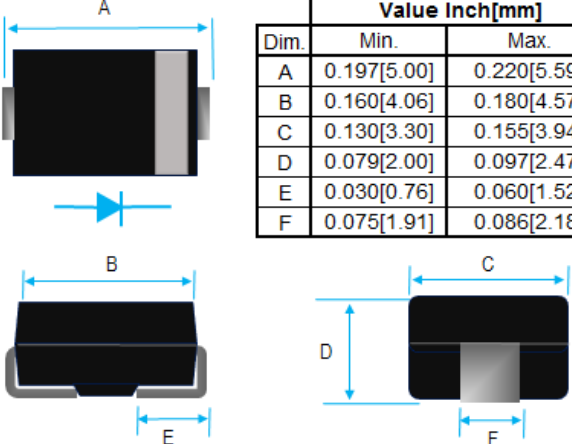

2A FAST RECOVERY SURFACE MOUNT RECTIFIER

	Value Inch[mm]	
	Dim.	Min.
A	0.197[5.00]	0.220[5.59]
B	0.160[4.06]	0.180[4.57]
C	0.130[3.30]	0.155[3.94]
D	0.079[2.00]	0.097[2.47]
E	0.030[0.76]	0.060[1.52]
F	0.075[1.91]	0.086[2.18]

PRODUCT FEATURES

1. FLAMMABILITY CLASSIFICATION: 94V-0
2. GLASS PASSIVATED CHIP JUNCTION
3. BUILT-IN STRAIN RELIEF
4. LOW PROFILE
5. FAST SWITCHING
6. CASE: MOLDED PLASTIC BODY, DO-214AA (SMB)
7. DIMENSIONS IN INCHES AND (MILLIMETERS)
8. POLARITY: INDICATED BY CATHODE BAND
9. WEIGHT : 0.093 GRAMS
10. RoHS

MAXIMUM RATINGS AND ELECTRICAL CHARACTERISTICS RATINGS AT 25°C AMBIENT TEMPERATURE UNLESS OTHERWISE SPECIFIED. STORAGE AND OPERATING TEMPERATURE RANGE -55°C TO +150°C. SINGLE PHASE, HALF WAVE, 60 HZ, RESISTIVE OR INDUCTIVE LOAD. FOR CAPACITIVE LOAD, DERATE CURRENT BY 20%.

RATINGS	SYMBOL	VALUE	UNITS
MAXIMUM AVERAGE FORWARD RECTIFIED CURRENT @ TL=90°C	I_o	2	A
PEAK FWD SURGE CURRENT, 8.3ms HALF SINE-WAVE SUPERIMPOSED ON RATED LOAD	I_{FSM}	70	A
TYPICAL JUNCTION CAPACITANCE(NOTE 1)	C_J	40	pF
TYPICAL THERMAL RESISTANCE (NOTE 2)	$R_{\theta ja}$	18	°C/W
MAXIMUM FORWARD VOLTAGE	V_F	1.3	V
MAXIMUM REVERSE CURRENT @ 25°C	I_R	5	uA

1. MEASURED @ 1.0 MHZ AND APPLIED REVERSE VOLTAGE OF 4.0 V
2. THERMAL RESISTANCE FROM JUNCTION TO LEAD P.C.B. MOUNTED ON 0.3x0.3"(8.0x8.0mm) COPPER PAD AREAS
3. REVERSE RECOVERY TEST CONDITIONS: $I_F=0.5A$, $I_R=1.0A$, $IRR=0$.
4. MAXIMUM FORWARD VOLTAGE AT I_o DC

PART NUMBER	MAX RECURRENT PK REV VOLTAGE V_{RRM} (V)	MAX RMS VOLTAGE V_{RMS} (V)	MAX DC BLOCKING VOLTAGE V_{DC} (V)	MARKING	MAX REV RECOVERY TIME T_{RR} (nS)
RS2A	50	35	50	RS2A	150
RS2B	100	70	100	RS2B	150
RS2D	200	140	200	RS2D	150
RS2G	400	280	400	RS2G	150
RS2J	600	420	600	RS2J	250
RS2K	800	560	800	RS2K	500
RS2M	1000	700	1000	RS2M	500

RATING AND CHARACTERISTIC CURVES

FIG. 1-TEST CIRCUIT DIAGRAM AND REVERSE RECOVERY TIME CHARACTERISTIC

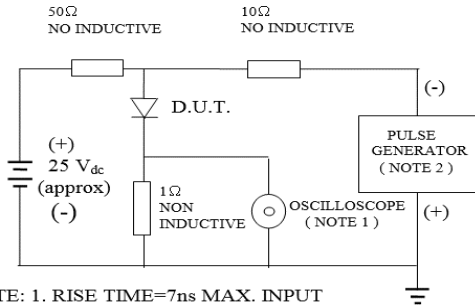

NOTE: 1. RISE TIME=7ns MAX. INPUT IMPEDANCE=1 MOhms 22PF
 2. RISE TIME =10ns MAX. SOURCE IMPEDANCE=50 OHMS

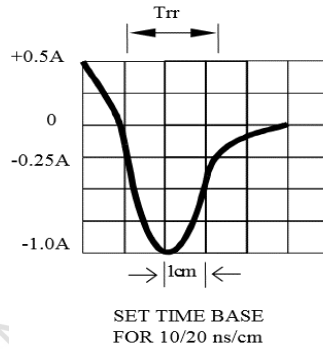

Fig. 2-MAXIMUM FORWARD CURRENT DERATING CURVE

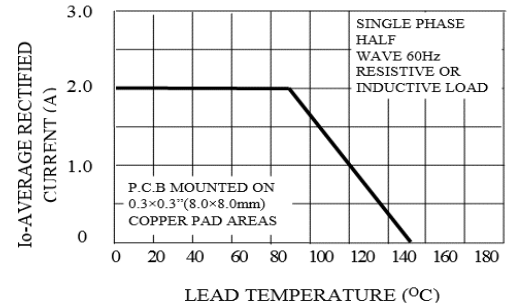

FIG. 3-TYPICAL REVERSE CHARACTERISTICS

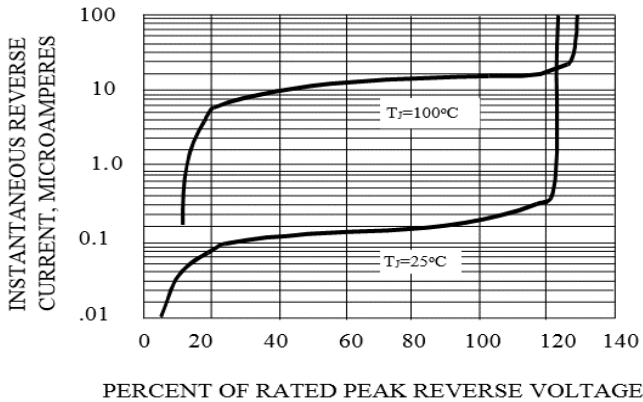

Fig. 4-MAXIMUM FORWARD SURGE CURRENT

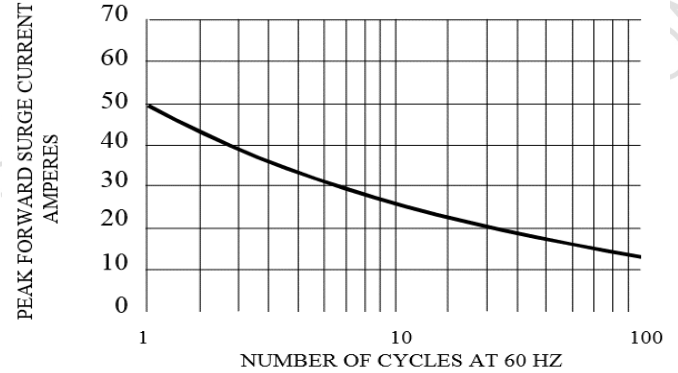

FIG. 5-TYPICAL JUNCTION CAPACITANCE

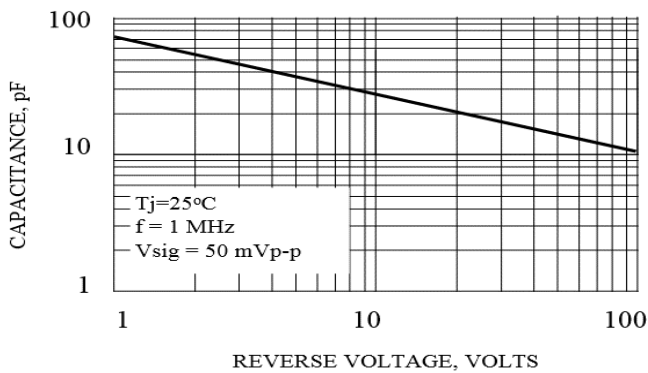

FIG. 6-TYPICAL INSTANTANEOUS FORWARD CHARACTERISTICS

