

# GB704

## SERIES INSTALLATION TOOL

### GB704

Stroke - .540" (13.72 mm)  
 Hand held weight - 4.30 lbs. (1.95 kg)  
 Entire tool weight - 4.30 lbs. (1.95 kg)  
 Pull load - 3,300 (14.68 kN)

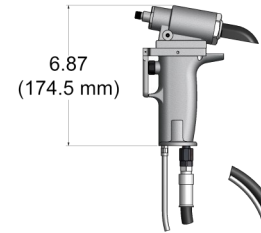
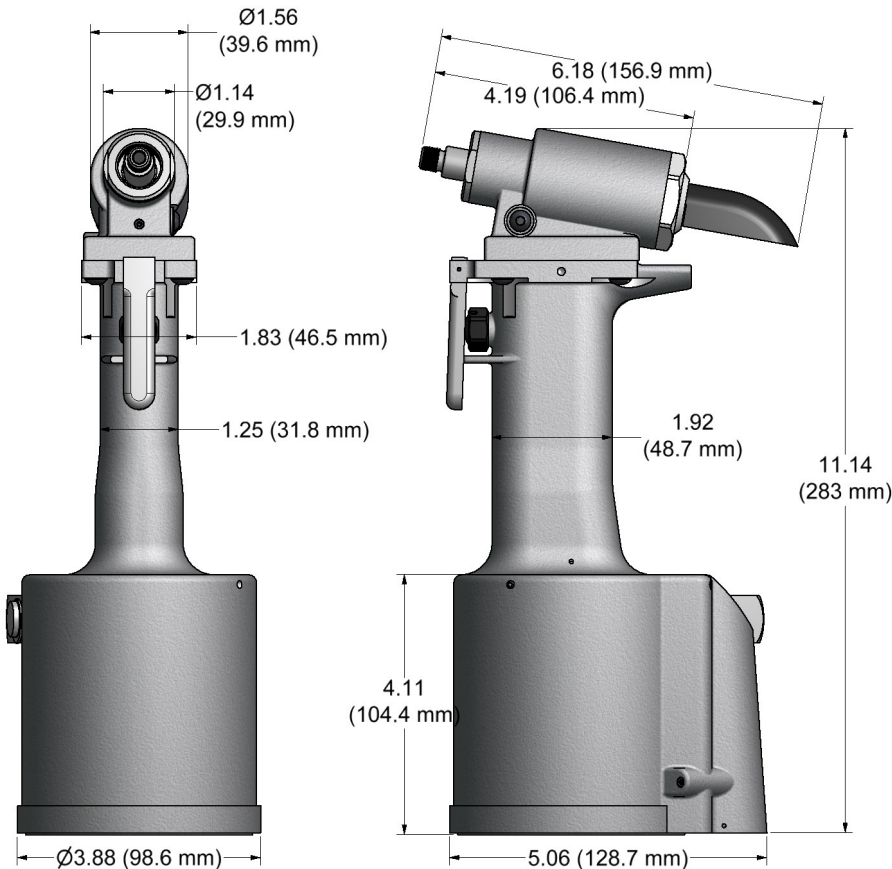

### GB704SH

Stroke - .600" (15.24 mm)  
 Hand held weight - 2.00 lbs. (.91 kg)  
 Entire tool weight - 7.25 lbs. (3.29 kg)  
 Pull load - 3,300 (14.68 kN)



### GB704SR

Stroke - .540" (13.72 mm)  
 Hand held weight - 1.50 lbs. (.68 kg)  
 Entire tool weight - 6.75 lbs. (3.06 kg)  
 Pull load - 3,300 (10.68 kN)

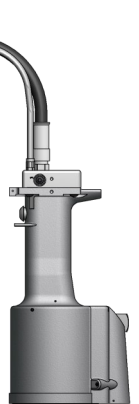

## DESCRIPTION

The GB704 series are pneumatic-hydraulic tools designed specifically for the efficient installation of a wide range of blind rivets. They can be operated in any position with one hand. They have a rated pull load of 3,300 lbs (14.68 kN) with 90 psi (6.2 bar) air pressure at the air inlet.

The GB704SH and GB704SR riveters offer a unique "split" system providing the operator with an ergonomic tool with reduced hand held weight, as shown above.

The GB704 series riveters operate on 90 to 100 psi (6.2-6.9 bar) of air pressure, providing the maximum efficiency. At 90 psi (6.2 bar) of air pressure, the GB704 series does not exceed 81.5 dB (A) and consumes 3 cfm at 20 cycles a minute.

The air inlet is provided with 1/4-18 female pipe thread to accept the users air hose fitting.

**NOSE ASSEMBLIES ARE NOT FURNISHED WITH TOOL AND MUST BE ORDERED SEPARATELY.**

**GB704 NOSE ASSEMBLY SELECTION CHART**  
**(SOLD SEPARATELY)**

**STRAIGHT**

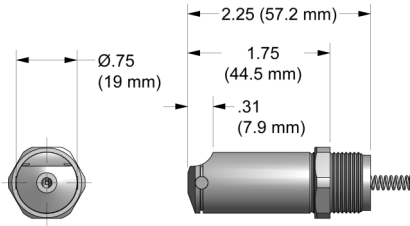

**RIGHT ANGLE**

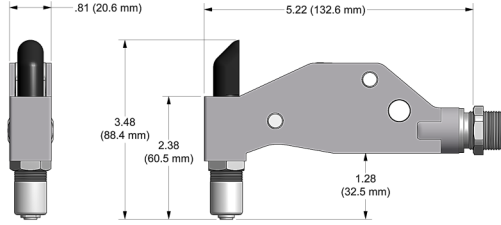

**OFFSET**

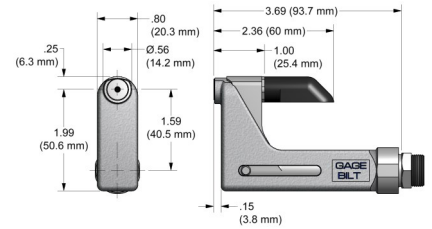

FASTENER	DIAMETER	STRAIGHT	RIGHT ANGLE (3)	OFFSET
CHERRYMAX®, CHERRYMAX® 'AB', MBC® LOCK CREATOR BACR15FR/FP, BACR15GF/GK,	1/8 5/32 3/16	456MAX-701-17 (2) 456MAX-704-35 (2) 456MAX-749-35 (4,2)	456MAX-704-54RA (2)	456MAX-704-43OS (2)
NUT PLATE RIVETS MS20600 SERIES CCR244/264/274 MS/9SP/PT BACR15CC/CF/DA/DR	3/32 1/8 5/32 3/16	3C-704A-16 4C-704A-16 5C-704A-16 6C-704A-16	3C-704-54RA 4C-704-54RA 5C-704-54RA 6C-704-54RA	3C-704-40OS 4C-704-40OS 5C-704-40OS 6C-704-40OS
'A' CODE NAS1398A NAS1399A	3/32 1/8 5/32 3/16	3A-704A-16 4A-704A-16 5A-704A-16 6A-704A-16	3A-704-54RA 4A-704-54RA 5A-704-54RA 6A-704-54RA	3A-704-40OS 4A-704-40OS 5A-704-40OS 6A-704-40OS
GROUND STUD M83454 BACS53B1EA1/2	8/32	GS8-704-16	GS8-704-54RA	GS8-704-40OS

CHERRYMAX® and MBC® are registered trademarks of Cherry Aerospace Fasteners.

**GAGE BILT CERTIFIES THE GB704 WILL INSTALL THE ABOVE FASTENERS**

- |   |
|---|
| 1) 715 SERIES NOSE ASSEMBLIES REQUIRE 704001 ADAPTER.         |
| 2) INSTALLS 1/8", 5/32", AND 3/16" DIAMETERS                  |
| 3) RIGHT ANGLE NOSE ASSEMBLIES MAY REQUIRE MORE THAN ONE PULL |
| 4) FRONT END EJECTING NOSE ASSEMBLY.                          |

NOTE: THE LAST 2 DIGITS OF THE NOSE ASSEMBLY REPRESENTS THE LENGTH THE NOSE EXTENDS FROM THE TOOL I.E. -20 = 2.0 INCHES

6/16

**ACCESSORIES AND FEATURED RIVETER KITS**  
**(SOLD SEPARATELY)**

**GRIP GAGE FOR CHERRYMAX® AND CHERRYLOCK® RIVETS**  
# 269G3 (Similar to #269C3)

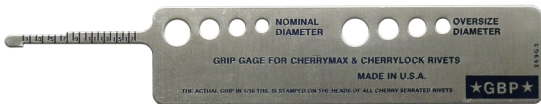

**GRIP GAGE FOR NAS LOCKBOLTS AND BLIND FASTENERS**  
#GB105093 (Equivalent to #105093)



**CATCHER BAG**  
#704214 (Equivalent to #670A20)



**AIR BLEEDER ASSY**  
#704153 (Equivalent to #700A77)



**RIVETER KIT**  
#GB704RK



**RIVETER KIT**  
#GB704RK-1

