

NOSE ASSEMBLY DATA SHEET

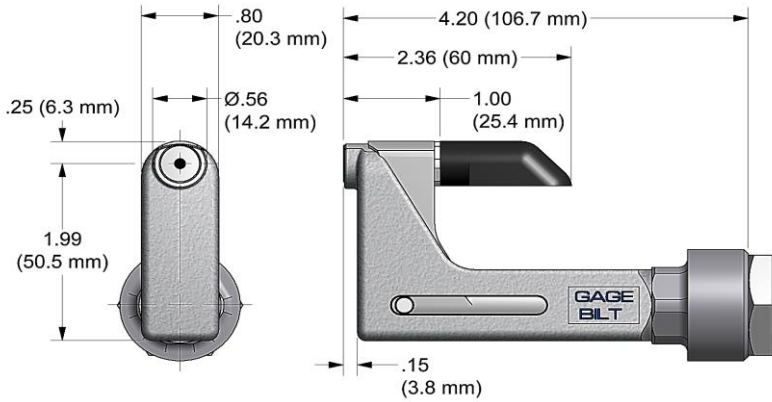

CAUTION:
Do not operate if pintail deflector is removed. Pintail may eject forcibly. SEVERE PERSONAL INJURY MAY RESULT.

Attachment :

Screw jam nut (70336) on nose fitting of tool at least 3/4". Screw nose assembly onto nose fitting of tool until it stops, then back off until nose is in desired position. (Warning: Do not back off nose assembly more than one complete turn). Lock jam nut (70336) against adapter (70331).

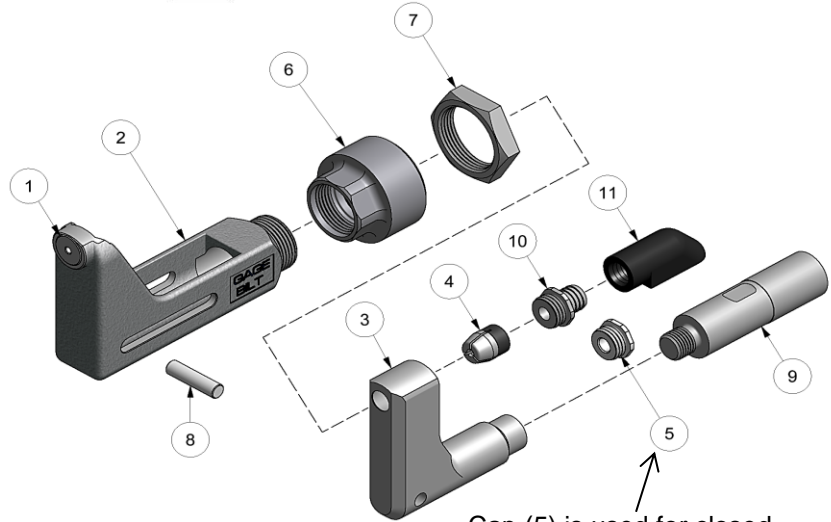

Cap (5) is used for closed access applications only or when clearance is an issue.

WARNING:
KEEP FINGERS AND HANDS AWAY FROM NOSE ASSEMBLY DURING OPERATION TO PREVENT SEVERE



REV 4/15

*USE ADAPTER 745751 & DO NOT USE # (7) JAM NUT 70336.

GAGE BILT Inc.

GAGE BILT

44766 Centre Court (586) 226-1500
Clinton Twp. MI 48038 (586) 226-1505 Fax
e-mail:solutions@gagebilt.com / www.gagebilt.com

Type:		Fasteners:	Recommended Tool: GB751
Non Self-Releasing 1/8" Ø		MS20600, CHERRY® 9000 HUCK® PT, SP & MS RV200 & RV500	Alternate Tools: GB752, GB713, GB2480 & *GB745
Ref. No.	Qty.	Description	4C-751-430S
1	1	Anvil Insert	10487
2	1	Anvil & Holder Assy (Inc. #1)	13370
3	1	Collet	20911
4	1	Super-Grip Jaw Assy	30425-S2
5	1	Cap	60428
6	1	Anvil Adapter	70331
7	1	Jam Nut	70336
8	1	Pin	70468
9	1	Collet Adapter	70332
10	1	Barbed Retainer	60440
11	1	Deflector	61107