



# Hi-Rel AC/DC PFC MODULE HGMM-350 : 350W POWER

Hi-Rel  
Grade ■■

## 115/230 VAC Universal Power Factor Corrected Frequency 45-65Hz Non Isolated Output Metallic Case



4

- AC/DC Non Isolated Power Factor Corrected Module
  - 115/230 VAC single phase
  - Permanent input range : 85 - 265 VAC
  - Frequency range : 45-65Hz
  - MIL-STD-704, MIL-STD-1399
- Low input current harmonic distortion < 10%
- Output Power : 350W
- Active inrush current limitation
- Inhibition function
- Leaded process

### 1- General

The GAIA Converter HGMM-350 universal input module HGMS-350-Y-T designates a non isolated AC/DC power factor corrected module designed to be compatible with the single phase input bus 115/230VAC 50/60Hz frequency.

The modules accept an AC input voltage ranging from 85Vac to 265Vac and include active power factor corrector that enables a very low level of current harmonic distortion.

The HGMM-350 is compliant with numerous military standards requirements among them with :

- the US military standard MIL-STD-1399A/B :
  - permanent input range : 107-123Vac
  - transient : 92Vac/2s - 138Vac/2s
- the US military standard MIL-STD-704E/F :
  - permanent input range : 108-118Vac
  - transient : 80Vac/10ms - 180Vac/100ms

The HGMS-350-Y-T module includes a soft start an active inrush current limitation, a permanent short circuit protection and an inhibit function. The soft-start/active current limitation eliminates inrush current during start-up, the short circuit protection protects the module against short-circuits of any duration by a shut down and restores to normal when the overload is removed.

The HGMS-350-Y-T output voltage is set to 420Vdc compatible with GAIA Converter high input voltage series of DC/DC converter and operates with a hold-up capacitance to allows transparency time and ripple reduction.

The design has been carried out with surface mount components and is manufactured in a fully automated process to guarantee high quality. Every module is tested with a Gaia Converter automated test equipment. The modules are potted with a bi-component thermal conductive compound and packaged in a metallic case to ensure the module's integrity under high environmental conditions.

### 2-Product Selection

Single output model : HGMS - 350 -  -  /  -

Input Voltage Range
Y : 85-265 VAC / 50/60 Hz

Output
T : 420 VDC

**Options :**  
 /T : option for -55°C start up operating temperature  
 /S : option for screening and serialization

**Suffix :**  
 -L : leaded process

### 3- Electrical Specifications

Data are valid at +25°C, unless otherwise specified.

Parameter	Conditions	Limit or typical	Units	HGMS-350-Y-T
<b>Input</b>				
Nominal input voltage	Full temperature range between phase and neutral	Nominal	VAC	115/230
Permanent input voltage range (Ui)	Full temperature range between phase and neutral	Min. - Max.	VAC	85-265
Transient input voltage	Full temperature range between phase and neutral	Minimum	VAC/ms	NA
		Maximum.	VAC/ms	NA
Frequency range permanent (Fi)	Full temperature range Ui min. to max.	Nominal	Hz	50/60
		Min. Max.	Hz	45-65
Frequency range transient	Full temperature range Ui min. to max.	Maximum	Hz/s	/
Power Factor (PF)	Ui nominal Fi nominal	At full load	/	0,99
		At half load		0,98
		At quarter load		0,90
Total Harmonic Distorsion (THD)	Ui min. to max.	from 50% to full load from 45Hz to 65Hz	%	< 10
Start up time	Ui min. to max., Fi nominal with minimum capacitance Co with maximum capacitance Co	Maximum	ms	250
		Maximum	ms	600
Start-up current	Ui nominal, Fi nominal	Maximum peak	A	10
Current in inhibit mode	Ui nominal, Fi nominal Inhibit	Maximum	mArms	50
<b>Output</b>				
Output voltage	Full temperature range Ui min. to max., full load	Nominal	VDC	420
Output voltage transient	Input voltage transient Load fast change	Maximum	VDC	480
Set point accuracy	Ambient temperature : +25°C Ui nominal, 75% load	Maximum	%	+/-3
Output power	Full temperature range Ui min. to max.	Maximum	W	350
Ripple output voltage	Ui nominal, Fi nominal Full load BW=20MHz	Maximum	Vpp	see curve page 12
Output regulation (Line + load + thermal)	Full temperature range Ui min. to max., Fi nominal No load to full load	Maximum	%	+/-1
Efficiency	Ui nominal, Fi nominal Full load	Typical	%	93
Admissible capacitive load (Co)	Full temperature range Ui min. to max.	Minimum	μF	270
		Maximum	μF	1 000

## 3- Electrical Characteristics (continued)

### 3-1 Power Factor (PF) Characteristics

The Power Factor (PF) is the ratio of the «real» power to the apparent power.

The apparent power is the product of the rms volts measured with one meter and the rms amps measured with another meter (value in VA).

The «real» power is the time average of the instant product of voltage and current (value in Watts).

The «real» power cannot be measured directly with 2 meters as it has to integrate the phase shift between voltage and current. This phase shift between voltage and current reduces the effective power delivered.

The Power Factor (PF) is a measure of the effectiveness with which an AC load can extract the usable power from an AC source.

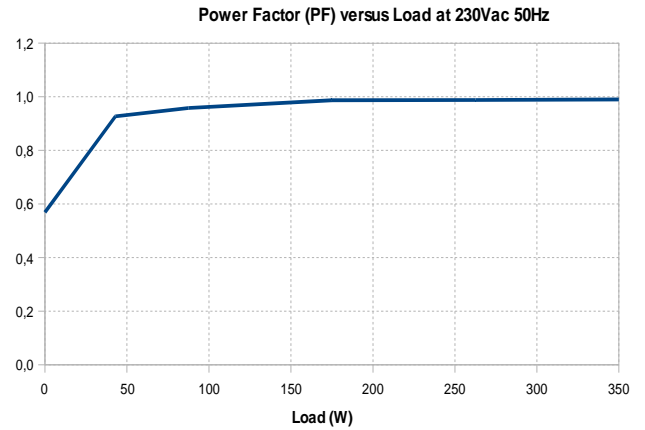
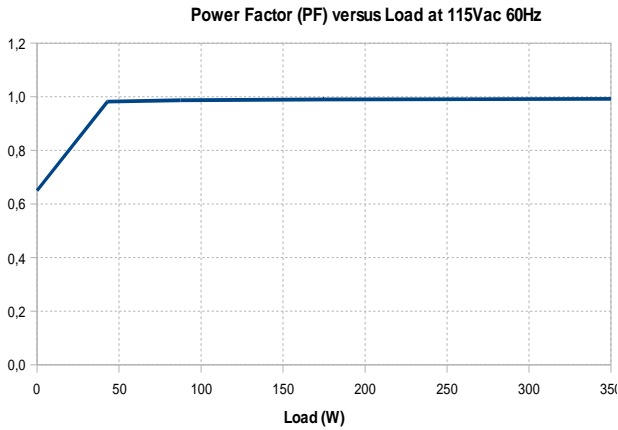

### 3-2 Total Harmonic Distorsion Factor (THD) Characteristics

The Total Harmonic Distorsion (THD) is the ratio between the total energy contained in all row harmonic (except fundamental harmonic) by the fundamental harmonic wave.

The following curves represent the Total Harmonic Distorsion Factor (THD) for the HGMS-350-Y-T at 115Vac/60Hz and at 230Vac/50Hz.

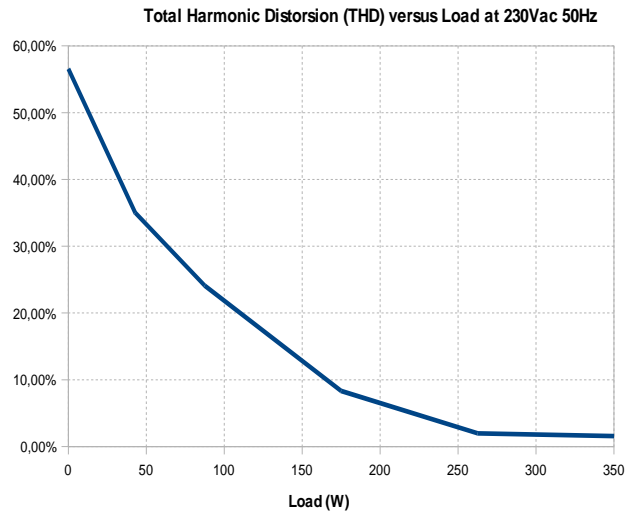
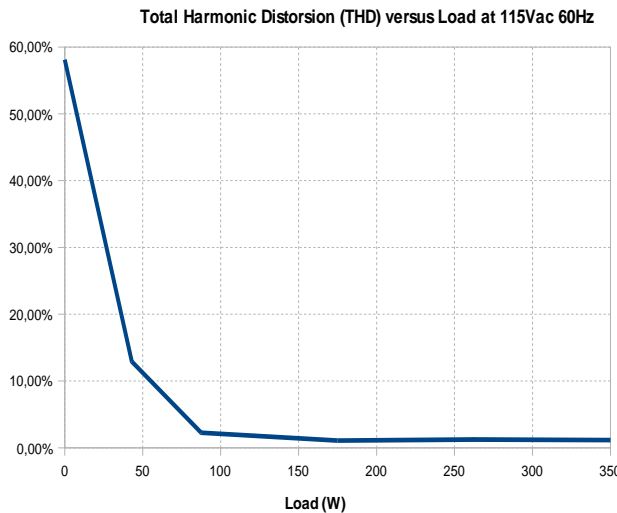

## 3- Electrical Characteristics (continued)

### 3-4 Anharmonic Input Current

The anharmonic input currents of the HGMS-350-Y-T at 115Vac/60Hz and 230Vac/50Hz are given thereafter at 350W power.

Anharmonic Input Current of HGMS-350-Y-T at 115Vac/50Hz

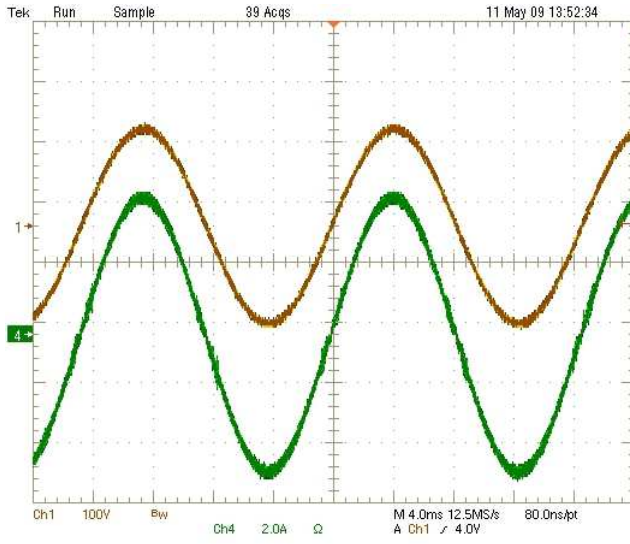

Anharmonic Input Current of HGMS-350-Y-T at 230Vac/60Hz

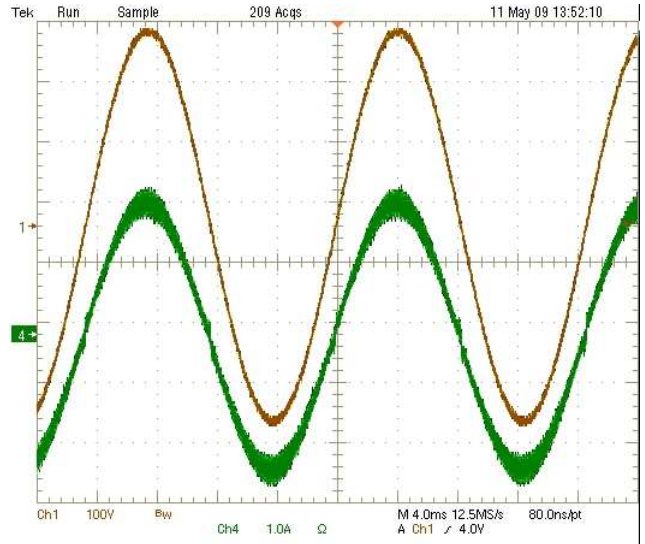

### 3-5 Efficiency

The efficiency curves of the HGMS-350-Y-T at 115Vac/60Hz and 230Vac/50Hz are given hereafter :

Efficiency versus Load at 115Vac 60Hz

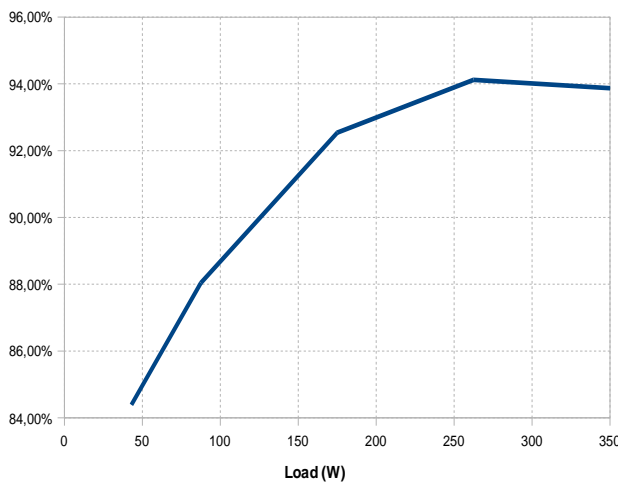

Efficiency versus Load at 230Vac 50Hz

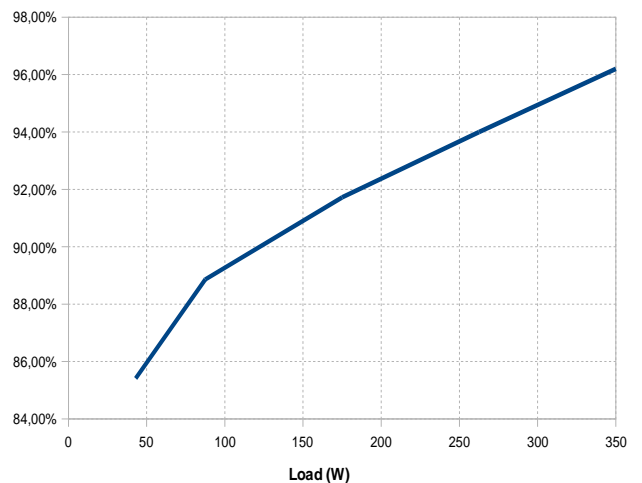

## 4- Switching Frequency

Parameter	Conditions	Limit or typical	Specifications
Switching frequency	Full temperature range Ui min. to max. No load to full load	Nominal, fixed	250 KHz

## 5- Isolation

Parameter	Conditions	Limit or typical	Specifications
Electric strength test voltage	Input to output	Minimum	No isolation
	Pin to case	Minimum	2 200 VDC / 1 min
Isolation resistance	Pin to case Under 500 VDC	Minimum	100 MOhm

## 6- Protection Functions

Characteristics	Protection Device	Recovery	Limit or typical	Specifications
Output short circuit protection (SCP)	Hiccup circuitry with auto-recovery	Automatic recovery	Permanent	See section 11
Output over power protection (OPP)		Automatic recovery	Typical	500W
Over temperature protection (OTP)	Thermal device with hysteresis cycle	Automatic recovery	Maximum	115°C

## 7- Reliability Data

Characteristics	Conditions	Temperature	Specifications
Mean Time Between Failure (MTBF) According to MIL-HDBK-217F	Ground fixed (Gf)	Case at 40°C Case at 85°C	610 000 Hrs 170 000 Hrs
	Airborne, Inhabited, Cargo (AIC)	Case at 40°C Case at 85°C	320 000 Hrs 110 000 Hrs
Mean Time Between Failure (MTBF) According to IEC-62380-TR	Civilian avionics, calculators	Ambient at 55°C 100% time on	470 000 Hrs

## 8- Electromagnetic Interference

Electromagnetic interference requirements according to DO-160D or MIL-STD-461D/E can be easily achieved as indicated in the following table with the use of an additional external filter as described hereafter.

Standards	DO-160D	MIL-STD-461E	Compliance
<b>Conducted emission (CE) :</b> Low frequency High frequency	Section 21	CE 101 CE 102	compliant module stand alone compliant with additional filter
<b>Conducted susceptibility (CS) :</b> Low frequency High frequency	Section 20	CS 101 CS114	compliant with additional filter compliant with additional filter
<b>Radiated emission (RE) :</b> Magnetic field Electrical field	Section 21	RE 101 RE 102	compliant module stand alone compliant module stand alone
<b>Radiated susceptibility (RS) :</b> Magnetic field Electrical field	Section 20	RS 101 RS 013	compliant module stand alone compliant module stand alone

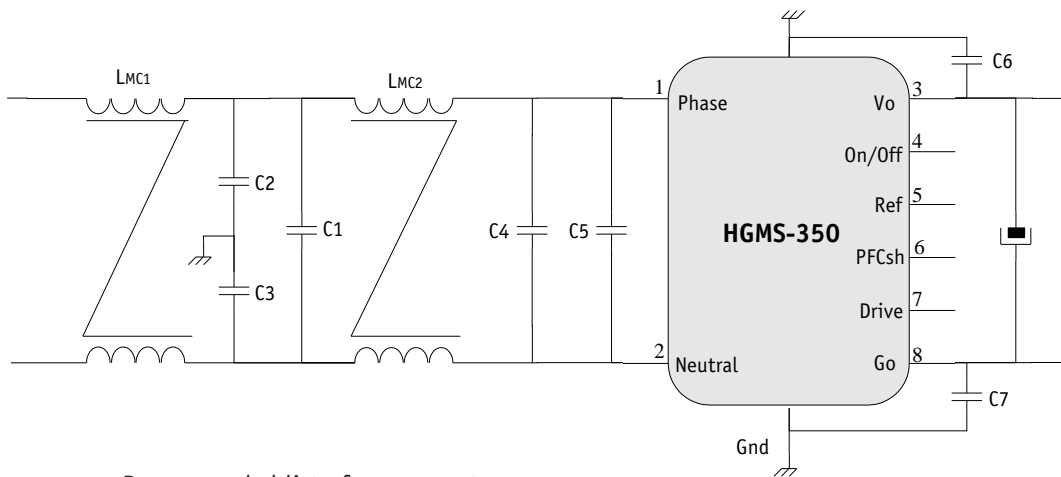

**Recommended list of components :**

- LMC1, LMC2 ..... : Common mode choke 2.5mH (Ferroxcube core TN23/14/7-3E25 with 2x26 turns (wire diameter 0.56mm))
- C2, C3, C6, C7 ..... : Ceramic chip capacitors 2.2 nF/2Kv 1210 (exemple AVX : 1210GC222MAT)
- C1, C4 ..... : Film chip capacitor 4 x 270 nF/250VAC (exemple AVX : CB182K0274)
- C5 ..... : Ceramic chip capacitor 100 nF/500V (exemple Syfer : 1812J50000104MX)

**Fig : DO-160D Conducted Noise Emission**

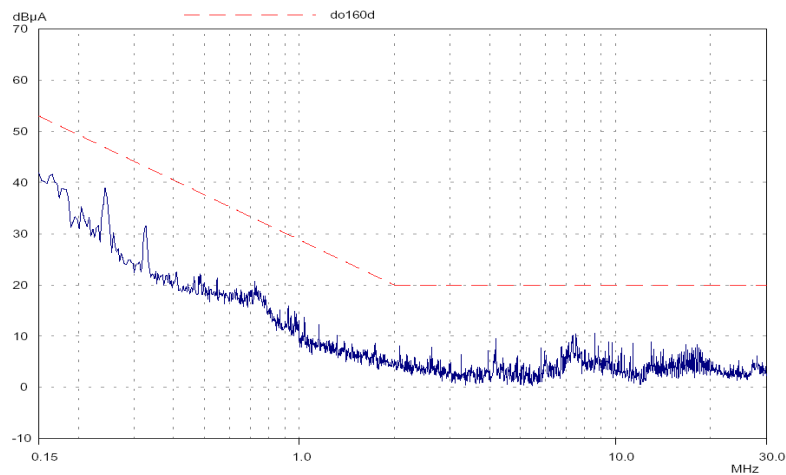

## 9- Thermal Characteristics

Characteristics	Conditions	Limit or typical	Performances
Operating ambient temperature range	Ambient temperature	Minimum Maximum	- 40°C see below
Operating case temperature range	Case temperature	Minimum Maximum	- 40°C + 105°C
Storage temperature range	Non functioning	Minimum Maximum	- 55°C + 125°C
Thermal resistance	Rth case to ambient in free air natural convection	Typical	8°C/W

The following discussion will help designer to determine the thermal characteristics and the operating temperature.

The HGMM-350 universal input series maximum **baseplate** temperature at full load must not exceed 105°C. Heat can be removed from the baseplate via three basic mechanisms

- Radiation transfert : radiation is counting for less than 5% of total heat transfert in majority of case, for this reason the presence of radiant cooling is used as a safety margin and is not considered.
- Conduction transfert : in most of the applications, heat will be conducted from the baseplate into an attached heatsink or heat conducting member; heat is conducted thru the interface.
- Convection transfert : convecting heat transfer into air refers to still air or forced air cooling.

In majority of the applications, heat will be removed from the baseplate either with :

- heatsink,
- forced air cooling,
- both heatsink and forced air cooling.

The table hereafter gives some example of thermal resistance for different heat transfert configurations.

Heat transfert	Thermal resistance heatsink to air Rth(h-a)	Thermal resistance baseplate to heatsink Rth(b-h)	Global resistance
Free air cooling only	No Heatsink baseplate only : 8°C/W	No need of thermal pad	8°C/W
	Heatsink Thermalloy 6516B : 4,4°C/W	Bergquist Silpad* : 0,14°C/W	4,54°C/W
	Heatsink Fischer Elektronik SK DC 5159SA : 3,8°C/W	Bergquist Silpad* : 0,14°C/W	3,94°C/W
Forced air cooling 200 LFM	No Heatsink baseplate only : 4,5°C/W	No need of thermal pad	4,5°C/W
	Heatsink Thermalloy 6516B : 3°C/W	Bergquist Silpad* : 0,14°C/W	3,14°C/W
	Heatsink Fischer Elektronik SK DC 5159SA : 2,5°C/W	Bergquist Silpad* : 0,14°C/W	2,64°C/W
Forced air cooling 400 LFM	No Heatsink baseplate only : 3,2°C/W	No need of thermal pad	3,2°C/W
	Heatsink Thermalloy 6516B : 1,75°C/W	Bergquist Silpad* : 0,14°C/W	1,89°C/W
	Heatsink Fischer Elektronik SK DC 5159SA : 1,7°C/W	Bergquist Silpad* : 0,14°C/W	1,84°C/W
Forced air cooling 1000 LFM	No Heatsink baseplate only : 1,7°C/W	No need of thermal pad	1,7°C/W
	Heatsink Fischer Elektronik SK DC 5159SA : 0,9°C/W	Bergquist Silpad* : 0,14°C/W	1,04°C/W

Fischer Elektronik and Thermalloy are heatsink manufacturers. «Silpad»<sup>®</sup> is a registered trademark of Bergquist.  
Note\* : Silpad performance are for Silpad 400 with pressure conditions of 50 Psi. Surface of HGMM-350 series is 5,5 inch<sup>2</sup>.

To calculate a maximum admissible ambient temperature the following method can be used.

Knowing the maximum baseplate temperature Tbase = 105°C of the module, the power used Pout and the efficiency η :

- determine the power dissipated by the module P<sub>diss</sub> that should be evacuated :

$$P_{diss} = P_{out} / (\eta - 1) \quad (A)$$

- determine the maximum ambient temperature :

$$T_a = 105^\circ\text{C} - R_{th}(b-a) \times P_{diss} \quad (B)$$

where **Rth(b-a)** is the thermal resistance from the baseplate to ambient.

This thermal Rth(b-a) resistance is the summ of :

- **the thermal resistance of baseplate to heatsink (Rth(b-h))**. The interface between baseplate and heatsink can be nothing or a conducting member, a thermal compound, a thermal pad.... The value of Rth(b-h) can range from 0.4°C/W for no interface down to 0.1°C/W for a thermal conductive member interface.
- **the thermal resistance of heatsink to ambient air (Rth(h-a))**, which is depending of air flow and given by heatsink supplier.

## 9- Thermal Characteristics (continued) : Heatsink Mounting

To mount properly the module to heatsink, some important recommendations need to be taken into account in order to avoid overstressing conditions that might lead to premature failures.

The module case is built with a copper IMS (isolated metallic substrate ) crimped on an aluminum frame that provides case rigidity. The IMS surface is the module base plate that need to be reported to heat sink to achieve proper cooling. If for some reasons like poor module report, the IMS base plate is subject to mechanical overstress, module's electrical characteristics may be definitely affected.

A typical example of damageable report is the use of thick thermal interface with usual screwing torque applied on mounting screws. This combination causes a high pressure on baseplate center due to thermal interface material compression. The final consequence is a slight IMS bending that can conduct for the module to fail high voltage isolation leading to heavy electrical damage on internal circuit.

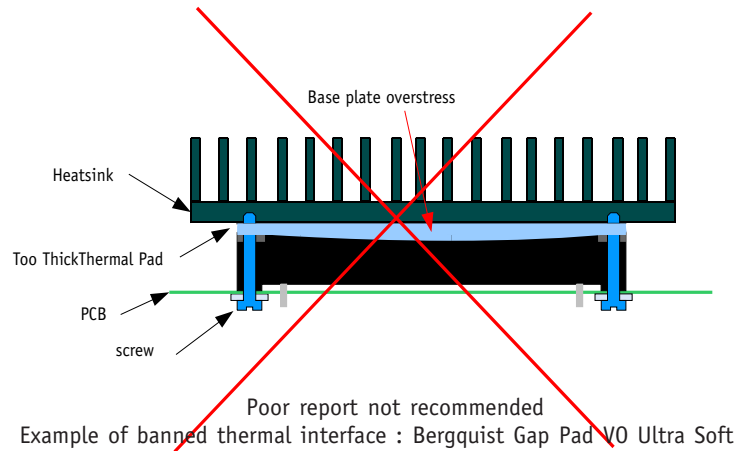

The good practice is to respect the 4 following recommendations:

- do not exceed recommended screwing torque of 0,7 N.m (6 lbs.in)
  - prefer thin thermal pad with thickness lower than 0,34 mm (0.015").
- GAIA Converter recommends to use thin thermal pads instead of thermal compound like grease.
- take care to reflow module leads only when all assembly operations are completed.
  - do not report module on surfaces with poor flatness characteristics. GAIA Converter recommends not to overflow 0,1mm/m for the surface flatness.

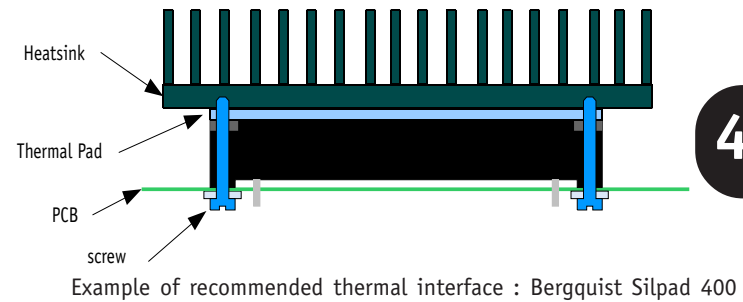

4

Gaia converter suggests to follow the procedure hereunder for the mechanical assembly procedure in order to avoid any stress on the pins of the converters. It is good practice to be sure to mount the converters first mechanically, then solder the units in place.

1. Choice of the thermal gap pad : its shape must be the same as the module. The dimensions of the gap pad can be a little larger than the module.
2. Screw the converter to the heatsink and/or to the board. The four screws have to be screwed in a "X" sequence.
  - Lightly finger-tighten all screws and run several «X» sequences before achieving final torque to get homogeneous tightening.
  - Torque screws from 0,35 N.m (3 lbs.in) to 0,7 N.m (6 lbs.in).
3. Screw the heatsink to the board.
4. Solder the pins of the converters on the board. This sequence avoids mechanical stresses on the converters that could lead to stress internal components or assemblies and cause their failures.

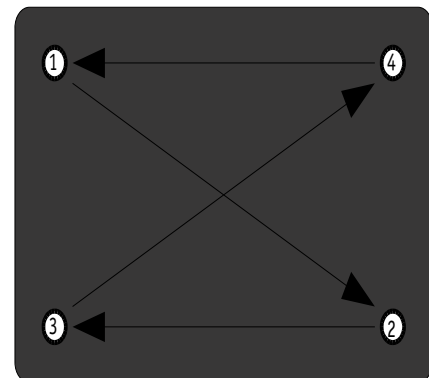



## 10- Environmental Qualifications

The modules have been subjected to the following environmental qualifications.

Characteristics	Conditions	Severity	Test procedure
<b>Climatic Qualifications</b>			
Life at high temperature	Duration Temperature / status of unit	Test D : 1 000 Hrs @ 105°C case, unit operating @ 125°C ambient, unit not operating	MIL-STD-202G Method 108A
Altitude	Altitude level C Duration Climb up Stabilization Status of unit	40 000 ft@-55°C 30 min. 1 000 ft/min to 70 000 ft@-55°C, 30 min. unit operating	MIL-STD-810E Method 500.3
Humidity cyclic	Number of cycle Cycle duration Relative humidity variation Temperature variation Status of unit	10 Cycle I : 24 Hrs 60 % to 88 % 31°C to 41°C unit not operating	MIL-STD-810E Method 507.3
Humidity steady	Damp heat Temperature Duration Status of unit	93 % relative humidity 40°C 56 days unit not operating	MIL-STD-202G Method 103B
Salt atmosphere	Temperature Concentration NaCl Duration Status of unit	35°C 5 % 48 Hrs unit not operating	MIL-STD-810E Method 509.3
Temperature cycling	Number of cycles Temperature change Transfert time Steady state time Status of unit	200 -40°C / +85°C 40 min. 20 min. unit operating	MIL-STD-202A Method 102A
Temperature shock	Number of shocks Temperature change Transfert time Steady state time Status of unit	100 -55°C / +105°C 10 sec. 20 min. unit not operating	MIL-STD-202G Method 107G
<b>Mechanical Qualifications</b>			
Vibration (Sinusoidal)	Number of cycles Frequency / amplitude Frequency / acceleration Duration Status of unit	10 cycles in each axis 10 to 60 Hz / 0,7 mm 60 to 2 000 Hz / 10 g 2h 30 min. per axis unit not operating	MIL-STD-810D Method 514.3
Shock (Half sinus)	Number of shocks Peak acceleration Duration Shock form Status of unit	3 shocks in each axis 100 g 6 ms 1/2 sinusoidal unit not operating	MIL-STD-810D Method 516.3
Bump (Half sinus)	Number of bumps Peak acceleration Duration Status of unit	2 000 Bumps in each axis 40 g 6 ms unit not operating	MIL-STD-810D Method 516.3

## 11- Description of Protections

### 11-1 Output Short Circuit Protection (SCP)

The short circuit protection device protects the module against short circuits of any duration. It operates in «hiccup» mode by testing approximately every «recovery time» (typically 1,1s) if an overload is applied with a detection time lower than 70ms and restores the module to normal operation when the short circuit is removed.

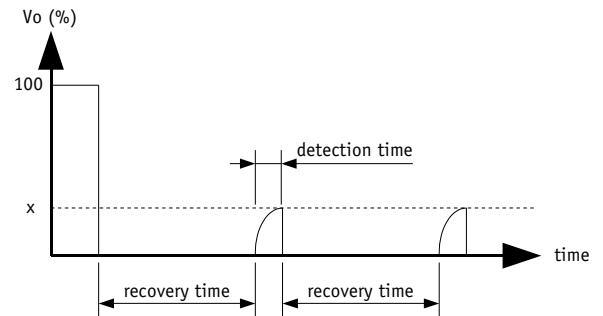

### 11-2 Output Over Power Protection (OPP)

The HGMM-350 incorporates a foldback power limit and protection circuit. When the output power reaches 1,5 times its full-rated power, the output voltage falls along the foldback line as described in the figure herein. When the output voltage decreases below 40% of  $V_{Onom}$  the module falls in a hiccup mode and activates the short circuit protection. The module restarts automatically to normal operation when overcurrent is removed.

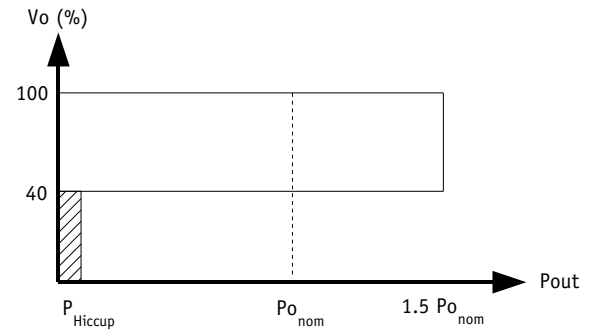

### 11-3 Over Temperature Protection (OTP)

A thermal protection device adjusted at 115°C (+/-5%) internal temperature with 10°C hysteresis cycle will inhibit the module as long as the overheat is present and restores to normal operation automatically when overheat is removed. The efficiency of the OTP function is warranty with the module mounted on a heatsink.

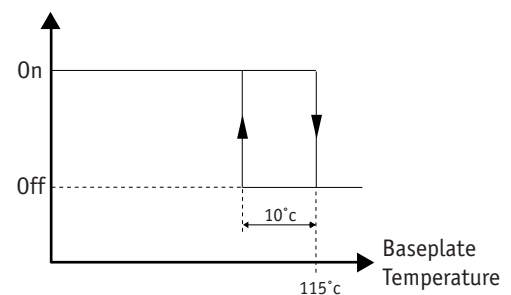

## 12- Description of Functions

### 12-1 On/Off Function

The control pin 4 (On/Off) can be used for applications requiring On/Off operation. This may be done with an open collector transistor, a switch, a relay or an optocoupler.

- The converter is disabled by pulling low the pin 4.
- No connection or high impedance on pin 4 enables the converter.

By releasing the On/Off function, the converter will restart within the start up time specifications given in table section 4.

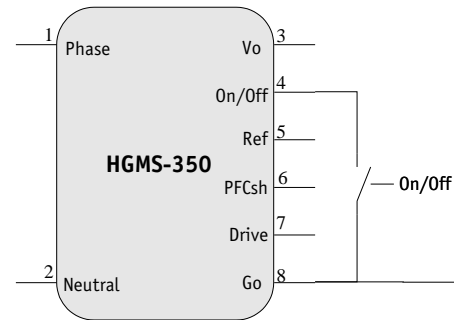

Parameter	Unit	Min.	Typ.	Max.	Notes, conditions
On/Off module enable voltage	Vdc	2,35	/	5,5	
On/Off module disable voltage	Vdc	0	/	2,35	
On/Off module enable delay	ms	/	/	/	See start-up time
On/Off module disable delay	µs	/	/	100	Vin, full load

### 12-2 «Drive» Function

The HGMM-350 with its 420Vdc output has to be used in conjunction with a hold-up capacitor and a companion isolated module MGDM-150-T series of GAIA Converter.

The drive function is a signal that controls the start-up and the stop of the the companion module.

At start-up of the HGMM-350, the drive function is in low impedance status preventing the companion module to start as long as the hold-up capacitor is not charged to reach 420Vdc.

When the capacitor reaches 90% of its charge, the drive signal is released allowing the companion module to start-up. If the HGMM-350 is powered-down in case of input bus failure for example, the hold-up capacitor will discharge to maintain the companion module in operation down to a voltage of 150Vdc then the drive signal will stop the companion module to operate with a low impedance signal.

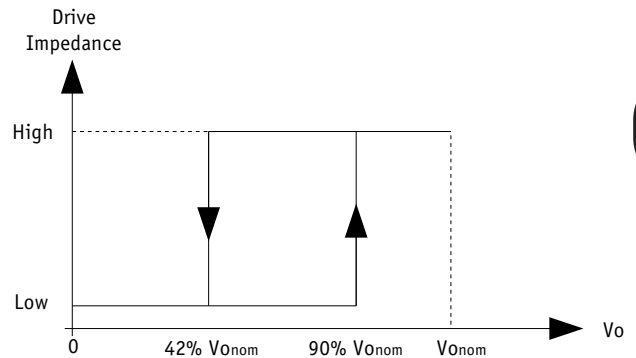

4

Parameter	Unit	Min.	Max.	Notes, conditions
Enable threshold	% of VOnom	89%	93%	/
Disable threshold	% of VOnom	39%	44%	/

### 12-3 «REF» Function

The signal «REF» is an auxiliary voltage of 7,5Vdc +/-2% referenced to Go. It can provide a maximum current of 1.5mA. It is recommended to add a 100nF decoupling capacitor when this signal is used. When the module is turned off or when there is an input power interruption, the signal Vref drops to 0Vdc.

### 12-4 «PFCsh» Function

The HGMM-350 features a trim function. Please consult factory for details.

## 13- Application Notes

### 13-1 Connections

The HGMM-350 has to be used in conjunction with an external hold-up capacitor across the outputs to limit the output voltage ripple.

This capacitor has to be carefully chosen to avoid damaging the HGMM-350.

A low ESR capacitor is recommended; as this ESR increases with temperature the following ratings should apply :

- max ESR @ 20°C : 1 Ohm
- max ESR @ -40°C : 5 Ohm

The capacitor voltage rating has to be chosen according to the maximum permanent & transient output voltage specified.

The charts hereby specify for a given capacitance value the resultant output ripple value.

Maximum capacitor value range is given in table section 3.

This capacitor is also used to achieve hold-up function for transparency time.

Output Ripple vs Output Capacitor for HGMS-350-Y-T

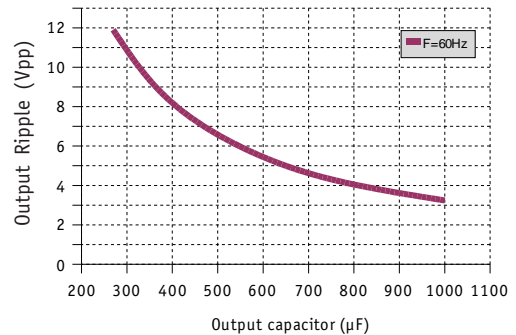

The HGMM-350-Y-T output voltage is a high and non isolated voltage of 420 Vdc.

To achieve usual low voltages such as 5, 15 .... or 28 Vdc, the HGMS-350 module has to be connected with a GAIA Converter compatible companion module. Companion modules can be found among all the high input series i.e with 120V-480V input range down to low voltage as shown in the figure below.

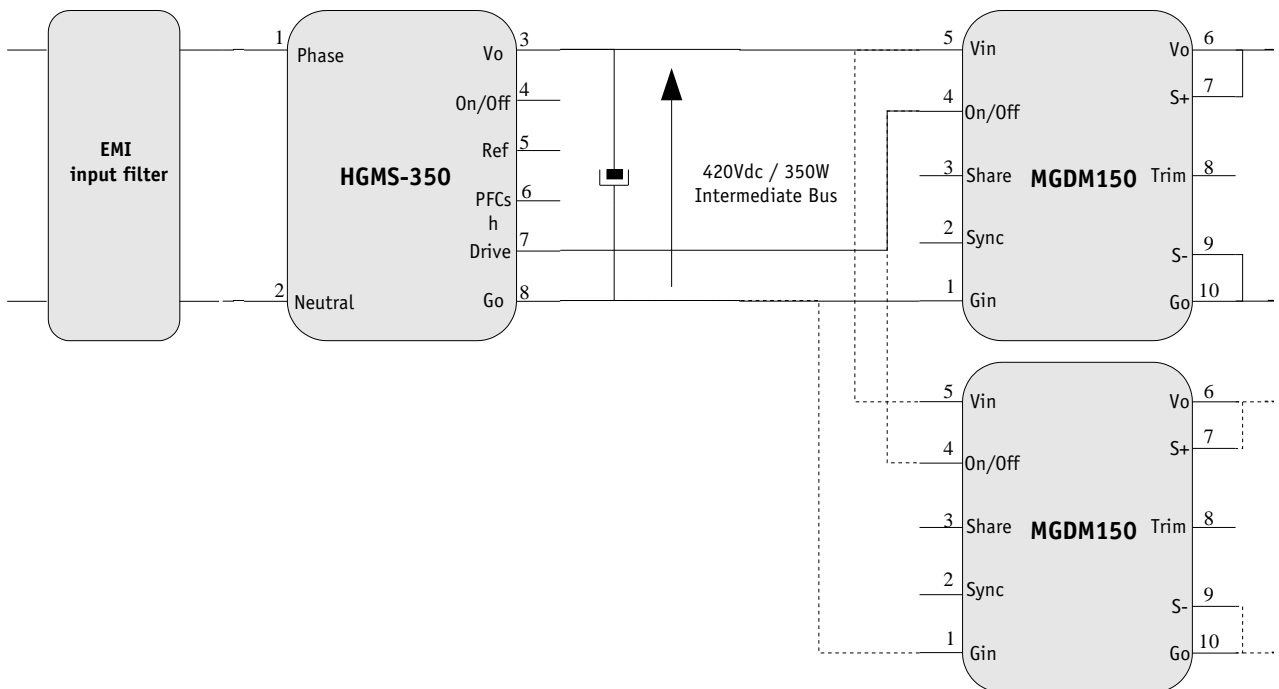

## 14- Dimensions

Dimension are given in mm (inches). Tolerance : +/- 0,2 mm (+/- 0.01 ") unless otherwise indicated.  
Weight : 110 grams (4.30 Ozs) max.

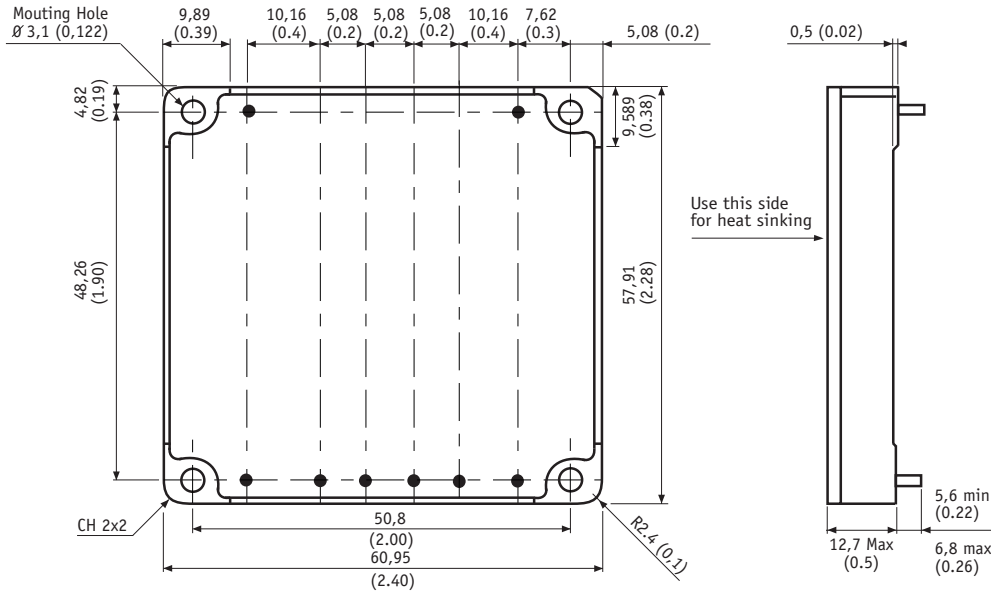

Pin dimensions : Ø 1 mm (0.04")

## 15- Materials

Frame : Aluminium alodined coating.  
Baseplate : Copper with tin finishing.  
Pins : Plated with pure matte tin over nickel underplate.

## 16- Product Marking

Side face : Company logo, location of manufacturing.  
: Module reference : HGMS-350-»X»-»Y».  
Date code : year and week of manufacturing, suffix, /option.

## 17- Connections

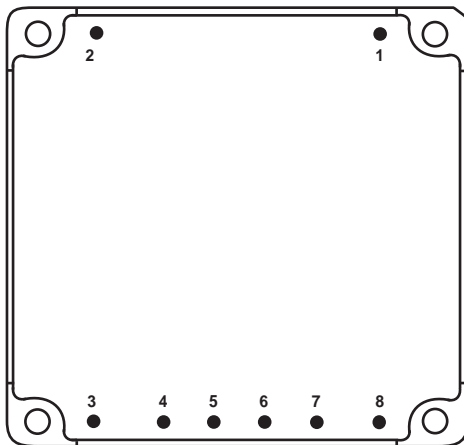

Bottom view

Pin	Single output
1	Phase
2	Neutral
3	Output (Vo)
4	On/Off
5	Ref
6	PFCSH
7	Drive
8	Common (Go)



For more detailed specifications and applications information, contact :

**International Headquarters**

GAIA Converter - France  
ZI de la Morandière  
33185 LE HAILLAN - FRANCE  
Tel. : + (33)-5-57-92-12-80  
Fax : + (33)-5-57-92-12-89

**North American Headquarters**

GAIA Converter Canada, Inc  
4038 Le Corbusier Blvd  
LAVAL, QUEBEC - CANADA H7L 5R2  
Tel. : (514)-333-3169  
Fax : (514)-333-4519

Represented by :