

Surface Mount Rectifiers

ES2AA--ES2JA

FEATURES

- Low cost
- Low leakage
- Low forward voltage drop
- High current capability
- Easily cleaned with Alcohol, Isopropanol and similar solvents
- The plastic material carries U/L recognition 94V-0



MECHANICAL DATA

- Case: DO-214AC(SMA) molded plastic
- Terminals: Solder able per MIL- STD-202,Method 208
- Polarity: Color band denotes cathode
- Weight: 0.002 ounces,0.064 grams

Maximum Ratings(@TA = 25°C unless otherwise specified)

Characteristic	Symbol	ES2AA	ES2BA	ES2CA	ES2DA	ES2GA	ES2HA	ES2JA	UNITS
Maximum recurrent peak reverse voltage	V_{RRM}	50	100	150	200	400	500	600	V
Maximum RMS voltage	V_{RMS}	35	70	105	140	280	350	420	V
Maximum DC blocking voltage	V_{DC}	50	100	150	200	400	500	600	V
Maximum average forward rectified current @TA=110°C	$I_{F(AV)}$	2.0							A
Peak forward surge current 8.3ms single half-sine-wave superimposed on rated load @Tj=125°C	I_{FSM}	50							A

Thermal Characteristics

Characteristic	Symbol	ES2AA	ES2BA	ES2CA	ES2DA	ES2GA	ES2HA	ES2JA	UNITS
Typical junction capacitance (Note2)	C_J	18							pF
Typical thermal resistance	$R_{\theta ja}$ $R_{\theta jc}$	50 31							°C/W
Operating junction temperature range	T_J	- 55 ---- + 150							°C
Storage temperature range	T_{STG}	- 55 ---- + 150							°C

Electrical Characteristics (@TA = 25°C unless otherwise specified)

Characteristic	Symbol	ES2AA	ES2BA	ES2CA	ES2DA	ES2GA	ES2HA	ES2JA	UNITS	
Maximum instantaneous forward voltage @2.0 A	V_F	0.95				1.25	1.7		V	
Maximum reverse current @TA=25°C at rated DC blocking voltage @TA=125°C	I_R	5.0				100				μA
Maximum reverse recovery time (Note1)	t_{rr}	35								ns

NOTE: 1. Measured with $I_F=0.5A$, $I_R=1A$, $I_{rr}=0.25A$.

2. Measured at 1.0MHz and applied reverse voltage of 4.0V DC.



Surface Mount Rectifiers

ES2AA--ES2JA

PACKAGE OUTLINE DIMENSIONS

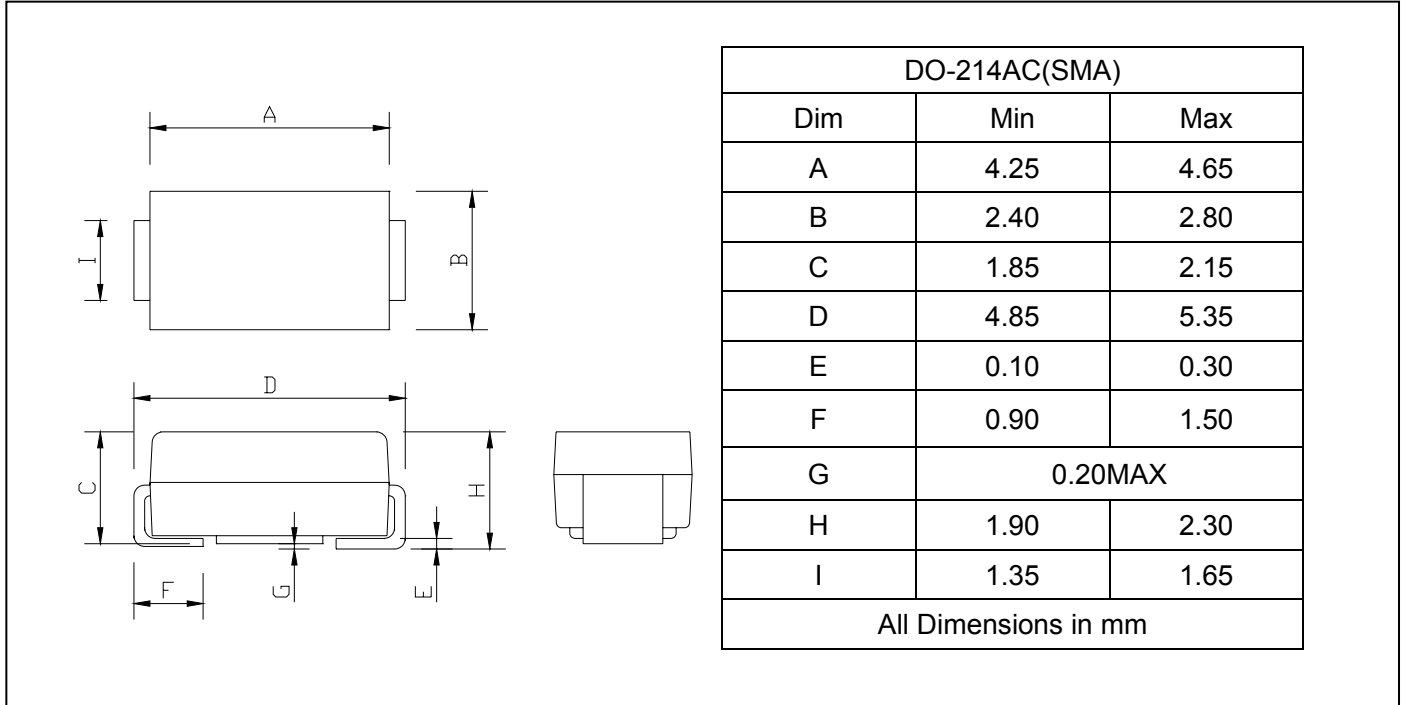

SOLDERING FOOTPRINT

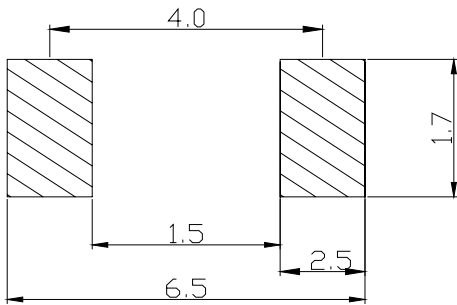

Unit : mm

PACKAGE INFORMATION

Device	Package	Shipping
ES2AA--ES2JA	DO-214AC(SMA)	5000/Tape&Reel



Surface Mount Rectifiers

ES2AA--ES2JA

FIG.1 -- TEST CIRCUIT DIAGRAM AND REVERSE RECOVERY TIME CHARACTERISTIC

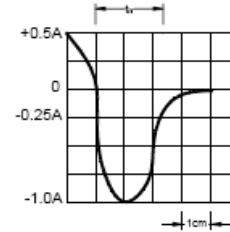
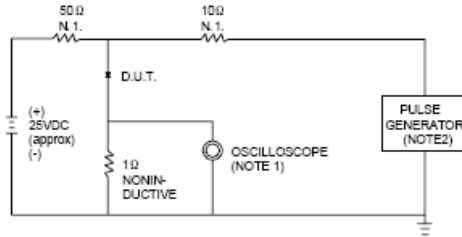

NOTES: 1. RISE TIME = 7ns MAX. INPUT IMPEDANCE = 1MΩ .22pF.
 2. RISE TIME = 10ns MAX. SOURCE IMPEDANCE = 50 Ω .

SET TIME BASE FOR 10/15 ns/cm

FIG.2 -- TYPICAL FORWARD CHARACTERISTIC

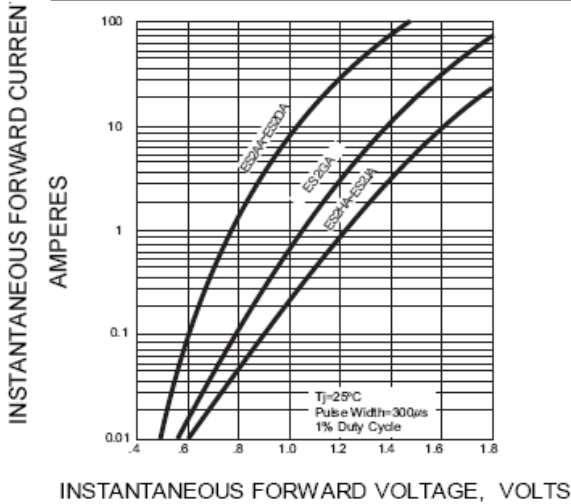

FIG.3 -- FORWARD DERATING CURVE

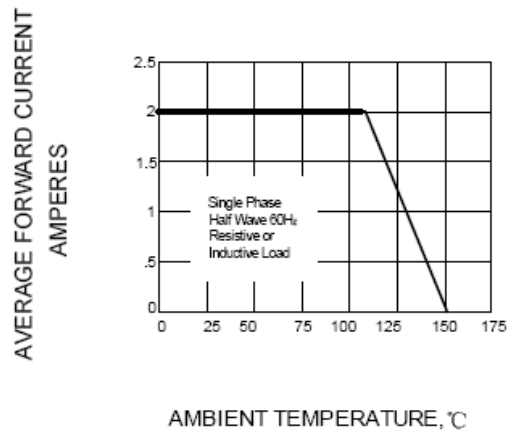

FIG.4 -- TYPICAL JUNCTION CAPACITANCE

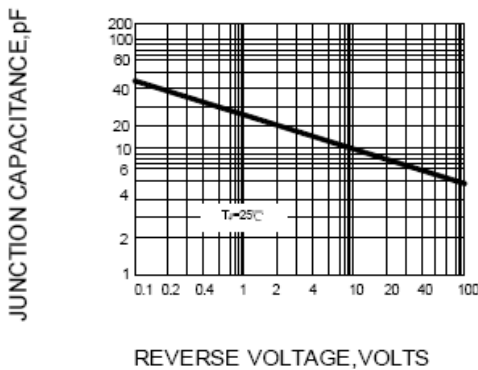

FIG.5 -- PEAK FORWARD SURGE CURRENT

