

Silicon Epitaxial Planar Transistor

2SC945

FEATURES

- High voltage and high current.
- Excellent h_{FE} linearity.
- Low noise.

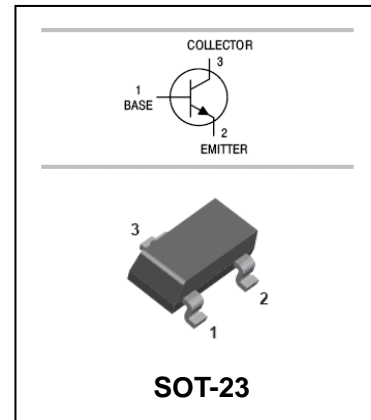

APPLICATIONS

- Audio frequency amplifier.

ORDERING INFORMATION

Type No.	Marking	Package Code
2SC945	CR	SOT-23

MAXIMUM RATING @ $T_a=25^{\circ}\text{C}$ unless otherwise specified

Symbol	Parameter	Value	Units
V_{CBO}	Collector-Base Voltage	60	V
V_{CEO}	Collector-Emitter Voltage	50	V
V_{EBO}	Emitter-Base Voltage	5	V
I_C	Collector Current -Continuous	100	mA
P_C	Collector Dissipation	200	mW
T_j, T_{stg}	Junction and Storage Temperature	-55 to +150	$^{\circ}\text{C}$



Silicon Epitaxial Planar Transistor

2SC945

ELECTRICAL CHARACTERISTICS @ Ta=25°C unless otherwise specified

Parameter	Symbol	Test conditions	MIN	TYP	MAX	UNIT
Collector-base breakdown voltage	$V_{(BR)CBO}$	$I_C=0.1mA, I_E=0$	60			V
Collector-emitter breakdown voltage	$V_{(BR)CEO}$	$I_C=1mA, I_B=0$	50			V
Emitter-base breakdown voltage	$V_{(BR)EBO}$	$I_E=0.1mA, I_C=0$	5			V
Collector cut-off current	I_{CBO}	$V_{CB}=60V, I_E=0$			0.1	μA
Collector cut-off current	I_{CEO}	$V_{CE}=50V, I_B=0$			0.1	μA
Emitter cut-off current	I_{EBO}	$V_{EB}=5V, I_C=0$			0.1	μA
DC current gain	h_{FE}	$V_{CE}=6V, I_C=1mA$ $V_{CE}=6V, I_C=0.1mA$	130 40		400	
Collector-emitter saturation voltage	$V_{CE(sat)}$	$I_C=100mA, I_B=10mA$		0.15	0.3	V
Base-emitter saturation voltage	$V_{BE(sat)}$	$I_C=100mA, I_B=10mA$		0.86	1	V
Base to Emitter Voltage	V_{BE}	$V_{CE}=6V, I_C=1.0mA$	0.55	0.62	0.65	V
Transition frequency	f_T	$V_{CE}=6V, I_C=10mA$ $f=30MHz$	150			MHz
Collector output capacitance	C_{ob}	$V_{CB}=10V, I_E=0, f=1MHz$		3.0	4.0	pF
Noise figure	NF	$V_{CE}=6V, I_C=0.1mA$ $f=1kHz, R_g=10k\Omega$		4	10	dB

CLASSIFICATION OF $h_{FE(1)}$

Rank	L	H
Range	130-200	200-400



Silicon Epitaxial Planar Transistor

2SC945

TYPICAL CHARACTERISTICS @ Ta=25°C unless otherwise specified

COLLECTOR CURRENT vs. COLLECTOR TO EMITTER VOLTAGE

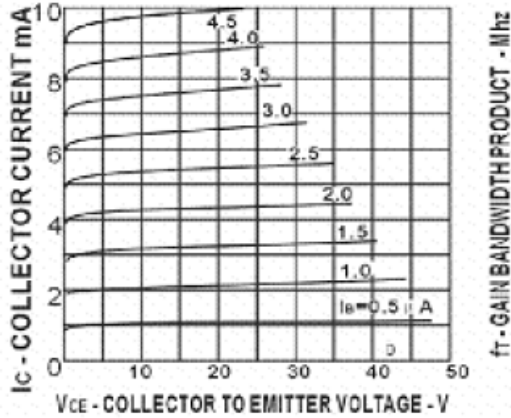

DC CURRENT GAIN vs. COLLECTOR CURRENT

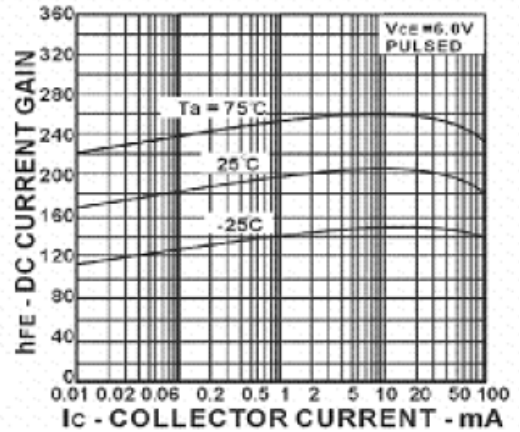

COLLECTOR AND BASE SATURATION VOLTAGE vs. COLLECTOR CURRENT

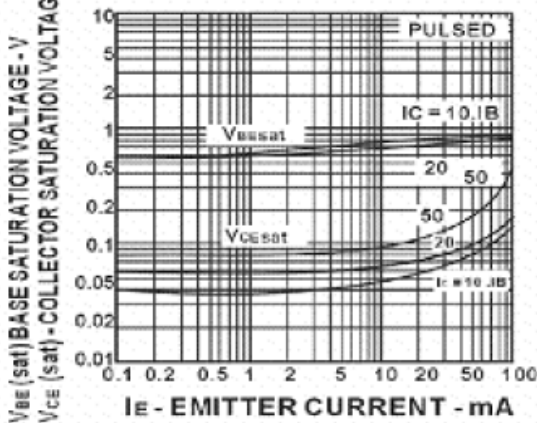

DC CURRENT GAIN vs. COLLECTOR CURRENT

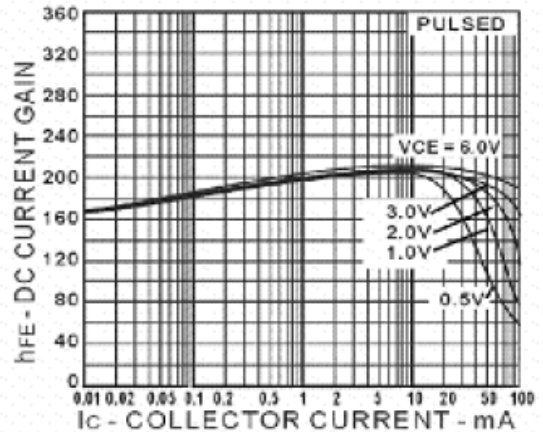

TOTAL Power Dissipation vs AMBIENT Temperature

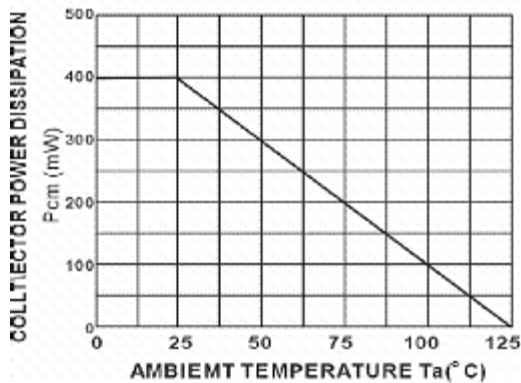

COLLECTOR CURRENT vs COLLECTOR TO EMITTER VOLTAGE

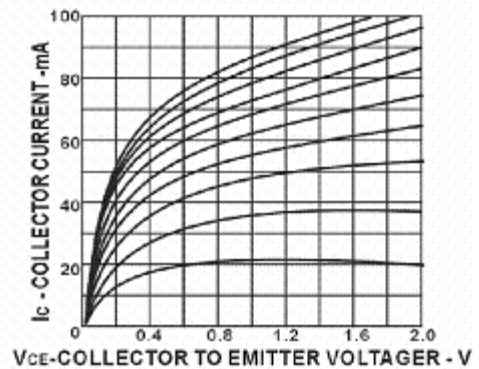



Silicon Epitaxial Planar Transistor

2SC945

PACKAGE OUTLINE

Plastic surface mounted package

SOT-23

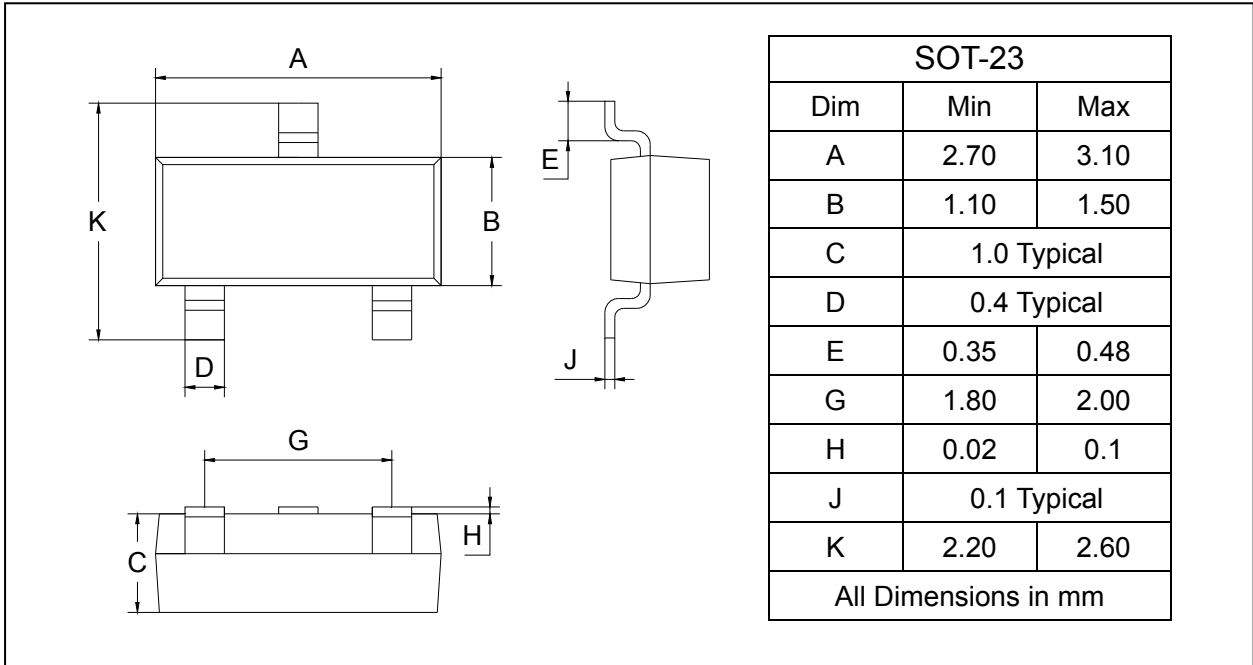

SOLDERING FOOTPRINT



PACKAGE INFORMATION

Device	Package	Shipping
2SC945	SOT-23	3000/Tape&Reel