

Silicon Epitaxial Planar Transistor

2SC2859

FEATURES

- Power dissipation: $P_C=150\text{mW}$.
- Excellent h_{FE} linearity: $h_{FE(2)}=25$
($V_{CE}=6\text{V}, I_C=400\text{mA}$).
- Complementary to 2SA1182.

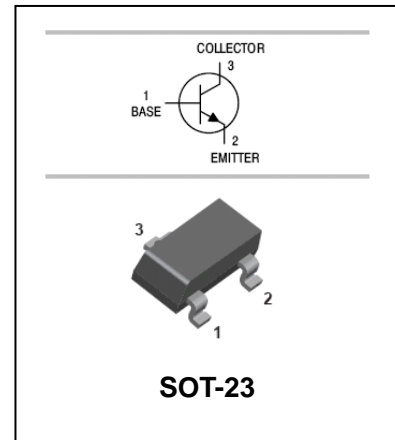

APPLICATIONS

- Audio frequency general purpose amplifier applications.

ORDERING INFORMATION

Type No.	Marking	Package Code
2SC2859	WOWY/WG	SOT-23

MAXIMUM RATING @ $T_a=25^\circ\text{C}$ unless otherwise specified

Symbol	Parameter	Value	Units
V_{CBO}	Collector-Base Voltage	35	V
V_{CEO}	Collector-Emitter Voltage	30	V
V_{EBO}	Emitter-Base Voltage	5	V
I_C	Collector Current -Continuous	500	mA
P_C	Collector Dissipation	150	mW
T_j, T_{stg}	Junction and Storage Temperature	-55 to +125	$^\circ\text{C}$



Silicon Epitaxial Planar Transistor

2SC2859

ELECTRICAL CHARACTERISTICS @ Ta=25°C unless otherwise specified

Parameter	Symbol	Test conditions	MIN	TYP	MAX	UNIT
Collector-base breakdown voltage	$V_{(BR)CBO}$	$I_C=100\mu A, I_E=0$	35			V
Collector-emitter breakdown voltage	$V_{(BR)CEO}$	$I_C=1mA, I_B=0$	30			V
Emitter-base breakdown voltage	$V_{(BR)EBO}$	$I_E=100\mu A, I_C=0$	5			V
Collector cut-off current	I_{CBO}	$V_{CB}=35V, I_E=0$			0.1	μA
Emitter cut-off current	I_{EBO}	$V_{EB}=5V, I_C=0$			0.1	μA
DC current gain	h_{FE}	$V_{CE}=1V, I_C=100mA$ $V_{CE}=6V, I_C=400mA$	70 25		400	
Collector-emitter saturation voltage	$V_{CE(sat)}$	$I_C=100mA, I_B=10mA$		0.1	0.25	V
Base-emitter voltage	V_{BE}	$V_{CE}=1V, I_C=100mA$		0.8	1.0	V
Collector output capacitance	C_{ob}	$V_{CB}=6V, I_E=0, f=1MHz$		7		pF
Transition frequency	f_T	$V_{CE}=6V, I_C=20mA$		300		MHz

CLASSIFICATION OF $h_{FE(1)}$

Rank	O	Y	G
Range	70-140	120-240	200-400



Silicon Epitaxial Planar Transistor

2SC2859

TYPICAL CHARACTERISTICS @ $T_a=25^\circ\text{C}$ unless otherwise specified

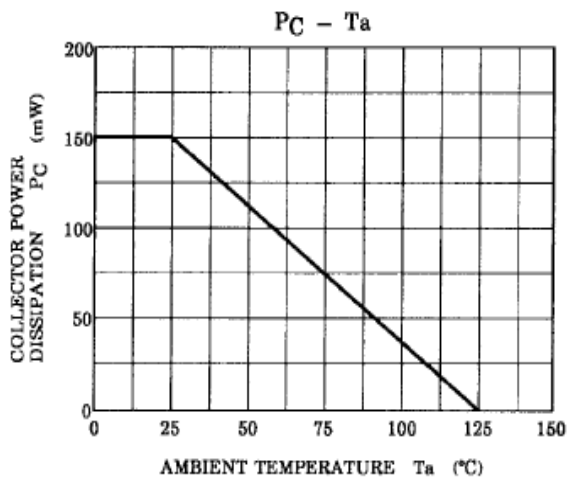
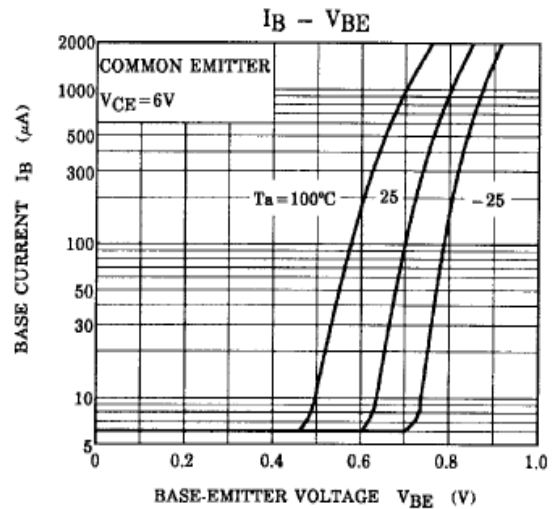
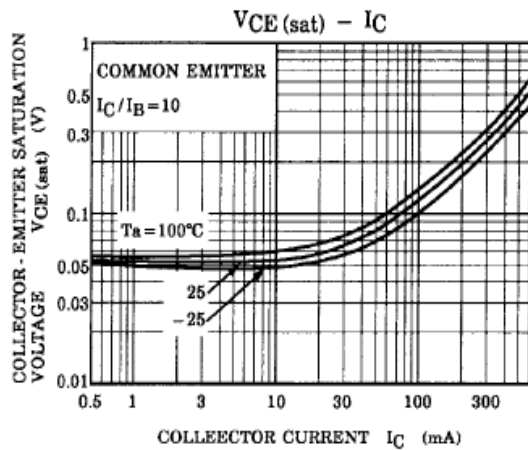
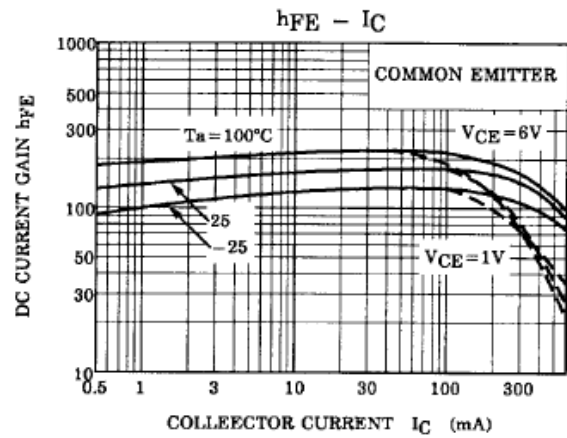
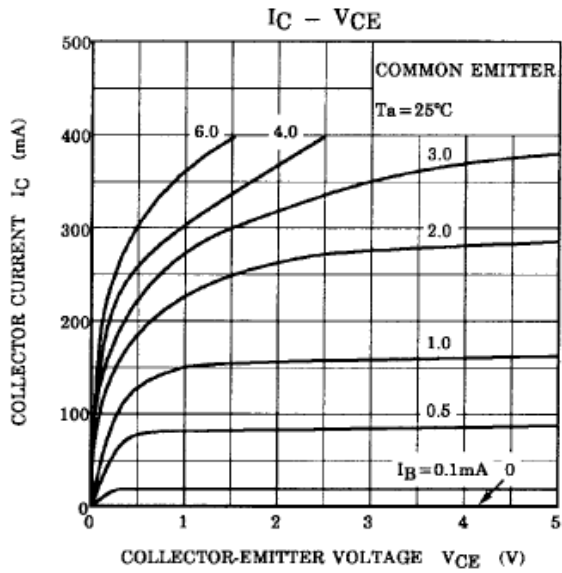



Silicon Epitaxial Planar Transistor

2SC2859

PACKAGE OUTLINE

Plastic surface mounted package

SOT-23

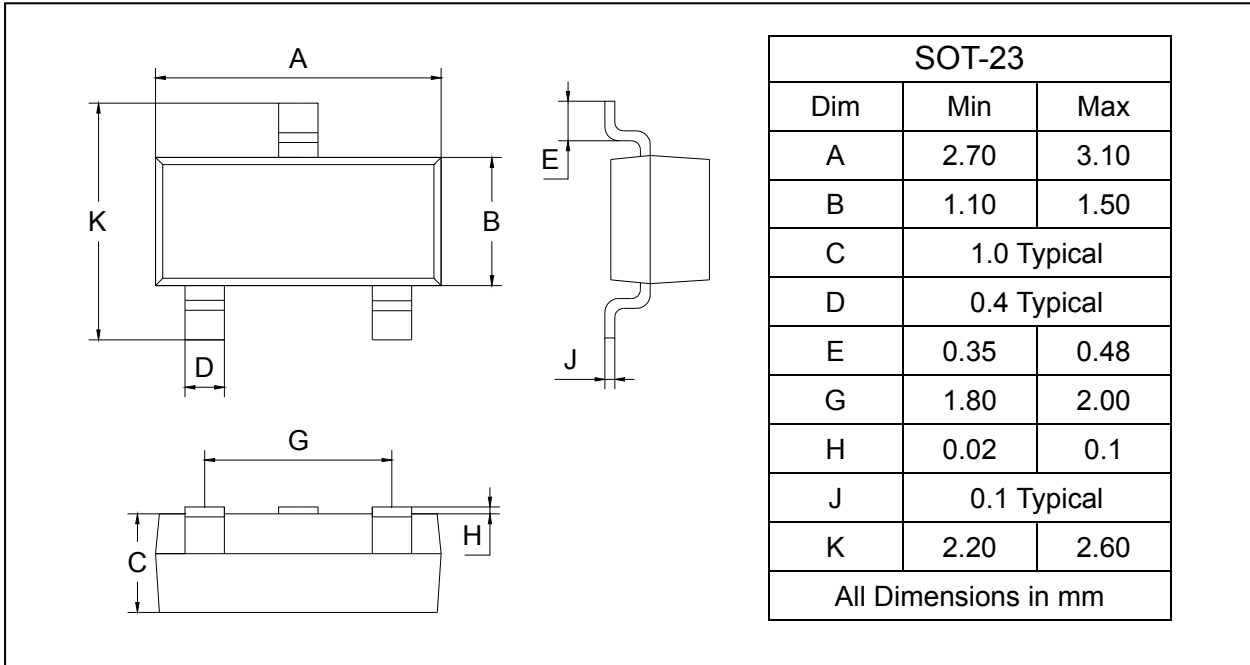

SOLDERING FOOTPRINT

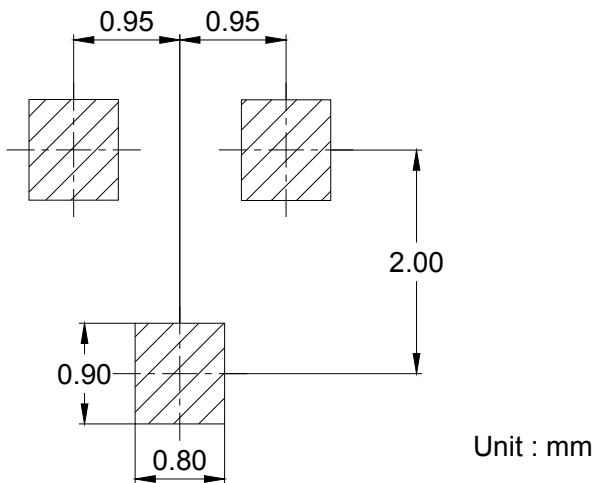

PACKAGE INFORMATION

Device	Package	Shipping
2SC2859	SOT-23	3000/Tape&Reel