

Quick Reference Applications Guide

General Cable manufactures the most comprehensive line of Carol[®] Brand Electronic Cables available today for signal & data transmission, security, fire alarm & life safety, sound and audio/video & home entertainment. Our products are readily available for immediate shipment through a network of authorized stocking distributors and distribution centers.

Alarm and Security:

General Cable's Carol[®] Brand is the right solution for your alarm and security needs. Carol offers as broad an offering as anyone in the industry. Our Alarm & Security Solutions Guide makes it easier to specify and sell the right cables for every application in this ever-growing market.

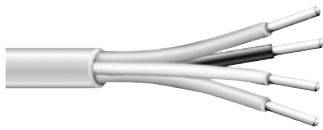
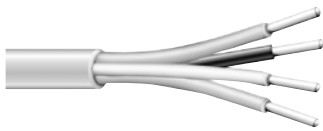

| PART NUMBER | PRODUCT DESCRIPTION | APPLICATIONS |
|---|--|--|
| PLENUM UNSHIELDED ALARM AND SECURITY | | |
| E3004S | 22/4 Multi-Cond. 7/30TC SHLD CM | <ul style="list-style-type: none"> Power-Limited Control Circuits Wiring of Intercom, Security, Audio, Background Music Suggested Voltage Rating: 300 V |
| E3032S | 18/2 Multi-Cond. 7/30TC SHLD CM | |
| E3034S | 18/4 Multi-Cond. 16/30TC SHLD CM | |
| E3033S | 18/3 Multi-Cond. 16/30TC SHLD CM | |
| E3042S | 16/2 Multi-Cond. 19/30TC SHLD CM | |
| PLENUM SHIELDED ALARM AND SECURITY | | |
| E2104S | 22/4 Multi-Cond. 7/30BC OA SH CMP/CL3P | <ul style="list-style-type: none"> Power-Limited Control Circuits Wiring of Intercom, Security, Audio, Background Music Suggested Voltage Rating: 300 V |
| E2106S | 22/6 Multi-Cond. 7/30BC OA SH CMP/CL3P | |
| E2202S | 18/2 Multi-Cond. 7/26BC OA SH CMP/CL3P | |
| E2204S | 18/4 Multi-Cond. 7/26BC OA SH CMP/CL3P | |
| E2206S | 18/6 Multi-Cond. 7/26BC OA SH CMP/CL3P | |
| RISER (NON-PLENUM) UNSHIELDED ALARM AND SECURITY | | |
| E1002S | 22/2 Multi-Cond. 7/30BC UNSH CMR/CL3R | <ul style="list-style-type: none"> Power-Limited Control Circuits Wiring of Intercom, Security, Audio, Background Music Suggested Voltage Rating: 300 V |
| E1004S | 22/4 Multi-Cond. 7/30BC UNSH CMR/CL3R | |
| E1032S | 18/2 Multi-Cond. 7/26BC UNSH CMR/CL3R | |
| E1034S | 18/4 Multi-Cond. 7/26BC UNSH CMR/CL3R | |
| E1042S | 16/2 Multi-Cond. 19/0117BC UNSH CMR | |
| RISER (NON-PLENUM) SHIELDED ALARM AND SECURITY | | |
| E2002S | 22/2 Multi-Cond. 7/30BC OA SH CMR/CL3R | <ul style="list-style-type: none"> Power-Limited Control Circuits Wiring of Intercom, Security, Audio, Background Music Suggested Voltage Rating: 300 V |
| E2032S | 18/2 Multi-Cond. 7/26BC OA SH CMR/CL3R | |
| E2033S | 18/3 Multi-Cond. 7/26BC OA SH CMR/CL3R | |
| E2034S | 18/4 Multi-Cond. 7/26BC OA SH CMR/CL3R | |
| E2042S | 16/2 Multi-Cond. 19/0117BC OA SH CMR | |

Fire Alarm:

General Cable's offering has expanded from a rather simple and unsophisticated business configured upon large, electromechanical devices to one relying upon the most modern technologies of microprocessor and chip technology. Our Carol[®] Brand designs have proven themselves in the area of fire system security over time; all are fabricated with solid, bare copper conductors and insulations and jackets of premium-grade PVC. Offered both with and without shields, the former to protect these critical circuits from noise, these cables will provide the latest in available technology for the system installer and contractor.

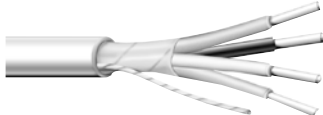
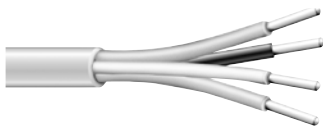

| PART NUMBER | PRODUCT DESCRIPTION | APPLICATIONS |
|---|---|---|
| PLENUM UNSHIELDED FIRE ALARM | | |
| E3502S | 1/28 Multi-Cond. SBC PVC/NS/FLEX FPLP | <ul style="list-style-type: none"> Residential Housing Business and Office Campus Environments Public Stadiums and Arenas Airport, Train, Bus and Other Transportation Hubs Schools, Colleges and Universities Commercial Buildings |
| E3504S | 18/4 Multi-Cond. SBC PVC/NS/FLEX FPLP | |
| E3512S | 16/2 Multi-Cond. SBC PVC/NS/FLEX FPLP | |
| E3522S | 14/2 Multi-Cond. SBC PVC/NS/FLEX FPLP | |
| E3532S | 12/2 Multi-Cond. SBC PVC/NS/FLEX FPLP | |
| PLENUM SHIELDED FIRE ALARM | | |
| E3602S | 18/2 Multi-Cond. SBC PVC/OA/FLEX FPLP | <ul style="list-style-type: none"> Residential Housing Business and Office Campus Environments Public Stadiums and Arenas Airport, Train, Bus and Other Transportation Hubs Schools, Colleges and Universities Commercial Buildings |
| E3604S | 18/4 Multi-Cond. SBC PVC/OA/FLEX FPLP/CMP | |
| E3612S | 16/2 Multi-Cond. SBC PVC/OA/FLEX FPLP | |
| E3622S | 14/2 Multi-Cond. SBC PVC/OA/FLEX FPLP | |
| E3632S | 12/2 Multi-Cond. SBC PVC/OA/FLEX FPLP/CMP | |
| RISER (NON-PLENUM) UNSHIELDED FIRE ALARM | | |
| E1502S | 18/2 Multi-Cond. SBC UNSH TYPE FPLR | <ul style="list-style-type: none"> Residential Housing Business and Office Campus Environments Public Stadiums and Arenas Airport, Train, Bus and Other Transportation Hubs Schools, Colleges and Universities Commercial Buildings |
| E1504S | 18/4 Multi-Cond. SBC UNSH TYPE FPLR | |
| E1512S | 16/2 Multi-Cond. SBC UNSH TYPE FPLR | |
| E1522S | 14/2 Multi-Cond. SBC UNSH TYPE FPLR | |
| E1532S | 12/2 Multi-Cond. SBC UNSH TYPE FPLR | |
| RISER (NON-PLENUM) SHIELDED FIRE ALARM | | |
| E2502S | 18/2 Multi-Cond. SBC OA SH TYPE FPLR | <ul style="list-style-type: none"> Residential Housing Business and Office Campus Environments Public Stadiums and Arenas Airport, Train, Bus and Other Transportation Hubs Schools, Colleges and Universities Commercial Buildings |
| E2504S | 18/4 Multi-Cond. SBC OA SH TYPE FPLR | |
| E2522S | 16/2 Multi-Cond. SBC OA SH TYPE FPLR | |
| E2524S | 16/4 Multi-Cond. SBC OA SH TYPE FPLR | |
| E2532S | 14/2 Multi-Cond. SBC OA SH TYPE FPLR | |

NOTE: Other gauges, colors and packaging are available. Contact your General Cable representative for additional ordering options.

Classics – Comm & Control:

Paired cable designs find frequent application in circuits requiring circuit-to-circuit isolation from noise, minimization of capacitance imbalances and a reduction of EMI interference currents. Circuit separation is further enhanced in those designs employing individual circuit shields in concert with an overall shield. These Carol® Brand shielding systems are available from General Cable in myriad combinations to suit the unique needs of the circuit designer.

* Paired constructions are also available

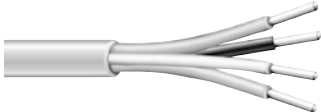

| PART NUMBER | PRODUCT DESCRIPTION | APPLICATIONS |
|-----------------------------------|--|--|
| RISER SHIELDED CLASSICS | | |
| C2514A | 22/2 Multi-Cond. 7/30TC SHLD CM | <ul style="list-style-type: none"> • Remote and Process Control • Public Address Systems • Building Automation for EIA 232 Serial Applications • HVAC/Lighting |
| C0763A | 22/6 Multi-Cond. 7/30TC SHLD CM | |
| C2534A | 18/2 Multi-Cond. 16/30TC SHLD CM | |
| C2535A | 18/3 Multi-Cond. 16/30TC SHLD CM | |
| C2543A | 18/4 Multi Cond. 19/30TC SHLD CM | |
| RISER UNSHIELDED CLASSICS | | |
| C6348A | 22/2 Multi-Cond. 7/30TC UNSH CM | <ul style="list-style-type: none"> • Remote and Process Control • Public Address Systems • Building Automation for EIA 232 Serial Applications • HVAC/Lighting |
| C4062A | 22/3 Multi-Cond. 7/30TC UNSH CM | |
| C4063A | 22/4 Multi-Cond. 7/30TC UNSH CM | |
| C6351A | 20/2 Multi-Cond. 7/28TC UNSH CM | |
| C2831A | 18/3 Multi-Cond. 16/30TC UNSH CM | |
| PLENUM SHIELDED CLASSICS | | |
| C3158 | 22/2 Multi-Cond. 7/30TC PVC/SHLD/FLEX CMP | <ul style="list-style-type: none"> • Remote and Process Control • Public Address Systems • Building Automation for EIA 232 Serial Applications • HVAC/Lighting |
| C3062 | 18/2 Multi-Cond. 7/26BC PVC/SHLD/FLEX CMP | |
| C3063 | 18/4 Multi Cond. 7/26BC PVC/SHLD/FLEX CMP | |
| C3065 | 18/6 Multi-Cond. 7/26BC PVC/SHLD/FLEX CMP | |
| C3068 | 16/2 Multi-Cond. 19/.0117BC SHLD/FLEX CMP | |
| PLENUM UNSHIELDED CLASSICS | | |
| C3115 | 22/2 Multi-Cond. 7/30TC PVC/UNSH/FLEX CMP | <ul style="list-style-type: none"> • Remote and Process Control • Public Address Systems • Building Automation for EIA 232 Serial Applications • HVAC/Lighting |
| C3112 | 18/2 Multi-Cond. 7/26BC PVC/UNSH/FLEX CMP | |
| C3113 | 18/4 Multi-Cond. 7/26BC PVC/UNSH/FLEX CMP | |
| C3122 | 18/8 Multi-Cond. 7/26BC PVC/UNSH/FLEX CMP | |
| C3128 | 14/2 Multi-Cond. 19/.0147BC UNSH/FLEX CL3P | |

Classics – Hi-Temp:

As with the multi-conductor designs, a wide array of insulating and jacketing materials are available to meet specific electronic applications. General Cable's Carol® Brand communication cable products are manufactured to meet the latest UL, CSA and NEC requirements and approvals.

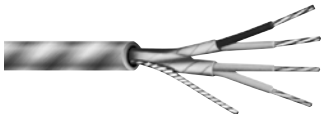
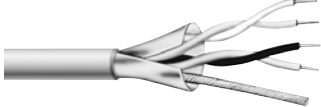

| PART NUMBER | PRODUCT DESCRIPTION | APPLICATIONS |
|--|--|---|
| MULTI-PAIRED UNSHIELDED HI-TEMP CLASSICS | | |
| C8122 | 18/1 Multi-Pr. 19/30TC UNSH FLP/PVC CMP | <ul style="list-style-type: none"> • Remote Control Circuits • Process Control and Instrumentation • Suggested Voltage Rating: 300 V |
| MULTI-PAIRED SHIELDED HI-TEMP CLASSICS | | |
| C8118 | 24/2 Multi-Pr. 7/32TC SHLD FFEP/PVDF CMP | <ul style="list-style-type: none"> • Remote Control Circuits • Process Control and Instrumentation • Suggested Voltage Rating: 300 V |
| C8109 | 22/1 Multi-Pr. 7/30TC SHLD FEP/FEP CMP | |
| C8103 | 22/1 Multi-Pr. 7/30TC SHLD FEP/PVDF CMP | |
| C8101 | 18/1 Multi-Pr. 19/30TC SHLD FEP/FEP CMP | |
| C8104 | 18/1 Multi-Pr. 19/30TC SHLD FEP/PVDF CMP | |
| C8127 | 24/1 Multi-Pr. 7/32TC SHLD FEP/PVC CMP | |
| C8113 | 24/3 Multi-Pr. 7/32TC SHLD FEP/LSPVC CMP | |
| C8126 | 22/1 Multi-Pr. 7/30TC SHLD FEP/PVC CMP | |
| C8124 | 22/1 Multi-Pr. 7/30TC SHLD FEP/PVC CMP | |
| C8123 | 18/1 Multi-Pr. 19/30TC SHLD FEP/PVC CMP | |
| MULTI-PAIRED DUAL SHIELDED HI-TEMP CLASSICS | | |
| C8117 | 24/1 Multi-Pr. 7/32TC FOIL/BRD SHLD FEP/FEP CMP | <ul style="list-style-type: none"> • Remote Control Circuits |
| C8129 | 24/2 Multi-Pr. 7/32TC FOIL/BRD SHLD FFEP/PVDF CMP | |
| MULTI-PAIRED INDIVIDUALLY SHIELDED HI-TEMP CLASSICS | | |
| C8134 | 24/2 Multi-Pr. 7/32TC ISHLD FFEP/PVC CMP | <ul style="list-style-type: none"> • Remote Control Circuits • Process Control and Instrumentation • Suggested Voltage Rating: 300 V |
| C8105 | 22/2 Multi-Pr. 7/30TC ISHLD FEP/PVC CMP | |
| C8131 | 22/3 Multi-Pr. 7/30TC ISHLD FEP/PVC CMP | |
| C8133 | 22/6 Multi-Pr. 7/30TC ISHLD FEP/PVC CMP | |
| C8112 | 22/2 Multi-Pr. 7/30TC ISHLD FEP/FEP CMP | |
| C8132 | 22/6 Multi-Pr. 7/30TC ISHLD FEP/FEP CMP | |
| C8128 | 24/2 Multi-Pr. 7/32TC ISHLD FFEP/PVDF CMP | |
| MULTI-CONDUCTOR UNSHIELDED HI-TEMP CLASSICS | | |
| C8102 | 18/4 Multi-Cond. 19/30TC UNSH FEP/FEP CMP | <ul style="list-style-type: none"> • Process Control and Instrumentation |
| MULTI-CONDUCTOR SHIELDED HI-TEMP CLASSICS | | |
| C8106 | 18/3 Multi-Cond. 19/30TC SHLD FEP/FEP CMP | <ul style="list-style-type: none"> • Process Control and Instrumentation |
| C8114 | 18/4 Multi-Cond. 19/30TC SHLD FEP/FEP CMP | |
| MULTI-CONDUCTOR DUAL SHIELDED HI-TEMP CLASSICS | | |
| C8107 | 18/3 Multi-Cond. 19/30TC FOIL/BRD SHLD FEP/FEP CMP | <ul style="list-style-type: none"> • Remote Control Circuits • Process Control and Instrumentation • Suggested Voltage Rating: 300 V |
| C8110 | 18/4 Multi-Cond. 19/30TC FOIL/BRD SHLD FEP/FEP CMP | |
| C8120 | 18/6 Multi-Cond. 19/30TC FOIL/BRD SHLD FEP/FEP CMP | |
| C8111 | 16/2 Multi-Cond. 19/29TC FOIL/BRD SHLD FEP/FEP CMP | |
| C8119 | 16/3 Multi-Cond. 19/29TC FOIL/BRD SHLD FEP/FEP CMP | |
| C8108 | 16/6 Multi-Cond. 19/29TC FOIL/BRD SHLD FEP/FEP CMP | |

NOTE: Other gauges, colors and packaging are available. Contact your General Cable representative for additional ordering options.

EXZEL®:

EXZEL® High-Endurance Electronic Cables are manufactured with the selection, quality and dependability our customers have come to expect from Carol® Brand. From special jacket colors, print legends and TRU-Mark® sequential footage markings to unique constructions, innovative materials and quality manufacturing, General Cable's expert engineers offer superior service and design assistance.

*Paired constructions are available

*LSZH constructions are available



| PART NUMBER | PRODUCT DESCRIPTION | APPLICATIONS |
|---|-------------------------------------|---|
| MULTI-CONDUCTOR UNSHIELDED COMMUNICATION AND CONTROL | | |
| C9009A | 22/2 Multi-Cond. 7/30TC UNSH CM | <ul style="list-style-type: none"> • Advanced Signal Transmission in Controlled Environments • Medical Instrumentation and Equipment • Consumer Electronic Peripherals • Industrial Process Control Systems • Suitable for EIA-RS-232 Applications |
| C9010A | 22/3 Multi-Cond. 7/30TC UNSH CM | |
| C9011A | 22/4 Multi-Cond. 7/30TC UNSH CM | |
| C9012A | 22/6 Multi-Cond. 7/30TC UNSH CM | |
| C9013A | 22/8 Multi-Cond. 7/30TC UNSH CM | |
| C9014A | 22/10 Multi-Cond. 7/30TC UNSH CM | |
| C9015A | 22/15 Multi-Cond. 7/30TC UNSH CM | |
| C9018A | 20/2 Multi-Cond. 7/28TC UNSH CM | |
| C9019A | 20/3 Multi-Cond. 7/28TC UNSH CM | |
| C9020A | 20/4 Multi-Cond. 7/28TC UNSH CM | |
| C9021A | 20/6 Multi-Cond. 7/28TC UNSH CM | |
| C9022A | 20/8 Multi-Cond. 7/28TC UNSH CM | |
| C9023A | 20/10 Multi-Cond. 7/28TC UNSH CM | |
| C9024A | 20/15 Multi-Cond. 7/28TC UNSH CM | |
| C9028A | 2/18 Multi-Cond. 16/30TC UNSH CM | |
| C9030A | 3/18 Multi-Cond. 16/30TC UNSH CM | |
| C9031A | 4/18 Multi-Cond. 16/30TC UNSH CM | |
| C9032A | 6/18 Multi-Cond. 16/30TC UNSH CM | |
| C9033A | 8/18 Multi-Cond. 16/30TC UNSH CM | |
| C9034A | 10/18 Multi-Cond. 16/30TC UNSH CM | |
| C9035A | 15/18 Multi-Cond. 16/30TC UNSH CM | |
| C9039A | 2/16 Multi-Cond. 19/0117TC UNSH CM | |
| C9041A | 3/16 Multi-Cond. 19/0117TC UNSH CM | |
| C9042A | 4/16 Multi-Cond. 19/0117TC UNSH CM | |
| C9043A | 6/16 Multi-Cond. 19/0117TC UNSH CM | |
| C9044A | 8/16 Multi-Cond. 19/0117TC UNSH CM | |
| C9045A | 10/16 Multi-Cond. 19/0117TC UNSH CM | |



| PART NUMBER | PRODUCT DESCRIPTION | APPLICATIONS |
|---|-------------------------------------|---|
| MULTI-CONDUCTOR SHIELDED COMMUNICATION AND CONTROL | | |
| C9109A | 22/2 Multi-Cond. 7/30TC SHLD CM | <ul style="list-style-type: none"> • Advanced Signal Transmission in Controlled Environments • Medical Instrumentation and Equipment • Consumer Electronic Peripherals • Industrial Process Control Systems • Suitable for EIA-RS-232 Applications |
| C9110A | 22/3 Multi-Cond. 7/30TC SHLD CM | |
| C9111A | 22/4 Multi-Cond. 7/30TC SHLD CM | |
| C9112A | 22/6 Multi-Cond. 7/30TC SHLD CM | |
| C9113A | 22/8 Multi-Cond. 7/30TC SHLD CM | |
| C9114A | 22/10 Multi-Cond. 7/30TC SHLD CM | |
| C9115A | 22/15 Multi-Cond. 7/30TC SHLD CM | |
| C9118A | 20/2 Multi-Cond. 7/28TC SHLD CM | |
| C9119A | 20/3 Multi-Cond. 7/28TC SHLD CM | |
| C9120A | 20/4 Multi-Cond. 7/28TC SHLD CM | |
| C9121A | 20/6 Multi-Cond. 7/28TC SHLD CM | |
| C9122A | 20/8 Multi-Cond. 7/28TC SHLD CM | |
| C9123A | 20/10 Multi-Cond. 7/28TC SHLD CM | |
| C9124A | 20/15 Multi-Cond. 7/28TC SHLD CM | |
| C9127A | 18/2 Multi-Cond. 16/30TC SHLD CM | |
| C9129A | 18/3 Multi-Cond. 16/30TC SHLD CM | |
| C9131A | 18/4 Multi-Cond. 16/30TC SHLD CM | |
| C9132A | 18/6 Multi-Cond. 16/30TC SHLD CM | |
| C9133A | 18/8 Multi-Cond. 16/30TC SHLD CM | |
| C9134A | 18/10 Multi-Cond. 16/30TC SHLD CM | |
| C9135A | 18/15 Multi-Cond. 16/30TC SHLD CM | |
| C9138A | 16/2 Multi-Cond. 19/0117TC SHLD CM | |
| C9140A | 16/3 Multi-Cond. 19/0117TC SHLD CM | |
| C9142A | 16/4 Multi-Cond. 19/0117TC SHLD CM | |
| C9143A | 16/6 Multi-Cond. 19/0117TC SHLD CM | |
| C9144A | 16/8 Multi-Cond. 19/0117TC SHLD CM | |
| C9145A | 16/10 Multi-Cond. 19/0117TC SHLD CM | |



| PART NUMBER | PRODUCT DESCRIPTION | APPLICATIONS |
|--|---|---|
| MULTI-CONDUCTOR DUAL SHIELDED COMMUNICATION AND CONTROL | | |
| C9209A | 22/2 Multi-Cond. 7/30TC FOIL/BRD SHLD CM | <ul style="list-style-type: none"> • Advanced Signal Transmission in Controlled Environments • Medical Instrumentation and Equipment • Consumer Electronic Peripherals • Industrial Process Control Systems • Suitable for EIA-RS-232 Applications |
| C9210A | 22/3 Multi-Cond. 7/30TC FOIL/BRD SHLD CM | |
| C9211A | 22/4 Multi-Cond. 7/30TC FOIL/BRD SHLD CM | |
| C9212A | 22/6 Multi-Cond. 7/30TC FOIL/BRD SHLD CM | |
| C9213A | 22/8 Multi-Cond. 7/30TC FOIL/BRD SHLD CM | |
| C9214A | 22/10 Multi-Cond. 7/30TC FOIL/BRD SHLD CM | |
| C9215A | 22/15 Multi-Cond. 7/30TC FOIL/BRD SHLD CM | |
| C9218A | 20/2 Multi-Cond. 7/28TC FOIL/BRD SHLD CM | |
| C9219A | 20/3 Multi-Cond. 7/28TC FOIL/BRD SHLD CM | |
| C9220A | 20/4 Multi-Cond. 7/28TC FOIL/BRD SHLD CM | |
| C9221A | 20/6 Multi-Cond. 7/28TC FOIL/BRD SHLD CM | |
| C9222A | 20/8 Multi-Cond. 7/28TC FOIL/BRD SHLD CM | |
| C9223A | 20/10 Multi-Cond. 7/28TC FOIL/BRD SHLD CM | |
| C9224A | 20/15 Multi-Cond. 7/28TC FOIL/BRD SHLD CM | |
| C9228A | 18/2 Multi-Cond. 16/30TC FOIL/BRD SHLD CM | |
| C9230A | 18/3 Multi-Cond. 16/30TC FOIL/BRD SHLD CM | |
| C9231A | 18/4 Multi-Cond. 16/30TC FOIL/BRD SHLD CM | |
| C9232A | 18/6 Multi-Cond. 16/30TC FOIL/BRD SHLD CM | |
| C9233A | 18/8 Multi-Cond. 16/30TC FOIL/BRD SHLD CM | |

NOTE: Other gauges, colors and packaging are available. Contact your General Cable representative for additional ordering options.

DBRF Coax for Distributed Antenna Systems (DAS):

The ability to communicate anywhere with wireless devices or cell phones, both indoors and out, continues to be a growing demand that requires Distributed Antenna Systems (DAS). A DAS is a network of spatially separated antennas connected to a transport medium, typically coax or fiber optic cable, that provides wireless service within a building or structure.

| PART NUMBER | PRODUCT DESCRIPTION | DBRF COAX | APPLICATIONS |
|-------------|---|-----------|---|
| DBRF100 | PVC Jacket - Indoor/Outdoor | | <ul style="list-style-type: none"> • 2-way Land Mobile Radios • Wireless Local Area Networks IEEE802.11 • Wireless Local Loop • Wireless Internet (WISP) • Wireless Cable (MMDS) • Wireless Broadband Data • Telemetry • Commercial Buildings • Residential Housing • Business and Office Campus Environments • Public Stadiums and Arenas • Transportation Hubs like Airports, Train Stations and Bus Stations • Primary and Secondary Schools, Universities and Colleges • Governments and Municipalities |
| DBRF100HF | FR-LSZH Jacket - Indoor/CMR Riser | | |
| DBRF100R | FR-PVC Jacket - Indoor/CMR Riser | | |
| DBRF100P | LS-PVC Jacket - Indoor/CMP Plenum | | |
| DBRF195 | Polyethylene Jacket - Indoor/Outdoor | | |
| DBRF195FL | Polyethylene Jacket - Outdoor/Flooded Water-Resistant | | |
| DBRF195HF | FR-LSZH Jacket - Indoor/CMR Riser | | |
| DBRF195R | FR-PVC Jacket - Indoor/CMR Riser | | |
| DBRF195P | LS-PVC Jacket - Indoor/CMP Plenum | | |
| DBRF200 | Polyethylene Jacket - Indoor/Outdoor | | |
| DBRF200FL | Polyethylene Jacket - Outdoor/Flooded Water-Resistant | | |
| DBRF200HF | FR-LSZH Jacket - Indoor/CMR Riser | | |
| DBRF200R | FR-PVC Jacket - Indoor/CMR Riser | | |
| DBRF200P | LS-PVC Jacket - Indoor/CMP Plenum | | |
| DBRF240 | Polyethylene Jacket - Indoor/Outdoor | | |
| DBRF240FL | Polyethylene Jacket - Outdoor/Flooded Water-Resistant | | |
| DBRF240HF | FR-LSZH Jacket - Indoor/CMR Riser | | |
| DBRF240R | FR-PVC Jacket - Indoor/CMR Riser | | |
| DBRF240P | LS-PVC Jacket - Indoor/CMP Plenum | | |
| DBRF300 | Polyethylene Jacket - Indoor/Outdoor | | |
| DBRF300FL | Polyethylene Jacket - Flooded Water-Resistant Outdoor | | |
| DBRF300HF | FR-LSZH Jacket - Indoor/CMR Riser | | |
| DBRF300R | FR-PVC Jacket - Indoor/CMR Riser | | |
| DBRF300P | LS-PVC Jacket - Indoor/CMP Plenum | | |
| DBRF400 | Polyethylene Jacket - Outdoor | | |
| DBRF400FL | Polyethylene Jacket - Outdoor/Flooded Water-Resistant | | |
| DBRF400HF | FR-LSZH Jacket - Indoor/CMR Riser | | |
| DBRF400R | FR-PVC Jacket - Indoor/CMR Riser | | |
| DBRF400P | PVDF Jacket - Indoor/CMP Plenum - 150C | | |



NOTE: Fiber/Power Composite Cables, as well as other gauges, colors and packaging, are available. Contact your General Cable representative for additional ordering options.

Coax:

General Cable offers a complete line of Carol® Brand Coaxial Cables for today's sophisticated high-speed, wide-bandwidth electronics products that run over long distances with minimal signal loss or degradation.



| PART NUMBER | PRODUCT DESCRIPTION | APPLICATIONS | |
|-------------|---|------------------|------------------------------------|
| C5775 | 18/1 RG6/U FL+60%AL/BRD SHLD CL2/CM | • CATV • MATV | |
| C5886 | 18/1 RG6/U FL+60%AL/BRD SHLD CMR | | |
| C5785 | 18/1 RG6/U QUAD SHLD CL2/CM | | |
| C5889 | 18/1 RG6/U QUAD SHLD RISER | | |
| C1156 | 26/1 RG174U 88%TC/BRD SHLD | | |
| C3524 | 18/1 RG6/U FL+80%AL/BRD SHLD CL2P/CMP | | |
| C3525 | 18/1 RG6/U QUAD SHLD CL2P/CMP | | |
| C3521 | 18/1 RG6/U FL+95%TC/BRD SHLD HD/ETL/CMP | | |
| C3528 | 14/1 RG11/U FL+60%AL/BRD SHLD CL2P | | |
| C3529 | 14/1 RG11/U QUAD SHLD CL2P | | |
| C8029 | 18+1PR18 RG6/U CCTV/CM/CL2 | | • CCTV • RF/Broadcast • HDTV |
| C8028 | 20+1PR18 RG59/U CCTV/CM/CL2 | | |
| C1142 | 20/1 RG59/U 95%BC/BRD SHLD CL2/CM | | |
| C1166 | 20/1 RG58/U 95%TC/BRD SHLD JAN-C-17A | | |
| C8030 | 20+1PR18 RG59/U CCTV PLENUM | • CCTV • HDTV | |
| 495025 | 18/1 RG6/U FL+95%TC/BRD SHLD HD/SDI/CMP | | |
| 495028 | 20/1 RG59/U 95%BC/BRD SHLD CMP | | |
| 495027 | 14/1 RG11/U FL+95%TC/BRD SHLD PVDF CMP | | |
| 495015 | 14/1 RG11/U 95%BC/BRD SHLD PVDF CMP | | |

Access Control:

When your job requires Access Control cable, think of Carol® Brand cables first. We manufacture over 1,000 standard electronic cables that we can ship direct from stock, and we have the technical staff and design expertise to meet any customer cable requirement. The cables are installer friendly, as they save time and money on installation. With multiple cables under one jacket, time is saved in preparation and setup, pulling and termination.



| PART NUMBER | PRODUCT DESCRIPTION | APPLICATIONS |
|-------------|--|--|
| 4EPL1S | 4 Elements 1 Shielded Overall Jacket Access Control Plenum | • Card Readers • Door Contacts • Lock Power • Retinal Scanner in Commercial Buildings |
| 4EPL4S | 4 Shielded Elements Overall Jacket Access Control Plenum | |
| 4ERS1S | 4 Elements 1 Shielded Overall Jacket Access Control Riser | |
| 4ERS4S | 4 Shielded Elements Overall Jacket Access Control Riser | |

JACKET COLOR CODING & COMPONENT APPLICATION

| JACKET COLOR | COMPONENT | CABLE TYPE | APPLICATION |
|--------------|-----------|---------------------|--------------|
| Gray | 1 | 4 Conductor, 18 AWG | Lock Power |
| Orange | 2 | 3 Pair, 22 AWG | Card Reader |
| White | 3 | 2 Conductor, 22 AWG | Door Contact |
| Blue | 4 | 4 Conductor, 22 AWG | Rex/Spare |

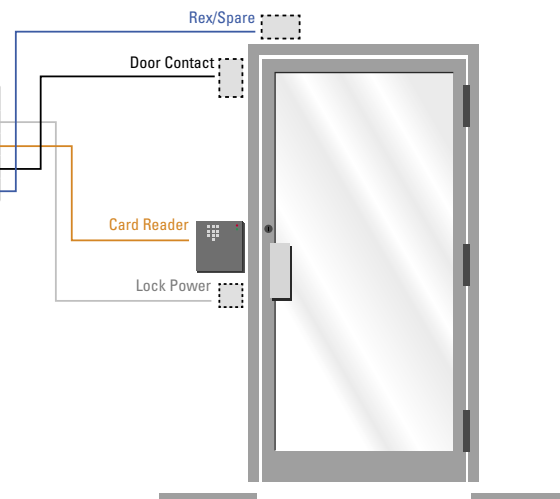

NOTE: Other gauges, colors and packaging are available. Contact your General Cable representative for additional ordering options.

Low Skew 4 Pair® UTP Cables:

General Cable's Carol® Brand Low Skew UTP Cables are manufactured for your RGB video and Digital CCTV camera needs. While the basic elements of the Low Skew Cables construction are similar to a UTP Cable (Category cable) used for data transmission, the design of the pair twists is the secret to delivering information in a manner necessary for streaming high-quality video.

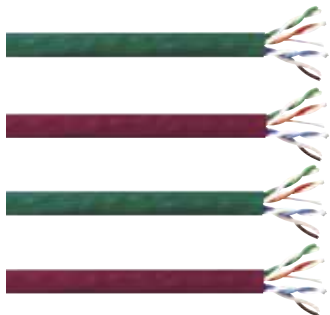

| PART NUMBER | PRODUCT DESCRIPTION | APPLICATIONS |
|---------------|---------------------------|---|
| E3842S CMP | 24 AWG 4 Pair UTP, Plenum | <ul style="list-style-type: none"> • Suitable for RGB Video Applications • Digital CCTV Cameras |
| E1842S CMR | 24 AWG 4 Pair UTP, Riser | |
| E3843S CMP | 23 AWG 4 Pair UTP, Plenum | |
| E1843S CMR | 23 AWG 4 Pair UTP, Riser | |

COMMODORE® (Armored):

For cable upgrades or installations, the offshore industry is focusing on network performance and increased bandwidth potential that will last for years. COMMODORE Coaxial communication and video monitoring LSZH constructions are used in control and coaxial communication applications where performance is critical.



| PART NUMBER | PRODUCT DESCRIPTION | APPLICATIONS |
|--------------|--------------------------------------|---|
| EO24P0022188 | 24/2P RS485 COMMODORE ABS SHPBRD | <ul style="list-style-type: none"> • Oil, Gas and Petrochemical Applications • Deeper Drilling for Natural Gas and Resources in Extremes • Offshore Rigs • Production Platforms • FPSOs and Ships • Stabilization and Directional Drilling • Shipboard Applications Only |
| EO24P0022186 | 24/2P RS422 COMMODORE ABS SHPBRD | |
| EO24P0042186 | 24/4P RS422 COMMODORE ABS SHPBRD | |
| EO24P0082186 | 24/8P RS422 COMMODORE ABS SHPBRD | |
| Z016P0022189 | 16/2P COMMODORE DEVICENET ABS SHPBRD | |
| CO18C0012170 | 18/1P RG6/U COMMODORE ABS SHPBRD | |
| CO14C0012170 | 14/1P RG11/U COMMODORE ABS SHPBRD | |
| CO21C0012170 | 21/1P RG58/U COMMODORE ABS SHPBRD | |
| CO20C0012170 | 20/1P RG59/U COMMODORE ABS SHPBRD | |
| CO13C0012170 | 13/1P RG213/U COMMODORE ABS SHPBRD | |
| EO18P0015337 | 18/1P COMMODORE FIELDBUS ABS SHPBRD | |
| EO18P0025337 | 18/2P COMMODORE FIELDBUS ABS SHPBRD | |
| EO18P0055337 | 18/5P COMMODORE FIELDBUS ABS SHPBRD | |
| EO22P0011203 | 22/1P COMMODORE PROFIBUS ABS SHPBRD | |

This cross-reference guide should be used in conjunction with the product information contained in our catalog or Website. It should be used for suggested alternative items, which are functionally equal. Constructional differences are not indicated. General Cable is not responsible for variances due to competitor and industry constructional changes or agency updates.

4 Tesseneer Drive, Highland Heights, Kentucky 41076-9753

GENERAL CABLE, CAROL BRAND, COMMODORE and EXZEL are trademarks of General Cable Technologies Corporation.

©2014. General Cable Technologies Corporation. Highland Heights, KY 41076
All rights reserved.

Printed in USA

Telephone: 888.295.5896
859.572.8000

Fax: 800.547.8249

E-mail: info@generalcable.com

www.generalcable.com

Form No. CAR-0150-R0614

45913