

# Rail-Mounted Terminal Block Systems

Full Line Catalog, Volume 1 – Edition 2017/2018

1

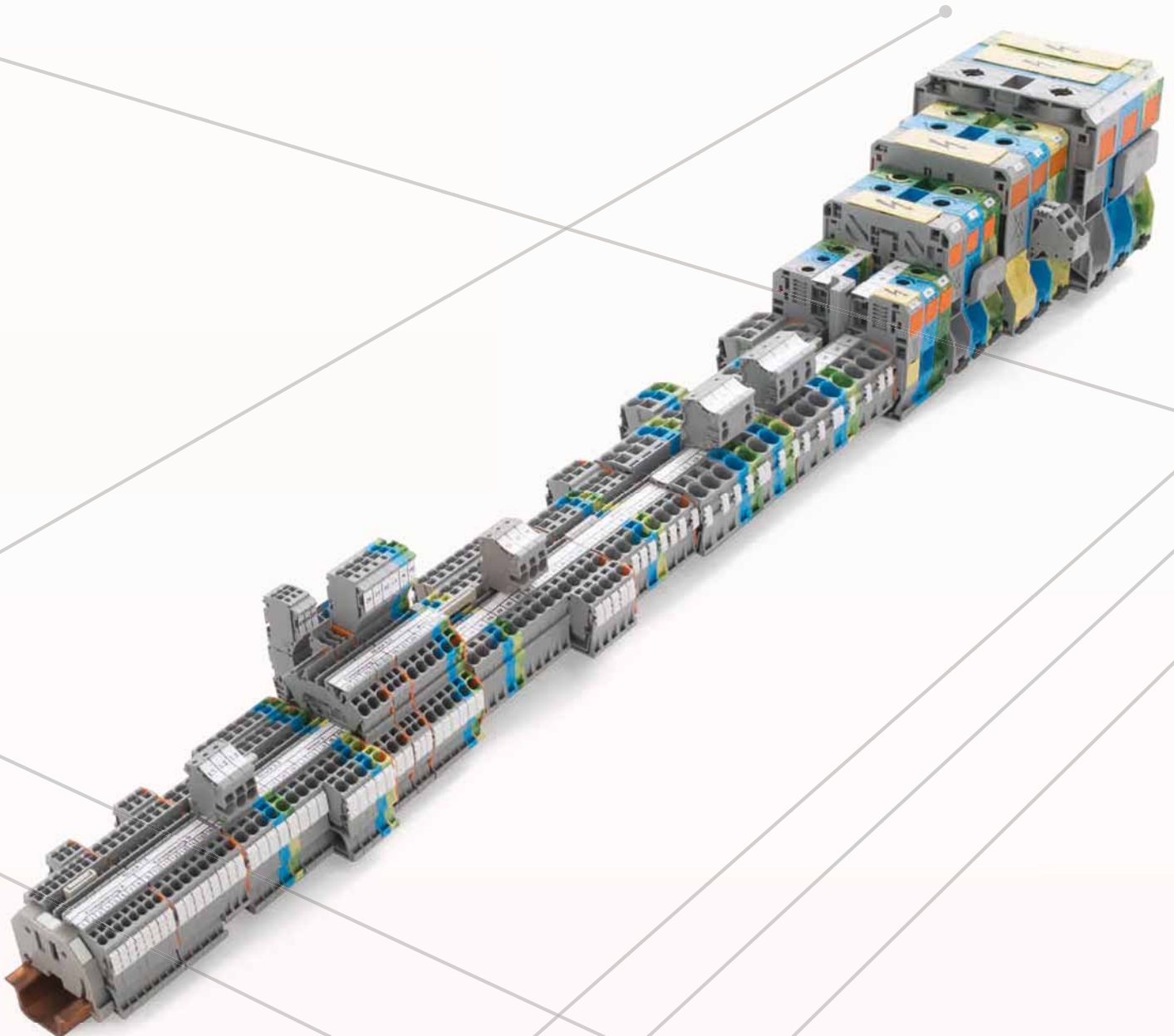

# WAGO Full Line Catalogs



## Volume 1, Rail-Mounted Terminal Block Systems

- Rail-Mounted Terminal Blocks
- Rail-Mounted Terminal Blocks with Pluggable Connector (X-COM®-SYSTEM)
- Patchboard Systems
- Terminal Strips
- PUSH WIRE® Connectors for Junction Boxes
- Lighting Connectors
- Shield Connecting System



## Volume 2, PCB Terminal Blocks and Connectors

- PCB Terminal Blocks
- SMD PCB Terminal Blocks
- *MULTI CONNECTION SYSTEM (MCS)*
- Pluggable PCB Terminal Blocks
- Feedthrough Terminal Blocks
- Specialty Connectors
- Empty Housings



## Volume 3, Automation Technology

- Software
- Operating & Monitoring
- Controllers
- Modular I/O-SYSTEM, IP20/IP67
- Industrial Switches
- Radio Technology, *TO-PASS®* Telecontrol Technology
- IP67 Sensor/Actuator Boxes, IP67 Cables and Connectors



## Volume 4, Interface Electronic

- Relay and Optocoupler Modules
- *JUMPFLEX®* Signal Conditioners and Isolation Amplifiers
- Current and Energy Measurement Technology
- *EPSITRON®* Power Supply System
- Interface Modules and System Wiring
- Overvoltage Protection
- Empty Housings



## Volume 5, *WINSTA®* – The Pluggable Connection System

- Pluggable Connectors
- Snap-In Device Connectors
- Pluggable PCB Connectors
- Distribution Connectors
- Cable Assemblies
- Flat Cable Systems
- Distribution Boxes



## Volume 6, Marking

- Terminal Block Marking
- Cable and Conductor Marking
- Device Marking
- Printer
- Software
- Marker Carriers

## Volume 1, Rail-Mount Terminal Block Systems

			Page	
	<b>Rail-Mount Terminal Blocks, TOPJOB® S</b> Front-entry wiring	Push-in CAGE CLAMP® 1 ... 16 (25 "f-st") mm <sup>2</sup> (16 ... 4 AWG) for DIN-35 rail	21	<b>1</b>
	<b>Rail-Mount Terminal Blocks with a Pluggable Connector, X-COM®S-SYSTEM</b> Front-entry wiring	Push-in CAGE CLAMP® 1 ... 2.5 (4) mm <sup>2</sup> (16 ... 12 AWG) for DIN-35 rail	177	<b>2</b>
	<b>Installation Rail-Mount Terminal Blocks, TOPJOB® S</b> Front-entry wiring	Push-in CAGE CLAMP® 1 ... 4 (6) mm <sup>2</sup> (16 ... 10 AWG) for DIN-35 rail	229	<b>3</b>
	<b>High-current, Rail-Mount Terminal Blocks High-Current Connectors</b> Side-entry wiring	POWER CAGE CLAMP 35 ... 185 mm <sup>2</sup> (2 AWG ... 350 kcmil), 1500 V nominal voltage, for DIN-35 rail	255	<b>4</b>
	<b>Rail-Mount Terminal Blocks, Classic Installation Rail-Mount Terminal Blocks, TOPJOB® Classic</b> Front-entry wiring	CAGE CLAMP® 1.5 ... 35 mm <sup>2</sup> (16 ... 2 AWG) for DIN-35 rail	279	<b>5</b>
	<b>Rail-Mount Terminal Blocks with a Pluggable Connector, X-COM®-SYSTEM, Classic</b> Front-entry wiring	CAGE CLAMP® 2.5 (4) mm <sup>2</sup> (12 AWG) for DIN-35 rail	465	<b>6</b>
	<b>Rail-Mount Terminal Blocks, Miniature Rail-Mount Terminal Blocks, Compact</b> Front-entry wiring	CAGE CLAMP® 2.5 mm <sup>2</sup> (4 mm <sup>2</sup> ) (12 AWG) for DIN-35 and DIN-15 rails	539	<b>7</b>
	<b>Modular Terminal Blocks and Terminal Strips</b> Side-/front-entry wiring	CAGE CLAMP® 1.5 ... 4 mm <sup>2</sup> (16 ... 12 AWG) for panel mounting	579	<b>8</b>
	<b>Field-Wiring Terminal Blocks and Chassis-Mount Terminal Strips</b> Side-entry wiring	Push-in CAGE CLAMP® 2.5 mm <sup>2</sup> (22 AWG), 4 mm <sup>2</sup> (12 AWG) for panel mounting	627	<b>9</b>
	<b>Rail-Mount Terminal Blocks, Classic</b> Side-entry wiring	CAGE CLAMP® 1.5 ... 16 mm <sup>2</sup> (16 ... 6 AWG) for DIN-35 rail	651	<b>10</b>
	<b>Terminal Blocks for Matrix Patching and Potential Distribution, Busbar Terminal Blocks</b>	CAGE CLAMP® 1.5 ... 16 mm <sup>2</sup> (16 ... 6 AWG)	681	<b>11</b>
	<b>Lighting Connectors, PUSH WIRE® Connectors for Junction Boxes, Splicing Connectors for All Conductor Types</b>		717	<b>12</b>
	<b>Accessories and Tools</b>		763	<b>13</b>
	<b>Technical Section</b>		807	<b>14</b>
	<b>Index and Addresses</b>		855	<b>15</b>

## Operating WAGO Connection Technologies

Please follow the applicable product-specific termination instructions.

### PUSH-IN CAGE CLAMP®



Push-in CAGE CLAMP® terminates the following copper conductors: solid



stranded



fine-stranded, also with tinned single strands



fine-stranded, tip-bonded



fine-stranded, with ferrule (gastight crimped)



fine-stranded, with pin terminal (gastight crimped)

The universal connection with an additional advantage:

Push-in connection

Terminate solid and stranded (Class B 7 strands or less), as well as ferruled conductors, by simply pushing them in – no tools required.

Termination for all conductor types:

- Open clamping unit.
- Insert the conductor.
- Release clamp – done!

### CAGE CLAMP®

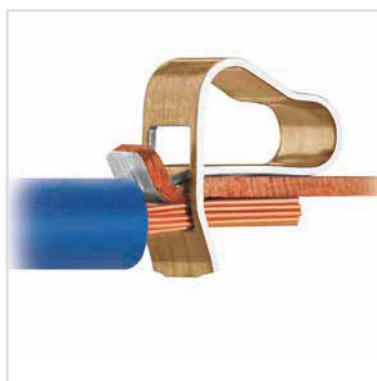

CAGE CLAMP® terminates the following copper conductors: solid



stranded



fine-stranded, also with tinned single strands



fine-stranded, tip-bonded



fine-stranded, with ferrule (gastight crimped)



fine-stranded, with pin terminal (gastight crimped)

The universal connection for solid, stranded and fine-stranded conductors

Termination:

- Open clamping unit.
- Insert the conductor.
- Release clamp – done!



## Operating WAGO Connection Technologies

Please follow the applicable product-specific termination instructions.

### POWER CAGE CLAMP®



POWER CAGE CLAMP terminates the following copper conductors:  
solid



stranded



fine-stranded,  
also with tinned  
single strands



fine-stranded,  
with ferrule  
(gastight crimped)

The universal connection for conductors larger than 35 mm<sup>2</sup> (2 AWG)

Termination:

- Open clamp by turning a T-wrench counter-clockwise.
- Press the integrated latch to open clamping unit for hands-free wiring.
- Insert the conductor.
- A small counter-clockwise rotation closes the clamp, securing conductor.

### PUSH WIRE®



PUSH WIRE® terminates the following copper conductors:  
solid

PUSH WIRE® connection for solid and stranded conductors (depending on the model used)

Termination:

Tool-free, twist-free terminations for solid and rigid stranded conductors – simply push into the unit.

## Product Overview

### TOPJOB® S

Rail-Mount Terminal Blocks with Push-in CAGE CLAMP® Connection

#### Through terminal blocks



Page 34

#### Ground conductor terminal blocks



Page 36

#### Shield terminal blocks



Page 40

### TOPJOB® S

Rail-Mount Terminal Blocks with Push-in CAGE CLAMP® Connection

#### Double-potential terminal blocks

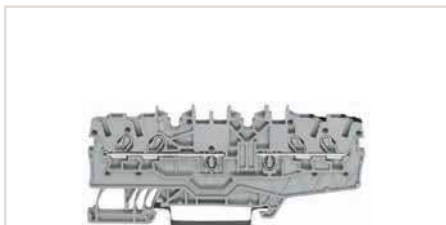

Page 35

#### Double-deck terminal blocks



Page 58

#### Double-deck disconnect terminal blocks



Page 72

### TOPJOB® S

Rail-Mount Terminal Blocks with Push-in CAGE CLAMP® Connection

#### Double-deck carrier terminal blocks

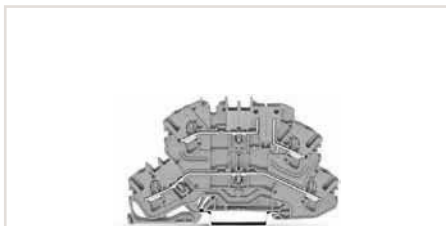

Page 73

#### Double-deck fuse terminal blocks

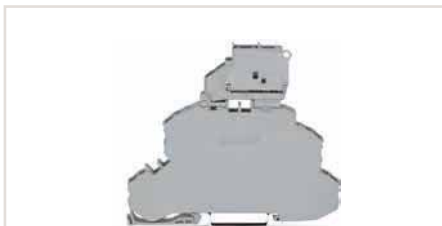

Page 75

#### Triple-deck terminal blocks



Page 76

### TOPJOB® S

Rail-Mount Terminal Blocks with Push-in CAGE CLAMP® Connection

#### Quadruple-deck, rail-mount terminal blocks for electric motor wiring



Page 78

#### Disconnect/test terminal blocks



Page 82

#### Disconnect/test terminal blocks for current and voltage transformer circuits



Page 114

# Product Overview

## TOPJOB® S Rail-Mount Terminal Blocks with Push-in CAGE CLAMP® Connection

Fuse terminal blocks



Page 88

Fuse disconnect terminal blocks with a pivoting fuse holder

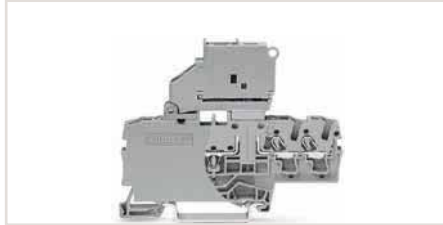

Page 90

Fuse plugs and carrier terminal blocks



Page 121

## TOPJOB® S Rail-Mount Terminal Blocks with Push-in CAGE CLAMP® Connection

Sensor terminal blocks

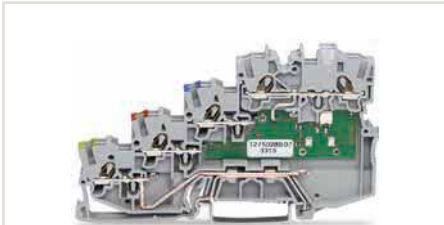

Page 126

Actuator terminal blocks



Page 130

Sensor and actuator supply terminal blocks



Page 127

## TOPJOB® S Rail-Mount Terminal Blocks with Push-in CAGE CLAMP® Connection

Diode terminal blocks



Page 132

LED terminal blocks



Page 134

Multilevel diode and LED terminal blocks



Page 142

## TOPJOB® S Rail-Mount Terminal Blocks with Push-in CAGE CLAMP® Connection

Empty component plug housings



Page 149

Diode modules



Page 148

LED modules



Page 150

## Product Overview

### X-COM®S-SYSTEM-MINI Rail-Mount Terminal Blocks with a Pluggable Connector

#### Carrier terminal blocks



 Page 180

#### Ground carrier terminal blocks



 Page 182

#### Double-deck carrier terminal blocks



 Page 184

### X-COM®S-SYSTEM-MINI Rail-Mount Terminal Blocks with a Pluggable Connector

#### 1-conductor female plugs

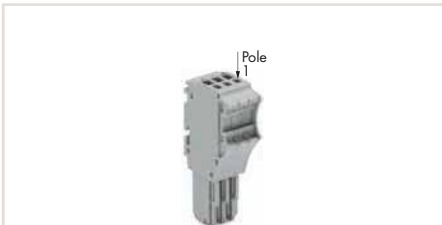

 Page 189

#### 2-conductor female plugs

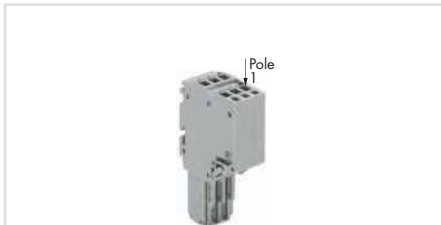

 Page 189

#### Pre-assembled female plugs

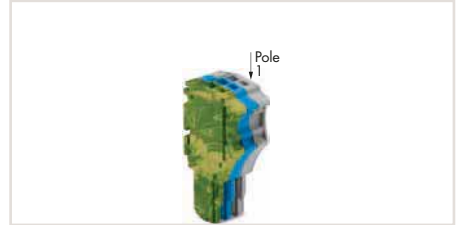

 Page 190

### X-COM®S-SYSTEM-MINI Rail-Mount Terminal Blocks with a Pluggable Connector

#### Female plugs for self-assembly



 Page 192

#### Female plugs with locking levers and strain relief plates

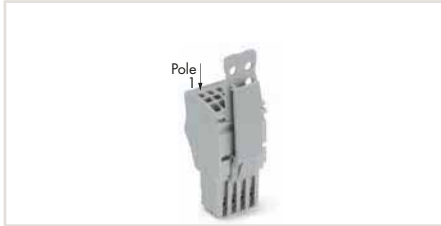

 Page 194

### X-COM®S-SYSTEM Rail-Mount Terminal Blocks with a Pluggable Connector

#### Carrier terminal blocks



 Page 198

#### Ground carrier terminal blocks



 Page 200

#### Double-deck carrier terminal blocks

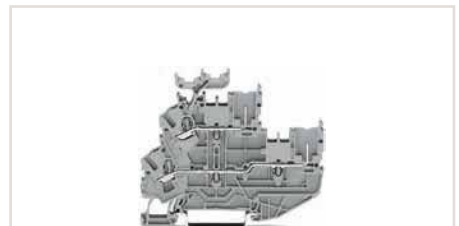

 Page 202

# Product Overview

## X-COM®S-SYSTEM Rail-Mount Terminal Blocks with a Pluggable Connector

Female plugs



Page 207

Pre-assembled female plugs

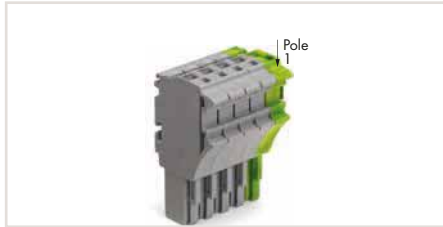

Page 208

Female plugs for self-assembly



Page 210

## X-COM®S-SYSTEM Rail-Mount Terminal Blocks with a Pluggable Connector

Female plugs with locking levers and strain relief plates



Page 212

## X-COM®S-SYSTEM Rail-Mount Terminal Blocks with a Pluggable Connector for Ex Applications

Carrier terminal blocks for Ex nA applications

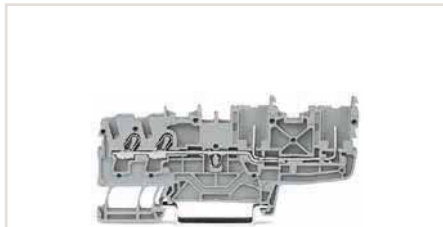

Page 214

Ground carrier terminal blocks for Ex nA applications



Page 216

## X-COM®S-SYSTEM Rail-Mount Terminal Blocks with a Pluggable Connector for Ex Applications

Double-deck carrier terminal blocks for Ex nA applications

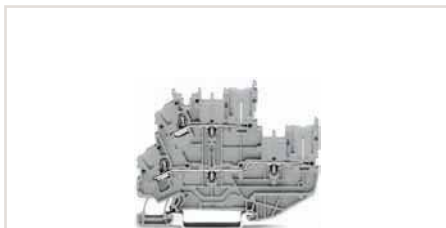

Page 218

Female plugs for Ex nA applications



Page 221

Pre-assembled female plugs for Ex nA applications

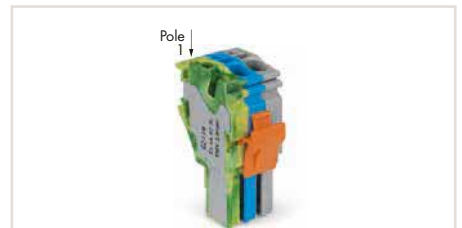

Page 221

## Product Overview

### TOPJOB® S

#### Installation Rail-Mount Terminal Blocks with Push-in CAGE CLAMP® Connection

Multilevel installation terminal blocks with an N-disconnect slide link, 2.5 (4) mm<sup>2</sup> (12 AWG)



 Page 234

Multilevel installation terminal blocks with an internal N-disconnection



 Page 236

Double-fuse plugs



 Page 239

### TOPJOB® S

#### Installation Rail-Mount Terminal Blocks with Push-in CAGE CLAMP® Connection

Multilevel installation terminal blocks with an N-disconnect slide link, 4 (6) mm<sup>2</sup> (10 AWG)



 Page 240

N-conductor disconnect terminal blocks and power distribution disconnect terminal blocks



 Page 242

Distribution supply terminal blocks



 Page 244

### High-Current, Rail-Mount Terminal Blocks

Through terminal blocks, 35 mm<sup>2</sup> (2 AWG)



 Page 258

Ground conductor terminal blocks, 35 mm<sup>2</sup> (2 AWG)



 Page 259

Power taps for 35 mm<sup>2</sup> (2 AWG) terminal blocks



 Page 259

### High-Current, Rail-Mount Terminal Blocks

Through terminal blocks, 50 mm<sup>2</sup> (1/0 AWG)



 Page 262

Ground conductor terminal blocks, 50 mm<sup>2</sup> (1/0 AWG)



 Page 263

Power taps for 50 mm<sup>2</sup> (1/0 AWG) terminal blocks



 Page 263



# Product Overview

## High-Current, Rail-Mount Terminal Blocks

Through terminal blocks, 95 mm<sup>2</sup> (4/0 AWG)



Page 264

Ground conductor terminal blocks, 95 mm<sup>2</sup> (4/0 AWG)



Page 265

Power taps for 95 mm<sup>2</sup> (4/0 AWG) terminal blocks



Page 265

## High-Current, Rail-Mount Terminal Blocks

Through terminal blocks, 185 mm<sup>2</sup> (350 kcmil)



Page 266

Ground conductor terminal blocks, 185 mm<sup>2</sup> (350 kcmil)



Page 267

Power taps for 185 mm<sup>2</sup> (350 kcmil) terminal blocks



Page 267

## High-Current, Rail-Mount Terminal Blocks

Through terminal blocks with screw flanges, 185 mm<sup>2</sup> (350 kcmil)



Page 268

Through terminal blocks with screw flanges, 185 mm<sup>2</sup> (350 kcmil)



Page 269

## Product Overview

### Rail-Mount Terminal Blocks with CAGE CLAMP® Connection, Front-Entry Wiring

Through terminal blocks

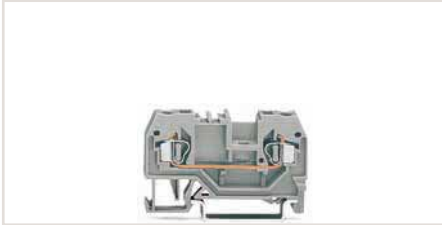

 Page 286

Ground conductor terminal blocks



 Page 286

Shield terminal blocks



 Page 287

### Rail-Mount Terminal Blocks with CAGE CLAMP® Connection, Front-Entry Wiring

Double-potential terminal blocks



 Page 287

Distribution terminal blocks



 Page 311

Double-deck terminal blocks



 Page 314

### Rail-Mount Terminal Blocks with CAGE CLAMP® Connection, Front-Entry Wiring

Triple-deck terminal blocks

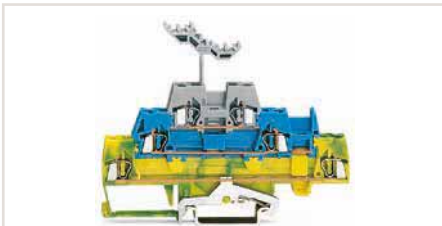

 Page 326

Quadruple-deck, rail-mount terminal blocks for electric motor wiring



 Page 328

Disconnect/test terminal blocks



 Page 348

### Rail-Mount Terminal Blocks with CAGE CLAMP® Connection, Front-Entry Wiring

Disconnect/test terminal blocks



 Page 346

Disconnect/test terminal blocks for current and voltage transformer circuits

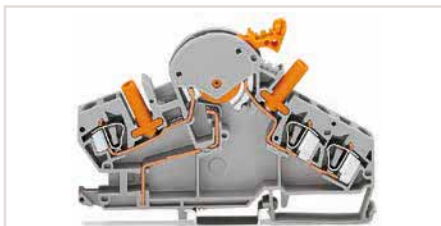

 Page 356

Ground conductor disconnect terminal blocks



 Page 367

# Product Overview

## Rail-Mount Terminal Blocks with CAGE CLAMP® Connection, Front-Entry Wiring

Fuse terminal blocks

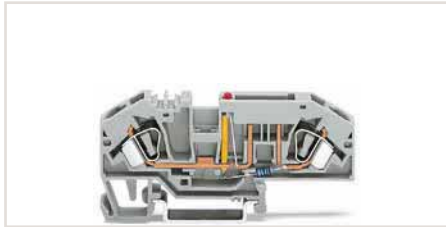

Page 372

Fuse disconnect terminal blocks with a pivoting fuse holder



Page 376

Fuse terminal blocks



Page 386

## Rail-Mount Terminal Blocks with CAGE CLAMP® Connection, Front-Entry Wiring

Fuse plugs and carrier terminal blocks



Page 380

Diode terminal blocks



Page 418

LED terminal blocks

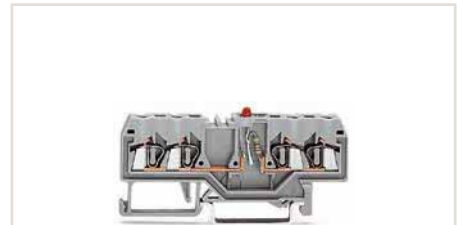

Page 420

## Rail-Mount Terminal Blocks with CAGE CLAMP® Connection, Front-Entry Wiring

Diode modules



Page 434

LED modules



Page 436

Sensor and actuator terminal blocks



Page 396

## TOPJOB® Classic Rail-Mount Terminal Blocks with CAGE CLAMP® Connection

Through terminal blocks



Page 332

Ground conductor terminal blocks



Page 333

N-conductor disconnect terminal blocks and power distribution disconnect terminal blocks



Page 340

## Product Overview

### X-COM®-SYSTEM, Classic Rail-Mount Terminal Blocks with a Pluggable Connector

#### Carrier terminal blocks



Page 470

#### Ground carrier terminal blocks

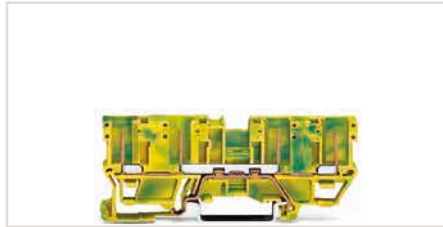

Page 470

#### Disconnect carrier terminal blocks

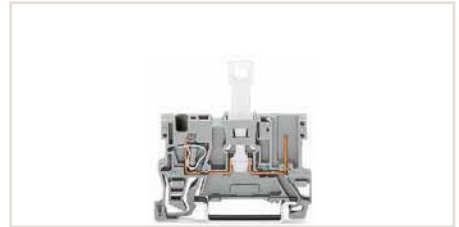

Page 482

### X-COM®-SYSTEM, Classic Rail-Mount Terminal Blocks with a Pluggable Connector

#### Diode carrier terminal blocks

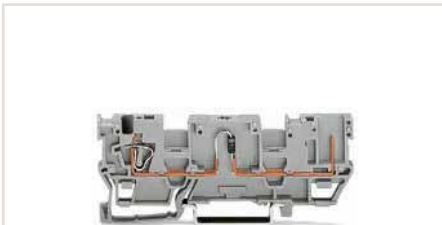

Page 484

#### LED carrier terminal blocks



Page 486

#### Carrier terminal blocks for pluggable modules

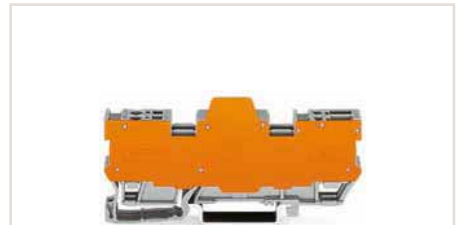

Page 492

### X-COM®-SYSTEM, Classic Rail-Mount Terminal Blocks with a Pluggable Connector

#### Double-deck carrier terminal blocks

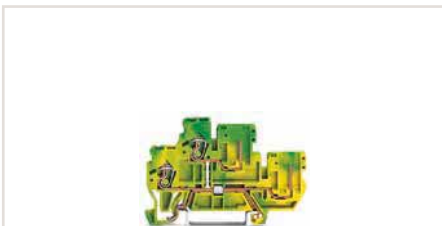

Page 498

#### Male connectors with CAGE CLAMP® connection



Page 508

#### Male headers with solder pins



Page 512

### X-COM®-SYSTEM, Classic Rail-Mount Terminal Blocks with a Pluggable Connector

#### Female plugs with and without lateral locking levers

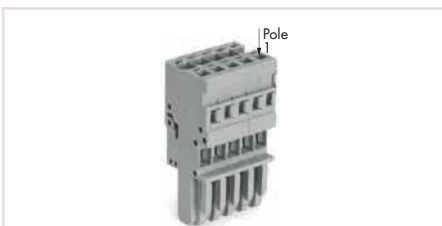

Page 518

#### Female plugs for self-assembly



Page 522

#### Pre-assembled female plugs

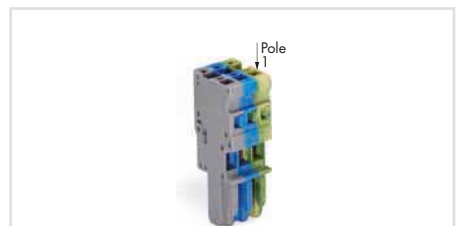

Page 519

# Product Overview

## Miniature Rail-Mount Terminal Blocks with CAGE CLAMP® Connection

Through terminal blocks for DIN-35 rail



Page 542

Ground conductor terminal blocks for DIN-35 rail



Page 543

Ex e II through terminal blocks for DIN-35 rail



Page 542

## Miniature Rail-Mount Terminal Blocks with CAGE CLAMP® Connection

Through terminal blocks for DIN-15 rail



Page 544

Ground conductor terminal blocks for DIN-15 rail



Page 545

Ex e II through terminal blocks for DIN-15 rail



Page 544

## Compact Rail-Mount Terminal Blocks with CAGE CLAMP COMPACT Connection

Through terminal blocks for DIN-35 rail



Page 550

Ground conductor terminal blocks for DIN-35 rail



Page 552

Ex e II through terminal blocks for DIN-35 rail



Page 550

## Compact Rail-Mount Terminal Blocks with CAGE CLAMP COMPACT Connection

Through terminal blocks for DIN-15 rail



Page 551

Ground conductor terminal blocks for DIN-15 rail

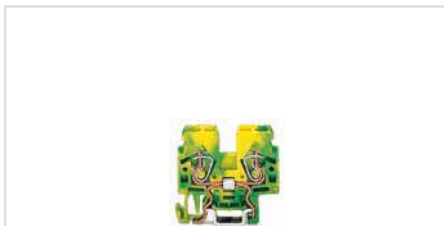

Page 553

Ex e II through terminal blocks for DIN-15 rail

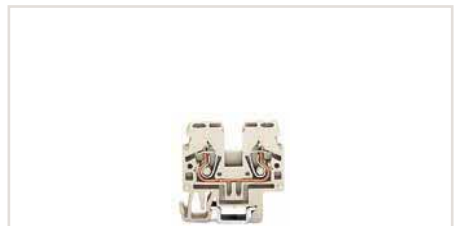

Page 551

## Product Overview

### Compact Rail-Mount Terminal Blocks with CAGE CLAMP COMPACT Connection

#### Double-potential terminal blocks



 Page 551

#### Double-deck terminal blocks



 Page 554

#### Triple-deck terminal blocks

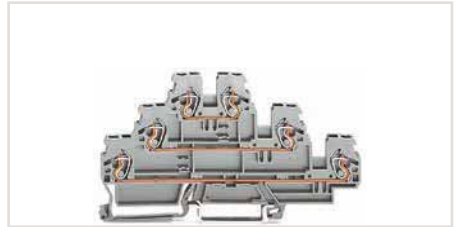

 Page 558

### Compact Rail-Mount Terminal Blocks with CAGE CLAMP COMPACT Connection

#### Sensor and actuator terminal blocks



 Page 572

#### Sensor and actuator supply terminal blocks



 Page 572

### Accessories (Selection)

#### Pluggable tap-off modules



 Page 567

### Modular Terminal Blocks and Terminal Strips

#### Modular terminal blocks

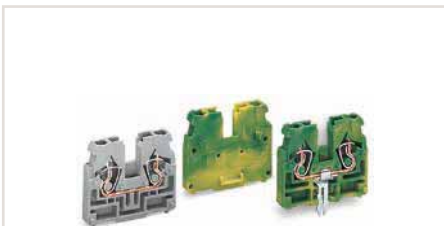

 Page 582

#### Terminal strips with mounting flanges



 Page 585

#### Terminal strips with snap-in mounting feet



 Page 585

### Modular Terminal Blocks and Terminal Strips

#### Modular terminal blocks



 Page 590

#### Terminal strips with mounting flanges



 Page 592

#### Terminal strips with snap-in mounting feet



 Page 593



# Product Overview

## Modular Terminal Blocks and Terminal Strips

Modular terminal blocks



Page 602

Terminal strips with mounting flanges



Page 604

Terminal strips with snap-in mounting feet



Page 604

## Chassis-Mount Terminal Strips and Field-Wiring Terminal Blocks

4-conductor, chassis-mount terminal strips



Page 631

Field-wiring terminal blocks



Page 639

Field-wiring terminal blocks for fluorescent lighting fixtures



Page 648

## Rail-Mount Terminal Blocks with CAGE CLAMP® Connection, Side-Entry Wiring

Through terminal blocks



Page 654

Ground conductor terminal blocks



Page 655

Disconnect/test terminal blocks

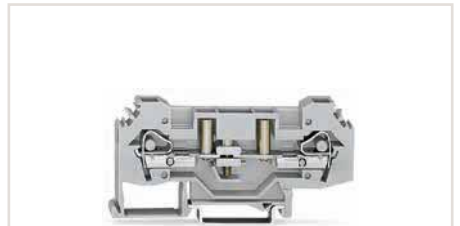

Page 662

## Rail-Mount Terminal Blocks with CAGE CLAMP® Connection, Side-Entry Wiring

Ground conductor disconnect terminal blocks

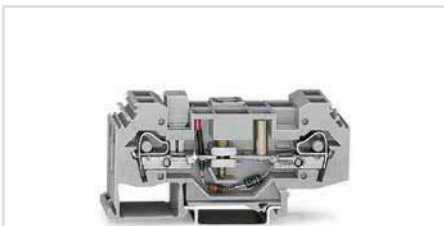

Page 665

Fuse terminal blocks



Page 666

# Product Overview

## Patchboard Systems

### Matrix patchboards



Page 684

### Common potential matrix patchboards



Page 688

### Additional modules



Page 696

## Patchboard Systems

### Terminal blocks for matrix patching



Page 700

### Common potential terminal blocks



Page 701

### 3-conductor, double-potential terminal blocks or terminal blocks for matrix patching



Page 707

## Busbar Terminal Blocks

### Busbar terminal blocks



Page 712

### Ground busbar terminal blocks



Page 713

### Insulated busbar carriers



Page 714

## PUSH WIRE® Connectors for Junction Boxes

### COMPACT PUSH WIRE® connectors for junction boxes



Page 720

### COMPACT PUSH WIRE® connectors for junction boxes



Page 722

### Mounting carriers



Page 723

# Product Overview

## PUSH WIRE® Connectors for Junction Boxes

CLASSIC PUSH WIRE® connectors for junction boxes



Page 726

CLASSIC PUSH WIRE® connectors for junction boxes



Page 728

Mounting carriers



Page 727

## PUSH WIRE® Connectors for Junction Boxes

PUSH WIRE® connectors for junction boxes



Page 732

Ex PUSH WIRE® connectors for junction boxes



Page 737

Mounting carriers



Page 733

## PUSH WIRE® Connectors for Junction Boxes

MICRO PUSH WIRE® connectors for junction boxes



Page 742

MICRO PUSH WIRE® connectors for junction boxes



Page 743

Mounting carriers



Page 745

## Splicing Connectors for All Conductor Types

COMPACT splicing connectors for all conductor types



Page 749

COMPACT splicing connectors for all conductor types



Page 749

Mounting carriers



Page 754

## Product Overview

### Splicing Connectors for All Conductor Types

CLASSIC splicing connectors for all conductor types



Page 753

CLASSIC splicing connectors for all conductor types



Page 753

Mounting carriers



Page 754

### Lighting Connectors

Lighting connectors



Page 758

Lighting connectors



Page 759

Luminaire disconnect connectors



Page 760

### Shield Connecting System

Shield clamping saddles



Page 769

Shield clamping saddles



Page 767

Busbar carriers



Page 774

### Marking Accessories

Marking cards

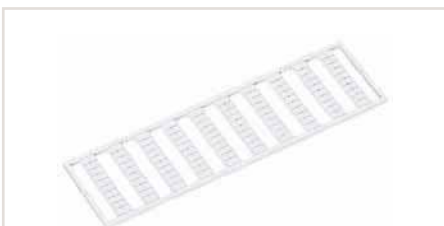

Page 780  
see Full Line Catalog, Volume 6

Marker carriers



see Full Line Catalog, Volume 6

Marking cards



see Full Line Catalog, Volume 6

# Product Overview

## Mounting Accessories

### Screwless end stops



Page 785

### Carrier rails



Page 786

### Collective jumper carriers



Page 790

## Mounting Accessories

### Covers



Page 789

## Tools

### Operating tools



Page 792

### Cable strippers



Page 795

### Stripping tools



Page 796

## Tools

### Crimping tools



Page 797

### Ferrules



Page 798

### Measurement devices



Page 802

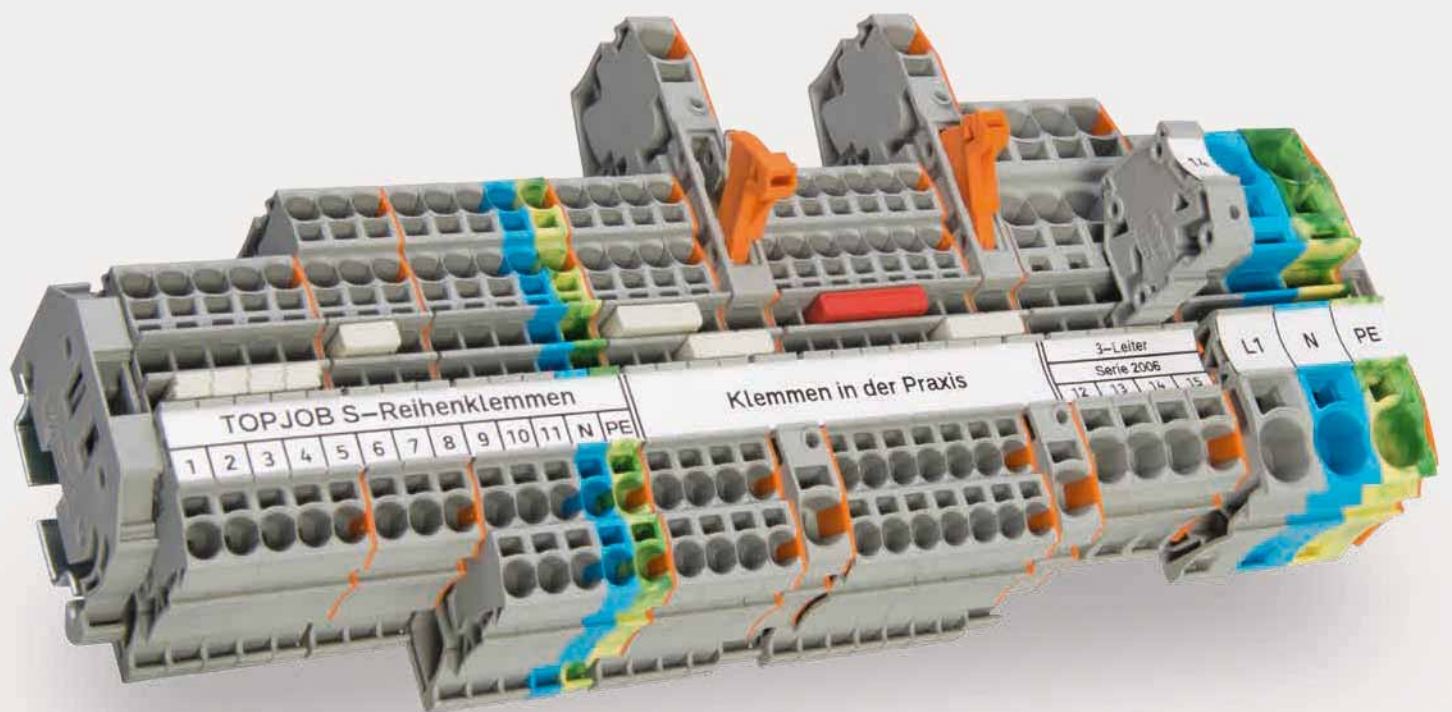

Rail-Mount Terminal Blocks, TOPJOB® S



## Rail-Mount Terminal Blocks, TOPJOB® S with Push-in CAGE CLAMP® Connection Front-Entry Wiring

			Page
	<b>Through, Ground Conductor, Shield and Ex Terminal Blocks</b> 0.14 ... 16 (25 "f-st") mm <sup>2</sup> (24 ... 4 AWG)	2000 ... 2016 Series	34
	<b>Multilevel Rail-Mount Terminal Blocks</b> 1 (1.5) mm <sup>2</sup> (16 AWG) and 2.5 (4) mm <sup>2</sup> (10 AWG)	2000/2002 Series	58
	<b>Disconnect/Test/Fuse Terminal Blocks and Through Terminal Blocks of Same Profile</b> 0.25 ... 2.5 (4) mm <sup>2</sup> (24 ... 4 AWG)	2002 Series	80
	<b>Fuse Disconnect Terminal Blocks with a Pivoting Fuse Holder</b> 0.25 ... 2.5 (4) mm <sup>2</sup> (24 ... 4 AWG)	2002 Series	90
	<b>Disconnect, Ground Conductor Disconnect Terminal Blocks and Fuse Terminal Blocks</b> 0.5 ... 6 (10) mm <sup>2</sup> (20 ... 8 AWG)	2006 Series	98
	<b>Disconnect/Test Terminal Blocks for Current and Voltage Transformer Circuits</b> 0.5 ... 6 (10) mm <sup>2</sup> (20 ... 8 AWG)	2007 Series	114
	<b>Fuse Plugs on Carrier Terminal Blocks</b>	2004/2006 Series	121
	<b>Sensor and Actuator Terminal Blocks</b> 0.14 ... 1 (1.5) mm <sup>2</sup> (24 ... 16 AWG)	2000 Series	126
	<b>Diode and LED Terminal Blocks</b> 0.25 ... 4 (6) mm <sup>2</sup> (22 ... 10 AWG)	2001/2002/2004 Series	132
	<b>Multilevel Diode and LED Terminal Blocks</b> 0.25 ... 2.5 (4) mm <sup>2</sup> (24 ... 4 AWG)	2002 Series	142
	<b>Diode, LED Modules and Empty Component Plug Housings</b>	2002 Series	148
	<b>Accessories for TOPJOB® S Rail-Mount Terminal Blocks</b>		156

## TOPJOB® S

### Conductor Insertion/Removal Installation

1



**Inserting conductors via push-in termination.**  
Stripped solid, ferruled or ultrasonically "bonded" conductors can be simply pushed in – without tools. This advantage significantly reduces wiring costs for conductors rated 0.5 mm<sup>2</sup> (20 AWG) to 16 mm<sup>2</sup> (4 AWG) in applications such as electrical installations or factory wiring.

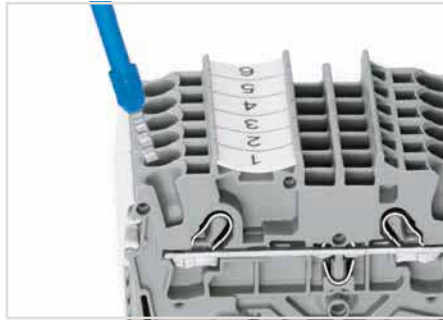

**Fine-stranded conductors with ferrules** from at least two sizes below the rated cross-section up to the rated cross-section can also be simply pushed in – without tools.



**Inserting conductors via push-in termination.**  
**Solid conductors** with cross-sections from either one size above, or up to two sizes below, the rated cross-section can be simply pushed in – no tools needed.



**Inserting a conductor via operating tool.**  
Connecting fine-stranded conductors without ferrules, or small cross-sectional conductors that cannot be pushed in, is performed similarly to the original CAGE CLAMP® – just use an operating tool.

**The smart feature:**

To open the clamp, the operating tool is inserted vertically. The conductor entry is less than 15 degrees for easier wiring.



**Removing a conductor.**  
Conductor removal is performed with an operating tool, just like CAGE CLAMP®.

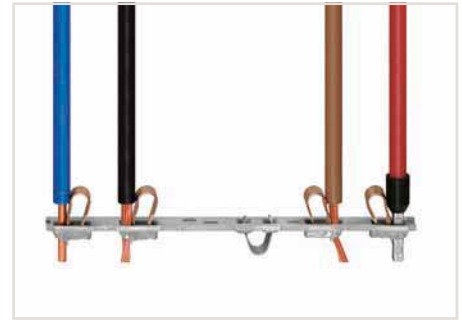



All conductor types at a glance

## TOPJOB® S

### Push-In Type Jumper Bars

#### Installation



**Push-in type jumper bars (2000 to 2016 Series)**  
800 V  
600 V   
550 V 

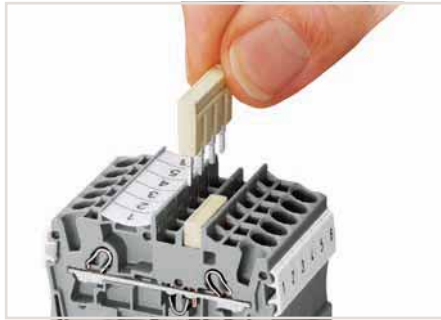

The push-in type jumper bar system is based on the common plug and socket principle. Each terminal block is spring-loaded with a double socket and a resilient CrNi steel spring. The jumper contact material is pure electrolytic copper, which allows for an extremely small design capable of carrying the full-rated current of the terminal block. Ground terminal blocks can also be commoned using the same jumper system. Custom jumpers are created by breaking and removing jumper contacts (2000, 2001, 2002, 2004 Series).

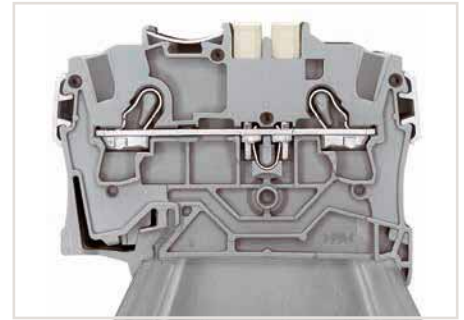

#### The smart feature:

The integrated sockets can be used for:

- Jumpers
- Test plug adapters and testing taps
- Preharnessed plugs for subassembly connections

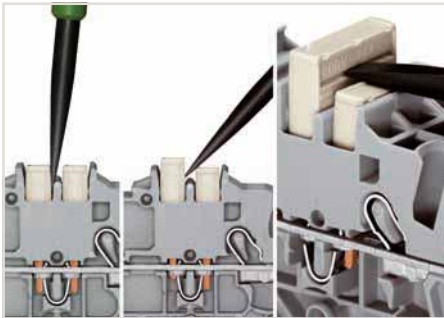

#### Removing a push-in type jumper bar.

Insert the operating tool between the jumper and and partition wall of the dual jumper slots, then lift up the jumper.

Place the operating tool in the center of jumpers up to five contacts (see above), or alternately on both sides for jumpers with more than five contacts.



Custom push-in type jumper bars are created by breaking off jumper contacts.

500 V  
300 V 

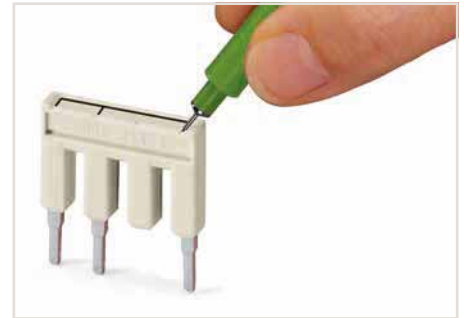

Marking a push-in type jumper bar using a felt-tip pen.



#### Stepping down via push-in type jumper bar.

Commoning via open terminal side with end plate allows jumpering over two cross-section sizes for 16 mm<sup>2</sup> (6 AWG) and 10 mm<sup>2</sup> (8 AWG) and one cross-section size for 6/4/2.5 mm<sup>2</sup> (10/12/14 AWG). An example: from 16 mm<sup>2</sup> (6 AWG) to 6 mm<sup>2</sup> (10 AWG) (see illustration above) or from 10 mm<sup>2</sup> (8 AWG) to 4 mm<sup>2</sup> (12 AWG).

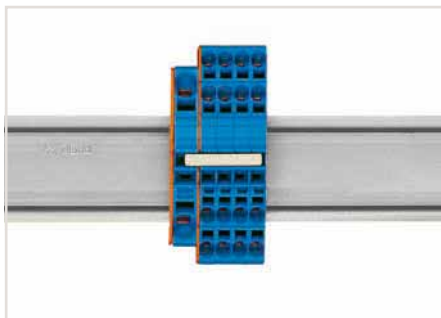

#### Stepping down via push-in type jumper bar.

Commoning via closed terminal side with end plate allows jumpering over two cross-section sizes, e.g., from 16 mm<sup>2</sup> (6 AWG) to 6 mm<sup>2</sup> (10 AWG) or from 6 mm<sup>2</sup> (10 AWG) to 2.5 mm<sup>2</sup> (14 AWG) (see illustration above).



An application example: colored push-in type jumper bars are used with sensor terminal blocks.

# TOPJOB® S

## Staggered Jumpers, 2002 Series

### Installation

1



Staggered Jumpers, 2002 Series

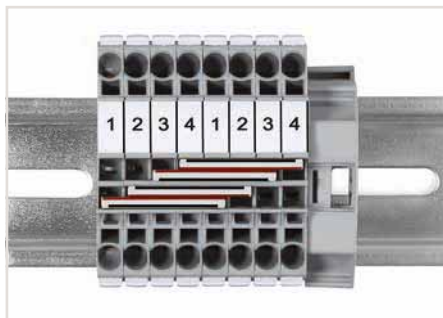

Commoning two potentials in one single jumper slot via extremely slim staggered jumpers.



Locate red stripes of the staggered jumpers on the inside. Insert staggered jumper and push down until it hits backstop.

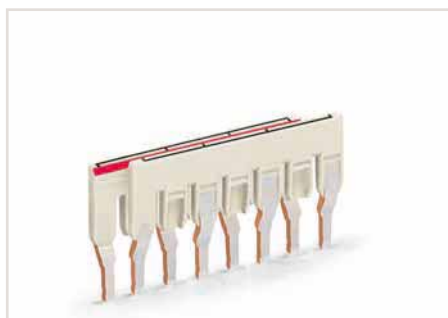

**Staggering jumpers in a single jumper slot.** When creating custom staggered jumpers (e.g., for bridging over a terminal block with a different potential), make sure that only one contact lug is in contact with the terminal block. The contact lugs of the customized staggered jumpers contact the terminal blocks via the gaps created in the second jumper. Insert and press the ready-made jumper assembly into the jumper slot until it hits backstop.



Staggered jumpers (seven contacts)

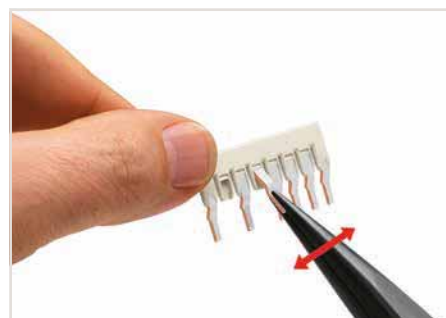

**Staggered jumper (seven contacts)** Individual jumper contacts can be broken off by bending them. The remaining piece of insulation will meet requirements for clearances and creepage distances.

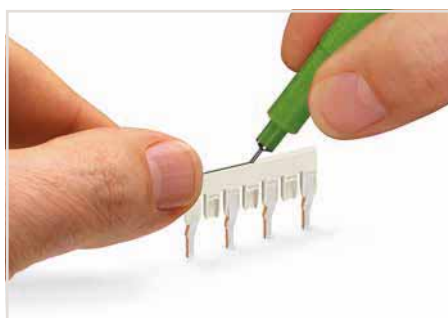

Marking a staggered jumper using a felt-tip pen.



Cutting off a staggered jumper using pliers.

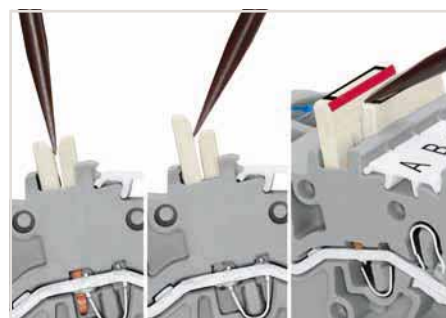

**Removing a staggered jumper:** Insert the operating tool between the staggered jumpers, then lift up the jumper.



# TOPJOB® S Jumper Systems Installation

1



Adjacent jumpers for continuous commoning, 2-way (2002-400)

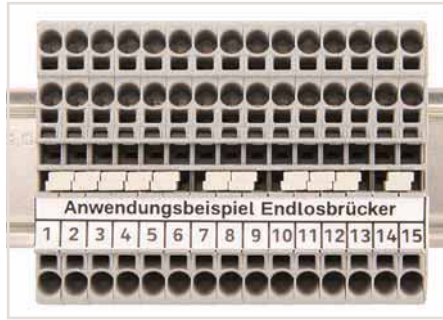

Continuous jumpers (2002 Series) readily connect an endless number of terminal blocks to each other via a single jumper slot. Use the second jumper slot for additional commoning or testing.



Adjacent jumpers for continuous commoning (2002-400)



Adjacent jumpers for continuous commoning, 1-to-3 (2002 Series)



The 1-to-3 adjacent jumper for continuous commoning enables every other terminal block to be commoned. For example, positive and negative potentials can be accommodated alongside each other.



By combining a 1-to-2 continuous jumper with a 1-to-3 adjacent jumper, various commoning applications can be performed in just one jumper slot.



Double-deck vertical jumper (2000-492 or 2002-492) and triple-deck vertical jumper (2002-493)



Created for double- and triple-deck TOPJOB® S Terminal Blocks, the vertical jumpers can common two or three levels. Clearly marked numerals ("2" and "3") distinguish the double-deck (2002-492) and triple-deck vertical jumpers (2002-493), even when inserted.

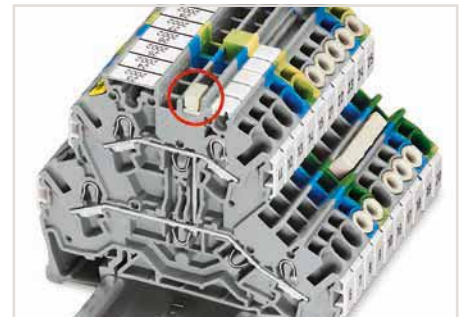

Commoning two levels via double-deck vertical jumper (2002-492).



Commoning three levels via triple-deck vertical jumper (2002-493).

# TOPJOB® S Jumper Systems Installation

1



Push-in type wire jumper, 0.75 mm<sup>2</sup> wire cross-section (suitable for 2000 and 2020 Series rail-mount terminal blocks)

Push-in type wire jumper, 0.75 mm<sup>2</sup> wire cross-section (suitable for 2001, 2002, 2003 and 2022 Series rail-mount terminal blocks)

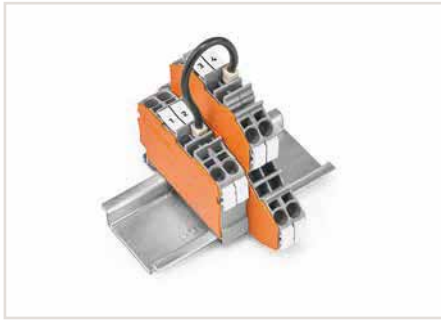

Push-in type wire jumpers common terminal blocks over longer distances and across multiple levels.

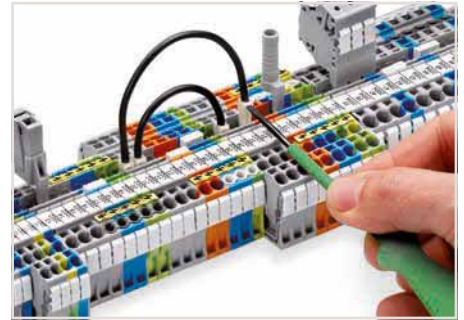

Push down the wire jumper until fully inserted. Lift the jumper with an operating tool for rewiring.



Star point jumper (2000 to 2016 Series)

Delta jumper (2000 to 2004 Series)

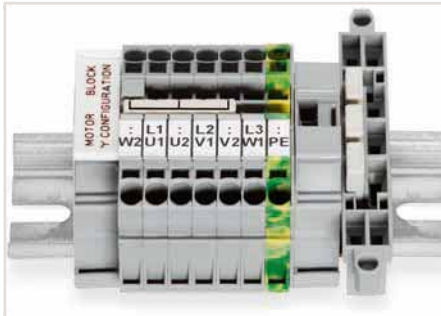

This star point jumper has been specially developed to create a "star point" and is used on motor terminal boards equipped with TOPJOB® S rail-mount terminal blocks.



This delta jumper has been specially developed to create a delta configuration and is used on motor terminal boards equipped with TOPJOB® S rail-mount terminal blocks.



Collective carrier for TOPJOB® S jumpers



## TOPJOB® S Step-Down Jumpers Installation

1



Step-down jumpers (2006-499 and 2016-499)

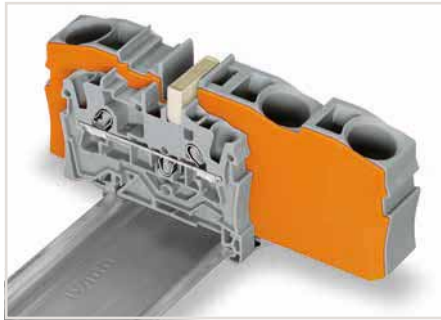

Step-down jumpers may common terminal blocks of different sizes, without losing a conductor clamping point. This can be beneficial on long conductor runs where voltage drops may be problematic. A large conductor can be easily connected to smaller conductors at the distribution point. Commoning may be made in either direction using the special thin end plate to cover the open side. Additional through terminal blocks having a smaller cross-section may be commoned using push-in type jumper bars.

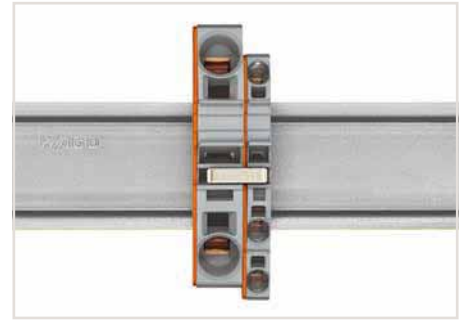

Using step-down jumpers, an end plate must be inserted between the terminal blocks to be commoned.

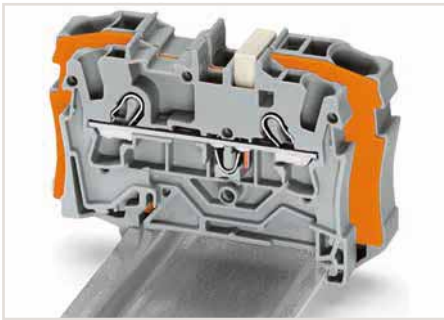

Step-down jumper (2006-499) commons 6/4 mm<sup>2</sup> (10/12 AWG) terminal blocks (2006/2004 Series) with 4/2.5/1.5 mm<sup>2</sup> (AWG 12/14/16) terminal blocks (2004/2002/2001 Series).

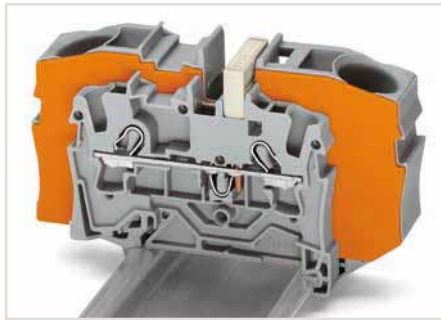

Step-down jumper (2016-499) commons 16/10 mm<sup>2</sup> (16/8 AWG) terminal blocks (2016/2010 Series) with 10/6/4/2.5 mm<sup>2</sup> (8/10/12/14 AWG) terminal blocks (2010/2006/2004/2002 Series).



**Stepping down via push-in type jumper bar.** Commoning via open terminal side with end plate allows jumpering over two cross-section sizes for 16 mm<sup>2</sup> (6 AWG) and 10 mm<sup>2</sup> (8 AWG) and one cross-section size for 6/4/2.5 mm<sup>2</sup> (10/12/14 AWG). An example: from 16 mm<sup>2</sup> (6 AWG) to 6 mm<sup>2</sup> (10 AWG) (see illustration above) or from 10 mm<sup>2</sup> (8 AWG) to 4 mm<sup>2</sup> (12 AWG).

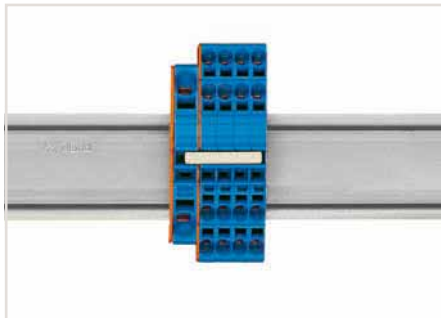

**Stepping down via push-in type jumper bar.** Commoning via closed terminal side with end plate allows jumpering over two cross-section sizes. e.g., from 16 mm<sup>2</sup> (6 AWG) to 6 mm<sup>2</sup> (10 AWG) or from 6 mm<sup>2</sup> (10 AWG) to 2.5 mm<sup>2</sup> (14 AWG) (see illustration above).

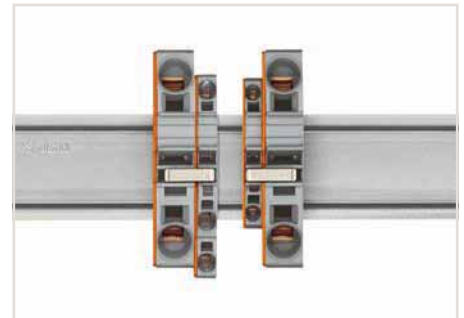

**Note:** The total current of the outgoing circuits shall not exceed the nominal current of the step-down jumper/push-in type jumper bar.



Step-down jumper (285-430)



Commoning 35 mm<sup>2</sup> (2 AWG) POWER CAGE CLAMP Terminal Blocks with 10/16 mm<sup>2</sup> (8/6 AWG) TOPJOB® S Terminal Blocks using step-down jumpers (285-430).

# TOPJOB® S

## Marking Accessories

Also see "Marking" Catalog, Volume 6.

1

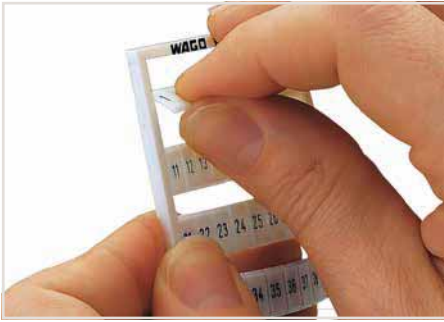

Separating a strip from the WMB marker card.



Stretching a marker strip:  
4 ... 4.2 mm  
5 ... 5.2 mm



Separating an individual marker from the strip – for larger terminal blocks.

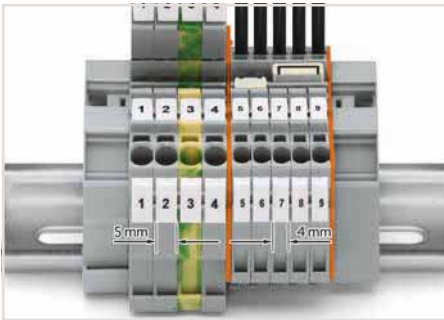

**WMB Inline markers**  
2009-115 Markers for 5–5.2 mm wide terminal blocks compared to 2009-114 Markers for 4–4.2 mm wide terminal blocks



**WMB Inline markers**  
WMB markers on a continuous reel

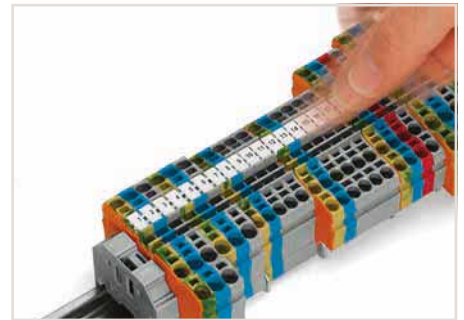

Snapping WMB Inline markers into marker slots.



**Standard and quick marking options:**  
Three marker slots are available for both individual markers and marking strips.



Printing a marking strip (2009-110) via **smartPRINTER**.

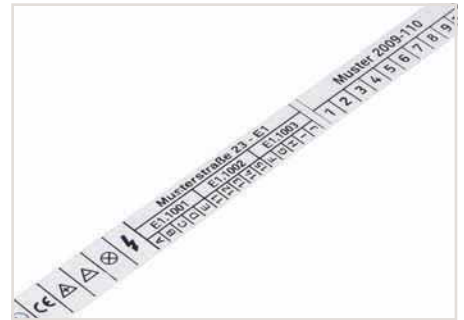

Multi-line printing of marking strips



Marking clamping points via WMB Multi Marking System.  
Marking a group of terminal blocks via marking strip.

# TOPJOB® S Marking Accessories

Also see "Marking" Catalog, Volume 6.

1



TOPJOB® S 2009-193 Group Marker Carrier (equipped with a marking strip) for all 2001 to 2016 Series TOPJOB® S Rail-Mount Terminal Blocks Do not use on an end plate!



Using marker carriers for marking strips (2009-198) in lateral marker slots.



Using marker carriers for marking strips (2002-161) in jumper slots.

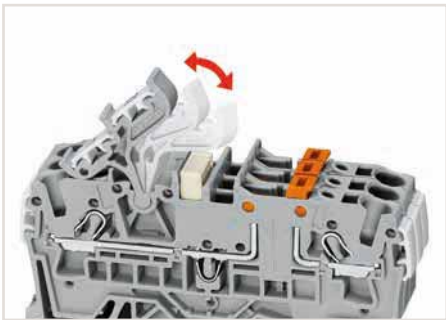

Pivoting double-deck marker carrier (2002-121) and 2-conductor disconnect/test terminal block (2002-1671)



Group marker carrier (2009-163) for marking strips (2009-110)



Height-adjustable group marker carrier (2009-163) for WMB markers or marking strips (2009-110) – snaps onto end stops.

## TOPJOB® S

## L-Type Test Plug Modules, Test Plug Adapters and Testing Taps

1



TOPJOB® S L-type test plugs for testing rail-mount terminal blocks via conductor entries



TOPJOB® S L-type test plug assembly:

- L-type test plug modules
- L-type spacer modules (max. 10-pole) to skip terminal blocks

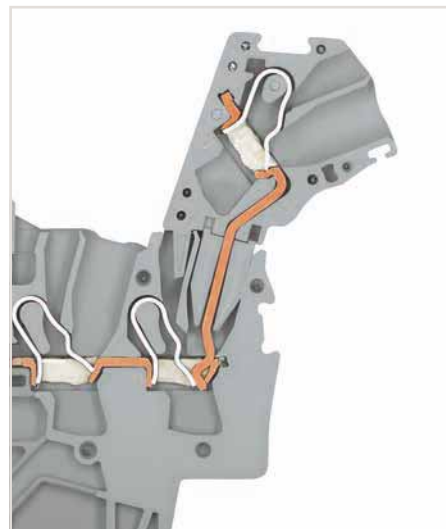

L-type test plug module – cross-sectional view of contacts



L-type test plug modules fitted in a triple-deck terminal block



Test plug adapter (2009-174, CAT I) for 4 mm Ø plugs – compatible with 2000 to 2016 Series



Testing tap (2009-182) for tool-free connection of test cables up to 2.5 mm<sup>2</sup> (12 AWG) – compatible with 2000 to 2016 Series



## TOPJOB® S

### Modular Connectors and Connector Strips

#### 2000 to 2016 Series

1

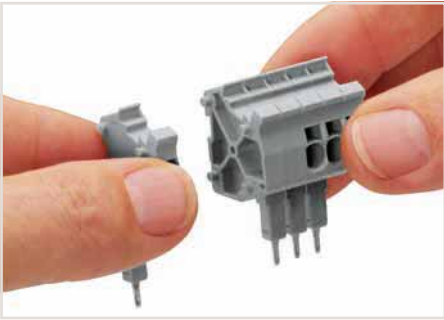

Snapping connectors and spacers together to assemble a multipole connector.

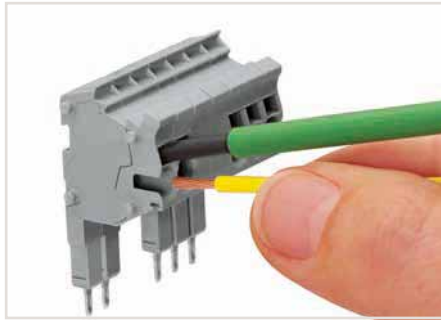

#### Conductor termination via:

- Operating tool for fine-stranded conductors without ferrules
- Push-in connection of solid conductors

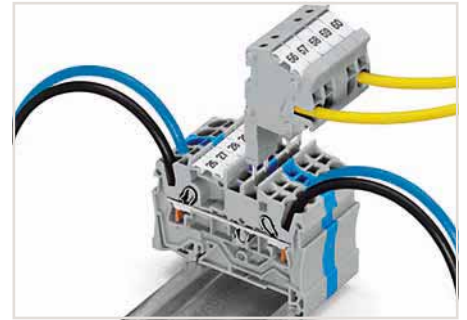

The modular TOPJOB® S connectors also connect conductors of the same size as the terminal blocks being used.



TOPJOB® S Connectors with a 2 mm Ø test socket for testing voltage via 2-pole voltage tester



Snapping on a strain relief plate.

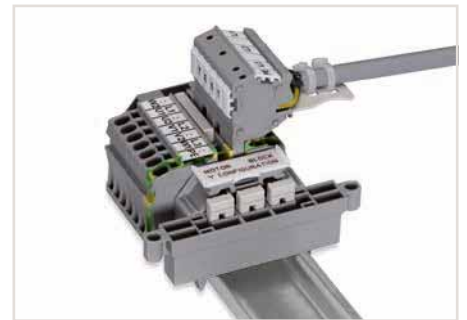

Rail-mount terminal block assembly for electric motor wiring



## TOPJOB® S

### Separators for Ex e/Ex Applications

#### Installation

1

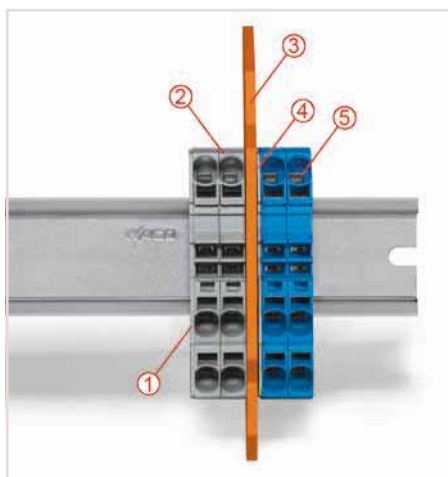

Separator located between Ex e II and Ex i terminal strip

- ① End plate
- ② Ex e II terminal blocks
- ③ Separator for Ex e/Ex i applications
- ④ End plate
- ⑤ Ex i terminal blocks

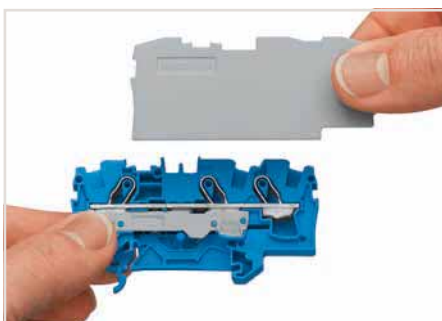

#### Separator for Ex e/Ex applications

An end plate must be applied to the terminal block located directly behind an Ex e/Ex i separator plate.

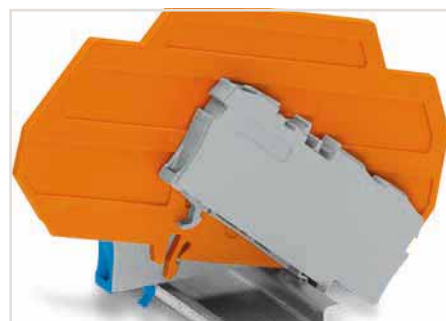

#### Ex e II/Ex i terminal strip

**Notice:**  
The movable feet of terminal blocks and separator plates must face the same direction.



#### Example of marking (rear):

The embossed details on the terminal blocks show the manufacturer's name, the series no., the type of protection Ex e II, the approval no., the approval data and the name of the test authority.

# TOPJOB® S

## Notes

### Installation

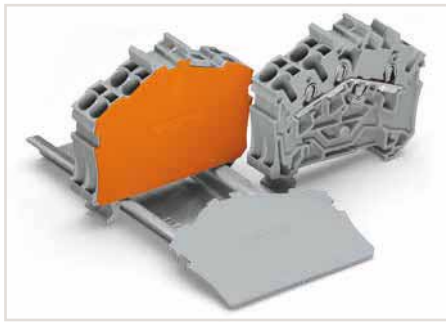

An end plate must be applied when changing from a 3-conductor terminal block to a 4-conductor terminal block (angled type) and vice versa.



With continuous terminal strips, an end plate must be used when changing from 3- to 4-conductor terminal blocks.

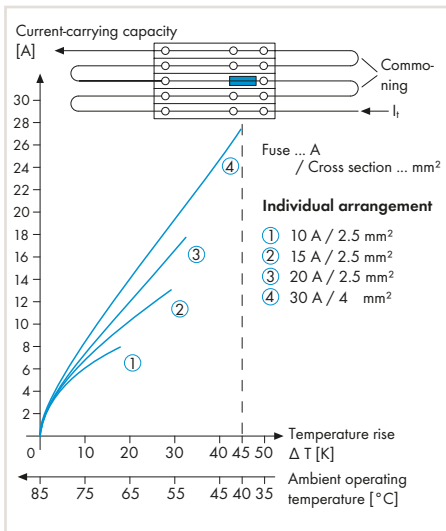

Application Notes on Terminal Blocks for Miniature Metric Fuses  
Diagram: Individual arrangement

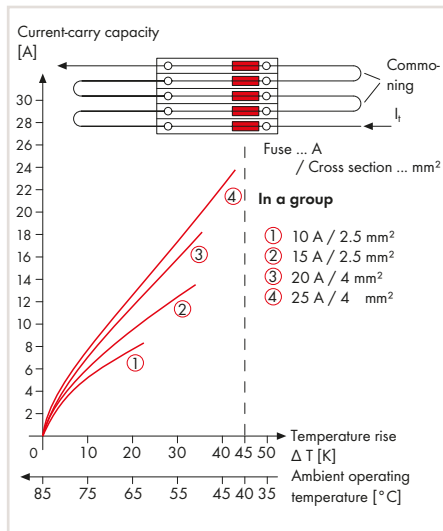

Application Notes on Terminal Blocks for Miniature Metric Fuses  
Diagram: Block arrangement

**Information from the mini-automotive, blade-type fuse manufacturers**

Derating T <sub>amb</sub> / °C	%	F <sub>T</sub>
- 25	14	0.877
- 20	13	0.885
- 15	12	0.893
- 10	11	0.901
- 5	10	0.909
0	9	0.917
5	8	0.926
10	6	0.943
15	4	0.962
20	2	0.980
23	0	1.000
30	- 2	1.020
35	- 4	1.042
40	- 6	1.064
45	- 8	1.087
50	- 10	1.111
55	- 13	1.149
60	- 16	1.190
65	- 19	1.235
70	- 22	1.282

For product safety, fuse cartridges must generally be tested both under normal and faulty operating conditions within your application.

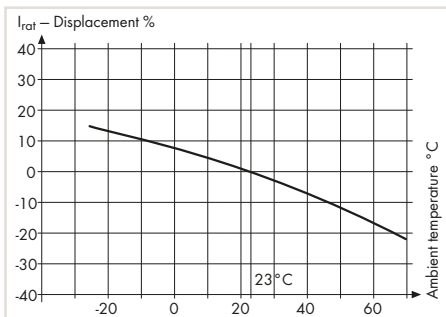

Application Notes on Terminal Blocks for Miniature Metric Fuses

Nominal current ratings for fuse cartridges are defined differently in international standards. This is why the recommended continuous current-carrying capacity of the fuses is max. 80 % of their nominal current according to DIN 72581/Part 3 (for an ambient operating temperature of 23 °C). Selecting the correct fuse cartridge is important for product safety within applications, as well as for fuse cartridge service life and reliability. Fuse cartridges will only operate perfectly as protection components (break-off point) if they are properly selected and used as intended (i.e., according to the state of the technology and valid specifications, as well as data sheet characteristics), according to basic safety requirements (i.e., persons, animals and property must be protected against hazards).

## TOPJOB® S

### Through/Double Potential Through and Ex Terminal Blocks

#### 1 (1.5) mm<sup>2</sup>, 2000 Series

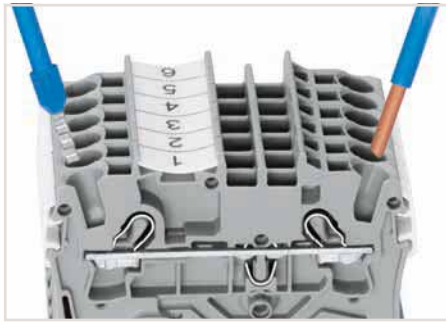

Terminating solid and ferruled conductors via push-in connection.

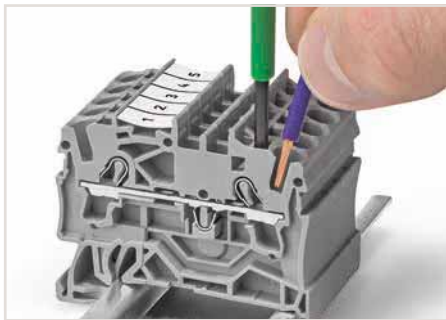

Terminating fine-stranded conductors via operating tool.

Rail-mount terminal blocks with an Ex mark are suitable for Ex e II applications. Terminal blocks with a blue insulated housing are suitable for Ex i applications.

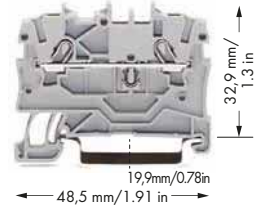

2-conductor through terminal block

Color	Item No.	Pack. Unit
gray ☉	2000-1201	100
blue ☉	2000-1204	100



#### Technical Data

Ratings per	IEC/EN 60947-7-1
Rated voltage (III / 3)	800 V
Rated surge voltage (III / 3)	8 kV
Rated current	13.5 A
Rated voltage EN (Ex e II)	550 V
Nominal current (Ex e II)	13 A
Nominal current (Ex e II) with jumper	12 A
Rated current (2)	18 A
Approval	600 V, 10 A  600 V, 10 A
Nominal cross section	1 mm <sup>2</sup>
<b>Connection Data</b>	
Solid conductor	0.14 ... 1.5 mm <sup>2</sup> / 24 ... 16 AWG
Solid conductor, push-in termination	0.5 ... 1.5 mm <sup>2</sup> / 20 ... 16 AWG
Fine-stranded conductor	0.14 ... 1.5 mm <sup>2</sup> / 24 ... 16 AWG
Fine-stranded conductor with ferrule, push-in termination, min.	0.5 mm <sup>2</sup> / 20 AWG
Strip length	9 ... 11 mm / 0.35 ... 0.43 inch
Terminal block width	3.5 mm / 0.138 inch
Insulation material	Polyamide 66 (PA 66)

#### Note:

#### Accessories (Selection)

Push-in type jumper bar, insulated, I <sub>N</sub> 14 A, light gray
End and intermediate plate, 0.7 mm thick
WMB Multi marking system, white, 10 strips with 10 markers per card, for 3.5 mm terminal block width
Marking strip, plain, 11 mm wide, 50 m reel
Modular TOPJOB® S connector, for jumper contact slot, snaps together

	Item No.	Page
2-way	2000-402	160
orange	2000-1292	161
plain	793-3501	780
white	2009-110	783
gray	2000-511	156

Additional colors, visit [www.wago.com](http://www.wago.com)

Accessories (jumpers, end plates, test plugs, etc.), see page 160

Carrier rails and tools, see Section 13

Appropriate marking system, WMB/markings strips, see Full Line Catalog, Volume 6

Information on hazardous locations, see Section 14

Approvals and corresponding ratings, visit [www.wago.com](http://www.wago.com)

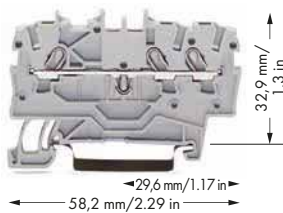

3-conductor through terminal block

Color	Item No.	Pack. Unit
gray	2000-1301	100
blue	2000-1304	100



IEC/EN 60947-7-1
800 V
8 kV
13.5 A
550 V
13 A
12 A
18 A
600 V, 10 A ; 600 V, 10 A
1 mm <sup>2</sup>
0.14 ... 1.5 mm <sup>2</sup> / 24 ... 16 AWG
0.5 ... 1.5 mm <sup>2</sup> / 20 ... 16 AWG
0.14 ... 1.5 mm <sup>2</sup> / 24 ... 16 AWG
0.5 mm <sup>2</sup> / 20 AWG
9 ... 11 mm / 0.35 ... 0.43 inch
3.5 mm / 0.138 inch
Polyamide 66 (PA 66)

	Item No.	Page
2-way	2000-402	160
orange	2000-1392	161
plain	793-3501	780
white	2009-110	783
gray	2000-511	156

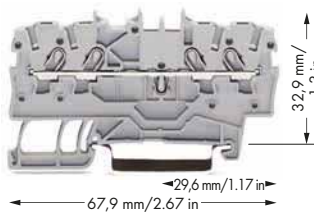

4-conductor through terminal block

Color	Item No.	Pack. Unit
gray	2000-1401	100
blue	2000-1404	100



IEC/EN 60947-7-1
800 V
8 kV
13.5 A
550 V
13 A
12 A
18 A
600 V, 10 A ; 600 V, 10 A
1 mm <sup>2</sup>
0.14 ... 1.5 mm <sup>2</sup> / 24 ... 16 AWG
0.5 ... 1.5 mm <sup>2</sup> / 20 ... 16 AWG
0.14 ... 1.5 mm <sup>2</sup> / 24 ... 16 AWG
0.5 mm <sup>2</sup> / 20 AWG
9 ... 11 mm / 0.35 ... 0.43 inch
3.5 mm / 0.138 inch
Polyamide 66 (PA 66)

	Item No.	Page
2-way	2000-402	160
orange	2000-1492	161
plain	793-3501	780
white	2009-110	783
gray	2000-511	156

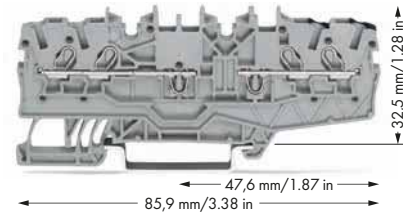

Double potential terminal block, both potentials can be commoned

Color	Item No.	Pack. Unit
gray	2000-2141	100

IEC/EN 60947-7-1
800 V
8 kV
13.5 A
18 A
1 mm <sup>2</sup>
0.14 ... 1.5 mm <sup>2</sup> / 24 ... 16 AWG
0.5 ... 1.5 mm <sup>2</sup> / 20 ... 16 AWG
0.14 ... 1.5 mm <sup>2</sup> / 24 ... 16 AWG
0.5 mm <sup>2</sup> / 20 AWG
9 ... 11 mm / 0.35 ... 0.43 inch
3.5 mm / 0.138 inch
Polyamide 66 (PA 66)

Double-potential terminal blocks save space. Two independent feedthrough circuits are placed in one insulated housing on one level in just 3.5 mm. This achieves a width of just 1.75 mm (0.069 inch) versus standard through terminal blocks. Input and output contacts of one circuit are placed on the same side of the terminal block. Both circuits can be individually marked according to input and output.

	Item No.	Page
2-way	2000-402	160
orange	2000-2196	161
plain	793-3501	780
white	2009-110	783
gray	2000-511	156

# TOPJOB® S

## Ground Conductor and Ex Terminal Blocks

### 1 (1.5) mm<sup>2</sup>, 2000 Series

1

Rail-mount terminal blocks with an Ex mark are suitable for Ex e II applications.

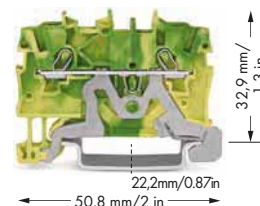

2-conductor ground terminal block

Color	Item No.	Pack. Unit
● green-yellow ☉	2000-1207	100



#### Technical Data

Ratings per	IEC/EN 60947-7-2
Nominal cross section	1 mm <sup>2</sup>
<b>Connection Data</b>	
Solid conductor	0.14 ... 1.5 mm <sup>2</sup> / 24 ... 16 AWG
Solid conductor, push-in termination	0.5 ... 1.5 mm <sup>2</sup> / 20 ... 16 AWG
Fine-stranded conductor	0.14 ... 1.5 mm <sup>2</sup> / 24 ... 16 AWG
Fine-stranded conductor with ferrule, push-in termination, min.	0.5 mm <sup>2</sup> / 20 AWG
Strip length	9 ... 11 mm / 0.35 ... 0.43 inch
Terminal block width	3.5 mm / 0.138 inch
Insulation material	Polyamide 66 (PA 66)

#### Accessories (Selection)

	Item No.	Page
Push-in type jumper bar, insulated, I <sub>N</sub> 14 A, light gray	2000-402	160
End and intermediate plate, 0.7 mm thick	2000-1292	161
WMB Multi marking system, white, 10 strips with 10 markers per card, for 3.5 mm terminal block width	793-3501	780
Marking strip, plain, 11 mm wide, 50 m reel	2009-110	783
Modular TOPJOB® S connector, for jumper contact slot, snaps together	2000-511	156

📖 Accessories (jumpers, end plates, test plugs, etc.), see page 160

📖 Carrier rails and tools, see Section 13

📖 Appropriate marking system, WMB/markings strips, see Full Line Catalog, Volume 6

📖 Information on hazardous locations, see Section 14

📖 Approvals and corresponding ratings, visit [www.wago.com](http://www.wago.com)



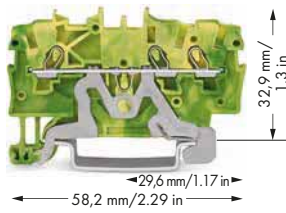

3-conductor ground terminal block		
Color	Item No.	Pack. Unit
● green-yellow ☺	2000-1307	100



IEC/EN 60947-7-2
1 mm <sup>2</sup>
0.14 ... 1.5 mm <sup>2</sup> / 24 ... 16 AWG
0.5 ... 1.5 mm <sup>2</sup> / 20 ... 16 AWG
0.14 ... 1.5 mm <sup>2</sup> / 24 ... 16 AWG
0.5 mm <sup>2</sup> / 20 AWG
9 ... 11 mm / 0.35 ... 0.43 inch
3.5 mm / 0.138 inch
Polyamide 66 (PA 66)

	Item No.	Page
2-way	2000-402	160
orange	2000-1392	161
plain	793-3501	780
white	2009-110	783
gray	2000-511	156

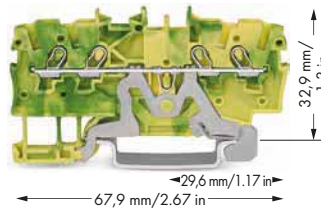

4-conductor ground terminal block		
Color	Item No.	Pack. Unit
● green-yellow ☺	2000-1407	100



IEC/EN 60947-7-2
1 mm <sup>2</sup>
0.14 ... 1.5 mm <sup>2</sup> / 24 ... 16 AWG
0.5 ... 1.5 mm <sup>2</sup> / 20 ... 16 AWG
0.14 ... 1.5 mm <sup>2</sup> / 24 ... 16 AWG
0.5 mm <sup>2</sup> / 20 AWG
9 ... 11 mm / 0.35 ... 0.43 inch
3.5 mm / 0.138 inch
Polyamide 66 (PA 66)

	Item No.	Page
2-way	2000-402	160
orange	2000-1492	161
plain	793-3501	780
white	2009-110	783
gray	2000-511	156

## TOPJOB® S

## Through/Double Potential Through and Ex Terminal Blocks

1.5 (2.5) mm<sup>2</sup>, 2001 Series

1

Rail-mount terminal blocks with an Ex mark are suitable for Ex e II applications. Terminal blocks with a blue insulated housing are suitable for Ex i applications.

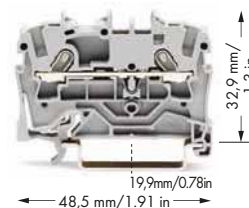

2-conductor through terminal block

Color	Item No.	Pack. Unit
gray ☉	2001-1201	100
blue ☉	2001-1204	100



## Technical Data

Ratings per	IEC/EN 60947-7-1
Rated voltage (III / 3)	800 V
Rated surge voltage (III / 3)	8 kV
Rated current	18 A
Rated voltage EN (Ex e II)	550 V
Nominal current (Ex e II)	17 A
Nominal current (Ex e II) with jumper	16 A
Rated current (2)	24 A
Approval	600 V, 15 A  600 V, 15 A
Nominal cross section	1.5 mm <sup>2</sup>
<b>Connection Data</b>	
Solid conductor	0.25 ... 2.5 mm <sup>2</sup> / 22 ... 14 AWG
Solid conductor, push-in termination	0.5 ... 2.5 mm <sup>2</sup> / 20 ... 14 AWG
Fine-stranded conductor	0.25 ... 2.5 mm <sup>2</sup> / 22 ... 14 AWG
Fine-stranded conductor with ferrule, push-in termination, min.	0.75 mm <sup>2</sup> / 18 AWG
Strip length	9 ... 11 mm / 0.35 ... 0.43 inch
Terminal block width	4.2 mm / 0.165 inch
Insulation material	Polyamide 66 (PA 66)

## Note:

## Accessories (Selection)

	Item No.	Page
Push-in type jumper bar, insulated, I <sub>N</sub> 18 A, light gray	2001-402	162
End and intermediate plate, 0.8 mm thick	orange 2002-1292	163
WMB Inline, plain, 2,000 WMB markers (4 mm) per reel, 4 ... 4.2 mm stretchable	white 2009-114	780
Marking strip, plain, 11 mm wide, 50 m reel	white 2009-110	783
Modular TOPJOB® S connector, for jumper contact slot, snaps together	gray 2001-511	157

Additional colors, visit [www.wago.com](http://www.wago.com)

Accessories (jumpers, end plates, test plugs, etc.), see page 162

Carrier rails and tools, see Section 13

Appropriate marking system, WMB/WMB Inline/markings strips, see Full Line Catalog, Volume 6

Information on hazardous locations, see Section 14

Approvals and corresponding ratings, visit [www.wago.com](http://www.wago.com)

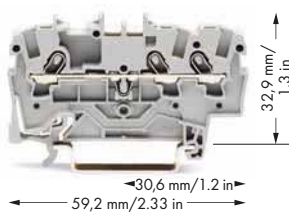

3-conductor through terminal block

Color	Item No.	Pack. Unit
gray	2001-1301	100
blue	2001-1304	100



IEC/EN 60947-7-1
800 V
8 kV
18 A
550 V
17 A
16 A
24 A
600 V, 15 A; 600 V, 15 A
1.5 mm <sup>2</sup>
0.25 ... 2.5 mm <sup>2</sup> / 22 ... 14 AWG
0.5 ... 2.5 mm <sup>2</sup> / 20 ... 14 AWG
0.25 ... 2.5 mm <sup>2</sup> / 22 ... 14 AWG
0.75 mm <sup>2</sup> / 18 AWG
9 ... 11 mm / 0.35 ... 0.43 inch
4.2 mm / 0.165 inch
Polyamide 66 (PA 66)

	Item No.	Page
2-way	2001-402	162
orange	2002-1392	163
white	2009-114	780
white	2009-110	783
gray	2001-511	157

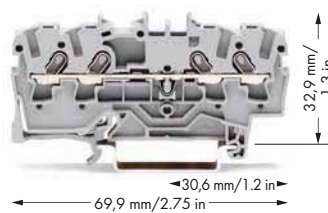

4-conductor through terminal block

Color	Item No.	Pack. Unit
gray	2001-1401	100
blue	2001-1404	100



IEC/EN 60947-7-1
800 V
8 kV
18 A
550 V
17 A
16 A
24 A
600 V, 15 A; 600 V, 15 A
1.5 mm <sup>2</sup>
0.25 ... 2.5 mm <sup>2</sup> / 22 ... 14 AWG
0.5 ... 2.5 mm <sup>2</sup> / 20 ... 14 AWG
0.25 ... 2.5 mm <sup>2</sup> / 22 ... 14 AWG
0.75 mm <sup>2</sup> / 18 AWG
9 ... 11 mm / 0.35 ... 0.43 inch
4.2 mm / 0.165 inch
Polyamide 66 (PA 66)

	Item No.	Page
2-way	2001-402	162
orange	2002-1492	163
white	2009-114	780
white	2009-110	783
gray	2001-511	157

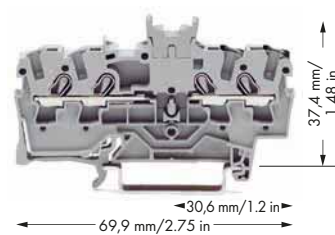

Double potential terminal block, with double, center marker slot

Color	Item No.	Pack. Unit
gray	2001-1441	100



IEC/EN 60947-7-1
800 V
8 kV
18 A
550 V
17 A
16 A
24 A
600 V, 15 A; 600 V, 15 A
1.5 mm <sup>2</sup>
0.25 ... 2.5 mm <sup>2</sup> / 22 ... 14 AWG
0.5 ... 2.5 mm <sup>2</sup> / 20 ... 14 AWG
0.25 ... 2.5 mm <sup>2</sup> / 22 ... 14 AWG
0.75 mm <sup>2</sup> / 18 AWG
9 ... 11 mm / 0.35 ... 0.43 inch
4.2 mm / 0.165 inch
Polyamide 66 (PA 66)

Double-potential terminal blocks save space. Two independent feedthrough circuits are placed in one insulated housing on one level in just 4.2 mm. This achieves a width of just 2.1 mm (0.083 inch) versus standard through terminal blocks. Input and output contacts of one circuit are placed on the same side of the terminal block. Both circuits can be individually marked according to input and output.

	Item No.	Page
2-way	2001-402	162
orange	2002-1492	163
white	2009-114	780
white	2009-110	783

# TOPJOB® S

## Ground/Shield Conductor and Ex Terminal Blocks

### 1.5 (2.5) mm<sup>2</sup>, 2001 Series

1

Rail-mount terminal blocks with an Ex mark are suitable for Ex e II applications.

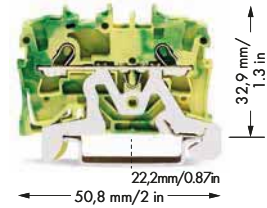

#### 2-conductor ground terminal block

Color	Item No.	Pack. Unit
● green-yellow ☹	2001-1207	100

#### 2-conductor shield terminal block

Color	Item No.	Pack. Unit
○ white	2001-1208	100



#### Technical Data

Ratings per	IEC/EN 60947-7-2
Nominal cross section	1.5 mm <sup>2</sup>
Connection Data	
Solid conductor	0.25 ... 2.5 mm <sup>2</sup> / 22 ... 14 AWG
Solid conductor, push-in termination	0.5 ... 2.5 mm <sup>2</sup> / 20 ... 14 AWG
Fine-stranded conductor	0.25 ... 2.5 mm <sup>2</sup> / 22 ... 14 AWG
Fine-stranded conductor with ferrule, push-in termination, min.	0.75 mm <sup>2</sup> / 18 AWG
Strip length	9 ... 11 mm / 0.35 ... 0.43 inch
Terminal block width	4.2 mm / 0.165 inch
Insulation material	Polyamide 66 (PA 66)

#### Accessories (Selection)

	Item No.	Page
Push-in type jumper bar, insulated, I <sub>N</sub> 18 A, light gray	2001-402	162
End and intermediate plate, 0.8 mm thick	orange 2002-1292	163
WMB Inline, plain, 2,000 WMB markers (4 mm) per reel, 4 ... 4.2 mm stretchable	white 2009-114	780
Marking strip, plain, 11 mm wide, 50 m reel	white 2009-110	783
Modular TOPJOB® S connector, for jumper contact slot, snaps together	gray 2001-511	157

📖 Accessories (jumpers, end plates, test plugs, etc.), see page 162

📖 Carrier rails and tools, see Section 13

📖 Appropriate marking system, WMB/WMB Inline/markings strips, see Full Line Catalog, Volume 6

📖 Information on hazardous locations, see Section 14

📖 Approvals and corresponding ratings, visit [www.wago.com](http://www.wago.com)

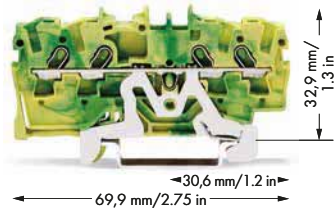
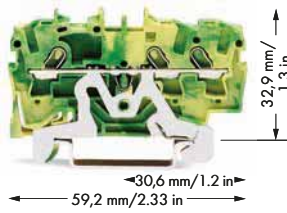

3-conductor ground terminal block		
Color	Item No.	Pack. Unit
● green-yellow ☉	2001-1307	100

4-conductor ground terminal block		
Color	Item No.	Pack. Unit
● green-yellow ☉	2001-1407	100

3-conductor shield terminal block		
Color	Item No.	Pack. Unit
○ white	2001-1308	100

4-conductor shield terminal block		
Color	Item No.	Pack. Unit
○ white	2001-1408	100



IEC/EN 60947-7-2
1.5 mm <sup>2</sup>
0.25 ... 2.5 mm <sup>2</sup> / 22 ... 14 AWG
0.5 ... 2.5 mm <sup>2</sup> / 20 ... 14 AWG
0.25 ... 2.5 mm <sup>2</sup> / 22 ... 14 AWG
0.75 mm <sup>2</sup> / 18 AWG
9 ... 11 mm / 0.35 ... 0.43 inch
4.2 mm / 0.165 inch
Polyamide 66 (PA 66)

IEC/EN 60947-7-2
1.5 mm <sup>2</sup>
0.25 ... 2.5 mm <sup>2</sup> / 22 ... 14 AWG
0.5 ... 2.5 mm <sup>2</sup> / 20 ... 14 AWG
0.25 ... 2.5 mm <sup>2</sup> / 22 ... 14 AWG
0.75 mm <sup>2</sup> / 18 AWG
9 ... 11 mm / 0.35 ... 0.43 inch
4.2 mm / 0.165 inch
Polyamide 66 (PA 66)

	Item No.	Page
2-way	2001-402	162
orange	2002-1392	163
white	2009-114	780
white	2009-110	783
gray	2001-511	157

	Item No.	Page
2-way	2001-402	162
orange	2002-1492	163
white	2009-114	780
white	2009-110	783
gray	2001-511	157



## TOPJOB® S

### Through/Double Potential Through and Ex Terminal Blocks

#### 2.5 (4) mm<sup>2</sup>, 2002 Series

1



By combining a 1-to-2 continuous jumper with a 1-to-3 adjacent jumper, various commoning applications can be performed in just one jumper slot.

Rail-mount terminal blocks with an Ex mark are suitable for Ex e II applications. Terminal blocks with a blue insulated housing are suitable for Ex i applications.

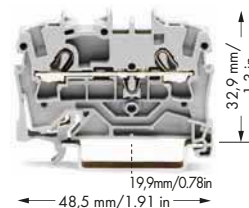

2-conductor through terminal block

Color	Item No.	Pack. Unit
gray ☉	2002-1201	100
blue ☉	2002-1204	100



#### Technical Data

Ratings per	IEC/EN 60947-7-1
Rated voltage (III / 3)	800 V
Rated surge voltage (III / 3)	8 kV
Rated current	24 A
Rated voltage EN (Ex e II)	550 V
Nominal current (Ex e II)	22 A
Nominal current (Ex e II) with jumper	20 A
Rated current (2)	32 A
Approval	600 V, 20 A  600 V, 20 A
Nominal cross section	2.5 mm <sup>2</sup>
<b>Connection Data</b>	
Solid conductor	0.25 ... 4 mm <sup>2</sup> / 22 ... 12 AWG
Solid conductor, push-in termination	0.75 ... 4 mm <sup>2</sup> / 18 ... 12 AWG
Fine-stranded conductor	0.25 ... 4 mm <sup>2</sup> / 22 ... 12 AWG
Fine-stranded conductor with ferrule, push-in termination, min.	0.75 mm <sup>2</sup> / 18 AWG
Strip length	10 ... 12 mm / 0.39 ... 0.47 inch
Terminal block width	5.2 mm / 0.205 inch
Insulation material	Polyamide 66 (PA 66)

#### Note:

#### Accessories (Selection)

	Item No.	Page
Push-in type jumper bar, insulated, I <sub>N</sub> 25 A, light gray	2002-402	165
End and intermediate plate, 0.8 mm thick	orange 2002-1292	166
WMB Inline, plain, 1,500 WMB markers (5 mm) per reel, 5 ... 5.2 mm stretchable	white 2009-115	780
Marking strip, plain, 11 mm wide, 50 m reel	white 2009-110	783
Modular TOPJOB® S connector, for jumper contact slot, snaps together	gray 2002-511	157

Additional colors, visit [www.wago.com](http://www.wago.com)

Accessories (jumpers, end plates, test plugs, etc.), see page 165

Carrier rails and tools, see Section 13

Appropriate marking system, WMB/WMB Inline/markings strips, see Full Line Catalog, Volume 6

Information on hazardous locations, see Section 14

Approvals and corresponding ratings, visit [www.wago.com](http://www.wago.com)



3-conductor through terminal block

Color	Item No.	Pack. Unit
gray	2002-1301	100
blue	2002-1304	100



IEC/EN 60947-7-1
800 V
8 kV
24 A
550 V
22 A
20 A
32 A
600 V, 20 A ; 600 V, 20 A
2.5 mm <sup>2</sup>
0.25 ... 4 mm <sup>2</sup> / 22 ... 12 AWG
0.75 ... 4 mm <sup>2</sup> / 18 ... 12 AWG
0.25 ... 4 mm <sup>2</sup> / 22 ... 12 AWG
0.75 mm <sup>2</sup> / 18 AWG
10 ... 12 mm / 0.39 ... 0.47 inch
5.2 mm / 0.205 inch
Polyamide 66 (PA 66)

	Item No.	Page
2-way	2002-402	165
orange	2002-1392	166
white	2009-115	780
white	2009-110	783
gray	2002-511	157

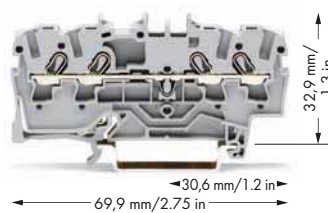

4-conductor through terminal block

Color	Item No.	Pack. Unit
gray	2002-1401	100
blue	2002-1404	100



IEC/EN 60947-7-1
800 V
8 kV
24 A
550 V
22 A
20 A
32 A
600 V, 20 A ; 600 V, 20 A
2.5 mm <sup>2</sup>
0.25 ... 4 mm <sup>2</sup> / 22 ... 12 AWG
0.75 ... 4 mm <sup>2</sup> / 18 ... 12 AWG
0.25 ... 4 mm <sup>2</sup> / 22 ... 12 AWG
0.75 mm <sup>2</sup> / 18 AWG
10 ... 12 mm / 0.39 ... 0.47 inch
5.2 mm / 0.205 inch
Polyamide 66 (PA 66)

	Item No.	Page
2-way	2002-402	165
orange	2002-1492	166
white	2009-115	780
white	2009-110	783
gray	2002-511	157

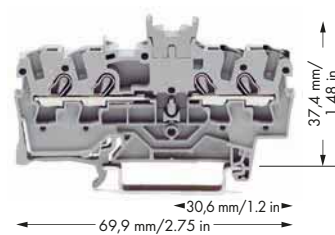

Double potential terminal block, with double, center marker slot

Color	Item No.	Pack. Unit
gray	2002-1441	100



IEC/EN 60947-7-1
800 V
8 kV
24 A
550 V
22 A
20 A
32 A
600 V, 20 A ; 600 V, 20 A
2.5 mm <sup>2</sup>
0.25 ... 4 mm <sup>2</sup> / 22 ... 12 AWG
0.75 ... 4 mm <sup>2</sup> / 18 ... 12 AWG
0.25 ... 4 mm <sup>2</sup> / 22 ... 12 AWG
0.75 mm <sup>2</sup> / 18 AWG
10 ... 12 mm / 0.39 ... 0.47 inch
5.2 mm / 0.205 inch
Polyamide 66 (PA 66)

Double-potential terminal blocks save space. Two independent feedthrough circuits are placed in one insulated housing on one level in just 5.2 mm. This achieves a width of just 2.6 mm (0.103 inch) versus standard through terminal blocks. Input and output contacts of one circuit are placed on the same side of the terminal block. Both circuits can be individually marked according to input and output.

	Item No.	Page
2-way	2002-402	165
orange	2002-1492	166
white	2009-115	780
white	2009-110	783

# TOPJOB® S

## Ground/Shield Conductor and Ex Terminal Blocks

### 2.5 (4) mm<sup>2</sup>, 2002 Series

1

Rail-mount terminal blocks with an Ex mark are suitable for Ex e II applications.

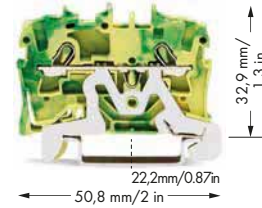

#### 2-conductor ground terminal block

Color	Item No.	Pack. Unit
● green-yellow ☸	2002-1207	100

#### 2-conductor shield terminal block

Color	Item No.	Pack. Unit
○ white	2002-1208	100



#### Technical Data

Ratings per	IEC/EN 60947-7-2
Nominal cross section	2.5 mm <sup>2</sup>
<b>Connection Data</b>	
Solid conductor	0.25 ... 4 mm <sup>2</sup> / 22 ... 12 AWG
Solid conductor, push-in termination	0.75 ... 4 mm <sup>2</sup> / 18 ... 12 AWG
Fine-stranded conductor	0.25 ... 4 mm <sup>2</sup> / 22 ... 12 AWG
Fine-stranded conductor with ferrule, push-in termination, min.	0.75 mm <sup>2</sup> / 18 AWG
Strip length	10 ... 12 mm / 0.39 ... 0.47 inch
Terminal block width	5.2 mm / 0.205 inch
Insulation material	Polyamide 66 (PA 66)

#### Accessories (Selection)

	Item No.	Page
Push-in type jumper bar, insulated, I <sub>N</sub> 25 A, light gray	2002-402	165
End and intermediate plate, 0.8 mm thick	orange 2002-1292	166
WMB Inline, plain, 1,500 WMB markers (5 mm) per reel, 5 ... 5.2 mm stretchable	white 2009-115	780
Marking strip, plain, 11 mm wide, 50 m reel	white 2009-110	783
Modular TOPJOB® S connector, for jumper contact slot, snaps together	gray 2002-511	157

📖 Accessories (jumpers, end plates, test plugs, etc.), see page 165

📖 Carrier rails and tools, see Section 13

📖 Appropriate marking system, WMB/WMB Inline/markings strips, see Full Line Catalog, Volume 6

📖 Information on hazardous locations, see Section 14

📖 Approvals and corresponding ratings, visit [www.wago.com](http://www.wago.com)

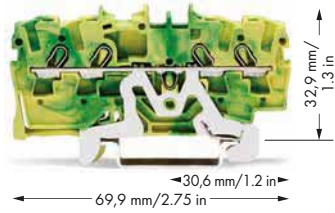
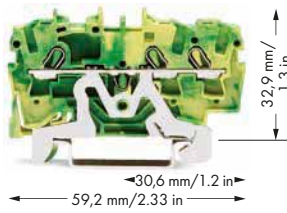

3-conductor ground terminal block		
Color	Item No.	Pack. Unit
● green-yellow ☉	2002-1307	100

4-conductor ground terminal block		
Color	Item No.	Pack. Unit
● green-yellow ☉	2002-1407	100

3-conductor shield terminal block		
Color	Item No.	Pack. Unit
○ white	2002-1308	100

4-conductor shield terminal block		
Color	Item No.	Pack. Unit
○ white	2002-1408	100



IEC/EN 60947-7-2
2.5 mm <sup>2</sup>
0.25 ... 4 mm <sup>2</sup> / 22 ... 12 AWG
0.75 ... 4 mm <sup>2</sup> / 18 ... 12 AWG
0.25 ... 4 mm <sup>2</sup> / 22 ... 12 AWG
0.75 mm <sup>2</sup> / 18 AWG
10 ... 12 mm / 0.39 ... 0.47 inch
5.2 mm / 0.205 inch
Polyamide 66 (PA 66)

IEC/EN 60947-7-2
2.5 mm <sup>2</sup>
0.25 ... 4 mm <sup>2</sup> / 22 ... 12 AWG
0.75 ... 4 mm <sup>2</sup> / 18 ... 12 AWG
0.25 ... 4 mm <sup>2</sup> / 22 ... 12 AWG
0.75 mm <sup>2</sup> / 18 AWG
10 ... 12 mm / 0.39 ... 0.47 inch
5.2 mm / 0.205 inch
Polyamide 66 (PA 66)

	Item No.	Page
2-way	2002-402	165
orange	2002-1392	166
white	2009-115	780
white	2009-110	783
gray	2002-511	157

	Item No.	Page
2-way	2002-402	165
orange	2002-1492	166
white	2009-115	780
white	2009-110	783
gray	2002-511	157

## TOPJOB® S

### Through/Ground/Shield Conductor and Ex Terminal Blocks

#### 2.5 (4) mm<sup>2</sup>, 2002 Series

1

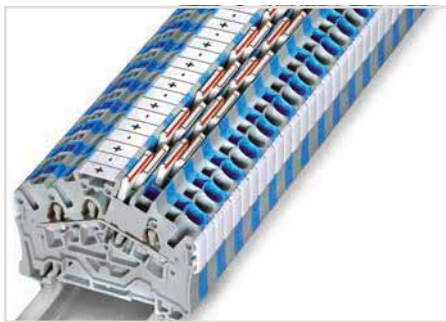

**3- and 4-conductor terminal blocks (angled type)**  
WAGO's TOPJOB® S Rail-Mount Terminal Blocks have a 35-degree conductor entry angle permitting a very small bend radius and an extremely short wiring distance to the cable duct. These are space- and cost-saving solutions for switchgear and control cabinet applications that use the LSC wiring system from Lütze. The design allows cable duct to be placed very close to the terminal blocks, keeping its height relatively low.

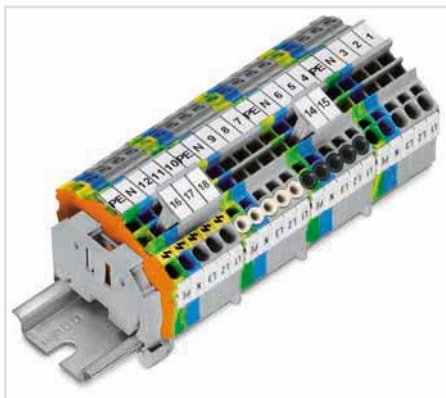

#### Product features:

- Push-in CAGE CLAMP® connection for all conductor types, with the additional benefit of solid, stranded and fine-stranded conductors with ferrules being simply pushed in
- Vibration-proof, fast, maintenance-free
- 3-conductor through and ground conductor terminal blocks equipped with a dual jumper slot
- 4-conductor terminal blocks permit potential multiplication – no additional jumpers or terminal blocks needed
- 3- and 4-conductor terminal blocks have the same dimensions
- An end plate must be applied when changing from a 3-conductor terminal block to a 4-conductor terminal block and vice versa.

Rail-mount terminal blocks with an Ex mark are suitable for Ex e II applications. Terminal blocks with a blue insulated housing are suitable for Ex i applications.

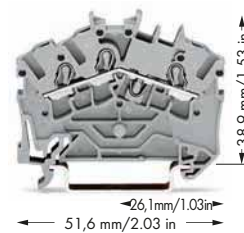

#### 3-conductor through terminal block

Color	Item No.	Pack. Unit
gray ☉	2002-6301	100
blue ☉	2002-6304	100



#### Technical Data

Ratings per	IEC/EN 60947-7-1
Rated voltage (III / 3)	800 V
Rated surge voltage (III / 3)	8 kV
Rated current	24 A
Rated voltage EN (Ex e II)	550 V
Nominal current (Ex e II)	22 A
Nominal current (Ex e II) with jumper	20 A
Rated current (2)	32 A
Approval	600 V, 20 A ; 600 V, 20 A
Nominal cross section	2.5 mm <sup>2</sup>

#### Connection Data

Solid conductor	0.25 ... 4 mm <sup>2</sup> / 22 ... 12 AWG
Solid conductor, push-in termination	0.75 ... 4 mm <sup>2</sup> / 18 ... 12 AWG
Fine-stranded conductor	0.25 ... 4 mm <sup>2</sup> / 22 ... 12 AWG
Fine-stranded conductor with ferrule, push-in termination, min.	0.75 mm <sup>2</sup> / 18 AWG
Strip length	10 ... 12 mm / 0.39 ... 0.47 inch
Terminal block width	5.2 mm / 0.205 inch
Insulation material	Polyamide 66 (PA 66)

#### Note:

An end plate must be applied when changing from a 3-conductor terminal block to a 4-conductor terminal block and vice versa.

#### Accessories (Selection)

Push-in type jumper bar, insulated, I <sub>n</sub> 25 A, light gray
End and intermediate plate, 0.8 mm thick
WMB Inline, plain, 1,500 WMB markers (5 mm) per reel, 5 ... 5.2 mm stretchable
Marking strip, plain, 11 mm wide, 50 m reel
Modular TOPJOB® S connector, for jumper contact slot, snaps together

	Item No.	Page
2-way	2002-402	165
orange	2002-6392	166
white	2009-115	780
white	2009-110	783
gray	2002-511	157

Additional colors, visit [www.wago.com](http://www.wago.com)

Accessories (jumpers, end plates, test plugs, etc.), see page 165

Carrier rails and tools, see Section 13

Appropriate marking system, WMB/WMB Inline/markings strips, see Full Line Catalog, Volume 6

Information on hazardous locations, see Section 14

Approvals and corresponding ratings, visit [www.wago.com](http://www.wago.com)

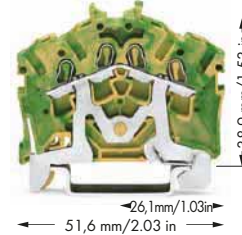
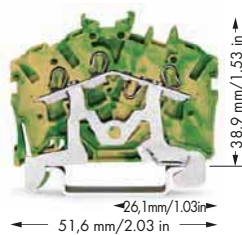
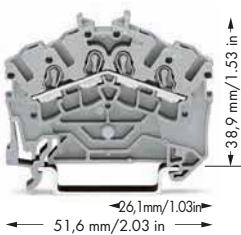

4-conductor through terminal block		
Color	Item No.	Pack. Unit
gray ☺	2002-6401	100
blue ☺	2002-6404	100

3-conductor ground terminal block		
Color	Item No.	Pack. Unit
green-yellow ☺	2002-6307	100

4-conductor ground terminal block		
Color	Item No.	Pack. Unit
green-yellow ☺	2002-6407	100

3-conductor shield terminal block		
Color	Item No.	Pack. Unit
white	2002-6308	100



IEC/EN 60947-7-1
800 V
8 kV
24 A
550 V
22 A
20 A
32 A
600 V, 20 A ; 600 V, 20 A
2.5 mm <sup>2</sup>

IEC/EN 60947-7-2
2.5 mm <sup>2</sup>

IEC/EN 60947-7-2
2.5 mm <sup>2</sup>

0.25 ... 4 mm <sup>2</sup> / 22 ... 12 AWG
0.75 ... 4 mm <sup>2</sup> / 18 ... 12 AWG
0.25 ... 4 mm <sup>2</sup> / 22 ... 12 AWG
0.75 mm <sup>2</sup> / 18 AWG

0.25 ... 4 mm <sup>2</sup> / 22 ... 12 AWG
0.75 ... 4 mm <sup>2</sup> / 18 ... 12 AWG
0.25 ... 4 mm <sup>2</sup> / 22 ... 12 AWG
0.75 mm <sup>2</sup> / 18 AWG

0.25 ... 4 mm <sup>2</sup> / 22 ... 12 AWG
0.75 ... 4 mm <sup>2</sup> / 18 ... 12 AWG
0.25 ... 4 mm <sup>2</sup> / 22 ... 12 AWG
0.75 mm <sup>2</sup> / 18 AWG

10 ... 12 mm / 0.39 ... 0.47 inch
5.2 mm / 0.205 inch
Polyamide 66 (PA 66)

10 ... 12 mm / 0.39 ... 0.47 inch
5.2 mm / 0.205 inch
Polyamide 66 (PA 66)

10 ... 12 mm / 0.39 ... 0.47 inch
5.2 mm / 0.205 inch
Polyamide 66 (PA 66)

**Notice:** This terminal block cannot be commoned with push-in type jumper bars. An end plate must be applied when changing from a 3-conductor terminal block to a 4-conductor terminal block and vice versa.

An end plate must be applied when changing from a 3-conductor terminal block to a 4-conductor terminal block and vice versa.

**Notice:** This terminal block cannot be commoned with push-in type jumper bars. An end plate must be applied when changing from a 3-conductor terminal block to a 4-conductor terminal block and vice versa.

	Item No.	Page
2-way	2002-402	165
orange	2002-6392	166
white	2009-115	780
white	2009-110	783
gray	2002-511	157

	Item No.	Page
2-way	2002-402	165
orange	2002-6392	166
white	2009-115	780
white	2009-110	783
gray	2002-511	157

	Item No.	Page
orange	2002-6392	166
white	2009-115	780
white	2009-110	783



## TOPJOB® S

### Through and Ex Terminal Blocks

#### 4 (6) mm<sup>2</sup>, 2004 Series

1



Through terminal blocks with a blue insulated housing are suitable for Ex i applications.



All through and ground conductor terminal blocks are suitable for Ex e II applications.

Rail-mount terminal blocks with an Ex mark are suitable for Ex e II applications. Terminal blocks with a blue insulated housing are suitable for Ex i applications.

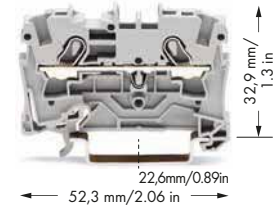

#### 2-conductor through terminal block

Color	Item No.	Pack. Unit
gray ☉	2004-1201	50
blue ☉	2004-1204	50



#### Technical Data

Ratings per	IEC/EN 60947-7-1
Rated voltage (III / 3)	800 V
Rated surge voltage (III / 3)	8 kV
Rated current	32 A
Rated voltage EN (Ex e II)	550 V
Nominal current (Ex e II)	30 A
Rated current (2)	41 A
Approval	600 V, 30 A ; 600 V, 30 A
Nominal cross section	4 mm <sup>2</sup>
<b>Connection Data</b>	
Solid conductor	0.5 ... 6 mm <sup>2</sup> / 20 ... 10 AWG
Solid conductor, push-in termination	1 ... 6 mm <sup>2</sup> / 14 ... 10 AWG
Fine-stranded conductor	0.5 ... 6 mm <sup>2</sup> / 20 ... 10 AWG
Fine-stranded conductor with ferrule, push-in termination, min.	0.75 mm <sup>2</sup> / 18 AWG
Strip length	11 ... 13 mm / 0.43 ... 0.51 inch
Terminal block width	6.2 mm / 0.244 inch
Insulation material	Polyamide 66 (PA 66)

#### Accessories (Selection)

	Item No.	Page
Push-in type jumper bar, insulated, I <sub>n</sub> 32 A, light gray	2004-402	169
End and intermediate plate, 1 mm thick	orange 2004-1292	169
WMB Multi marking system, white, 10 strips with 10 markers per card, 5 ... 5.2 mm stretchable	plain 793-5501	780
Marking strip, plain, 11 mm wide, 50 m reel	white 2009-110	783
Modular TOPJOB® S connector, for jumper contact slot, snaps together	gray 2004-511	158

Additional colors, visit [www.wago.com](http://www.wago.com)

Accessories (jumpers, end plates, test plugs, etc.), see page 169

Carrier rails and tools, see Section 13

Appropriate marking system, WMB/WMB Inline/markings strips, see Full Line Catalog, Volume 6

Information on hazardous locations, see Section 14

Approvals and corresponding ratings, visit [www.wago.com](http://www.wago.com)

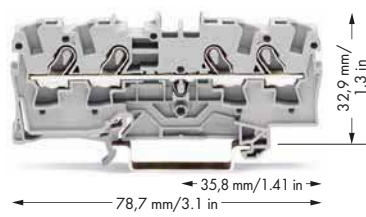
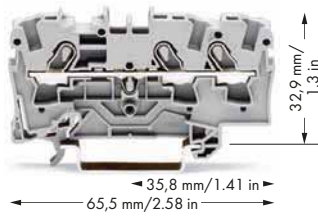

**3-conductor through terminal block**

Color	Item No.	Pack. Unit
gray ☉	2004-1301	50
blue ☉	2004-1304	50



IEC/EN 60947-7-1
800 V
8 kV
32 A
550 V
30 A
41 A
600 V, 30 A ; 600 V, 30 A
4 mm <sup>2</sup>
0.5 ... 6 mm <sup>2</sup> / 20 ... 10 AWG
1 ... 6 mm <sup>2</sup> / 14 ... 10 AWG
0.5 ... 6 mm <sup>2</sup> / 20 ... 10 AWG
0.75 mm <sup>2</sup> / 18 AWG
11 ... 13 mm / 0.43 ... 0.51 inch
6.2 mm / 0.244 inch
Polyamide 66 (PA 66)

	Item No.	Page
2-way	2004-402	169
orange	2004-1392	169
plain	793-5501	780
white	2009-110	783
gray	2004-511	158

**4-conductor through terminal block**

Color	Item No.	Pack. Unit
gray ☉	2004-1401	50
blue ☉	2004-1404	50



IEC/EN 60947-7-1
800 V
8 kV
32 A
550 V
30 A
41 A
600 V, 30 A ; 600 V, 30 A
4 mm <sup>2</sup>
0.5 ... 6 mm <sup>2</sup> / 20 ... 10 AWG
1 ... 6 mm <sup>2</sup> / 14 ... 10 AWG
0.5 ... 6 mm <sup>2</sup> / 20 ... 10 AWG
0.75 mm <sup>2</sup> / 18 AWG
11 ... 13 mm / 0.43 ... 0.51 inch
6.2 mm / 0.244 inch
Polyamide 66 (PA 66)

	Item No.	Page
2-way	2004-402	169
orange	2004-1492	170
plain	793-5501	780
white	2009-110	783
gray	2004-511	158

# TOPJOB® S

## Ground/Shield Conductor and Ex Terminal Blocks

### 4 (6) mm<sup>2</sup>, 2004 Series

1

Rail-mount terminal blocks with an Ex mark are suitable for Ex e II applications.

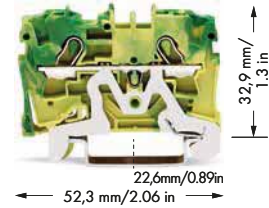

2-conductor ground terminal block		
Color	Item No.	Pack. Unit
● green-yellow ☉	2004-1207	50



#### Technical Data

Ratings per	IEC/EN 60947-7-2
Nominal cross section	4 mm <sup>2</sup>
<b>Connection Data</b>	
Solid conductor	0.5 ... 6 mm <sup>2</sup> / 20 ... 10 AWG
Solid conductor, push-in termination	1 ... 6 mm <sup>2</sup> / 14 ... 10 AWG
Fine-stranded conductor	0.5 ... 6 mm <sup>2</sup> / 20 ... 10 AWG
Fine-stranded conductor with ferrule, push-in termination, min.	0.75 mm <sup>2</sup> / 18 AWG
Strip length	11 ... 13 mm / 0.43 ... 0.51 inch
Terminal block width	6.2 mm / 0.244 inch
Insulation material	Polyamide 66 (PA 66)

#### Accessories (Selection)

	Item No.	Page
Push-in type jumper bar, insulated, I <sub>N</sub> 32 A, light gray	2004-402	169
End and intermediate plate, 1 mm thick	orange 2004-1292	169
WMB Multi marking system, white, 10 strips with 10 markers per card, 5 ... 5.2 mm stretchable	plain 793-5501	780
Marking strip, plain, 11 mm wide, 50 m reel	white 2009-110	783
Modular TOPJOB® S connector, for jumper contact slot, snaps together	gray 2004-511	158

📖 Accessories (jumpers, end plates, test plugs, etc.), see page 169

📖 Carrier rails and tools, see Section 13

📖 Appropriate marking system, WMB/WMB Inline/markings strips, see Full Line Catalog, Volume 6

📖 Information on hazardous locations, see Section 14

📖 Approvals and corresponding ratings, visit [www.wago.com](http://www.wago.com)

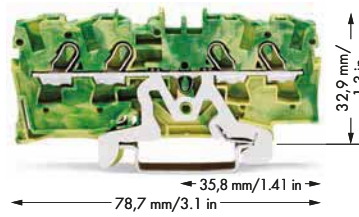
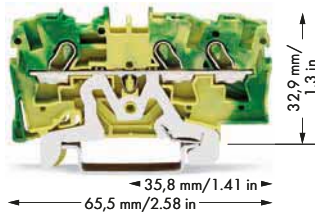

3-conductor ground terminal block		
Color	Item No.	Pack. Unit
● green-yellow ☉	2004-1307	50

4-conductor ground terminal block		
Color	Item No.	Pack. Unit
● green-yellow ☉	2004-1407	50

4-conductor shield terminal block		
Color	Item No.	Pack. Unit
○ white	2004-1408	50



IEC/EN 60947-7-2
4 mm <sup>2</sup>
0.5 ... 6 mm <sup>2</sup> / 20 ... 10 AWG
1 ... 6 mm <sup>2</sup> / 14 ... 10 AWG
0.5 ... 6 mm <sup>2</sup> / 20 ... 10 AWG
0.75 mm <sup>2</sup> / 18 AWG
11 ... 13 mm / 0.43 ... 0.51 inch
6.2 mm / 0.244 inch
Polyamide 66 (PA 66)

IEC/EN 60947-7-2
4 mm <sup>2</sup>
0.5 ... 6 mm <sup>2</sup> / 20 ... 10 AWG
1 ... 6 mm <sup>2</sup> / 14 ... 10 AWG
0.5 ... 6 mm <sup>2</sup> / 20 ... 10 AWG
0.75 mm <sup>2</sup> / 18 AWG
11 ... 13 mm / 0.43 ... 0.51 inch
6.2 mm / 0.244 inch
Polyamide 66 (PA 66)

	Item No.	Page
2-way	2004-402	169
orange	2004-1392	169
plain	793-5501	780
white	2009-110	783
gray	2004-511	158

	Item No.	Page
2-way	2004-402	169
orange	2004-1492	170
plain	793-5501	780
white	2009-110	783
gray	2004-511	158

## TOPJOB® S

### Through/Ground/Shield Conductor and Ex Terminal Blocks

#### 6 (10) mm<sup>2</sup>, 2006 Series

1



Cover (2006-191) seals unused conductor entry.

Rail-mount terminal blocks with an Ex mark are suitable for Ex e II applications. Terminal blocks with a blue insulated housing are suitable for Ex i applications.

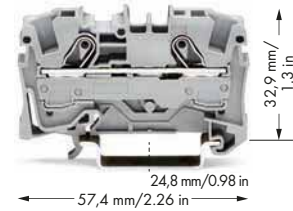

2-conductor through terminal block		
Color	Item No.	Pack. Unit
gray ☉	2006-1201	50
blue ☉	2006-1204	50



#### Technical Data

Ratings per	IEC/EN 60947-7-1
Rated voltage (III / 3)	800 V
Rated surge voltage (III / 3)	8 kV
Rated current	41 A
Rated voltage EN (Ex e II)	550 V
Nominal current (Ex e II)	38 A
Nominal current (Ex e II) with jumper	33 A
Rated current (2)	57 A
Approval	600 V, 50 A ; 600 V, 50 A
Nominal cross section	6 mm <sup>2</sup>
<b>Connection Data</b>	
Solid conductor	0.5 ... 10 mm <sup>2</sup> / 20 ... 8 AWG
Solid conductor, push-in termination	1 ... 10 mm <sup>2</sup> / 14 ... 8 AWG
Fine-stranded conductor	0.5 ... 10 mm <sup>2</sup> / 20 ... 8 AWG
Fine-stranded conductor with ferrule, push-in termination, min.	1.5 mm <sup>2</sup> / 16 AWG
Strip length	13 ... 15 mm / 0.51 ... 0.59 inch
Terminal block width	7.5 mm / 0.295 inch
Insulation material	Polyamide 66 (PA 66)

#### Accessories (Selection)

Push-in type jumper bar, insulated, I <sub>n</sub> 41 A, light gray
End and intermediate plate, 1 mm thick
WMB Multi marking system, white, 10 strips with 10 markers per card, 5 ... 5.2 mm stretchable
Marking strip, plain, 11 mm wide, 50 m reel
Modular TOPJOB® S connector, for jumper contact slot, snaps together

	Item No.	Page
2-way	2006-402	171
orange	2006-1292	171
plain	793-5501	780
white	2009-110	783
gray	2006-511	159

Additional colors, visit [www.wago.com](http://www.wago.com)

Accessories (jumpers, end plates, test plugs, etc.), see page 171

Carrier rails and tools, see Section 13

Appropriate marking system, WMB/WMB Inline/marketing strips, see Full Line Catalog, Volume 6

Information on hazardous locations, see Section 14

Approvals and corresponding ratings, visit [www.wago.com](http://www.wago.com)

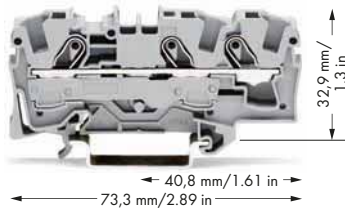

3-conductor through terminal block		
Color	Item No.	Pack. Unit
gray ☺	2006-1301	25
blue ☺	2006-1304	25

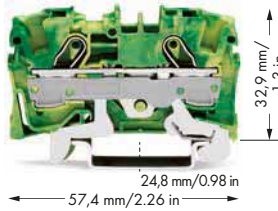

2-conductor ground terminal block		
Color	Item No.	Pack. Unit
green-yellow ☺	2006-1207	50

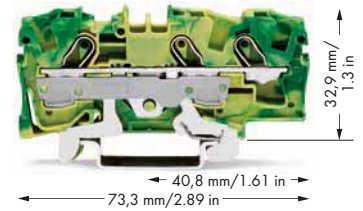

3-conductor ground terminal block		
Color	Item No.	Pack. Unit
green-yellow ☺	2006-1307	25

2-conductor shield terminal block		
Color	Item No.	Pack. Unit
white	2006-1208	50



IEC/EN 60947-7-1
800 V
8 kV
41 A
550 V
36 A
33 A
57 A
600 V, 50 A ; 600 V, 50 A
6 mm <sup>2</sup>
0.5 ... 10 mm <sup>2</sup> / 20 ... 8 AWG
1 ... 10 mm <sup>2</sup> / 14 ... 8 AWG
0.5 ... 10 mm <sup>2</sup> / 20 ... 8 AWG
1.5 mm <sup>2</sup> / 16 AWG
13 ... 15 mm / 0.51 ... 0.59 inch
7.5 mm / 0.295 inch
Polyamide 66 (PA 66)

IEC/EN 60947-7-2
6 mm <sup>2</sup>
0.5 ... 10 mm <sup>2</sup> / 20 ... 8 AWG
1 ... 10 mm <sup>2</sup> / 14 ... 8 AWG
0.5 ... 10 mm <sup>2</sup> / 20 ... 8 AWG
1.5 mm <sup>2</sup> / 16 AWG
13 ... 15 mm / 0.51 ... 0.59 inch
7.5 mm / 0.295 inch
Polyamide 66 (PA 66)

IEC/EN 60947-7-2
6 mm <sup>2</sup>
0.5 ... 10 mm <sup>2</sup> / 20 ... 8 AWG
1 ... 10 mm <sup>2</sup> / 14 ... 8 AWG
0.5 ... 10 mm <sup>2</sup> / 20 ... 8 AWG
1.5 mm <sup>2</sup> / 16 AWG
13 ... 15 mm / 0.51 ... 0.59 inch
7.5 mm / 0.295 inch
Polyamide 66 (PA 66)

	Item No.	Page
2-way	2006-402	171
orange	2006-1392	171
plain	793-5501	780
white	2009-110	783
gray	2006-511	159

	Item No.	Page
2-way	2006-402	171
orange	2006-1292	171
plain	793-5501	780
white	2009-110	783
gray	2006-511	159

	Item No.	Page
2-way	2006-402	171
orange	2006-1392	171
plain	793-5501	780
white	2009-110	783
gray	2006-511	159



## TOPJOB® S

### Through/Ground/Shield Conductor and Ex Terminal Blocks

#### 10 (16) mm<sup>2</sup>, 2010 Series

1

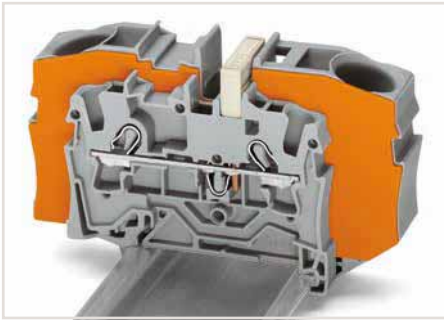

#### Commoning with step-down jumpers:

An end plate must be inserted between the terminal blocks to be commoned. Step-down jumpers (2016-499) common 16/10 mm<sup>2</sup> (16/8 AWG) terminal blocks (2016/2010 Series) with 10/6/4/2.5 mm<sup>2</sup> (8/10/12/14 AWG) terminal blocks (2010/2006/2004/2002 Series).

Step-down jumpers are simply pushed down for full insertion, similar to other push-in type jumper bars.

#### Note:

The total current of the outgoing circuits shall not exceed the nominal current of the step-down jumper/push-in type jumper bar.

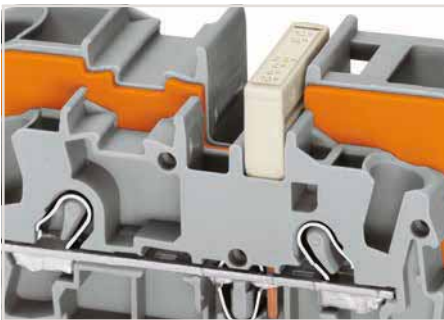

Commoning with a step-down jumper.

Rail-mount terminal blocks with an Ex mark are suitable for Ex e II applications. Terminal blocks with a blue insulated housing are suitable for Ex i applications.

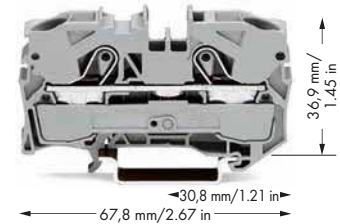

#### 2-conductor through terminal block

Color	Item No.	Pack. Unit
gray ☉	2010-1201	25
blue ☉	2010-1204	25



#### Technical Data

Ratings per	IEC/EN 60947-7-1
Rated voltage (III / 3)	800 V
Rated surge voltage (III / 3)	8 kV
Rated current	57 A
Rated voltage EN (Ex e II)	550 V
Nominal current (Ex e II)	51 A
Rated current (2)	76 A
Approval	600 V, 65 A  600 V, 65 A
Nominal cross section	10 mm <sup>2</sup>
<b>Connection Data</b>	
Solid conductor	0.5 ... 16 mm <sup>2</sup> / 20 ... 6 AWG
Solid conductor, push-in termination	2.5 ... 16 mm <sup>2</sup> / 14 ... 6 AWG
Fine-stranded conductor	0.5 ... 16 mm <sup>2</sup> / 20 ... 6 AWG
Fine-stranded conductor with ferrule, push-in termination, min.	2.5 mm <sup>2</sup> / 14 AWG
Strip length	17 ... 19 mm / 0.67 ... 0.91 inch
Terminal block width	10 mm / 0.394 inch
Insulation material	Polyamide 66 (PA 66)

#### Accessories (Selection)

Push-in type jumper bar, insulated, I <sub>n</sub> 57 A, light gray
End and intermediate plate, 1 mm thick
WMB Multi marking system, white, 10 strips with 10 markers per card, 5 ... 5.2 mm stretchable
Marking strip, plain, 11 mm wide, 50 m reel
Modular TOPJOB® S connector, for jumper contact slot, snaps together

	Item No.	Page
2-way	2010-402	173
orange	2010-1292	173
plain	793-5501	780
white	2009-110	783
gray	2010-511	159

Additional colors, visit [www.wago.com](http://www.wago.com)

Accessories (jumpers, end plates, test plugs, etc.), see page 173

Carrier rails and tools, see Section 13

Appropriate marking system, WMB/WMB Inline/markings strips, see Full Line Catalog, Volume 6

Information on hazardous locations, see Section 14

Approvals and corresponding ratings, visit [www.wago.com](http://www.wago.com)

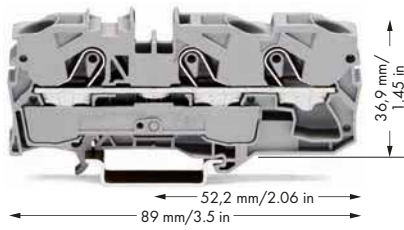

3-conductor through terminal block		
Color	Item No.	Pack. Unit
gray ☉	2010-1301	25
blue ☉	2010-1304	25

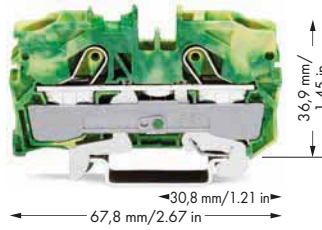

2-conductor ground terminal block		
Color	Item No.	Pack. Unit
green-yellow ☉	2010-1207	25

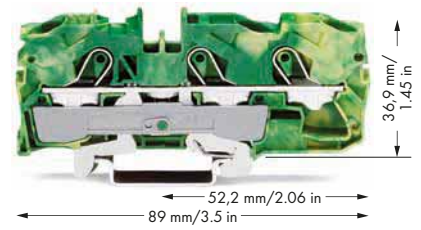

3-conductor ground terminal block		
Color	Item No.	Pack. Unit
green-yellow ☉	2010-1307	25

2-conductor shield terminal block		
Color	Item No.	Pack. Unit
white	2010-1208	25



IEC/EN 60947-7-1
800 V
8 kV
57 A
550 V
50 A
76 A
600 V, 65 A ; 600 V, 65 A
10 mm²
0.5 ... 16 mm² / 20 ... 6 AWG
2.5 ... 16 mm² / 14 ... 6 AWG
0.5 ... 16 mm² / 20 ... 6 AWG
2.5 mm² / 14 AWG
17 ... 19 mm / 0.67 ... 0.91 inch
10 mm / 0.394 inch
Polyamide 66 (PA 66)

IEC/EN 60947-7-2
10 mm²
0.5 ... 16 mm² / 20 ... 6 AWG
2.5 ... 16 mm² / 14 ... 6 AWG
0.5 ... 16 mm² / 20 ... 6 AWG
2.5 mm² / 14 AWG
17 ... 19 mm / 0.67 ... 0.91 inch
10 mm / 0.394 inch
Polyamide 66 (PA 66)

IEC/EN 60947-7-2
10 mm²
0.5 ... 16 mm² / 20 ... 6 AWG
2.5 ... 16 mm² / 14 ... 6 AWG
0.5 ... 16 mm² / 20 ... 6 AWG
2.5 mm² / 14 AWG
17 ... 19 mm / 0.67 ... 0.91 inch
10 mm / 0.394 inch
Polyamide 66 (PA 66)

	Item No.	Page
2-way	2010-402	173
orange	2010-1392	173
plain	793-5501	780
white	2009-110	783
gray	2010-511	159

	Item No.	Page
2-way	2010-402	173
orange	2010-1292	173
plain	793-5501	780
white	2009-110	783
gray	2010-511	159

	Item No.	Page
2-way	2010-402	173
orange	2010-1392	173
plain	793-5501	780
white	2009-110	783
gray	2010-511	159

## TOPJOB® S

### Through/Ground/Shield Conductor and Ex Terminal Blocks

#### 16 (25 "f") mm<sup>2</sup>, 2016 Series

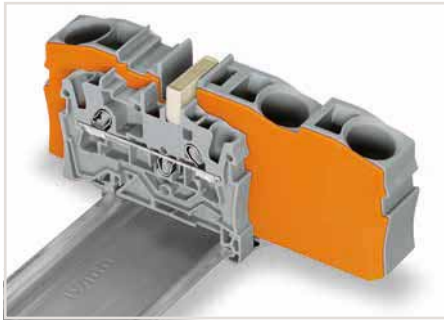

Step-down jumpers connect terminal blocks of different sizes, without losing a conductor clamping point. This can be beneficial on long conductor runs where voltage drop can be a problem. A large conductor can be easily connected to smaller conductors at the distribution point.

Commoning may be made in either direction using the special thin end plate to cover the open side. Additional through terminal blocks having a smaller cross-section may be commoned using push-in type jumper bars.

Rail-mount terminal blocks with an Ex mark are suitable for Ex e II applications. Terminal blocks with a blue insulated housing are suitable for Ex i applications.

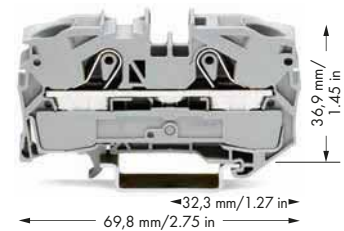

2-conductor through terminal block		
Color	Item No.	Pack. Unit
gray ☉	2016-1201	20
blue ☉	2016-1204	20



Finger guard seals unused conductor entry.

#### Technical Data

Ratings per	IEC/EN 60947-7-1
Rated voltage (III / 3)	800 V
Rated surge voltage (III / 3)	8 kV
Rated current	76 A
Rated voltage EN (Ex e II)	550 V
Nominal current (Ex e II)	70 A
Nominal current (Ex e II) with jumper	67 A
Rated current (2)	90 A
Approval	600 V, 85 A ; 600 V, 85 A
Nominal cross section	16 mm <sup>2</sup>
<b>Connection Data</b>	
Solid conductor	0.5 ... 16 mm <sup>2</sup> / 20 ... 6 AWG
Solid conductor, push-in termination	2.5 ... 16 mm <sup>2</sup> / 14 ... 6 AWG
Fine-stranded conductor	0.5 ... 25 mm <sup>2</sup> / 20 ... 4 AWG
Fine-stranded conductor with ferrule, push-in termination, min.	2.5 mm <sup>2</sup> / 14 AWG
Strip length	18 ... 20 mm / 0.71 ... 0.79 inch
Terminal block width	12 mm / 0.472 inch
Insulation material	Polyamide 66 (PA 66)

#### Note:

#### Accessories (Selection)

Push-in type jumper bar, insulated, I <sub>N</sub> 76 A, light gray	
End and intermediate plate, 1 mm thick	
WMB Multi marking system, white, 10 strips with 10 markers per card, 5 ... 5.2 mm stretchable	
Marking strip, plain, 11 mm wide, 50 m reel	
Modular TOPJOB® S connector, for jumper contact slot, snaps together	

	Item No.	Page
2-way	2016-402	174
orange	2016-1292	174
plain	793-5501	780
white	2009-110	783
gray	2016-511	159

Additional colors, visit [www.wago.com](http://www.wago.com)

Accessories (jumpers, end plates, test plugs, etc.), see page 174

Carrier rails and tools, see Section 13

Appropriate marking system, WMB/WMB Inline/markings strips, see Full Line Catalog, Volume 6

Information on hazardous locations, see Section 14

Approvals and corresponding ratings, visit [www.wago.com](http://www.wago.com)

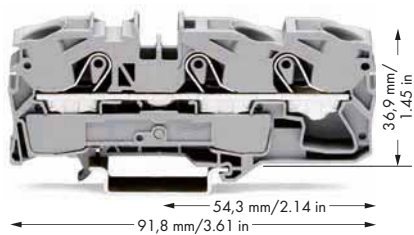

3-conductor through terminal block		
Color	Item No.	Pack. Unit
gray ☺	2016-1301	20
blue ☺	2016-1304	20

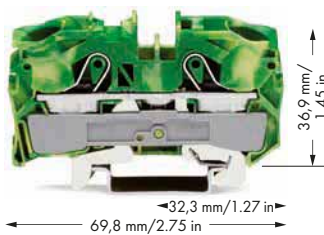

2-conductor ground terminal block		
Color	Item No.	Pack. Unit
green-yellow ☺	2016-1207	20

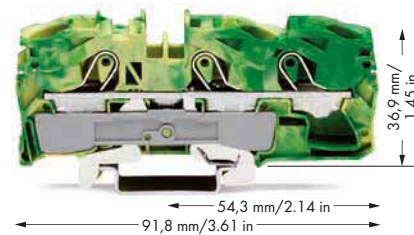

3-conductor ground terminal block		
Color	Item No.	Pack. Unit
green-yellow ☺	2016-1307	20

2-conductor shield terminal block		
Color	Item No.	Pack. Unit
white	2016-1208	20



IEC/EN 60947-7-1
800 V
8 kV
76 A
550 V
67 A
65 A
90 A
600 V, 85 A  600 V, 85 A
16 mm²
0.5 ... 16 mm² / 20 ... 6 AWG
2.5 ... 16 mm² / 14 ... 6 AWG
0.5 ... 25 mm² / 20 ... 4 AWG
2.5 mm² / 14 AWG
18 ... 20 mm / 0.71 ... 0.79 inch
12 mm / 0.472 inch
Polyamide 66 (PA 66)

IEC/EN 60947-7-2
16 mm²
0.5 ... 16 mm² / 20 ... 6 AWG
2.5 ... 16 mm² / 14 ... 6 AWG
0.5 ... 25 mm² / 20 ... 4 AWG
2.5 mm² / 14 AWG
18 ... 20 mm / 0.71 ... 0.79 inch
12 mm / 0.472 inch
Polyamide 66 (PA 66)
15 mm high DIN-35 rails shall be used for a current load higher than 76 A!

IEC/EN 60947-7-2
16 mm²
0.5 ... 16 mm² / 20 ... 6 AWG
2.5 ... 16 mm² / 14 ... 6 AWG
0.5 ... 25 mm² / 20 ... 4 AWG
2.5 mm² / 14 AWG
18 ... 20 mm / 0.71 ... 0.79 inch
12 mm / 0.472 inch
Polyamide 66 (PA 66)
15 mm high DIN-35 rails shall be used for a current load higher than 76 A!

	Item No.	Page
2-way	2016-402	174
orange	2016-1392	174
plain	793-5501	780
white	2009-110	783
gray	2016-511	159

	Item No.	Page
2-way	2016-402	174
orange	2016-1292	174
plain	793-5501	780
white	2009-110	783
gray	2016-511	159

	Item No.	Page
2-way	2016-402	174
orange	2016-1392	174
plain	793-5501	780
white	2009-110	783
gray	2016-511	159

# TOPJOB® S

## Double-Deck Terminal Blocks

### 1 (1.5) mm<sup>2</sup>, 2000 Series

1



Double-deck terminal block with double-deck marker carrier (2000-2231)



Double-deck terminal block without double-deck marker carrier (2000-2201)

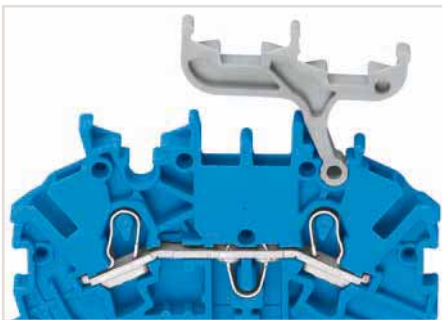

**Double-Deck Terminal Blocks**  
A double-deck marker carrier (2000-121) can be retrofitted to double-deck terminal blocks without a marker carrier.

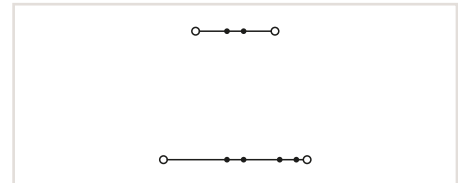
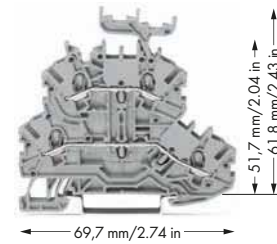

Double-deck terminal block, through/through terminal block, with marker carrier

	Item No.	Pack. Unit
○ L/L	2000-2231	50
○ N/L	2000-2232	50
○ L/N	2000-2233	50
● N/N	2000-2234	50

Double-deck terminal block, through/through terminal block, no marker carrier

	Item No.	Pack. Unit
○ L/L	2000-2201	50
○ N/L	2000-2202	50
○ L/N	2000-2203	50
● N/N	2000-2204	50



#### Technical Data

Ratings per	IEC/EN 60947-7-1
Rated voltage (III / 3)	500 V
Rated surge voltage (III / 3)	6 kV
Rated current	13.5 A
Rated current (2)	18 A
Approval	600 V, 10 A ; 600 V, 10 A
Nominal cross section	1 mm <sup>2</sup>
<b>Connection Data</b>	
Solid conductor	0.14 ... 1.5 mm <sup>2</sup> / 24 ... 16 AWG
Solid conductor, push-in termination	0.5 ... 1.5 mm <sup>2</sup> / 20 ... 16 AWG
Fine-stranded conductor	0.14 ... 1.5 mm <sup>2</sup> / 24 ... 16 AWG
Fine-stranded conductor with ferrule, push-in termination, min.	0.5 mm <sup>2</sup> / 20 AWG
Strip length	9 ... 11 mm / 0.35 ... 0.43 inch
Terminal block width	3.5 mm / 0.138 inch
Insulation material	Polyamide 66 (PA 66)

#### Accessories (Selection)

Push-in type jumper bar, insulated, I <sub>N</sub> 14 A, light gray	2-way	2000-402	160
End and intermediate plate, 0.7 mm thick	orange	2000-2292	161
WMB Multi marking system, white, 10 strips with 10 markers per card, for 3.5 mm terminal block width	plain	793-3501	780
Marking strip, plain, 11 mm wide, 50 m reel	white	2009-110	783

Accessories (jumpers, end plates, test plugs, etc.), see page 160

Carrier rails and tools, see Section 13

Appropriate marking system, WMB/markings strips, see Full Line Catalog, Volume 6

Approvals and corresponding ratings, visit [www.wago.com](http://www.wago.com)

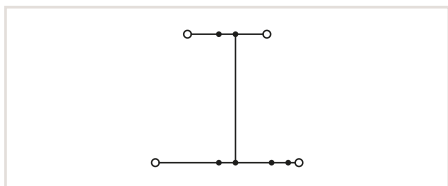
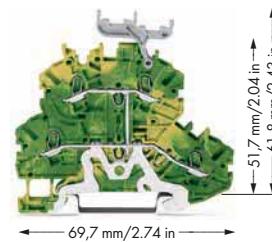
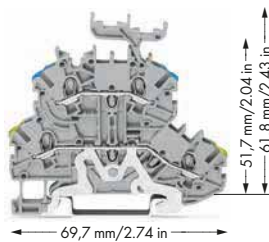
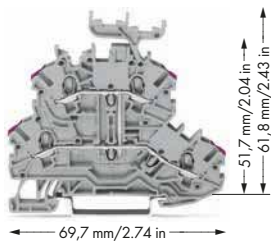

Double-deck terminal block, 4-conductor through terminal block, with marker carrier, internally commoned, violet conductor entry

	Item No.	Pack. Unit
○ L	2000-2238	50
● N	2000-2239	50

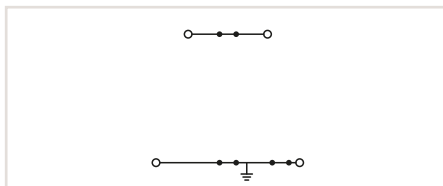

Double-deck terminal block, ground conductor/through terminal block, with marker carrier

	Item No.	Pack. Unit
○ PE/N	2000-2247	50
○ PE/L	2000-2257	50
○ Shield/N	2000-2248	50
○ Shield/L	2000-22 58	50

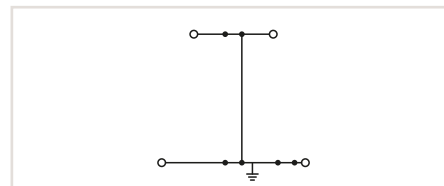

Double-deck terminal block, 4-conductor ground terminal block, with marker carrier, internally commoned

	Item No.	Pack. Unit
● PE	2000-2237	50

Double-deck terminal block, 4-conductor through terminal block, no marker carrier, internally commoned, violet conductor entry

	Item No.	Pack. Unit
○ L	2000-2208	50
● N	2000-2209	50

Double-deck terminal block, ground conductor/through terminal block, no marker carrier

	Item No.	Pack. Unit
○ PE/N	2000-2217	50
○ PE/L	2000-2227	50
○ Shield/N	2000-2218	50
○ Shield/L	2000-2228	50

Double-deck terminal block, 4-conductor ground terminal block, no marker carrier, internally commoned

	Item No.	Pack. Unit
● PE	2000-2207	50



IEC/EN 60947-7-1
500 V
6 kV
13.5 A
18 A
600 V, 10 A ; 600 V, 10 A
1 mm <sup>2</sup>
0.14 ... 1.5 mm <sup>2</sup> / 24 ... 16 AWG
0.5 ... 1.5 mm <sup>2</sup> / 20 ... 16 AWG
0.14 ... 1.5 mm <sup>2</sup> / 24 ... 16 AWG
0.5 mm <sup>2</sup> / 20 AWG
9 ... 11 mm / 0.35 ... 0.43 inch
3.5 mm / 0.138 inch
Polyamide 66 (PA 66)

	Item No.	Page
2-way	2000-402	160
orange	2000-2292	161
plain	793-3501	780
white	2009-110	783



IEC/EN 60947-7-1
500 V
6 kV
13.5 A
18 A
600 V, 10 A ; 600 V, 10 A
1 mm <sup>2</sup>
0.14 ... 1.5 mm <sup>2</sup> / 24 ... 16 AWG
0.5 ... 1.5 mm <sup>2</sup> / 20 ... 16 AWG
0.14 ... 1.5 mm <sup>2</sup> / 24 ... 16 AWG
0.5 mm <sup>2</sup> / 20 AWG
9 ... 11 mm / 0.35 ... 0.43 inch
3.5 mm / 0.138 inch
Polyamide 66 (PA 66)

	Item No.	Page
2-way	2000-402	160
orange	2000-2292	161
plain	793-3501	780
white	2009-110	783



IEC/EN 60947-7-2
1 mm <sup>2</sup>
0.14 ... 1.5 mm <sup>2</sup> / 24 ... 16 AWG
0.5 ... 1.5 mm <sup>2</sup> / 20 ... 16 AWG
0.14 ... 1.5 mm <sup>2</sup> / 24 ... 16 AWG
0.5 mm <sup>2</sup> / 20 AWG
9 ... 11 mm / 0.35 ... 0.43 inch
3.5 mm / 0.138 inch
Polyamide 66 (PA 66)

	Item No.	Page
2-way	2000-402	160
orange	2000-2292	161
plain	793-3501	780
white	2009-110	783



# TOPJOB® S

## Double-Deck Terminal Blocks with End Plate, 800 V

### 1 (1.5) mm<sup>2</sup>, 2000 Series

1



Double-deck terminal block with double-deck marker carrier (2000-2231/099-000)



Double-deck terminal block without double-deck marker carrier (2000-2201/099-000)



**Double-Deck Terminal Blocks**  
A double-deck marker carrier (2000-121) can be retrofitted to double-deck terminal blocks without a marker carrier.

A protective warning marker and an insulation stop must be applied individually. Due to the 4.2 mm width of double-deck terminal blocks, 2001 Series Push-In Type Jumper Bars must be used.

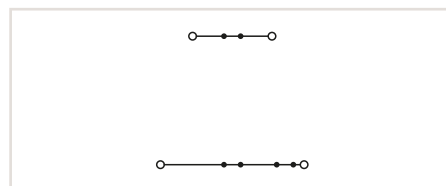
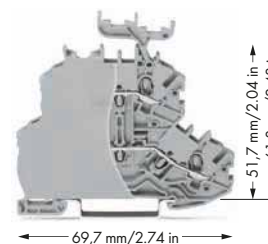

Double-deck terminal block, through/through terminal block, with marker carrier

	Item No.	Pack. Unit
○ L/L	2000-2231/099-000	50
○ N/L	2000-2232/099-000	50
○ L/N	2000-2233/099-000	50
● N/N	2000-2234/099-000	50

Double-deck terminal block, through/through terminal block, no marker carrier

	Item No.	Pack. Unit
○ L/L	2000-2201/099-000	50
○ N/L	2000-2202/099-000	50
○ L/N	2000-2203/099-000	50
● N/N	2000-2204/099-000	50



**Technical Data**

Ratings per	IEC/EN 60947-7-1
Rated voltage (III / 3)	800 V
Rated surge voltage (III / 3)	8 kV
Rated current	13.5 A
Rated current (2)	18 A
Approval	600 V, 10 A ; 600 V, 10 A
Nominal cross section	1 mm <sup>2</sup>
<b>Connection Data</b>	
Solid conductor	0.14 ... 1.5 mm <sup>2</sup> / 24 ... 16 AWG
Solid conductor, push-in termination	0.5 ... 1.5 mm <sup>2</sup> / 20 ... 16 AWG
Fine-stranded conductor	0.14 ... 1.5 mm <sup>2</sup> / 24 ... 16 AWG
Fine-stranded conductor with ferrule, push-in termination, min.	0.5 mm <sup>2</sup> / 20 AWG
Strip length	9 ... 11 mm / 0.35 ... 0.43 inch
Terminal block width	4.2 mm / 0.165 inch
Insulation material	Polyamide 66 (PA 66)

**Accessories (Selection)**

	Item No.	Page
Push-in type jumper bar, insulated, I <sub>N</sub> 18 A, light gray	2001-402	162
End and intermediate plate, 0.7 mm thick	orange 2000-2292	161
WMB Inline, plain, 2,000 WMB markers (4 mm) per reel, 4 ... 4.2 mm stretchable	white 2009-114	780
Marking strip, plain, 11 mm wide, 50 m reel	white 2009-110	783

- Push-in type jumper bars (2001 Series), see page 162
- Accessories (end plates, etc.), see page 161
- Carrier rails and tools, see Section 13
- Appropriate marking system, WMB/WMB Inline/marketing strips, see Full Line Catalog, Volume 6
- Approvals and corresponding ratings, visit [www.wago.com](http://www.wago.com)

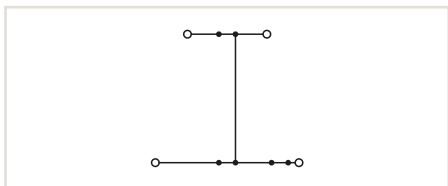
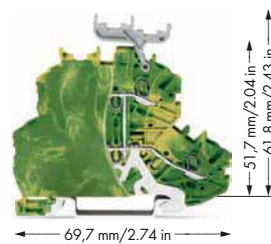
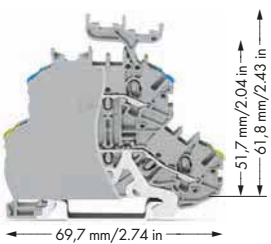
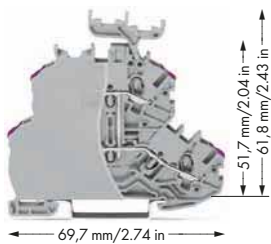

Double-deck terminal block, 4-conductor through terminal block, with marker carrier, internally commoned, violet conductor entry

	Item No.	Pack. Unit
○ L	2000-2238/099-000	50
● N	2000-2239/099-000	50

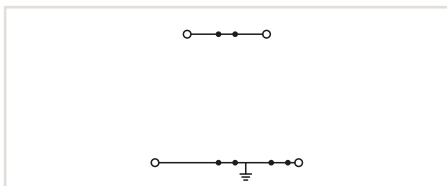

Double-deck terminal block, ground conductor/through terminal block, with marker carrier

	Item No.	Pack. Unit
○ PE/N	2000-2247/099-000	50
○ PE/L	2000-2257/099-000	50
○ Shield/N	2000-2248/099-000	50
○ Shield/L	2000-22 58/099-000	50

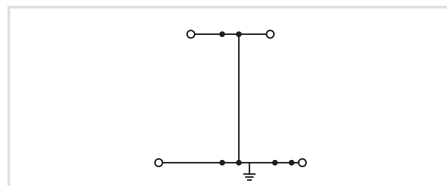

Double-deck terminal block, 4-conductor ground terminal block, with marker carrier, internally commoned

	Item No.	Pack. Unit
● PE	2000-2237/099-000	50

Double-deck terminal block, 4-conductor through terminal block, no marker carrier, internally commoned, violet conductor entry

	Item No.	Pack. Unit
○ L	2000-2208/099-000	50
● N	2000-2209/099-000	50

Double-deck terminal block, ground conductor/through terminal block, no marker carrier

	Item No.	Pack. Unit
○ PE/N	2000-2217/099-000	50
○ PE/L	2000-2227/099-000	50
○ Shield/N	2000-2218/099-000	50
○ Shield/L	2000-2228/099-000	50

Double-deck terminal block, 4-conductor ground terminal block, no marker carrier, internally commoned

	Item No.	Pack. Unit
● PE	2000-2207/099-000	50



IEC/EN 60947-7-1
800 V
8 kV
13.5 A
18 A
600 V, 10 A, ; 600 V, 10 A
1 mm <sup>2</sup>
0.14 ... 1.5 mm <sup>2</sup> / 24 ... 16 AWG
0.5 ... 1.5 mm <sup>2</sup> / 20 ... 16 AWG
0.14 ... 1.5 mm <sup>2</sup> / 24 ... 16 AWG
0.5 mm <sup>2</sup> / 20 AWG
9 ... 11 mm / 0.35 ... 0.43 inch
4.2 mm / 0.165 inch
Polyamide 66 (PA 66)

IEC/EN 60947-7-1
800 V
8 kV
13.5 A
18 A
600 V, 10 A, ; 600 V, 10 A
1 mm <sup>2</sup>
0.14 ... 1.5 mm <sup>2</sup> / 24 ... 16 AWG
0.5 ... 1.5 mm <sup>2</sup> / 20 ... 16 AWG
0.14 ... 1.5 mm <sup>2</sup> / 24 ... 16 AWG
0.5 mm <sup>2</sup> / 20 AWG
9 ... 11 mm / 0.35 ... 0.43 inch
4.2 mm / 0.165 inch
Polyamide 66 (PA 66)

IEC/EN 60947-7-2
800 V
8 kV
13.5 A
18 A
600 V, 10 A, ; 600 V, 10 A
1 mm <sup>2</sup>
0.14 ... 1.5 mm <sup>2</sup> / 24 ... 16 AWG
0.5 ... 1.5 mm <sup>2</sup> / 20 ... 16 AWG
0.14 ... 1.5 mm <sup>2</sup> / 24 ... 16 AWG
0.5 mm <sup>2</sup> / 20 AWG
9 ... 11 mm / 0.35 ... 0.43 inch
4.2 mm / 0.165 inch
Polyamide 66 (PA 66)

	Item No.	Page
2-way	2001-402	162
orange	2000-2292	161
white	2009-114	780
white	2009-110	783

	Item No.	Page
2-way	2001-402	162
orange	2000-2292	161
white	2009-114	780
white	2009-110	783

	Item No.	Page
2-way	2001-402	162
orange	2000-2292	161
white	2009-114	780
white	2009-110	783

# TOPJOB® S

## Double-Deck Terminal Blocks

### 2.5 (4) mm<sup>2</sup>, 2002 Series

1



Double-deck terminal block assembly



Both ground and shield conductor terminal blocks have a contact foot in the bottom level, automatically establishing direct contact to the carrier rail or busbar.

The flexible double-deck marker carrier, which is placed above the wiring level, can be pushed aside during wiring. The carrier has two staggered levels for WMB markers that perfectly line up to the terminal block decks.

With a terminal block width of just 5.2 mm, an effective width of just 2.6 mm for terminal blocks of same or different potentials can be realized for conductors ranging 0.25 mm<sup>2</sup> ... 4 mm<sup>2</sup> (22 ... 12 AWG). Shielded control cables are becoming an increasingly common solution to external signal interference. Front-entry shield conductor terminal blocks are ideally suited to connect braided cables. Like front-entry ground conductor terminal blocks, they are equipped with a grounding foot for direct electrical connection to the rail, however they differ significantly by their white insulated housing. Front-entry shield conductor terminal blocks can be directly mounted beside signal-conductor terminal blocks, providing excellent deflection of interfering signals.

Rail-mount terminal blocks with an Ex mark are suitable for Ex e II applications. Terminal blocks with a blue insulated housing are suitable for Ex i applications.

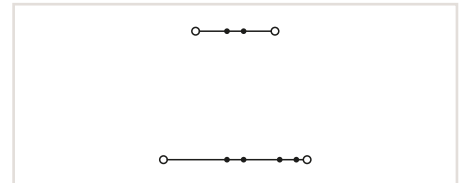
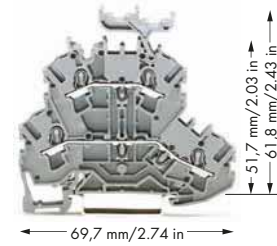

Double-deck terminal block, through/through terminal block, with marker carrier

	Item No.	Pack. Unit
○ L/L ☒	2002-2231	50
○ N/L ☒	2002-2232	50
○ L/N ☒	2002-2233	50
● N/N ☒	2002-2234	50

Double-deck terminal block, through/through terminal block, no marker carrier

	Item No.	Pack. Unit
○ L/L ☒	2002-2201	50
○ N/L ☒	2002-2202	50
○ L/N ☒	2002-2203	50
● N/N ☒	2002-2204	50



#### Technical Data

Ratings per	IEC/EN 60947-7-1
Rated voltage (III / 3)	500 V
Rated surge voltage (III / 3)	6 kV
Rated current	24 A
Rated voltage EN (Ex e II)	440 V
Nominal current (Ex e II)	20 A
Nominal current (Ex e II) with jumper	18 A
Rated current (2)	28 A
Approval	600 V, 20 A, ; 600 V, 20 A
Nominal cross section	2.5 mm <sup>2</sup>
<b>Connection Data</b>	
Solid conductor	0.25 ... 4 mm <sup>2</sup> / 22 ... 12 AWG
Solid conductor, push-in termination	0.75 ... 4 mm <sup>2</sup> / 18 ... 12 AWG
Fine-stranded conductor	0.25 ... 4 mm <sup>2</sup> / 22 ... 12 AWG
Fine-stranded conductor with ferrule, push-in termination, min.	0.75 mm <sup>2</sup> / 18 AWG
Strip length	10 ... 12 mm / 0.39 ... 0.47 inch
Terminal block width	5.2 mm / 0.205 inch
Insulation material	Polyamide 66 (PA 66)

#### Accessories (Selection)

	Item No.	Page
Push-in type jumper bar, insulated, I <sub>n</sub> 25 A, light gray	2-way 2002-402	164
End and intermediate plate, 0.8 mm thick	orange 2002-2292	166
WMB Inline, plain, 1,500 WMB markers (5 mm) per reel, 5 ... 5.2 mm stretchable	white 2009-115	780
Marking strip, plain, 11 mm wide, 50 m reel	white 2009-110	783

Accessories (jumpers, end plates, test plugs, etc.), see page 164

Carrier rails and tools, see Section 13

Appropriate marking system, WMB/WMB Inline/markings strips, see Full Line Catalog, Volume 6

Information on hazardous locations, see Section 14

Approvals and corresponding ratings, visit [www.wago.com](http://www.wago.com)

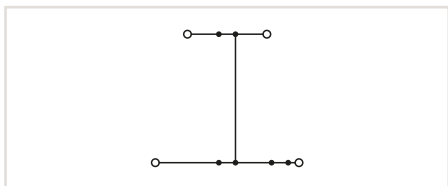
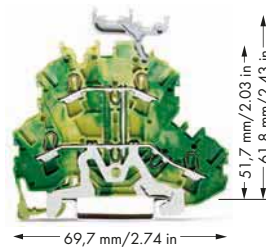
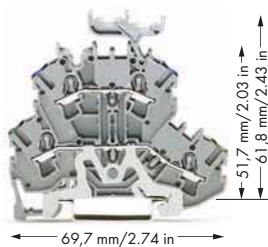
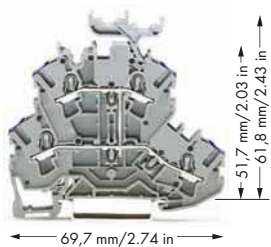

Double-deck terminal block, 4-conductor through terminal block, with marker carrier, internally commoned, violet conductor entry

	Item No.	Pack. Unit
○ L ⊕	2002-2238	50
● N ⊕	2002-2239	50

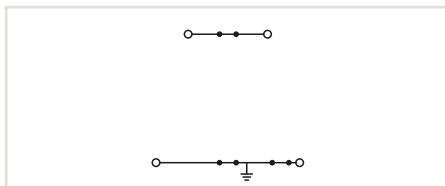

Double-deck terminal block, ground conductor/through terminal block, with marker carrier

	Item No.	Pack. Unit
○ PE/N ⊕	2002-2247	50
○ PE/L ⊕	2002-2257	50
○ Shield/N	2002-2248	50
○ Shield/L	2002-2258	50

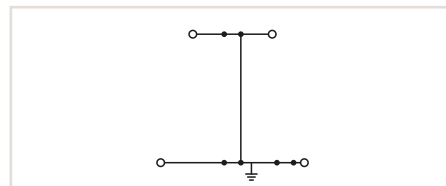

Double-deck terminal block, 4-conductor ground terminal block, with marker carrier, internally commoned

	Item No.	Pack. Unit
● PE ⊕	2002-2237	50

Double-deck terminal block, 4-conductor through terminal block, no marker carrier, internally commoned, violet conductor entry

	Item No.	Pack. Unit
○ L ⊕	2002-2208	50
● N ⊕	2002-2209	50

Double-deck terminal block, ground conductor/through terminal block, no marker carrier

	Item No.	Pack. Unit
○ PE/N ⊕	2002-2217	50
○ PE/L ⊕	2002-2227	50
○ Shield/N	2002-2218	50
○ Shield/L	2002-2228	50

Double-deck terminal block, 4-conductor ground terminal block, no marker carrier, internally commoned

	Item No.	Pack. Unit
● PE ⊕	2002-2207	50



IEC/EN 60947-7-1
500 V
6 kV
24 A
440 V
20 A
18 A
28 A
600 V, 20 A, ; 600 V, 20 A
2.5 mm <sup>2</sup>
0.25 ... 4 mm <sup>2</sup> / 22 ... 12 AWG
0.75 ... 4 mm <sup>2</sup> / 18 ... 12 AWG
0.25 ... 4 mm <sup>2</sup> / 22 ... 12 AWG
0.75 mm <sup>2</sup> / 18 AWG
10 ... 12 mm / 0.39 ... 0.47 inch
5.2 mm / 0.205 inch
Polyamide 66 (PA 66)

IEC/EN 60947-7-1
500 V
6 kV
24 A
440 V
20 A
18 A
28 A
600 V, 20 A, ; 600 V, 20 A
2.5 mm <sup>2</sup>
0.25 ... 4 mm <sup>2</sup> / 22 ... 12 AWG
0.75 ... 4 mm <sup>2</sup> / 18 ... 12 AWG
0.25 ... 4 mm <sup>2</sup> / 22 ... 12 AWG
0.75 mm <sup>2</sup> / 18 AWG
10 ... 12 mm / 0.39 ... 0.47 inch
5.2 mm / 0.205 inch
Polyamide 66 (PA 66)

IEC/EN 60947-7-2
2.5 mm <sup>2</sup>
0.25 ... 4 mm <sup>2</sup> / 22 ... 12 AWG
0.75 ... 4 mm <sup>2</sup> / 18 ... 12 AWG
0.25 ... 4 mm <sup>2</sup> / 22 ... 12 AWG
0.75 mm <sup>2</sup> / 18 AWG
10 ... 12 mm / 0.39 ... 0.47 inch
5.2 mm / 0.205 inch
Polyamide 66 (PA 66)

	Item No.	Page
2-way	2002-402	164
orange	2002-2292	166
white	2009-115	780
white	2009-110	783

	Item No.	Page
2-way	2002-402	164
orange	2002-2292	166
white	2009-115	780
white	2009-110	783

	Item No.	Page
2-way	2002-402	164
orange	2002-2292	166
white	2009-115	780
white	2009-110	783

# TOPJOB® S

## Double-Deck Terminal Blocks with End Plate, 800 V

### 2.5 (4) mm<sup>2</sup>, 2002 Series

1



Double-deck terminal block with double-deck marker carrier (2002-2231/099-000)



Double-deck terminal block with double-deck marker carrier (2002-2231/099-000)  
A double-deck marker carrier (2002-121) can be fitted retrospectively to double-deck terminal blocks no marker carrier.

Terminal blocks with a blue insulated housing are suitable for Ex i applications.

A protective warning marker and an insulation stop must be applied individually. Due to the 6.2 mm width of double-deck terminal blocks, 2004 Series Push-In Type Jumper Bars must be used.

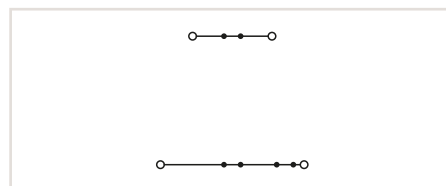
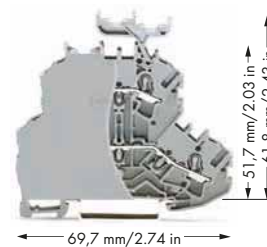

Double-deck terminal block, through/through terminal block, with marker carrier

	Item No.	Pack. Unit
○ L/L	2002-2231/099-000	50
○ N/L	2002-2232/099-000	50
○ L/N	2002-2233/099-000	50
● N/N	2002-2234/099-000	50

Double-deck terminal block, through/through terminal block, no marker carrier

	Item No.	Pack. Unit
○ L/L	2002-2201/099-000	50
○ N/L	2002-2202/099-000	50
○ L/N	2002-2203/099-000	50
● N/N	2002-2204/099-000	50



#### Technical Data

Ratings per	IEC/EN 60947-7-1
Rated voltage (III / 3)	800 V
Rated surge voltage (III / 3)	8 kV
Rated current	24 A
Rated current (2)	28 A
Approval	600 V, 20 A ; 600 V, 20 A
Nominal cross section	2.5 mm <sup>2</sup>
<b>Connection Data</b>	
Solid conductor	0.25 ... 4 mm <sup>2</sup> / 22 ... 12 AWG
Solid conductor, push-in termination	0.75 ... 4 mm <sup>2</sup> / 18 ... 12 AWG
Fine-stranded conductor	0.25 ... 4 mm <sup>2</sup> / 22 ... 12 AWG
Fine-stranded conductor with ferrule, push-in termination, min.	0.75 mm <sup>2</sup> / 18 AWG
Strip length	10 ... 12 mm / 0.39 ... 0.47 inch
Terminal block width	6.2 mm / 0.244 inch
Insulation material	Polyamide 66 (PA 66)

#### Accessories (Selection)

Push-in type jumper bar, insulated, I <sub>N</sub> 32 A, light gray
End and intermediate plate, 0.8 mm thick
WMB Multi marking system, white, 10 strips with 10 markers per card, 5 ... 5.2 mm stretchable
Marking strip, plain, 11 mm wide, 50 m reel

	Item No.	Page
2-way	2004-402	169
orange	2002-2292	166
plain	793-5501	780
white	2009-110	783

- Push-in type jumper bars (2004 Series), see page 169
- Accessories (end plates, etc.), see page 166
- Carrier rails and tools, see Section 13
- Appropriate marking system, WMB/WMB Inline/marketing strips, see Full Line Catalog, Volume 6
- Approvals and corresponding ratings, visit [www.wago.com](http://www.wago.com)

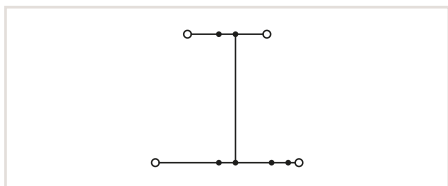
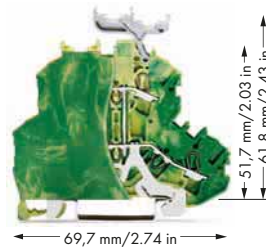
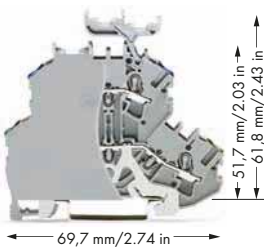
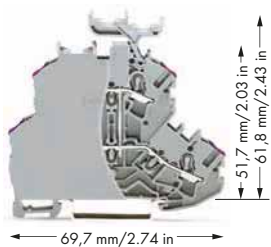

Double-deck terminal block, 4-conductor through terminal block, with marker carrier, internally commoned, violet conductor entry

	Item No.	Pack. Unit
○ L	2002-2238/099-000	50
● N	2002-2239/099-000	50

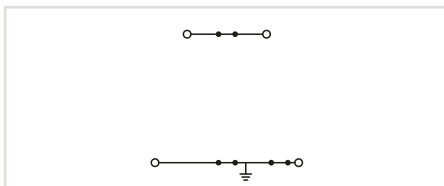

Double-deck terminal block, ground conductor/through terminal block, with marker carrier

	Item No.	Pack. Unit
○ PE/N	2002-2247/099-000	50
○ PE/L	2002-2257/099-000	50
○ Shield/N	2002-2248/099-000	50
○ Shield/L	2002-22 58/099-000	50

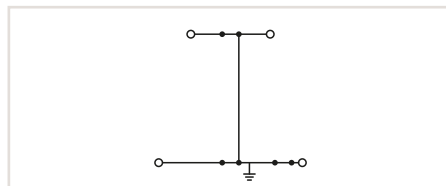

Double-deck terminal block, 4-conductor ground terminal block, with marker carrier, internally commoned

	Item No.	Pack. Unit
● PE	2002-2237/099-000	50

Double-deck terminal block, 4-conductor through terminal block, no marker carrier, internally commoned, violet conductor entry

	Item No.	Pack. Unit
○ L	2002-2208/099-000	50
● N	2002-2209/099-000	50

Double-deck terminal block, ground conductor/through terminal block, no marker carrier

	Item No.	Pack. Unit
○ PE/N	2002-2217/099-000	50
○ PE/L	2002-2227/099-000	50
○ Shield/N	2002-2218/099-000	50
○ Shield/L	2002-2228/099-000	50

Double-deck terminal block, 4-conductor ground terminal block, no marker carrier, internally commoned

	Item No.	Pack. Unit
● PE	2002-2207/099-000	50



IEC/EN 60947-7-1
800 V
8 kV
24 A
28 A
600 V, 20 A ; 600 V, 20 A
2.5 mm <sup>2</sup>
0.25 ... 4 mm <sup>2</sup> / 22 ... 12 AWG
0.75 ... 4 mm <sup>2</sup> / 18 ... 12 AWG
0.25 ... 4 mm <sup>2</sup> / 22 ... 12 AWG
0.75 mm <sup>2</sup> / 18 AWG
10 ... 12 mm / 0.39 ... 0.47 inch
6.2 mm / 0.244 inch
Polyamide 66 (PA 66)

IEC/EN 60947-7-1
800 V
8 kV
24 A
28 A
600 V, 20 A ; 600 V, 20 A
2.5 mm <sup>2</sup>
0.25 ... 4 mm <sup>2</sup> / 22 ... 12 AWG
0.75 ... 4 mm <sup>2</sup> / 18 ... 12 AWG
0.25 ... 4 mm <sup>2</sup> / 22 ... 12 AWG
0.75 mm <sup>2</sup> / 18 AWG
10 ... 12 mm / 0.39 ... 0.47 inch
6.2 mm / 0.244 inch
Polyamide 66 (PA 66)

IEC/EN 60947-7-2
800 V
8 kV
24 A
28 A
600 V, 20 A ; 600 V, 20 A
2.5 mm <sup>2</sup>
0.25 ... 4 mm <sup>2</sup> / 22 ... 12 AWG
0.75 ... 4 mm <sup>2</sup> / 18 ... 12 AWG
0.25 ... 4 mm <sup>2</sup> / 22 ... 12 AWG
0.75 mm <sup>2</sup> / 18 AWG
10 ... 12 mm / 0.39 ... 0.47 inch
6.2 mm / 0.244 inch
Polyamide 66 (PA 66)

	Item No.	Page
2-way	2004-402	169
orange	2002-2292	166
plain	793-5501	780
white	2009-110	783

	Item No.	Page
2-way	2004-402	169
orange	2002-2292	166
plain	793-5501	780
white	2009-110	783

	Item No.	Page
2-way	2004-402	169
orange	2002-2292	166
plain	793-5501	780
white	2009-110	783



## TOPJOB® S

Double-Deck Terminal Blocks with Oversized Separator Plate, 1000 V  
2.5 (4) mm<sup>2</sup>, 2002 Series

1

A protective warning marker and an insulation stop must be applied individually.

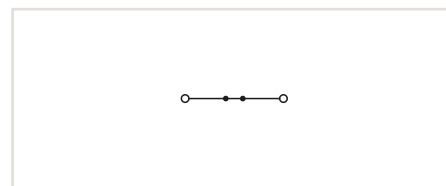
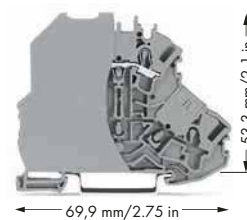

Double-deck terminal block, contact insert only on upper deck, with oversized, gray separator plate

	Item No.	Pack. Unit
○ L	2002-2201/097-000	50

**Technical Data**

Ratings per	IEC/EN 60947-7-1
Voltage type	AC/DC
Rated voltage (III / 3)	1000 V
Rated surge voltage (III / 3)	12 kV
Voltage type (2)	DC
Rated voltage (III / 3) (2)	1500 V
Rated surge voltage (III / 3) (2)	12 kV
Rated current	24 A
Nominal cross section	2.5 mm <sup>2</sup>

**Connection Data**

Solid conductor	0.25 ... 4 mm <sup>2</sup> / 22 ... 12 AWG
Solid conductor, push-in termination	0.75 ... 4 mm <sup>2</sup> / 18 ... 12 AWG
Fine-stranded conductor	0.25 ... 4 mm <sup>2</sup> / 22 ... 12 AWG
Fine-stranded conductor with ferrule, push-in termination, min.	0.75 mm <sup>2</sup> / 18 AWG
Strip length	10 ... 12 mm / 0.39 ... 0.47 inch
Terminal block width	7.2 mm / 0.283 inch
Insulation material	Polyamide 66 (PA 66)

**Accessories (Selection)**

	Item No.	Page
Separator plate, oversized upper deck, snap-on type, 2 mm thick	orange 2002-2296	166
WMB Multi marking system, white, 10 strips with 10 markers per card, 5 ... 5.2 mm stretchable	plain 793-5501	780
Marking strip, plain, 11 mm wide, 50 m reel	white 2009-110	783

Accessories (end plates, etc.), see page 166

Carrier rails and tools, see Section 13

Appropriate marking system, WMB/WMB Inline/marketing strips, see Full Line Catalog, Volume 6

Approvals and corresponding ratings, visit [www.wago.com](http://www.wago.com)

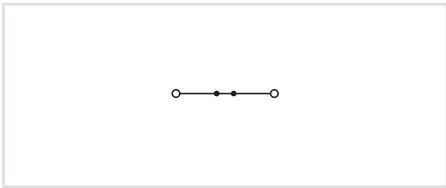
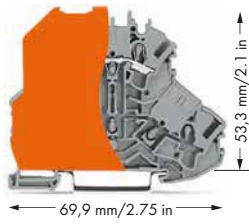

Double-deck terminal block, contact insert only on upper deck, with oversized, gray separator plate

	Item No.	Pack. Unit
○ L	2002-2201/098-000	50

IEC/EN 60947-7-1
AC/DC
1000 V
12 kV
DC
1500 V
12 kV
24 A
2.5 mm <sup>2</sup>
0.25 ... 4 mm <sup>2</sup> / 22 ... 12 AWG
0.75 ... 4 mm <sup>2</sup> / 18 ... 12 AWG
0.25 ... 4 mm <sup>2</sup> / 22 ... 12 AWG
0.75 mm <sup>2</sup> / 18 AWG
10 ... 12 mm / 0.39 ... 0.47 inch
7.2 mm / 0.283 inch
Polyamide 66 (PA 66)

	Item No.	Page
orange	2002-2296	166
plain	793-5501	780
white	2009-110	783

# TOPJOB® S

## 4-Conductor, Double-Deck Terminal Blocks

### 2.5 (4) mm<sup>2</sup>, 2002 Series

1

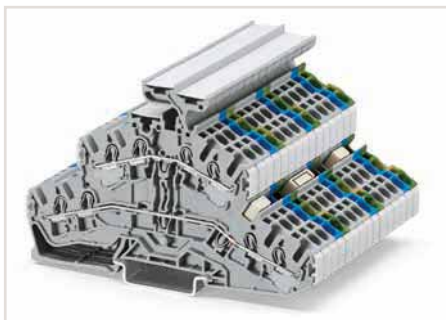

Double-deck terminal block assembly

Terminal blocks with a blue insulated housing are suitable for Ex i applications.



Created for double- and triple-deck TOPJOB® S Terminal Blocks, the vertical jumpers can common two or three levels. Clearly marked numerals ("2" and "3") distinguish the double-deck (2002-0492) and triple-deck vertical jumpers (2002-0493), even when inserted.

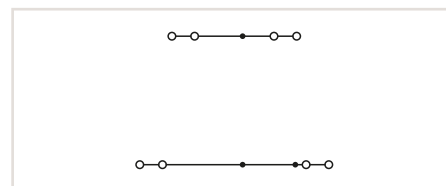
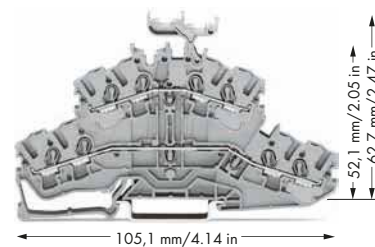

4-conductor, double-deck terminal block, through/through terminal block, with marker carrier

	Item No.	Pack. Unit
○ L/L	2002-2431	50
○ N/L	2002-2432	50
○ L/N	2002-2433	50
● N/N	2002-2434	50

4-conductor, double-deck terminal block, through/through terminal block, no marker carrier

	Item No.	Pack. Unit
○ L/L	2002-2401	50
○ N/L	2002-2402	50
○ L/N	2002-2403	50
● N/N	2002-2404	50



#### Technical Data

Ratings per	IEC/EN 60947-7-1
Rated voltage (III / 3)	800 V
Rated surge voltage (III / 3)	8 kV
Rated current	24 A
Rated current (2)	28 A
Approval	600 V, 20 A ; 600 V, 20 A
Nominal cross section	2.5 mm <sup>2</sup>

#### Connection Data

Solid conductor	0.25 ... 4 mm <sup>2</sup> / 22 ... 12 AWG
Solid conductor, push-in termination	0.75 ... 4 mm <sup>2</sup> / 18 ... 12 AWG
Fine-stranded conductor	0.25 ... 4 mm <sup>2</sup> / 22 ... 12 AWG
Fine-stranded conductor with ferrule, push-in termination, min.	0.75 mm <sup>2</sup> / 18 AWG
Strip length	10 ... 12 mm / 0.39 ... 0.47 inch
Terminal block width	5.2 mm / 0.205 inch
Insulation material	Polyamide 66 (PA 66)

#### Accessories (Selection)

Push-in type jumper bar, insulated, I <sub>N</sub> 25 A, light gray	
End and intermediate plate, 0.8 mm thick	
WMB Inline, plain, 1,500 WMB markers (5 mm) per reel, 5 ... 5.2 mm stretchable	
Marking strip, plain, 11 mm wide, 50 m reel	

	Item No.	Page
2-way	2002-402	164
orange	2002-2492	166
white	2009-115	780
white	2009-110	783

Accessories (jumpers, end plates, test plugs, etc.), see page 164

Carrier rails and tools, see Section 13

Appropriate marking system, WMB/WMB Inline/marketing strips, see Full Line Catalog, Volume 6

Approvals and corresponding ratings, visit [www.wago.com](http://www.wago.com)

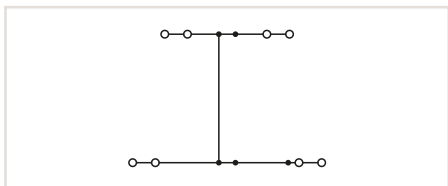
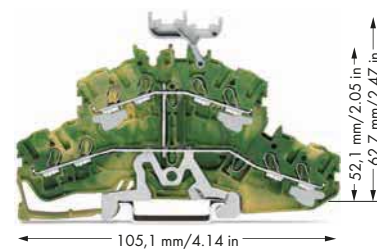
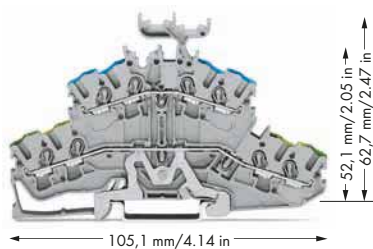
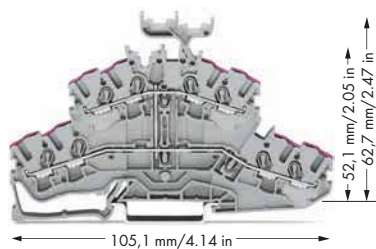

4-conductor, double-deck terminal block, 4-conductor through terminal block, with marker carrier, internally commoned, violet conductor entry

	Item No.	Pack. Unit
○ L	2002-2438	50
● N	2002-2439	50

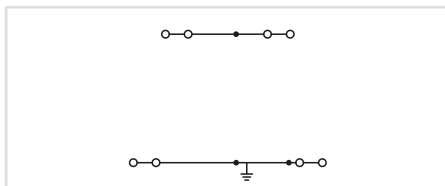

4-conductor, double-deck terminal block, ground conductor/through terminal block, with marker carrier

	Item No.	Pack. Unit
○ PE/N	2002-2447	50
○ PE/L	2002-2457	50
○ Shield/N	2002-2448	50
○ Shield/L	2002-2458	50

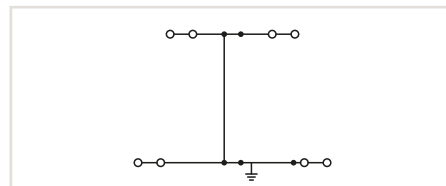

4-conductor, double-deck terminal block, 4-conductor ground terminal block, with marker carrier, internally commoned

	Item No.	Pack. Unit
● PE	2002-2437	50

4-conductor, double-deck terminal block, 4-conductor through terminal block, no marker carrier, internally commoned, violet conductor entry

	Item No.	Pack. Unit
○ L	2002-2408	50
● N	2002-2409	50

4-conductor, double-deck terminal block, ground conductor/through terminal block, no marker carrier

	Item No.	Pack. Unit
○ PE/N	2002-2417	50
○ PE/L	2002-2427	50
○ Shield/N	2002-2418	50
○ Shield/L	2002-2428	50

4-conductor, double-deck terminal block, 4-conductor ground terminal block, no marker carrier, internally commoned

	Item No.	Pack. Unit
● PE	2002-2407	50



IEC/EN 60947-7-1

800 V  
8 kV  
24 A  
28 A  
600 V, 20 A ; 600 V, 20 A   
2.5 mm<sup>2</sup>

0.25 ... 4 mm<sup>2</sup> / 22 ... 12 AWG  
0.75 ... 4 mm<sup>2</sup> / 18 ... 12 AWG  
0.25 ... 4 mm<sup>2</sup> / 22 ... 12 AWG  
0.75 mm<sup>2</sup> / 18 AWG

10 ... 12 mm / 0.39 ... 0.47 inch  
5.2 mm / 0.205 inch  
Polyamide 66 (PA 66)

	Item No.	Page
2-way	2002-402	164
orange	2002-2492	166
white	2009-115	780
white	2009-110	783

IEC/EN 60947-7-1

800 V  
8 kV  
24 A  
28 A  
600 V, 20 A ; 600 V, 20 A   
2.5 mm<sup>2</sup>

0.25 ... 4 mm<sup>2</sup> / 22 ... 12 AWG  
0.75 ... 4 mm<sup>2</sup> / 18 ... 12 AWG  
0.25 ... 4 mm<sup>2</sup> / 22 ... 12 AWG  
0.75 mm<sup>2</sup> / 18 AWG

10 ... 12 mm / 0.39 ... 0.47 inch  
5.2 mm / 0.205 inch  
Polyamide 66 (PA 66)

	Item No.	Page
2-way	2002-402	164
orange	2002-2492	166
white	2009-115	780
white	2009-110	783

IEC/EN 60947-7-2

2.5 mm<sup>2</sup>

0.25 ... 4 mm<sup>2</sup> / 22 ... 12 AWG  
0.75 ... 4 mm<sup>2</sup> / 18 ... 12 AWG  
0.25 ... 4 mm<sup>2</sup> / 22 ... 12 AWG  
0.75 mm<sup>2</sup> / 18 AWG

10 ... 12 mm / 0.39 ... 0.47 inch  
5.2 mm / 0.205 inch  
Polyamide 66 (PA 66)

	Item No.	Page
2-way	2002-402	164
orange	2002-2492	166
white	2009-115	780
white	2009-110	783

## TOPJOB® S

### Double-Deck Terminal Blocks

#### 2.5 (4) mm<sup>2</sup>, 2002 Series

1

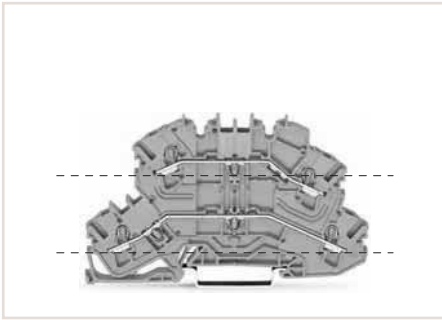

Through terminal blocks (2002-2601) feature two independent current bars on both lower and upper deck, sharing the same profile as disconnect terminal blocks.

These terminal blocks can be commoned via double-deck vertical jumpers (2002-492).

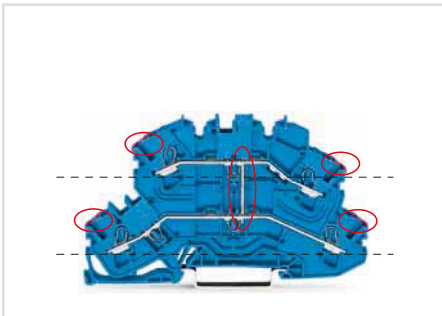

4-conductor through terminal blocks (2002-2609) with internal commoning can be immediately identified via violet conductor entry.

Terminal blocks with a blue insulated housing are suitable for Ex i applications.

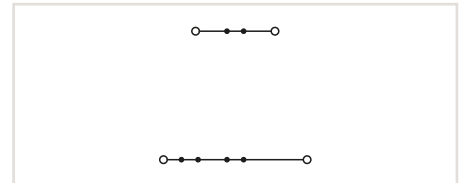
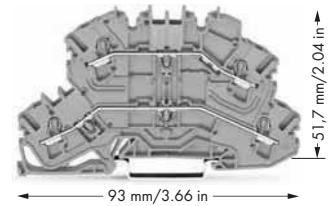

Double-deck terminal block, through/through terminal block, same profile as double-deck disconnect terminal block, no marker carrier

	Item No.	Pack. Unit
○ L/L	2002-2601	50
○ N/L	2002-2602	50
○ L/N	2002-2603	50
● N/N	2002-2604	50



#### Technical Data

Ratings per	IEC/EN 60947-7-1
Rated voltage (III / 3)	500 V
Rated surge voltage (III / 3)	6 kV
Rated current	24 A
Rated current (2)	28 A
Approval	300 V, 20 A ; 300 V, 20 A
Nominal cross section	2.5 mm <sup>2</sup>

#### Connection Data

Solid conductor	0.25 ... 4 mm <sup>2</sup> / 22 ... 12 AWG
Solid conductor, push-in termination	0.75 ... 4 mm <sup>2</sup> / 18 ... 12 AWG
Fine-stranded conductor	0.25 ... 4 mm <sup>2</sup> / 22 ... 12 AWG
Fine-stranded conductor with ferrule, push-in termination, min.	0.75 mm <sup>2</sup> / 18 AWG
Strip length	10 ... 12 mm / 0.39 ... 0.47 inch
Terminal block width	5.2 mm / 0.205 inch
Insulation material	Polyamide 66 (PA 66)

#### Accessories (Selection)

Push-in type jumper bar, insulated, I <sub>N</sub> 25 A, light gray
End and intermediate plate, 1 mm thick
WMB Inline, plain, 1,500 WMB markers (5 mm) per reel, 5 ... 5.2 mm stretchable
Marking strip, plain, 11 mm wide, 50 m reel

	Item No.	Page
2-way	2002-402	164
orange	2002-2692	167
white	2009-115	780
white	2009-110	783

Accessories (jumpers, end plates, test plugs, etc.), see page 164

Carrier rails and tools, see Section 13

Appropriate marking system, WMB/WMB Inline/markings strips, see Full Line Catalog, Volume 6

Approvals and corresponding ratings, visit [www.wago.com](http://www.wago.com)

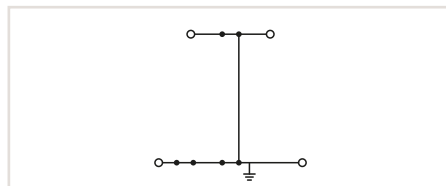
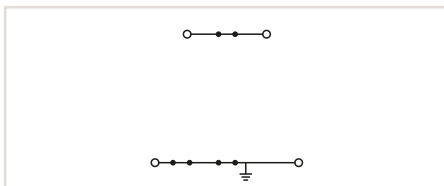
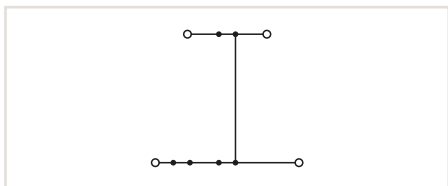
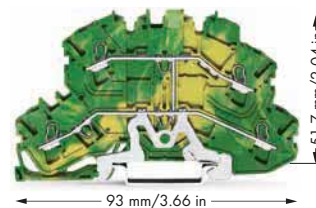
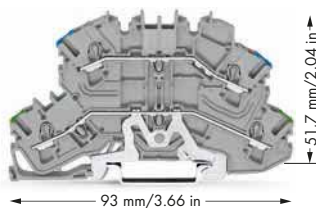
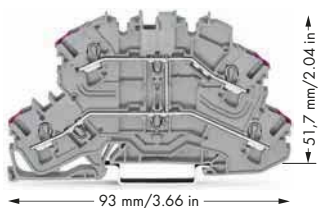

Double-deck terminal block, 4-conductor through terminal block, same profile as double-deck disconnect terminal block, no marker carrier, internally commoned, violet conductor entry

	Item No.	Pack. Unit
○ L	2002-2608	50
● N	2002-2609	

Double-deck terminal block, ground conductor/through terminal block, same profile as double-deck disconnect terminal block, no marker carrier

	Item No.	Pack. Unit
○ PE/N	2002-2647	50
○ PE/L	2002-2657	50

Double-deck terminal block, 4-conductor ground disconnect terminal block, same profile as double-deck disconnect terminal block, no marker carrier, internally commoned

	Item No.	Pack. Unit
● PE	2002-2607	50



IEC/EN 60947-7-1

500 V

6 kV

24 A

28 A

300 V, 20 A ; 300 V, 20 A

2.5 mm<sup>2</sup>

0.25 ... 4 mm<sup>2</sup> / 22 ... 12 AWG

0.75 ... 4 mm<sup>2</sup> / 18 ... 12 AWG

0.25 ... 4 mm<sup>2</sup> / 22 ... 12 AWG

0.75 mm<sup>2</sup> / 18 AWG

10 ... 12 mm / 0.39 ... 0.47 inch

5.2 mm / 0.205 inch

Polyamide 66 (PA 66)

	Item No.	Page
2-way	2002-402	164
orange	2002-2692	167
white	2009-115	780
white	2009-110	783

IEC/EN 60947-7-1

500 V

6 kV

24 A

28 A

300 V, 20 A ; 300 V, 20 A

2.5 mm<sup>2</sup>

0.25 ... 4 mm<sup>2</sup> / 22 ... 12 AWG

0.75 ... 4 mm<sup>2</sup> / 18 ... 12 AWG

0.25 ... 4 mm<sup>2</sup> / 22 ... 12 AWG

0.75 mm<sup>2</sup> / 18 AWG

10 ... 12 mm / 0.39 ... 0.47 inch

5.2 mm / 0.205 inch

Polyamide 66 (PA 66)

	Item No.	Page
2-way	2002-402	164
orange	2002-2692	167
white	2009-115	780
white	2009-110	783

IEC/EN 60947-7-2

2.5 mm<sup>2</sup>

0.25 ... 4 mm<sup>2</sup> / 22 ... 12 AWG

0.75 ... 4 mm<sup>2</sup> / 18 ... 12 AWG

0.75 mm<sup>2</sup> / 18 AWG

10 ... 12 mm / 0.39 ... 0.47 inch

5.2 mm / 0.205 inch

Polyamide 66 (PA 66)

	Item No.	Page
2-way	2002-402	164
orange	2002-2692	167
white	2009-115	780
white	2009-110	783



## TOPJOB® S

### Double-Deck Disconnect and Carrier Terminal Blocks

#### 2.5 (4) mm<sup>2</sup>, 2002 Series

1

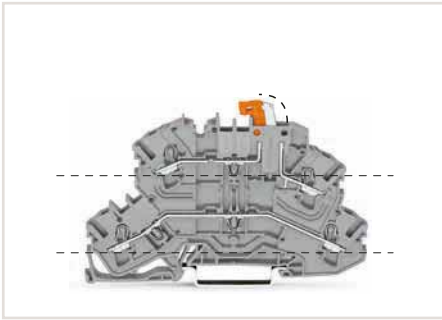

Double-deck disconnect terminal blocks with a pivoting knife disconnect (2002-2671) can be used as through terminal blocks on the lower deck and as disconnect terminal blocks on the upper deck. Besides disconnection and measurement, double-deck carrier terminal blocks (2002-2667) also provide ground conductor functionality.

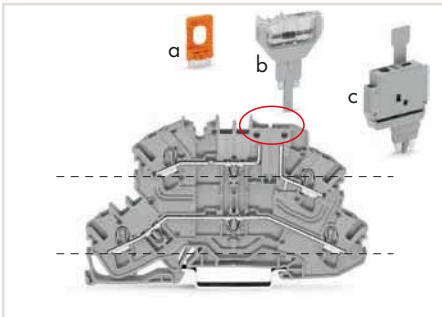

Carrier terminal blocks (2002-2661) have the same design as disconnect terminal blocks. The following components may be used:

- Disconnect plug (a: 2002-401)
- Pluggable diode (b: 2002-800/1000-411)
- LED module (2002-800/1000-541, no illustration)
- Fuse plug (c: 2004-911)

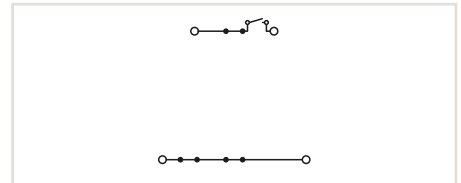
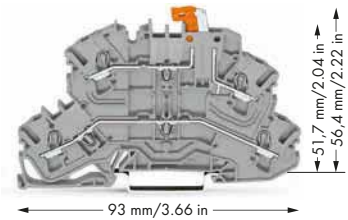

Double-deck disconnect terminal block, with a pivoting knife disconnect, gray housing

	Item No.	Pack. Unit
○ L/L	2002-2671	50
○ N/L	2002-2672	50



#### Technical Data

Ratings per	IEC/EN 60947-7-1
Rated voltage (III / 3)	400 V
Rated surge voltage (III / 3)	6 kV
Rated current	16 A
Approval	300 V, 15 A ; 300 V, 15 A
Nominal cross section	2.5 mm <sup>2</sup>
Connection Data	
Solid conductor	0.25 ... 4 mm <sup>2</sup> / 22 ... 12 AWG
Solid conductor, push-in termination	0.75 ... 4 mm <sup>2</sup> / 18 ... 12 AWG
Fine-stranded conductor	0.25 ... 4 mm <sup>2</sup> / 22 ... 12 AWG
Fine-stranded conductor with ferrule, push-in termination, min.	0.75 mm <sup>2</sup> / 18 AWG
Strip length	10 ... 12 mm / 0.39 ... 0.47 inch
Terminal block width	5.2 mm / 0.205 inch
Insulation material	Polyamide 66 (PA 66)

#### Accessories (Selection)

Push-in type jumper bar, insulated, I <sub>n</sub> 25 A, light gray
End and intermediate plate, 1 mm thick
WMB Inline, plain, 1,500 WMB markers (5 mm) per reel, 5 ... 5.2 mm stretchable
Marking strip, plain, 11 mm wide, 50 m reel

	Item No.	Page
2-way	2002-402	164
orange	2002-2692	167
white	2009-115	780
white	2009-110	783

Accessories (jumpers, end plates, test plugs, etc.), see page 164

Carrier rails and tools, see Section 13

Appropriate marking system, WMB/WMB Inline/marketing strips, see Full Line Catalog, Volume 6

Approvals and corresponding ratings, visit [www.wago.com](http://www.wago.com)

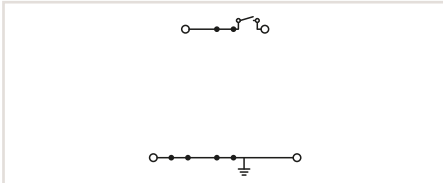
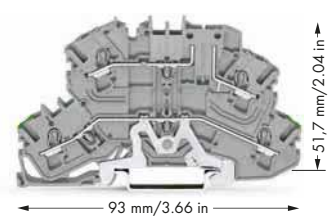
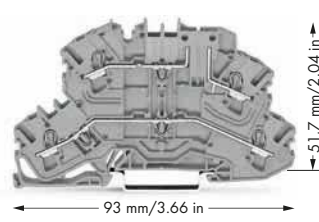
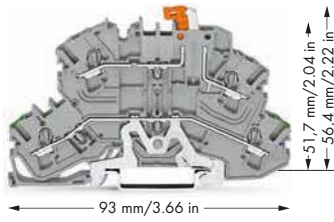

Double-deck disconnect terminal block, with a pivoting knife disconnect, gray housing

	Item No.	Pack. Unit
● Shield/L	2002-2678	50



IEC/EN 60947-7-1
400 V
6 kV
16 A
300 V, 15 A <b>UL</b> ; 300 V, 15 A <b>CE</b>
2.5 mm <sup>2</sup>
0.25 ... 4 mm <sup>2</sup> / 22 ... 12 AWG
0.75 ... 4 mm <sup>2</sup> / 18 ... 12 AWG
0.25 ... 4 mm <sup>2</sup> / 22 ... 12 AWG
0.75 mm <sup>2</sup> / 18 AWG
10 ... 12 mm / 0.39 ... 0.47 inch
5.2 mm / 0.205 inch
Polyamide 66 (PA 66)

	Item No.	Page
2-way	2002-402	164
orange	2002-2692	167
white	2009-115	780
white	2009-110	783

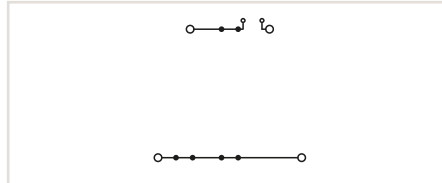

Double-deck carrier terminal block, upper-deck base, gray housing

	Item No.	Pack. Unit
● L/L	2002-2661	50
● N/L	2002-2662	50



IEC/EN 60947-7-1
400 V
6 kV
16 A
300 V, 15 A <b>UL</b> ; 300 V, 15 A <b>CE</b>
2.5 mm <sup>2</sup>
0.25 ... 4 mm <sup>2</sup> / 22 ... 12 AWG
0.75 ... 4 mm <sup>2</sup> / 18 ... 12 AWG
0.25 ... 4 mm <sup>2</sup> / 22 ... 12 AWG
0.75 mm <sup>2</sup> / 18 AWG
10 ... 12 mm / 0.39 ... 0.47 inch
5.2 mm / 0.205 inch
Polyamide 66 (PA 66)

	Item No.	Page
2-way	2002-402	164
orange	2002-2692	167
white	2009-115	780
white	2009-110	783

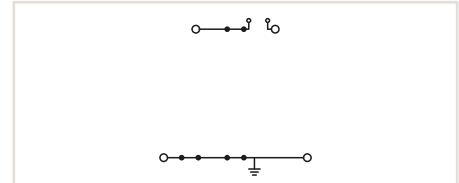

Double-deck carrier terminal block, upper-deck base, gray housing

	Item No.	Pack. Unit
● PE	2002-2667	50



IEC/EN 60947-7-1
400 V
6 kV
16 A
300 V, 15 A <b>UL</b> ; 300 V, 15 A <b>CE</b>
2.5 mm <sup>2</sup>
0.25 ... 4 mm <sup>2</sup> / 22 ... 12 AWG
0.75 ... 4 mm <sup>2</sup> / 18 ... 12 AWG
0.25 ... 4 mm <sup>2</sup> / 22 ... 12 AWG
0.75 mm <sup>2</sup> / 18 AWG
10 ... 12 mm / 0.39 ... 0.47 inch
5.2 mm / 0.205 inch
Polyamide 66 (PA 66)

	Item No.	Page
2-way	2002-402	164
orange	2002-2692	167
white	2009-115	780
white	2009-110	783

# TOPJOB® S

## Double-Deck Fuse Terminal Blocks

### Installation

1



Pivot the fuse holder into the open position.



Double-deck fuse disconnect terminal blocks with a pivoting fuse holder (2002-2611, gray) are compatible with disconnect, carrier, through and ground conductor terminal blocks. The fuse holder is also available with a blown fuse LED indicator. (e.g., 2002-2611/1000-541 for 12 ... 30 V).



An end plate for fuse disconnect terminal blocks (shown in orange, 2002-1092) is used for additional protection, preventing the fuse holder from being opened. The fuse cannot be replaced until disconnecting the fuse holder from the power supply.

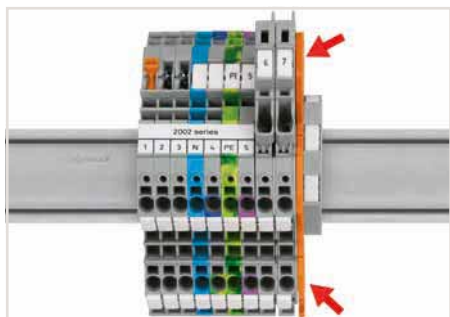

Additionally, an end plate for fuse terminal blocks (e.g., 2002-1092, orange) must be used at the end of an assembly or if there is no adjacent fuse terminal block.

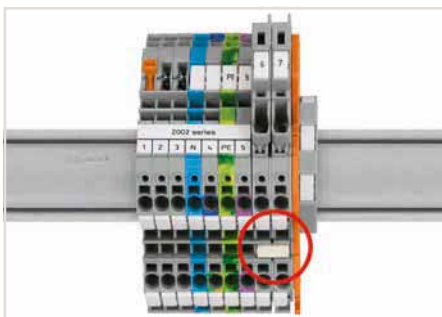

An intermediate plate is supplied with all 6.2 mm wide fuse disconnect terminal blocks. Due to the 6.2 mm width of fuse disconnect terminal blocks with a pivoting fuse holder, 2004 Series Push-In Type Jumper Bars must be used.

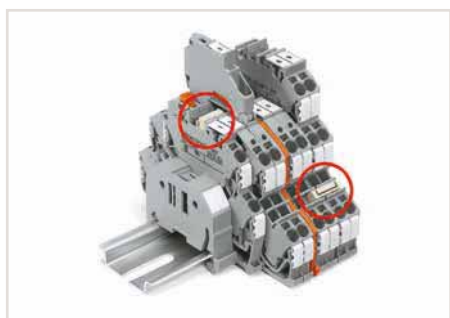

The same profile allows for commoning with TOPJOB® S double-deck terminal blocks (upper deck) and with triple-deck terminal blocks (lower deck).

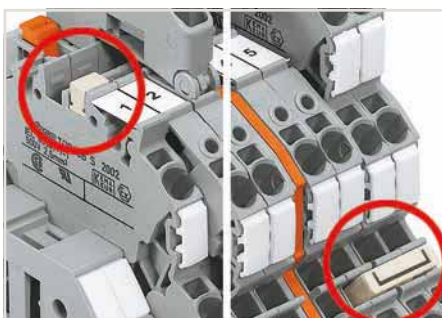

Left picture – Vertical jumper (2002-492)  
Right picture – Push-in type jumper bar (2002 Series)

## TOPJOB® S

### Double-Deck Fuse Terminal Blocks

#### 2.5 (4) mm<sup>2</sup>, 2002 Series

A protective warning marker and an insulation stop must be applied individually. Due to the 6.2 mm width of double-deck terminal blocks, 2004 Series Push-In Type Jumper Bars must be used.

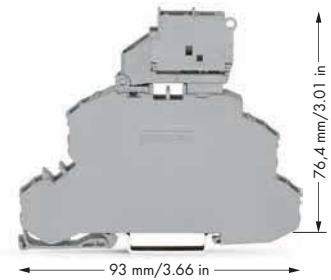

Double-deck fuse disconnect terminal block with a pivoting fuse holder, through/fuse terminal block, for (5 x 20) mm miniature metric fuse, without blown fuse indication, gray  
Electrical ratings are given by the fuse.

	Item No.	Pack. Unit
○ L/L	2002-2611	25
○ N/L	2002-2612	25

Double-deck fuse disconnect terminal block with a pivoting fuse holder, through/fuse terminal block, for (5 x 20) mm miniature metric fuse, with blown fuse indication by LED, gray  
Electrical ratings are given by the fuse and blown fuse indication. Leakage current in case of a blown fuse: LED 2 mA

	Item No.	Pack. Unit
○ 12 ... 30 V	2002-2611/1000-541	25
○ 30 ... 65 V	2002-2611/1000-542	25
○ 120 V	2002-2611/1000-867	25
○ 230 V	2002-2611/1000-836	25



#### Technical Data

Ratings per	
Rated voltage (III / 3)	
Rated surge voltage (III / 3)	
Rated current	
Approval	
Nominal cross section	
<b>Connection Data</b>	
Solid conductor	
Solid conductor, push-in termination	
Fine-stranded conductor	
Fine-stranded conductor with ferrule, push-in termination, min.	
Strip length	
Terminal block width	
Insulation material	

IEC/EN 60947-7-3	
250 V	
6 kV	
6.3 A	
300 V, 6,3 A ; 300 V, 6,3 A	
2.5 mm <sup>2</sup>	
0.25 ... 4 mm <sup>2</sup> / 22 ... 12 AWG	
0.75 ... 4 mm <sup>2</sup> / 18 ... 12 AWG	
0.25 ... 4 mm <sup>2</sup> / 22 ... 12 AWG	
0.75 mm <sup>2</sup> / 18 AWG	
10 ... 12 mm / 0.39 ... 0.47 inch	
6.2 mm / 0.244 inch	
Polyamide 66 (PA 66)	

#### Accessories (Selection)

Push-in type jumper bar, insulated, I <sub>n</sub> 32 A, light gray	
End and intermediate plate, 1 mm thick	
WMB Multi marking system, white, 10 strips with 10 markers per card, 5 ... 5.2 mm stretchable	
Marking strip, plain, 11 mm wide, 50 m reel	

	Item No.	Page
2-way	2004-402	169
orange	2002-2692	167
plain	793-5501	780
white	2009-110	783

Push-in type jumper bars (2004 Series), see page 169

Accessories (end plates, etc.), see page 167

Carrier rails and tools, see Section 13

Appropriate marking system, WMB/WMB Inline/marketing strips, see Full Line Catalog, Volume 6

Approvals and corresponding ratings, visit [www.wago.com](http://www.wago.com)

# TOPJOB® S

## Triple-Deck Terminal Blocks

### 2.5 (4) mm<sup>2</sup>, 2002 Series

1

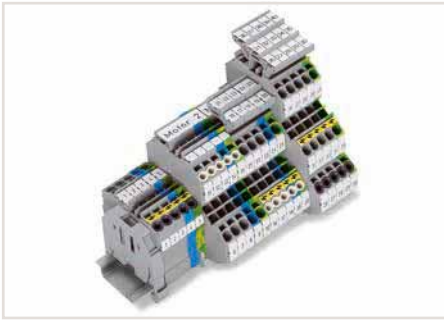

Combining multilevel terminal blocks.



Internally commoned triple-deck terminal block as 6-conductor through terminal block with violet conductor entry



Triple-deck vertical jumpers (2002-493) common the three levels of triple-deck terminal blocks.

Rail-mount terminal blocks with an Ex e II applications. Terminal blocks with a blue insulated housing are suitable for Ex i applications.

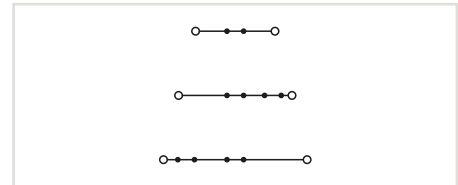
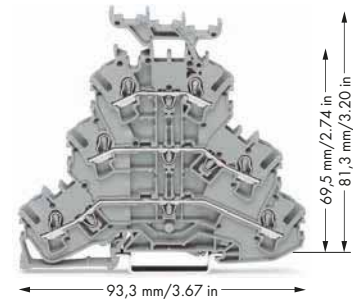

Triple-deck terminal block, through/through/through terminal block, with marker carrier

	Item No.	Pack. Unit
○ L/L/L ⊕	2002-3231	50
○ L/L/N ⊕	2002-3232	50
● N/N/N ⊕	2002-3234	50

Triple-deck terminal block, through/through/through terminal block, no marker carrier

	Item No.	Pack. Unit
○ L/L/L ⊕	2002-3201	50
○ L/L/N ⊕	2002-3202	50
● N/N/N ⊕	2002-3204	50



#### Technical Data

Ratings per	IEC/EN 60947-7-1
Rated voltage (III / 3)	500 V
Rated surge voltage (III / 3)	6 kV
Rated current	24 A
Rated voltage EN (Ex e II)	440 V
Nominal current (Ex e II)	19 A
Nominal current (Ex e II) with jumper	17 A
Rated current (2)	28 A
Approval	600 V, 20 A  600 V, 20 A
Nominal cross section	2.5 mm <sup>2</sup>

#### Connection Data

Solid conductor	0.25 ... 4 mm <sup>2</sup> / 22 ... 12 AWG
Solid conductor, push-in termination	0.75 ... 4 mm <sup>2</sup> / 18 ... 12 AWG
Fine-stranded conductor	0.25 ... 4 mm <sup>2</sup> / 22 ... 12 AWG
Fine-stranded conductor with ferrule, push-in termination, min.	0.75 mm <sup>2</sup> / 18 AWG
Strip length	10 ... 12 mm / 0.39 ... 0.47 inch
Terminal block width	5.2 mm / 0.205 inch
Insulation material	Polyamide 66 (PA 66)

#### Accessories (Selection)

Push-in type jumper bar, insulated, I <sub>n</sub> 25 A, light gray	
End and intermediate plate, 0.8 mm thick	
WMB Inline, plain, 1,500 WMB markers (5 mm) per reel, 5 ... 5.2 mm stretchable	
Marking strip, plain, 11 mm wide, 50 m reel	

	Item No.	Page
2-way	2002-402	164
orange	2002-3292	167
white	2009-115	780
white	2009-110	783

Accessories (jumpers, end plates, test plugs, etc.), see page 164

Carrier rails and tools, see Section 13

Appropriate marking system, WMB/WMB Inline/markings strips, see Full Line Catalog, Volume 6

Information on hazardous locations, see Section 14

Approvals and corresponding ratings, visit [www.wago.com](http://www.wago.com)

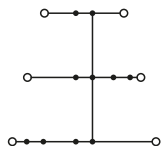
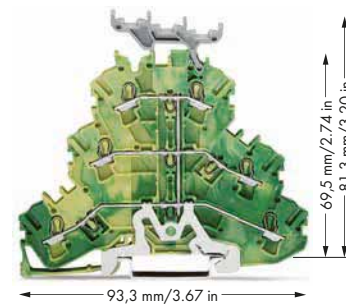
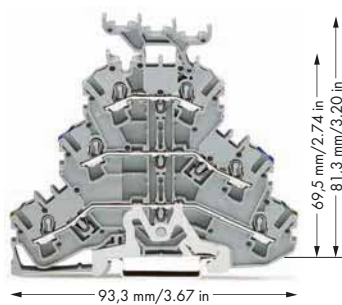
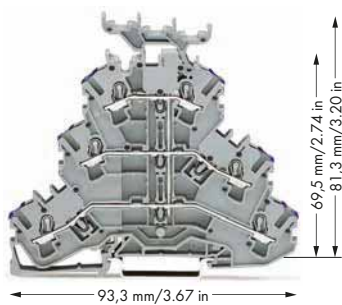

Triple-deck terminal block, 6-conductor through terminal block, with marker carrier, internally commoned, violet conductor entry

	Item No.	Pack. Unit
○ L ⊕	2002-3238	50
● N ⊕	2002-3239	50

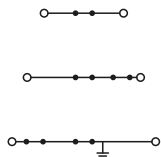

Triple-deck terminal block, ground conductor/through/through terminal block, with marker carrier

	Item No.	Pack. Unit
○ PE/N/L ⊕	2002-3247	50
○ PE/L/L ⊕	2002-3257	50
○ Shield/N/L	2002-3248	50
○ Shield/L/L	2002-3258	50

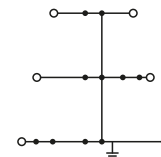

Triple-deck terminal block, 6-conductor ground terminal block, with marker carrier, internally commoned

	Item No.	Pack. Unit
● PE ⊕	2002-3237	50

Triple-deck terminal block, 6-conductor through terminal block, no marker carrier, internally commoned, violet conductor entry

	Item No.	Pack. Unit
○ L ⊕	2002-3208	50
● N ⊕	2002-3209	50

Triple-deck terminal block, ground conductor/through/through terminal block, no marker carrier

	Item No.	Pack. Unit
○ PE/N/L ⊕	2002-3217	50
○ PE/L/L ⊕	2002-3227	50
○ Shield/N/L	2002-3218	50
○ Shield/L/L	2002-3228	50

Triple-deck terminal block, 6-conductor ground terminal block, no marker carrier, internally commoned

	Item No.	Pack. Unit
● PE ⊕	2002-3207	50



IEC/EN 60947-7-1

500 V  
6 kV  
24 A  
440 V  
19 A  
17 A  
28 A  
600 V, 20 A ; 600 V, 20 A

0.25 ... 4 mm<sup>2</sup> / 22 ... 12 AWG  
0.75 ... 4 mm<sup>2</sup> / 18 ... 12 AWG  
0.25 ... 4 mm<sup>2</sup> / 22 ... 12 AWG  
0.75 mm<sup>2</sup> / 18 AWG

10 ... 12 mm / 0.39 ... 0.47 inch  
5.2 mm / 0.205 inch  
Polyamide 66 (PA 66)

	Item No.	Page
2-way	2002-402	164
orange	2002-3292	167
white	2009-115	780
white	2009-110	783

IEC/EN 60947-7-1

500 V  
6 kV  
24 A  
440 V  
19 A  
17 A  
28 A  
600 V, 20 A ; 600 V, 20 A

0.25 ... 4 mm<sup>2</sup> / 22 ... 12 AWG  
0.75 ... 4 mm<sup>2</sup> / 18 ... 12 AWG  
0.25 ... 4 mm<sup>2</sup> / 22 ... 12 AWG  
0.75 mm<sup>2</sup> / 18 AWG

10 ... 12 mm / 0.39 ... 0.47 inch  
5.2 mm / 0.205 inch  
Polyamide 66 (PA 66)

	Item No.	Page
2-way	2002-402	164
orange	2002-3292	167
white	2009-115	780
white	2009-110	783

IEC/EN 60947-7-2

2.5 mm<sup>2</sup>

0.25 ... 4 mm<sup>2</sup> / 22 ... 12 AWG  
0.75 ... 4 mm<sup>2</sup> / 18 ... 12 AWG  
0.25 ... 4 mm<sup>2</sup> / 22 ... 12 AWG  
0.75 mm<sup>2</sup> / 18 AWG

10 ... 12 mm / 0.39 ... 0.47 inch  
5.2 mm / 0.205 inch  
Polyamide 66 (PA 66)

	Item No.	Page
2-way	2002-402	164
orange	2002-3292	167
white	2009-115	780
white	2009-110	783



## TOPJOB® S

## Quadruple-Deck, Rail-Mount Terminal Blocks for Electric Motor Wiring

### 2.5 (4) mm<sup>2</sup>, 2002 Series

1



Compact design: Three phases and one ground conductor in a single terminal block

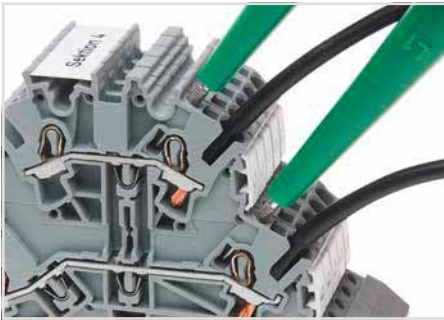

Testing with voltage tester.



Creating spacer housings for electric motor wiring rail-mount terminal blocks via lockout caps (2002-192) for conductor entry and operating slot.

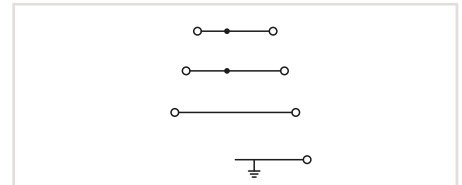
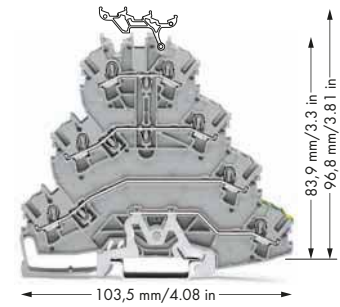

Quadruple-deck, rail-mount terminal block, electric motor wiring rail-mount terminal block, no marker carrier, gray

	Item No.	Pack. Unit
○ L1 - L2 - L3 - PE	2002-4127	25

Quadruple-deck, rail-mount terminal block, electric motor wiring rail-mount terminal block, with marker carrier, gray

	Item No.	Pack. Unit
○ L1 - L2 - L3 - PE	2002-4157	25



#### Technical Data

Ratings per	IEC/EN 60947-7-1
Rated voltage (III / 3)	800 V
Rated surge voltage (III / 3)	8 kV
Rated current	20 A
Rated current (2)	25 A
Approval	300 V, 15 A, 
Nominal cross section	2.5 mm <sup>2</sup>

#### Connection Data

Solid conductor	0.25 ... 4 mm <sup>2</sup> / 22 ... 12 AWG
Solid conductor, push-in termination	0.75 ... 4 mm <sup>2</sup> / 18 ... 12 AWG
Fine-stranded conductor	0.25 ... 4 mm <sup>2</sup> / 22 ... 12 AWG
Fine-stranded conductor with ferrule, push-in termination, min.	0.75 mm <sup>2</sup> / 18 AWG
Strip length	10 ... 12 mm / 0.39 ... 0.47 inch
Terminal block width	5.2 mm / 0.205 inch
Insulation material	Polyamide 66 (PA 66)

#### Accessories (Selection)

	Item No.	Page
Push-in type jumper bar, insulated, I, 25 A, light gray	2002-402	164
End and intermediate plate, 1 mm thick	2002-4192	167
WMB Inline, plain, 1,500 WMB markers (5 mm) per reel, 5 ... 5.2 mm stretchable	2009-115	780
Marking strip, plain, 11 mm wide, 50 m reel	2009-110	783

 Accessories (jumpers, end plates, test plugs, etc.), see page 164

 Carrier rails and tools, see Section 13

 Appropriate marking system, WMB/WMB Inline/marketing strips, see Full Line Catalog, Volume 6

 Approvals and corresponding ratings, visit [www.wago.com](http://www.wago.com)

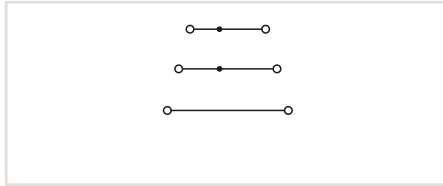
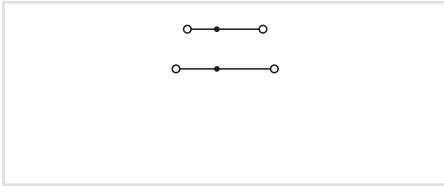
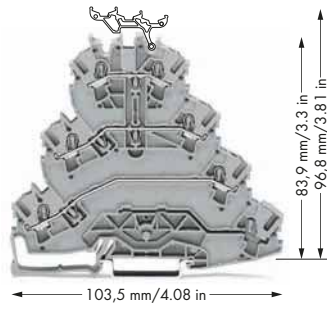
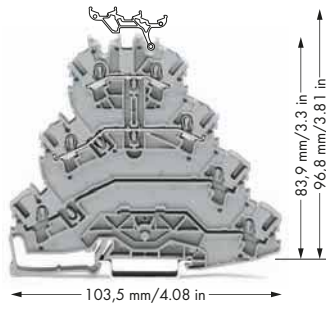

Quadruple-deck, rail-mount terminal block, electric motor wiring rail-mount terminal block, no marker carrier, gray

	Item No.	Pack. Unit
○ L1 - L2	2002-4111	25

Quadruple-deck, rail-mount terminal block, electric motor wiring rail-mount terminal block, no marker carrier, gray

	Item No.	Pack. Unit
○ L1 - L2 - L3	2002-4101	25

Quadruple-deck, rail-mount terminal block, electric motor wiring rail-mount terminal block, with marker carrier, gray

	Item No.	Pack. Unit
○ L1 - L2	2002-4141	25

Quadruple-deck, rail-mount terminal block, electric motor wiring rail-mount terminal block, with marker carrier, gray

	Item No.	Pack. Unit
○ L1 - L2 - L3	2002-4131	25



IEC/EN 60947-7-1
800 V
8 kV
20 A
25 A
600 V, 20 A,
2.5 mm <sup>2</sup>

IEC/EN 60947-7-1
800 V
8 kV
20 A
25 A
600 V, 20 A,
2.5 mm <sup>2</sup>

0.25 ... 4 mm <sup>2</sup> / 22 ... 12 AWG
0.75 ... 4 mm <sup>2</sup> / 18 ... 12 AWG
0.25 ... 4 mm <sup>2</sup> / 22 ... 12 AWG
0.75 mm <sup>2</sup> / 18 AWG

0.25 ... 4 mm <sup>2</sup> / 22 ... 12 AWG
0.75 ... 4 mm <sup>2</sup> / 18 ... 12 AWG
0.25 ... 4 mm <sup>2</sup> / 22 ... 12 AWG
0.75 mm <sup>2</sup> / 18 AWG

10 ... 12 mm / 0.39 ... 0.47 inch
5.2 mm / 0.205 inch
Polyamide 66 (PA 66)

10 ... 12 mm / 0.39 ... 0.47 inch
5.2 mm / 0.205 inch
Polyamide 66 (PA 66)

	Item No.	Page
2-way	2002-402	164
orange	2002-4192	167
white	2009-115	780
white	2009-110	783

	Item No.	Page
2-way	2002-402	164
orange	2002-4192	167
white	2009-115	780
white	2009-110	783

# TOPJOB® S

## Double-Deck Test/Disconnect and Carrier Terminal Blocks

### 2.5 (4) mm<sup>2</sup>, 2002 Series

1

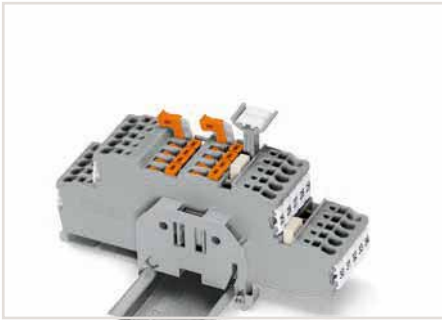

Double-deck, double-disconnect terminal blocks (2002-2951) with group marker carrier accommodated in jumper contact slot

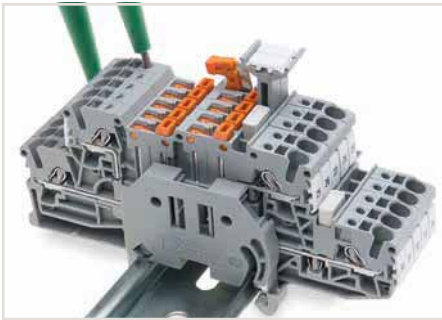

Testing with voltage tester.

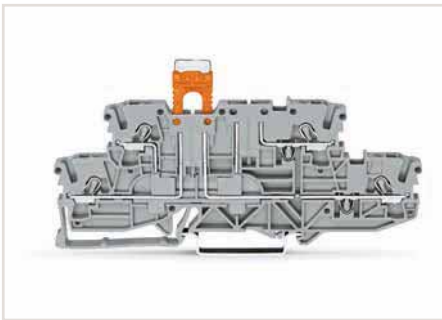

Carrier terminal block (2002-2941) with disconnect plug (2002-401) in parked position

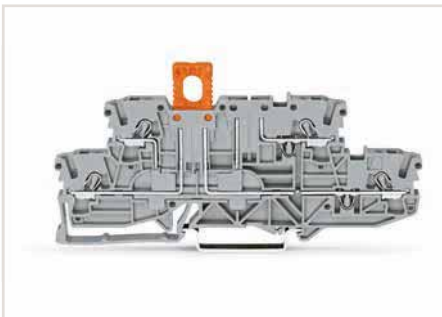

Carrier terminal block (2002-2941) with disconnect plug (2002-401) in operating position

Accessories (jumpers, end plates, test plugs, etc.), see page 164

Carrier rails and tools, see Section 13

Appropriate marking system, WMB/WMB Inline/marketing strips, see Full Line Catalog, Volume 6

Approvals and corresponding ratings, visit [www.wago.com](http://www.wago.com)

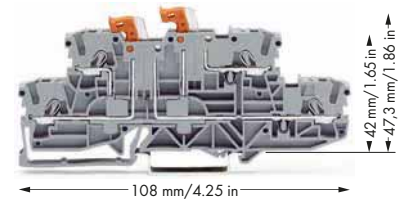

2002-2951

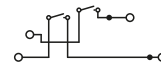

Double-deck, double-disconnect terminal block, with two pivoting knife disconnects

	Item No.	Pack. Unit
○ L/L	2002-2951	50
○ N/L	2002-2952	50
● N/N	2002-2954	50



#### Technical Data

Ratings per	IEC/EN 60947-7-1
Rated voltage (III / 3)	400 V
Rated surge voltage (III / 3)	6 kV
Rated current	16 A
Approval	300 V, 15 A ; 150 V, 15 A
Nominal cross section	2.5 mm <sup>2</sup>
<b>Connection Data</b>	
Solid conductor	0.25 ... 4 mm <sup>2</sup> / 22 ... 12 AWG
Solid conductor, push-in termination	0.75 ... 4 mm <sup>2</sup> / 18 ... 12 AWG
Fine-stranded conductor	0.25 ... 4 mm <sup>2</sup> / 22 ... 12 AWG
Fine-stranded conductor with ferrule, push-in termination, min.	0.75 mm <sup>2</sup> / 18 AWG
Strip length	10 ... 12 mm / 0.39 ... 0.47 inch
Terminal block width	5.2 mm / 0.205 inch
Insulation material	Polyamide 66 (PA 66)

#### Accessories (Selection)

Push-in type jumper bar, insulated, I <sub>n</sub> 25 A, light gray
End and intermediate plate, 1 mm thick
WMB Inline, plain, 1,500 WMB markers (5 mm) per reel, 5 ... 5.2 mm stretchable
Marking strip, plain, 11 mm wide, 50 m reel
Modular TOPJOB® S connector, for jumper contact slot, snaps together

	Item No.	Page
2-way	2002-402	164
orange	2002-2992	167
white	2009-115	780
white	2009-110	783
gray	2002-511	157

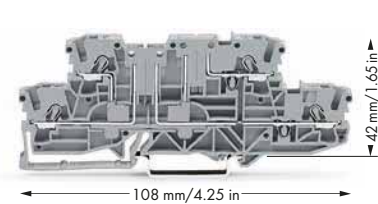
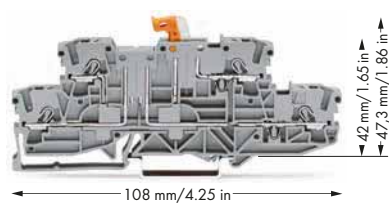
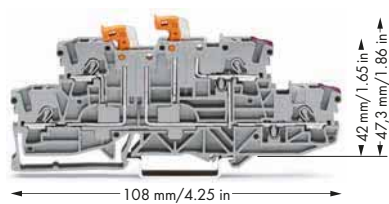

2002-2958

2002-2971

2002-2961

2002-2941

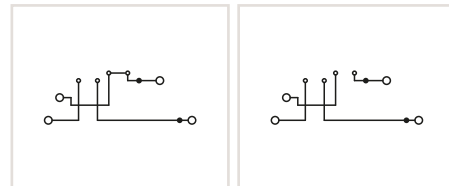
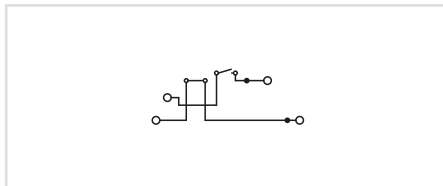
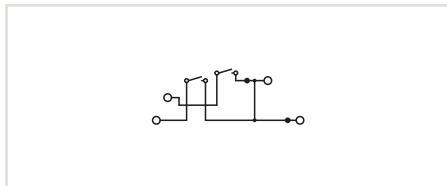

Double-deck, double-disconnect terminal block, with two pivoting knife disconnects, lower and upper decks internally commoned on right side, violet conductor entry

Double-deck disconnect terminal block, with pivoting knife disconnect, same profile as double-deck, double-disconnect terminal block

Double-deck carrier terminal block, lower-deck carrier

	Item No.	Pack. Unit
○ L/L	2002-2958	50
● N/N	2002-2959	50

	Item No.	Pack. Unit
○ L/L	2002-2971	50
○ N/L	2002-2972	50
● N/N	2002-2974	50

	Item No.	Pack. Unit
○ L/L	2002-2961	50
○ L/N	2002-2963	50

Double-deck carrier terminal block, same profile as double-deck, double-disconnect terminal block

	Item No.	Pack. Unit
○ L/L	2002-2941	50
● N/N	2002-2944	50



IEC/EN 60947-7-1
400 V
6 kV
16 A
300 V, 15 A ; 150 V, 15 A
2.5 mm <sup>2</sup>
0.25 ... 4 mm <sup>2</sup> / 22 ... 12 AWG
0.75 ... 4 mm <sup>2</sup> / 18 ... 12 AWG
0.25 ... 4 mm <sup>2</sup> / 22 ... 12 AWG
0.75 mm <sup>2</sup> / 18 AWG
10 ... 12 mm / 0.39 ... 0.47 inch
5.2 mm / 0.205 inch
Polyamide 66 (PA 66)

IEC/EN 60947-7-1
400 V
6 kV
16 A
300 V, 15 A ; 150 V, 15 A
2.5 mm <sup>2</sup>
0.25 ... 4 mm <sup>2</sup> / 22 ... 12 AWG
0.75 ... 4 mm <sup>2</sup> / 18 ... 12 AWG
0.25 ... 4 mm <sup>2</sup> / 22 ... 12 AWG
0.75 mm <sup>2</sup> / 18 AWG
10 ... 12 mm / 0.39 ... 0.47 inch
5.2 mm / 0.205 inch
Polyamide 66 (PA 66)

IEC/EN 60947-7-1
400 V
6 kV
16 A
300 V, 15 A
2.5 mm <sup>2</sup>
0.25 ... 4 mm <sup>2</sup> / 22 ... 12 AWG
0.75 ... 4 mm <sup>2</sup> / 18 ... 12 AWG
0.25 ... 4 mm <sup>2</sup> / 22 ... 12 AWG
0.75 mm <sup>2</sup> / 18 AWG
10 ... 12 mm / 0.39 ... 0.47 inch
5.2 mm / 0.205 inch
Polyamide 66 (PA 66)

	Item No.	Page
2-way	2002-402	164
orange	2002-2992	167
white	2009-115	780
white	2009-110	783
gray	2002-511	157

	Item No.	Page
2-way	2002-402	164
orange	2002-2992	167
white	2009-115	780
white	2009-110	783
gray	2002-511	157

	Item No.	Page
2-way	2002-402	164
orange	2002-2992	167
white	2009-115	780
white	2009-110	783
gray	2002-511	157

# TOPJOB® S – Disconnect/Test Terminal Blocks and Through/Carrier Terminal Blocks of Same Profile

## 2.5 (4) mm<sup>2</sup>, 2002 Series

1

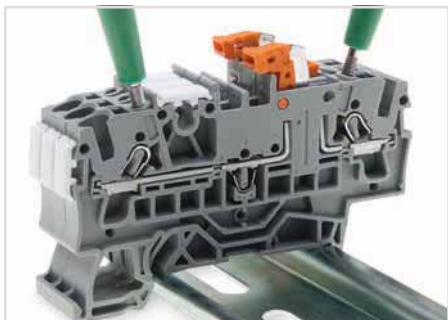

Testing with voltage tester.



Carrier terminal block (2002-1661) with disconnect plug (2002-401) in parked position



Carrier terminal block (2002-1661) with disconnect plug (2002-401) in operating position

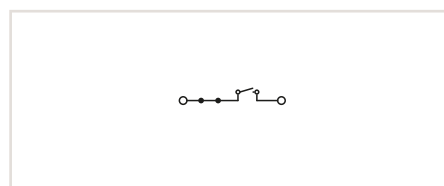
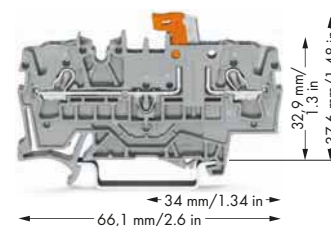

2-conductor disconnect/test terminal block, with test point, orange disconnect link

Color	Item No.	Pack. Unit
○ gray	2002-1671	50
● blue	2002-1674	50



### Technical Data

Ratings per	IEC/EN 60947-7-1
Rated voltage (III / 3)	400 V
Rated surge voltage (III / 3)	6 kV
Rated current	16 A
Approval	300 V, 15 A <b>UL</b> ; 600 V, 10 A <b>CE</b>
Nominal cross section	2.5 mm <sup>2</sup>
<b>Connection Data</b>	
Solid conductor	0.25 ... 4 mm <sup>2</sup> / 22 ... 12 AWG
Solid conductor, push-in termination	0.75 ... 4 mm <sup>2</sup> / 18 ... 12 AWG
Fine-stranded conductor	0.25 ... 4 mm <sup>2</sup> / 22 ... 12 AWG
Fine-stranded conductor with ferrule, push-in termination, min.	0.75 mm <sup>2</sup> / 18 AWG
Strip length	10 ... 12 mm / 0.39 ... 0.47 inch
Terminal block width	5.2 mm / 0.205 inch
Insulation material	Polyamide 66 (PA 66)

### Accessories (Selection)

Push-in type jumper bar, insulated, I <sub>N</sub> 25 A, light gray
End and intermediate plate, 1 mm thick
WMB Inline, plain, 1,500 WMB markers (5 mm) per reel, 5 ... 5.2 mm stretchable
Marking strip, plain, 11 mm wide, 50 m reel
Modular TOPJOB® S connector, for jumper contact slot, snaps together

	Item No.	Page
2-way	2002-402	164
orange	2002-1692	167
white	2009-115	780
white	2009-110	783
gray	2002-511	157

Additional colors, visit [www.wago.com](http://www.wago.com)

Accessories (jumpers, end plates, test plugs, etc.), see page 164

Carrier rails and tools, see Section 13

Appropriate marking system, WMB/WMB Inline/marketing strips, see Full Line Catalog, Volume 6

Approvals and corresponding ratings, visit [www.wago.com](http://www.wago.com)

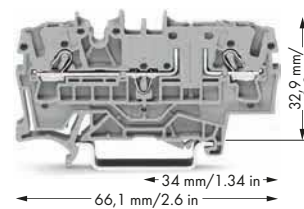
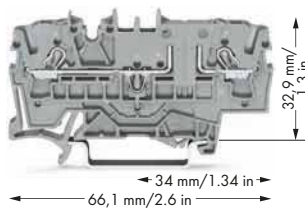
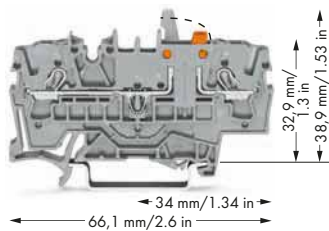

2-conductor disconnect/test terminal block with mechanical interlock, with test point, orange disconnect link

Color	Item No.	Pack. Unit
gray	2002-1671/401-000	50
blue	2002-1674/401-000	50



IEC/EN 60947-7-1  
400 V  
6 kV  
16 A  
300 V, 15 A **VA**; 600 V, 10 A **CE**  
2.5 mm<sup>2</sup>

0.25 ... 4 mm<sup>2</sup> / 22 ... 12 AWG  
0.75 ... 4 mm<sup>2</sup> / 18 ... 12 AWG  
0.25 ... 4 mm<sup>2</sup> / 22 ... 12 AWG  
0.75 mm<sup>2</sup> / 18 AWG

10 ... 12 mm / 0.39 ... 0.47 inch  
5.2 mm / 0.205 inch  
Polyamide 66 (PA 66)

	Item No.	Page
2-way	2002-402	164
orange	2002-1692	167
white	2009-115	780
white	2009-110	783
gray	2002-511	157

2-conductor through terminal block, with test point, same profile as 2-conductor disconnect terminal block

Color	Item No.	Pack. Unit
gray	2002-1601	50
blue	2002-1604	50



IEC/EN 60947-7-1  
400 V  
6 kV  
16 A  
300 V, 15 A **VA**; 600 V, 10 A **CE**  
2.5 mm<sup>2</sup>

0.25 ... 4 mm<sup>2</sup> / 22 ... 12 AWG  
0.75 ... 4 mm<sup>2</sup> / 18 ... 12 AWG  
0.25 ... 4 mm<sup>2</sup> / 22 ... 12 AWG  
0.75 mm<sup>2</sup> / 18 AWG

10 ... 12 mm / 0.39 ... 0.47 inch  
5.2 mm / 0.205 inch  
Polyamide 66 (PA 66)

	Item No.	Page
2-way	2002-402	164
orange	2002-1692	167
white	2009-115	780
white	2009-110	783
gray	2002-511	157

2-conductor carrier block

Color	Item No.	Pack. Unit
gray	2002-1661	50



IEC/EN 60947-7-1  
400 V  
6 kV  
16 A  
300 V, 15 A **VA**; 600 V, 10 A **CE**  
2.5 mm<sup>2</sup>

0.25 ... 4 mm<sup>2</sup> / 22 ... 12 AWG  
0.75 ... 4 mm<sup>2</sup> / 18 ... 12 AWG  
0.25 ... 4 mm<sup>2</sup> / 22 ... 12 AWG  
0.75 mm<sup>2</sup> / 18 AWG

10 ... 12 mm / 0.39 ... 0.47 inch  
5.2 mm / 0.205 inch  
Polyamide 66 (PA 66)

	Item No.	Page
2-way	2002-402	164
orange	2002-1692	167
white	2009-115	780
white	2009-110	783
gray	2002-511	157



# TOPJOB® S – Disconnect/Test Terminal Blocks and Through/Ground/Carrier Terminal Blocks of Same Profile

## 2.5 (4) mm<sup>2</sup>, 2002 Series

1

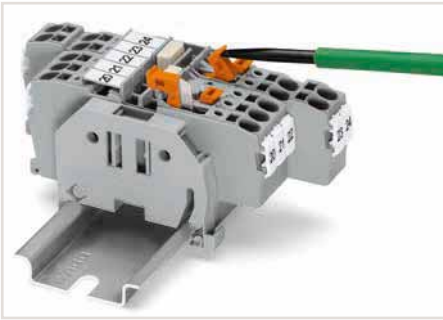

Disconnect/test terminal block with pivoting knife disconnect – opening the knife disconnect.

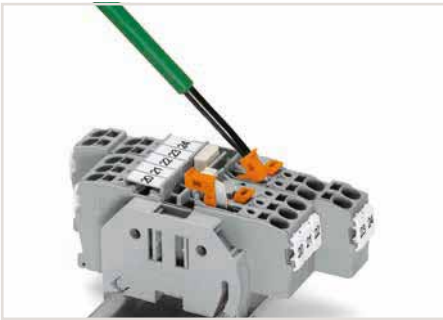

Disconnect/test terminal block with pivoting knife disconnect – closing the knife disconnect.

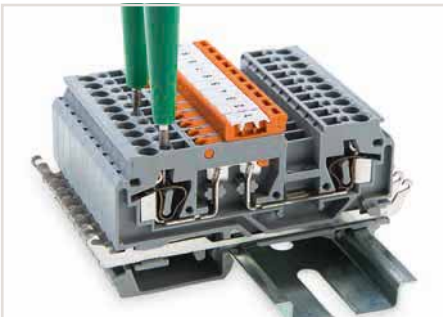

Disconnect/test terminal block with pivoting knife disconnect – testing with voltage tester.

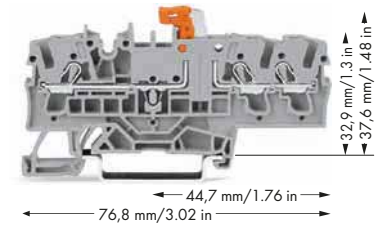

2002-1771

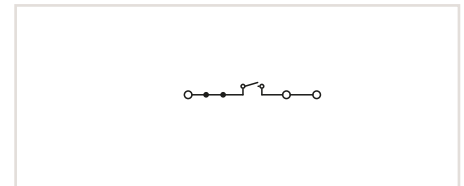

3-conductor disconnect/test terminal block, with test point, orange disconnect link

Color	Item No.	Pack. Unit
gray	2002-1771	50
blue	2002-1774	50



### Technical Data

Ratings per	IEC/EN 60947-7-1
Rated voltage (III / 3)	400 V
Rated surge voltage (III / 3)	6 kV
Rated current	16 A
Approval	300 V, 15 A
Nominal cross section	2.5 mm <sup>2</sup>
<b>Connection Data</b>	
Solid conductor	0.25 ... 4 mm <sup>2</sup> / 22 ... 12 AWG
Solid conductor, push-in termination	0.75 ... 4 mm <sup>2</sup> / 18 ... 12 AWG
Fine-stranded conductor	0.25 ... 4 mm <sup>2</sup> / 22 ... 12 AWG
Fine-stranded conductor with ferrule, push-in termination, min.	0.75 mm <sup>2</sup> / 18 AWG
Strip length	10 ... 12 mm / 0.39 ... 0.47 inch
Terminal block width	5.2 mm / 0.205 inch
Insulation material	Polyamide 66 (PA 66)

### Accessories (Selection)

Push-in type jumper bar, insulated, I <sub>N</sub> 25 A, light gray	
End and intermediate plate, 1 mm thick	
WMB Inline, plain, 1,500 WMB markers (5 mm) per reel, 5 ... 5.2 mm stretchable	
Marking strip, plain, 11 mm wide, 50 m reel	
Modular TOPJOB® S connector, for jumper contact slot, snaps together	

	Item No.	Page
2-way	2002-402	164
orange	2002-1792	167
white	2009-115	780
white	2009-110	783
gray	2002-511	157

Additional colors, visit [www.wago.com](http://www.wago.com)

Accessories (jumpers, end plates, test plugs, etc.), see page 164

Carrier rails and tools, see Section 13

Appropriate marking system, WMB/WMB Inline/marketing strips, see Full Line Catalog, Volume 6

Approvals and corresponding ratings, visit [www.wago.com](http://www.wago.com)

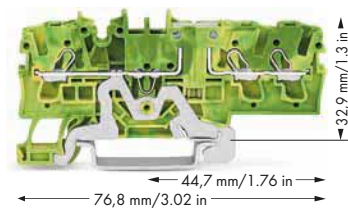
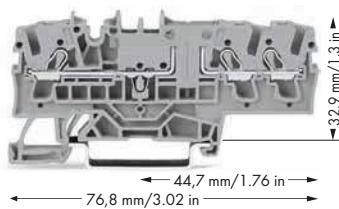
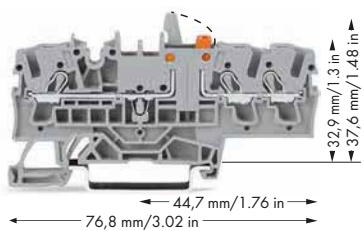

2002-1771/401-000

2002-1701

2002-1761

2002-1707

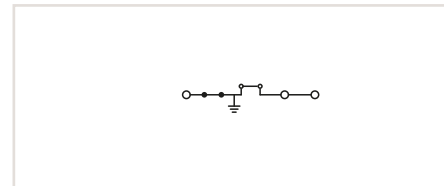
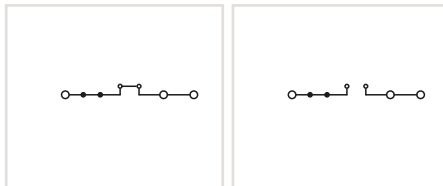
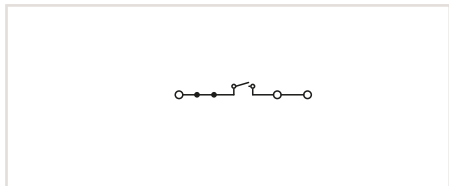

3-conductor disconnect/test terminal block with mechanical interlock, with test point, orange disconnect link

Color	Item No.	Pack. Unit
gray	2002-1771/401-000	50
blue	2002-1774/401-000	50

3-conductor through terminal block, with test point, same profile as 3-conductor disconnect terminal block

Color	Item No.	Pack. Unit
gray	2002-1701	50
blue	2002-1704	50

3-conductor ground terminal block, with test point, same profile as 3-conductor disconnect terminal block

Color	Item No.	Pack. Unit
green-yellow	2002-1707	50

3-conductor carrier terminal block

Color	Item No.	Pack. Unit
gray	2002-1761	50



IEC/EN 60947-7-1

400 V

6 kV

16 A

300 V, 15 A

2.5 mm<sup>2</sup>

0.25 ... 4 mm<sup>2</sup> / 22 ... 12 AWG

0.75 ... 4 mm<sup>2</sup> / 18 ... 12 AWG

0.25 ... 4 mm<sup>2</sup> / 22 ... 12 AWG

0.75 mm<sup>2</sup> / 18 AWG

10 ... 12 mm / 0.39 ... 0.47 inch

5.2 mm / 0.205 inch

Polyamide 66 (PA 66)

IEC/EN 60947-7-1

400 V

6 kV

16 A

300 V, 15 A

2.5 mm<sup>2</sup>

0.25 ... 4 mm<sup>2</sup> / 22 ... 12 AWG

0.75 ... 4 mm<sup>2</sup> / 18 ... 12 AWG

0.25 ... 4 mm<sup>2</sup> / 22 ... 12 AWG

0.75 mm<sup>2</sup> / 18 AWG

10 ... 12 mm / 0.39 ... 0.47 inch

5.2 mm / 0.205 inch

Polyamide 66 (PA 66)

IEC/EN 60947-7-2

2.5 mm<sup>2</sup>

0.25 ... 4 mm<sup>2</sup> / 22 ... 12 AWG

0.75 ... 4 mm<sup>2</sup> / 18 ... 12 AWG

0.25 ... 4 mm<sup>2</sup> / 22 ... 12 AWG

0.75 mm<sup>2</sup> / 18 AWG

10 ... 12 mm / 0.39 ... 0.47 inch

5.2 mm / 0.205 inch

Polyamide 66 (PA 66)

	Item No.	Page
2-way	2002-402	164
orange	2002-1792	167
white	2009-115	780
white	2009-110	783
gray	2002-511	157

	Item No.	Page
2-way	2002-402	164
orange	2002-1792	167
white	2009-115	780
white	2009-110	783
gray	2002-511	157

	Item No.	Page
2-way	2002-402	164
orange	2002-1792	167
white	2009-115	780
white	2009-110	783
gray	2002-511	157

# TOPJOB® S – Disconnect/Test Terminal Blocks and Through/Carrier Terminal Blocks of Same Profile

## 2.5 (4) mm<sup>2</sup>, 2002 Series

1

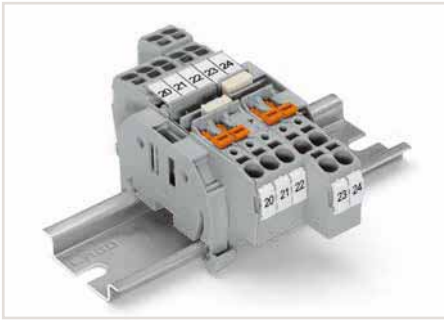

- One center and two side marker slots for WMB markers or marking strips
- Dual jumper slots in the same location as other 2002 Series terminal blocks
- Commoning options in front of or behind the knife disconnect, depending on the power supply direction



Disconnect/test terminal block with pivoting knife disconnect and mechanical interlock – knife disconnect in open position.

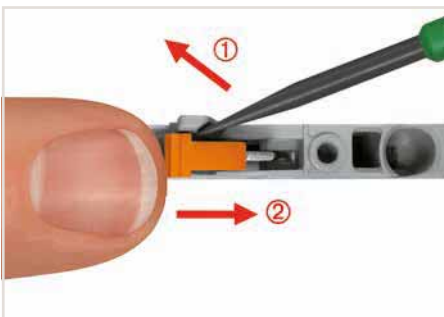

Disconnect/test terminal block with pivoting knife disconnect and mechanical interlock – closing the knife disconnect.

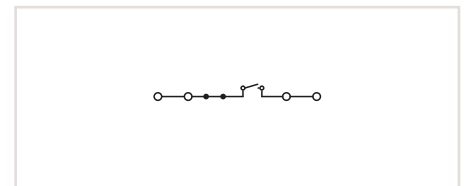
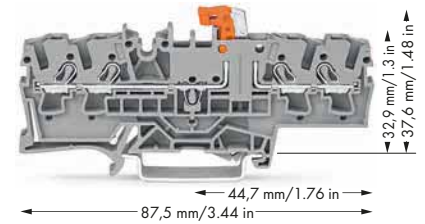

4-conductor disconnect/test terminal block, with test point, orange disconnect link

Color	Item No.	Pack. Unit
gray	2002-1871	50
blue	2002-1874	50



### Technical Data

Ratings per	IEC/EN 60947-7-1
Rated voltage (III / 3)	400 V
Rated surge voltage (III / 3)	6 kV
Rated current	16 A
Approval	300 V, 15 A  600 V, 10 A
Nominal cross section	2.5 mm <sup>2</sup>

### Connection Data

Solid conductor	0.25 ... 4 mm <sup>2</sup> / 22 ... 12 AWG
Solid conductor, push-in termination	0.75 ... 4 mm <sup>2</sup> / 18 ... 12 AWG
Fine-stranded conductor	0.25 ... 4 mm <sup>2</sup> / 22 ... 12 AWG
Fine-stranded conductor with ferrule, push-in termination, min.	0.75 mm <sup>2</sup> / 18 AWG
Strip length	10 ... 12 mm / 0.39 ... 0.47 inch
Terminal block width	5.2 mm / 0.205 inch
Insulation material	Polyamide 66 (PA 66)

### Accessories (Selection)

Push-in type jumper bar, insulated, I <sub>N</sub> 25 A, light gray	
End and intermediate plate, 1 mm thick	
WMB Inline, plain, 1,500 WMB markers (5 mm) per reel, 5 ... 5.2 mm stretchable	
Marking strip, plain, 11 mm wide, 50 m reel	
Modular TOPJOB® S connector, for jumper contact slot, snaps together	

	Item No.	Page
2-way	2002-402	164
orange	2002-1892	167
white	2009-115	780
white	2009-110	783
gray	2002-511	157

Additional colors, visit [www.wago.com](http://www.wago.com)

Accessories (jumpers, end plates, test plugs, etc.), see page 164

Carrier rails and tools, see Section 13

Appropriate marking system, WMB/WMB Inline/markings strips, see Full Line Catalog, Volume 6

Approvals and corresponding ratings, visit [www.wago.com](http://www.wago.com)

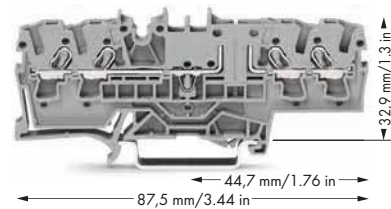
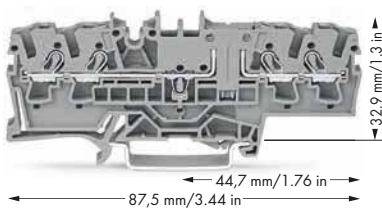
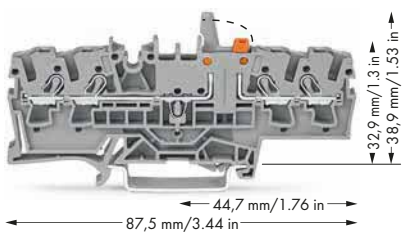

4-conductor disconnect/test terminal block with mechanical interlock, with test point, orange disconnect link

Color	Item No.	Pack. Unit
gray	2002-1871/401-000	50
blue	2002-1874/401-000	50



IEC/EN 60947-7-1  
400 V  
6 kV  
16 A  
300 V, 15 A **VA**; 600 V, 10 A **CE**  
2.5 mm<sup>2</sup>

0.25 ... 4 mm<sup>2</sup> / 22 ... 12 AWG  
0.75 ... 4 mm<sup>2</sup> / 18 ... 12 AWG  
0.25 ... 4 mm<sup>2</sup> / 22 ... 12 AWG  
0.75 mm<sup>2</sup> / 18 AWG

10 ... 12 mm / 0.39 ... 0.47 inch  
5.2 mm / 0.205 inch  
Polyamide 66 (PA 66)

	Item No.	Page
2-way	2002-402	164
orange	2002-1892	167
white	2009-115	780
white	2009-110	783
gray	2002-511	157

4-conductor through terminal block, with test point, same profile as 4-conductor disconnect terminal block

Color	Item No.	Pack. Unit
gray	2002-1801	50
blue	2002-1804	50



IEC/EN 60947-7-1  
400 V  
6 kV  
16 A  
300 V, 15 A **VA**; 600 V, 10 A **CE**  
2.5 mm<sup>2</sup>

0.25 ... 4 mm<sup>2</sup> / 22 ... 12 AWG  
0.75 ... 4 mm<sup>2</sup> / 18 ... 12 AWG  
0.25 ... 4 mm<sup>2</sup> / 22 ... 12 AWG  
0.75 mm<sup>2</sup> / 18 AWG

10 ... 12 mm / 0.39 ... 0.47 inch  
5.2 mm / 0.205 inch  
Polyamide 66 (PA 66)

	Item No.	Page
2-way	2002-402	164
orange	2002-1892	167
white	2009-115	780
white	2009-110	783
gray	2002-511	157

4-conductor carrier block

Color	Item No.	Pack. Unit
gray	2002-1861	50



IEC/EN 60947-7-1  
400 V  
6 kV  
16 A  
300 V, 15 A **VA**; 600 V, 10 A **CE**  
2.5 mm<sup>2</sup>

0.25 ... 4 mm<sup>2</sup> / 22 ... 12 AWG  
0.75 ... 4 mm<sup>2</sup> / 18 ... 12 AWG  
0.25 ... 4 mm<sup>2</sup> / 22 ... 12 AWG  
0.75 mm<sup>2</sup> / 18 AWG

10 ... 12 mm / 0.39 ... 0.47 inch  
5.2 mm / 0.205 inch  
Polyamide 66 (PA 66)

	Item No.	Page
2-way	2002-402	164
orange	2002-1892	167
white	2009-115	780
white	2009-110	783
gray	2002-511	157

# TOPJOB® S

## Fuse Terminal Blocks

### 2.5 (4) mm<sup>2</sup>, 2002 Series

1

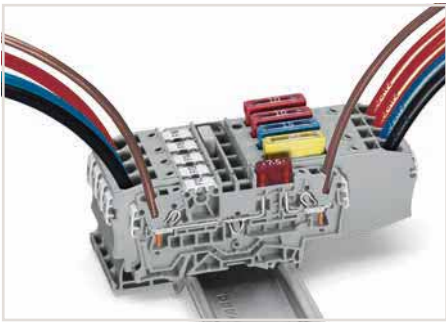

Selecting the correct fuse cartridge is important for product safety within applications, as well as for fuse cartridge service life and reliability. Fuse cartridges can operate perfectly as protection (break-off point) if they are properly selected and used according to manufacturer specifications.

Nominal current ratings for fuse cartridges are defined differently in international standards.

This is why the recommended continuous current-carrying capacity of the fuses a max. 80 % of their nominal current according to DIN 72581/Part 3 (for an ambient operating temperature of 23 °C).

**With regard to product safety, fuse cartridges must generally be tested both under normal and faulty operating conditions within your application.**

Blade-style fuses are not offered by WAGO.

Observe touch-proof protection for 42 V and higher voltages!

- 10 A (individual arrangement)
- 5 A (block arrangement)

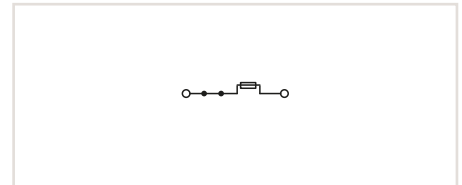
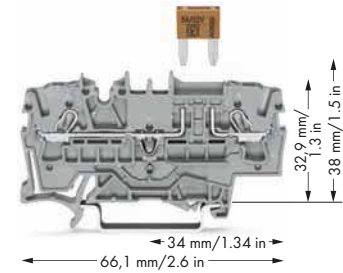

2-conductor fuse terminal block, with test point, for blade-style fuses per DIN 72581-3f, ISO 8820-3

Color	Item No.	Pack. Unit
○ gray	2002-1681	50



#### Technical Data

Ratings per	IEC/EN 60947-7-3
Rated voltage (III / 3)	400 V
Rated surge voltage (III / 3)	6 kV
Rated current	16 A
Approval	300 V, 10 A  600 V, 6.3 A
Nominal cross section	2.5 mm <sup>2</sup>

#### Connection Data

Solid conductor	0.25 ... 4 mm <sup>2</sup> / 22 ... 12 AWG
Solid conductor, push-in termination	0.75 ... 4 mm <sup>2</sup> / 18 ... 12 AWG
Fine-stranded conductor	0.25 ... 4 mm <sup>2</sup> / 22 ... 12 AWG
Fine-stranded conductor with ferrule, push-in termination, min.	0.75 mm <sup>2</sup> / 18 AWG
Strip length	10 ... 12 mm / 0.39 ... 0.47 inch
Terminal block width	5.2 mm / 0.205 inch
Insulation material	Polyamide 66 (PA 66)

#### Note:

Electrical ratings are given by the fuse. Blade-style fuses: Observe touch-proof protection for 42 V and higher voltages!

#### Accessories (Selection)

Push-in type jumper bar, insulated, I <sub>n</sub> 25 A, light gray
End and intermediate plate, 1 mm thick
WMB Inline, plain, 1,500 WMB markers (5 mm) per reel, 5 ... 5.2 mm stretchable
Marking strip, plain, 11 mm wide, 50 m reel
Modular TOPJOB® S connector, for jumper contact slot, snaps together

	Item No.	Page
2-way	2002-402	164
orange	2002-1692	167
white	2009-115	780
white	2009-110	783
gray	2002-511	157

Applications notes on fuses, see page 33

Accessories (jumpers, end plates, test plugs, etc.), see page 164

Carrier rails and tools, see Section 13

Appropriate marking system, WMB/WMB Inline/markings strips, see Full Line Catalog, Volume 6

Approvals and corresponding ratings, visit [www.wago.com](http://www.wago.com)

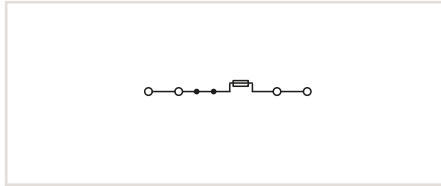
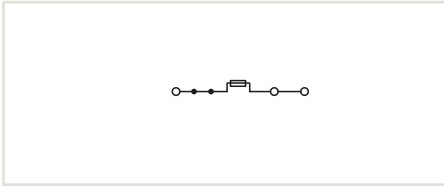
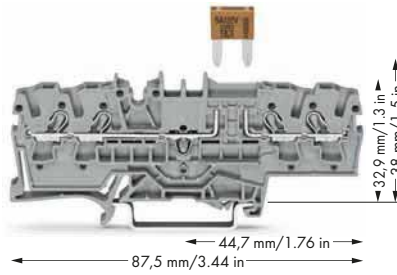
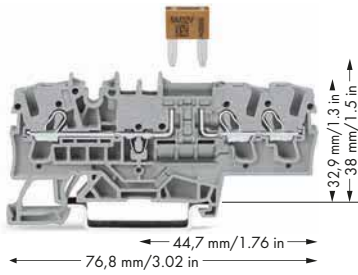

3-conductor fuse terminal block, with test point, for blade-style fuses per DIN 72581-3f, ISO 8820-3

Color	Item No.	Pack. Unit
○ gray	2002-1781	50



IEC/EN 60947-7-3

400 V

6 kV

16 A

300 V, 10 A ; 600 V, 10 A

2.5 mm<sup>2</sup>

0.25 ... 4 mm<sup>2</sup> / 22 ... 12 AWG

0.75 ... 4 mm<sup>2</sup> / 18 ... 12 AWG

0.25 ... 4 mm<sup>2</sup> / 22 ... 12 AWG

0.75 mm<sup>2</sup> / 18 AWG

10 ... 12 mm / 0.39 ... 0.47 inch

5.2 mm / 0.205 inch

Polyamide 66 (PA 66)

Electrical ratings are given by the fuse.  
Blade-style fuses: Observe touch-proof protection for 42 V and higher voltages!

	Item No.	Page
2-way	2002-402	164
orange	2002-1792	167
white	2009-115	780
white	2009-110	783
gray	2002-511	157

4-conductor fuse terminal block, with test point, for blade-style fuses per DIN 72581-3f, ISO 8820-3

Color	Item No.	Pack. Unit
○ gray	2002-1881	50



IEC/EN 60947-7-3

400 V

6 kV

16 A

300 V, 10 A ; 600 V, 10 A

2.5 mm<sup>2</sup>

0.25 ... 4 mm<sup>2</sup> / 22 ... 12 AWG

0.75 ... 4 mm<sup>2</sup> / 18 ... 12 AWG

0.25 ... 4 mm<sup>2</sup> / 22 ... 12 AWG

0.75 mm<sup>2</sup> / 18 AWG

10 ... 12 mm / 0.39 ... 0.47 inch

5.2 mm / 0.205 inch

Polyamide 66 (PA 66)

Electrical ratings are given by the fuse.  
Blade-style fuses: Observe touch-proof protection for 42 V and higher voltages!

	Item No.	Page
2-way	2002-402	164
orange	2002-1892	167
white	2009-115	780
white	2009-110	783
gray	2002-511	157



# TOPJOB® S – Fused Disconnect Terminal Blocks with a Pivoting Fuse Holder for (5 x 20) mm Miniature Metric Fuses

## 2.5 (4) mm<sup>2</sup>, 2002 Series

1



Fuse terminal blocks with a width of 6.2 mm can be assembled adjacently. If there is no adjacent fuse terminal block at the end of the assembly, an end plate must be used.

A protective warning marker and an insulation stop must be applied individually. Due to the 6.2 mm width of double-deck terminal blocks, 2004 Series Push-In Type Jumper Bars must be used.

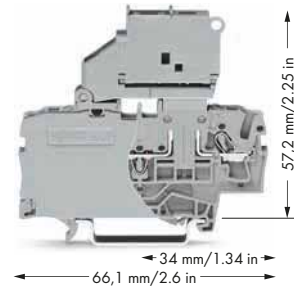

Miniature fuses 5 x 20				
Series Item No.	Overload and short circuit protection		Short circuit protection only	
	Individual argmt.	Group argmt.	Individual argmt.	Group argmt.
Fuse terminal blocks				
2002-1611 2002-1811	1.6 W	1.6 W	2.5 W	2.5 W
2002-1611/..... 2002-1811/.....	1.6 W	1.6 W	2.5 W	2.5 W

When selecting miniature metric fuses, make sure that the maximum power loss listed above is not exceeded. The power loss is determined according to IEC or EN 60947-7-3/VDE 0611-6 at 23 °C. The temperature rise of the terminal blocks must be checked according to their application and mounting. Higher ambient temperatures place additional strain on fuse cartridges. Therefore, in such applications, the rated current must be reduced if necessary. More details are available from the fuse manufacturers.



Fused disconnect terminal block with a pivoting fuse holder – replacing a fuse.

### Technical Data

Ratings per	IEC/EN 60947-7-3
Rated voltage (III / 3)	250 V
Rated surge voltage (III / 3)	6 kV
Rated current	6.3 A
Approval	250 V, 6.3 A ; 250 V, 6.3 A
Nominal cross section	2.5 mm <sup>2</sup>
<b>Connection Data</b>	
Solid conductor	0.25 ... 4 mm <sup>2</sup> / 22 ... 12 AWG
Solid conductor, push-in termination	0.75 ... 4 mm <sup>2</sup> / 18 ... 12 AWG
Fine-stranded conductor	0.25 ... 4 mm <sup>2</sup> / 22 ... 12 AWG
Fine-stranded conductor with ferrule, push-in termination, min.	0.75 mm <sup>2</sup> / 18 AWG
Strip length	10 ... 12 mm / 0.39 ... 0.47 inch
Terminal block width	6.2 mm / 0.244 inch
Insulation material	Polyamide 66 (PA 66)

### Accessories (Selection)

Push-in type jumper bar, insulated, I <sub>n</sub> 32 A, light gray
End plate for fuse terminal blocks, 2 mm thick
WMB Multi marking system, white, 10 strips with 10 markers per card, 5 ... 5.2 mm stretchable
Marking strip, plain, 11 mm wide, 50 m reel

2002-1611

2002-1611/1000-541

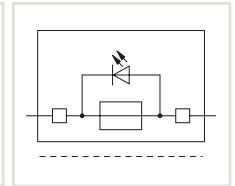
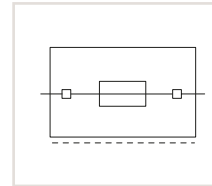

2-conductor fused disconnect terminal block with a pivoting fuse holder, for (5 x 20) mm miniature metric fuse, without blown fuse indication. Electrical ratings are given by the fuse.

Color	Item No.	Pack. Unit
gray	2002-1611	50

2-conductor fused disconnect terminal block with a pivoting fuse holder, for (5 x 20) mm miniature metric fuse, with blown fuse indication by LED, gray. Electrical ratings are given by the fuse and blown fuse indication. Leakage current in case of a blown fuse: LED 2 mA

	Item No.	Pack. Unit
15 ... 30 V	2002-1611/1000-541	50
30 ... 65 V	2002-1611/1000-542	50
120 V	2002-1611/1000-867	50
230 V	2002-1611/1000-836	50



- Push-in type jumper bars (2004 Series), see page 169
- Accessories (end plates, etc.), see page 167
- Carrier rails and tools, see Section 13
- Appropriate marking system, WMB/WMB Inline/marketing strips, see Full Line Catalog, Volume 6
- Approvals and corresponding ratings, visit [www.wago.com](http://www.wago.com)

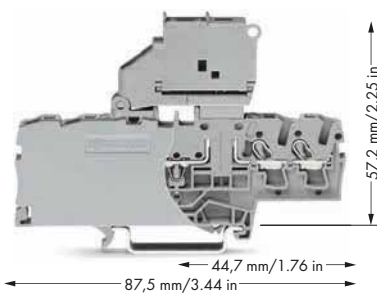
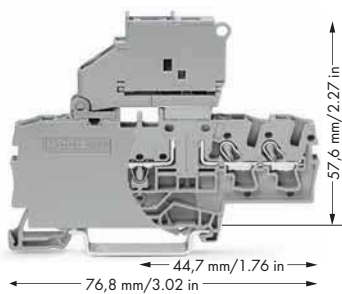

2002-1711

2002-1711/1000-541

2002-1811

2002-1811/1000-541

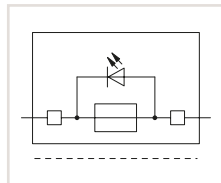
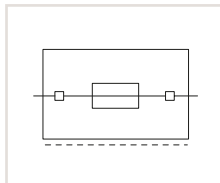

3-conductor fused disconnect terminal block with a pivoting fuse holder, for (5 x 20) mm miniature metric fuse, without blown fuse indication  
Electrical ratings are given by the fuse.

Color	Item No.	Pack. Unit
○ gray	2002-1711	50

3-conductor fused disconnect terminal block with a pivoting fuse holder, for (5 x 20) mm miniature metric fuse, with blown fuse indication by LED, gray  
Electrical ratings are given by the fuse and blown fuse indication. Leakage current in case of a blown fuse: LED 2 mA

	Item No.	Pack. Unit
○ 15 ... 30 V	2002-1711/1000-541	50
○ 30 ... 65 V	2002-1711/1000-542	50
○ 120 V	2002-1711/1000-867	50
○ 230 V	2002-1711/1000-836	50

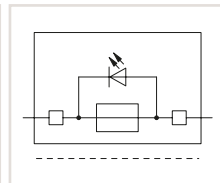
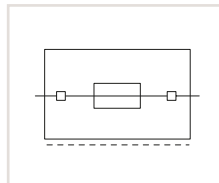

4-conductor fused disconnect terminal block with a pivoting fuse holder, for (5 x 20) mm miniature metric fuse, without blown fuse indication  
Electrical ratings are given by the fuse.

Color	Item No.	Pack. Unit
○ gray	2002-1811	50

4-conductor fused disconnect terminal block with a pivoting fuse holder, for (5 x 20) mm miniature metric fuse, with blown fuse indication by LED, gray  
Electrical ratings are given by the fuse and blown fuse indication. Leakage current in case of a blown fuse: LED 2 mA

	Item No.	Pack. Unit
○ 15 ... 30 V	2002-1811/1000-541	50
○ 30 ... 65 V	2002-1811/1000-542	50
○ 120 V	2002-1811/1000-867	50
○ 230 V	2002-1811/1000-836	50



IEC/EN 60947-7-3
250 V
6 kV
6.3 A
250 V, 6.3 A <b>UL</b>
2.5 mm <sup>2</sup>

0.25 ... 4 mm <sup>2</sup> / 22 ... 12 AWG
0.75 ... 4 mm <sup>2</sup> / 18 ... 12 AWG
0.25 ... 4 mm <sup>2</sup> / 22 ... 12 AWG
0.75 mm <sup>2</sup> / 18 AWG

10 ... 12 mm / 0.39 ... 0.47 inch
6.2 mm / 0.244 inch
Polyamide 66 (PA 66)

	Item No.	Page
2-way	2004-402	169
orange	2002-992	167
plain	793-5501	780
white	2009-110	783



IEC/EN 60947-7-3
250 V
6 kV
6.3 A
250 V, 6.3 A <b>UL</b> ; 250 V, 6.3 A <b>UL</b>
2.5 mm <sup>2</sup>

0.25 ... 4 mm <sup>2</sup> / 22 ... 12 AWG
0.75 ... 4 mm <sup>2</sup> / 18 ... 12 AWG
0.25 ... 4 mm <sup>2</sup> / 22 ... 12 AWG
0.75 mm <sup>2</sup> / 18 AWG

10 ... 12 mm / 0.39 ... 0.47 inch
6.2 mm / 0.244 inch
Polyamide 66 (PA 66)

	Item No.	Page
2-way	2004-402	169
orange	2002-992	167
plain	793-5501	780
white	2009-110	783

# TOPJOB® S – Disconnect/Test Terminal Blocks and Through/Ground/Carrier Terminal Blocks with Additional Jumper Slot

## 2.5 (4) mm<sup>2</sup>, 2002 Series

1

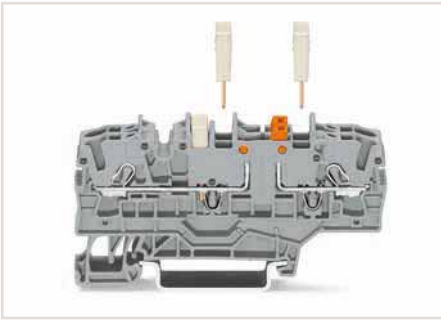

Three jumper slots available

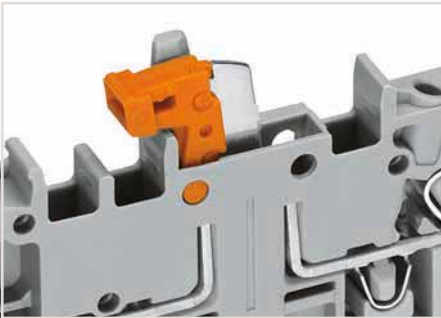

Disconnect/test terminal block with pivoting knife disconnect and mechanical interlock – knife disconnect in open position



Disconnect/test terminal block with pivoting knife disconnect and mechanical interlock – top view

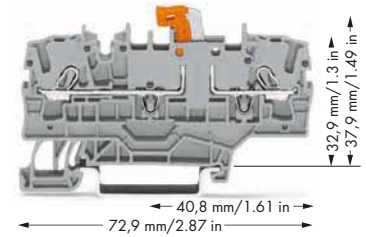

2002-1971

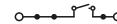

2-conductor disconnect/test terminal block, with test point, orange disconnect link and additional jumper slot

Color	Item No.	Pack. Unit
gray	2002-1971	50
blue	2002-1974	50



### Technical Data

Ratings per	IEC/EN 60947-7-1
Rated voltage (III / 3)	400 V
Rated surge voltage (III / 3)	6 kV
Rated current	16 A
Approval	300 V, 15 A  , 600 V, 10 A 
Nominal cross section	2.5 mm <sup>2</sup>

### Connection Data

Solid conductor	0.25 ... 4 mm <sup>2</sup> / 22 ... 12 AWG
Solid conductor, push-in termination	0.75 ... 4 mm <sup>2</sup> / 18 ... 12 AWG
Fine-stranded conductor	0.25 ... 4 mm <sup>2</sup> / 22 ... 12 AWG
Fine-stranded conductor with ferrule, push-in termination, min.	0.75 mm <sup>2</sup> / 18 AWG
Strip length	10 ... 12 mm / 0.39 ... 0.47 inch
Terminal block width	5.2 mm / 0.205 inch
Insulation material	Polyamide 66 (PA 66)

### Accessories (Selection)

Push-in type jumper bar, insulated, I <sub>N</sub> 25 A, light gray	
End and intermediate plate, 1 mm thick	
WMB Inline, plain, 1,500 WMB markers (5 mm) per reel, 5 ... 5.2 mm stretchable	
Marking strip, plain, 11 mm wide, 50 m reel	
Modular TOPJOB® S connector, for jumper contact slot, snaps together	

	Item No.	Page
2-way	2002-402	164
orange	2002-1992	167
white	2009-115	780
white	2009-110	783
gray	2002-511	157

 Additional colors, visit [www.wago.com](http://www.wago.com)

 Accessories (jumpers, end plates, test plugs, etc.), see page 164

 Carrier rails and tools, see Section 13

 Appropriate marking system, WMB/WMB Inline/markings strips, see Full Line Catalog, Volume 6

 Approvals and corresponding ratings, visit [www.wago.com](http://www.wago.com)

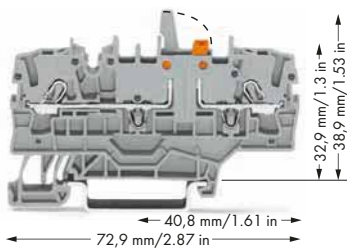

2002-1971/401-000

2-conductor disconnect/test terminal block with mechanical interlock, with test point, orange disconnect link and additional jumper slot		
Color	Item No.	Pack. Unit
gray	2002-1971/401-000	50
blue	2002-1974/401-000	50

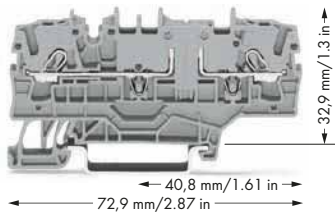

2002-1901

2002-1961

2-conductor through terminal block, with test point and additional jumper slot, same profile as 2-conductor disconnect terminal block		
Color	Item No.	Pack. Unit
gray	2002-1901	50
blue	2002-1904	50

2-conductor carrier terminal block, with additional jumper slot		
Color	Item No.	Pack. Unit
gray	2002-1961	50

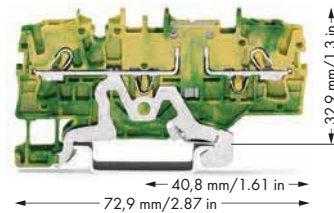

2002-1907

2-conductor ground terminal block, with test point and additional jumper slot, same profile as 2-conductor disconnect terminal block		
Color	Item No.	Pack. Unit
green-yellow	2002-1907	50



IEC/EN 60947-7-1  
400 V  
6 kV  
16 A  
300 V, 15 A **UL**; 600 V, 10 A **CE**  
2.5 mm<sup>2</sup>

0.25 ... 4 mm<sup>2</sup> / 22 ... 12 AWG  
0.75 ... 4 mm<sup>2</sup> / 18 ... 12 AWG  
0.25 ... 4 mm<sup>2</sup> / 22 ... 12 AWG  
0.75 mm<sup>2</sup> / 18 AWG

10 ... 12 mm / 0.39 ... 0.47 inch  
5.2 mm / 0.205 inch  
Polyamide 66 (PA 66)

	Item No.	Page
2-way	2002-402	164
orange	2002-1992	167
white	2009-115	780
white	2009-110	783
gray	2002-511	157



IEC/EN 60947-7-1  
400 V  
6 kV  
16 A  
300 V, 15 A **UL**; 600 V, 10 A **CE**  
2.5 mm<sup>2</sup>

0.25 ... 4 mm<sup>2</sup> / 22 ... 12 AWG  
0.75 ... 4 mm<sup>2</sup> / 18 ... 12 AWG  
0.25 ... 4 mm<sup>2</sup> / 22 ... 12 AWG  
0.75 mm<sup>2</sup> / 18 AWG

10 ... 12 mm / 0.39 ... 0.47 inch  
5.2 mm / 0.205 inch  
Polyamide 66 (PA 66)

	Item No.	Page
2-way	2002-402	164
orange	2002-1992	167
white	2009-115	780
white	2009-110	783
gray	2002-511	157



IEC/EN 60947-7-2  
2.5 mm<sup>2</sup>

0.25 ... 4 mm<sup>2</sup> / 22 ... 12 AWG  
0.75 ... 4 mm<sup>2</sup> / 18 ... 12 AWG  
0.25 ... 4 mm<sup>2</sup> / 22 ... 12 AWG  
0.75 mm<sup>2</sup> / 18 AWG

10 ... 12 mm / 0.39 ... 0.47 inch  
5.2 mm / 0.205 inch  
Polyamide 66 (PA 66)

	Item No.	Page
2-way	2002-402	164
orange	2002-1992	167
white	2009-115	780
white	2009-110	783
gray	2002-511	157

## TOPJOB® S

### Fuse Terminal Blocks with Additional Jumper Slot

#### 2.5 (4) mm<sup>2</sup>, 2002 Series

1

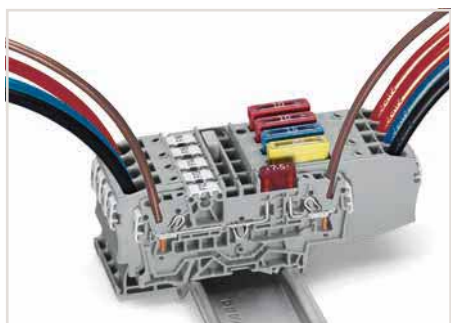

Selecting the correct fuse cartridge is important for product safety within applications, as well as for fuse cartridge service life and reliability. Fuse cartridges can operate perfectly as protection (break-off point) if they are properly selected and used according to manufacturer specifications.

Nominal current ratings for fuse cartridges are defined differently in international standards.

This is why the recommended continuous current-carrying capacity of the fuses is a max. 80 % of their nominal current according to DIN 72581/Part 3 (for an ambient operating temperature of 23 °C).

With regard to product safety, fuse cartridges must generally be tested both under normal and faulty operating conditions within your application.

Blade-style fuses are not offered by WAGO.

Observe touch-proof protection for 42 V and higher voltages!

- 10 A (individual arrangement)
- 5 A (block arrangement)

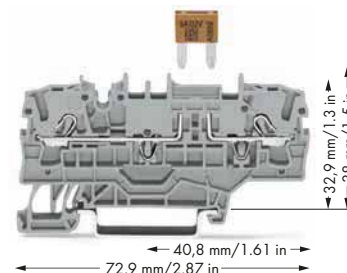

2-conductor fuse terminal block, with test point, for blade-style fuses per DIN 72581-3f, ISO 8820-3, without blown fuse indication, with additional jumper slot

Color	Item No.	Pack. Unit
● gray	2002-1981	50



#### Technical Data

Ratings per	IEC/EN 60947-7-3
Rated voltage (III / 3)	400 V
Rated surge voltage (III / 3)	6 kV
Rated current	10 A
Approval	250 V, 10 A ; 600 V, 6.3 A
Nominal cross section	2.5 mm <sup>2</sup>

#### Connection Data

Solid conductor	0.25 ... 4 mm <sup>2</sup> / 22 ... 12 AWG
Solid conductor, push-in termination	0.75 ... 4 mm <sup>2</sup> / 18 ... 12 AWG
Fine-stranded conductor	0.25 ... 4 mm <sup>2</sup> / 22 ... 12 AWG
Fine-stranded conductor with ferrule, push-in termination, min.	0.75 mm <sup>2</sup> / 18 AWG
Strip length	10 ... 12 mm / 0.39 ... 0.47 inch
Terminal block width	5.2 mm / 0.205 inch
Insulation material	Polyamide 66 (PA 66)

**Note:** Electrical ratings are given by the fuse. Blade-style fuses: Observe touch-proof protection for 42 V and higher voltages!

#### Accessories (Selection)

	Item No.	Page
Push-in type jumper bar, insulated, I <sub>n</sub> 25 A, light gray	2002-402	164
End and intermediate plate, 1 mm thick	orange 2002-1992	167
WMB Inline, plain, 1,500 WMB markers (5 mm) per reel, 5 ... 5.2 mm stretchable	white 2009-115	780
Marking strip, plain, 11 mm wide, 50 m reel	white 2009-110	783

Applications notes on fuses, see page 33

Accessories (jumpers, end plates, test plugs, etc.), see page 164

Carrier rails and tools, see Section 13

Appropriate marking system, WMB/WMB Inline/markings strips, see Full Line Catalog, Volume 6

Approvals and corresponding ratings, visit [www.wago.com](http://www.wago.com)

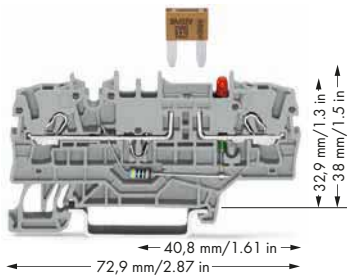

2002-1981/1000-429

2002-1981/1000-449

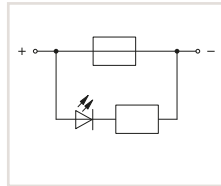
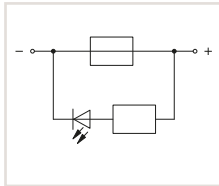

2-conductor fuse terminal block, with test point, for blade-style fuses per DIN 72581-3f, ISO 8820-3, 12 V, with blown fuse indication by LED, power consumption LED: 4.8 mA

Color	Item No.	Pack. Unit
○ gray	2002-1981/1000-429	50
○ blue	2002-1981/1000-449	50



IEC/EN 60947-7-3  
400 V  
6 kV  
10 A  
12 V, 10 A **UL**; 12 V, 6.3 A **CE**  
2.5 mm<sup>2</sup>

0.25 ... 4 mm<sup>2</sup> / 22 ... 12 AWG  
0.75 ... 4 mm<sup>2</sup> / 18 ... 12 AWG  
0.25 ... 4 mm<sup>2</sup> / 22 ... 12 AWG  
0.75 mm<sup>2</sup> / 18 AWG

10 ... 12 mm / 0.39 ... 0.47 inch  
5.2 mm / 0.205 inch  
Polyamide 66 (PA 66)

Electrical ratings are given by the fuse and blown fuse indication.  
Blade-style fuses: Observe touch-proof protection for 42 V and higher voltages!

	Item No.	Page
2-way	2002-402	164
orange	2002-1992	167
white	2009-115	780
white	2009-110	783

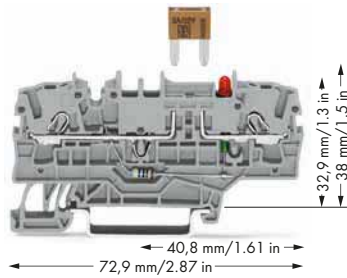

2002-1981/1000-413

2002-1981/1000-434

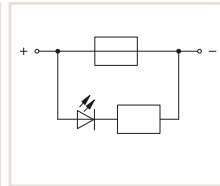
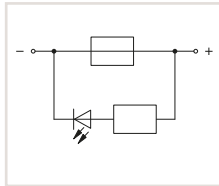

2-conductor fuse terminal block, with test point, for blade-style fuses per DIN 72581-3f, ISO 8820-3, 24 V, with blown fuse indication by LED, power consumption LED: 4.8 mA

Color	Item No.	Pack. Unit
○ gray	2002-1981/1000-413	50
○ blue	2002-1981/1000-434	50



IEC/EN 60947-7-3  
400 V  
6 kV  
10 A  
24 V, 10 A **UL**; 24 V, 6.3 A **CE**  
2.5 mm<sup>2</sup>

0.25 ... 4 mm<sup>2</sup> / 22 ... 12 AWG  
0.75 ... 4 mm<sup>2</sup> / 18 ... 12 AWG  
0.25 ... 4 mm<sup>2</sup> / 22 ... 12 AWG  
0.75 mm<sup>2</sup> / 18 AWG

10 ... 12 mm / 0.39 ... 0.47 inch  
5.2 mm / 0.205 inch  
Polyamide 66 (PA 66)

Electrical ratings are given by the fuse and blown fuse indication.  
Blade-style fuses: Observe touch-proof protection for 42 V and higher voltages!

	Item No.	Page
2-way	2002-402	164
orange	2002-1992	167
white	2009-115	780
white	2009-110	783

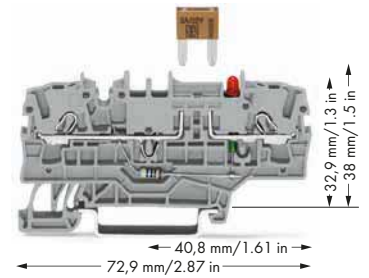

2002-1981/1000-414

2002-1981/1000-435

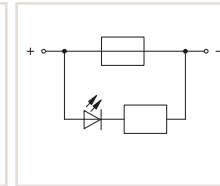
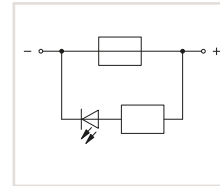

2-conductor fuse terminal block, with test point, for blade-style fuses per DIN 72581-3f, ISO 8820-3, 48 V, with blown fuse indication by LED, power consumption LED: 4.8 mA

Color	Item No.	Pack. Unit
○ gray	2002-1981/1000-414	50
○ gray	2002-1981/1000-435	50



IEC/EN 60947-7-3  
400 V  
6 kV  
10 A  
48 V, 10 A **CE**; 48 V, 6.3 A **CE**  
2.5 mm<sup>2</sup>

0.25 ... 4 mm<sup>2</sup> / 22 ... 12 AWG  
0.75 ... 4 mm<sup>2</sup> / 18 ... 12 AWG  
0.25 ... 4 mm<sup>2</sup> / 22 ... 12 AWG  
0.75 mm<sup>2</sup> / 18 AWG

10 ... 12 mm / 0.39 ... 0.47 inch  
5.2 mm / 0.205 inch  
Polyamide 66 (PA 66)

Electrical ratings are given by the fuse and blown fuse indication.  
Blade-style fuses: Observe touch-proof protection for 42 V and higher voltages!

	Item No.	Page
2-way	2002-402	164
orange	2002-1992	167
white	2009-115	780
white	2009-110	783



# TOPJOB® S – Fused Disconnect Terminal Blocks with a Pivoting Fuse Holder for 5 x 20 mm Miniature Metric Fuses and Additional Jumper Slot 2.5 (4) mm<sup>2</sup>, 2002 Series

1

## Miniature fuses 5 x 20

Series Item No.	Overload and short circuit protection		Short circuit protection only	
	Individual argmt.	Group argmt.	Individual argmt.	Group argmt.
Fuse terminal blocks				
2002-1911	1.6 W	1.6 W	2.5 W	2.5 W
2002-1911/.....	1.6 W	1.6 W	2.5 W	2.5 W

When selecting miniature metric fuses, make sure that the maximum power loss listed above is not exceeded. The power loss is determined according to IEC or EN 60947-7-3/VDE 0611-6 at 23 °C. The temperature rise of the terminal blocks must be checked according to their application and mounting. Higher ambient temperatures place additional strain on fuse cartridges. Therefore, in such applications, the rated current must be reduced if necessary. More details are available from the fuse manufacturers.

A protective warning marker and an insulation stop must be applied individually. Due to the 6.2 mm width of double-deck terminal blocks, 2004 Series Push-In Type Jumper Bars must be used.

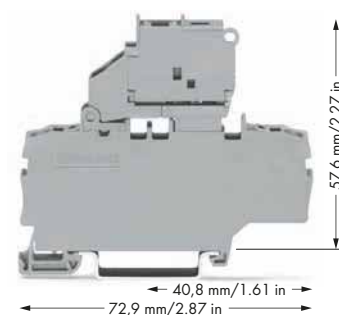

2002-1911

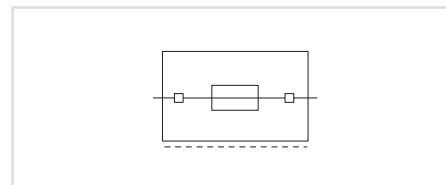

2-conductor fused disconnect terminal block with a pivoting fuse holder for (5 x 20) mm miniature metric fuse, with additional jumper slot, without blown fuse indication

Color	Item No.	Pack. Unit
○ gray	2002-1911	50

### Technical Data

Ratings per	IEC/EN 60947-7-3
Rated voltage (III / 3)	250 V
Rated surge voltage (III / 3)	6 kV
Rated current	6.3 A
Approval	600 V, 6.3 A ; 600 V, 6.3 A
Nominal cross section	2.5 mm <sup>2</sup>
<b>Connection Data</b>	
Solid conductor	0.25 ... 4 mm <sup>2</sup> / 22 ... 12 AWG
Solid conductor, push-in termination	0.75 ... 4 mm <sup>2</sup> / 18 ... 12 AWG
Fine-stranded conductor	0.25 ... 4 mm <sup>2</sup> / 22 ... 12 AWG
Fine-stranded conductor with ferrule, push-in termination, min.	0.75 mm <sup>2</sup> / 18 AWG
Strip length	10 ... 12 mm / 0.39 ... 0.47 inch
Terminal block width	6.2 mm / 0.244 inch
Insulation material	Polyamide 66 (PA 66)

### Accessories (Selection)

Push-in type jumper bar, insulated, I <sub>N</sub> 32 A, light gray	2-way	Item No. 2004-402	Page 169
End plate for fuse terminal blocks, 2 mm thick	orange	2002-992	167
WMB Multi marking system, white, 10 strips with 10 markers per card, 5 ... 5.2 mm stretchable	plain	793-5501	780
Marking strip, plain, 11 mm wide, 50 m reel	white	2009-110	783

Push-in type jumper bars (2004 Series), see page 169

Accessories (end plates, etc.), see page 167

Carrier rails and tools, see Section 13

Appropriate marking system, WMB/WMB Inline/marketing strips, see Full Line Catalog, Volume 6

Approvals and corresponding ratings, visit [www.wago.com](http://www.wago.com)

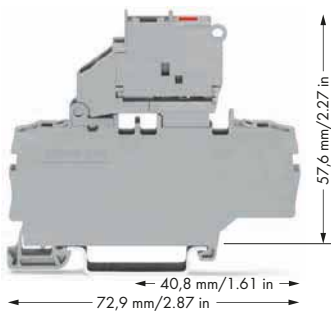

2002-1911/1000-541

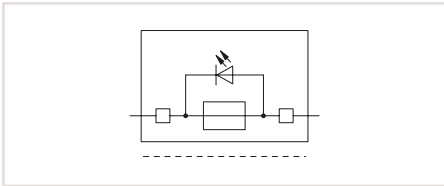

2-conductor fused disconnect terminal block with a pivoting fuse holder for (5 x 20) mm miniature metric fuse, with additional jumper slot, with blown fuse indication by LED, gray

	Item No.	Pack. Unit
○ 15 ... 30 V	2002-1911/1000-541	50
○ 30 ... 65 V	2002-1911/1000-542	50
○ 120 V	2002-1911/1000-867	50
○ 230 V	2002-1911/1000-836	50



IEC/EN 60947-7-3
250 V
6 kV
6.3 A
250 V, 6.3 A
2.5 mm <sup>2</sup>
0.25 ... 4 mm <sup>2</sup> / 22 ... 12 AWG
0.75 ... 4 mm <sup>2</sup> / 18 ... 12 AWG
0.25 ... 4 mm <sup>2</sup> / 22 ... 12 AWG
0.75 mm <sup>2</sup> / 18 AWG
10 ... 12 mm / 0.39 ... 0.47 inch
6.2 mm / 0.244 inch
Polyamide 66 (PA 66)

	Item No.	Page
2-way	2004-402	169
orange	2002-992	167
plain	793-5501	780
white	2009-110	783

# TOPJOB® S – Disconnect Terminal Blocks (30 A) and Through/Carrier Terminal Blocks of Same Profile

## 6 (10) mm<sup>2</sup>, 2006 Series

1

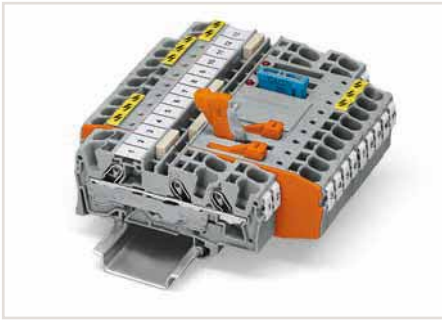

Terminal block assembly including:

- Through terminal blocks
- Disconnect terminal blocks
- Fuse terminal blocks for mini-automotive, blade-style fuses

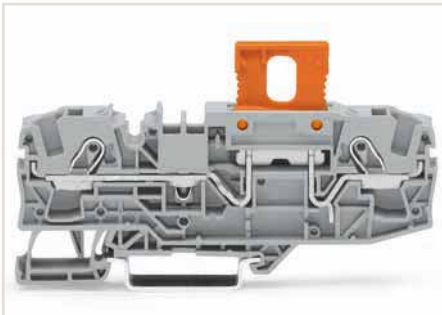

Carrier terminal block (2006-401) with disconnect plug (2006-1661) in operating position

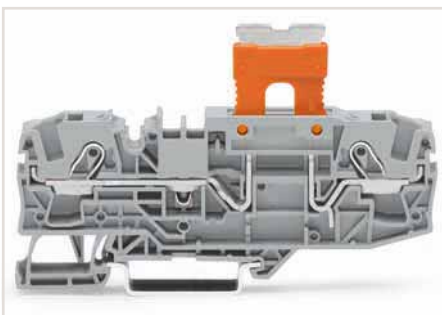

Carrier terminal block (2006-401) with disconnect plug (2002-1661) in parked position

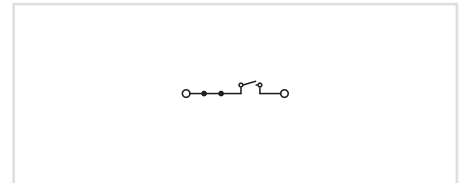
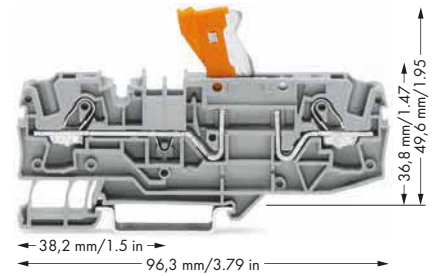

2-conductor disconnect terminal block, with test point, orange disconnect link

Color	Item No.	Pack. Unit
gray	2006-1671	25
blue	2006-1674	25



### Technical Data

Ratings per	
Rated voltage (III / 3)	800 V
Rated surge voltage (III / 3)	8 kV
Rated current	30 A
Approval	600 V, 30 A <b>UL</b> ; 600 V, 30 A <b>CE</b>
Nominal cross section	6 mm <sup>2</sup>
<b>Connection Data</b>	
Solid conductor	0.5 ... 10 mm <sup>2</sup> / 20 ... 8 AWG
Solid conductor, push-in termination	1 ... 10 mm <sup>2</sup> / 14 ... 8 AWG
Fine-stranded conductor	0.5 ... 10 mm <sup>2</sup> / 20 ... 8 AWG
Fine-stranded conductor with ferrule, push-in termination, min.	1.5 mm <sup>2</sup> / 16 AWG
Strip length	13 ... 15 mm / 0.51 ... 0.59 inch
Terminal block width	7.5 mm / 0.295 inch
Insulation material	Polyamide 66 (PA 66)

### Accessories (Selection)

Push-in type jumper bar, insulated, I <sub>N</sub> 41 A, light gray	
End and intermediate plate, 1 mm thick	
WMB Multi marking system, white, 10 strips with 10 markers per card, 5 ... 5.2 mm stretchable	
Marking strip, plain, 11 mm wide, 50 m reel	
Modular TOPJOB® S connector, for jumper contact slot, snaps together	

	Item No.	Page
2-way	2006-402	171
orange	2006-1692	171
plain	793-5501	780
white	2009-110	783
gray	2006-511	159

Accessories (jumpers, end plates, test plugs, etc.), see page 171

Carrier rails and tools, see Section 13

Appropriate marking system, WMB/WMB Inline/markings strips, see Full Line Catalog, Volume 6

Approvals and corresponding ratings, visit [www.wago.com](http://www.wago.com)

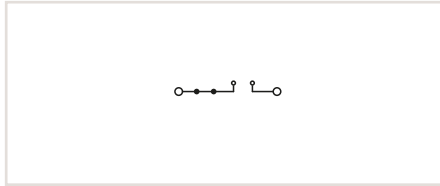
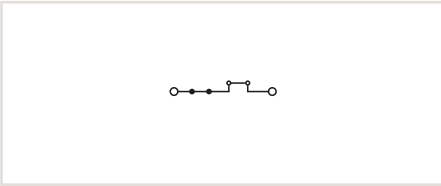
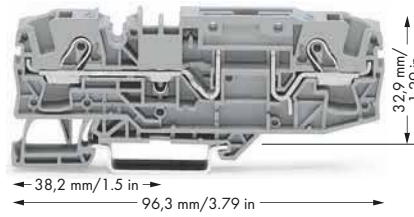
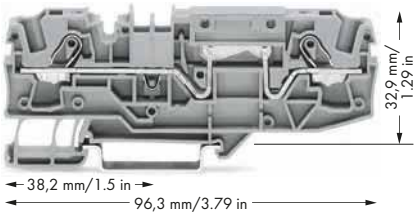

2-conductor through terminal block, with test point, same profile as 2-conductor disconnect terminal block

Color	Item No.	Pack. Unit
gray	2006-1601	25
blue	2006-1604	25

2-conductor carrier block

Color	Item No.	Pack. Unit
gray	2006-1661	25
blue	2006-1664	25

Ⓢ

IEC/EN 60947-7-1
800 V
8 kV
30 A
600 V, 30 A Ⓢ
6 mm <sup>2</sup>
0.5 ... 10 mm <sup>2</sup> / 20 ... 8 AWG
1 ... 10 mm <sup>2</sup> / 14 ... 8 AWG
0.5 ... 10 mm <sup>2</sup> / 20 ... 8 AWG
1.5 mm <sup>2</sup> / 16 AWG
13 ... 15 mm / 0.51 ... 0.59 inch
7.5 mm / 0.295 inch
Polyamide 66 (PA 66)

Ⓢ

IEC/EN 60947-7-1
800 V
8 kV
30 A
600 V, 30 A Ⓢ
6 mm <sup>2</sup>
0.5 ... 10 mm <sup>2</sup> / 20 ... 8 AWG
1 ... 10 mm <sup>2</sup> / 14 ... 8 AWG
0.5 ... 10 mm <sup>2</sup> / 20 ... 8 AWG
1.5 mm <sup>2</sup> / 16 AWG
13 ... 15 mm / 0.51 ... 0.59 inch
7.5 mm / 0.295 inch
Polyamide 66 (PA 66)

	Item No.	Page
2-way	2006-402	171
orange	2006-1692	171
plain	793-5501	780
white	2009-110	783
gray	2006-511	159

	Item No.	Page
2-way	2006-402	171
orange	2006-1692	171
plain	793-5501	780
white	2009-110	783
gray	2006-511	159

# TOPJOB® S

## Ground Conductor Disconnect Terminal Blocks

### Installation

1



Ground conductor disconnect terminal block – top view

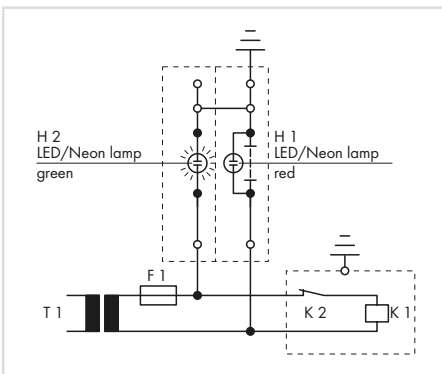

**Operating condition**  
Slide link closed, auxiliary circuit grounded, green LED/neon lamp illuminates.

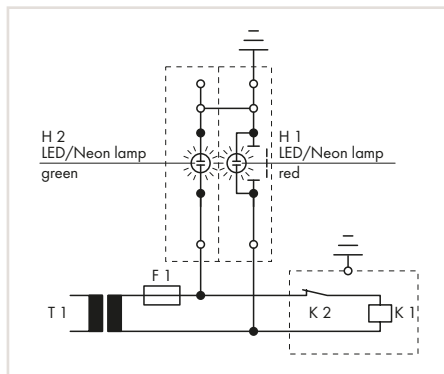

**Test condition – no grounding**  
Slide link open, auxiliary circuit not grounded.

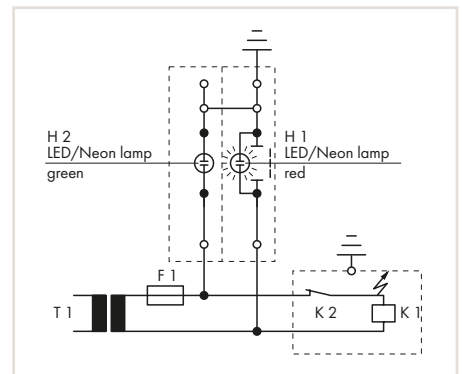

**Test condition – grounding**  
Slide link open, auxiliary circuit not grounded, red LED/neon lamp illuminates.

# TOPJOB® S

## Ground Conductor Disconnect Terminal Blocks

### 6 (10) mm<sup>2</sup>, 2006 Series

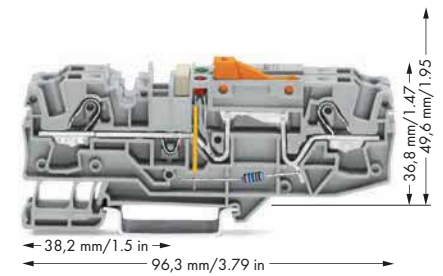

Ground conductor disconnect terminal block, with test point, orange disconnect link, gray

	Item No.	Pack. Unit
○ 24 V	2006-1671/1000-848	12
○ 48 V	2006-1671/1000-849	12
○ 120 V	2006-1671/1000-850	12
○ 230 V	2006-1671/1000-851	12



#### Technical Data

Rated voltage (III / 3)	500 V
Rated surge voltage (III / 3)	6 kV
Rated current	30 A
Approval	24 V, 30 A ; 24 V, 30 A
Nominal cross section	6 mm <sup>2</sup>

#### Connection Data

Solid conductor	0.5 ... 10 mm <sup>2</sup> / 20 ... 8 AWG
Solid conductor, push-in termination	1 ... 10 mm <sup>2</sup> / 14 ... 8 AWG
Fine-stranded conductor	0.5 ... 10 mm <sup>2</sup> / 20 ... 8 AWG
Fine-stranded conductor with ferrule, push-in termination, min.	1.5 mm <sup>2</sup> / 16 AWG
Strip length	13 ... 15 mm / 0.51 ... 0.59 inch
Terminal block width	7.5 mm / 0.295 inch
Insulation material	Polyamide 66 (PA 66)

#### Accessories (Selection)

Push-in type jumper bar, insulated, I <sub>N</sub> 41 A, light gray	
End and intermediate plate, 1 mm thick	
WMB Multi marking system, white, 10 strips with 10 markers per card, 5 ... 5.2 mm stretchable	
Marking strip, plain, 11 mm wide, 50 m reel	
Modular TOPJOB® S connector, for jumper contact slot, snaps together	

	Item No.	Page
2-way	2006-402	171
orange	2006-1692	171
plain	793-5501	780
white	2009-110	783
gray	2006-511	159

IEC 60204/DIN VDE 0113 "Safety of machinery – Electrical equipment of machines – Part 1: General requirements," Section 9.4.3.1: Ground faults on control circuits shall not cause unintentional starting, hazardous movements or prevent stopping of the machine.

In order to fulfill this requirement, bonding to the protective bonding circuit shall be provided in accordance with Section 8.2 and the devices shall be connected as described in Section 9.1.4. Control circuits fed from a transformer and not connected to the protective bonding circuit shall be provided with an insulation monitoring device (e.g., residual current device), which either indicates a ground fault or interrupts the circuit automatically after a ground fault.

In the case of electronic circuits, the connection of one side of the control circuit to the protective bonding circuit in accordance with Section 9.1.4 can prevent unintentional operation. When this does not help, or if due to other reasons that electronic circuits cannot be connected to the protective bonding circuit, other measures shall be taken to achieve the same level of safety.

Multipole control switches that interrupt all live conductors shall be used where the control circuit is directly connected between the phase conductors of the supply or between a phase conductor and a neutral conductor, which is either not grounded or grounded through a high impedance. This is required for starting or stopping those machine functions, which can cause a hazardous situation including: damaging the machine or halting work in progress in the event of unintentional starting or failure to stop.

Accessories (jumpers, end plates, test plugs, etc.), see page 171

Carrier rails and tools, see Section 13

Appropriate marking system, WMB/WMB Inline/marketing strips, see Full Line Catalog, Volume 6

Approvals and corresponding ratings, visit [www.wago.com](http://www.wago.com)



## TOPJOB® S

## Fuse terminal blocks for mini-automotive, blade-style fuses

6 (10) mm<sup>2</sup>, 2006 Series

1

Blade-style fuses are not offered by WAGO.

Thermal automotive circuit breakers are not offered by WAGO.  
WAGO recommends automotive circuit breakers from ETA.

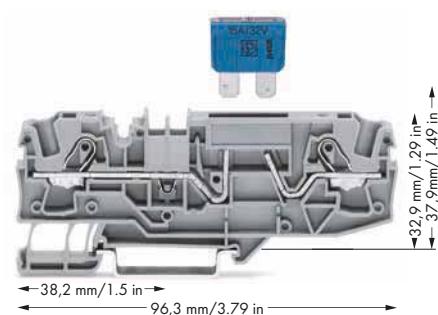

2-conductor fuse terminal block for mini-automotive fuses, with test point, without blown fuse indication

Color	Item No.	Pack. Unit
○ gray	2006-1681	25



#### Technical Data

Ratings per	IEC/EN 60947-7-3
Rated voltage (III / 3)	500 V
Rated surge voltage (III / 3)	8 kV
Rated current	25 A
Rated current (2)	30 A
Approval	600 V, 30 A  600 V, 30 A
Nominal cross section	6 mm <sup>2</sup>

#### Connection Data

Solid conductor	0.5 ... 10 mm <sup>2</sup> / 20 ... 8 AWG
Solid conductor, push-in termination	1 ... 10 mm <sup>2</sup> / 14 ... 8 AWG
Fine-stranded conductor	0.5 ... 10 mm <sup>2</sup> / 20 ... 8 AWG
Fine-stranded conductor with ferrule, push-in termination, min.	1.5 mm <sup>2</sup> / 16 AWG
Strip length	13 ... 15 mm / 0.51 ... 0.59 inch
Terminal block width	7.5 mm / 0.295 inch
Insulation material	Polyamide 66 (PA 66)

#### Note:

Electrical ratings are given by the fuse.  
Blade-style fuses: Observe touch-proof protection for 42 V and higher voltages!

#### Accessories (Selection)

Push-in type jumper bar, insulated, I <sub>n</sub> 41 A, light gray
End and intermediate plate, 1 mm thick
WMB Multi marking system, white, 10 strips with 10 markers per card, 5 ... 5.2 mm stretchable
Marking strip, plain, 11 mm wide, 50 m reel
Modular TOPJOB® S connector, for jumper contact slot, snaps together

	Item No.	Page
2-way	2006-402	171
orange	2006-1692	171
plain	793-5501	780
white	2009-110	783
gray	2006-511	159

Applications notes on fuses, see page 33

Accessories (jumpers, end plates, test plugs, etc.), see page 171

Carrier rails and tools, see Section 13

Appropriate marking system, WMB/WMB Inline/markings strips, see Full Line Catalog, Volume 6

Approvals and corresponding ratings, visit [www.wago.com](http://www.wago.com)

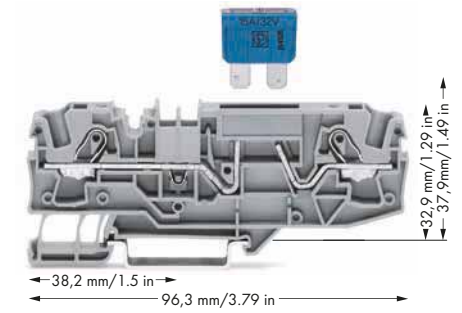
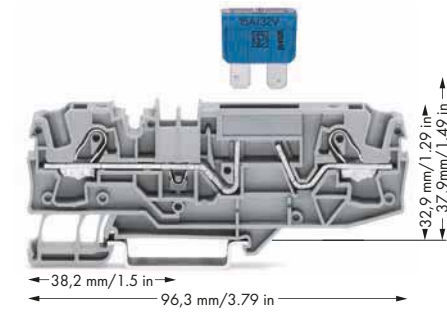
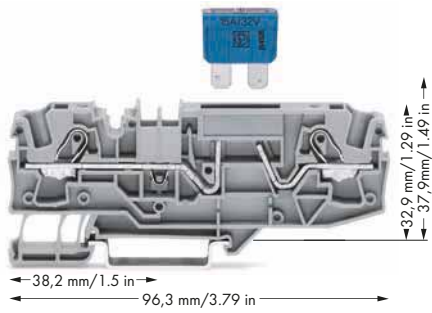

2006-1681/1000-429    2006-1681/1000-449

2006-1681/1000-413    2006-1681/1000-434

2006-1681/1000-414    2006-1681/1000-435

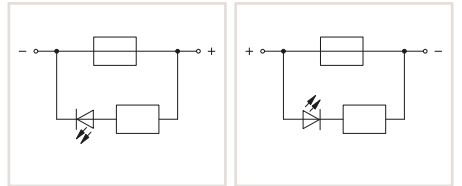
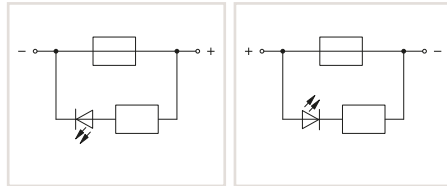
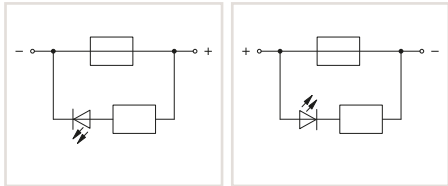

2-conductor fuse terminal block for mini-automotive fuses, 12 V, with test point and blown fuse indication by LED, power consumption LED: 4.8 mA

Color	Item No.	Pack. Unit
gray	2006-1681/1000-429	25
gray	2006-1681/1000-449	25

2-conductor fuse terminal block for mini-automotive fuses, 24 V, with test point and blown fuse indication by LED, power consumption LED: 4.8 mA

Color	Item No.	Pack. Unit
gray	2006-1681/1000-413	25
gray	2006-1681/1000-434	25

2-conductor fuse terminal block for mini-automotive fuses, 48 V, with test point and blown fuse indication by LED, power consumption LED: 4.8 mA

Color	Item No.	Pack. Unit
gray	2006-1681/1000-414	25
gray	2006-1681/1000-435	25



IEC/EN 60947-7-3
500 V
8 kV
25 A
30 A
24 V, 30 A ; 12 V, 30 A
6 mm <sup>2</sup>
0.5 ... 10 mm <sup>2</sup> / 20 ... 8 AWG
1 ... 10 mm <sup>2</sup> / 14 ... 8 AWG
0.5 ... 10 mm <sup>2</sup> / 20 ... 8 AWG
1.5 mm <sup>2</sup> / 16 AWG
13 ... 15 mm / 0.51 ... 0.59 inch
7.5 mm / 0.295 inch
Polyamide 66 (PA 66)
Electrical ratings are given by the fuse and blown fuse indication. Blade-style fuses: Observe touch-proof protection for 42 V and higher voltages!

IEC/EN 60947-7-3
500 V
8 kV
25 A
30 A
12 V, 30 A ; 24 V, 30 A
6 mm <sup>2</sup>
0.5 ... 10 mm <sup>2</sup> / 20 ... 8 AWG
1 ... 10 mm <sup>2</sup> / 14 ... 8 AWG
0.5 ... 10 mm <sup>2</sup> / 20 ... 8 AWG
1.5 mm <sup>2</sup> / 16 AWG
13 ... 15 mm / 0.51 ... 0.59 inch
7.5 mm / 0.295 inch
Polyamide 66 (PA 66)
Electrical ratings are given by the fuse and blown fuse indication. Blade-style fuses: Observe touch-proof protection for 42 V and higher voltages!

IEC/EN 60947-7-3
500 V
8 kV
25 A
30 A
48 V, 30 A ; 48 V, 30 A
6 mm <sup>2</sup>
0.5 ... 10 mm <sup>2</sup> / 20 ... 8 AWG
1 ... 10 mm <sup>2</sup> / 14 ... 8 AWG
0.5 ... 10 mm <sup>2</sup> / 20 ... 8 AWG
1.5 mm <sup>2</sup> / 16 AWG
13 ... 15 mm / 0.51 ... 0.59 inch
7.5 mm / 0.295 inch
Polyamide 66 (PA 66)
Electrical ratings are given by the fuse and blown fuse indication. Blade-style fuses: Observe touch-proof protection for 42 V and higher voltages!

	Item No.	Page
2-way	2006-402	171
orange	2006-1692	171
plain	793-5501	780
white	2009-110	783
gray	2006-511	159

	Item No.	Page
2-way	2006-402	171
orange	2006-1692	171
plain	793-5501	780
white	2009-110	783
gray	2006-511	159

	Item No.	Page
2-way	2006-402	171
orange	20061692	171
plain	793-5501	780
white	2009-110	783
gray	2006-511	159

# TOPJOB® S – Fused Disconnect Terminal Blocks with a Pivoting Fuse Holder for 5 x 20 mm, 5 x 30 mm and ¼" x 1¼" Miniature Metric Fuses

## 6 (10) mm<sup>2</sup>, 2006 Series

1



Pivoting fuse holder with spare fuse holder

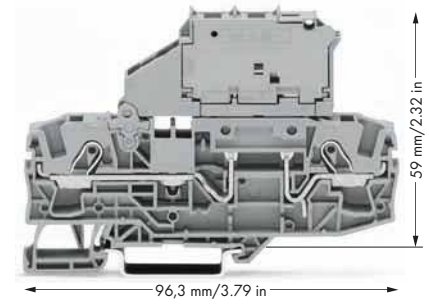

2006-1611

2006-1611/1000-541

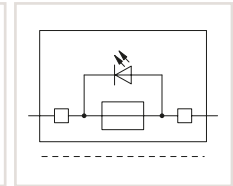
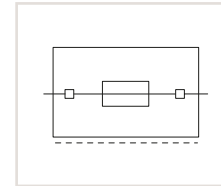

2-conductor fused disconnect terminal block with a pivoting fuse holder, for (5 x 20) mm miniature metric fuse, without blown fuse indication  
Electrical ratings are given by the fuse.

Color	Item No.	Pack. Unit
○ gray	2006-1611	25

2-conductor fused disconnect terminal block with a pivoting fuse holder, for (5 x 20) mm miniature metric fuse, with blown fuse indication by LED, gray  
Electrical ratings are given by the fuse and blown fuse indication. Leakage current in case of a blown fuse: LED 2 mA

	Item No.	Pack. Unit
○ 15 ... 30 V	2006-1611/1000-541	25
○ 30 ... 65 V	2006-1611/1000-542	25
○ 120 V	2006-1611/1000-867	25
○ 230 V	2006-1611/1000-836	25



Miniature fuses					
Series Item No.		Overload and short circuit protection		Short circuit protection only	
		Individual argmt.	Group argmt.	Individual argmt.	Group argmt.
Fused disconnect terminal blocks					
2006-1611	7.5	1.6 W	1.6 W	2.5 W	2.5 W
2006-1621	7.5	1.6 W	1.6 W	2.5 W	2.5 W
2006-1631	7.5	1.6 W	1.6 W	2.5 W	2.5 W
2006-1631 /099...	10.4	2.5 W	2.5 W	2.5 W	2.5 W
2006-1631 /1099...	10.4	2.5 W	2.5 W	2.5 W	2.5 W

When selecting miniature metric fuses, make sure that the maximum power loss listed above is not exceeded. The power loss is determined according to IEC or EN 60947-7-3/VDE 0611-6 at 23 °C. The temperature rise of the terminal blocks must be checked according to their application and mounting. Higher ambient temperatures place additional strain on fuse cartridges. Therefore, in such applications, the rated current must be reduced if necessary. More details are available from the fuse manufacturers.

### Technical Data

Ratings per	IEC/EN 60947-7-3
Rated voltage (III / 3)	800 V
Rated surge voltage (III / 3)	8 kV
Rated current	10 A
Approval	600 V, 15 A ; 600 V, 15 A
Nominal cross section	6 mm <sup>2</sup>
<b>Connection Data</b>	
Solid conductor	0.5 ... 10 mm <sup>2</sup> / 20 ... 8 AWG
Solid conductor, push-in termination	1 ... 10 mm <sup>2</sup> / 14 ... 8 AWG
Fine-stranded conductor	0.5 ... 10 mm <sup>2</sup> / 20 ... 8 AWG
Fine-stranded conductor with ferrule, push-in termination, min.	1.5 mm <sup>2</sup> / 16 AWG
Strip length	13 ... 15 mm / 0.51 ... 0.59 inch
Terminal block width	7.5 mm / 0.295 inch
Insulation material	Polyamide 66 (PA 66)

### Accessories (Selection)

Push-in type jumper bar, insulated, I <sub>n</sub> 41 A, light gray
End and intermediate plate, 1 mm thick
End plate for fuse terminal blocks, 2 mm thick
WMB Multi marking system, white, 10 strips with 10 markers per card, 5 ... 5.2 mm stretchable
Marking strip, plain, 11 mm wide, 50 m reel

Accessories (jumpers, end plates, test plugs, etc.), see page 171

Carrier rails and tools, see Section 13

Appropriate marking system, WMB/WMB Inline/markings strips, see Full Line Catalog, Volume 6

Approvals and corresponding ratings, visit [www.wago.com](http://www.wago.com)

	Item No.	Page
2-way	2006-402	171
orange	2006-1692	171
orange	2006-992	172
plain	793-5501	780
white	2009-110	783

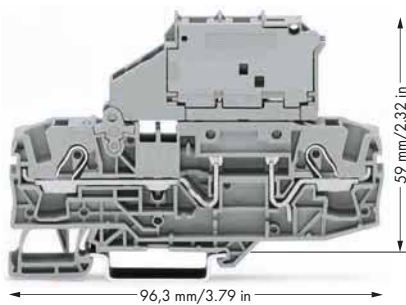
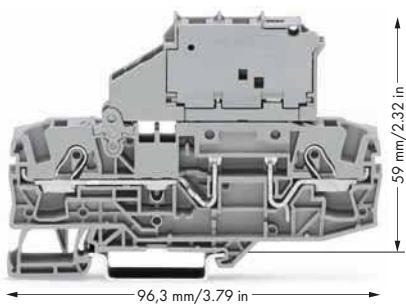

2006-1621

2006-1621/1000-541

2006-1631

2006-1631/1000-541

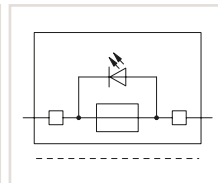
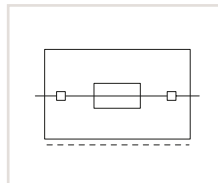
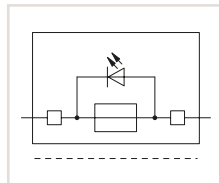
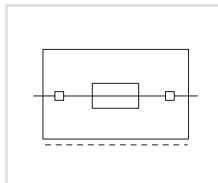

2-conductor fused disconnect terminal block with a pivoting fuse holder, for (5 x 30) mm miniature metric fuse, without blown fuse indication  
Electrical ratings are given by the fuse.

Color	Item No.	Pack. Unit
○ gray	2006-1621	25

2-conductor fused disconnect terminal block with a pivoting fuse holder, for ¼" x 1¼" miniature metric fuse, without blown fuse indication  
Electrical ratings are given by the fuse.

Color	Item No.	Pack. Unit
○ gray	2006-1631	25

2-conductor fused disconnect terminal block with a pivoting fuse holder, for (5 x 30) mm miniature metric fuse, with blown fuse indication by LED, gray  
Electrical ratings are given by the fuse and blown fuse indication. Leakage current in case of a blown fuse: LED 2 mA

	Item No.	Pack. Unit
○ 15 ... 30 V	2006-1621/1000-541	25
○ 30 ... 65 V	2006-1621/1000-542	25
○ 120 V	2006-1621/1000-867	25
○ 230 V	2006-1621/1000-836	25
○ 380 ... 500 V	2006-1621/1000-859	25

2-conductor fused disconnect terminal block with a pivoting fuse holder, for ¼" x 1¼" miniature metric fuse, with blown fuse indication by LED, gray  
Electrical ratings are given by the fuse and blown fuse indication. Leakage current in case of a blown fuse: LED 2 mA

	Item No.	Pack. Unit
○ 15 ... 30 V	2006-1631/1000-541	25
○ 30 ... 65 V	2006-1631/1000-542	25
○ 120 V	2006-1631/1000-867	25
○ 230 V	2006-1631/1000-836	25
○ 380 ... 500 V	2006-1631/1000-859	25



IEC/EN 60947-7-3

800 V

8 kV

10 A

600 V, 15 A ; 600 V, 15 A

6 mm<sup>2</sup>

0.5 ... 10 mm<sup>2</sup> / 20 ... 8 AWG

1 ... 10 mm<sup>2</sup> / 14 ... 8 AWG

0.5 ... 10 mm<sup>2</sup> / 20 ... 8 AWG

1.5 mm<sup>2</sup> / 16 AWG

13 ... 15 mm / 0.51 ... 0.59 inch

7.5 mm / 0.295 inch

Polyamide 66 (PA 66)

	Item No.	Page
2-way	2006-402	171
orange	2006-1692	171
orange	2006-992	172
plain	793-5501	780
white	2009-110	783

IEC/EN 60947-7-3

800 V

8 kV

10 A

600 V, 15 A ; 600 V, 15 A

6 mm<sup>2</sup>

0.5 ... 10 mm<sup>2</sup> / 20 ... 8 AWG

1 ... 10 mm<sup>2</sup> / 14 ... 8 AWG

0.5 ... 10 mm<sup>2</sup> / 20 ... 8 AWG

1.5 mm<sup>2</sup> / 16 AWG

13 ... 15 mm / 0.51 ... 0.59 inch

7.5 mm / 0.295 inch

Polyamide 66 (PA 66)

	Item No.	Page
2-way	2006-402	171
orange	2006-1692	171
orange	2006-992	172
plain	793-5501	780
white	2009-110	783

## TOPJOB® S – Fused Disconnect Terminal Blocks with a Pivoting Fuse Holder for ¼" x 1¼" Miniature Metric Fuses

### 6 (10) mm<sup>2</sup>, 2006 Series

1



Pivoting fuse holder with spare fuse holder

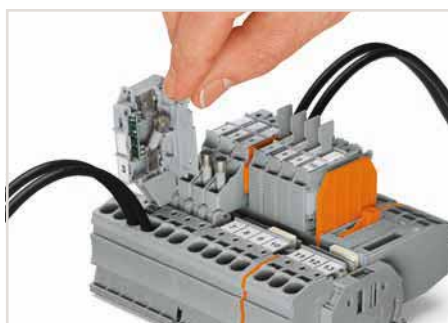

When selecting miniature metric fuses, make sure that the maximum power loss listed above is not exceeded. The power loss is determined according to IEC or EN 60947-7-3/VDE 0611-6 at 23 °C. The temperature rise of the terminal blocks must be checked according to their application and mounting. Higher ambient temperatures place additional strain on fuse cartridges. Therefore, in such applications, the rated current must be reduced if necessary. More details are available from the manufacturers.

Protective warning markers must be applied individually. Due to the 10.4 mm width of fused disconnect terminal blocks with a pivoting fuse holder, 2002 Series Push-In Type Jumper Bars must be used.

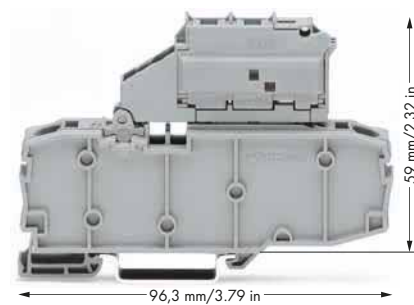

2006-1631/099-000

2006-1631/1099-541

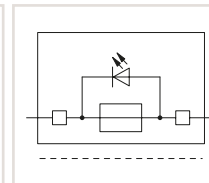
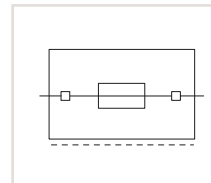

Fused disconnect terminal block with a pivoting fuse holder and end plate, for ¼" x 1¼" miniature metric fuse, without blown fuse indication  
Electrical ratings are given by the fuse.

Color	Item No.	Pack. Unit
○ gray	2006-1631/099-000	25

Fused disconnect terminal block with a pivoting fuse holder and end plate, for ¼" x 1¼" miniature metric fuse, with blown fuse indication by LED, gray  
Electrical ratings are given by the fuse and blown fuse indication. Leakage current in case of a blown fuse: LED 2 mA

	Item No.	Pack. Unit
○ 15 ... 30 V	2006-1631/1099-541	25
○ 30 ... 65 V	2006-1631/1099-542	25
○ 120 V	2006-1631/1099-867	25
○ 230 V	2006-1631/1099-836	25
○ 380 ... 500 V	2006-1631/1099-859	25



#### Technical Data

Ratings per	IEC/EN 60947-7-3
Rated voltage (III / 3)	800 V
Rated surge voltage (III / 3)	8 kV
Rated current	10 A
Approval	600 V, 15 A ; 600 V, 15 A
Nominal cross section	6 mm <sup>2</sup>
<b>Connection Data</b>	
Solid conductor	0.5 ... 10 mm <sup>2</sup> / 20 ... 8 AWG
Solid conductor, push-in termination	1 ... 10 mm <sup>2</sup> / 14 ... 8 AWG
Fine-stranded conductor	0.5 ... 10 mm <sup>2</sup> / 20 ... 8 AWG
Fine-stranded conductor with ferrule, push-in termination, min.	1.5 mm <sup>2</sup> / 16 AWG
Strip length	13 ... 15 mm / 0.51 ... 0.59 inch
Terminal block width	10.4 mm / 0.409 inch
Insulation material	Polyamide 66 (PA 66)

#### Accessories (Selection)

Push-in type jumper bar, insulated, I <sub>N</sub> 25 A, light gray	1 to 3	2002-433	171
Push-in type jumper bar, insulated, I <sub>N</sub> 25 A, light gray	1 to 5	2002-435	171
Push-in type jumper bar, insulated, I <sub>N</sub> 25 A, light gray	1 to 7	2002-437	171
Push-in type jumper bar, insulated, I <sub>N</sub> 25 A, light gray	1 to 9	2002-439	171
End plate for fuse terminal blocks, 2 mm thick	orange	2006-992	172
WMB Multi marking system, white, 10 strips with 10 markers per card, 5 ... 5.2 mm stretchable	plain	793-5501	780
Marking strip, plain, 11 mm wide, 50 m reel	white	2009-110	783

Carrier rails and tools, see Section 13

Appropriate marking system, WMB/WMB Inline/markings strips, see Full Line Catalog, Volume 6

Approvals and corresponding ratings, visit [www.wago.com](http://www.wago.com)

# TOPJOB® S – Disconnect/Test Terminal Blocks, 1500 VDC, Carrier Terminal Blocks and Through Terminal Blocks of Same Profile 6 (10) mm<sup>2</sup>, 30 A, 2006 Series Installation

1

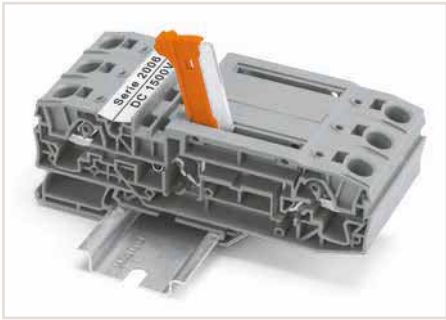

Disconnect/test terminal block with knife disconnect (2006-8671) in disconnect position

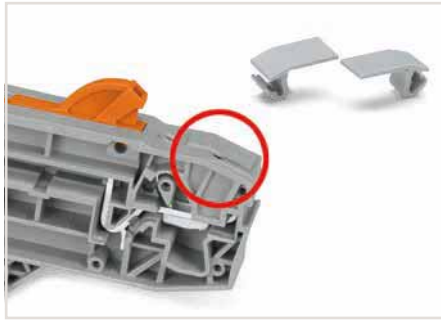

Lockout cap (2006-191) seals unused conductor entry.

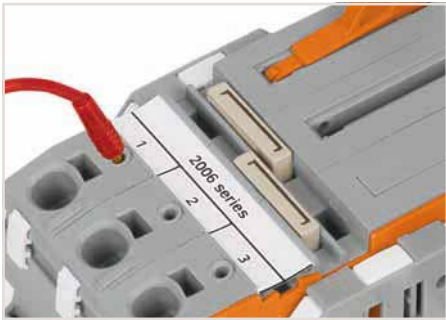

Test slots on both terminal block sides allow for direct measurement.



Test slots on both terminal block sides allow for direct measurement.

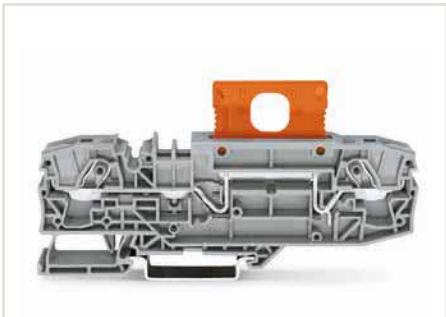

Carrier terminal block with disconnect plug (2006-8401) in operating position

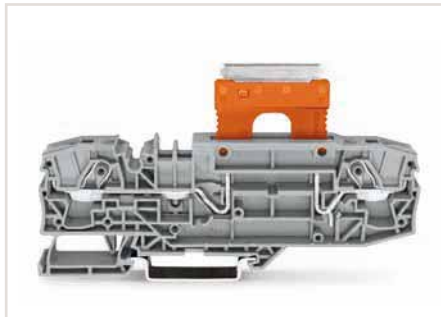

Carrier terminal block with disconnect plug (2006-8401) in parked position



## TOPJOB® S – Disconnect/Test Terminal Blocks (30 A) and Through/Carrier Terminal Blocks of Same Profile

### 6 (10) mm<sup>2</sup>, 2006 Series

1

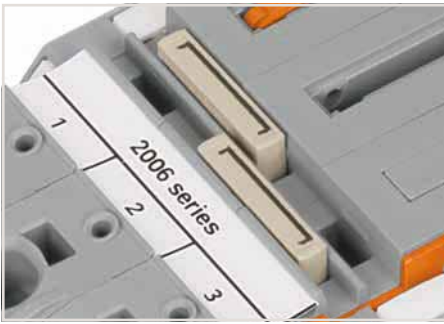

Commoning a 15 mm-wide terminal block via push-in type jumper bars: 1 to 3 (2006-433) and 1 to 5 (2006-435).

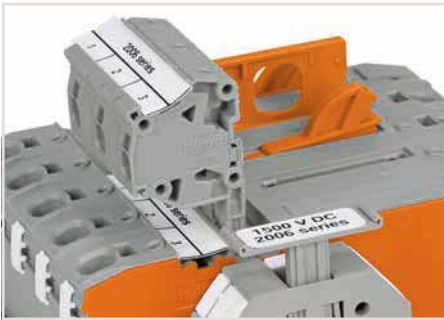

Alternatively, measurement can also be performed using TOPJOB® S Connectors (2006-511) from terminal block 1 to 2. Spacer modules (2006-549) must be used to compensate for the 15 mm terminal block width.

Protective warning markers must be applied individually.

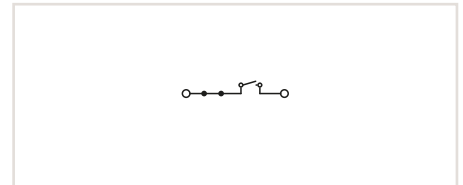
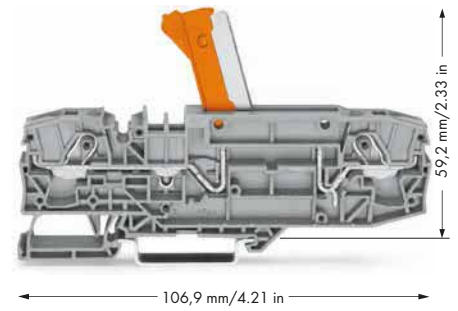

2-conductor disconnect/test terminal block, with test point, orange disconnect link

Color	Item No.	Pack. Unit
gray	2006-8671	12
blue	2006-8674	12



#### Technical Data

Ratings per	AC/DC
Voltage type	1000 V
Rated voltage (III / 3)	12 kV
Rated surge voltage (III / 3)	DC
Voltage type (2)	1500 V
Rated voltage (III / 3) (2)	12 kV
Rated surge voltage (III / 3) (2)	30 A
Rated current	600 V, 30 A ; 1000 V, 30 A
Approval	6 mm <sup>2</sup>
Nominal cross section	
<b>Connection Data</b>	
Solid conductor	0.5 ... 10 mm <sup>2</sup> / 20 ... 8 AWG
Solid conductor, push-in termination	1 ... 10 mm <sup>2</sup> / 14 ... 8 AWG
Fine-stranded conductor	0.5 ... 10 mm <sup>2</sup> / 20 ... 8 AWG
Fine-stranded conductor with ferrule, push-in termination, min.	1.5 mm <sup>2</sup> / 16 AWG
Strip length	13 ... 15 mm / 0.51 ... 0.59 inch
Terminal block width	15 mm / 0.591 inch
Insulation material	Polyamide 66 (PA 66)

#### Accessories (Selection)

	Item No.	Page
Push-in type jumper bar, insulated, I <sub>n</sub> 41 A, light gray	2006-433	171
Push-in type jumper bar, insulated, I <sub>n</sub> 41 A, light gray	2006-435	171
End and intermediate plate, 1 mm thick	orange 2006-8692	172
WMB Inline, plain, 1,500 WMB markers (5 mm) per reel, 5 ... 5.2 mm stretchable	white 2009-115	780
Marking strip, plain, 11 mm wide, 50 m reel	white 2009-110	783

Accessories (jumpers, end plates, test plugs, etc.), see page 171

Carrier rails and tools, see Section 13

Appropriate marking system, WMB/WMB Inline/marketing strips, see Full Line Catalog, Volume 6

Approvals and corresponding ratings, visit [www.wago.com](http://www.wago.com)

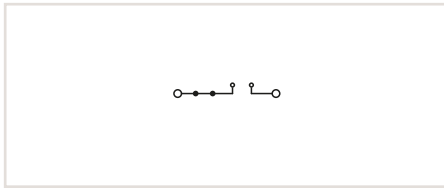
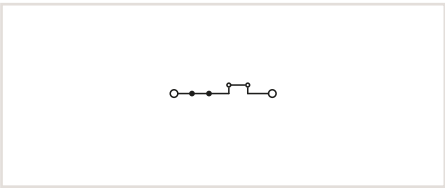
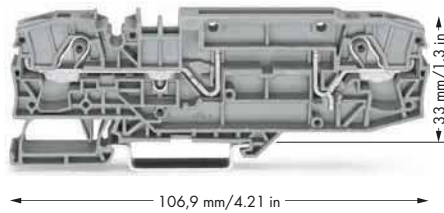
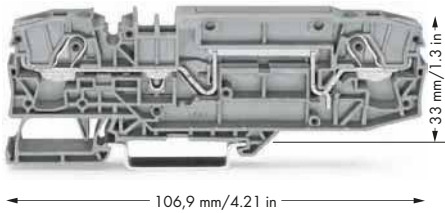

2-conductor through terminal block, with test point, same profile as 2-conductor disconnect terminal block

Color	Item No.	Pack. Unit
gray	2006-8601	12
blue	2006-8604	12

2-conductor carrier terminal block, with test point

Color	Item No.	Pack. Unit
gray	2006-8661	12
blue	2006-8664	12



IEC/EN 60947-7-1
AC/DC
1000 V
12 kV
DC
1500 V
12 kV
30 A
600 V, 30 A ; 1000 V, 30 A
6 mm <sup>2</sup>
0.5 ... 10 mm <sup>2</sup> / 20 ... 8 AWG
1 ... 10 mm <sup>2</sup> / 14 ... 8 AWG
0.5 ... 10 mm <sup>2</sup> / 20 ... 8 AWG
1.5 mm <sup>2</sup> / 16 AWG
13 ... 15 mm / 0.51 ... 0.59 inch
15 mm / 0.591 inch
Polyamide 66 (PA 66)

IEC/EN 60947-7-1
AC/DC
1000 V
12 kV
DC
1500 V
12 kV
30 A
600 V, 30 A ; 1000 V, 30 A
6 mm <sup>2</sup>
0.5 ... 10 mm <sup>2</sup> / 20 ... 8 AWG
1 ... 10 mm <sup>2</sup> / 14 ... 8 AWG
0.5 ... 10 mm <sup>2</sup> / 20 ... 8 AWG
1.5 mm <sup>2</sup> / 16 AWG
13 ... 15 mm / 0.51 ... 0.59 inch
15 mm / 0.591 inch
Polyamide 66 (PA 66)

	Item No.	Page
1 to 3	2006-433	171
1 to 5	2006-435	171
orange	2006-8692	172
white	2009-115	780
white	2009-110	783

	Item No.	Page
1 to 3	2006-433	171
1 to 5	2006-435	171
orange	2006-8692	172
white	2009-115	780
white	2009-110	783

# TOPJOB® S

## Current Transformer Terminal Blocks, 2007-8821 (Orange Disconnect Link)

1

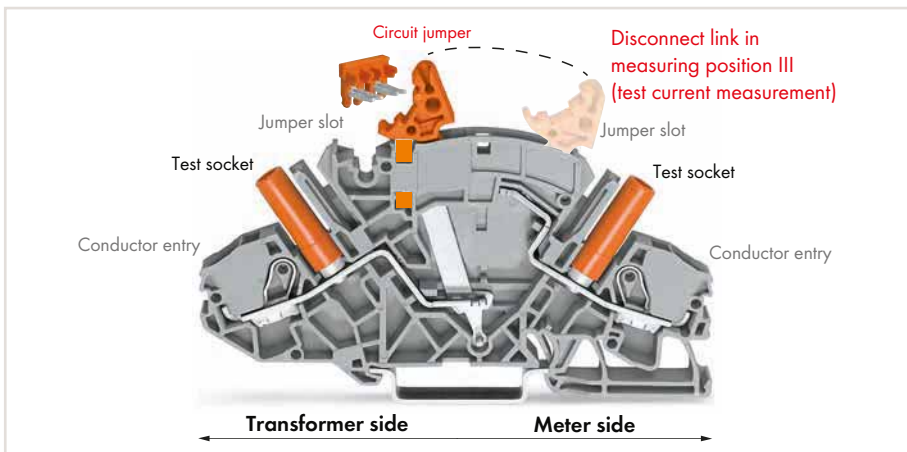
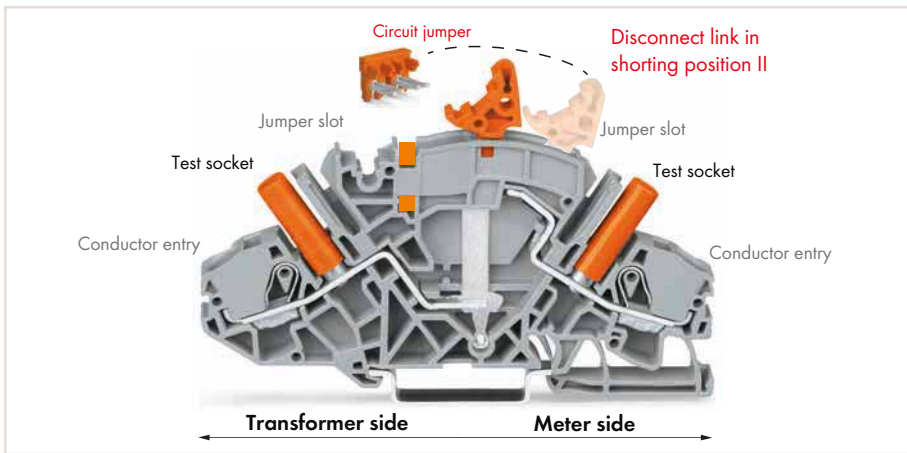
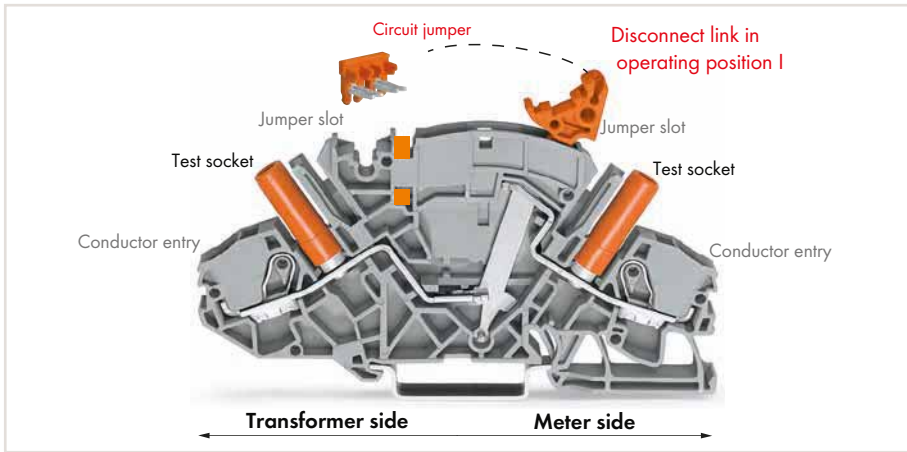

WAGO's TOPJOB® S Current Transformer (Disconnect/Test) Terminal Block (2007-8821) is designed for current transformer circuits.

First, the current transformer is shorted via disconnect link and circuit jumper (insert jumper, move disconnect link from operating position I to shorting position II, activate shorting path). Connecting a measurement device via test socket on the meter side can only be performed once circuit disconnection is complete (disconnect link in measuring position III).

- Features top-of-unit circuit jumper slot for shorting path activation.
- Disconnect link provides intuitive and easy operation, as well as exact switching status indication.
- Combines high functionality with compact design (99.6 mm long and 8 mm wide).
- All 2007 Series terminal blocks are rated at 30 A/500 V (IEC) and 300 V (UL).
- With a terminal block width of 8 mm, the maximum cross-section for solid and fine-stranded conductors is 10 mm<sup>2</sup> (8 AWG) and 6 mm<sup>2</sup> (10 AWG) for ferruled conductors.
- Touch-proof test sockets for 4 mm Ø test plugs on transformer and meter side.
- Compatible with through and ground conductor terminal blocks having the same profile.



Preparing shorting path for the current transformer circuits.



Insert insulated, touch-proof circuit jumpers into jumper slot.



Using locking covers or profiles for adjacent terminal blocks allows disconnect links to be operated simultaneously.

# TOPJOB® S Implementing a Current and Voltage Transformer Circuit

1



**Disconnect link in operating position I**  
Terminal blocks required:  
2 x disconnect/test terminal block (2007-8821)  
1 x circuit jumper, orange (2007-8442)  
Locking covers or interlocking links (option)

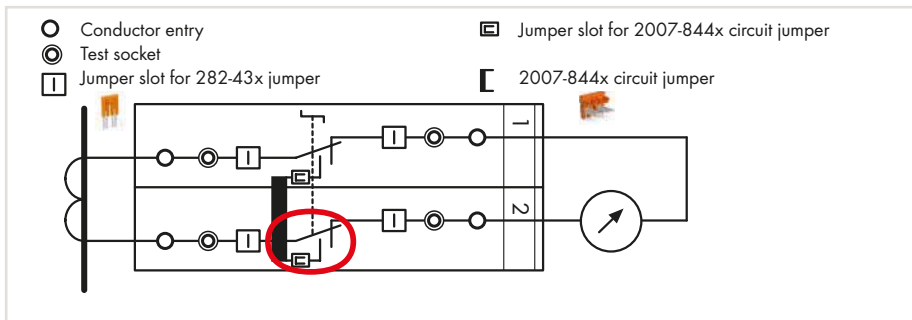

In the operating position, the measurement device is connected to the transformer, the circuit jumper is inserted and the disconnect link is in position I.

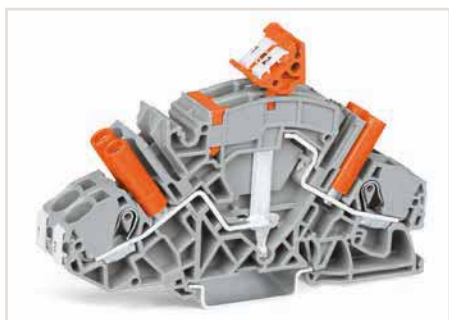

**Disconnect link in shorting position II**

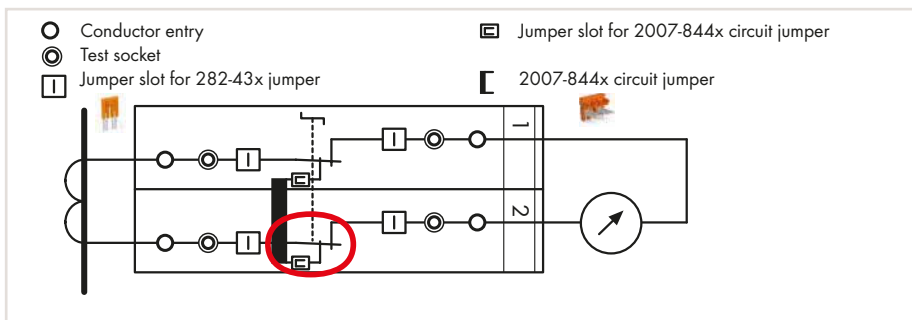

The transformer is not disconnected from the measuring device yet, the shorting path is activated by moving the disconnect link into shorting position II and the transformer is safely shorted.



**Test current measurement: Disconnect link in measuring position III**

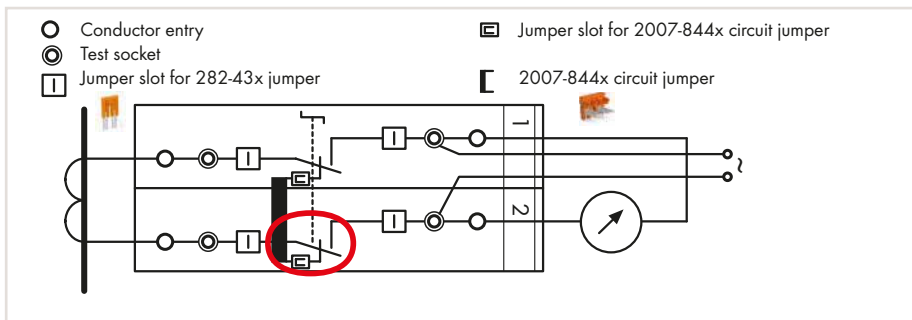

The measuring device is electrically disconnected from the transformer. If required, an external voltage can be applied to the measuring device via the test socket.



**Measurement testing (using both test sockets)**  
Terminal block 1: Disconnect link in operating position I  
Terminal block 2: Disconnect link in measuring position III

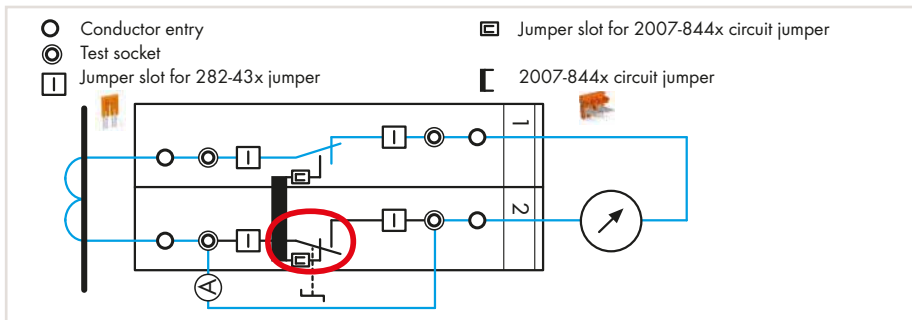

Measurement testing: First insert the reference current meter (A) into the test socket, then move the disconnect link into measurement position III (test current measurement).

## Examples for Current Transformer Circuits

1



### Measuring set for a three-phase current transformer

Terminal blocks required:

6 x disconnect/test terminal block (2007-8821)

3 x circuit jumper, orange (2007-8442)

In addition: interlocking links, locking covers, lock-outs

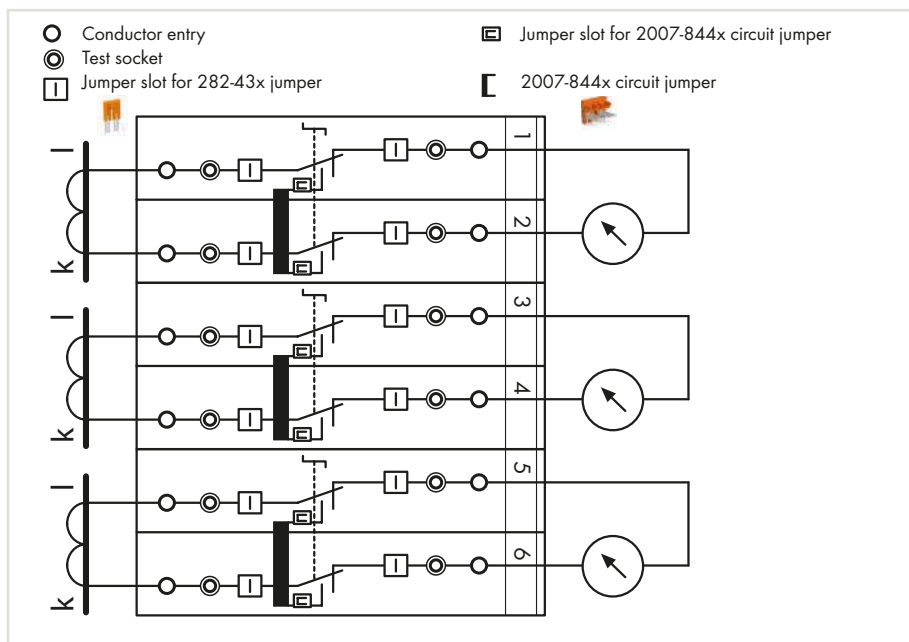

Pairs of disconnect links are interconnected via locking cover or interlocking link. Measurement testing is performed after the interlocking is released.



### Measuring set for a three-phase current transformer with 'Y' point

Terminal blocks required:

6 x disconnect/test terminal block (2007-8821)

1 x circuit jumper, orange (2007-8446)

1 x jumper, orange (282-433)

In addition: interlocking links, locking covers, lock-outs

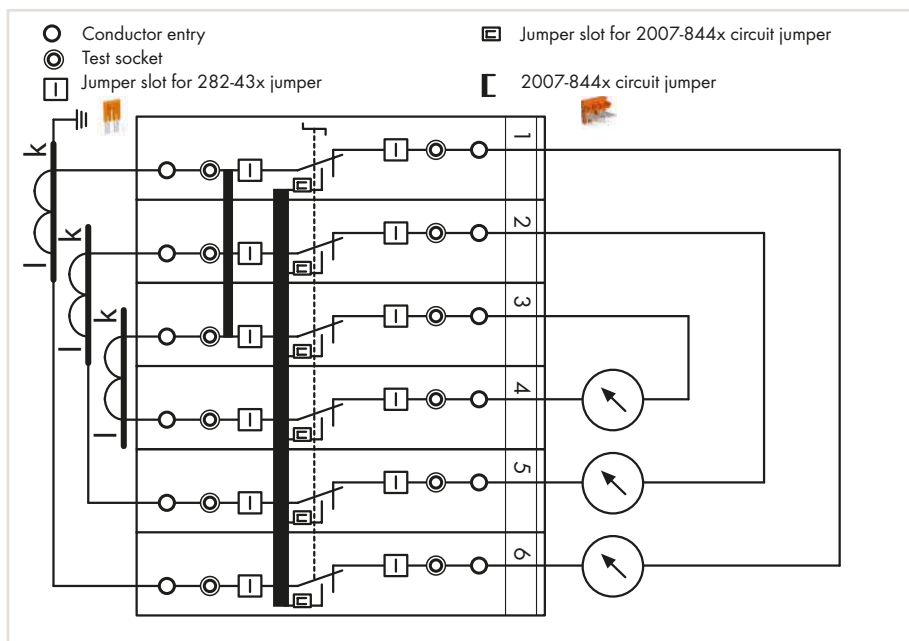

All six disconnect links are interconnected via locking cover or interlocking link.



# TOPJOB® S 2007-8811 Voltage Transformer Terminal Blocks (Light Gray Disconnect Link)

1

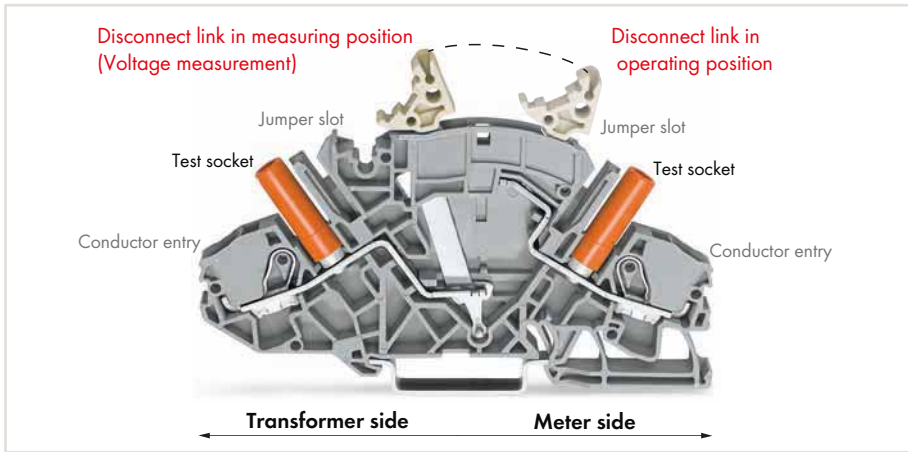

WAGO's TOPJOB® S Voltage Transformer (Disconnect/Test) Terminal Block (2007-8811) is designed for current transformer circuits.

First, disconnect the voltage transformer from the circuit (move disconnect link from operating position to measuring position). Connecting a measurement device via test socket on the meter side can only be performed after disconnection is complete (measuring position).

- For voltage transformer circuits (no circuit jumper slot required as with 2007-8821 Current Transformer Terminal Block)
- Disconnect link provides intuitive and easy operation, as well as exact switching status indication.
- Combines high functionality with compact design (99.6 mm long and 8 mm wide).
- All 2007 Series terminal blocks are rated at 30 A/500 V (IEC) and 300 V (UL).
- With a terminal block width of 8 mm, the maximum cross-section for solid and fine-stranded conductors is 10 mm<sup>2</sup> (8 AWG) and 6 mm<sup>2</sup> (10 AWG) for ferruled conductors.
- Touch-proof test sockets for 4 mm Ø test plugs on transformer and meter side.
- Compatible with through and ground conductor terminal blocks of same profile.



**Example for voltage transformer testing**  
**Measuring set for single-phase voltage transformer testing**

- Terminal blocks required:  
 1 x disconnect/test terminal block (2007-8811)  
 1 x through terminal block (2007-8801)  
 1 x end plate, orange (2007-8892)  
 In addition: locking cover, lock-out

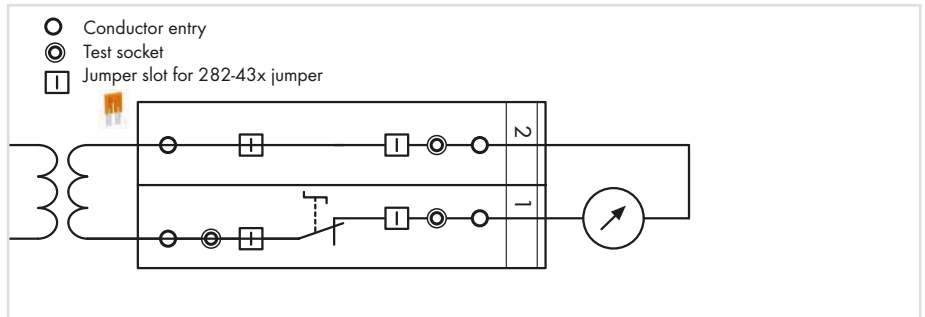

Disconnecting the voltage transformer from the circuit: Move disconnect link from operating position to measuring position.

Voltage measurement: Connecting a measurement device via test socket on the meter side can only be performed after disconnection is complete (measuring position).



Marking via WMB Multi markers or marking strips.



Additional commoning option on the transformer side



Multipole switching via snap-on type, transparent (locking) cover for disconnect links.



# TOPJOB® S – Disconnect/Test Terminal Blocks (30 A) and Through/Ground Conductor Terminal Blocks for Current and Voltage Transformer Circuits

## 6 (10) mm<sup>2</sup>, 2006 Series

1



Marking via WMB Multi markers or marking strips.



Preparing shorting path for the current transformer circuits.



Insert insulated, touch-proof circuit jumpers into jumper slot.

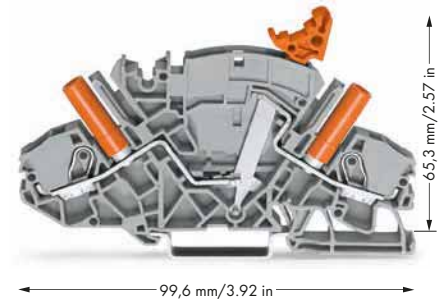

2-conductor disconnect/test terminal block, e.g., current transformer circuits, with circuit jumper slot, with touch-proof test sockets, for 4 mm Ø test plugs

Color	Item No.	Pack. Unit
○ gray	2007-8821	25



### Technical Data

Ratings per	
Rated voltage (III / 3)	500 V
Rated surge voltage (III / 3)	6 kV
Rated current	30 A
Approval	300 V, 30 A
Nominal cross section	6 mm <sup>2</sup>

### Connection Data

Solid conductor	0.5 ... 10 mm <sup>2</sup> / 20 ... 8 AWG
Solid conductor, push-in termination	1 ... 10 mm <sup>2</sup> / 14 ... 8 AWG
Fine-stranded conductor	0.5 ... 10 mm <sup>2</sup> / 20 ... 8 AWG
Fine-stranded conductor with ferrule, push-in termination, min.	1.5 mm <sup>2</sup> / 16 AWG
Strip length	13 ... 15 mm / 0.51 ... 0.59 inch
Terminal block width	8 mm / 0.315 inch
Insulation material	Polyamide 66 (PA 66)

### Accessories (Selection)

	Item No.	Page
Circuit jumper, insulated, I <sub>N</sub> 30 A, orange	2007-8442	118
Jumper, insulated, I <sub>N</sub> 30 A, orange	282-432	118
End and separator plate, 1.5 mm thick, without lock-out seal option	2007-8892	118
WMB Multi marking system, white, 10 strips with 10 markers per card, 5 ... 5.2 mm stretchable	793-5501	780
Marking strip, plain, 11 mm wide, 50 m reel	2009-110	783

Accessories (jumpers, end plates, etc.), see page 118

Carrier rails and tools, see Section 13

Appropriate marking system, WMB/WMB Inline/markings strips, see Full Line Catalog, Volume 6

Approvals and corresponding ratings, visit [www.wago.com](http://www.wago.com)

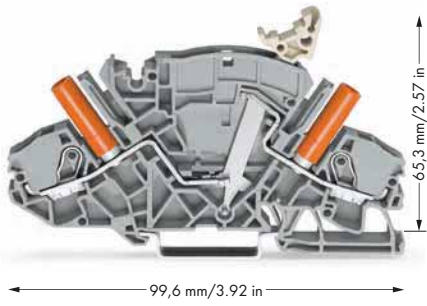

2-conductor disconnect/test terminal block, e.g., voltage transformer circuits, with touch-proof test sockets, for 4 mm Ø test plugs

Color	Item No.	Pack. Unit
○ gray	2007-8811	25



500 V
6 kV
30 A
300 V, 30 A
6 mm <sup>2</sup>
0.5 ... 10 mm <sup>2</sup> / 20 ... 8 AWG
1 ... 10 mm <sup>2</sup> / 14 ... 8 AWG
0.5 ... 10 mm <sup>2</sup> / 20 ... 8 AWG
1.5 mm <sup>2</sup> / 16 AWG
13 ... 15 mm / 0.51 ... 0.59 inch
8 mm / 0.315 inch
Polyamide 66 (PA 66)

	Item No.	Page
2-way	282-432	118
orange	2007-8892	118
plain	793-5501	780
white	2009-110	783

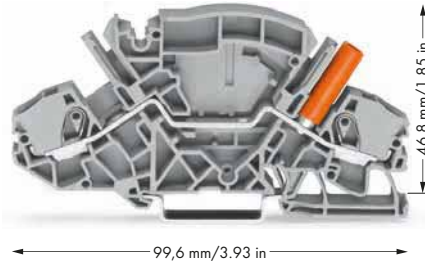

2-conductor through terminal block, with touch-proof test socket, for 4 mm Ø test plugs

Color	Item No.	Pack. Unit
○ gray	2007-8801	25



IEC/EN 60947-7-1
500 V
6 kV
30 A
300 V, 30 A
6 mm <sup>2</sup>
0.5 ... 10 mm <sup>2</sup> / 20 ... 8 AWG
1 ... 10 mm <sup>2</sup> / 14 ... 8 AWG
0.5 ... 10 mm <sup>2</sup> / 20 ... 8 AWG
1.5 mm <sup>2</sup> / 16 AWG
13 ... 15 mm / 0.51 ... 0.59 inch
8 mm / 0.315 inch
Polyamide 66 (PA 66)

	Item No.	Page
2-way	282-432	118
orange	2007-8892	118
plain	793-5501	780
white	2009-110	783



2-conductor ground terminal block, with touch-proof test socket, for 4 mm Ø test plugs

Color	Item No.	Pack. Unit
● green-yellow	2007-8807	25

IEC/EN 60947-7-2
6 mm <sup>2</sup>
0.5 ... 10 mm <sup>2</sup> / 20 ... 8 AWG
1 ... 10 mm <sup>2</sup> / 14 ... 8 AWG
0.5 ... 10 mm <sup>2</sup> / 20 ... 8 AWG
1.5 mm <sup>2</sup> / 16 AWG
13 ... 15 mm / 0.51 ... 0.59 inch
8 mm / 0.315 inch
Polyamide 66 (PA 66)

	Item No.	Page
2-way	282-432	118
orange	2007-8892	118
plain	793-5501	780
white	2009-110	783

## TOPJOB® S

## Terminal Block Assemblies for Current and Voltage Transformers

6 (10) mm<sup>2</sup>, 2006 Series

1

**2007-8873**

- 2 x screwless end stop, 10 mm wide (249-117)
- 3 x locking cover, mechanically locks multiple links, 2-pole (282-882)
- 1 x locking cover, mechanically locks multiple links, 4-pole (282-884)
- 3 x circuit jumper, insulated, 2-way (2007-8442)
- 1 x 2-conductor ground terminal block, with touch-proof test socket, for 4 mm Ø test plugs (2007-8807)
- 4 x 2-conductor disconnect/test terminal block, with touch-proof test sockets, for 4 mm Ø test plugs (2007-8811)
- 6 x 2-conductor disconnect/test terminal block, with touch-proof test sockets, for 4 mm Ø test plugs (2007-8821)
- 2 x end and separator plate, 1.5 mm thick, without lock-out seal option (2007-8892)
- 21 x WMB Inline, plain, 8,000 WMB markers (5 mm) per reel (2009-135)
- 1 x jumper, insulated, 1-3-5 (282-435/011-000)

Assembly width incl. end stop: 11.2 cm

**2007-8876**

- 2 x screwless end stop, 10 mm wide (249-117)
- 1 x collective jumper carrier, for DIN-35 rail, compatible with jumpers for transverse switching (282-811) and longitudinal switching disconnect (282-821) terminal blocks (282-369)
- 3 x locking cover, mechanically locks multiple links, 2-pole (282-882)
- 3 x circuit jumper, insulated, 2-way (2007-8442)
- 6 x 2-conductor disconnect/test terminal block, with touch-proof test sockets, for 4 mm Ø test plugs (2007-8821)
- 1 x end and separator plate, 1.5 mm thick, without lock-out seal option (2007-8892)
- 12 x WMB Inline, plain, 8,000 WMB markers (5 mm) per reel (2009-135)
- 1 x jumper, insulated, 1-3-5 (282-435/011-000)

Assembly width incl. end stop: 8.5 cm

**Compact terminal block for current transformer circuit**

Item No.	Pack. Unit
2007-8873	1

**Compact terminal block for 3-phase current transformer circuit**

Item No.	Pack. Unit
2007-8876	1

**Technical Data**

Rated voltage (III / 3)	500 V
Rated surge voltage (III / 3)	6 kV
Nominal cross section	6 mm <sup>2</sup>
<b>Connection Data</b>	
Solid conductor	0.5 ... 10 mm <sup>2</sup> / 20 ... 8 AWG
Solid conductor, push-in termination	1 ... 10 mm <sup>2</sup> / 14 ... 8 AWG
Fine-stranded conductor	0.5 ... 10 mm <sup>2</sup> / 20 ... 8 AWG
Fine-stranded conductor with ferrule, push-in termination, min.	1.5 mm <sup>2</sup> / 16 AWG
Strip length	13 ... 15 mm / 0.51 ... 0.59 inch
Insulation material	Polyamide 66 (PA 66)

## Installation

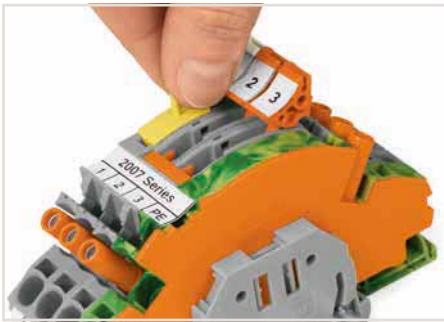

Lock-out prevents accidental operation of disconnect link.



Using locking covers or profiles for adjacent terminal blocks allows disconnect links to be operated simultaneously.



Lock-out snaps into one of two notched positions.



A lock-out seal can be used on the disconnect link in operating position I in combination with an end and separator plate (2007-8893 or 2007-8894).



Additional commoning option on the transformer side



Interlocking link mechanically locks multiple links for multi-pole switching applications.

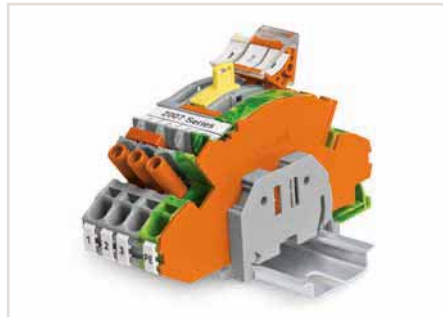

Preparing shunting path for the current transformer circuits.



Insert insulated, touch-proof circuit jumpers into jumper slot.

## TOPJOB® S

### Accessories, 2007 Series

#### Commoning, Mounting and Marking

1



Circuit jumper, insulated, I <sub>N</sub> 30 A, orange			
Suitable for:		Item No.	Pack. Unit
2007-8821	2-way	2007-8442	50 (10)
	3-way	2007-8443	50 (10)
	4-way	2007-8444	50 (10)
	5-way	2007-8445	50 (10)
	6-way	2007-8446	50 (10)
	7-way	2007-8447	50 (10)
	8-way	2007-8448	50 (10)



Jumper, insulated, I <sub>N</sub> 30 A, orange		
	Item No.	Pack. Unit
2-way	282-432	50 (10)
3-way	282-433	50 (10)
4-way	282-434	50 (10)
5-way	282-435	50 (10)
6-way	282-436	50 (10)
7-way	282-437	50 (10)
8-way	282-438	50 (10)
9-way	282-439	50 (10)
10-way	282-440	50 (10)



Jumper with safety lid, insulated, I <sub>N</sub> 30 A, orange		
	Item No.	Pack. Unit
2-way	282-432/100-000	50 (10)
3-way	282-433/100-000	50 (10)
4-way	282-434/100-000	50 (10)



Jumper, insulated, I <sub>N</sub> 30 A, orange		
	Item No.	Pack. Unit
1-3-5	282-435/011-000	50 (10)
1-4-5	282-435/301-000	50 (10)
1-2-4-6	282-436/301-000	50 (10)
1-4-6	282-436/304-000	50 (10)
1-3-5-7	282-437/011-000	50 (10)
1-4-7	282-437/012-000	50 (10)
1-2-5-8	282-438/300-000	50 (10)
1-4-7-8	282-438/301-000	50 (10)
1-3-5-7-9	282-439/011-000	50 (10)



End and separator plate, 1.5 mm thick, without lock-out seal option		
Color	Item No.	Pack. Unit
orange	2007-8892	50 (10)
gray	2007-8891	50 (10)



End and separator plate, 1.5 mm thick, with lock-out seal option		
Color	Item No.	Pack. Unit
orange	2007-8894	50 (10)
gray	2007-8893	50 (10)



Lock-out device, for disconnect link		
Color	Item No.	Pack. Unit
yellow	2007-8899	100 (20)



## TOPJOB® S

### Accessories, 2007 Series

#### Commoning, Mounting and Marking



Locking cover, mechanically locks multiple links, transparent		
	Item No.	Pack. Unit
1-pole	282-881	50 (10)
2-pole	282-882	50 (10)
3-pole	282-883	50 (10)
4-pole	282-884	50 (10)
5-pole	282-885	50 (10)
6-pole	282-886	50 (10)
7-pole	282-887	50 (10)
8-pole	282-888	50 (10)



Interlocking link, mechanically locks multiple links, 1 m long		
Color	Item No.	Pack. Unit
transparent	210-254	1

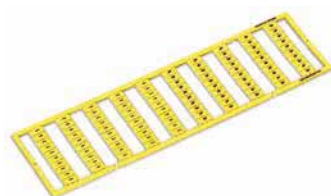

WMB Multi marking system, yellow, 10 strips with 10 markers per card, for 5 ... 17.5 mm terminal block width		
Marking	Item No.	Pack. Unit
k/I (50x each)	794-5553/000-002	5

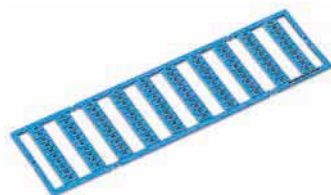

WMB Multi marking system, blue, 10 strips with 10 markers per card, for 5 ... 17.5 mm terminal block width		
Marking	Item No.	Pack. Unit
U/V (50x each)	794-5554/000-006	5



# TOPJOB® S

## Fuse Plugs on 2.5 (4) mm<sup>2</sup> Carrier Terminal Blocks Installation

1

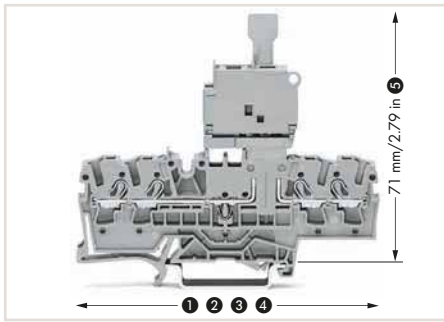

**Fuse plug dimensions:**

- 1 66.1 mm / 2.62 inch for 2002-1661
- 2 76.8 mm / 3.02 inch for 2002-1761
- 3 87.5 mm / 3.45 inch for 2002-1861
- 4 72.9 mm / 2.87 inch for 2002-1961
- 5 with inserted fuse plug

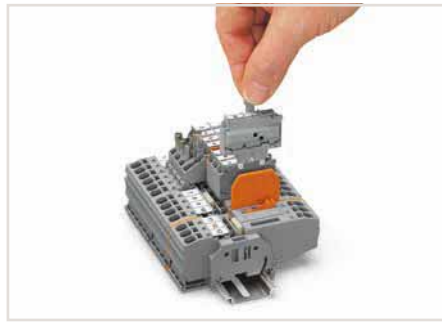

The end plate ensures that the fuse can only be removed when the fuse plug is pulled out.

**Miniature fuses 5 x 20**

Series Item No.	Overload and short circuit protection		Short circuit protection only	
	Individual argmt.	Group argmt.	Individual argmt.	Group argmt.
Fuse terminal blocks				
2004-911	1.6 W	1.6 W	2.5 W	2.5 W
2004-911/.....				

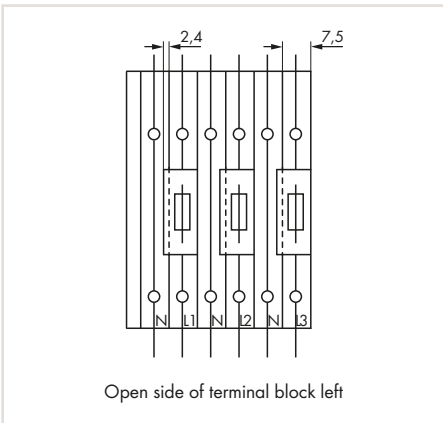
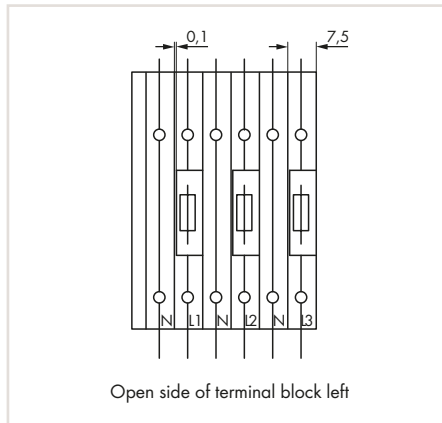
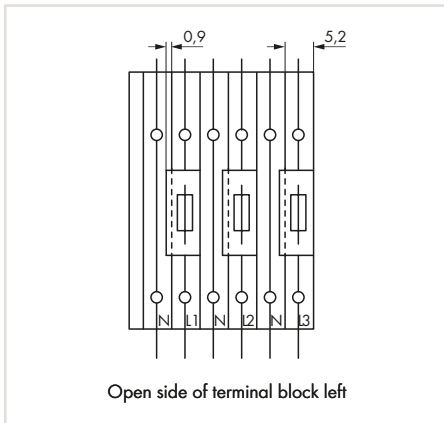

**Please note:**

The extra width of the plug (6.1 mm compared to 5.2 mm for carrier terminal blocks) must be compensated for with intermediate plates (1 mm) when building an assembly of carrier terminal blocks equipped with fuse plugs.

**When using 10.4 mm wide plugs, please note:**

The extra width of the plug (10.4 mm compared to 7.5 mm for carrier terminal blocks) must be compensated for with intermediate plates (2.9 mm) when building an assembly of carrier terminal blocks equipped with fuse plugs.

**Miniature fuses**

Series Item No.	Overload and short circuit protection		Short circuit protection only	
	Individual argmt.	Group argmt.	Individual argmt.	Group argmt.
Fused disconnect terminal blocks				
2006-911	7.5	1.6 W	1.6 W	2.5 W
2006-921	7.5	1.6 W	1.6 W	2.5 W
2006-931	7.5	1.6 W	1.6 W	2.5 W
2006-931 /099...	10.4	2.5 W	2.5 W	2.5 W
2006-931 /1099...	10.4	2.5 W	2.5 W	2.5 W

## TOPJOB® S

### Fuse Plugs on 2.5 (4) mm<sup>2</sup> Carrier Terminal Blocks

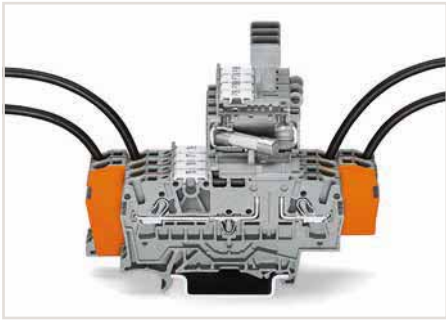

Please note:

The extra width of the plug (6.1 mm compared to 5.2 mm for carrier terminal blocks) must be compensated for with intermediate plates (1 mm) when building an assembly of carrier terminal blocks equipped with fuse plugs.



2004-911

2004-911/1000-541

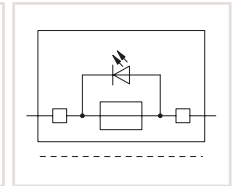
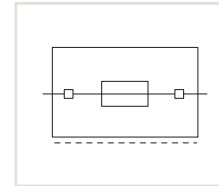

Fuse plug with pull-tab, for (5 x 20) mm miniature metric fuses  
Electrical ratings are given by the fuse.

Color	Item No.	Pack. Unit
○ gray	2004-911	25

Fuse plug with pull-tab, for (5 x 20) mm miniature metric fuses, with LED, gray  
Electrical ratings are given by the fuse and blown fuse indication. Leakage current in case of a blown fuse: LED 2 mA

Color	Item No.	Pack. Unit
○ 15 ... 30 V	2004-911/1000-541	25
○ 30 ... 65 V	2004-911/1000-542	25
○ 120 V	2004-911/1000-867	25
○ 230 V	2004-911/1000-836	25



#### Technical Data

Rated voltage (III / 3)

250 V

Rated current

6.3 A

Approval

250 V, 6.3 A ; 250 V, 6.3 A

Plug width

6.1 mm / 0.24 inch

Insulation material

Polyamide 66 (PA 66)

#### Accessories (Selection)

2-conductor carrier terminal block, 0.25 ... 4 mm<sup>2</sup>

(22 ... 12 AWG), 5.2 mm (0.205 inch) wide

gray 2002-1661 83

3-conductor carrier terminal block, 0.25 ... 4 mm<sup>2</sup>

(22 ... 12 AWG), 5.2 mm (0.205 inch) wide

gray 2002-1761 85

4-conductor carrier terminal block, 0.25 ... 4 mm<sup>2</sup>

(22 ... 12 AWG), 5.2 mm (0.205 inch) wide

gray 2002-1861 87

2-conductor carrier terminal block, 0.25 ... 4 mm<sup>2</sup>

(22 ... 12 AWG), 5.2 mm (0.205 inch) wide

gray 2002-1961 93

Double-deck carrier terminal block, 0.25 ... 4 mm<sup>2</sup>

(22 ... 12 AWG), 5.2 mm (0.205 inch) wide

L/L 2002-2961 81

Double-deck carrier terminal block, 0.25 ... 4 mm<sup>2</sup>

(22 ... 12 AWG), 5.2 mm (0.205 inch) wide

L/N 2002-2963 81

End plate for fuse terminal blocks, 2 mm thick

orange 2002-992 167

Shorting link, (5 x 20) mm, suitable when using the fuse plug as a disconnect plug, I<sub>n</sub> 6.3 A

281-503 175

Accessories (end plates, etc.), see page 167

Carrier rails and tools, see Section 13

Appropriate marking system, WMB/markings strips, see Full Line Catalog, Volume 6

Approvals and corresponding ratings, visit [www.wago.com](http://www.wago.com)

# TOPJOB® S

## Fuse Plugs on 6 (10) mm<sup>2</sup> Carrier Terminal Blocks

1

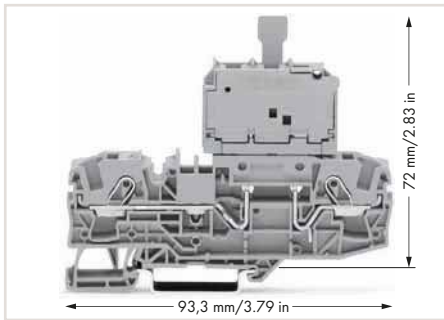

Pivoting fuse holder with spare fuse holder



When selecting miniature metric fuses, make sure that the maximum power loss listed above is not exceeded. The power loss is determined according to IEC or EN 60947-7-3/VDE 0611-6 at 23 °C. The temperature rise of the terminal blocks must be checked according to their application and mounting. Higher ambient temperatures place additional strain on fuse cartridges. Therefore, in such applications, the rated current must be reduced if necessary. More details are available from the manufacturers.

### Technical Data

Rated voltage (III / 3)	800 V
Rated current	10 A
Approval	600 V, 15 A <b>RU</b> ; 600 V, 15 A <b>CE</b>
Plug width	7.4 mm / 0.291 inch

### Accessories (Selection)

2-conductor carrier terminal block, 0.5 ... 10 mm <sup>2</sup> (20 ... 8 AWG), 7.5 mm (0.295 inch) wide	2006-1661	99
End and intermediate plate, 1 mm thick	2006-1692	171
Intermediate plate, 2.9 mm thick		
End plate for fuse terminal blocks, 2 mm thick	2006-992	172
Shorting link, (5 x 20) mm, suitable when using the fuse plug as a disconnect plug, I <sub>n</sub> 6.3 A	281-503	175

Accessories (end plates, etc.), see page 171

Carrier rails and tools, see Section 13

Appropriate marking system, WMB/markings strips, see Full Line Catalog, Volume 6

Approvals and corresponding ratings, visit [www.wago.com](http://www.wago.com)



2006-911

2006-911/1000-541

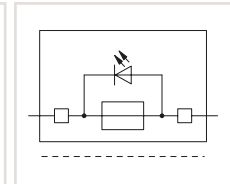
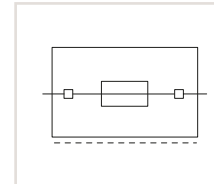

Fuse plug with pull-tab, for (5 x 20) mm miniature metric fuses  
Electrical ratings are given by the fuse.

Color	Item No.	Pack. Unit
○ gray	2006-911	25

Fuse plug with pull-tab, for (5 x 20) mm miniature metric fuses, with blown fuse indication by LED, gray  
Electrical ratings are given by the fuse and blown fuse indication. Leakage current in case of a blown fuse: LED 2 mA

	Item No.	Pack. Unit
○ 15 ... 30 V	2006-911/1000-541	25
○ 30 ... 65 V	2006-911/1000-542	25
○ 120 V	2006-911/1000-867	25
○ 230 V	2006-911/1000-836	25



800 V

10 A

600 V, 15 A **RU**; 600 V, 15 A **CE**

7.4 mm / 0.291 inch

	Item No.	Page
gray	2006-1661	99
orange	2006-1692	171
orange	2006-992	172
	281-503	175



2006-921

2006-921/1000-541

2006-931

2006-931/1000-541

2006-931/099-000

2006-931/1099-541

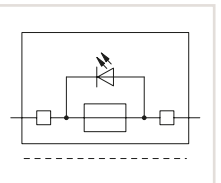
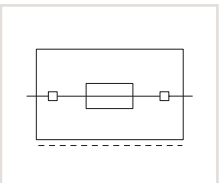
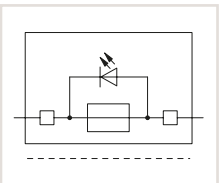
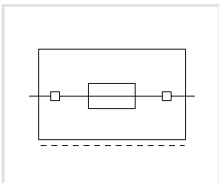
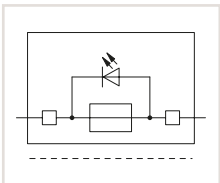
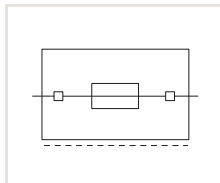

Fuse plug with pull-tab, for (5 x 30) mm miniature metric fuses  
Electrical ratings are given by the fuse.

Color	Item No.	Pack. Unit
○ gray	2006-921	25

Fuse plug with pull-tab, for ¼" x 1¼" miniature metric fuses  
Electrical ratings are given by the fuse.

Color	Item No.	Pack. Unit
○ gray	2006-931	25

Fuse plug with pull-tab, for ¼" x ¼" miniature metric fuses  
Electrical ratings are given by the fuse.

Color	Item No.	Pack. Unit
○ gray	2006-931/099-000	

Fuse plug with pull-tab, for (5 x 30) mm miniature metric fuses, with blown fuse indication by LED, gray  
Electrical ratings are given by the fuse and blown fuse indication. Leakage current in case of a blown fuse: LED 2 mA

	Item No.	Pack. Unit
○ 15 ... 30 V	2006-921/1000-541	25
○ 30 ... 65 V	2006-921/1000-542	25
○ 120 V	2006-921/1000-867	25
○ 230 V	2006-921/1000-836	25
○ 380 ... 500 V	2006-921/1000-859	25

Fuse plug with pull-tab, for ¼" x 1¼" miniature metric fuses, with blown fuse indication by LED, gray  
Electrical ratings are given by the fuse and blown fuse indication. Leakage current in case of a blown fuse: LED 2 mA

	Item No.	Pack. Unit
○ 15 ... 30 V	2006-931/1000-541	25
○ 30 ... 65 V	2006-931/1000-542	25
○ 120 V	2006-931/1000-867	25
○ 230 V	2006-931/1000-836	25
○ 380 ... 500 V	2006-931/1000-859	25

Fuse plug with pull-tab, for ¼" x ¼" miniature metric fuses, with blown fuse indication by LED, gray  
Electrical ratings are given by the fuse and blown fuse indication. Leakage current in case of a blown fuse: LED 2 mA

	Item No.	Pack. Unit
○ 15 ... 30 V	2006-931/1099-541	25
○ 30 ... 65 V	2006-931/1099-542	25
○ 120 V	2006-931/1099-867	25
○ 230 V	2006-931/1099-836	25
○ 380 ... 500 V	2006-931/1099-859	25



800 V  
10 A  
600 V, 15 A ; 600 V, 15 A

800 V  
10 A  
600 V, 15 A ; 600 V, 15 A

800 V  
10 A  
600 V, 15 A ; 600 V, 15 A

	Item No.	Page
gray	2006-1661	99
orange	2006-1692	171
orange	2006-992	172
	281-503	175

	Item No.	Page
gray	2006-1661	99
orange	2006-1692	171
orange	2006-992	172
	281-503	175

	Item No.	Page
gray	2006-1661	99
orange	2006-1696	171
orange	2006-992	172
	281-503	175

# TOPJOB® S

## Sensor and Actuator Terminal Blocks, 2000 Series

### Description and Installation

1

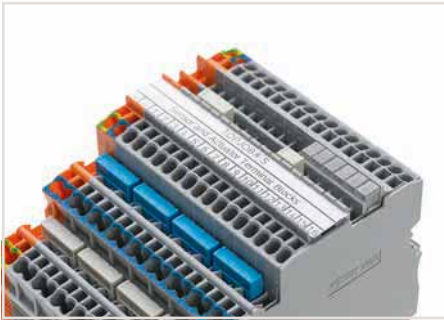

**Commoning (signal level):**  
Commoning the signal level with push-in type jumper bars (2000 Series). Models with an LED can only be commoned in one jumper slot. TOPJOB® S Test Plug Adapters can be used in all jumper slots.



**Upper level: two independent signal pathways**



**Commoning (potential level):**  
Commoning potential levels via push-in type jumper bars (2000 Series).



Power supply via orange supply terminal block of same profile from both the cabinet and sensor sides

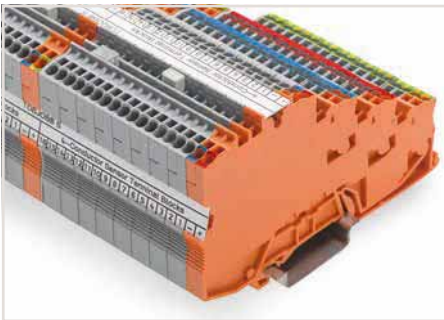

**Labeling**  
Labeling via marking strips (2009-110) – from the top or the side.

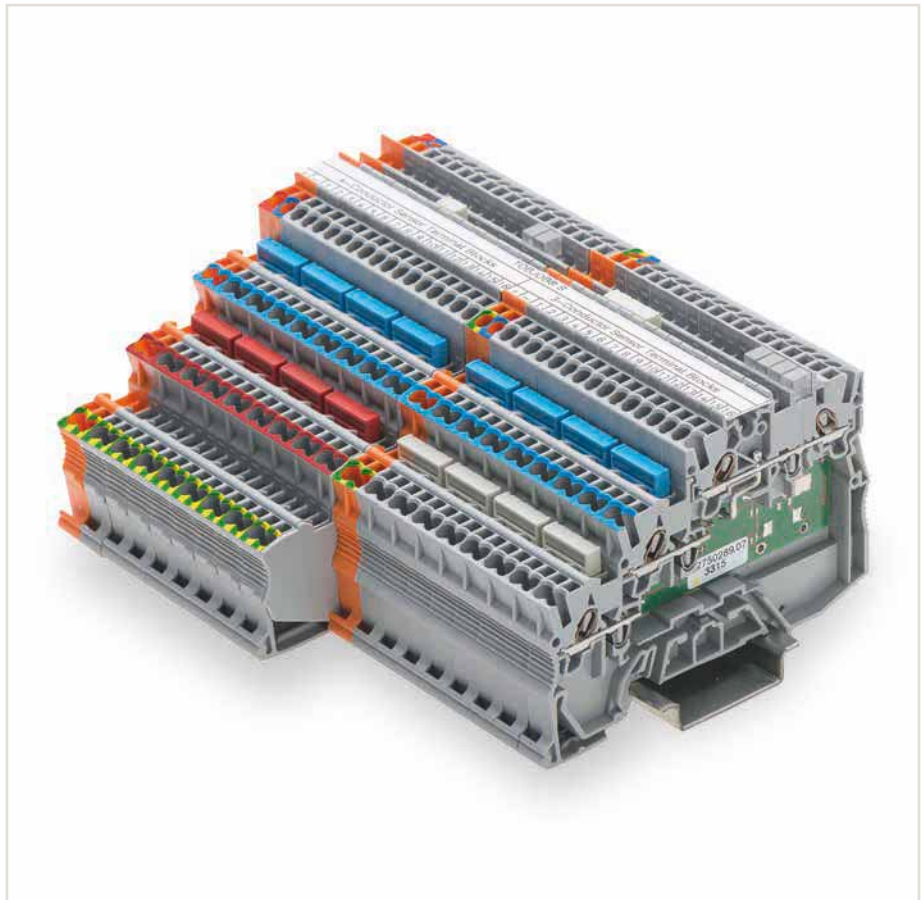

Terminal block assembly with 4-conductor sensor terminal blocks and 3-conductor actuator terminal blocks

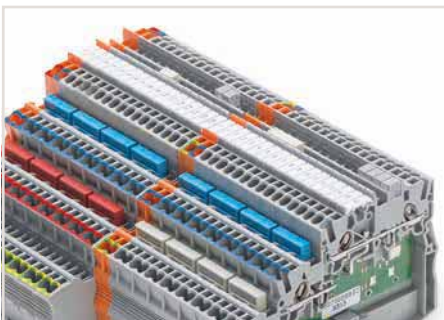

**Labeling**  
Labeling via 3.5 mm WMB markers (793-35xx) from the top or the side – additional marking option via marker carrier.

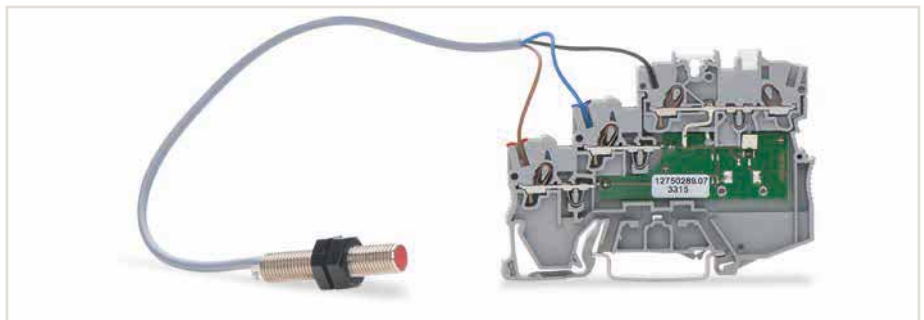

3-conductor sensor LED terminal block with a connected sensor





**Commoning (potential level):**  
Continuous commoning in the potential levels via push-in type jumper bars for even pole numbers (2000 Series)



Two adjacent commoning options on a current bar

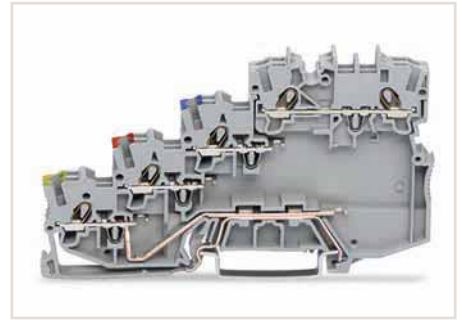

4-conductor sensor terminal block with ground contact

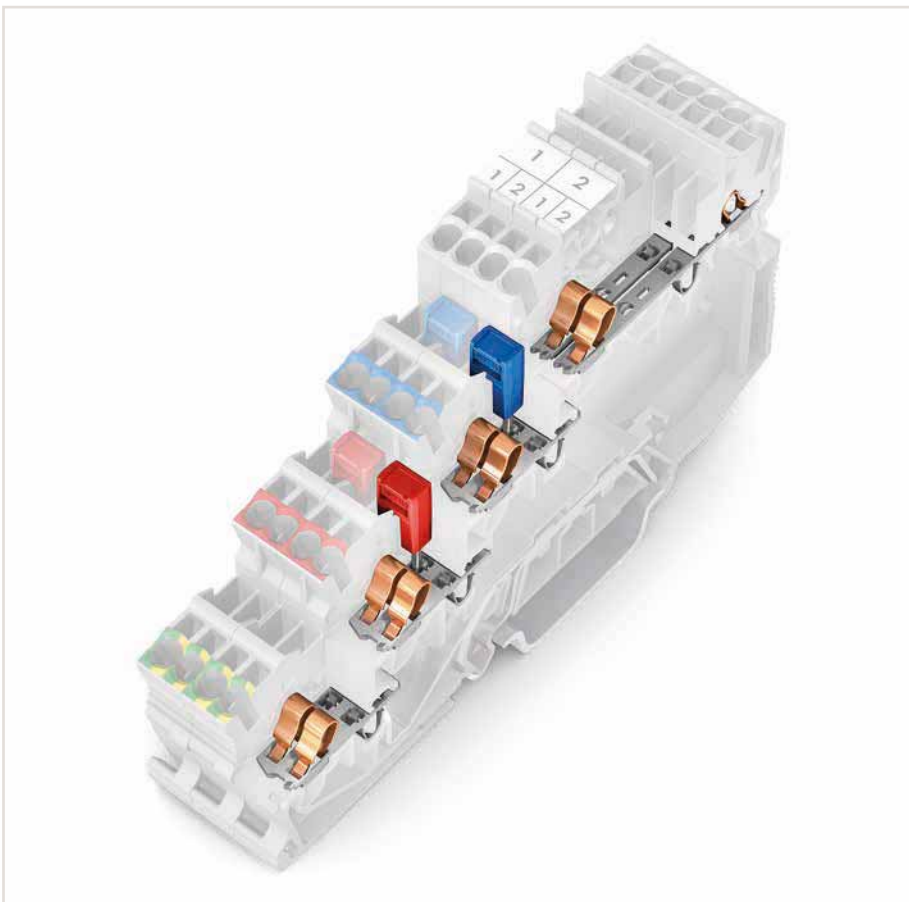

Upper level: two independent signal pathways, in 3.5 mm spacing per pole, with a dual jumper slot  
Lower levels: two interconnected potential clamping units, with a single jumper slot, can be commoned in both directions



**Ground commoning:**  
For sensor and actuator terminal blocks without ground connection to the DIN-rail, the ground connection can be performed by commoning to the terminal block with a ground foot.

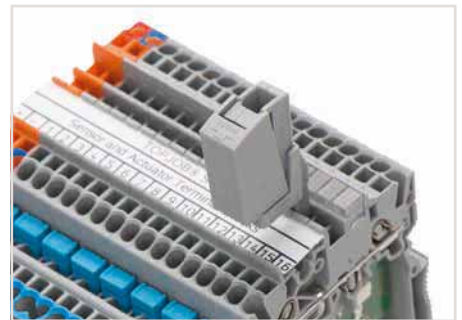

Testing via testing tap (2009-182) (up to max. 42 V).

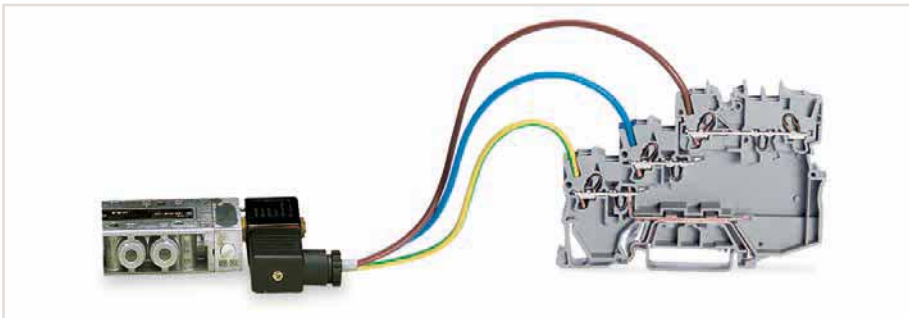

3-conductor actuator LED terminal block with a connected actuator

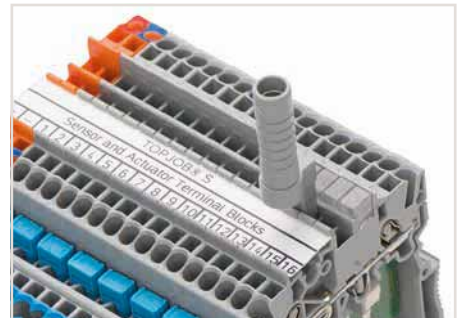

Testing via test plug adapter (2009-174) (up to max. 42 V).



## TOPJOB® S

### 3-Conductor Sensor Terminal Blocks

#### 1 (1.5) mm<sup>2</sup>, 2000 Series



Power supply via orange supply terminal block of same profile from both the cabinet and sensor sides

#### Note:

The double spacing per pole of this terminal block series maximizes connectivity. For example, ten sensors may be connected using only five sensor terminal blocks plus a power supply terminal block.

3.5 mm spacing per signal  
(2 x 3.5 mm = 7 mm)

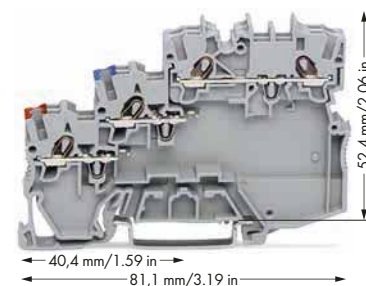

2000-5311

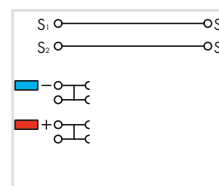

3-conductor sensor terminal block

Color	Item No.	Pack. Unit
gray	2000-5311	50

#### Technical Data

Ratings per	IEC/EN 60947-7-1
Voltage type	
Nominal voltage	
Rated voltage (III / 3)	250 V
Rated surge voltage (III / 3)	4 kV
Rated current	13.5 A
Nominal cross section	1 mm <sup>2</sup>
<b>Connection Data</b>	
Solid conductor	0.14 ... 1.5 mm <sup>2</sup> / 24 ... 16 AWG
Solid conductor, push-in termination	0.5 ... 1.5 mm <sup>2</sup> / 20 ... 16 AWG
Fine-stranded conductor	0.14 ... 1.5 mm <sup>2</sup> / 24 ... 16 AWG
Fine-stranded conductor with ferrule, push-in termination, min.	0.5 mm <sup>2</sup> / 20 AWG
Strip length	9 ... 11 mm / 0.35 ... 0.43 inch
Terminal block width	7 mm / 0.276 inch
Insulation material	Polyamide 66 (PA 66)

#### Accessories (Selection)

	Item No.	Page
Push-in type jumper bar, insulated, I <sub>n</sub> 14 A, light gray	2000-402	160
End and intermediate plate, 1 mm thick	gray 2000-5391	161
WMB Multi marking system, white, 10 strips with 10 markers per card, for 3.5 mm terminal block width	plain 793-3501	780
Marking strip, plain, 11 mm wide, 50 m reel	white 2009-110	783
Test plug adapter, for 4 mm Ø test plug	gray 2009-174	175

Accessories (jumpers, end plates, test plugs, etc.), see page 160

Carrier rails and tools, see Section 13

Appropriate marking system, WMB/markings strips, see Full Line Catalog, Volume 6

Approvals and corresponding ratings, visit [www.wago.com](http://www.wago.com)

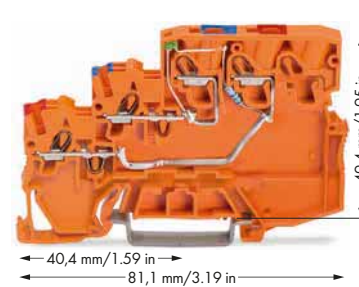
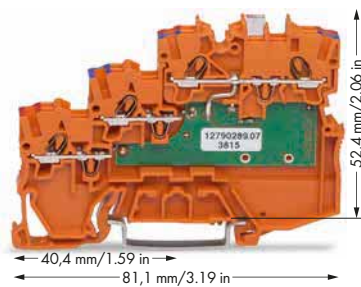
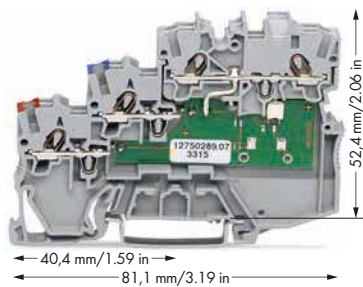

2000-5311/1102-950    2000-5311/1101-951

2000-5372/1102-953    2000-5372

2000-5352/1102-953    2000-5352

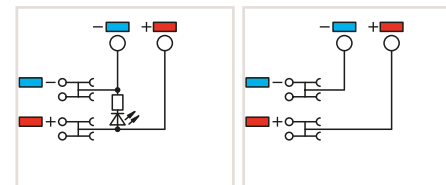
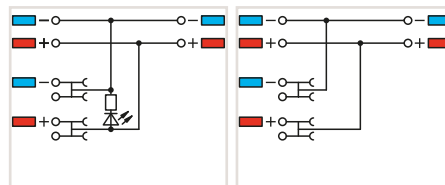
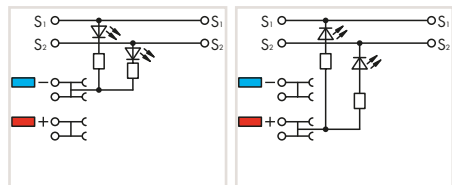

3-conductor sensor LED terminal block, for PNP (high-side) switching sensors, yellow LED

Color	Item No.	Pack. Unit
gray	2000-5311/1102-950	50

3-conductor sensor LED supply terminal block, 24 VDC, green LED

Color	Item No.	Pack. Unit
orange	2000-5372/1102-953	15

3-conductor sensor LED supply terminal block, 24 VDC, green LED, control panel side: 2.5 (4) mm<sup>2</sup>, max. 28 A

Color	Item No.	Pack. Unit
orange	2000-5352/1102-953	15

3-conductor sensor LED terminal block, for NPN (low-side) switching sensors, yellow LED

Color	Item No.	Pack. Unit
gray	2000-5311/1101-951	50

3-conductor sensor supply terminal block, max. 250 V, internally commoned

Color	Item No.	Pack. Unit
orange	2000-5372	15

3-conductor sensor supply terminal block, max. 250 V, control panel side: 2.5 (4) mm<sup>2</sup>, max. 28 A

Color	Item No.	Pack. Unit
orange	2000-5352	15

IEC/EN 60947-7-1
DC
24 V
13.5 A
1 mm <sup>2</sup>
0.14 ... 1.5 mm <sup>2</sup> / 24 ... 16 AWG
0.5 ... 1.5 mm <sup>2</sup> / 20 ... 16 AWG
0.14 ... 1.5 mm <sup>2</sup> / 24 ... 16 AWG
0.5 mm <sup>2</sup> / 20 AWG
9 ... 11 mm / 0.35 ... 0.43 inch
7 mm / 0.276 inch
Polyamide 66 (PA 66)

IEC/EN 60947-7-1
13.5 A
1 mm <sup>2</sup>
0.14 ... 1.5 mm <sup>2</sup> / 24 ... 16 AWG
0.5 ... 1.5 mm <sup>2</sup> / 20 ... 16 AWG
0.14 ... 1.5 mm <sup>2</sup> / 24 ... 16 AWG
0.5 mm <sup>2</sup> / 20 AWG
9 ... 11 mm / 0.35 ... 0.43 inch
7 mm / 0.276 inch
Polyamide 66 (PA 66)

IEC/EN 60947-7-1
13.5 A
1 mm <sup>2</sup>
0.14 ... 1.5 mm <sup>2</sup> / 24 ... 16 AWG
0.5 ... 1.5 mm <sup>2</sup> / 20 ... 16 AWG
0.14 ... 1.5 mm <sup>2</sup> / 24 ... 16 AWG
0.5 mm <sup>2</sup> / 20 AWG
9 ... 11 mm / 0.35 ... 0.43 inch
7 mm / 0.276 inch
Polyamide 66 (PA 66)

	Item No.	Page
2-way	2000-402	160
gray	2000-5391	161
plain	793-3501	780
white	2009-110	783
gray	2009-174	175

	Item No.	Page
2-way	2000-402	160
gray	2000-5391	161
plain	793-3501	780
white	2009-110	783
gray	2009-174	175

	Item No.	Page
2-way	2000-402	160
gray	2000-5391	161
plain	793-3501	780
white	2009-110	783
gray	2009-174	175

# TOPJOB® S

## 4-Conductor Sensor Terminal Blocks

### 1 (1.5) mm<sup>2</sup>, 2000 Series

1



For example, colored push-in type jumper bars are used with sensor terminal blocks.

**Note:**  
The double spacing per pole of this terminal block series maximizes connectivity. For example, ten sensors may be connected using only five sensor terminal blocks plus a power supply terminal block.  
3.5 mm spacing per signal  
(2 x 3.5 mm = 7 mm)

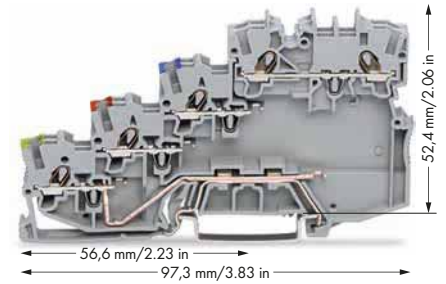

2000-5417		2000-5410	
4-conductor sensor terminal block, with ground connection			
Color	Item No.	Pack. Unit	
● gray	2000-5417	50	
4-conductor sensor terminal block, with ground via push-in type jumper bar			
Color	Item No.	Pack. Unit	
● gray	2000-5410	50	

#### Technical Data

Ratings per	IEC/EN 60947-7-1
Voltage type	
Nominal voltage	
Rated voltage (III / 3)	250 V
Rated surge voltage (III / 3)	4 kV
Rated current	13.5 A
Nominal cross section	1 mm <sup>2</sup>
<b>Connection Data</b>	
Solid conductor	0.14 ... 1.5 mm <sup>2</sup> / 24 ... 16 AWG
Solid conductor, push-in termination	0.5 ... 1.5 mm <sup>2</sup> / 20 ... 16 AWG
Fine-stranded conductor	0.14 ... 1.5 mm <sup>2</sup> / 24 ... 16 AWG
Fine-stranded conductor with ferrule, push-in termination, min.	0.5 mm <sup>2</sup> / 20 AWG
Strip length	9 ... 11 mm / 0.35 ... 0.43 inch
Terminal block width	7 mm / 0.276 inch
Insulation material	Polyamide 66 (PA 66)

#### Accessories (Selection)

	Item No.	Page
Push-in type jumper bar, insulated, I <sub>N</sub> 14 A, light gray	2000-402	160
End and intermediate plate, 1 mm thick	2000-5491	161
Test plug adapter, for 4 mm Ø test plug	2009-174	175

Accessories (jumpers, end plates, test plugs, etc.), see page 160

Carrier rails and tools, see Section 13

Appropriate marking system, WMB/markings strips, see Full Line Catalog, Volume 6

Approvals and corresponding ratings, visit [www.wago.com](http://www.wago.com)

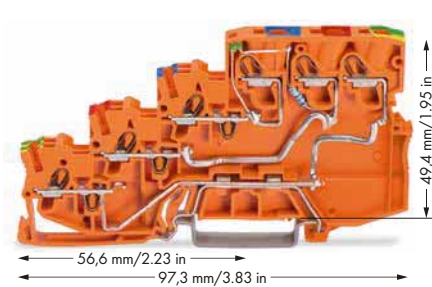
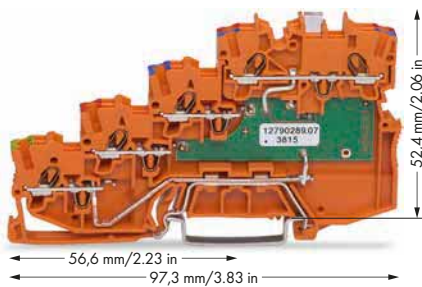
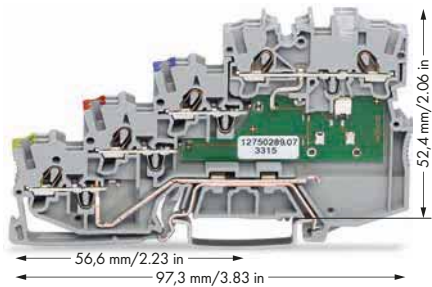

2000-5417/1102-950    2000-5417/1101-951

4-conductor sensor LED terminal block, yellow LED, for PNP (high-side) switching sensors, with ground connection

Color	Item No.	Pack. Unit
gray	2000-5417/1102-950	50

2000-5477/1102-953    2000-5477

4-conductor sensor LED supply terminal block, 24 VDC, green LED, with ground connection

Color	Item No.	Pack. Unit
orange	2000-5477/1102-953	15

2000-5457/1102-953    2000-5457

4-conductor sensor LED supply terminal block, 24 VDC, green LED, with ground connection, control panel side: 2.5 (4) mm<sup>2</sup>, max. 28 A

Color	Item No.	Pack. Unit
orange	2000-5457/1102-953	15

4-conductor sensor LED terminal block, yellow LED, for PNP (high-side) switching sensors, with ground via push-in type jumper bar

Color	Item No.	Pack. Unit
gray	2000-5410/1102-950	50

4-conductor sensor supply terminal block, max. 250 V, internally commoned, with ground connection

Color	Item No.	Pack. Unit
orange	2000-5477	15

4-conductor sensor supply terminal block, max. 250 V, with ground connection, control panel side: 2.5 (4) mm<sup>2</sup>, max. 28 A

Color	Item No.	Pack. Unit
orange	2000-5457	15

4-conductor sensor LED terminal block, yellow LED, for NPN (low-side) switching sensors, with ground connection

Color	Item No.	Pack. Unit
gray	2000-5417/1101-951	50

4-conductor sensor LED terminal block, yellow LED, for NPN (low-side) switching sensors, with ground via push-in type jumper bar

Color	Item No.	Pack. Unit
gray	2000-5410/1101-951	50

IEC/EN 60947-7-1
DC
24 V
13.5 A
1 mm <sup>2</sup>
0.14 ... 1.5 mm <sup>2</sup> / 24 ... 16 AWG
0.5 ... 1.5 mm <sup>2</sup> / 20 ... 16 AWG
0.14 ... 1.5 mm <sup>2</sup> / 24 ... 16 AWG
0.5 mm <sup>2</sup> / 20 AWG
9 ... 11 mm / 0.35 ... 0.43 inch
7 mm / 0.276 inch
Polyamide 66 (PA 66)

IEC/EN 60947-7-1
13.5 A
1 mm <sup>2</sup>
0.14 ... 1.5 mm <sup>2</sup> / 24 ... 16 AWG
0.5 ... 1.5 mm <sup>2</sup> / 20 ... 16 AWG
0.14 ... 1.5 mm <sup>2</sup> / 24 ... 16 AWG
0.5 mm <sup>2</sup> / 20 AWG
9 ... 11 mm / 0.35 ... 0.43 inch
7 mm / 0.276 inch
Polyamide 66 (PA 66)

IEC/EN 60947-7-1
13.5 A
1 mm <sup>2</sup>
0.14 ... 1.5 mm <sup>2</sup> / 24 ... 16 AWG
0.5 ... 1.5 mm <sup>2</sup> / 20 ... 16 AWG
0.14 ... 1.5 mm <sup>2</sup> / 24 ... 16 AWG
0.5 mm <sup>2</sup> / 20 AWG
9 ... 11 mm / 0.35 ... 0.43 inch
7 mm / 0.276 inch
Polyamide 66 (PA 66)

	Item No.	Page
2-way	2000-402	160
gray	2000-5491	161
gray	2009-174	175

	Item No.	Page
2-way	2000-402	160
gray	2000-5491	161
gray	2009-174	175

	Item No.	Page
2-way	2000-402	160
gray	2000-5491	161
gray	2009-174	175

# TOPJOB® S

## 3-Conductor Actuator Terminal Blocks

### 1 (1.5) mm<sup>2</sup>, 2000 Series

1

**Note:**

The double spacing per pole of this terminal block series maximizes connectivity. For example, ten sensors may be connected using only five sensor terminal blocks plus a power supply terminal block.

3.5 mm spacing per signal  
(2 x 3.5 mm = 7 mm)

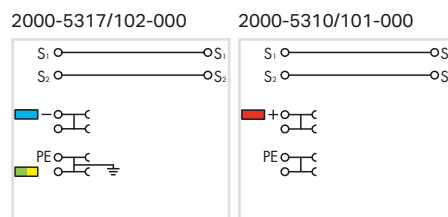
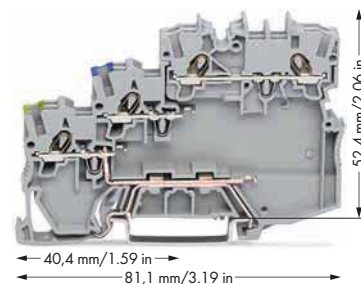

3-conductor actuator terminal block, for PNP (high-side) switching actuators, with ground connection

Color	Item No.	Pack. Unit
gray	2000-5317/102-000	50

3-conductor actuator terminal block, for PNP (high-side) switching actuators, with ground via push-in type jumper bar

Color	Item No.	Pack. Unit
gray	2000-5310/102-000	50

3-conductor actuator terminal block, for NPN (low-side) switching actuators, with ground connection

Color	Item No.	Pack. Unit
gray	2000-5317/101-000	50

3-conductor actuator terminal block, for NPN (low-side) switching actuators, with ground via push-in type jumper bar

Color	Item No.	Pack. Unit
gray	2000-5310/101-000	50

**Technical Data**

Ratings per	IEC/EN 60947-7-1
Voltage type	
Nominal voltage	
Rated voltage (III / 3)	250 V
Rated surge voltage (III / 3)	4 kV
Rated current	13.5 A
Nominal cross section	1 mm <sup>2</sup>
<b>Connection Data</b>	
Solid conductor	0.14 ... 1.5 mm <sup>2</sup> / 24 ... 16 AWG
Solid conductor, push-in termination	0.5 ... 1.5 mm <sup>2</sup> / 20 ... 16 AWG
Fine-stranded conductor	0.14 ... 1.5 mm <sup>2</sup> / 24 ... 16 AWG
Fine-stranded conductor with ferrule, push-in termination, min.	0.5 mm <sup>2</sup> / 20 AWG
Strip length	9 ... 11 mm / 0.35 ... 0.43 inch
Terminal block width	7 mm / 0.276 inch
Insulation material	Polyamide 66 (PA 66)

**Accessories (Selection)**

Push-in type jumper bar, insulated, I <sub>N</sub> 14 A, light gray
End and intermediate plate, 1 mm thick
Test plug adapter, for 4 mm Ø test plug

	Item No.	Page
2-way	2000-402	160
gray	2000-5391	161
gray	2009-174	175

Accessories (jumpers, end plates, test plugs, etc.), see page 160

Carrier rails and tools, see Section 13

Appropriate marking system, WMB/markings strips, see Full Line Catalog, Volume 6

Approvals and corresponding ratings, visit [www.wago.com](http://www.wago.com)

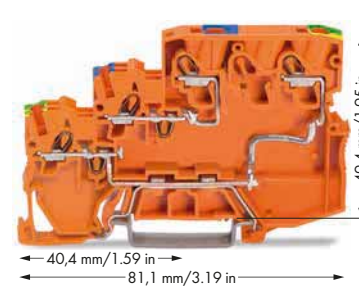
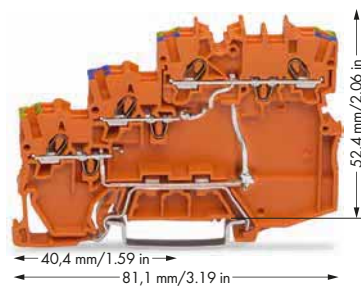
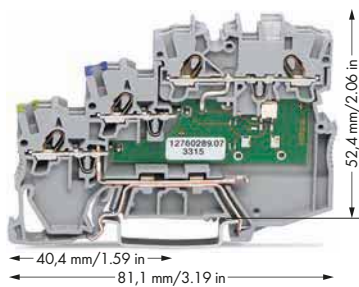

2000-5317/1102-950    2000-5310/1101-951

2000-5377/102-000    2000-5377/101-000

2000-5357/102-000    2000-5357/101-000

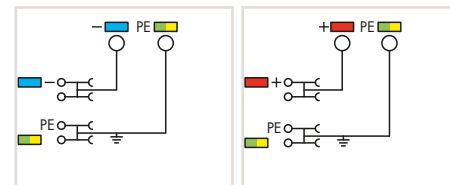
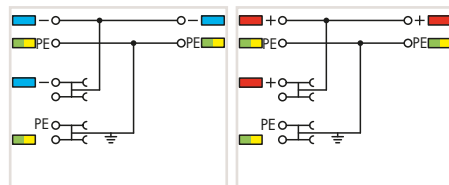
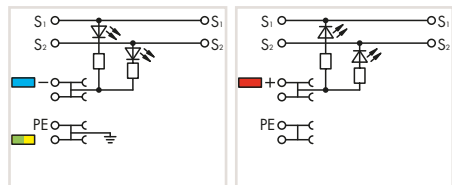

3-conductor actuator terminal block, yellow LED, for PNP (high-side) switching actuators, with ground connection

3-conductor actuator supply terminal block, max. 250 V, for PNP (high-side) switching actuators, with ground connection, internally commoned

3-conductor actuator supply terminal block, max. 250 V, control panel side: 2.5 (4) mm<sup>2</sup>, max. 28 A, for PNP (high-side) switching actuators, with ground connection

Color	Item No.	Pack. Unit
○ gray	2000-5317/1102-950	50

Color	Item No.	Pack. Unit
● orange	2000-5377/102-000	15

Color	Item No.	Pack. Unit
● orange	2000-5357/102-000	15

3-conductor actuator terminal block, yellow LED, for PNP (high-side) switching actuators, with ground via push-in type jumper bar

3-conductor actuator supply terminal block, max. 250 V, for NPN (low-side) switching actuators, with ground connection

3-conductor actuator supply terminal block, max. 250 V, control panel side: 2.5 (4) mm<sup>2</sup>, max. 28 A, for NPN (low-side) switching actuators, with ground connection

Color	Item No.	Pack. Unit
○ gray	2000-5310/1102-950	50

Color	Item No.	Pack. Unit
● orange	2000-5377/101-000	15

Color	Item No.	Pack. Unit
● orange	2000-5357/101-000	15

3-conductor actuator terminal block, yellow LED, for NPN (low-side) switching actuators, with ground connection

Color	Item No.	Pack. Unit
○ gray	2000-5317/1101-951	50

3-conductor actuator terminal block, yellow LED, for NPN (low-side) switching actuators, with ground via push-in type jumper bar

Color	Item No.	Pack. Unit
○ gray	2000-5310/1101-951	50

IEC/EN 60947-7-1		
DC		
24 V		
13.5 A		
1 mm <sup>2</sup>		
0.14 ... 1.5 mm <sup>2</sup> / 24 ... 16 AWG		
0.5 ... 1.5 mm <sup>2</sup> / 20 ... 16 AWG		
0.14 ... 1.5 mm <sup>2</sup> / 24 ... 16 AWG		
0.5 mm <sup>2</sup> / 20 AWG		
9 ... 11 mm / 0.35 ... 0.43 inch		
7 mm / 0.276 inch		
Polyamide 66 (PA 66)		

IEC/EN 60947-7-1		
13.5 A		
1 mm <sup>2</sup>		
0.14 ... 1.5 mm <sup>2</sup> / 24 ... 16 AWG		
0.5 ... 1.5 mm <sup>2</sup> / 20 ... 16 AWG		
0.14 ... 1.5 mm <sup>2</sup> / 24 ... 16 AWG		
0.5 mm <sup>2</sup> / 20 AWG		
9 ... 11 mm / 0.35 ... 0.43 inch		
7 mm / 0.276 inch		
Polyamide 66 (PA 66)		

IEC/EN 60947-7-1		
13.5 A		
1 mm <sup>2</sup>		
0.14 ... 1.5 mm <sup>2</sup> / 24 ... 16 AWG		
0.5 ... 1.5 mm <sup>2</sup> / 20 ... 16 AWG		
0.14 ... 1.5 mm <sup>2</sup> / 24 ... 16 AWG		
0.5 mm <sup>2</sup> / 20 AWG		
9 ... 11 mm / 0.35 ... 0.43 inch		
7 mm / 0.276 inch		
Polyamide 66 (PA 66)		

	Item No.	Page
2-way	2000-402	160
gray	2000-5391	161
gray	2009-174	175

	Item No.	Page
2-way	2000-402	160
gray	2000-5391	161
gray	2009-174	175

	Item No.	Page
2-way	2000-402	160
gray	2000-5391	160
gray	2009-174	175



# TOPJOB® S

## Diode Terminal Blocks

### 1.5 (2.5) mm<sup>2</sup>, 2001 Series

1

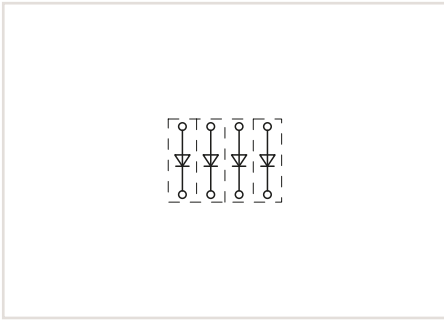

Open diode gates can be created using the following terminal blocks:  
2001-1211/1000-410 or 2001-1211/1000-411

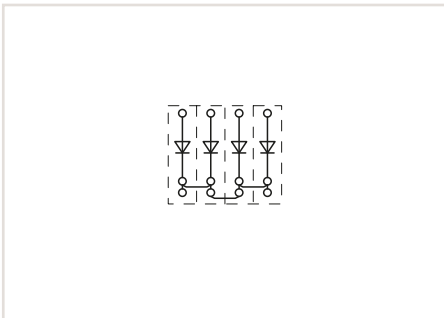

Open diode gates can be created using the following terminal blocks:  
2001-1311/1000-410 or 2001-1311/1000-411

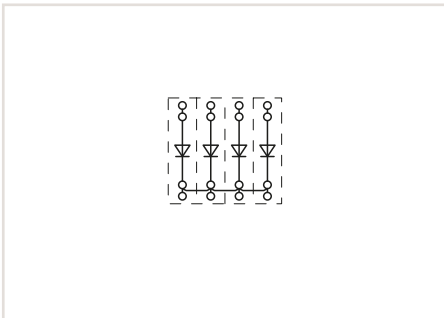

Open diode gates can be created using the following terminal blocks:  
2001-1411/1000-410 or 2001-1411/1000-411

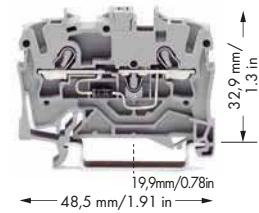

2001-1211/1000-411      2001-1211/1000-410

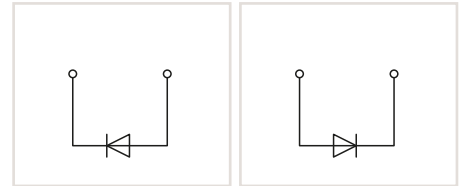

2-conductor diode terminal block, with 1N4007 diode

Color	Item No.	Pack. Unit
○ gray	2001-1211/1000-411	100
○ gray	2001-1211/1000-410	100

#### Technical Data

Ratings per	IEC/EN 60947-7-1
Nominal voltage	250 V
Reverse voltage	1000 V
Rated current	0.5 A
Nominal cross section	1.5 mm <sup>2</sup>
<b>Connection Data</b>	
Solid conductor	0.25 ... 2.5 mm <sup>2</sup> / 22 ... 14 AWG
Solid conductor, push-in termination	0.5 ... 2.5 mm <sup>2</sup> / 20 ... 14 AWG
Fine-stranded conductor	0.25 ... 2.5 mm <sup>2</sup> / 22 ... 14 AWG
Fine-stranded conductor with ferrule, push-in termination, min.	0.75 mm <sup>2</sup> / 18 AWG
Strip length	9 ... 11 mm / 0.35 ... 0.43 inch
Terminal block width	4.2 mm / 0.165 inch
Insulation material	Polyamide 66 (PA 66)

#### Accessories (Selection)

Push-in type jumper bar, insulated, I <sub>N</sub> 18 A, light gray	2-way	2001-402	162
End and intermediate plate, 0.8 mm thick	orange	2002-1292	163
WMB Inline, plain, 2,000 WMB markers (4 mm) per reel, 4 ... 4.2 mm stretchable	white	2009-114	780
Marking strip, plain, 11 mm wide, 50 m reel	white	2009-110	783

Accessories (jumpers, end plates, etc.), see page 162

Carrier rails and tools, see Section 13

Appropriate marking system, WMB/WMB Inline/markings strips, see Full Line Catalog, Volume 6

Approvals and corresponding ratings, visit [www.wago.com](http://www.wago.com)

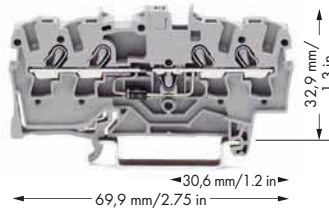
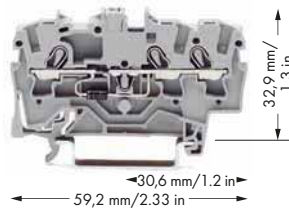

2001-1311/1000-411    2001-1311/1000-410

2001-1411/1000-411    2001-1411/1000-410

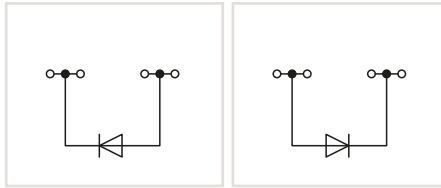
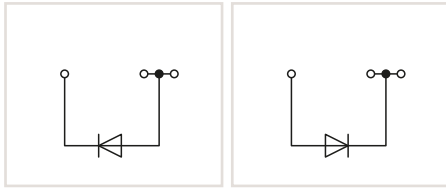

**3-conductor diode terminal block, with 1N4007 diode**

Color	Item No.	Pack. Unit
● gray	2001-1311/1000-411	100
● gray	2001-1311/1000-410	100

**4-conductor diode terminal block, with 1N4007 diode**

Color	Item No.	Pack. Unit
● gray	2001-1411/1000-411	100
● gray	2001-1411/1000-410	100

IEC/EN 60947-7-1
250 V
1000 V
0.5 A
1.5 mm <sup>2</sup>
0.25 ... 2.5 mm <sup>2</sup> / 22 ... 14 AWG
0.5 ... 2.5 mm <sup>2</sup> / 20 ... 14 AWG
0.25 ... 2.5 mm <sup>2</sup> / 22 ... 14 AWG
0.75 mm <sup>2</sup> / 18 AWG
9 ... 11 mm / 0.35 ... 0.43 inch
4.2 mm / 0.165 inch
Polyamide 66 (PA 66)

IEC/EN 60947-7-1
250 V
1000 V
0.5 A
1.5 mm <sup>2</sup>
0.25 ... 2.5 mm <sup>2</sup> / 22 ... 14 AWG
0.5 ... 2.5 mm <sup>2</sup> / 20 ... 14 AWG
0.25 ... 2.5 mm <sup>2</sup> / 22 ... 14 AWG
0.75 mm <sup>2</sup> / 18 AWG
9 ... 11 mm / 0.35 ... 0.43 inch
4.2 mm / 0.165 inch
Polyamide 66 (PA 66)

	Item No.	Page
2-way	2001-402	162
orange	2002-1392	163
white	2009-114	780
white	2009-110	783

	Item No.	Page
2-way	2001-402	162
orange	2002-1492	163
white	2009-114	780
white	2009-110	783

# TOPJOB® S

## LED Terminal Blocks

### 1.5 (2.5) mm<sup>2</sup>, 2001 Series

1

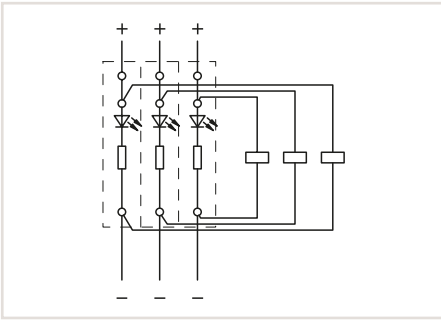

Circuit-related voltage indications can be created using the following terminal blocks:  
2001-1321/1000-434 or 2001-1321/1000-413

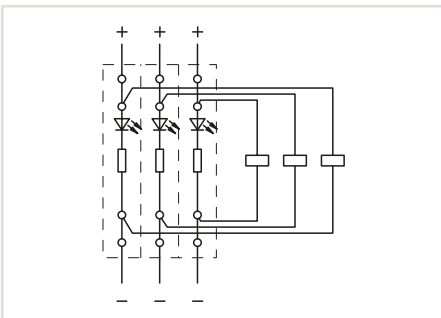

Circuit-related voltage indications can be created using the following terminal blocks:  
2001-1421/1000-434 or 2001-1421/1000-413

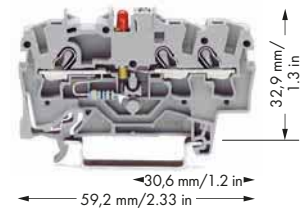

2001-1321/1000-413

2001-1321/1000-434

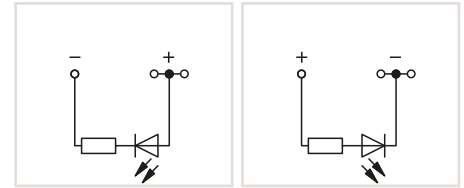

3-conductor LED terminal block, with red LED

Color	Item No.	Pack. Unit
○ gray	2001-1321/1000-413	100
○ gray	2001-1321/1000-434	100

#### Technical Data

Ratings per	IEC/EN 60947-7-1
Voltage type	DC
Nominal voltage	24 V
Rated current	0.025 A
Nominal cross section	1.5 mm <sup>2</sup>
<b>Connection Data</b>	
Solid conductor	0.25 ... 2.5 mm <sup>2</sup> / 22 ... 14 AWG
Solid conductor, push-in termination	0.5 ... 2.5 mm <sup>2</sup> / 20 ... 14 AWG
Fine-stranded conductor	0.25 ... 2.5 mm <sup>2</sup> / 22 ... 14 AWG
Fine-stranded conductor with ferrule, push-in termination, min.	0.75 mm <sup>2</sup> / 18 AWG
Strip length	9 ... 11 mm / 0.35 ... 0.43 inch
Terminal block width	4.2 mm / 0.165 inch
Insulation material	Polyamide 66 (PA 66)
<b>Note:</b>	Notice: This LED terminal block cannot be com- moned with push-in type jumper bars.

#### Accessories (Selection)

End and intermediate plate, 0.8 mm thick	
WMB Inline, plain, 2,000 WMB markers (4 mm) per reel, 4 ... 4.2 mm stretchable	
Marking strip, plain, 11 mm wide, 50 m reel	

	Item No.	Page
orange	2002-1292	166
white	2009-114	780
white	2009-110	783

Accessories (end plates, etc.),  
see page 166

Carrier rails and tools,  
see Section 13

Appropriate marking system,  
WMB/WMB Inline/markings strips,  
see Full Line Catalog, Volume 6

Approvals and corresponding ratings,  
visit [www.wago.com](http://www.wago.com)

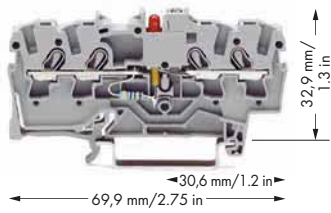

2001-1421/1000-413      2001-1421/1000-434

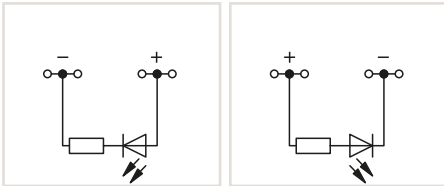

4-conductor LED terminal block, with red LED

Color	Item No.	Pack. Unit
○ gray	2001-1421/1000-413	100
○ gray	2001-1421/1000-434	100

IEC/EN 60947-7-1

DC

24 V

0.025 A

1.5 mm<sup>2</sup>

0.25 ... 2.5 mm<sup>2</sup> / 22 ... 14 AWG

0.5 ... 2.5 mm<sup>2</sup> / 20 ... 14 AWG

0.25 ... 2.5 mm<sup>2</sup> / 22 ... 14 AWG

0.75 mm<sup>2</sup> / 18 AWG

9 ... 11 mm / 0.35 ... 0.43 inch

4.2 mm / 0.165 inch

Polyamide 66 (PA 66)

Notice: This LED terminal block cannot be com-  
moned with push-in type jumper bars.

	Item No.	Page
orange	2002-1392	166
white	2009-114	780
white	2009-110	783

# TOPJOB® S

## Diode Terminal Blocks

### 2.5 (4) mm<sup>2</sup>, 2002 Series

1



These diode terminal blocks have been specially developed for custom diode circuits, such as lamp test and collective fault signal circuits.

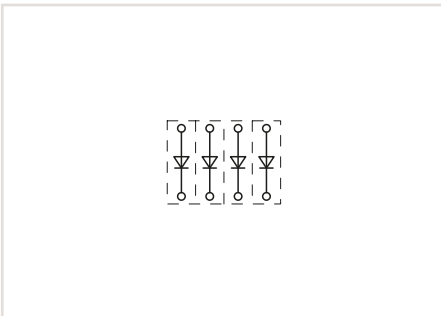

Open diode gates can be created using the following terminal blocks:

2002-1211/1000-410 or 2002-1211/1000-411

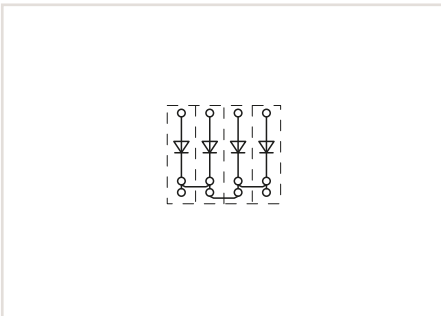

Open diode gates can be created using the following terminal blocks:

2002-1311/1000-410 or 2002-1311/1000-411

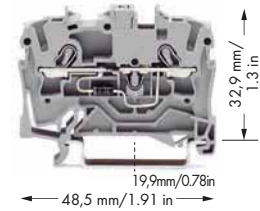

2002-1211/1000-411

2002-1211/1000-410

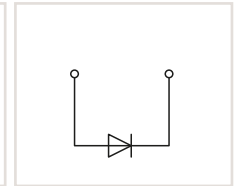
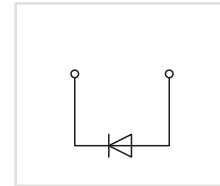

2-conductor diode terminal block, with 1N4007 diode

Color	Item No.	Pack. Unit
○ gray	2002-1211/1000-411	100
○ gray	2002-1211/1000-410	100

#### Technical Data

Ratings per	IEC/EN 60947-7-1
Nominal voltage	250 V
Reverse voltage	1000 V
Rated current	0.5 A
Nominal cross section	2.5 mm <sup>2</sup>
<b>Connection Data</b>	
Solid conductor	0.25 ... 4 mm <sup>2</sup> / 22 ... 12 AWG
Solid conductor, push-in termination	0.75 ... 4 mm <sup>2</sup> / 18 ... 12 AWG
Fine-stranded conductor	0.25 ... 4 mm <sup>2</sup> / 22 ... 12 AWG
Fine-stranded conductor with ferrule, push-in termination, min.	0.75 mm <sup>2</sup> / 18 AWG
Strip length	10 ... 12 mm / 0.39 ... 0.47 inch
Terminal block width	5.2 mm / 0.205 inch
Insulation material	Polyamide 66 (PA 66)

#### Accessories (Selection)

Push-in type jumper bar, insulated, I <sub>N</sub> 25 A, light gray	2-way	2002-402	164
End and intermediate plate, 0.8 mm thick	orange	2002-1292	166
WMB Inline, plain, 1,500 WMB markers (5 mm) per reel, 5 ... 5.2 mm stretchable	white	2009-115	780
Marking strip, plain, 11 mm wide, 50 m reel	white	2009-110	783

Accessories (jumpers, end plates, etc.), see page 164

Carrier rails and tools, see Section 13

Appropriate marking system, WMB/WMB Inline/markings strips, see Full Line Catalog, Volume 6

Approvals and corresponding ratings, visit [www.wago.com](http://www.wago.com)

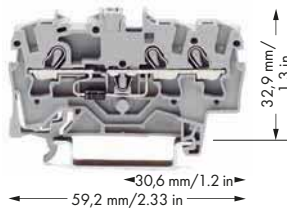

2002-1311/1000-411 2002-1311/1000-410

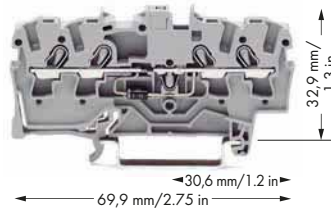

2002-1411/1000-411 2002-1411/1000-410

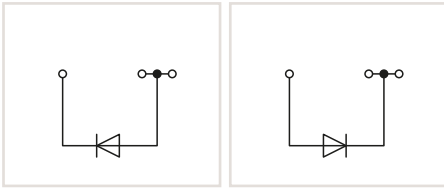

**3-conductor diode terminal block, with 1N4007 diode**

Color	Item No.	Pack. Unit
gray	2002-1311/1000-411	100
gray	2002-1311/1000-410	100

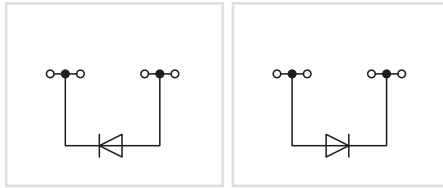

**4-conductor diode terminal block, with 1N4007 diode**

Color	Item No.	Pack. Unit
gray	2002-1411/1000-411	100
gray	2002-1411/1000-410	100

IEC/EN 60947-7-1
250 V
1000 V
0.5 A
2.5 mm <sup>2</sup>
0.25 ... 4 mm <sup>2</sup> / 22 ... 12 AWG
0.75 ... 4 mm <sup>2</sup> / 18 ... 12 AWG
0.25 ... 4 mm <sup>2</sup> / 22 ... 12 AWG
0.75 mm <sup>2</sup> / 18 AWG
10 ... 12 mm / 0.39 ... 0.47 inch
5.2 mm / 0.205 inch
Polyamide 66 (PA 66)

IEC/EN 60947-7-1
250 V
1000 V
0.5 A
2.5 mm <sup>2</sup>
0.25 ... 4 mm <sup>2</sup> / 22 ... 12 AWG
0.75 ... 4 mm <sup>2</sup> / 18 ... 12 AWG
0.25 ... 4 mm <sup>2</sup> / 22 ... 12 AWG
0.75 mm <sup>2</sup> / 18 AWG
10 ... 12 mm / 0.39 ... 0.47 inch
5.2 mm / 0.205 inch
Polyamide 66 (PA 66)

	Item No.	Page
2-way	2002-402	164
orange	2002-1392	166
white	2009-115	780
white	2009-110	783

	Item No.	Page
2-way	2002-402	164
orange	2002-1492	166
white	2009-115	780
white	2009-110	783



# TOPJOB® S

## LED Terminal Blocks

### 2.5 (4) mm<sup>2</sup>, 2002 Series

1

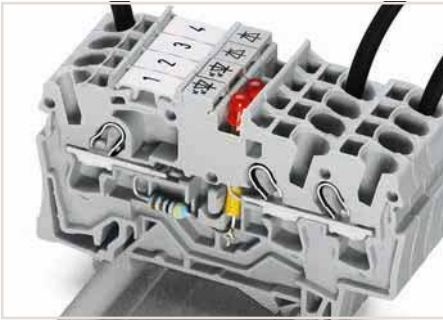

Designing monitoring units via LED terminal blocks (e.g., for control and operating circuits).

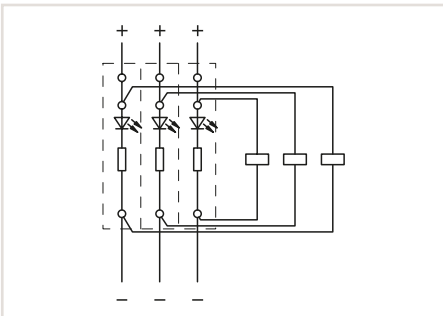

Circuit-related voltage indications can be created using the following terminal blocks:  
2002-1321/1000-434 or 2002-1321/1000-413

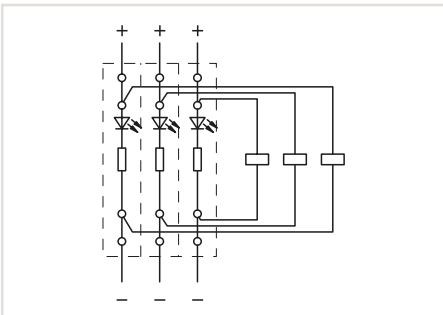

Circuit-related voltage indications can be created using the following terminal blocks:  
2002-1421/1000-434 or 2002-1421/1000-413



2002-1321/1000-413

2002-1321/1000-434

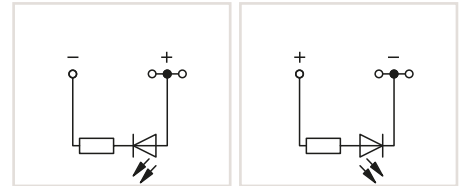

3-conductor LED terminal block, with red LED

Color	Item No.	Pack. Unit
○ gray	2002-1321/1000-413	100
○ gray	2002-1321/1000-434	100

#### Technical Data

Ratings per

Voltage type

Nominal voltage

Rated current

Nominal cross section

#### Connection Data

Solid conductor

Solid conductor, push-in termination

Fine-stranded conductor

Fine-stranded conductor with ferrule, push-in termination, min.

Strip length

Terminal block width

Insulation material

**Note:**

#### Accessories (Selection)

End and intermediate plate, 0.8 mm thick

WMB Inline, plain, 1,500 WMB markers (5 mm) per reel, 5 ... 5.2 mm stretchable

Marking strip, plain, 11 mm wide, 50 m reel

IEC/EN 60947-7-1

DC

24 V

0.025 A

2.5 mm<sup>2</sup>

0.25 ... 4 mm<sup>2</sup> / 22 ... 12 AWG

0.75 ... 4 mm<sup>2</sup> / 18 ... 12 AWG

0.25 ... 4 mm<sup>2</sup> / 22 ... 12 AWG

0.75 mm<sup>2</sup> / 18 AWG

10 ... 12 mm / 0.39 ... 0.47 inch

5.2 mm / 0.205 inch

Polyamide 66 (PA 66)

Notice: This LED terminal block cannot be com-moned with push-in type jumper bars.

	Item No.	Page
orange	2002-1292	166
white	2009-115	780
white	2009-110	783

Accessories (end plates, etc.), see page 166

Carrier rails and tools, see Section 13

Appropriate marking system, WMB/WMB Inline/marketing strips, see Full Line Catalog, Volume 6

Approvals and corresponding ratings, visit [www.wago.com](http://www.wago.com)

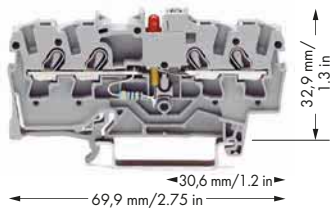

2002-1421/1000-413      2002-1421/1000-434

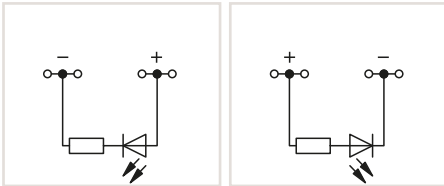

4-conductor LED terminal block, with red LED

Color	Item No.	Pack. Unit
○ gray	2002-1421/1000-413	100
○ gray	2002-1421/1000-434	100

IEC/EN 60947-7-1

DC

24 V

0.025 A

2.5 mm<sup>2</sup>

0.25 ... 4 mm<sup>2</sup> / 22 ... 12 AWG

0.75 ... 4 mm<sup>2</sup> / 18 ... 12 AWG

0.25 ... 4 mm<sup>2</sup> / 22 ... 12 AWG

0.75 mm<sup>2</sup> / 18 AWG

10 ... 12 mm / 0.39 ... 0.47 inch

5.2 mm / 0.205 inch

Polyamide 66 (PA 66)

Notice: This LED terminal block cannot be com-  
moned with push-in type jumper bars.

	Item No.	Page
orange	2002-1392	166
white	2009-115	780
white	2009-110	783

# TOPJOB® S

## Diode Terminal Blocks

### 4 (6) mm<sup>2</sup>, 2004 Series

1

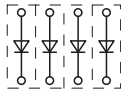

Open diode gates can be created using the following terminal blocks:  
2004-1211/1000-400 or 2004-1211/1000-401

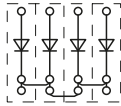

Open diode gates can be created using the following terminal blocks:  
2004-1311/1000-400 or 2004-1311/1000-401

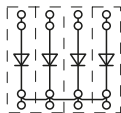

Open diode gates can be created using the following terminal blocks:  
2004-1411/1000-400 or 2004-1411/1000-401

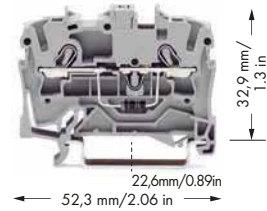

2004-1211/1000-401      2004-1211/1000-400

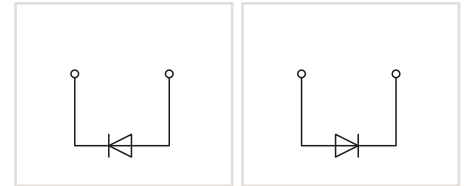

2-conductor diode terminal block, with 1N5408 diode

Color	Item No.	Pack. Unit
○ gray	2004-1211/1000-401	100
○ gray	2004-1211/1000-400	100

#### Technical Data

Ratings per	IEC/EN 60947-7-1
Nominal voltage	250 V
Reverse voltage	1000 V
Rated current	1.5 A
Nominal cross section	4 mm <sup>2</sup>
<b>Connection Data</b>	
Solid conductor	0.5 ... 6 mm <sup>2</sup> / 20 ... 10 AWG
Solid conductor, push-in termination	1 ... 6 mm <sup>2</sup> / 14 ... 10 AWG
Fine-stranded conductor	0.5 ... 6 mm <sup>2</sup> / 20 ... 10 AWG
Fine-stranded conductor with ferrule, push-in termination, min.	0.75 mm <sup>2</sup> / 18 AWG
Strip length	11 ... 13 mm / 0.43 ... 0.51 inch
Terminal block width	6.2 mm / 0.244 inch
Insulation material	Polyamide 66 (PA 66)

#### Accessories (Selection)

Push-in type jumper bar, insulated, I <sub>N</sub> 32 A, light gray	2-way	2004-402	169
End and intermediate plate, 1 mm thick	orange	2004-1292	169
WMB Multi marking system, white, 10 strips with 10 markers per card, 5 ... 5.2 mm stretchable	plain	793-5501	780
Marking strip, plain, 11 mm wide, 50 m reel	white	2009-110	783

	Item No.	Page
2-way	2004-402	169
orange	2004-1292	169
plain	793-5501	780
white	2009-110	783

Accessories (jumpers, end plates, etc.), see page 169

Carrier rails and tools, see Section 13

Appropriate marking system, WMB/WMB Inline/markings strips, see Full Line Catalog, Volume 6

Approvals and corresponding ratings, visit [www.wago.com](http://www.wago.com)

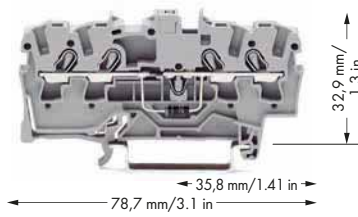
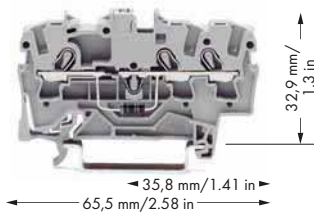

2004-1311/1000-401    2004-1311/1000-400

2004-1411/1000-401    2004-1411/1000-400

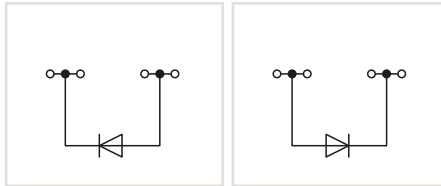
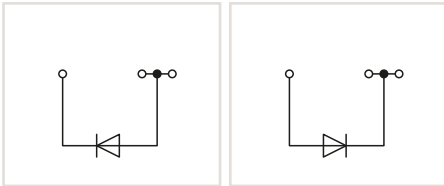

**3-conductor diode terminal block, with 1N5408 diode**

Color	Item No.	Pack. Unit
● gray	2004-1311/1000-401	100
● gray	2004-1311/1000-400	100

**4-conductor diode terminal block, with 1N5408 diode**

Color	Item No.	Pack. Unit
● gray	2004-1411/1000-401	100
● gray	2004-1411/1000-400	100

IEC/EN 60947-7-1
250 V
1000 V
1.5 A
4 mm <sup>2</sup>
0.5 ... 6 mm <sup>2</sup> / 20 ... 10 AWG
1 ... 6 mm <sup>2</sup> / 14 ... 10 AWG
0.5 ... 6 mm <sup>2</sup> / 20 ... 10 AWG
0.75 mm <sup>2</sup> / 18 AWG
11 ... 13 mm / 0.43 ... 0.51 inch
6.2 mm / 0.244 inch
Polyamide 66 (PA 66)

IEC/EN 60947-7-1
250 V
1000 V
1.5 A
4 mm <sup>2</sup>
0.5 ... 6 mm <sup>2</sup> / 20 ... 10 AWG
1 ... 6 mm <sup>2</sup> / 14 ... 10 AWG
0.5 ... 6 mm <sup>2</sup> / 20 ... 10 AWG
0.75 mm <sup>2</sup> / 18 AWG
11 ... 13 mm / 0.43 ... 0.51 inch
6.2 mm / 0.244 inch
Polyamide 66 (PA 66)

	Item No.	Page
2-way	2004-402	169
orange	2004-1392	169
plain	793-5501	780
white	2009-110	783

	Item No.	Page
2-way	2004-402	169
orange	2004-1492	170
plain	793-5501	780
white	2009-110	783

# TOPJOB® S

## Double-Deck Diode Terminal Blocks

### 2.5 (4) mm<sup>2</sup>, 2002 Series

1



Double-deck diode terminal blocks were specifically developed for custom diode circuits, such as lamp test and collective fault signal circuits. These terminal blocks provide high-density wiring in a width of just 5.2 mm. Push-in type jumper bars provide additional options for custom circuit design.

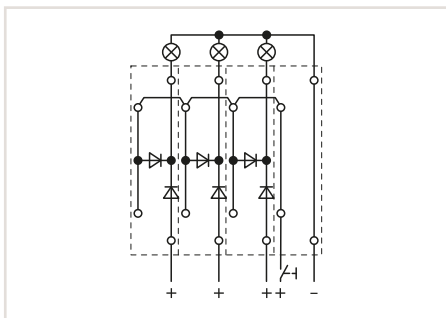

Lamp test circuits can be created using the following terminal blocks:  
2002-2214/1000-492 or 2002-2214/1000-491

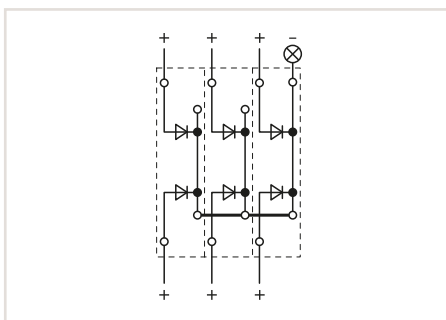

Collective fault signals can be created using the following terminal blocks:  
2002-2214/1000-489 or 2002-2214/1000-490

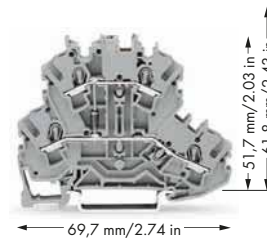

2002-2211/1000-410      2002-2211/1000-411

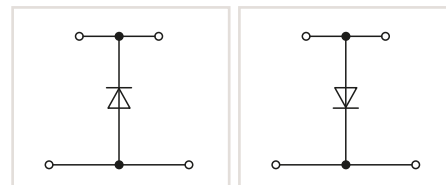

Double-deck diode terminal block, with 1N4007 diode

Color	Item No.	Pack. Unit
● gray	2002-2211/1000-410	50
● gray	2002-2211/1000-411	50

#### Technical Data

Ratings per	IEC/EN 60947-7-1
Nominal voltage	250 V
Reverse voltage	1000 V
Rated current	0.5 A
Nominal cross section	2.5 mm <sup>2</sup>

#### Connection Data

Solid conductor	0.25 ... 4 mm <sup>2</sup> / 22 ... 12 AWG
Solid conductor, push-in termination	0.75 ... 4 mm <sup>2</sup> / 18 ... 12 AWG
Fine-stranded conductor	0.25 ... 4 mm <sup>2</sup> / 22 ... 12 AWG
Fine-stranded conductor with ferrule, push-in termination, min.	0.75 mm <sup>2</sup> / 18 AWG
Strip length	10 ... 12 mm / 0.39 ... 0.47 inch
Terminal block width	5.2 mm / 0.205 inch
Insulation material	Polyamide 66 (PA 66)

#### Accessories (Selection)

	Item No.	Page
Push-in type jumper bar, insulated, I <sub>N</sub> 25 A, light gray	2002-402	164
End and intermediate plate, 0.8 mm thick	orange 2002-2292	166
WMB Inline, plain, 1,500 WMB markers (5 mm) per reel, 5 ... 5.2 mm stretchable	white 2009-115	780
Marking strip, plain, 11 mm wide, 50 m reel	white 2009-110	783

Accessories (jumpers, end plates, etc.), see page 164

Carrier rails and tools, see Section 13

Appropriate marking system, WMB/WMB Inline/markings strips, see Full Line Catalog, Volume 6

Approvals and corresponding ratings, visit [www.wago.com](http://www.wago.com)

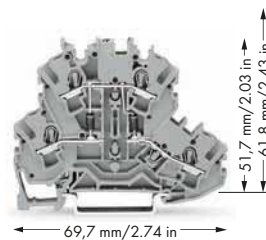
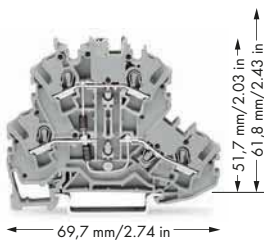
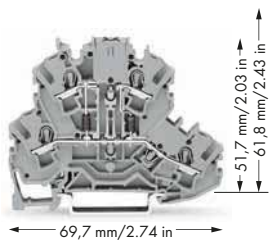

2002-2213/1000-487    2002-2213/1000-488

2002-2214/1000-492    2002-2214/1000-491

2002-2214/1000-489    2002-2214/1000-490

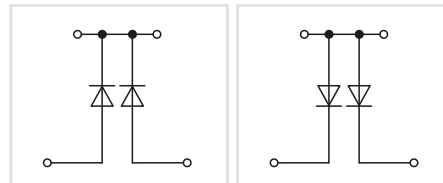
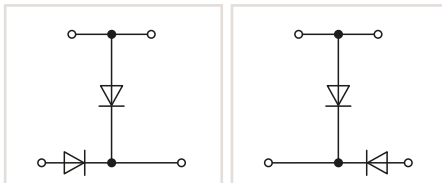
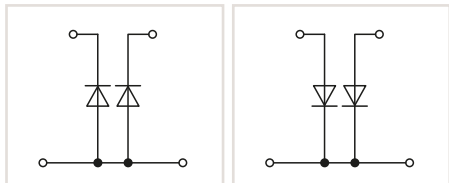

Double-deck diode terminal block, with two 1N4007 diodes

Color	Item No.	Pack. Unit
gray	2002-2213/1000-487	50
gray	2002-2213/1000-488	50

Double-deck diode terminal block, with two 1N4007 diodes

Color	Item No.	Pack. Unit
gray	2002-2214/1000-492	50
gray	2002-2214/1000-491	50

Double-deck diode terminal block, with two 1N4007 diodes

Color	Item No.	Pack. Unit
gray	2002-2214/1000-489	50
gray	2002-2214/1000-489	50

IEC/EN 60947-7-1
250 V
1000 V
0.5 A
2.5 mm <sup>2</sup>

IEC/EN 60947-7-1
250 V
1000 V
0.5 A
2.5 mm <sup>2</sup>

IEC/EN 60947-7-1
250 V
1000 V
0.5 A
2.5 mm <sup>2</sup>

0.25 ... 4 mm <sup>2</sup> / 22 ... 12 AWG
0.75 ... 4 mm <sup>2</sup> / 18 ... 12 AWG
0.25 ... 4 mm <sup>2</sup> / 22 ... 12 AWG
0.75 mm <sup>2</sup> / 18 AWG

0.25 ... 4 mm <sup>2</sup> / 22 ... 12 AWG
0.75 ... 4 mm <sup>2</sup> / 18 ... 12 AWG
0.25 ... 4 mm <sup>2</sup> / 22 ... 12 AWG
0.75 mm <sup>2</sup> / 18 AWG

0.25 ... 4 mm <sup>2</sup> / 22 ... 12 AWG
0.75 ... 4 mm <sup>2</sup> / 18 ... 12 AWG
0.25 ... 4 mm <sup>2</sup> / 22 ... 12 AWG
0.75 mm <sup>2</sup> / 18 AWG

10 ... 12 mm / 0.39 ... 0.47 inch
5.2 mm / 0.205 inch
Polyamide 66 (PA 66)

10 ... 12 mm / 0.39 ... 0.47 inch
5.2 mm / 0.205 inch
Polyamide 66 (PA 66)

10 ... 12 mm / 0.39 ... 0.47 inch
5.2 mm / 0.205 inch
Polyamide 66 (PA 66)

	Item No.	Page
2-way	2002-402	164
orange	2002-2292	166
white	2009-115	780
white	2009-110	783

	Item No.	Page
2-way	2002-402	164
orange	2002-2292	166
white	2009-115	780
white	2009-110	783

	Item No.	Page
2-way	2002-402	164
orange	2002-2292	166
white	2009-115	780
white	2009-110	783



## TOPJOB® S

### Triple-Deck Diode Terminal Blocks

#### 2.5 (4) mm<sup>2</sup>, 2002 Series

1

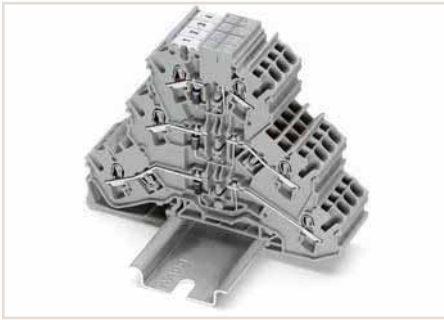

Triple-deck diode terminal blocks were specifically developed for custom diode circuits, such as lamp test and collective fault signal circuits. These terminal blocks provide high-density wiring in a width of just 5.2 mm. Push-in type jumper bars provide additional options for custom circuit design.

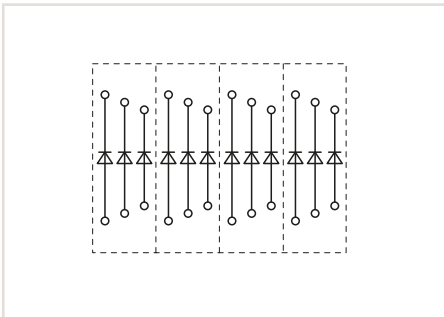

Open diode gates can be created and connected individually using the following terminal blocks: 2002-3212/1000-673 or 2002-3212/1000-674

Using push-in type jumper bars, individual levels can be turned into polarized diode gates.

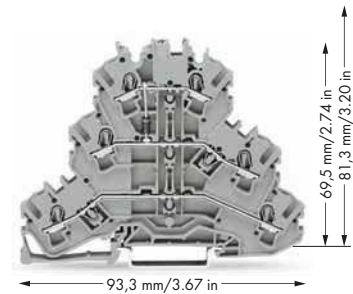

2002-3211/1000-410

2002-3211/1000-411

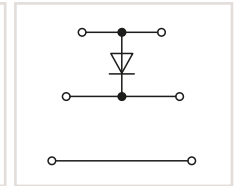
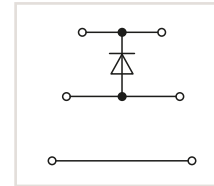

Triple-deck diode terminal block, with 1N4007 diode

Color	Item No.	Pack. Unit
○ gray	2002-3211/1000-410	50
○ gray	2002-3211/1000-411	50

#### Technical Data

Ratings per	IEC/EN 60947-7-1
Nominal voltage	250 V
Reverse voltage	1000 V
Rated current	0.5 A
Nominal cross section	2.5 mm <sup>2</sup>

#### Connection Data

Solid conductor	0.25 ... 4 mm <sup>2</sup> / 22 ... 12 AWG
Solid conductor, push-in termination	0.75 ... 4 mm <sup>2</sup> / 18 ... 12 AWG
Fine-stranded conductor	0.25 ... 4 mm <sup>2</sup> / 22 ... 12 AWG
Fine-stranded conductor with ferrule, push-in termination, min.	0.75 mm <sup>2</sup> / 18 AWG
Strip length	10 ... 12 mm / 0.39 ... 0.47 inch
Terminal block width	5.2 mm / 0.205 inch
Insulation material	Polyamide 66 (PA 66)

#### Accessories (Selection)

Push-in type jumper bar, insulated, I <sub>N</sub> 25 A, light gray	2-way	2002-402	164
End and intermediate plate, 0.8 mm thick	orange	2002-3292	167
WMB Inline, plain, 1,500 WMB markers (5 mm) per reel, 5 ... 5.2 mm stretchable	white	2009-115	780
Marking strip, plain, 11 mm wide, 50 m reel	white	2009-110	783

Accessories (jumpers, end plates, etc.), see page 164

Carrier rails and tools, see Section 13

Appropriate marking system, WMB/WMB Inline/markings strips, see Full Line Catalog, Volume 6

Approvals and corresponding ratings, visit [www.wago.com](http://www.wago.com)

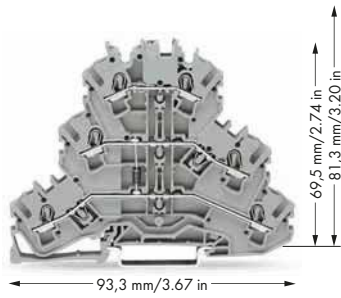

2002-3211/1000-675

2002-3211/1000-676

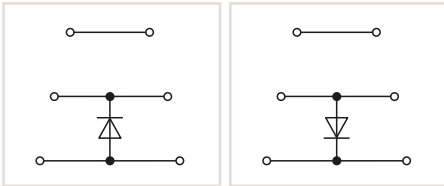

Triple-deck diode terminal block, with 1N4007 diode

Color	Item No.	Pack. Unit
gray	2002-3211/1000-675	50
gray	2002-3211/1000-676	50

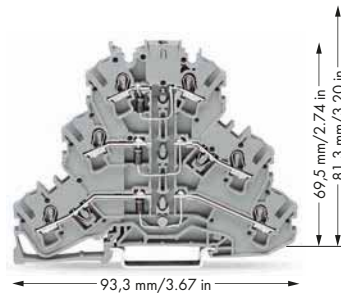

2002-3212/1000-673

2002-3212/1000-674

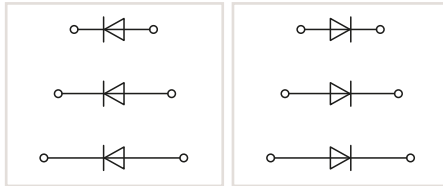

Triple-deck diode terminal block, with three 1N4007 diodes

Color	Item No.	Pack. Unit
gray	2002-3212/1000-673	50
gray	2002-3212/1000-674	50

IEC/EN 60947-7-1

250 V

1000 V

0.5 A

2.5 mm<sup>2</sup>

0.25 ... 4 mm<sup>2</sup> / 22 ... 12 AWG

0.75 ... 4 mm<sup>2</sup> / 18 ... 12 AWG

0.25 ... 4 mm<sup>2</sup> / 22 ... 12 AWG

0.75 mm<sup>2</sup> / 18 AWG

10 ... 12 mm / 0.39 ... 0.47 inch

5.2 mm / 0.205 inch

Polyamide 66 (PA 66)

	Item No.	Page
2-way	2002-402	164
orange	2002-3292	167
white	2009-115	780
white	2009-110	783

IEC/EN 60947-7-1

250 V

1000 V

0.5 A

2.5 mm<sup>2</sup>

0.25 ... 4 mm<sup>2</sup> / 22 ... 12 AWG

0.75 ... 4 mm<sup>2</sup> / 18 ... 12 AWG

0.25 ... 4 mm<sup>2</sup> / 22 ... 12 AWG

0.75 mm<sup>2</sup> / 18 AWG

10 ... 12 mm / 0.39 ... 0.47 inch

5.2 mm / 0.205 inch

Polyamide 66 (PA 66)

	Item No.	Page
2-way	2002-402	164
orange	2002-3292	167
white	2009-115	780
white	2009-110	783

## TOPJOB® S

### Double- and Triple-Deck LED Terminal Blocks

#### 2.5 (4) mm<sup>2</sup>, 2002 Series

1



Double- and triple-deck LED terminal blocks  
Designing monitoring units via LED terminal blocks  
(e.g., for control and operating circuits).

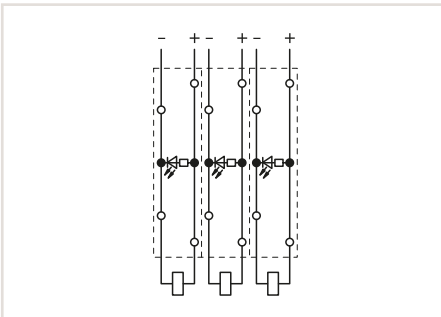

Circuit-related voltage indications can be created  
using the following terminal blocks:  
2002-2221/1000-434 or 2002-2221/1000-413

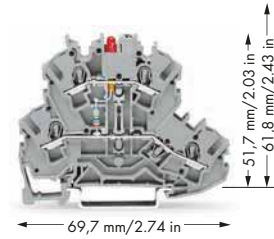

2002-2221/1000-434      2002-2221/1000-413

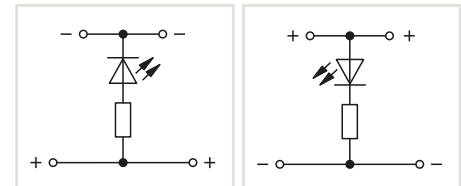

Triple-deck LED terminal block, with red LED

Color	Item No.	Pack. Unit
○ gray	2002-2221/1000-434	50
○ gray	2002-2221/1000-413	50

#### Technical Data

Ratings per	IEC/EN 60947-7-1
Voltage type	DC
Nominal voltage	24 V
Rated current	0.025 A
Nominal cross section	2.5 mm <sup>2</sup>

#### Connection Data

Solid conductor	0.25 ... 4 mm <sup>2</sup> / 22 ... 12 AWG
Solid conductor, push-in termination	0.75 ... 4 mm <sup>2</sup> / 18 ... 12 AWG
Fine-stranded conductor	0.25 ... 4 mm <sup>2</sup> / 22 ... 12 AWG
Fine-stranded conductor with ferrule, push-in termination, min.	0.75 mm <sup>2</sup> / 18 AWG
Strip length	10 ... 12 mm / 0.39 ... 0.47 inch
Terminal block width	5.2 mm / 0.205 inch
Insulation material	Polyamide 66 (PA 66)

#### Accessories (Selection)

Push-in type jumper bar, insulated, I <sub>n</sub> 25 A, light gray
End and intermediate plate, 0.8 mm thick
WMB Inline, plain, 1,500 WMB markers (5 mm) per reel, 5 ... 5.2 mm stretchable
Marking strip, plain, 11 mm wide, 50 m reel

	Item No.	Page
2-way	2002-402	164
orange	2002-2292	166
white	2009-115	780
white	2009-110	783

Accessories (jumpers, end plates, etc.),  
see page 164

Carrier rails and tools,  
see Section 13

Appropriate marking system,  
WMB/WMB Inline/marketing strips,  
see Full Line Catalog, Volume 6

Approvals and corresponding ratings,  
visit [www.wago.com](http://www.wago.com)

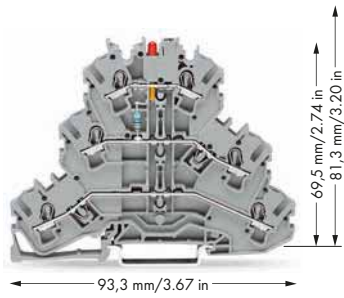

2002-3221/1000-434

2002-3221/1000-413

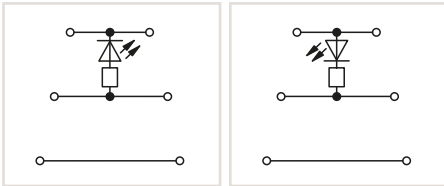

Triple-deck LED terminal block, with red LED

Color	Item No.	Pack. Unit
○ gray	2002-3221/1000-434	50
○ gray	2002-3221/1000-413	50

IEC/EN 60947-7-1

DC

24 V

0.025 A

2.5 mm<sup>2</sup>

0.25 ... 4 mm<sup>2</sup> / 22 ... 12 AWG

0.75 ... 4 mm<sup>2</sup> / 18 ... 12 AWG

0.25 ... 4 mm<sup>2</sup> / 22 ... 12 AWG

0.75 mm<sup>2</sup> / 18 AWG

10 ... 12 mm / 0.39 ... 0.47 inch

5.2 mm / 0.205 inch

Polyamide 66 (PA 66)

	Item No.	Page
2-way	2002-402	164
orange	2002-3292	167
white	2009-115	780
white	2009-110	783

## TOPJOB® S

Pluggable Diode Modules on Carrier Terminal Blocks, 2.5 (4) mm<sup>2</sup>  
2002 Series

1

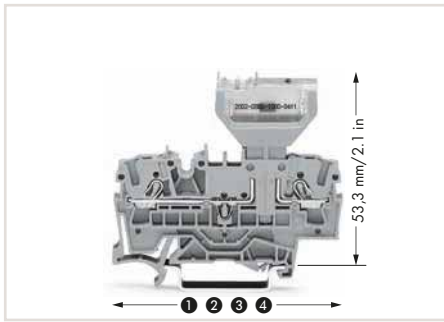

Dimensions of carrier terminal blocks with a pluggable diode module:

- ① 66.1 mm / 2.62 inch for 2002-1661
- ② 76.8 mm / 3.02 inch for 2002-1761
- ③ 87.5 mm / 3.45 inch for 2002-1861
- ④ 72.9 mm / 2.87 inch for 2002-1961

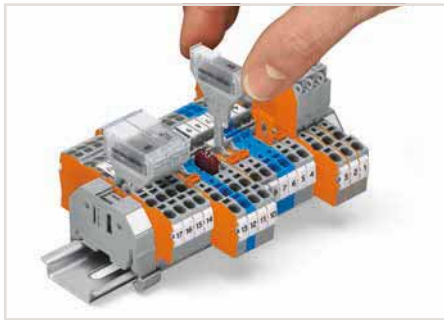

These diode modules are ideal for custom diode circuits (e.g., lamp test and collective fault signal circuits) and offer the following advantages:

- Separation into functional and wiring levels
- Polarized switching direction
- Quick and easy exchange of modules
- Terminal blocks/modules provide high-density wiring in a width of just 5.2 mm

#### Technical Data

Nominal voltage	250 V
Reverse voltage	1000 V
Rated current	1 A
Plug width	5.2 mm / 0.205 inch
Insulation material	Polyamide 66 (PA 66)

#### Accessories (Selection)

2-conductor carrier terminal block, 0.25 ... 4 mm <sup>2</sup> (22 ... 12 AWG), 5.2 mm (0.205 inch) wide	gray	2002-1661	83
3-conductor carrier terminal block, 0.25 ... 4 mm <sup>2</sup> (22 ... 12 AWG), 5.2 mm (0.205 inch) wide	gray	2002-1761	85
4-conductor carrier terminal block, 0.25 ... 4 mm <sup>2</sup> (22 ... 12 AWG), 5.2 mm (0.205 inch) wide	gray	2002-1861	87
2-conductor carrier terminal block, 0.25 ... 4 mm <sup>2</sup> (22 ... 12 AWG), 5.2 mm (0.205 inch) wide	gray	2002-1961	93
Double-deck carrier terminal block, 0.25 ... 4 mm <sup>2</sup> (22 ... 12 AWG), 5.2 mm (0.205 inch) wide	L/L	2002-2961	81
Double-deck carrier terminal block, 0.25 ... 4 mm <sup>2</sup> (22 ... 12 AWG), 5.2 mm (0.205 inch) wide	L/N	2002-2963	81



2002-800/1000-411

2002-800/1000-410

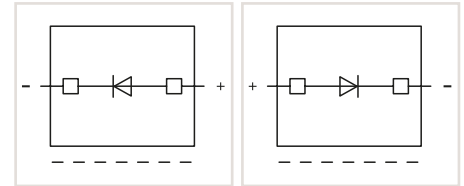

Diode module, with 1N4007 diode, max. operating temperature: 85 °C, 5.2 mm wide

Color	Item No.	Pack. Unit
● gray	2002-800/1000-411	100
● gray	2002-800/1000-410	100

Accessories (end plates, etc.), see page 167

Carrier rails and tools, see Section 13

Appropriate marking system, WMB/markings strips, see Full Line Catalog, Volume 6

Approvals and corresponding ratings, visit [www.wago.com](http://www.wago.com)

## TOPJOB® S – Pluggable Diode Modules and Empty Component Plug Housings on Through Terminal Blocks, 2.5 (4) mm<sup>2</sup> 2002 Series



Dimensions of through terminal blocks with a pluggable diode module:

- ① 48.5 mm / 1.91 inch for 2002-1201
- ② 59.2 mm / 2.33 inch for 2002-1301
- ③ 69.9 mm / 2.75 inch for 2002-1401

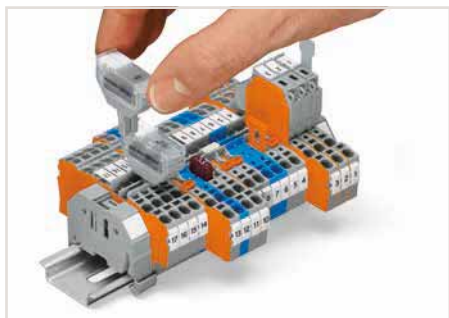

Similar to push-in type jumpers, these diode modules are simply pushed into the current bar's contact slots of two adjacent through terminal blocks, providing the following advantages:

- Compatible with all 2001 to 2006 Series Through Terminal Blocks equipped with jumper slots (note the module's width)
  - Easily retrofit existing systems
- Additional advantages:
- Separation into functional and wiring levels
  - Fast replacement of other functional units
  - Solder-free assembly of diodes, resistors, etc.

### Technical Data

Nominal voltage
Reverse voltage
Rated current
Plug width
Insulation material

2002-880/1000-411

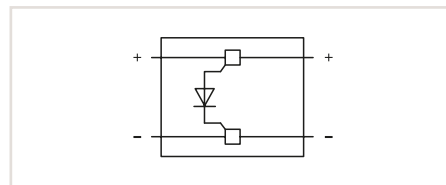

Diode module, with 1N4007 diode, max. operating temperature: 85 °C, 5.2 mm wide

Color	Item No.	Pack. Unit
● gray	2002-880/1000-411	50

Empty component plug housing, type 4, 2-pole

Color	Item No.	Pack. Unit
● gray	2002-880	50

250 V
1000 V
1 A
10.4 mm / 0.409 inch
Polyamide 66 (PA 66)

### Accessories (Selection)

2-conductor through terminal block, 0.25 ... 4 mm <sup>2</sup> (22 ... 12 AWG), 5.2 mm (0.205 inch) wide	gray	2002-1201	42
3-conductor through terminal block, 0.25 ... 4 mm <sup>2</sup> (22 ... 12 AWG), 5.2 mm (0.205 inch) wide	gray	2002-1301	43
4-conductor through terminal block, 0.25 ... 4 mm <sup>2</sup> (22 ... 12 AWG), 5.2 mm (0.205 inch) wide	gray	2002-1401	43

Accessories (end plates, etc.), see page 166

Carrier rails and tools, see Section 13

Appropriate marking system, WMB/markings strips, see Full Line Catalog, Volume 6

Approvals and corresponding ratings, visit [www.wago.com](http://www.wago.com)



## TOPJOB® S

### Pluggable LED Modules on Carrier Terminal Blocks, 2.5 (4) mm<sup>2</sup>

#### 2002 Series

1

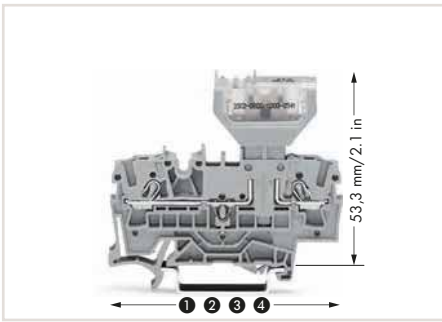

Dimensions of carrier terminal blocks with a pluggable LED module:

- ① 66.1 mm / 2.6 inch for 2002-1661
- ② 76.8 mm / 3.02 inch for 2002-1761
- ③ 87.5 mm / 3.44 inch for 2002-1861
- ④ 72.9 mm / 2.87 inch for 2002-1961

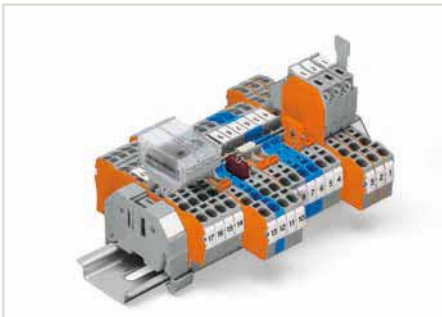

The monitoring of control and operating current circuits with LED modules on rail-mount terminal blocks provides several advantages:

- No additional cost for assembly and wiring
- Separation into functional and wiring levels
- Fast and easy replacement of other functional units

Additional advantages:

- Polarized switching direction
- Terminal blocks/modules provide high-density wiring in a width of just 5.2 mm

 $I_N \leq 3 \text{ mA}$ 

2002-800/1000-541

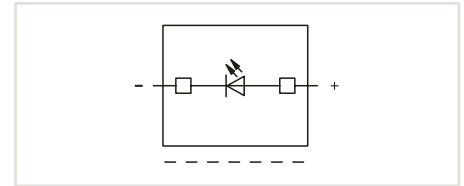

LED module, with red LED, operating temperature: 85 °C, gray

	Item No.	Pack. Unit
○ 12 ... 30 V	2002-800/1000-541	100
○ 30 ... 65 V	2002-800/1000-542	100
○ 230 V	2002-800/1000-836	100

#### Technical Data

Rated current

0.003 A

Plug width

5.2 mm / 0.205 inch

#### Accessories (Selection)

2-conductor carrier terminal block, 0.25 ... 4 mm<sup>2</sup> (22 ... 12 AWG), 5.2 mm (0.205 inch) wide

3-conductor carrier terminal block, 0.25 ... 4 mm<sup>2</sup> (22 ... 12 AWG), 5.2 mm (0.205 inch) wide

4-conductor carrier terminal block, 0.25 ... 4 mm<sup>2</sup> (22 ... 12 AWG), 5.2 mm (0.205 inch) wide

2-conductor carrier terminal block, 0.25 ... 4 mm<sup>2</sup> (22 ... 12 AWG), 5.2 mm (0.205 inch) wide

Double-deck carrier terminal block, 0.25 ... 4 mm<sup>2</sup> (22 ... 12 AWG), 5.2 mm (0.205 inch) wide

Double-deck carrier terminal block, 0.25 ... 4 mm<sup>2</sup> (22 ... 12 AWG), 5.2 mm (0.205 inch) wide

	Item No.	Page
gray	2002-1661	83
gray	2002-1761	85
gray	2002-1861	87
gray	2002-1961	93
L/L	2002-2961	81
L/N	2002-2963	81

Accessories (end plates, etc.), see page 167

Carrier rails and tools, see Section 13

Appropriate marking system, WMB/markings strips, see Full Line Catalog, Volume 6

Approvals and corresponding ratings, visit [www.wago.com](http://www.wago.com)

# TOPJOB® S

## Pluggable LED Modules on Through Terminal Blocks, 2.5 (4) mm<sup>2</sup>

### 2002 Series

1



$I_N \leq 3 \text{ mA}$

Dimensions of through terminal blocks with a pluggable LED module:

- ① 48.5 mm / 1.91 inch for 2002-1201
- ② 59.2 mm / 2.33 inch for 2002-1301
- ③ 69.9 mm / 2.75 inch for 2002-1401



Labelling via WMB Multi markers and marking strips.



Testing can also be performed via 2-pole test plugs.



2002-880/1000-541

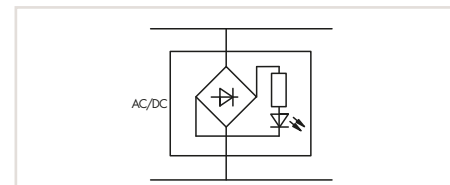

LED module, with red LED, operating temperature: 85 °C, gray

	Item No.	Pack. Unit
○ 12 ... 30 V	2002-880/1000-541	50
○ 30 ... 65 V	2002-880/1000-542	50
○ 230 V	2002-880/1000-836	50

#### Technical Data

Rated current	0.003 A
Plug width	10.4 mm / 0.409 inch

#### Accessories (Selection)

	Item No.	Page
2-conductor through terminal block, 0.25 ... 4 mm <sup>2</sup> (22 ... 12 AWG), 5.2 mm (0.205 inch) wide	2002-1201	42
3-conductor through terminal block, 0.25 ... 4 mm <sup>2</sup> (22 ... 12 AWG), 5.2 mm (0.205 inch) wide	2002-1301	43
4-conductor through terminal block, 0.25 ... 4 mm <sup>2</sup> (22 ... 12 AWG), 5.2 mm (0.205 inch) wide	2002-1401	43

Accessories (end plates, etc.), see page 167

Carrier rails and tools, see Section 13

Appropriate marking system, WMB/markings strips, see Full Line Catalog, Volume 6

Approvals and corresponding ratings, visit [www.wago.com](http://www.wago.com)

## TOPJOB® S

Empty Component Plug Housings on Carrier Terminal Blocks, 2.5 (4) mm<sup>2</sup>  
2002 Series

1



Empty component plug housing, type 1, 2-pole

Color	Item No.	Pack. Unit
○ gray	2002-800	100

## Technical Data

Plug width

5.2 mm / 0.205 inch

## Accessories (Selection)

2-conductor carrier terminal block, 0.25 ... 4 mm<sup>2</sup>  
(22 ... 12 AWG), 5.2 mm (0.205 inch) wide

gray

Item No.

2002-1661

Page

83

3-conductor carrier terminal block, 0.25 ... 4 mm<sup>2</sup>  
(22 ... 12 AWG), 5.2 mm (0.205 inch) wide

gray

2002-1761

85

4-conductor carrier terminal block, 0.25 ... 4 mm<sup>2</sup>  
(22 ... 12 AWG), 5.2 mm (0.205 inch) wide

gray

2002-1861

87

2-conductor carrier terminal block, 0.25 ... 4 mm<sup>2</sup>  
(22 ... 12 AWG), 5.2 mm (0.205 inch) wide

gray

2002-1961

93

Double-deck carrier terminal block, 0.25 ... 4 mm<sup>2</sup>  
(22 ... 12 AWG), 5.2 mm (0.205 inch) wide

L/L

2002-2961

81

Double-deck carrier terminal block, 0.25 ... 4 mm<sup>2</sup>  
(22 ... 12 AWG), 5.2 mm (0.205 inch) wide

L/N

2002-2963

81

 Accessories (end plates, etc.),  
see page 167

 Carrier rails and tools,  
see Section 13

 Appropriate marking system,  
WMB/markings strips,  
see Full Line Catalog, Volume 6

 Approvals and corresponding ratings,  
visit [www.wago.com](http://www.wago.com)

**Empty component plug housing, type 2, 2-pole**

Color	Item No.	Pack. Unit
○ gray	2002-810	50

**Empty component plug housing, type 3, 4-pole**

Color	Item No.	Pack. Unit
○ gray	2002-820	50

10.4 mm / 0.409 inch

	Item No.	Page
gray	2002-1661	83
gray	2002-1761	85
gray	2002-1861	97
gray	2002-1961	93
L/L	2002-2961	81
L/N	2002-2963	81

# Technical Information

1



Cutting component to the proper length.



Pressing component into plug contact via operating tool.

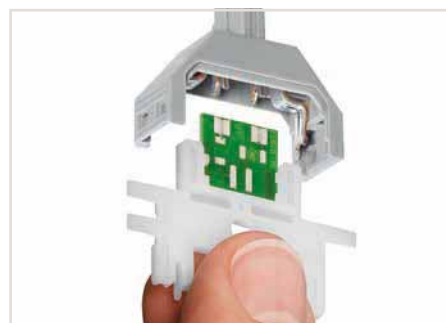

Pushing PCB into plug contact via operating tool.

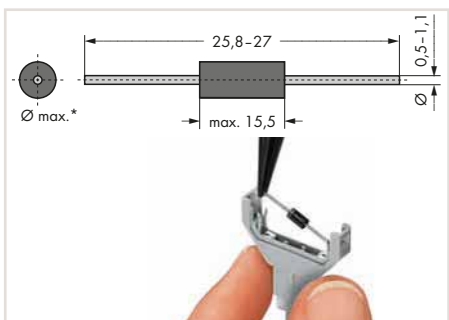

\*max. 3.4 mm Ø at 5.2 mm module width and \*max. 5.4 mm Ø at 10.4 mm module width  
**Notice:** Reconnection only possible with similar or larger wire diameter.  
 Solder-free assembly of diodes, resistors, etc.  
 Illustration shows a 1N4007 diode.



Component plugs for building custom circuits – solder-free assembly of diodes, resistors, etc.  
 Illustration shows a 1N4007 diode.

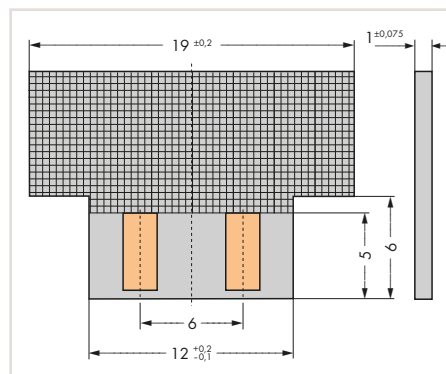

Dimensions of self-assembled PCBs:  
 Module height: 2 mm at 5.2 mm module width  
 Module height: 3.3 mm at 10.4 mm module width



When closing the cover, please insert cover as shown in the illustration.



Opening the cover via operating tool (2.5 mm blade).



Opening the cover via multi-purpose operating tool for component plugs.

# Circuit Configuration Examples

## Diode and LED Modules Installation

1

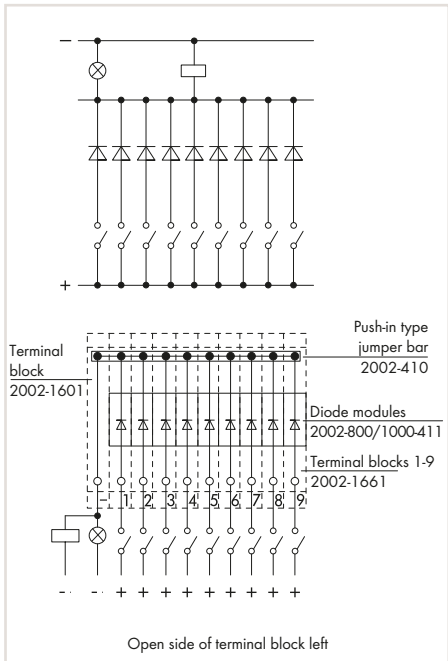

Diode module (2002-800/1000-411)  
Diode gate for collective fault indication

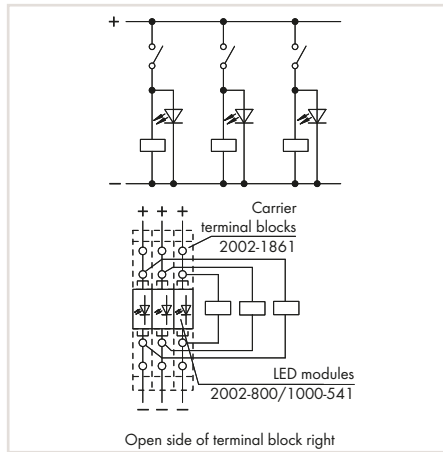

LED module (2002-800/1000-541)  
Voltage control refers to current circuits.

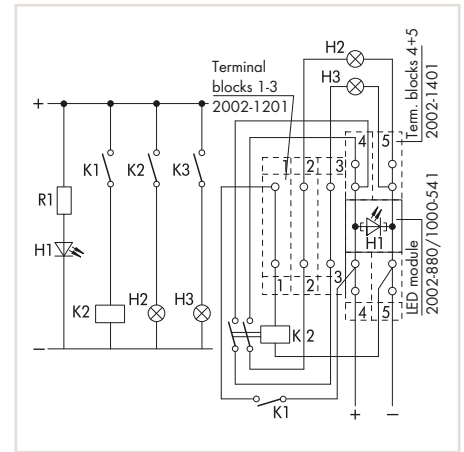

LED module (2002-880/1000-541)  
Control unit

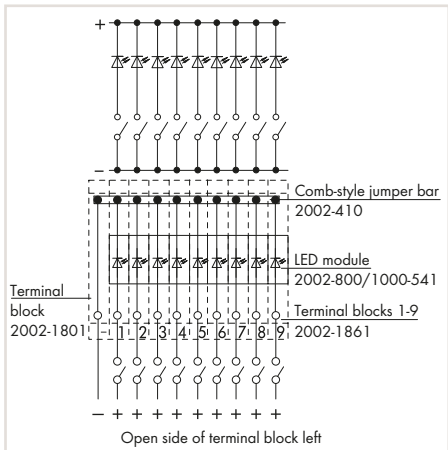

LED module (2002-800/1000-541)  
Potential indication via indicator lamp

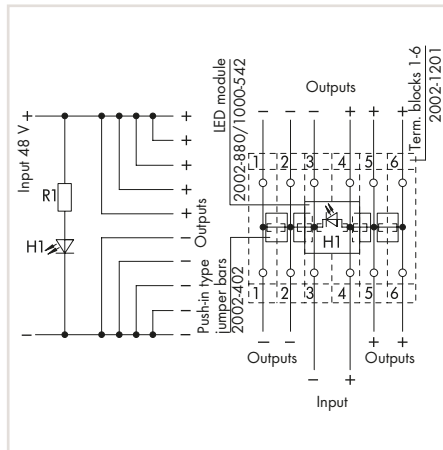

LED module (2002-880/1000-541)  
Multiple outputs with indicator lamp



## TOPJOB® S

## Modular Connectors, Connector Strips and L-Type Test Plug Modules

1 (1.5) mm<sup>2</sup>, 2000 Series and 1.5 (2.5) mm<sup>2</sup>, 2001 Series and 2.5 (4) mm<sup>2</sup>, 2002 Series

1

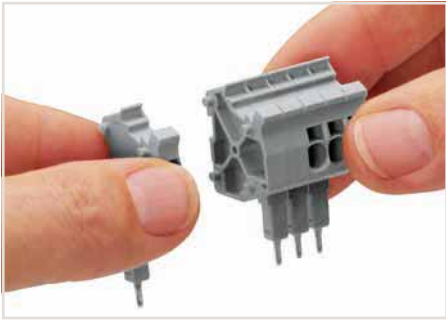

Snapping connectors and spacers together to assemble a multipole connector.

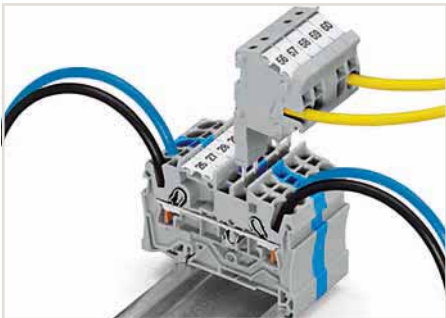

The modular TOPJOB® S connectors also connect conductors of the same size as the terminal blocks being used.

2000-510    2000-511    2000-549



Modular TOPJOB® S connector, for jumper contact slot, snaps together, gray

Pole No.	Item No.	Pack. Unit
○ 1	2000-510	100 (25)

Modular TOPJOB® S connector, for jumper contact slot, snaps together, gray  
Terminal block width: 5 mm / 0.197 inch

Pole No.	Item No.	Pack. Unit
○ 1	2000-511	100 (25)

Spacer module, snaps together, bridges commoned terminal blocks

Color	Item No.	Pack. Unit
○ gray	2000-549	100 (25)

TOPJOB® S connector strip, for jumper contact slot, gray

Pole No.	Item No.	Pack. Unit
○ 2	2000-552	25
○ 3	2000-553	25
○ 4	2000-554	25
○ 5	2000-555	10
○ 6	2000-556	10
○ 7	2000-557	10
○ 8	2000-558	10
○ 9	2000-559	10
○ 10	2000-560	10

#### Technical Data

Rated voltage (III / 3)	500 V
-------------------------	-------

Rated surge voltage (III / 3)	6 kV
-------------------------------	------

Rated current	13.5 A
---------------	--------

Approval	
----------	--

Nominal cross section	1 mm <sup>2</sup>
-----------------------	-------------------

#### Connection Data

Solid conductor	0.14 ... 1.5 mm <sup>2</sup> / 24 ... 16 AWG
-----------------	--

Solid conductor, push-in termination	0.5 ... 1.5 mm <sup>2</sup> / 20 ... 16 AWG
--------------------------------------	---

Fine-stranded conductor	0.14 ... 1.5 mm <sup>2</sup> / 24 ... 16 AWG
-------------------------	--

Fine-stranded conductor with ferrule, push-in termination, min.	0.75 mm <sup>2</sup> / 18 AWG
---	-------------------------------

Strip length	9 ... 11 mm / 0.35 ... 0.43 inch
--------------	----------------------------------

Terminal block width	3.5 mm / 0.138 inch
----------------------	---------------------

Insulation material	Polyamide 66 (PA 66)
---------------------	----------------------

#### Note:

TOPJOB® S connectors, see page 31

TOPJOB® S L-type test plug modules, see page 30

Appropriate marking system, WMB/WMB Inline/Mini-WSB/marketing strips, see Full Line Catalog, Volume 6

Approvals and corresponding ratings, visit [www.wago.com](http://www.wago.com)

#### Accessories (Selection)

End plate, for modular TOPJOB® S connector, 1.5 mm thick	gray	2002-541	175
--	------	----------	-----

End plate, for modular TOPJOB® S test plug module, 1.5 mm thick			
---	--	--	--

Strain relief plate, gray	35 mm wide	734-326	175
---------------------------	------------	---------	-----



Modular TOPJOB® S connector, for jumper contact slot, snaps together, gray

Pole No.	Item No.	Pack. Unit
○ 1	2001-511	100 (25)

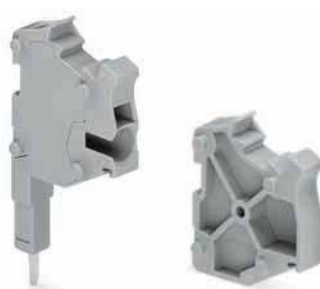

Modular TOPJOB® S connector, for jumper contact slot, snaps together, gray

Pole No.	Item No.	Pack. Unit
○ 1	2002-511	100 (25)



TOPJOB® S L-type test plug module, snaps together, gray

Pole No.	Item No.	Pack. Unit
○ 1	2002-611	100 (25)

Spacer module, snaps together, bridges commoned terminal blocks

Color	Item No.	Pack. Unit
○ gray	2001-549	100 (25)

Spacer module, snaps together, bridges commoned terminal blocks

Color	Item No.	Pack. Unit
○ gray	2002-549	100 (25)

TOPJOB® S L-type spacer module, snaps together, bridges commoned terminal blocks

Color	Item No.	Pack. Unit
○ gray	2002-649	100 (25)

TOPJOB® S connector strip, for jumper contact slot, gray

Pole No.	Item No.	Pack. Unit
○ 2	2001-552	25
○ 3	2001-553	25
○ 4	2001-554	25
○ 5	2001-555	10
○ 6	2001-556	10
○ 7	2001-557	10
○ 8	2001-558	10
○ 9	2001-559	10
○ 10	2001-560	10

TOPJOB® S connector strip, for jumper contact slot, gray

Pole No.	Item No.	Pack. Unit
○ 2	2002-552	25
○ 3	2002-553	25
○ 4	2002-554	25
○ 5	2002-555	10
○ 6	2002-556	10
○ 7	2002-557	10
○ 8	2002-558	10
○ 9	2002-559	10
○ 10	2002-560	10



500 V
6 kV
18 A
300 V, 15 A,
1.5 mm <sup>2</sup>
0.25 ... 2.5 mm <sup>2</sup> / 22 ... 14 AWG
0.5 ... 2.5 mm <sup>2</sup> / 20 ... 14 AWG
0.25 ... 2.5 mm <sup>2</sup> / 22 ... 14 AWG
0.75 mm <sup>2</sup> / 18 AWG
9 ... 11 mm / 0.35 ... 0.43 inch
4.2 mm / 0.165 inch
Polyamide 66 (PA 66)

500 V
6 kV
24 A
300 V, 20 A,
2.5 mm <sup>2</sup>
0.25 ... 4 mm <sup>2</sup> / 22 ... 12 AWG
0.75 ... 4 mm <sup>2</sup> / 18 ... 12 AWG
0.25 ... 4 mm <sup>2</sup> / 22 ... 12 AWG
0.75 mm <sup>2</sup> / 18 AWG
10 ... 12 mm / 0.39 ... 0.47 inch
5.2 mm / 0.205 inch
Polyamide 66 (PA 66)

500 V
6 kV
18 A
2.5 mm <sup>2</sup>
0.25 ... 4 mm <sup>2</sup> / 22 ... 12 AWG
0.75 ... 4 mm <sup>2</sup> / 18 ... 12 AWG
0.25 ... 4 mm <sup>2</sup> / 22 ... 12 AWG
0.75 mm <sup>2</sup> / 18 AWG
10 ... 12 mm / 0.39 ... 0.47 inch
5.2 mm / 0.205 inch
Polyamide 66 (PA 66)

According to EN 61984, pluggable connectors without current interrupting capacity shall not be mated and unmated when live or under load.

	Item No.	Page
gray	2002-541	175
35 mm wide	734-326	175

	Item No.	Page
gray	2002-541	175
35 mm wide	734-326	175

	Item No.	Page
gray	2002-641	175
35 mm wide	734-326	175

## TOPJOB® S

### Modular Connectors and Connector Strips

#### 4 (6) mm<sup>2</sup>, 2004, 2006, 2010 and 2016 Series

1

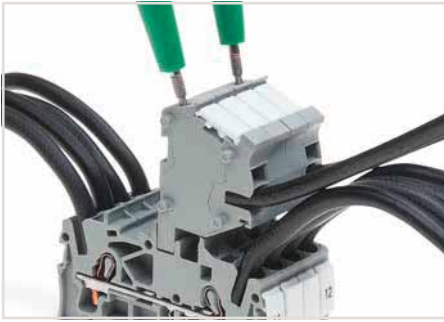

TOPJOB® S Connectors with a 2 mm Ø test socket for testing voltage via 2-pole voltage tester

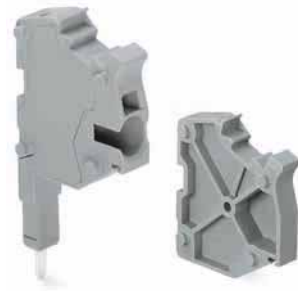

Modular TOPJOB® S connector, for jumper contact slot, snaps together, gray

Pole No.	Item No.	Pack. Unit
○ 1	2004-511	100 (25)

Spacer module, snaps together, bridges commoned terminal blocks

Color	Item No.	Pack. Unit
○ gray	2004-549	100 (25)

TOPJOB® S connector strip, for jumper contact slot, gray

Pole No.	Item No.	Pack. Unit
○ 2	2004-552	25
○ 3	2004-553	25
○ 4	2004-554	25
○ 5	2004-555	10



#### Technical Data

Rated voltage (III / 3)	500 V
Rated surge voltage (III / 3)	6 kV
Rated current	32 A
Approval	300 V, 15 A, 
Nominal cross section	4 mm <sup>2</sup>

#### Connection Data

Solid conductor	0.5 ... 6 mm <sup>2</sup> / 20 ... 10 AWG
Solid conductor, push-in termination	1 ... 6 mm <sup>2</sup> / 14 ... 10 AWG
Fine-stranded conductor	0.5 ... 6 mm <sup>2</sup> / 20 ... 10 AWG
Fine-stranded conductor with ferrule, push-in termination, min.	0.75 mm <sup>2</sup> / 18 AWG
Strip length	11 ... 13 mm / 0.43 ... 0.51 inch
Terminal block width	6.2 mm / 0.244 inch
Insulation material	Polyamide 66 (PA 66)

#### Accessories (Selection)

	Item No.	Page
End plate, for modular TOPJOB® S connector, 1.5 mm thick	2004-541	175
Strain relief plate, gray	734-326	175

 TOPJOB® S connectors, see page 31

 Appropriate marking system, WMB/WMB Inline/Mini-WSB/markings strips, see Full Line Catalog, Volume 6

 Approvals and corresponding ratings, visit [www.wago.com](http://www.wago.com)



Modular TOPJOB® S connector, for jumper contact slot, snaps together, gray

Pole No.	Item No.	Pack. Unit
○ 1	2006-511	50 (25)

Modular TOPJOB® S connector, for jumper contact slot, snaps together, gray

Pole No.	Item No.	Pack. Unit
○ 1	2010-511	50 (25)

Modular TOPJOB® S connector, for jumper contact slot, snaps together, gray

Pole No.	Item No.	Pack. Unit
○ 1	2016-511	50 (25)

Spacer module, snaps together, bridges commoned terminal blocks

Color	Item No.	Pack. Unit
○ gray	2006-549	50 (25)

Spacer module, snaps together, bridges commoned terminal blocks

Color	Item No.	Pack. Unit
○ gray	2010-549	50 (25)

Spacer module, snaps together, bridges commoned terminal blocks

Color	Item No.	Pack. Unit
○ gray	2016-549	50 (25)



500 V
6 kV
32 A

500 V
6 kV
32 A

500 V
6 kV
32 A

4 mm <sup>2</sup>
-------------------

4 mm <sup>2</sup>
-------------------

4 mm <sup>2</sup>
-------------------

0.5 ... 6 mm <sup>2</sup> / 20 ... 10 AWG
1 ... 6 mm <sup>2</sup> / 14 ... 10 AWG
0.5 ... 6 mm <sup>2</sup> / 20 ... 10 AWG
0.75 mm <sup>2</sup> / 18 AWG

0.5 ... 6 mm <sup>2</sup> / 20 ... 10 AWG
1 ... 6 mm <sup>2</sup> / 14 ... 10 AWG
0.5 ... 6 mm <sup>2</sup> / 20 ... 10 AWG
0.75 mm <sup>2</sup> / 18 AWG

0.5 ... 6 mm <sup>2</sup> / 20 ... 10 AWG
1 ... 6 mm <sup>2</sup> / 14 ... 10 AWG
0.5 ... 6 mm <sup>2</sup> / 20 ... 10 AWG
0.75 mm <sup>2</sup> / 18 AWG

11 ... 13 mm / 0.43 ... 0.51 inch
7.5 mm / 0.295 inch
Polyamide 66 (PA 66)

11 ... 13 mm / 0.43 ... 0.51 inch
10 mm / 0.394 inch
Polyamide 66 (PA 66)

11 ... 13 mm / 0.43 ... 0.51 inch
12 mm / 0.47 inch
Polyamide 66 (PA 66)

	Item No.	Page
gray	2004-541	175
35 mm wide	734-326	175

	Item No.	Page
gray	2004-541	175
35 mm wide	734-326	175

	Item No.	Page
gray	2004-541	175
35 mm wide	734-326	175

## TOPJOB® S

Accessories, 2000 Series or a 3.5 mm Terminal Block Width  
Commoning, Mounting, Marking and Testing

1



 Push-in type jumper bars,  
see page 23

Push-in type jumper bar, insulated,  $I_N$  14 A

	light gray Item No.	red Item No.	blue Item No.	yellow-green Item No.	Pack. Unit
2-way	2000-402	2000-402/000-005	2000-402/000-006	2000-402/000-018	200 (25)
3-way	2000-403	2000-403/000-005	2000-403/000-006		200 (25)
4-way	2000-404	2000-404/000-005	2000-404/000-006		200 (25)
5-way	2000-405	2000-405/000-005	2000-405/000-006		100 (25)
6-way	2000-406	2000-406/000-005	2000-406/000-006		100 (25)
7-way	2000-407	2000-407/000-005	2000-407/000-006		100 (25)
8-way	2000-408	2000-408/000-005	2000-408/000-006		100 (25)
9-way	2000-409	2000-409/000-005	2000-409/000-006		100 (25)
10-way	2000-410	2000-410/000-005	2000-410/000-006		100 (25)



Push-in type jumper bar, insulated,  $I_N$  14 A, light gray

	Item No.	Pack. Unit
1 to 3	2000-433	200 (25)
1 to 4	2000-434	200 (25)
1 to 5	2000-435	100 (25)
1 to 6	2000-436	100 (25)
1 to 7	2000-437	100 (25)
1 to 8	2000-438	100 (25)
1 to 9	2000-439	100 (25)
1 to 10	2000-440	100 (25)



 Delta jumper,  
see page 26

Delta jumper, insulated,  $I_N = I_N$  terminal block, light gray

	Item No.	Pack. Unit
1-2 3-4 5-6	2000-406/020-000	100 (25)



 Star point jumper,  
see page 26

Star point jumper, insulated,  $I_N = I_N$  terminal block, light gray

	Item No.	Pack. Unit
1-3-5	2000-405/011-000	100 (25)



 Push-in type wire jumpers,  
see page 26

Note: Push down the wire jumper until fully inserted.

Rated voltage (III / 3)	800 V
Rated surge voltage (III / 3)	8 kV

Push-in type wire jumper, insulated, 0.75 mm<sup>2</sup> conductor cross-section, for 2000 and 2020 Series rail-mount terminal blocks,  $I_N$  9 A

	Item No.	Pack. Unit
L = 60 mm	2009-402	100 (10)
L = 110 mm	2009-404	100 (10)
L = 250 mm	2009-406	100 (10)



 Double-deck vertical jumpers,  
see page 25

Rated voltage (III / 3)	500 V
Rated surge voltage (III / 3)	6 kV

Double-deck vertical jumper, insulated,  $I_N$  13.5 A

Suitable for:	Color	Item No.	Pack. Unit
2000-2231 2000-2231/099-000	light gray	2000-492	100 (25)

## TOPJOB® S

Accessories, 2000 Series or a 3.5 mm Terminal Block Width  
Commoning, Mounting, Marking and Testing

End and intermediate plate, 0.7 mm thick			
Suitable for:	Color	Item No.	Pack. Unit
2000-1201	orange	2000-1292	100 (25)
	gray	2000-1291	100 (25)



End and intermediate plate, 0.7 mm thick			
Suitable for:	Color	Item No.	Pack. Unit
2000-1301	orange	2000-1392	100 (25)
	gray	2000-1391	100 (25)



End and intermediate plate, 0.7 mm thick			
Suitable for:	Color	Item No.	Pack. Unit
2000-1401	orange	2000-1492	100 (25)
	gray	2000-1491	100 (25)



End and intermediate plate, 0.7 mm thick			
Suitable for:	Color	Item No.	Pack. Unit
2000-2141	orange	2000-2196	100 (25)
	gray	2000-2195	100 (25)



End and intermediate plate, 0.7 mm thick			
Suitable for:	Color	Item No.	Pack. Unit
2000-2231 2000-2231/099-000	orange	2000-2292	100 (25)
	gray	2000-2291	100 (25)

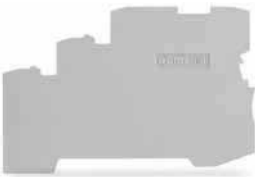

End and intermediate plate, 1 mm thick, for 3-conductor terminal blocks			
Suitable for:	Color	Item No.	Pack. Unit
2000-5311	gray	2000-5391	100 (25)



End and intermediate plate, 1 mm thick, for 4-conductor terminal blocks			
Suitable for:	Color	Item No.	Pack. Unit
2000-5417	gray	2000-5491	100 (25)



 For application notes, see page 32.

Separator for Ex e/Ex i applications, 3 mm thick, orange			
		Item No.	Pack. Unit
90 mm wide		209-190	50 (25)
120 mm wide		209-191	50 (25)



Protective warning marker, with black high-voltage symbol, for 5 terminal blocks			
Color		Item No.	Pack. Unit
yellow		2000-115	100 (25)



## TOPJOB® S

Accessories, 2001 Series or a 4.2 mm Terminal Block Width  
Commoning, Mounting, Marking and Testing

1



Push-in type jumper bars, see page 23

Push-in type jumper bar, insulated, I<sub>N</sub> 14 A, light gray

	Item No.	Pack. Unit
2-way	2001-402	200 (25)
3-way	2001-403	200 (25)
4-way	2001-404	200 (25)
5-way	2001-405	100 (25)
6-way	2001-406	100 (25)
7-way	2001-407	100 (25)
8-way	2001-408	100 (25)
9-way	2001-409	100 (25)
10-way	2001-410	100 (25)



Push-in type jumper bar, insulated, I<sub>N</sub> 14 A, light gray

	Item No.	Pack. Unit
1 to 3	2001-433	200 (25)
1 to 4	2001-434	200 (25)
1 to 5	2001-435	100 (25)
1 to 6	2001-436	100 (25)
1 to 7	2001-437	100 (25)
1 to 8	2001-438	100 (25)
1 to 9	2001-439	100 (25)
1 to 10	2001-440	100 (25)



Delta jumper, see page 26

Delta jumper, insulated, I<sub>N</sub> = I<sub>N</sub> terminal block, light gray

	Item No.	Pack. Unit
1-2 3-4 5-6	2001-406/020-000	100 (25)



Star point jumper, see page 26

Star point jumper, insulated, I<sub>N</sub> = I<sub>N</sub> terminal block, light gray

	Item No.	Pack. Unit
1-3-5	2001-405/011-000	100 (25)



Step-down jumper, see page 27

Step-down jumper, insulated, commons 6/4 mm<sup>2</sup> (10/12 AWG) to 4/2.5/1.5 mm<sup>2</sup> (12/14/16 AWG), I<sub>N</sub> 32 A

Color	Item No.	Pack. Unit
light gray	2006-499	50 (25)



Push-in type wire jumpers, see page 26

Note: Push down the wire jumper until fully inserted.

Rated voltage (III / 3)	800 V
Rated surge voltage (III / 3)	8 kV

Push-in type wire jumper, insulated, 1.5 mm<sup>2</sup> conductor cross-section, for 2001, 2002, 2003 and 2022 Series rail-mount terminal blocks, I<sub>N</sub> 18 A

	Item No.	Pack. Unit
L = 60 mm	2009-412	100 (10)
L = 110 mm	2009-414	100 (10)
L = 250 mm	2009-416	100 (10)

## TOPJOB® S

Accessories, 2001 Series or a 4.2 mm Terminal Block Width  
Commoning, Mounting, Marking and Testing

End and intermediate plate, 0.8 mm thick			
Suitable for:	Color	Item No.	Pack. Unit
2001-1201	orange	2002-1292	100 (25)
2001-1211/1000-411	gray	2002-1291	100 (25)



Separator, oversized, 2 mm thick			
Suitable for:	Color	Item No.	Pack. Unit
2001-1201	orange	2002-1294	100 (25)
2001-1211/1000-411	gray	2002-1293	100 (25)



End and intermediate plate, 0.8 mm thick			
Suitable for:	Color	Item No.	Pack. Unit
2001-1301	orange	2002-1392	100 (25)
2001-1311/1000-411	gray	2002-1391	100 (25)



Separator, oversized, 2 mm thick			
Suitable for:	Color	Item No.	Pack. Unit
2001-1301	orange	2002-1394	100 (25)
2001-1311/1000-411	gray	2002-1393	100 (25)



End and intermediate plate, 0.8 mm thick			
Suitable for:	Color	Item No.	Pack. Unit
2001-1401	orange	2002-1492	100 (25)
2001-1411/1000-411	gray	2002-1491	100 (25)
2001-1441			



Separator, oversized, 2 mm thick			
Suitable for:	Color	Item No.	Pack. Unit
2001-1401	orange	2002-1494	100 (25)
2001-1411/1000-411	gray	2002-1493	100 (25)
2001-1441			



 For application notes, see page 32.

Separator for Ex e/Ex i applications, 3 mm thick, orange			
		Item No.	Pack. Unit
90 mm wide		209-190	50 (25)
120 mm wide		209-191	50 (25)



Protective warning marker, with black high-voltage symbol, for 5 terminal blocks			
Color		Item No.	Pack. Unit
yellow		2001-115	100 (25)



Insulation stop, 0.25 ... 0.5 mm², 5 pcs/strip			
Color		Item No.	Pack. Unit
light gray		2001-171	200 (25)

## TOPJOB® S

Accessories, 2002 Series or a 5.2 mm Terminal Block Width  
Commoning, Mounting, Marking and Testing

1



 Push-in type jumper bars,  
see page 23

Push-in type jumper bar, insulated,  $I_N$  25 A

	light gray Item No.	red Item No.	blue Item No.	Pack. Unit
2-way	2002-402	2002-402/000-005	2002-402/000-006	200 (25)
3-way	2002-403	2002-403/000-005	2002-403/000-006	200 (25)
4-way	2002-404	2002-404/000-005	2002-404/000-006	200 (25)
5-way	2002-405	2002-405/000-005	2002-405/000-006	100 (25)
6-way	2002-406	2002-406/000-005	2002-406/000-006	100 (25)
7-way	2002-407	2002-407/000-005	2002-407/000-006	100 (25)
8-way	2002-408	2002-408/000-005	2002-408/000-006	100 (25)
9-way	2002-409	2002-409/000-005	2002-409/000-006	100 (25)
10-way	2002-410	2002-410/000-005	2002-410/000-006	100 (25)



Push-in type jumper bar, insulated,  $I_N$  14 A, light gray

	Item No.	Pack. Unit
1 to 3	2002-433	200 (25)
1 to 4	2002-434	200 (25)
1 to 5	2002-435	100 (25)
1 to 6	2002-436	100 (25)
1 to 7	2002-437	100 (25)
1 to 8	2002-438	100 (25)
1 to 9	2002-439	100 (25)
1 to 10	2002-440	100 (25)



 Staggered jumpers,  
see page 24

Note: Push down the staggered jumper until fully inserted.

Rated voltage (III / 3)	400 V
Rated surge voltage (III / 3)	6 kV

Staggered jumper, insulated,  $I_N$  25 A, light gray

	Item No.	Pack. Unit
2-way	2002-472	100 (25)
3-way	2002-473	100 (25)
4-way	2002-474	100 (25)
5-way	2002-475	50 (25)
6-way	2002-476	50 (25)
7-way	2002-477	50 (25)
8-way	2002-478	50 (25)
9-way	2002-479	50 (25)
10-way	2002-480	50 (25)
11-way	2002-481	50 (25)
12-way	2002-482	50 (25)

Note: Push down the staggered jumper until fully inserted.

Rated voltage (III / 3)	400 V
Rated surge voltage (III / 3)	6 kV



Customized staggered jumper, insulated, with contact lugs broken off at the factory and circuit printing,  $I_N$  25 A, light gray

	Item No.	Pack. Unit
2-way (1-3)	2002-473/011-000	100 (25)
3-way (1-3-5)	2002-475/011-000	50 (25)
4-way (1-3-5-7)	2002-477/011-000	50 (25)
5-way (1-3-5-7-9)	2002-479/011-000	50 (25)
6-way (1-3-5-7-9-11)	2002-481/011-000	50 (25)

## TOPJOB® S

Accessories, 2002 Series or a 5.2 mm Terminal Block Width  
Commoning, Mounting, Marking and Testing

Adjacent jumper for continuous commoning, see page 25

Adjacent jumper for continuous commoning, insulated, 800 V, I<sub>N</sub> 25 A, light gray

	Item No.	Pack. Unit
2-way	2002-400	100 (25)



Adjacent jumpers for continuous commoning, see page 25

Rated voltage (III / 3)	800 V
Rated surge voltage (III / 3)	8 kV

Adjacent jumper for continuous commoning, insulated, I<sub>N</sub> 25 A, 1 to 3

	Item No.	Pack. Unit
Color		
light gray	2002-423	100 (25)
red	2002-423/000-005	100 (25)
blue	2002-423/000-006	100 (25)



Delta jumper, see page 26

Delta jumper, insulated, I<sub>N</sub> = I<sub>N</sub> terminal block, light gray

	Item No.	Pack. Unit
1-2 3-4 5-6	2002-406/020-000	100 (25)



Star point jumper, see page 26

Star point jumper, insulated, I<sub>N</sub> = I<sub>N</sub> terminal block, light gray

	Item No.	Pack. Unit
1-3-5	2002-405/011-000	100 (25)



Step-down jumper, see page 27

Step-down jumper, insulated, commons 6/4 mm<sup>2</sup> (10/12 AWG) to 4/2.5/1.5 mm<sup>2</sup> (12/14/16 AWG), I<sub>N</sub> 32 A

	Item No.	Pack. Unit
Color		
light gray	2006-499	50 (25)



Push-in type wire jumpers, see page 26

Note: Push down the wire jumper until fully inserted.

Rated voltage (III / 3)	800 V
Rated surge voltage (III / 3)	8 kV

Push-in type wire jumper, insulated, 1.5 mm<sup>2</sup> conductor cross-section, for 2001, 2002, 2003 and 2022 Series rail-mount terminal blocks, I<sub>N</sub> 18 A

	Item No.	Pack. Unit
L = 60 mm	2009-412	100 (10)
L = 110 mm	2009-414	100 (10)
L = 250 mm	2009-416	100 (10)



Double-deck vertical jumpers, see page 25

Rated voltage (III / 3)	500 V
Rated surge voltage (III / 3)	6 kV

Double-deck vertical jumper, insulated, I<sub>N</sub> 24 A

Suitable for:	Color	Item No.	Pack. Unit
2002-2231	light gray	2002-492	100 (25)
2002-2231/099-000	orange	2002-492/000-012	100 (25)

## TOPJOB® S

Accessories, 2002 Series or a 5.2 mm Terminal Block Width  
Commoning, Mounting, Marking and Testing

1



 Triple-deck vertical jumper, see page 25

Rated voltage (III / 3)	500 V
Rated surge voltage (III / 3)	6 kV

Triple-deck vertical jumper, insulated, I<sub>N</sub> 24 A

Suitable for:	Color	Item No.	Pack. Unit
2002-3231	light gray	2002-493	100 (25)



## End and intermediate plate, 0.8 mm thick

Suitable for:	Color	Item No.	Pack. Unit
2002-1201	orange	2002-1292	100 (25)
2002-1211/1000-411	gray	2002-1291	100 (25)



## Separator, oversized, 2 mm thick

Suitable for:	Color	Item No.	Pack. Unit
2002-1201	orange	2002-1294	100 (25)
2002-1211/1000-411	gray	2002-1293	100 (25)



## End and intermediate plate, 0.8 mm thick

Suitable for:	Color	Item No.	Pack. Unit
2002-1301	orange	2002-1392	100 (25)
2002-1311/1000-411	gray	2002-1391	100 (25)



## Separator, oversized, 2 mm thick

Suitable for:	Color	Item No.	Pack. Unit
2002-1301	orange	2002-1394	100 (25)
2002-1311/1000-411	gray	2002-1393	100 (25)



## End and intermediate plate, 0.8 mm thick

Suitable for:	Color	Item No.	Pack. Unit
2002-1401	orange	2002-1492	100 (25)
2002-1411/1000-411	gray	2002-1491	100 (25)
2002-1441			



## Separator, oversized, 2 mm thick

Suitable for:	Color	Item No.	Pack. Unit
2002-1401	orange	2002-1494	100 (25)
2002-1411/1000-411	gray	2002-1493	100 (25)
2002-1441			



## End and intermediate plate, 0.8 mm thick

Suitable for:	Color	Item No.	Pack. Unit
2002-6301	orange	2002-6392	100 (25)
2002-6401	gray	2002-6391	100 (25)



## End and intermediate plate, 0.8 mm thick

Suitable for:	Color	Item No.	Pack. Unit
2002-2231	orange	2002-2292	100 (25)
2002-2231/099-000	gray	2002-2291	100 (25)



## Separator plate, oversized upper deck, snap-on type, 2 mm thick

Suitable for:	Color	Item No.	Pack. Unit
2002-2201/098-000	orange	2002-2296	100 (25)
	gray	2002-2295	100 (25)



## End and intermediate plate, 0.8 mm thick

Suitable for:	Color	Item No.	Pack. Unit
2002-2431	orange	2002-2492	100 (25)
	gray	2002-2491	100 (25)

## TOPJOB® S

Accessories, 2002 Series or a 5.2 mm Terminal Block Width  
Commoning, Mounting, Marking and Testing

End and intermediate plate, 1 mm thick			
Suitable for:	Color	Item No.	Pack. Unit
2002-2601	orange	2002-2692	100 (25)
2002-2671	gray	2002-2691	100 (25)



End and intermediate plate, 0.8 mm thick			
Suitable for:	Color	Item No.	Pack. Unit
2002-3231	orange	2002-3292	100 (25)
	gray	2002-3291	100 (25)



End and intermediate plate, 1 mm thick			
Suitable for:	Color	Item No.	Pack. Unit
2002-4127	orange	2002-4192	100 (25)
	gray	2002-4191	100 (25)



End and intermediate plate, 1 mm thick			
Suitable for:	Color	Item No.	Pack. Unit
2002-2951	orange	2002-2992	100 (25)
	gray	2002-2991	100 (25)



End and intermediate plate, 1 mm thick			
Suitable for:	Color	Item No.	Pack. Unit
2002-1601	orange	2002-1692	100 (25)
2002-1681	gray	2002-1691	100 (25)
2002-1611			



End and intermediate plate, 1 mm thick			
Suitable for:	Color	Item No.	Pack. Unit
2002-1701	orange	2002-1792	100 (25)
2002-1781	gray	2002-1791	100 (25)
2002-1711			



End and intermediate plate, 1 mm thick			
Suitable for:	Color	Item No.	Pack. Unit
2002-1801	orange	2002-1892	100 (25)
2002-1881	gray	2002-1891	100 (25)
2002-1811			



End and intermediate plate, 1 mm thick			
Suitable for:	Color	Item No.	Pack. Unit
2002-1901	orange	2002-1992	100 (25)
2002-1981	gray	2002-1991	100 (25)
2002-1911			



End plate for fuse terminal blocks, 2 mm thick			
Suitable for:	Color	Item No.	Pack. Unit
2004-911	orange	2002-992	100 (25)
2002-1611	gray	2002-991	100 (25)
2002-1711			
2002-1811			
2002-1911			

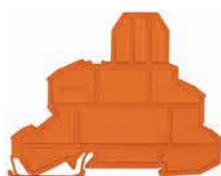

End plate for fuse terminal blocks, 2 mm thick			
Suitable for:	Color	Item No.	Pack. Unit
2002-2611	orange	2002-1092	100 (25)
	gray	2002-1091	100 (25)



## TOPJOB® S

Accessories, 2002 Series or a 5.2 mm Terminal Block Width  
Commoning, Mounting, Marking and Testing

1



 For application notes, see page 32.

Separator for Ex e/Ex i applications, 3 mm thick, orange

	Item No.	Pack. Unit
90 mm wide	209-190	50 (25)
120 mm wide	209-191	50 (25)



 For application notes, see page 32.

Separator for Ex e/Ex i applications, 3 mm thick, orange

Suitable for:	Item No.	Pack. Unit
Double-deck terminal blocks	209-192	50 (25)



Protective warning marker, with black high-voltage symbol, for 5 terminal blocks

Color	Item No.	Pack. Unit
yellow	2002-115	100 (25)



Insulation stop, 0.25 ... 0.5 mm<sup>2</sup>, 5 pcs/strip

Color	Item No.	Pack. Unit
light gray	2002-171	200 (25)



Insulation stop, 0.75 ... 1 mm<sup>2</sup>, 5 pcs/strip

Color	Item No.	Pack. Unit
dark gray	2002-172	200 (25)



Lockout cap, for conductor entry and operating slot

Suitable for:	Color	Item No.	Pack. Unit
2002-4127	orange	2002-192	25
	gray	2002-191	25
	blue	2002-194	25



Disconnect plug for carrier terminal blocks, suitable when using a carrier terminal block as disconnect terminal block

Suitable for:	Color	Item No.	Pack. Unit
2002-1661	orange	2002-401	100 (25)
2002-1761			
2002-1861			
2002-1961			

## TOPJOB® S

Accessories, 2004 Series or a 6.2 mm Terminal Block Width  
Commoning, Mounting, Marking and Testing

 Push-in type jumper bars,  
see page 23

Push-in type jumper bar, insulated, I<sub>N</sub> 32 A, light gray

	Item No.	Pack. Unit
2-way	2004-402	200 (25)
3-way	2004-403	200 (25)
4-way	2004-404	100 (25)
5-way	2004-405	100 (25)
6-way	2004-406	100 (25)
7-way	2004-407	100 (25)
8-way	2004-408	100 (25)
9-way	2004-409	100 (25)
10-way	2004-410	100 (25)

Push-in type jumper bar, insulated, I<sub>N</sub> 32 A, light gray

	Item No.	Pack. Unit
1 to 3	2004-433	200 (25)
1 to 4	2004-434	200 (25)
1 to 5	2004-435	100 (25)
1 to 6	2004-436	100 (25)
1 to 7	2004-437	100 (25)
1 to 8	2004-438	100 (25)
1 to 9	2004-439	100 (25)
1 to 10	2004-440	100 (25)



 Delta jumper,  
see page 26

Delta jumper, insulated, I<sub>N</sub> = I<sub>N</sub> terminal block, light gray

	Item No.	Pack. Unit
1-2-3-4-5-6	2004-406/020-000	100 (25)



 Star point jumper,  
see page 26

Star point jumper, insulated, I<sub>N</sub> = I<sub>N</sub> terminal block, light gray

	Item No.	Pack. Unit
1-3-5	2004-405/011-000	100 (25)



 Step-down jumper,  
see page 27

Step-down jumper, insulated, commons 6/4 mm<sup>2</sup> (10/12 AWG) to 4/2.5/1.5 mm<sup>2</sup> (12/14/16 AWG), I<sub>N</sub> 32 A

Color	Item No.	Pack. Unit
light gray	2006-499	50 (25)



## End and intermediate plate, 1 mm thick

Suitable for:	Color	Item No.	Pack. Unit
2004-1201	orange	2004-1292	100 (25)
2004-1211/1000-401	gray	2004-1291	100 (25)



## Separator, oversized, 2 mm thick

Suitable for:	Color	Item No.	Pack. Unit
2004-1201	orange	2004-1294	100 (25)
2004-1211/1000-401	gray	2004-1293	100 (25)



## End and intermediate plate, 1 mm thick

Suitable for:	Color	Item No.	Pack. Unit
2004-1301	orange	2004-1392	100 (25)
2004-1311/1000-401	gray	2004-1391	100 (25)

## TOPJOB® S

Accessories, 2004 Series or a 6.2 mm Terminal Block Width  
Commoning, Mounting, Marking and Testing

1



Separator, oversized, 2 mm thick			
Suitable for:	Color	Item No.	Pack. Unit
2004-1301	orange	2004-1394	100 (25)
2004-1311/1000-401	gray	2004-1393	100 (25)



End and intermediate plate, 1 mm thick			
Suitable for:	Color	Item No.	Pack. Unit
2004-1401	orange	2004-1492	100 (25)
2004-1411/1000-401	gray	2004-1491	100 (25)



Separator, oversized, 2 mm thick			
Suitable for:	Color	Item No.	Pack. Unit
2004-1401	orange	2004-1494	100 (25)
2004-1411/1000-401	gray	2004-1493	100 (25)



 For application notes, see page 32.

Separator for Ex e/Ex i applications, 3 mm thick, orange			
		Item No.	Pack. Unit
90 mm wide		209-190	50 (25)
120 mm wide		209-191	50 (25)



Protective warning marker, with black high-voltage symbol, for 5 terminal blocks			
Color		Item No.	Pack. Unit
yellow		2004-115	100 (25)



Insulation stop, 0.25 ... 0.5 mm², 5 pcs/strip			
Color		Item No.	Pack. Unit
light gray		2004-171	200 (25)



Insulation stop, 0.75 ... 1 mm², 5 pcs/strip			
Color		Item No.	Pack. Unit
dark gray		2004-172	200 (25)

## TOPJOB® S

Accessories, 2006 Series or a 7.5 mm Terminal Block Width  
Commoning, Mounting, Marking and Testing

Push-in type jumper bars,  
see page 23

Push-in type jumper bar, insulated, I <sub>N</sub> 41 A, light gray		
	Item No.	Pack. Unit
2-way	2006-402	50 (25)
3-way	2006-403	50 (25)
4-way	2006-404	50 (25)
5-way	2006-405	50 (25)



Push-in type jumper bar, insulated, I <sub>N</sub> 41 A, light gray		
	Item No.	Pack. Unit
1 to 3	2006-433	50 (25)
1 to 4	2006-434	50 (25)
1 to 5	2006-435	50 (25)



Star point jumper,  
see page 26

Star point jumper, insulated, I <sub>N</sub> = I <sub>N</sub> terminal block, light gray		
	Item No.	Pack. Unit
1-3-5	2006-405/011-000	50 (25)



Step-down jumper,  
see page 27

Step-down jumper, insulated, commons 6/4 mm <sup>2</sup> (10/12 AWG) to 4/2.5/1.5 mm <sup>2</sup> (12/14/16 AWG), I <sub>N</sub> 32 A		
Color	Item No.	Pack. Unit
light gray	2006-499	50 (25)



End and intermediate plate, 1 mm thick			
Suitable for:	Color	Item No.	Pack. Unit
2006-1201	orange	2006-1292	100 (25)
	gray	2006-1291	100 (25)



Separator, oversized, 2 mm thick			
Suitable for:	Color	Item No.	Pack. Unit
2006-1201	orange	2006-1294	100 (25)
	gray	2006-1293	100 (25)



End and intermediate plate, 1 mm thick			
Suitable for:	Color	Item No.	Pack. Unit
2006-1301	orange	2006-1392	100 (25)
	gray	2006-1391	100 (25)



Separator, oversized, 2 mm thick			
Suitable for:	Color	Item No.	Pack. Unit
2006-1301	orange	2006-1394	100 (25)
	gray	2006-1393	100 (25)



End and intermediate plate, 1 mm thick			
Suitable for:	Color	Item No.	Pack. Unit
2006-1601	orange	2006-1692	100 (25)
2006-1681	gray	2006-1691	100 (25)
2006-1611			



Intermediate plate, 2.9 mm thick			
Suitable for:	Color	Item No.	Pack. Unit
2006-931/099-000	orange	2006-1696	100 (25)
	gray	2006-1695	100 (25)

1

## TOPJOB® S

Accessories, 2006 Series or a 7.5 mm Terminal Block Width  
Commoning, Mounting, Marking and Testing

1

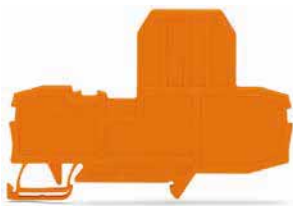

End plate for fuse terminal blocks, 2 mm thick			
Suitable for:	Color	Item No.	Pack. Unit
2006-1611	orange	2006-992	100 (25)
2006-1631/099-000	gray	2006-991	100 (25)



End and intermediate plate, 1 mm thick			
Suitable for:	Color	Item No.	Pack. Unit
2006-8601	orange	2006-8692	48 (12)
	gray	2006-8691	48 (12)



 For application notes, see page 32.

Separator for Ex e/Ex i applications, 3 mm thick, orange		
	Item No.	Pack. Unit
120 mm wide	209-191	50 (25)



Protective warning marker, with black high-voltage symbol, for 5 terminal blocks		
Color	Item No.	Pack. Unit
yellow	2006-115	100 (25)



Lockout cap, for conductor entry and operating slot			
Suitable for:	Color	Item No.	Pack. Unit
2006-1671	gray	2006-191	25
2006-8671			



Disconnect plug for carrier terminal blocks, suitable when using a carrier terminal block as disconnect terminal block			
Suitable for:	Color	Item No.	Pack. Unit
2006-1661	orange	2006-401	100 (25)
	white	2006-401/000-050	100 (25)



Disconnect plug for carrier terminal blocks, suitable when using a carrier terminal block as disconnect terminal block			
Suitable for:	Color	Item No.	Pack. Unit
2006-8661	orange	2006-8401	48 (12)



Blind plug for carrier terminal blocks, indicates a disconnection			
Suitable for:	Color	Item No.	Pack. Unit
2006-1661	red	2006-451	100 (25)

## TOPJOB® S

Accessories, 2010 Series or a 10 mm Terminal Block Width  
Commoning, Mounting, Marking and Testing

Push-in type jumper bars, see page 23

Push-in type jumper bar, insulated, I<sub>N</sub> 57 A, light gray

	Item No.	Pack. Unit
2-way	2010-402	50 (25)
3-way	2010-403	50 (25)
4-way	2010-404	50 (25)
5-way	2010-405	50 (25)



Push-in type jumper bar, insulated, I<sub>N</sub> 57 A, light gray

	Item No.	Pack. Unit
1 to 3	2010-433	50 (25)
1 to 4	2010-434	50 (25)
1 to 5	2010-435	50 (25)



Star point jumper, see page 26

Star point jumper, insulated, I<sub>N</sub> = I<sub>N</sub> terminal block, light gray

	Item No.	Pack. Unit
1-3-5	2010-405/011-000	50 (25)



Step-down jumper, see page 27

Step-down jumper, insulated, commons 16/10 mm<sup>2</sup> (8/10 AWG) to 10/6/4/2.5 mm<sup>2</sup> (8/10/12/14 AWG), I<sub>N</sub> 57 A

Color	Item No.	Pack. Unit
light gray	2016-499	50 (25)



End and intermediate plate, 1 mm thick

Suitable for:	Color	Item No.	Pack. Unit
2010-1201	orange	2010-1292	100 (25)
	gray	2010-1291	100 (25)



End and intermediate plate, 1 mm thick

Suitable for:	Color	Item No.	Pack. Unit
2010-1301	orange	2010-1392	100 (25)
	gray	2010-1391	100 (25)



For application notes, see page 32.

Separator for Ex e/Ex i applications, 3 mm thick, orange

	Item No.	Pack. Unit
120 mm wide	209-191	50 (25)



Protective warning marker, with black high-voltage symbol, for 5 terminal blocks

Color	Item No.	Pack. Unit
yellow	2010-115	50 (25)



Finger guard, touch-proof cover protects unused conductor entries

Color	Item No.	Pack. Unit
yellow	2010-100	100 (25)



## TOPJOB® S

Accessories, 2016 Series or a 12 mm Terminal Block Width  
Commoning, Mounting, Marking and Testing

1



Push-in type jumper bars, see page 23

Push-in type jumper bar, insulated, I<sub>N</sub> 76 A, light gray

	Item No.	Pack. Unit
2-way	2016-402	50 (25)
3-way	2016-403	50 (25)
4-way	2016-404	50 (25)
5-way	2016-405	50 (25)



Push-in type jumper bar, insulated, I<sub>N</sub> 76 A, light gray

	Item No.	Pack. Unit
1 to 3	2016-433	50 (25)
1 to 4	2016-434	50 (25)
1 to 5	2016-435	50 (25)



Star point jumper, see page 26

Star point jumper, insulated, I<sub>N</sub> = I<sub>N</sub> terminal block, light gray

	Item No.	Pack. Unit
1-3-5	2016-405/011-000	50 (25)



Step-down jumper, see page 27

Step-down jumper, insulated, commons 16/10 mm<sup>2</sup> (8/10 AWG) to 10/6/4/2.5 mm<sup>2</sup> (8/10/12/14 AWG), I<sub>N</sub> 57 A

Color	Item No.	Pack. Unit
light gray	2016-499	50 (25)



End and intermediate plate, 1 mm thick

Suitable for:	Color	Item No.	Pack. Unit
2016-1201	orange	2016-1292	100 (25)
	gray	2016-1291	100 (25)



End and intermediate plate, 1 mm thick

Suitable for:	Color	Item No.	Pack. Unit
2016-1301	orange	2016-1392	100 (25)
	gray	2016-1391	100 (25)



For application notes, see page 32.

Separator for Ex e/Ex i applications, 3 mm thick, orange

	Item No.	Pack. Unit
120 mm wide	209-191	50 (25)



Protective warning marker, with black high-voltage symbol, for 5 terminal blocks

Color	Item No.	Pack. Unit
yellow	2016-115	50 (25)



Finger guard, touch-proof cover protects unused conductor entries

Color	Item No.	Pack. Unit
yellow	2016-400	100 (25)

## TOPJOB® S General Accessories



Collective jumper carrier,  
see page 26

Collective jumper carrier, for DIN-35 rail, compatible with 2000 to 2016 Series jumpers

Color	Item No.	Pack. Unit
gray	2009-180	25



Shorting link, (5 x 20) mm, suitable when using the fuse plug as a disconnect plug, I<sub>N</sub> 6.3 A

Suitable for:	Item No.	Pack. Unit
2004-911	281-503	250 (25)
2006-911		



Wire commoning chain, insulated, 50 connections, I<sub>N</sub> 8 A

Color	Item No.	Pack. Unit
black	210-103	5 (1)
blue	210-123	5 (1)



Strain relief plate, gray

	Item No.	Pack. Unit
35 mm wide	734-326	100 (25)
6 mm wide	734-327	100 (25)
12.5 mm wide	734-328	100 (25)
25 mm wide	734-329	100 (25)



TOPJOB® S connector,  
see pages 31 and 156.

End plate, for modular TOPJOB® S connector, 1.5 mm thick

Suitable for:	Color	Item No.	Pack. Unit
2000-510	gray	2002-541	100 (25)
2001-511			
2002-511			
2002-511			



TOPJOB® S connector,  
see pages 31 and 158.

End plate, for modular TOPJOB® S connector, 1.5 mm thick

Suitable for:	Color	Item No.	Pack. Unit
2004-511	gray	2004-541	100 (25)
2006-511			
2010-511			
2016-511			



TOPJOB® S L-type test plug module,  
see pages 30 and 157.

End plate, for modular TOPJOB® S test plug module, 1.5 mm thick

Suitable for:	Color	Item No.	Pack. Unit
2002-611	gray	2002-641	100 (25)



Test plug adapter,  
see page 30

Power must be switched off when installing the test plug adapter. The safety rules for working on live installations must be observed.

Test plug adapter, for 4 mm Ø test plug

Color	Item No.	Pack. Unit
gray	2009-174	100 (25)



Testing tap,  
see page 30

Power must be switched off when installing the test plug adapter. The safety rules for working on live installations must be observed.

Testing tap, for max. 2.5 mm<sup>2</sup> (14 AWG)

Color	Item No.	Pack. Unit
gray	2009-182	100 (25)

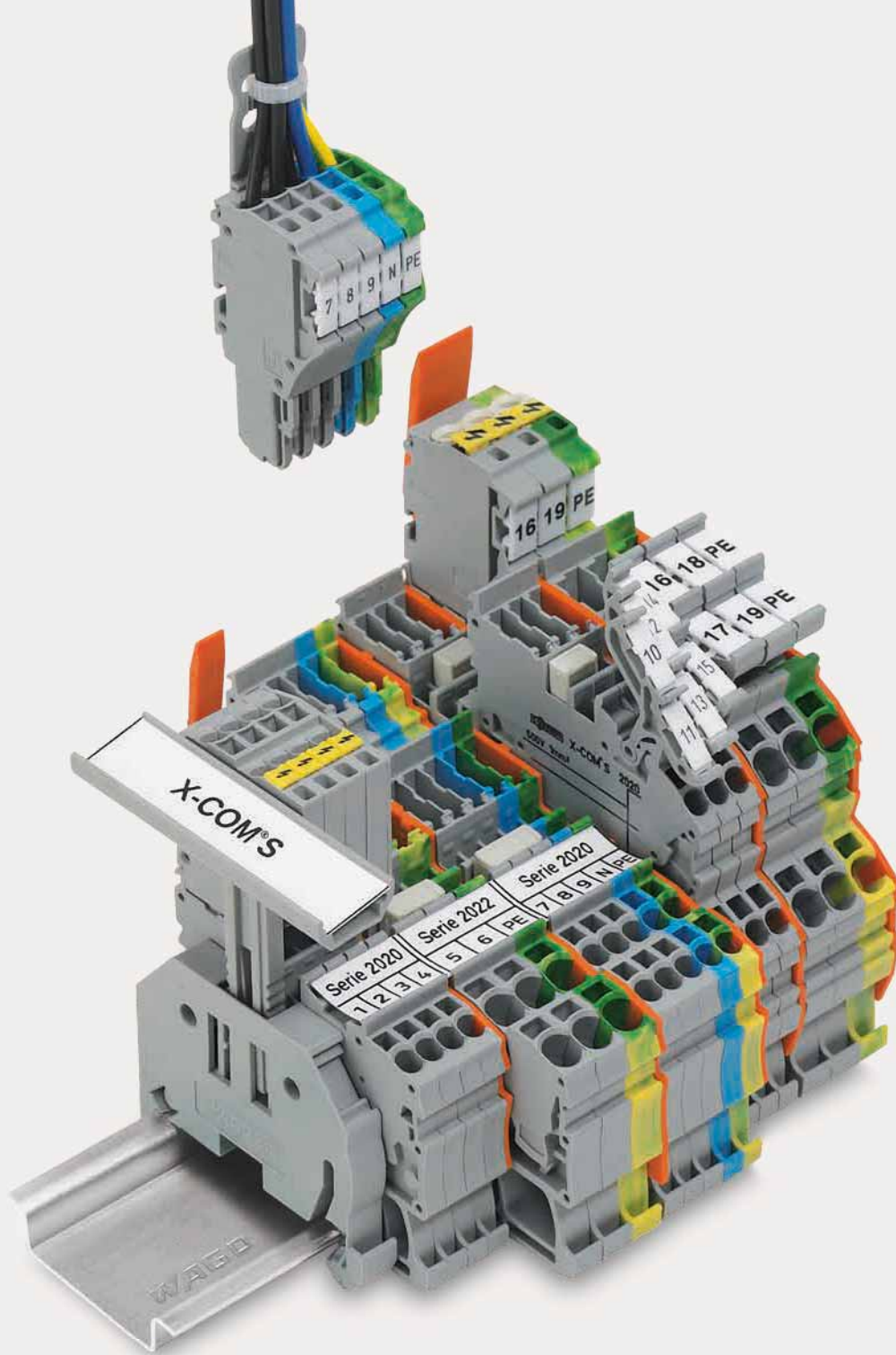

## Rail-Mount Terminal Blocks with a Plug-gable Connector, X-COM<sup>®</sup>S-SYSTEM

## Rail-Mount Terminal Blocks with a Pluggable Connector, X-COM®S-SYSTEM with Push-in CAGE CLAMP® Connection Front-Entry Wiring

			Page
	<b>X-COM®S-SYSTEM-MINI</b> Through and Ground Conductor Carrier Terminal Blocks 0.14 ... 1 (1.5) mm <sup>2</sup> (24 ... 16 AWG)	2020 Series	180
	<b>Double-Deck Carrier Terminal Blocks</b> 0.14 ... 1 (1.5) mm <sup>2</sup> (24 ... 16 AWG)	2020 Series	184
	<b>1- and 2-Conductor Female Plugs</b> 0.14 ... 1 (1.5) mm <sup>2</sup> (24 ... 16 AWG)	2020 Series	189
	<b>Female Plugs for Self-Assembly</b> 0.14 ... 1 (1.5) mm <sup>2</sup> (24 ... 16 AWG)	2020 Series	192
	<b>1- and 2-Conductor Female Plugs with Locking Levers and Strain Relief Plates</b> 0.14 ... 1 (1.5) mm <sup>2</sup> (24 ... 16 AWG)	2020 Series	194
	<b>X-COM®S-SYSTEM</b> Through and Ground Conductor Carrier Terminal Blocks 0.25 ... 2.5 (4) mm <sup>2</sup> (24 ... 4 AWG)	2022 Series	198
	<b>Double-Deck Carrier Terminal Blocks</b> 0.25 ... 2.5 (4) mm <sup>2</sup> (24 ... 4 AWG)	2022 Series	202
	<b>1-Conductor Female Plugs</b> 0.25 ... 2.5 (4) mm <sup>2</sup> (24 ... 4 AWG)	2022 Series	207
	<b>Female Plugs for Self-Assembly</b> 0.25 ... 2.5 (4) mm <sup>2</sup> (24 ... 4 AWG)	2022 Series	210
	<b>1-Conductor Female Plugs with Locking Levers and Strain Relief Plates</b> 0.25 ... 2.5 (4) mm <sup>2</sup> (24 ... 4 AWG)	2022 Series	212
	<b>X-COM®S-SYSTEM, for Ex Applications</b> Through/Ground Conductor Carrier Terminal Blocks and Double-Deck Carrier Terminal Blocks 0.25 ... 2.5 (4) mm <sup>2</sup> (24 ... 4 AWG)	2022 Series	214
	<b>1-Conductor Female Plugs</b> 0.25 ... 2.5 (4) mm <sup>2</sup> (24 ... 4 AWG)		221



## X-COM®S-SYSTEM-MINI, 2020 Series

## X-COM®S-SYSTEM, 2022 Series

### Description and Installation

2

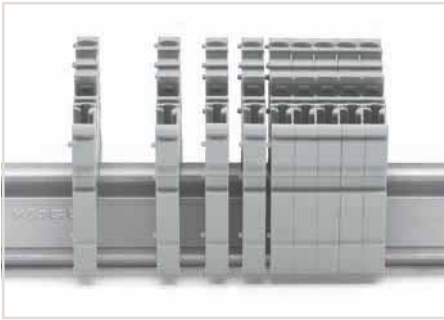

Snap individual carrier terminal blocks onto the carrier rail and slide together.



Open the assembly by laterally sliding a block via operating tool (3.5 x 0.5 mm blade).



Separate terminal block assembly and slide individual terminal blocks laterally using an operating tool.

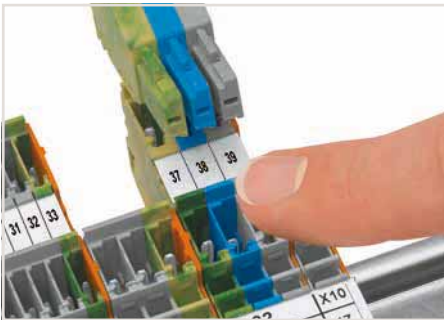

Carrier terminal blocks and female plugs are touch-proof.



Push-in CAGE CLAMP® enables solid conductors and fine-stranded conductors with ferrules to be connected by simply pushing them into the unit.

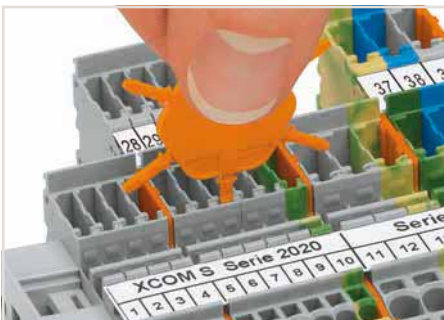
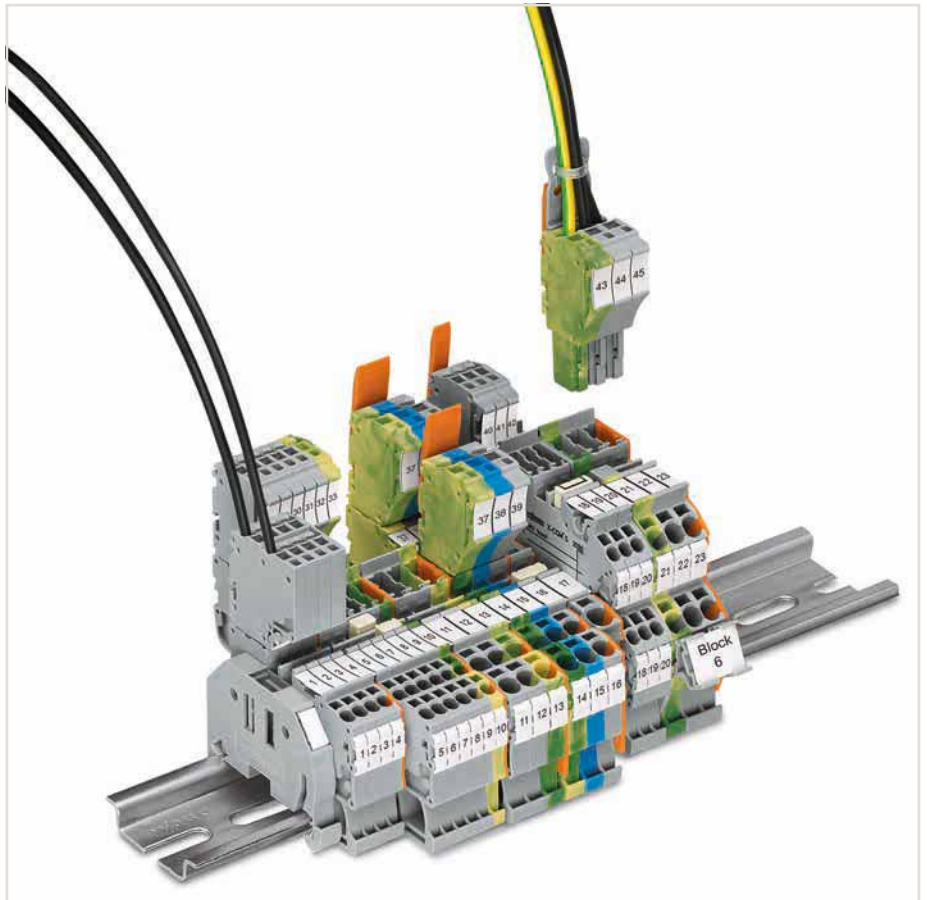

Insert coding pin into the corresponding slot and twist it off.



Remove the coding finger using a cutting tool.

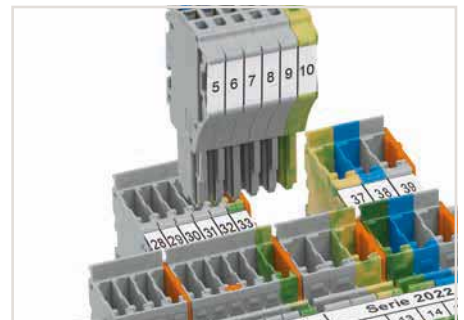

Insert coded female connector into X-COM®S-SYSTEM terminal block assembly.

# X-COM®S-SYSTEM-MINI, 2020 Series X-COM®S-SYSTEM, 2022 Series Installation

2

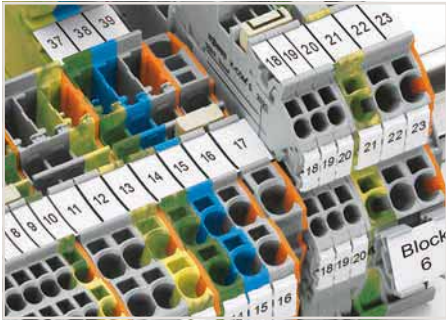

Commoning X-COM®S-SYSTEM Terminal Blocks using jumpers for TOPJOB® S Terminal Blocks. An end plate provides connection to TOPJOB® S Terminal Blocks. 2020 and 2022 Series Terminal Blocks are combinable. Jumper slots are on the same level for both series.

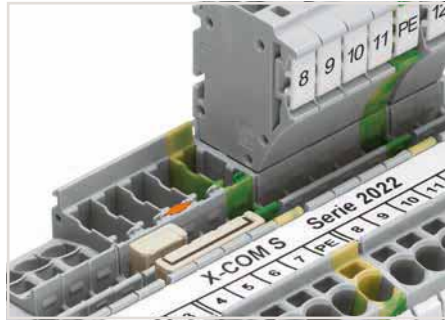

Pairing push-in comb style jumpers.

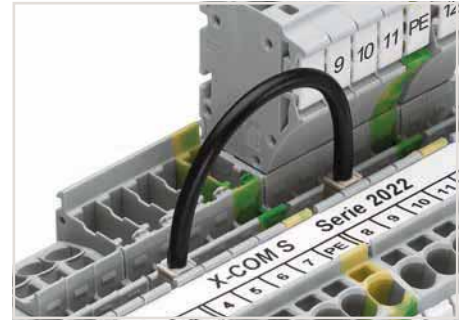

Commoning with push-in type wire jumper.

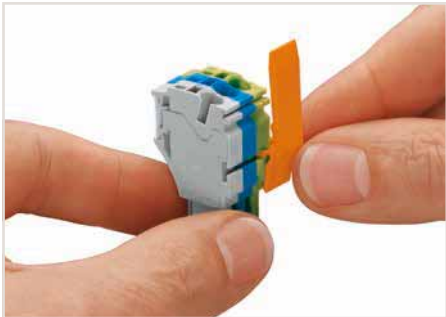

Slide the locking lever into position.



Female plugs can be individually locked.



Test plug adapter (2009-174) for 4 mm test plugs or banana plugs – also suitable for X-COM®S-SYSTEM-MINI Terminal Blocks.



Clear marking via large marking area

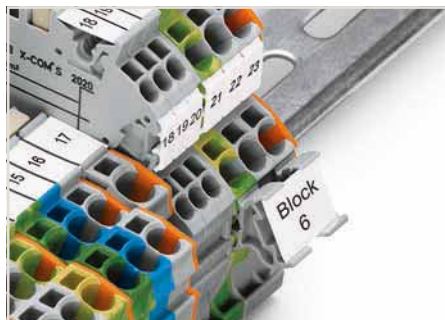

Marker carrier (2009-198)



## X-COM®S-SYSTEM-MINI – 1-Conductor/1-Pin, 2-Conductor/1-Pin and 2-Conductor/2-Pin Carrier Terminal Blocks

### 1 (1.5) mm<sup>2</sup>, 2020 Series

2



X-COM®S-SYSTEM terminal block assembly

Current-carrying capacity curves upon request.

#### Note:

When used as intended, female plugs shall not be connected/disconnected when live or under load.

An appropriate end plate must be applied to the carrier terminal blocks after each female plug.

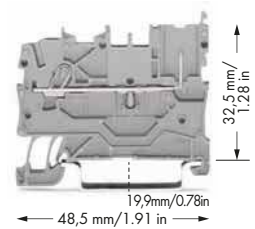

1-conductor/1-pin carrier terminal block, for DIN-35 rail, per EN 60715

Color	Item No.	Pack. Unit
● gray	2020-1201	50
● blue	2020-1204	50



#### Technical Data

Ratings per	IEC/EN 60947-7-1
Rated voltage (III / 3)	500 V
Rated surge voltage (III / 3)	6 kV
Rated current	13.5 A
Approval	300 V, 10 A ; 300 V, 10 A
Nominal cross section	1 mm <sup>2</sup>

#### Connection Data

Solid conductor	0.14 ... 1.5 mm <sup>2</sup> / 24 ... 16 AWG
Solid conductor, push-in termination	0.5 ... 1.5 mm <sup>2</sup> / 20 ... 16 AWG
Fine-stranded conductor	0.14 ... 1.5 mm <sup>2</sup> / 24 ... 16 AWG
Fine-stranded conductor with ferrule, push-in termination, min.	0.75 mm <sup>2</sup> / 18 AWG
Strip length	9 ... 11 mm / 0.35 ... 0.43 inch
Terminal block width	3.5 mm / 0.138 inch
Insulation material	Polyamide 66 (PA 66)

#### Accessories (Selection)

Push-in type jumper bar, insulated, I <sub>n</sub> 14 A, light gray	
End and intermediate plate, 1 mm thick	
WMB Multi marking system, white, 10 strips with 10 markers per card, for 3.5 mm terminal block width	
Marking strip, plain, 11 mm wide, 50 m reel	
Test pin, 1 mm Ø, with solder connection for test cable	

	Item No.	Page
2-way	2000-402	222
orange	2020-1292	223
plain	793-3501	780
white	2009-110	783
	859-500	227

Accessories (jumpers, end plates, test plugs, etc.), see page 222

Female plugs, see page 189

Carrier rails and tools, see Section 13

Appropriate marking system, WMB/marketing strips, see Full Line Catalog, Volume 6

Approvals and corresponding ratings, visit [www.wago.com](http://www.wago.com)

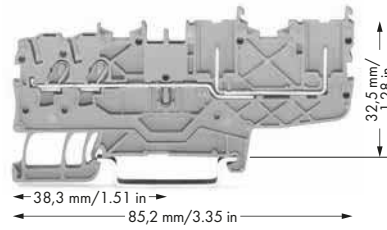
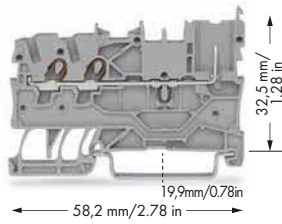

2-conductor/1-pin carrier terminal block, for DIN-35 rail, per EN 60715

Color	Item No.	Pack. Unit
gray	2020-1301	50
blue	2020-1304	50

2-conductor/2-pin carrier terminal block, for DIN-35 rail, per EN 60715

Color	Item No.	Pack. Unit
gray	2020-1401	50
blue	2020-1404	50



IEC/EN 60947-7-1
500 V
6 kV
13.5 A
300 V, 10 A ; 300 V, 10 A
1 mm <sup>2</sup>
0.14 ... 1.5 mm <sup>2</sup> / 24 ... 16 AWG
0.5 ... 1.5 mm <sup>2</sup> / 20 ... 16 AWG
0.14 ... 1.5 mm <sup>2</sup> / 24 ... 16 AWG
0.75 mm <sup>2</sup> / 18 AWG
9 ... 11 mm / 0.35 ... 0.43 inch
3.5 mm / 0.138 inch
Polyamide 66 (PA 66)

	Item No.	Page
2-way	2000-402	222
orange	2020-1392	223
plain	793-3501	780
white	2009-110	783
	859-500	227



IEC/EN 60947-7-1
500 V
6 kV
13.5 A
300 V, 10 A ; 300 V, 10 A
1 mm <sup>2</sup>
0.14 ... 1.5 mm <sup>2</sup> / 24 ... 16 AWG
0.5 ... 1.5 mm <sup>2</sup> / 20 ... 16 AWG
0.14 ... 1.5 mm <sup>2</sup> / 24 ... 16 AWG
0.75 mm <sup>2</sup> / 18 AWG
9 ... 11 mm / 0.35 ... 0.43 inch
3.5 mm / 0.138 inch
Polyamide 66 (PA 66)

	Item No.	Page
2-way	2000-402	222
orange	2020-1492	223
plain	793-3501	780
white	2009-110	783
	859-500	227

## X-COM®S-SYSTEM-MINI – 1-Conductor/1-Pin, 2-Conductor/1-Pin and 2-Conductor/2-Pin Ground Carrier Terminal Blocks

### 1 (1.5) mm<sup>2</sup>, 2020 Series

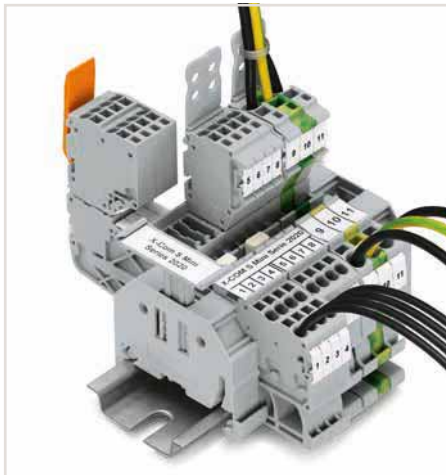

X-COM®S-SYSTEM terminal block assembly

**Note:**

When used as intended, female plugs shall not be connected/disconnected when live or under load.

An appropriate end plate must be applied to the carrier terminal blocks after each female plug.

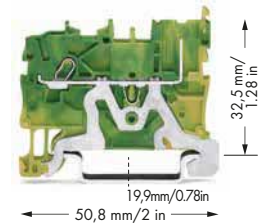

1-conductor/1-pin ground carrier terminal block, for DIN-35 rail, per EN 60715

Color	Item No.	Pack. Unit
● green-yellow	2020-1207	50

**Technical Data**

Ratings per	IEC/EN 60947-7-2
Nominal cross section	1 mm <sup>2</sup>
<b>Connection Data</b>	
Solid conductor	0.14 ... 1.5 mm <sup>2</sup> / 24 ... 16 AWG
Solid conductor, push-in termination	0.5 ... 1.5 mm <sup>2</sup> / 20 ... 16 AWG
Fine-stranded conductor	0.14 ... 1.5 mm <sup>2</sup> / 24 ... 16 AWG
Fine-stranded conductor with ferrule, push-in termination, min.	0.75 mm <sup>2</sup> / 18 AWG
Strip length	9 ... 11 mm / 0.35 ... 0.43 inch
Terminal block width	3.5 mm / 0.138 inch
Insulation material	Polyamide 66 (PA 66)

**Accessories (Selection)**

	Item No.	Page
Push-in type jumper bar, insulated, I <sub>N</sub> 14 A, light gray	2000-402	222
End and intermediate plate, 1 mm thick	orange	223
WMB Multi marking system, white, 10 strips with 10 markers per card, for 3.5 mm terminal block width	plain	780
Marking strip, plain, 11 mm wide, 50 m reel	white	783
Test pin, 1 mm Ø, with solder connection for test cable	859-500	227

📖 Accessories (jumpers, end plates, test plugs, etc.), see page 222

📖 Female plugs, see page 189

📖 Carrier rails and tools, see Section 13

📖 Appropriate marking system, WMB/markings strips, see Full Line Catalog, Volume 6

📖 Approvals and corresponding ratings, visit [www.wago.com](http://www.wago.com)

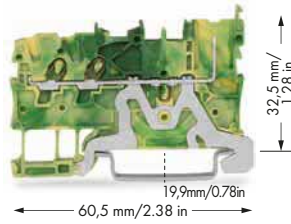

2-conductor/1-pin ground carrier terminal block, for DIN-35 rail, per EN 60715

Color	Item No.	Pack. Unit
● green-yellow	2020-1307	50



IEC/EN 60947-7-2
1 mm <sup>2</sup>
0.14 ... 1.5 mm <sup>2</sup> / 24 ... 16 AWG
0.5 ... 1.5 mm <sup>2</sup> / 20 ... 16 AWG
0.14 ... 1.5 mm <sup>2</sup> / 24 ... 16 AWG
0.75 mm <sup>2</sup> / 18 AWG
9 ... 11 mm / 0.35 ... 0.43 inch
3.5 mm / 0.138 inch
Polyamide 66 (PA 66)

	Item No.	Page
2-way	2000-402	222
orange	2020-1392	223
plain	793-3501	780
white	2009-110	783
	859-500	227

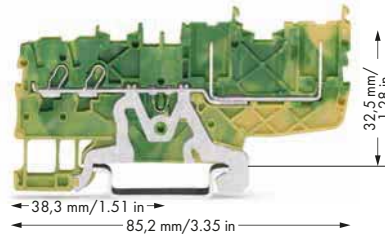

2-conductor/2-pin ground carrier terminal block, for DIN-35 rail, per EN 60715

Color	Item No.	Pack. Unit
● green-yellow	2020-1407	50



IEC/EN 60947-7-2
1 mm <sup>2</sup>
0.14 ... 1.5 mm <sup>2</sup> / 24 ... 16 AWG
0.5 ... 1.5 mm <sup>2</sup> / 20 ... 16 AWG
0.14 ... 1.5 mm <sup>2</sup> / 24 ... 16 AWG
0.75 mm <sup>2</sup> / 18 AWG
9 ... 11 mm / 0.35 ... 0.43 inch
3.5 mm / 0.138 inch
Polyamide 66 (PA 66)

	Item No.	Page
2-way	2000-402	222
orange	2020-1492	223
plain	793-3501	780
white	2009-110	783
	859-500	227

## X-COM®S-SYSTEM-MINI

### Double-Deck Terminal Blocks

#### 1 (1.5 mm<sup>2</sup>, 2020 Series)



Size comparison:  
Double-deck carrier terminal blocks with 3.5 mm and 5.2 mm terminal block width

#### Note:

When used as intended, female plugs shall not be connected/disconnected when live or under load.

An appropriate end plate must be applied to the carrier terminal blocks after each female plug.

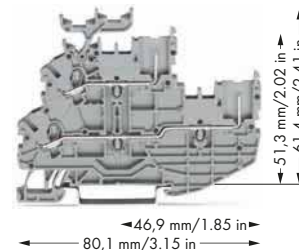

1-conductor/1-pin double-deck carrier terminal block, through/through terminal block, with marker carrier

	Item No.	Pack. Unit
○ L/L	2020-2231	50
○ N/L	2020-2232	50
○ L/N	2020-2233	50
● N/N	2020-2234	50

1-conductor/1-pin double-deck carrier block, through/through terminal block, without marker carrier

	Item No.	Pack. Unit
○ L/L	2020-2201	50
○ N/L	2020-2202	50
○ L/N	2020-2203	50
● N/N	2020-2204	50



#### Technical Data

Ratings per	IEC/EN 60947-7-1
Rated voltage (III / 3)	500 V
Rated surge voltage (III / 3)	6 kV
Rated current	13.5 A
Approval	300 V, 10 A  300 V, 10 A
Nominal cross section	1 mm <sup>2</sup>

#### Connection Data

Solid conductor	0.14 ... 1.5 mm <sup>2</sup> / 24 ... 16 AWG
Solid conductor, push-in termination	0.5 ... 1.5 mm <sup>2</sup> / 20 ... 16 AWG
Fine-stranded conductor	0.14 ... 1.5 mm <sup>2</sup> / 24 ... 16 AWG
Fine-stranded conductor with ferrule, push-in termination, min.	0.5 mm <sup>2</sup> / 20 AWG
Strip length	9 ... 11 mm / 0.35 ... 0.43 inch
Terminal block width	3.5 mm / 0.138 inch
Insulation material	Polyamide 66 (PA 66)

#### Accessories (Selection)

Push-in type jumper bar, insulated, I <sub>N</sub> 14 A, light gray	
End and intermediate plate, 1 mm thick	
WMB Multi marking system, white, 10 strips with 10 markers per card, for 3.5 mm terminal block width	
Marking strip, plain, 11 mm wide, 50 m reel	
Test pin, 1 mm Ø, with solder connection for test cable	

	Item No.	Page
2-way	2000-402	222
orange	2020-2292	223
plain	793-3501	780
white	2009-110	783
	859-500	227

Accessories (jumpers, end plates, test plugs, etc.), see page 222

Female plugs, see page 189

Carrier rails and tools, see Section 13

Appropriate marking system, WMB/markings strips, see Full Line Catalog, Volume 6

Approvals and corresponding ratings, visit [www.wago.com](http://www.wago.com)

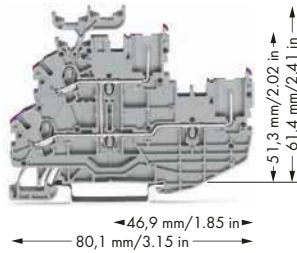

2-conductor/2-pin double-deck carrier terminal block, 2-conductor/2-pin through terminal block, with marker carrier, internally commoned, violet conductor entry, blue housing

	Item No.	Pack. Unit
○ L	2020-2238	50
● N	2020-2239	50

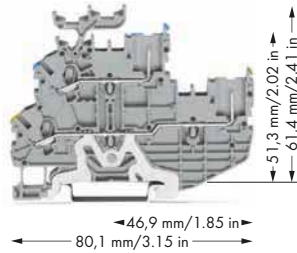

1-conductor/1-pin double-deck carrier terminal block, ground conductor/through terminal block, with marker carrier

	Item No.	Pack. Unit
○ PE/N	2020-2247	50
○ PE/L	2020-2257	50

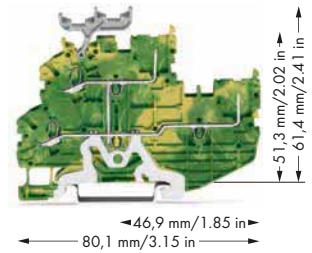

2-conductor/2-pin double-deck carrier block, 2-conductor/2-pin ground conductor block, with marker carrier, internally commoned

	Item No.	Pack. Unit
● PE	2020-2237	50

2-conductor/2-pin double-deck carrier terminal block, 2-conductor/2-pin through terminal block, without marker carrier, internally commoned, violet conductor entry, blue housing

	Item No.	Pack. Unit
○ L	2020-2208	50
● N	2020-2209	50

1-conductor/1-pin double-deck carrier terminal block, ground conductor/through terminal block, without marker carrier

	Item No.	Pack. Unit
○ PE/N	2020-2217	50
○ PE/L	2020-2227	50

2-conductor/2-pin double-deck carrier block, 2-conductor/2-pin ground conductor block, without marker carrier, internally commoned

	Item No.	Pack. Unit
● PE	2020-2207	50



IEC/EN 60947-7-1
500 V
6 kV
13.5 A
300 V, 10 A ; 300 V, 10 A
1 mm <sup>2</sup>

0.14 ... 1.5 mm <sup>2</sup> / 24 ... 16 AWG
0.5 ... 1.5 mm <sup>2</sup> / 20 ... 16 AWG
0.14 ... 1.5 mm <sup>2</sup> / 24 ... 16 AWG
0.5 mm <sup>2</sup> / 20 AWG

9 ... 11 mm / 0.35 ... 0.43 inch
3.5 mm / 0.138 inch
Polyamide 66 (PA 66)

	Item No.	Page
2-way	2000-402	222
orange	2020-2292	223
plain	793-3501	780
white	2009-110	783
	859-500	227



IEC/EN 60947-7-1
500 V
6 kV
13.5 A
300 V, 10 A ; 300 V, 10 A
1 mm <sup>2</sup>

0.14 ... 1.5 mm <sup>2</sup> / 24 ... 16 AWG
0.5 ... 1.5 mm <sup>2</sup> / 20 ... 16 AWG
0.14 ... 1.5 mm <sup>2</sup> / 24 ... 16 AWG
0.5 mm <sup>2</sup> / 20 AWG

9 ... 11 mm / 0.35 ... 0.43 inch
3.5 mm / 0.138 inch
Polyamide 66 (PA 66)

	Item No.	Page
2-way	2000-402	222
orange	2020-2292	223
plain	793-3501	780
white	2009-110	783
	859-500	227



IEC/EN 60947-7-2
500 V
6 kV
13.5 A
300 V, 10 A ; 300 V, 10 A
1 mm <sup>2</sup>

0.14 ... 1.5 mm <sup>2</sup> / 24 ... 16 AWG
0.5 ... 1.5 mm <sup>2</sup> / 20 ... 16 AWG
0.14 ... 1.5 mm <sup>2</sup> / 24 ... 16 AWG
0.5 mm <sup>2</sup> / 20 AWG

9 ... 11 mm / 0.35 ... 0.43 inch
3.5 mm / 0.138 inch
Polyamide 66 (PA 66)

	Item No.	Page
2-way	2000-402	222
orange	2020-2292	223
plain	793-3501	780
white	2009-110	783
	859-500	227



## X-COM®S-SYSTEM-MINI

### Carrier Terminal Blocks and 1-/2-Conductor Female Plugs Assembly Types

2



**1-conductor female plug**  
Carrier terminal blocks can be commoned via 2000 Series Push-In Type Jumper Bars and tested via 859-500 Test Pin.

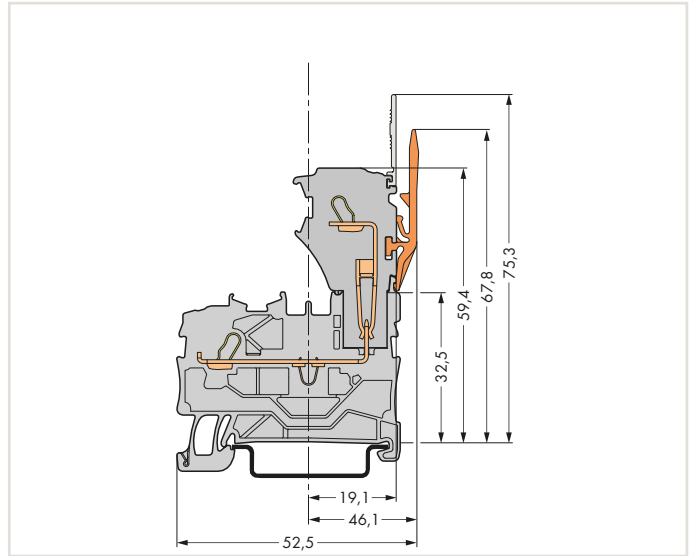

Carrier terminal block

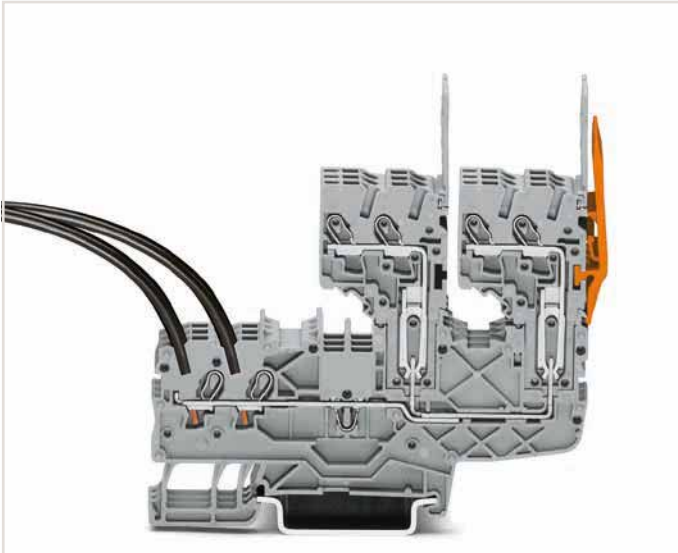

**2-conductor female connector**  
Carrier terminal blocks can be commoned via 2000 Series Push-In Type Jumper Bars and tested via 859-500 Test Pin.

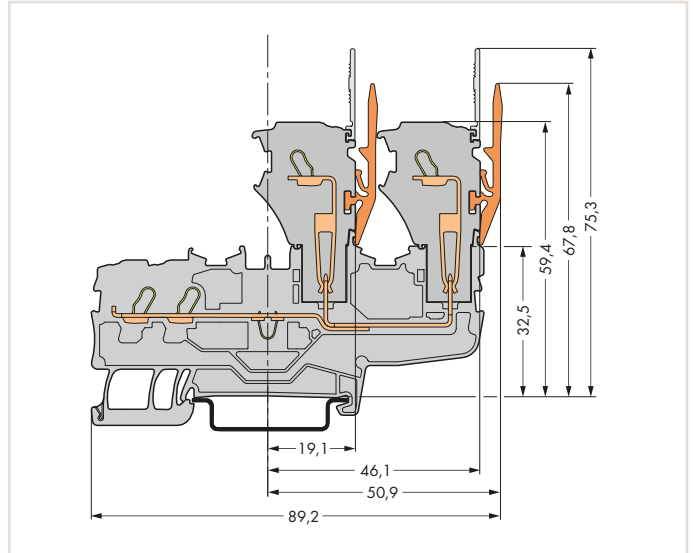

Carrier terminal block 1-conductor female plug

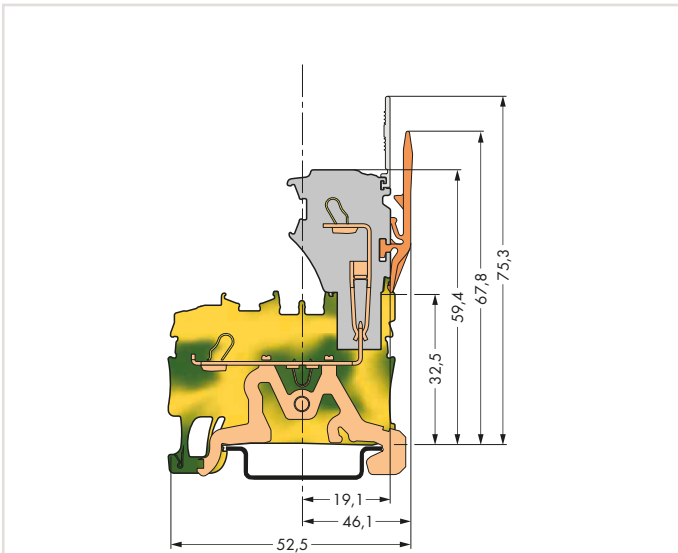

Ground carrier terminal block

## X-COM®S-SYSTEM-MINI

### Double-Deck Carrier Terminal Blocks and 1-/2-Conductor Female Plugs Assembly Types

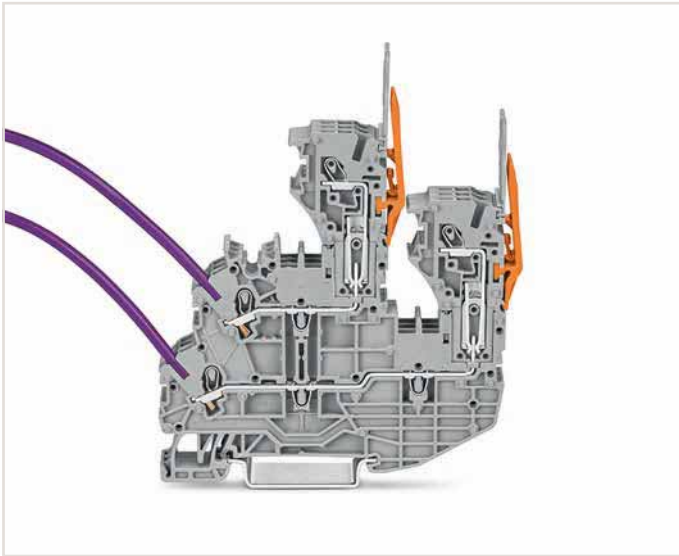

1-conductor female plug

Double-deck carrier terminal blocks can be commoned via 2000 Series Push-In Type Jumper Bars and tested via 859-500 Test Pin.

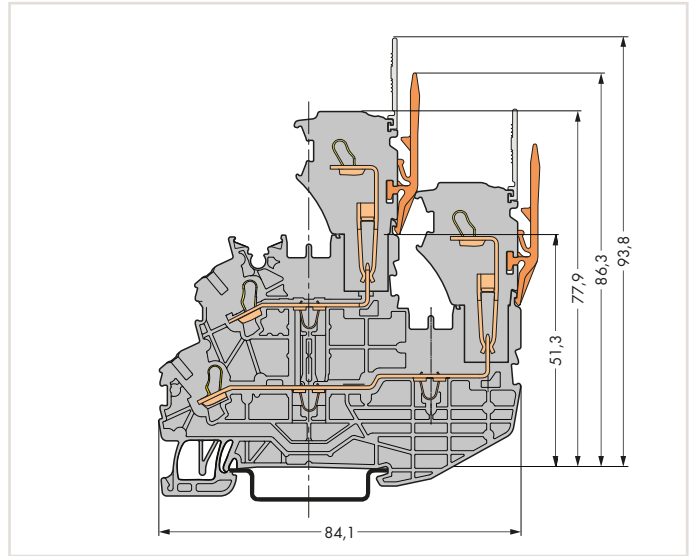

Double-deck carrier terminal block with 1-conductor female plug

## X-COM®S-SYSTEM-MINI

### 1- and 2-Conductor Female Plugs

#### 1 (1.5) mm<sup>2</sup>, 2020 Series

2

Technical Data	
Ratings per	IEC/EN 61984
Rated voltage (III / 3)	500 V
Rated surge voltage (III / 3)	6 kV
Rated current	13.5 A
Connection Data	
Connection technology	Push-in CAGE CLAMP®
Solid conductor	0.14 ... 1.5 mm <sup>2</sup> / 24 ... 16 AWG
Solid conductor, push-in termination	0.5 ... 1.5 mm <sup>2</sup> / 20 ... 16 AWG
Fine-stranded conductor	0.14 ... 1.5 mm <sup>2</sup> / 24 ... 16 AWG
Fine-stranded conductor with ferrule, push-in termination, min.	0.75 mm <sup>2</sup> / 18 AWG
Nominal cross section	1 mm <sup>2</sup>
Strip length	9 ... 11 mm / 0.35 ... 0.43 inch
Approval	300 V, 10 A <sup>W</sup> ; 300 V, 10 A <sup>®</sup>
Module width	3.5 mm / 0.138 inch
Insulation material	Polyamide 66 (PA 66)



Item no. suffixes for female plugs

blue .../000-006  
green-yellow .../000-016

Current-carrying capacity curves, visit [www.wago.com](http://www.wago.com)

#### Note:

According to EN 61984, pluggable connectors without current interrupting capacity shall not be mated and unmated when live or under load.

Accessories (Selection)		Item No.	Page
 Accessories for female plugs, see page 227	WMB Multi marking system, white, 10 strips with 10 markers per card, for 3.5 mm terminal block width	793-3501	780
 Appropriate marking system, WMB/marketing strips, see Full Line Catalog, Volume 6	Marking strip, plain, 11 mm wide, 50 m reel	2009-110	783
 Approvals and corresponding ratings, visit <a href="http://www.wago.com">www.wago.com</a>	Protective warning marker, with black high-voltage symbol, for 5 terminal blocks	2000-115	223
	Strain relief plate, gray	734-326	227
	Locking lever Width 4.8 mm	2022-142	227

# X-COM®S-SYSTEM-MINI

## 1- and 2-Conductor Female Plugs

### 1 (1.5) mm<sup>2</sup>, 2020 Series



2

Dimensions (in mm):

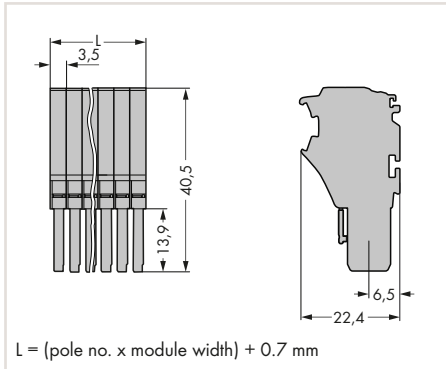

Dimensions (in mm):

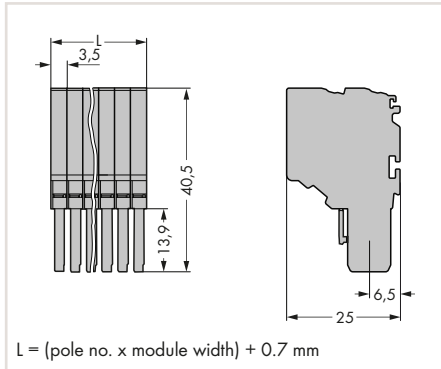

1-conductor female plug, fits into carrier terminal blocks, with coding fingers, gray

Pole No.	Item No.	Pack. Unit
2	2020-102	100
3	2020-103	50
4	2020-104	50
5	2020-105	50
6	2020-106	25
7	2020-107	25
8	2020-108	25
9	2020-109	25
10	2020-110	25
11	2020-111	20
12	2020-112	20
13	2020-113	10
14	2020-114	10
15	2020-115	10



2-conductor female plug, fits into carrier terminal blocks, with coding fingers, gray

Pole No.	Item No.	Pack. Unit
2	2020-202	100
3	2020-203	50
4	2020-204	50
5	2020-205	50
6	2020-206	25
7	2020-207	25
8	2020-208	25
9	2020-209	25
10	2020-210	25
11	2020-211	20
12	2020-212	20
13	2020-213	10
14	2020-214	10
15	2020-215	10



## X-COM®S-SYSTEM-MINI

### Pre-Assembled 1-Conductor Female Plugs

#### 1 (1.5 mm<sup>2</sup>, 2020 Series)

2

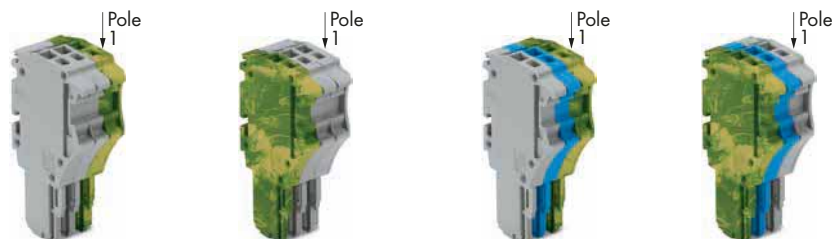

1-conductor female plug with ground base module (green-yellow), fits into carrier terminal blocks, with coding fingers

Pole No.	Item No.	Pack. Unit
3	2020-103/000-036	50
4	2020-104/000-036	50
5	2020-105/000-036	50
6	2020-106/000-036	25
7	2020-107/000-036	25
8	2020-108/000-036	25
9	2020-109/000-036	25
10	2020-110/000-036	25
11	2020-111/000-036	20
12	2020-112/000-036	20
13	2020-113/000-036	10
14	2020-114/000-036	10
15	2020-115/000-036	10

1-conductor female plug with ground base module (green-yellow), fits into carrier terminal blocks, with coding fingers, gray, blue, green-yellow

Pole No.	Item No.	Pack. Unit
3	2020-103/000-038	50
4	2020-104/000-038	50
5	2020-105/000-038	50
6	2020-106/000-038	25
7	2020-107/000-038	25
8	2020-108/000-038	25
9	2020-109/000-038	25
10	2020-110/000-038	25
11	2020-111/000-038	20
12	2020-112/000-038	20
13	2020-113/000-038	10
14	2020-114/000-038	10
15	2020-115/000-038	10

1-conductor female plug with ground end module (green-yellow), fits into carrier terminal blocks, with coding fingers

Pole No.	Item No.	Pack. Unit
3	2020-103/000-037	50
4	2020-104/000-037	50
5	2020-105/000-037	50
6	2020-106/000-037	25
7	2020-107/000-037	25
8	2020-108/000-037	25
9	2020-109/000-037	25
10	2020-110/000-037	25
11	2020-111/000-037	20
12	2020-112/000-037	20
13	2020-113/000-037	10
14	2020-114/000-037	10
15	2020-115/000-037	10

1-conductor female plug with ground end module (green-yellow), fits into carrier terminal blocks, with coding fingers, green-yellow, blue, gray

Pole No.	Item No.	Pack. Unit
3	2020-103/000-039	50
4	2020-104/000-039	50
5	2020-105/000-039	50
6	2020-106/000-039	25
7	2020-107/000-039	25
8	2020-108/000-039	25
9	2020-109/000-039	25
10	2020-110/000-039	25
11	2020-111/000-039	20
12	2020-112/000-039	20
13	2020-113/000-039	10
14	2020-114/000-039	10
15	2020-115/000-039	10



## X-COM®S-SYSTEM-MINI

### Pre-Assembled 2-Conductor Female Plugs

#### 1 (1.5) mm<sup>2</sup>, 2020 Series

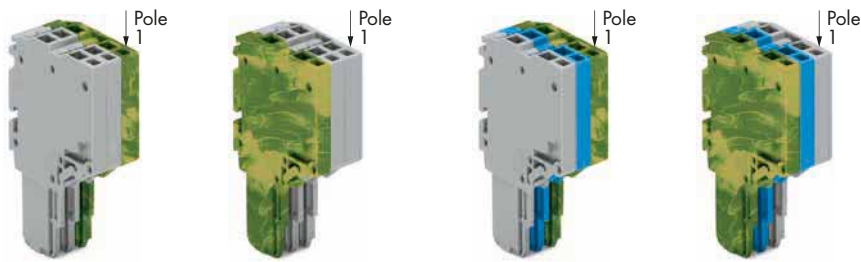

2-conductor female plug with ground base module (green-yellow), fits into carrier terminal blocks, with coding fingers

Pole No.	Item No.	Pack. Unit
3	2020-203/000-036	50
4	2020-204/000-036	50
5	2020-205/000-036	50
6	2020-206/000-036	25
7	2020-207/000-036	25
8	2020-208/000-036	25
9	2020-209/000-036	25
10	2020-210/000-036	25
11	2020-211/000-036	20
12	2020-212/000-036	20
13	2020-213/000-036	10
14	2020-214/000-036	10
15	2020-215/000-036	10

2-conductor female plug with ground base module (green-yellow), fits into carrier terminal blocks, with coding fingers, gray, blue, green-yellow

Pole No.	Item No.	Pack. Unit
3	2020-203/000-038	50
4	2020-204/000-038	50
5	2020-205/000-038	50
6	2020-206/000-038	25
7	2020-207/000-038	25
8	2020-208/000-038	25
9	2020-209/000-038	25
10	2020-210/000-038	25
11	2020-211/000-038	20
12	2020-212/000-038	20
13	2020-213/000-038	10
14	2020-214/000-038	10
15	2020-215/000-038	10

2-conductor female plug with ground end module (green-yellow), fits into carrier terminal blocks, with coding fingers

Pole No.	Item No.	Pack. Unit
3	2020-203/000-037	50
4	2020-204/000-037	50
5	2020-205/000-037	50
6	2020-206/000-037	25
7	2020-207/000-037	25
8	2020-208/000-037	25
9	2020-209/000-037	25
10	2020-210/000-037	25
11	2020-211/000-037	20
12	2020-212/000-037	20
13	2020-213/000-037	10
14	2020-214/000-037	10
15	2020-215/000-037	10

2-conductor female plug with ground end module (green-yellow), fits into carrier terminal blocks, with coding fingers, green-yellow, blue, gray

Pole No.	Item No.	Pack. Unit
3	2020-203/000-039	50
4	2020-204/000-039	50
5	2020-205/000-039	50
6	2020-206/000-039	25
7	2020-207/000-039	25
8	2020-208/000-039	25
9	2020-209/000-039	25
10	2020-210/000-039	25
11	2020-211/000-039	20
12	2020-212/000-039	20
13	2020-213/000-039	10
14	2020-214/000-039	10
15	2020-215/000-039	10





## X-COM®S-SYSTEM-MINI

### Female Plugs for Self-Assembly

#### 1 (1.5) mm<sup>2</sup>, 2020 Series



2

1-conductor end module, with coding finger		
Color	Item No.	Pack. Unit
○ gray	2020-181	250
● blue	2020-184	250
● green-yellow	2020-187	250

2-conductor end module, with coding finger		
Color	Item No.	Pack. Unit
○ gray	2020-281	250
● blue	2020-284	250
● green-yellow	2020-287	250

1-conductor base module with end plate and coding finger		
Color	Item No.	Pack. Unit
○ gray	2020-161	250
● blue	2020-164	250
● green-yellow	2020-167	250

2-conductor base module with end plate and coding finger		
Color	Item No.	Pack. Unit
○ gray	2020-261	250
● blue	2020-264	250
● green-yellow	2020-267	250



**Customizing Modular Female Plugs**

WAGO's modular X-COM®S-SYSTEM female plugs can be customized for applications requiring varying numbers of poles (e.g., when designing prototypes).

**Modules and Pole Numbers**

A customized X-COM®S-SYSTEM-MINI female plug consists of:

- One base module with end plate
- Up to 14 end modules

**Intended Use**

According to EN 61984, pluggable connectors without current interrupting capacity shall not be mated and unmated when live or under load.

**Assembly**

The appropriate mounting tool shall be used in order to guarantee that the individual modules are properly attached to each other without damaging the locking latches.



End module

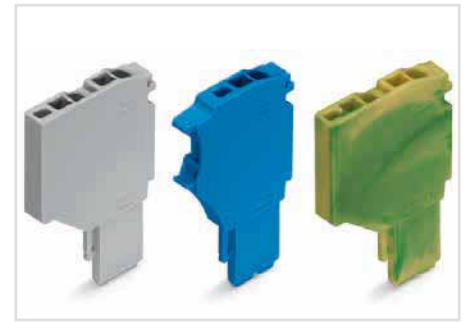

Base module

**Example: 5-Pole, 1-Conductor Female Plug**

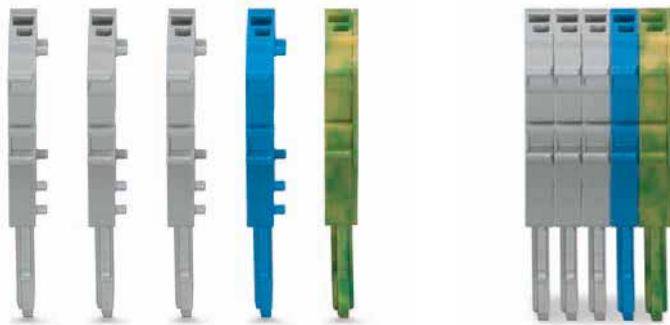

Base module with end plate  
2020-167

End module  
2020-184

End modules  
2020-181

## X-COM®S-SYSTEM-MINI

## 1-Conductor Female Plugs with Locking Levers and Strain Relief Plates

1 (1.5) mm<sup>2</sup>, 2020 Series

2

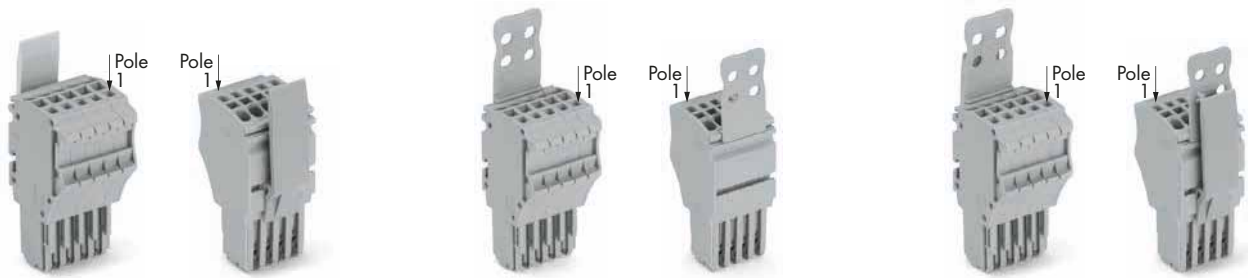

1-conductor female plug with locking lever, fits into carrier terminal blocks, with coding fingers, gray

Pole No.	Item No.	Pack. Unit
○ 2	2020-102/122-000	100
○ 3	2020-103/122-000	50
○ 4	2020-104/124-000	50
○ 5	2020-105/124-000	50
○ 6	2020-106/124-000	25
○ 7	2020-107/124-000	25
○ 8	2020-108/124-000	25
○ 9	2020-109/124-000	25
○ 10	2020-110/125-000	25
○ 11	2020-111/125-000	20
○ 12	2020-112/125-000	20
○ 13	2020-113/125-000	10
○ 14	2020-114/125-000	10
○ 15	2020-115/125-000	10



1-conductor female plug with strain relief plate, fits into carrier terminal blocks, with coding fingers, gray

Pole No.	Item No.	Pack. Unit
○ 2	2020-102/132-000	100
○ 3	2020-103/132-000	50
○ 4	2020-104/133-000	50
○ 5	2020-105/133-000	50
○ 6	2020-106/133-000	25
○ 7	2020-107/134-000	25
○ 8	2020-108/134-000	25
○ 9	2020-109/134-000	25
○ 10	2020-110/135-000	25
○ 11	2020-111/135-000	20
○ 12	2020-112/135-000	20
○ 13	2020-113/135-000	10
○ 14	2020-114/135-000	10
○ 15	2020-115/135-000	10



1-conductor female plug with strain relief plate and locking lever, fits into carrier terminal blocks, with coding fingers, gray

Pole No.	Item No.	Pack. Unit
○ 2	2020-102/142-000	100
○ 3	2020-103/142-000	50
○ 4	2020-104/143-000	50
○ 5	2020-105/143-000	50
○ 6	2020-106/143-000	25
○ 7	2020-107/144-000	25
○ 8	2020-108/144-000	25
○ 9	2020-109/144-000	25
○ 10	2020-110/145-000	25
○ 11	2020-111/145-000	20
○ 12	2020-112/145-000	20
○ 13	2020-113/145-000	10
○ 14	2020-114/145-000	10
○ 15	2020-115/145-000	10



# X-COM®S-SYSTEM-MINI

## 1-Conductor Female Plugs with Locking Levers and Strain Relief Plates

2

Strain Relief Plates (SRP), Gray			Locking Levers (LL), Gray				SRP and LL, Gray	
			Assembled		Assembled		Assembled	
SRP			Pole No.	Quantity	1-Way	2-Way		
Item No.					Item No.		Item No.	
Suffix					Suffix		Suffix	
Item No.	Color	Width						
734-327	gray	6mm	/132-0xx	2 to 3	1	/122-0xx	-	/142-0xx
734-328	gray	12.5mm	/133-0xx	4 to 6	1	-	/124-0xx	/143-0xx
734-329	gray	25mm	/134-0xx	7 to 9	1	-	/124-0xx	/144-0xx
734-326	gray	35mm	/135-0xx	10 to 15	2	-	/125-0xx	/145-0xx

For colored female plugs, the item number suffix "xx" must be replaced by the blue "-006" and the green-yellow "-016" color suffix.

Dimensions of locking levers

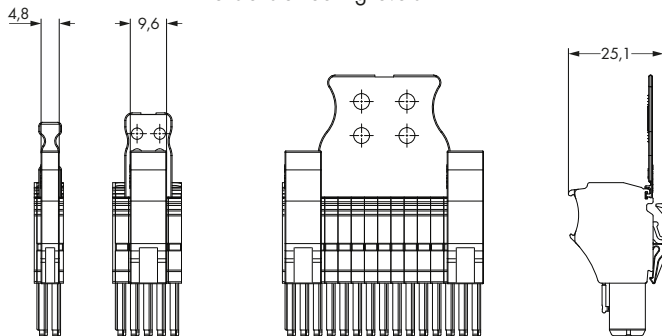

Description	Color	Item No.	Suffix No.
1-conductor female plug	gray	2020-102	none
2- to 15-pole	blue green-yellow	to 2020-115	/000-006 /000-016

Dimensions of strain relief plates

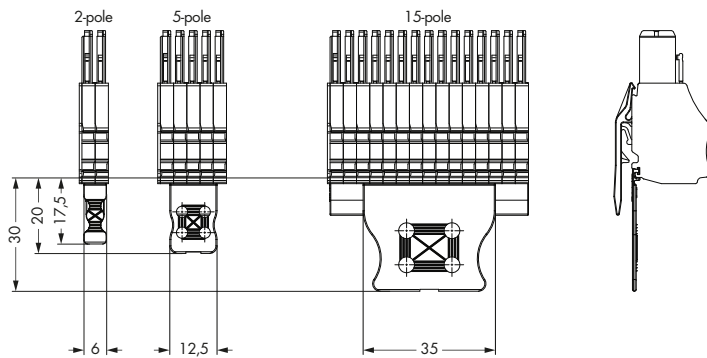

## X-COM®S-SYSTEM-MINI

## 2-Conductor Female Plugs with Locking Levers and Strain Relief Plates

1 (1.5) mm<sup>2</sup>, 2020 Series

2

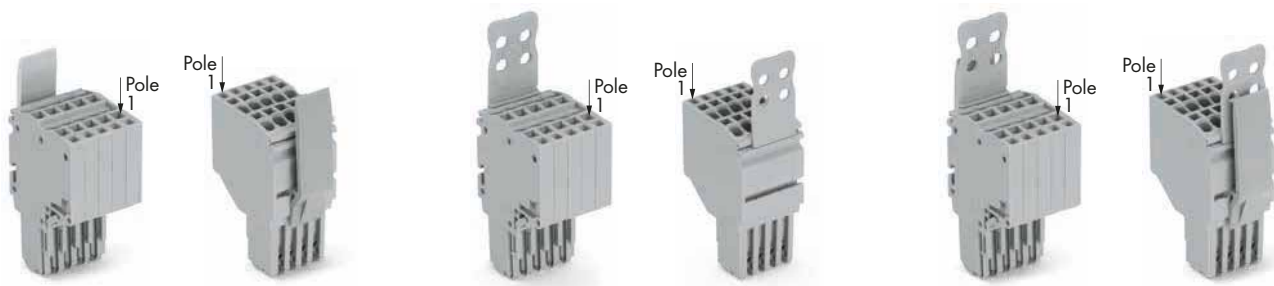

2-conductor female plug with locking lever, fits into carrier terminal blocks, with coding fingers, gray

Pole No.	Item No.	Pack. Unit
○ 2	2020-202/122-000	100
○ 3	2020-203/122-000	50
○ 4	2020-204/124-000	50
○ 5	2020-205/124-000	50
○ 6	2020-206/124-000	25
○ 7	2020-207/124-000	25
○ 8	2020-208/124-000	25
○ 9	2020-209/124-000	25
○ 10	2020-210/125-000	25
○ 11	2020-211/125-000	20
○ 12	2020-212/125-000	20
○ 13	2020-213/125-000	10
○ 14	2020-214/125-000	10
○ 15	2020-215/125-000	10



2-conductor female plug with strain relief plate, fits into carrier terminal blocks, with coding fingers, gray

Pole No.	Item No.	Pack. Unit
○ 2	2020-202/132-000	100
○ 3	2020-203/132-000	50
○ 4	2020-204/133-000	50
○ 5	2020-205/133-000	50
○ 6	2020-206/133-000	25
○ 7	2020-207/134-000	25
○ 8	2020-208/134-000	25
○ 9	2020-209/134-000	25
○ 10	2020-210/135-000	25
○ 11	2020-211/135-000	20
○ 12	2020-212/135-000	20
○ 13	2020-213/135-000	10
○ 14	2020-214/135-000	10
○ 15	2020-215/135-000	10



2-conductor female plug with strain relief plate and locking lever, fits into carrier terminal blocks, with coding fingers, gray

Pole No.	Item No.	Pack. Unit
○ 2	2020-202/142-000	100
○ 3	2020-203/142-000	50
○ 4	2020-204/143-000	50
○ 5	2020-205/143-000	50
○ 6	2020-206/143-000	25
○ 7	2020-207/144-000	25
○ 8	2020-208/144-000	25
○ 9	2020-209/144-000	25
○ 10	2020-210/145-000	25
○ 11	2020-211/145-000	20
○ 12	2020-212/145-000	20
○ 13	2020-213/145-000	10
○ 14	2020-214/145-000	10
○ 15	2020-215/145-000	10



# X-COM®S-SYSTEM-MINI

## 2-Conductor Female Plugs with Locking Levers and Strain Relief Plates

2

Strain Relief Plates (SRP), Gray			Locking Levers (LL), Gray				SRP and LL, Gray	
			Assembled		Assembled		Assembled	
SRP			Pole No.	Quantity	1-Way	2-Way		
Item No.					Item No.		Item No.	
Suffix					Suffix		Suffix	
Item No.	Color	Width						
734-327	gray	6mm	/132-0xx	2 to 3	1	/122-0xx	-	/142-0xx
734-328	gray	12.5mm	/133-0xx	4 to 6	1	-	/124-0xx	/143-0xx
734-329	gray	25mm	/134-0xx	7 to 9	1	-	/124-0xx	/144-0xx
734-326	gray	35mm	/135-0xx	10 to 15	2	-	/125-0xx	/145-0xx

For colored female plugs, the item number suffix "xx" must be replaced by the blue "-006" and the green-yellow "-016" color suffix.

Dimensions of locking levers

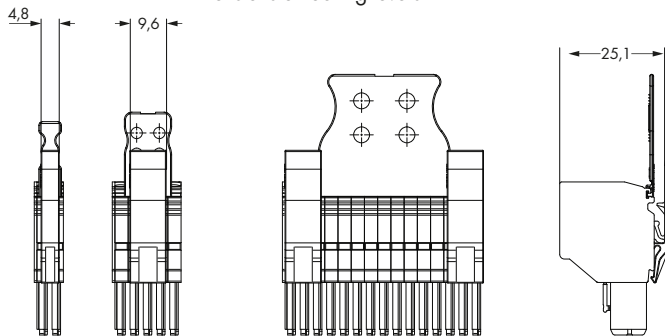

Description	Color	Item No.	Suffix No.
2-conductor female plug	gray	2020-202	none
2- to 15-pole	blue	to	/000-006
	green-yellow	2020-215	/000-016

Dimensions of strain relief plates

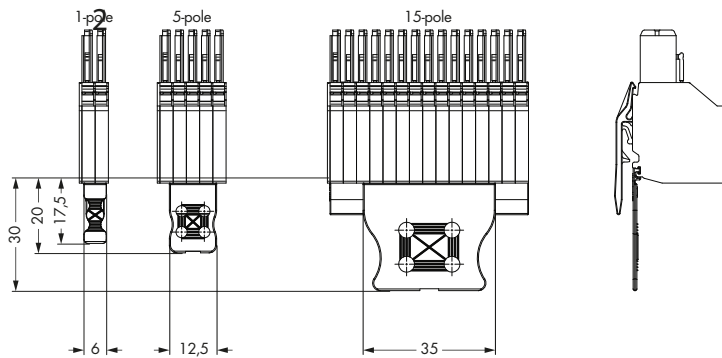



## X-COM®S-SYSTEM – 1-Conductor/1-Pin, 2-Conductor/1-Pin and 2-Conductor/2-Pin Carrier Terminal Blocks 2.5 (4) mm<sup>2</sup>, 2022 Series

2

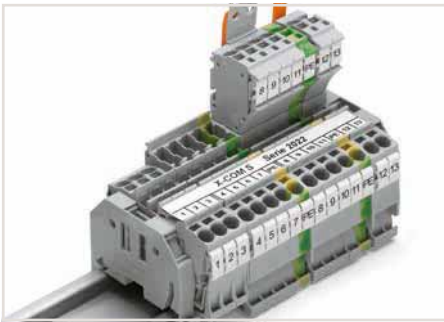

2022 Series X-COM®S-SYSTEM Carrier Terminal Blocks combined with 2002 Series Through Terminal Blocks

Current-carrying capacity curves upon request

### Note:

When used as intended, female plugs shall not be connected/disconnected when live or under load.

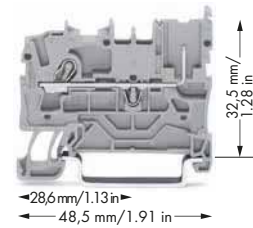

1-conductor/1-pin carrier terminal block, for DIN-35 rail, per EN 60715

Color	Item No.	Pack. Unit
gray	2022-1201	100
blue	2022-1204	100
orange	2022-1202	100

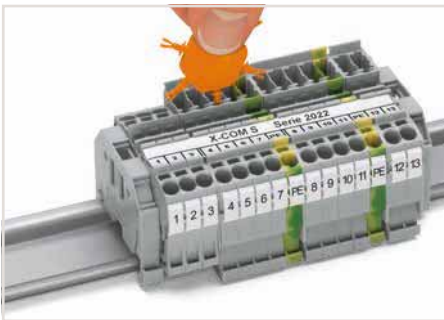

Insert coding pin into the corresponding slot and twist it off.

### Technical Data

Ratings per	IEC/EN 60947-7-1
Rated voltage (III / 3)	690 V
Rated surge voltage (III / 3)	6 kV
Rated current	24 A
Rated current (2)	32 A
Approval	600 V, 20 A ; 600 V, 20 A
Nominal cross section	2.5 mm <sup>2</sup>
<b>Connection Data</b>	
Solid conductor	0.25 ... 4 mm <sup>2</sup> / 22 ... 12 AWG
Solid conductor, push-in termination	0.75 ... 4 mm <sup>2</sup> / 18 ... 12 AWG
Fine-stranded conductor	0.25 ... 4 mm <sup>2</sup> / 22 ... 12 AWG
Fine-stranded conductor with ferrule, push-in termination, min.	0.75 mm <sup>2</sup> / 18 AWG
Strip length	10 ... 12 mm / 0.39 ... 0.47 inch
Terminal block width	5.2 mm / 0.205 inch
Insulation material	Polyamide 66 (PA 66)

### Accessories (Selection)

Push-in type jumper bar, insulated, I <sub>n</sub> 25 A, light gray
End and intermediate plate, 1 mm thick
WMB Inline, plain, 1,500 WMB markers (5 mm) per reel, 5 ... 5.2 mm stretchable
Marking strip, plain, 11 mm wide, 50 m reel
Test pin, 1 mm Ø, with solder connection for test cable

	Item No.	Page
2-way	2002-402	224
orange	2022-1292	226
white	2009-115	780
white	2009-110	783
	859-500	225

Accessories (jumpers, end plates, test plugs, etc.), see page 224

Female plugs, see page 207

Carrier rails and tools, see Section 13

Appropriate marking system, WMB/WMB Inline/marketing strips, see Full Line Catalog, Volume 6

Approvals and corresponding ratings, visit [www.wago.com](http://www.wago.com)

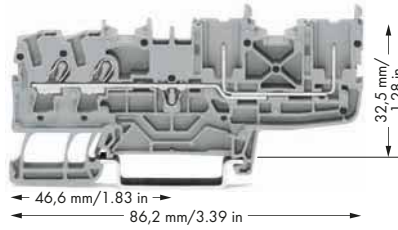
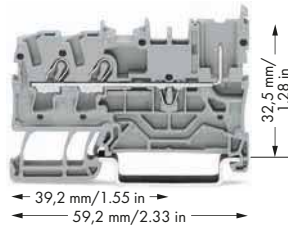

2-conductor/1-pin carrier terminal block, for DIN-35 rail, per EN 60715

Color	Item No.	Pack. Unit
gray	2022-1301	100
blue	2022-1304	100
orange	2022-1302	100



IEC/EN 60947-7-1
690 V
6 kV
24 A
32 A
600 V, 20 A ; 600 V, 20 A
2.5 mm <sup>2</sup>
0.25 ... 4 mm <sup>2</sup> / 22 ... 12 AWG
0.75 ... 4 mm <sup>2</sup> / 18 ... 12 AWG
0.25 ... 4 mm <sup>2</sup> / 22 ... 12 AWG
0.75 mm <sup>2</sup> / 18 AWG
10 ... 12 mm / 0.39 ... 0.47 inch
5.2 mm / 0.205 inch
Polyamide 66 (PA 66)

	Item No.	Page
2-way	2002-402	224
orange	2022-1392	226
white	2009-115	780
white	2009-110	783
	859-500	225

2-conductor/2-pin carrier terminal block, for DIN-35 rail, per EN 60715

Color	Item No.	Pack. Unit
gray	2022-1401	50
blue	2022-1404	50
orange	2022-1402	50



IEC/EN 60947-7-1
690 V
6 kV
24 A
28 A
600 V, 20 A ; 600 V, 20 A
2.5 mm <sup>2</sup>
0.25 ... 4 mm <sup>2</sup> / 22 ... 12 AWG
0.75 ... 4 mm <sup>2</sup> / 18 ... 12 AWG
0.25 ... 4 mm <sup>2</sup> / 22 ... 12 AWG
0.75 mm <sup>2</sup> / 18 AWG
10 ... 12 mm / 0.39 ... 0.47 inch
5.2 mm / 0.205 inch
Polyamide 66 (PA 66)

	Item No.	Page
2-way	2002-402	224
orange	2022-1492	226
white	2009-115	780
white	2009-110	783
	859-500	225

## X-COM®S-SYSTEM – 1-Conductor/1-Pin, 2-Conductor/1-Pin and 2-Conductor/2-Pin Ground Carrier Terminal Blocks

### 2.5 (4) mm<sup>2</sup>, 2022 Series

2

**Note:**

When used as intended, female plugs shall not be connected/disconnected when live or under load.

An appropriate end plate must be applied to the carrier terminal blocks after each female plug.

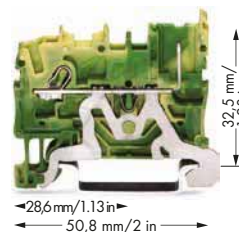

1-conductor/1-pin ground carrier terminal block, for DIN-35 rail, per EN 60715

Color	Item No.	Pack. Unit
● green-yellow	2022-1207	100

**Technical Data**

Ratings per	IEC/EN 60947-7-2
Nominal cross section	2.5 mm <sup>2</sup>
<b>Connection Data</b>	
Solid conductor	0.25 ... 4 mm <sup>2</sup> / 22 ... 12 AWG
Solid conductor, push-in termination	0.75 ... 4 mm <sup>2</sup> / 18 ... 12 AWG
Fine-stranded conductor	0.25 ... 4 mm <sup>2</sup> / 22 ... 12 AWG
Fine-stranded conductor with ferrule, push-in termination, min.	0.75 mm <sup>2</sup> / 18 AWG
Strip length	10 ... 12 mm / 0.39 ... 0.47 inch
Terminal block width	5.2 mm / 0.205 inch
Insulation material	Polyamide 66 (PA 66)

**Accessories (Selection)**

	Item No.	Page
Push-in type jumper bar, insulated, I <sub>N</sub> 25 A, light gray	2002-402	224
End and intermediate plate, 1 mm thick	orange	2022-1292
WMB Inline, plain, 1,500 WMB markers (5 mm) per reel, 5 ... 5.2 mm stretchable	white	2009-115
Marking strip, plain, 11 mm wide, 50 m reel	white	2009-110
Test pin, 1 mm Ø, with solder connection for test cable	859-500	225

📖 Accessories (jumpers, end plates, test plugs, etc.), see page 224

📖 Female plugs, see page 207

📖 Carrier rails and tools, see Section 13

📖 Appropriate marking system, WMB/WMB Inline/marketing strips, see Full Line Catalog, Volume 6

📖 Approvals and corresponding ratings, visit [www.wago.com](http://www.wago.com)

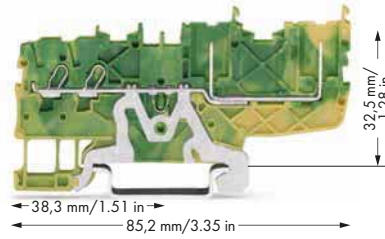
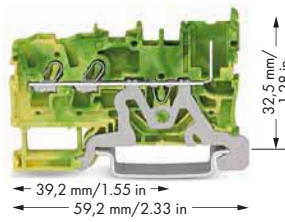

2-conductor/1-pin ground carrier terminal block, for DIN-35 rail, per EN 60715

Color	Item No.	Pack. Unit
● green-yellow	2022-1307	100

2-conductor/2-pin ground carrier terminal block, for DIN-35 rail, per EN 60715

Color	Item No.	Pack. Unit
● green-yellow	2022-1407	50



IEC/EN 60947-7-2
2.5 mm <sup>2</sup>
0.25 ... 4 mm <sup>2</sup> / 22 ... 12 AWG
0.75 ... 4 mm <sup>2</sup> / 18 ... 12 AWG
0.25 ... 4 mm <sup>2</sup> / 22 ... 12 AWG
0.75 mm <sup>2</sup> / 18 AWG
10 ... 12 mm / 0.39 ... 0.47 inch
5.2 mm / 0.205 inch
Polyamide 66 (PA 66)

IEC/EN 60947-7-2
2.5 mm <sup>2</sup>
0.25 ... 4 mm <sup>2</sup> / 22 ... 12 AWG
0.75 ... 4 mm <sup>2</sup> / 18 ... 12 AWG
0.25 ... 4 mm <sup>2</sup> / 22 ... 12 AWG
0.75 mm <sup>2</sup> / 18 AWG
10 ... 12 mm / 0.39 ... 0.47 inch
5.2 mm / 0.205 inch
Polyamide 66 (PA 66)

	Item No.	Page
2-way	2002-402	224
orange	2022-1392	226
white	2009-115	780
white	2009-110	783
	859-500	

	Item No.	Page
2-way	2002-402	224
orange	2022-1492	226
white	2009-115	780
white	2009-110	783
	859-500	225

## X-COM®S-SYSTEM

### Double-Deck Terminal Blocks

#### 2.5 (4) mm<sup>2</sup>, 2022 Series



Size comparison:  
Double-deck carrier terminal blocks with 3.5 mm and 5.2 mm terminal block widths

#### Note:

When used as intended, female plugs shall not be connected/disconnected when live or under load.

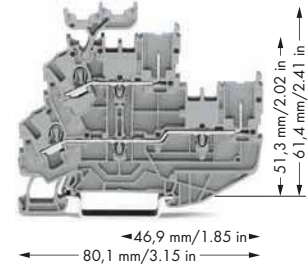

1-conductor/1-pin double-deck carrier terminal block, through/through terminal block, with marker carrier

	Item No.	Pack. Unit
○ L/L	2022-2231	50
○ N/L	2022-2232	50
○ L/N	2022-2233	50
● N/N	2022-2234	50

1-conductor/1-pin double-deck carrier block, through/through terminal block, without marker carrier

	Item No.	Pack. Unit
○ L/L	2022-2201	50
○ N/L	2022-2202	50
○ L/N	2022-2203	50
● N/N	2022-2204	50



#### Technical Data

Ratings per	IEC/EN 60947-7-1
Rated voltage (III / 3)	690 V
Rated surge voltage (III / 3)	6 kV
Rated current	24 A
Rated current (2)	28 A
Approval	600 V, 20 A ; 600 V, 20 A
Nominal cross section	2.5 mm <sup>2</sup>

#### Connection Data

Solid conductor	0.25 ... 4 mm <sup>2</sup> / 22 ... 12 AWG
Solid conductor, push-in termination	0.75 ... 4 mm <sup>2</sup> / 18 ... 12 AWG
Fine-stranded conductor	0.25 ... 4 mm <sup>2</sup> / 22 ... 12 AWG
Fine-stranded conductor with ferrule, push-in termination, min.	0.5 mm <sup>2</sup> / 20 AWG
Strip length	10 ... 12 mm / 0.39 ... 0.47 inch
Terminal block width	5.2 mm / 0.205 inch
Insulation material	Polyamide 66 (PA 66)

#### Accessories (Selection)

Push-in type jumper bar, insulated, I <sub>n</sub> 25 A, light gray	
End and intermediate plate, 1 mm thick	
WMB Inline, plain, 1,500 WMB markers (5 mm) per reel, 5 ... 5.2 mm stretchable	
Marking strip, plain, 11 mm wide, 50 m reel	
Test pin, 1 mm Ø, with solder connection for test cable	

	Item No.	Page
2-way	2002-402	224
orange	2022-2292	226
white	2009-115	780
white	2009-110	783
	859-500	225

Accessories (jumpers, end plates, test plugs, etc.), see page 224

Female plugs, see page 207

Carrier rails and tools, see Section 13

Appropriate marking system, WMB/WMB Inline/markings strips, see Full Line Catalog, Volume 6

Approvals and corresponding ratings, visit [www.wago.com](http://www.wago.com)

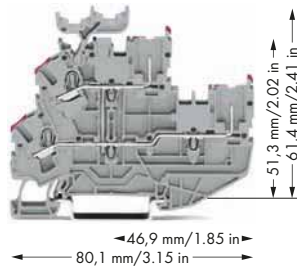

2-conductor/2-pin double-deck carrier terminal block, 2-conductor/2-pin through terminal block, with marker carrier, internally commoned, violet conductor entry, blue housing

	Item No.	Pack. Unit
○ L	2022-2238	50
● N	2022-2239	50

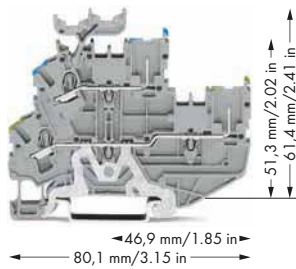

1-conductor/1-pin double-deck carrier terminal block, ground conductor/through terminal block, with marker carrier

	Item No.	Pack. Unit
○ PE/N	2022-2247	50
○ PE/L	2022-2257	50

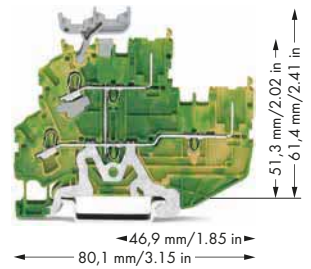

2-conductor/2-pin double-deck carrier block, 2-conductor/2-pin ground conductor block, with marker carrier, internally commoned

	Item No.	Pack. Unit
● PE	2022-2237	50

2-conductor/2-pin double-deck carrier terminal block, 2-conductor/2-pin through terminal block, without marker carrier, internally commoned, violet conductor entry, blue housing

	Item No.	Pack. Unit
○ L	2022-2208	50
● N	2022-2209	50

1-conductor/1-pin double-deck carrier terminal block, ground conductor/through terminal block, without marker carrier

	Item No.	Pack. Unit
○ PE/N	2022-2217	50
○ PE/L	2022-2227	50

2-conductor/2-pin double-deck carrier block, 2-conductor/2-pin ground conductor block, without marker carrier, internally commoned

	Item No.	Pack. Unit
● PE	2022-2207	50



IEC/EN 60947-7-1
690 V
6 kV
24 A
28 A
600 V, 20 A ; 600 V, 20 A
2.5 mm <sup>2</sup>

0.25 ... 4 mm <sup>2</sup> / 22 ... 12 AWG
0.75 ... 4 mm <sup>2</sup> / 18 ... 12 AWG
0.25 ... 4 mm <sup>2</sup> / 22 ... 12 AWG
0.5 mm <sup>2</sup> / 20 AWG

10 ... 12 mm / 0.39 ... 0.47 inch
5.2 mm / 0.205 inch
Polyamide 66 (PA 66)

	Item No.	Page
2-way	2002-402	224
orange	2022-2292	226
white	2009-115	780
white	2009-110	783
	859-500	225



IEC/EN 60947-7-1
690 V
6 kV
24 A
28 A
600 V, 20 A ; 600 V, 20 A
2.5 mm <sup>2</sup>

0.25 ... 4 mm <sup>2</sup> / 22 ... 12 AWG
0.75 ... 4 mm <sup>2</sup> / 18 ... 12 AWG
0.25 ... 4 mm <sup>2</sup> / 22 ... 12 AWG
0.5 mm <sup>2</sup> / 20 AWG

10 ... 12 mm / 0.39 ... 0.47 inch
5.2 mm / 0.205 inch
Polyamide 66 (PA 66)

	Item No.	Page
2-way	2002-402	224
orange	2022-2292	226
white	2009-115	780
white	2009-110	783
	859-500	225



IEC/EN 60947-7-2
690 V
6 kV
24 A
28 A
600 V, 20 A ; 600 V, 20 A
2.5 mm <sup>2</sup>

0.25 ... 4 mm <sup>2</sup> / 22 ... 12 AWG
0.75 ... 4 mm <sup>2</sup> / 18 ... 12 AWG
0.25 ... 4 mm <sup>2</sup> / 22 ... 12 AWG
0.5 mm <sup>2</sup> / 20 AWG

10 ... 12 mm / 0.39 ... 0.47 inch
5.2 mm / 0.205 inch
Polyamide 66 (PA 66)

	Item No.	Page
2-way	2002-402	224
orange	2022-2292	226
white	2009-115	780
white	2009-110	783
	859-500	225



## X-COM®S-SYSTEM

### Carrier Terminal Blocks and 1-Conductor Female Plugs Assembly Types

2



1-conductor female plug  
Carrier terminal blocks can be commoned via 2002 Series Push-In Type Jumper Bars and tested via 859-500 Test Pin.

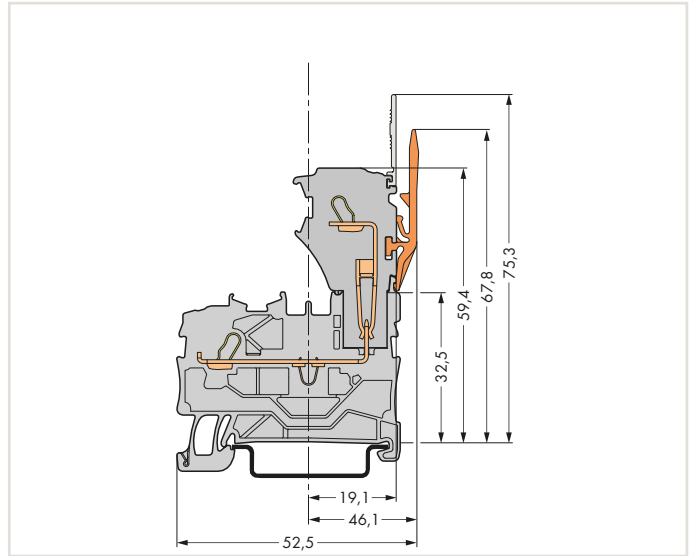

Carrier terminal block



X-COM®S-SYSTEM terminal block assembly

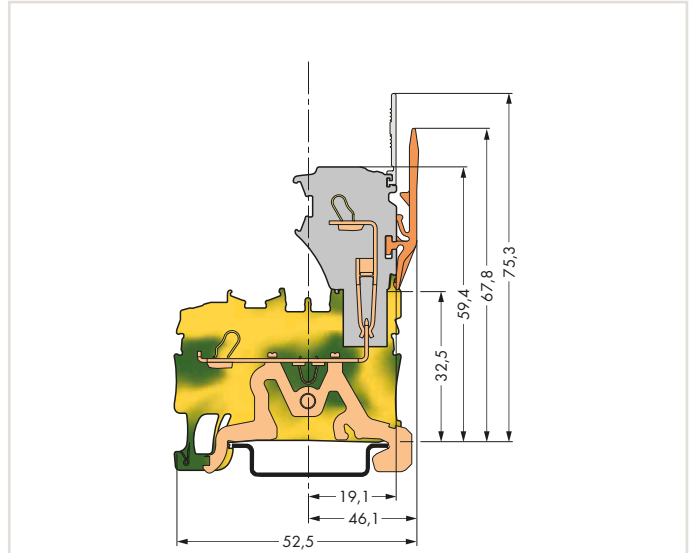

Ground carrier terminal block

## X-COM®S-SYSTEM

### Double-Deck Carrier Terminal Blocks and 1-Conductor Female Plugs Assembly Types

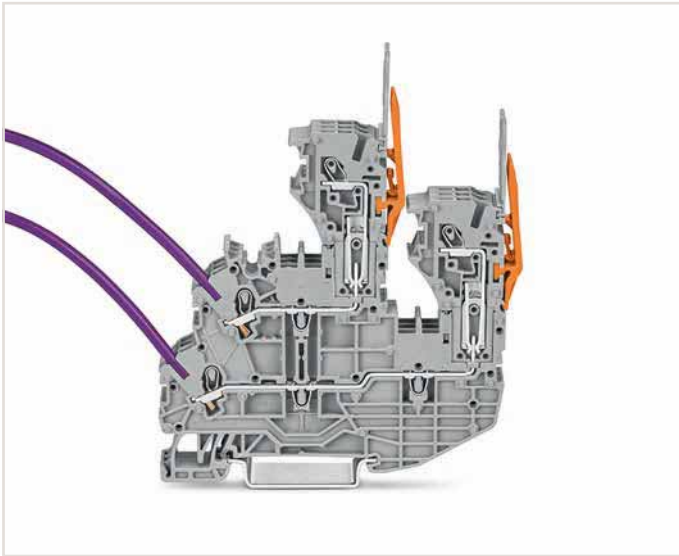

1-conductor female plug

Double-deck carrier terminal blocks can be commoned via 2002 Series Push-In Type Jumper Bars and tested via 859-500 Test Pin.

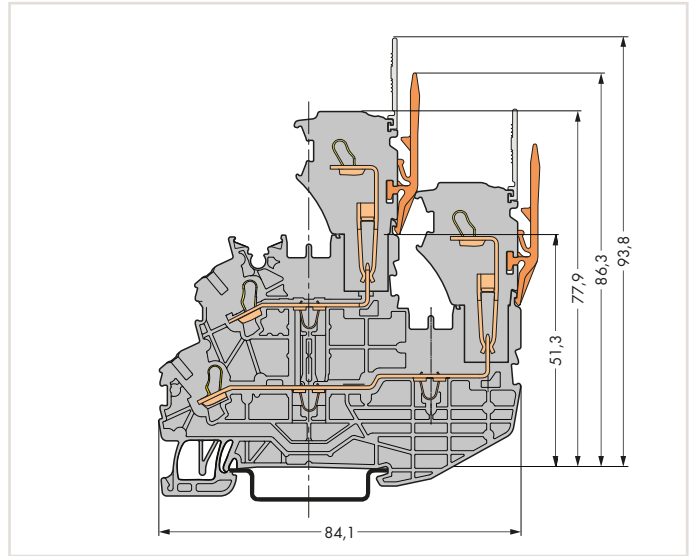

Double-deck carrier terminal block with 1-conductor female plug

2

## X-COM®S-SYSTEM

## 1- and 2-Conductor Female Plugs

2.5 (4) mm<sup>2</sup>, 2022 Series

Coding a female plug: remove coding finger using a suitable tool.

## Technical Data

Ratings per	IEC/EN 61984
Rated voltage (III / 3)	690 V
Rated surge voltage (III / 3)	6 kV
Rated current	24 A
<b>Connection Data</b>	
Connection technology	Push-in CAGE CLAMP®
Solid conductor	0.25 ... 4 mm <sup>2</sup> / 22 ... 12 AWG
Solid conductor, push-in termination	0.75 ... 4 mm <sup>2</sup> / 18 ... 12 AWG
Fine-stranded conductor	0.25 ... 4 mm <sup>2</sup> / 22 ... 12 AWG
Fine-stranded conductor with ferrule, push-in termination, min.	0.75 mm <sup>2</sup> / 18 AWG
Nominal cross section	2.5 mm <sup>2</sup>
Strip length	9 ... 11 mm / 0.35 ... 0.43 inch
Approval	300 V, 10 A ; 300 V, 10 A
Module width	5.2 mm / 0.205 inch
Insulation material	Polyamide 66 (PA 66)

## Item no. suffixes for female plugs

blue .../000-006  
green-yellow .../000-016

Current-carrying capacity curves, visit [www.wago.com](http://www.wago.com)

## Note:

According to EN 61984, pluggable connectors without current interrupting capacity shall not be mated and unmated when live or under load.

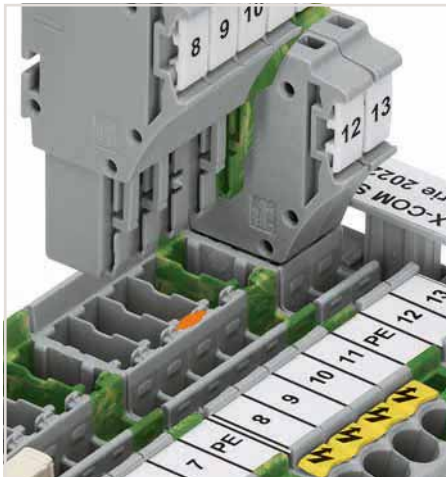

Insert a coding pin (2022-100) into the corresponding location of the carrier terminal block.

Accessories for female plugs, see page 227

Appropriate marking system, WMB/WMB Inline/marketing strips, see Full Line Catalog, Volume 6

Approvals and corresponding ratings, visit [www.wago.com](http://www.wago.com)

## Accessories (Selection)

	Item No.	Page
WMB Inline, plain, 1,500 WMB markers (5 mm) per reel, 5 ... 5.2 mm stretchable	2009-115	780
Marking strip, plain, 11 mm wide, 50 m reel	2009-110	783
Protective warning marker, with black high-voltage symbol, for 5 terminal blocks	2002-115	226
Strain relief plate, gray	734-326	225
Locking lever Width 4.8 mm	2022-142	225

# X-COM®S-SYSTEM

## 1- and 2-Conductor Female Plugs

### 2.5 (4) mm², 2022 Series

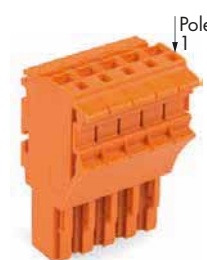
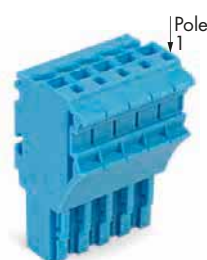

2

Dimensions (in mm):

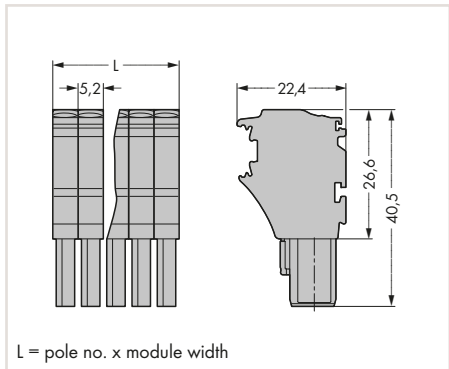

Dimensions (in mm):

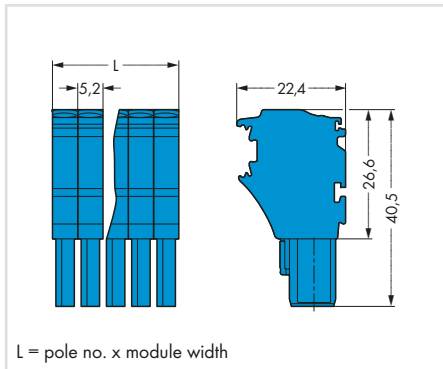

Dimensions (in mm):

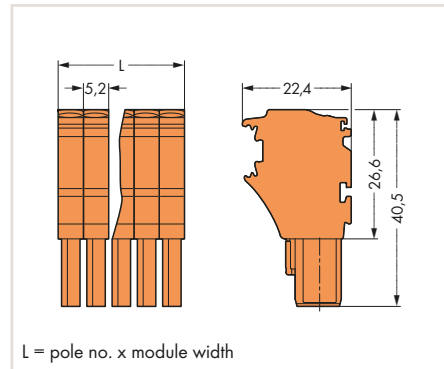

1-conductor female plug, fits into carrier terminal blocks, with coding fingers, gray

Pole No.	Item No.	Pack. Unit
1	2022-101	200
2	2022-102	200
3	2022-103	100
4	2022-104	100
5	2022-105	50
6	2022-106	50
7	2022-107	50
8	2022-108	50
9	2022-109	50
10	2022-110	25
11	2022-111	25
12	2022-112	25
13	2022-113	25
14	2022-114	25
15	2022-115	25

1-conductor female plug, fits into carrier terminal blocks, with coding fingers, blue

Pole No.	Item No.	Pack. Unit
1	2022-101/000-006	200
2	2022-102/000-006	200
3	2022-103/000-006	100
4	2022-104/000-006	100
5	2022-105/000-006	50
6	2022-106/000-006	50
7	2022-107/000-006	50
8	2022-108/000-006	50
9	2022-109/000-006	50
10	2022-110/000-006	25
11	2022-111/000-006	25
12	2022-112/000-006	25
13	2022-113/000-006	25
14	2022-114/000-006	25
15	2022-115/000-006	25

1-conductor female plug, fits into carrier terminal blocks, with coding fingers, orange

Pole No.	Item No.	Pack. Unit
1	2022-101/000-012	200
2	2022-102/000-012	200
3	2022-103/000-012	100
4	2022-104/000-012	100
5	2022-105/000-012	50
6	2022-106/000-012	50
7	2022-107/000-012	50
8	2022-108/000-012	50
9	2022-109/000-012	50
10	2022-110/000-012	25
11	2022-111/000-012	25
12	2022-112/000-012	25
13	2022-113/000-012	25
14	2022-114/000-012	25
15	2022-115/000-012	25

1-conductor female plug, fits into carrier terminal blocks, with coding fingers, green-yellow

Pole No.	Item No.	Pack. Unit
1	2022-101/000-016	200
2	2022-102/000-016	200



## X-COM®S-SYSTEM

### 1-Conductor Female Plugs

#### 2.5 (4) mm<sup>2</sup>, 2022 Series

2

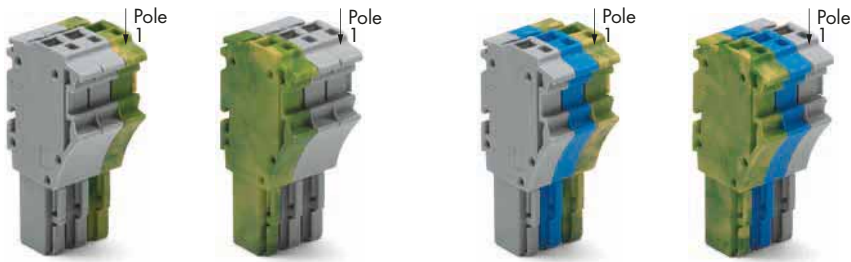

1-conductor female plug with ground base module (green-yellow), fits into carrier terminal blocks, with coding fingers

Pole No.	Item No.	Pack. Unit
3	2022-103/000-036	100
4	2022-104/000-036	100
5	2022-105/000-036	50
6	2022-106/000-036	50
7	2022-107/000-036	50
8	2022-108/000-036	50
9	2022-109/000-036	50
10	2022-110/000-036	25
11	2022-111/000-036	25
12	2022-112/000-036	25
13	2022-113/000-036	25
14	2022-114/000-036	25
15	2022-115/000-036	25

1-conductor female plug with ground base module (green-yellow), fits into carrier terminal blocks, with coding fingers, gray, blue, green-yellow

Pole No.	Item No.	Pack. Unit
3	2022-103/000-038	100
4	2022-104/000-038	100
5	2022-105/000-038	50
6	2022-106/000-038	50
7	2022-107/000-038	50
8	2022-108/000-038	50
9	2022-109/000-038	50
10	2022-110/000-038	25
11	2022-111/000-038	25
12	2022-112/000-038	25
13	2022-113/000-038	25
14	2022-114/000-038	25
15	2022-115/000-038	25

1-conductor female plug with ground end module (green-yellow), fits into carrier terminal blocks, with coding fingers

Pole No.	Item No.	Pack. Unit
3	2022-103/000-037	100
4	2022-104/000-037	100
5	2022-105/000-037	50
6	2022-106/000-037	50
7	2022-107/000-037	50
8	2022-108/000-037	50
9	2022-109/000-037	50
10	2022-110/000-037	25
11	2022-111/000-037	25
12	2022-112/000-037	25
13	2022-113/000-037	25
14	2022-114/000-037	25
15	2022-115/000-037	25

1-conductor female plug with ground end module (green-yellow), fits into carrier terminal blocks, with coding fingers, green-yellow, blue, gray

Pole No.	Item No.	Pack. Unit
3	2022-103/000-039	100
4	2022-104/000-039	100
5	2022-105/000-039	50
6	2022-106/000-039	50
7	2022-107/000-039	50
8	2022-108/000-039	50
9	2022-109/000-039	50
10	2022-110/000-039	25
11	2022-111/000-039	25
12	2022-112/000-039	25
13	2022-113/000-039	25
14	2022-114/000-039	25
15	2022-115/000-039	25







**X-COM®S-SYSTEM****1-Conductor Female Plugs for Self-Assembly**  
2.5 (4) mm<sup>2</sup>, 2022 Series

2

**1-conductor end module, with coding finger**

Color	Item No.	Pack. Unit
○ gray	2022-181	250
● blue	2022-184	250
● orange	2022-182	250
● green-yellow	2022-187	250

**1-conductor center module, with coding finger**

Color	Item No.	Pack. Unit
○ gray	2022-171	250
● blue	2022-174	250
● orange	2022-172	250
● green-yellow	2022-177	250

**1-conductor base module with integrated end plate and coding finger**

Color	Item No.	Pack. Unit
○ gray	2022-161	250
● blue	2022-164	250
● orange	2022-162	250
● green-yellow	2022-167	250



**Customizing Modular Female Plugs**

WAGO's modular X-COM®S-SYSTEM female plugs can be customized for applications requiring varying numbers of poles (e.g., when designing prototypes).

**Modules and Pole Numbers**

A customized X-COM®S-SYSTEM-MINI female plug consists of:

- One base module with an integrated end plate
- Up to 13 center modules (corresponding to a 15-pole female plug = maximum pole number)
- One end module

**Intended Use**

According to EN 61984, pluggable connectors without current interrupting capacity shall not be mated and unmated when live or under load.

**Assembly**

The appropriate mounting tool shall be used in order to guarantee that the individual modules are properly attached to each other without damaging the locking latches.



End module



Center module

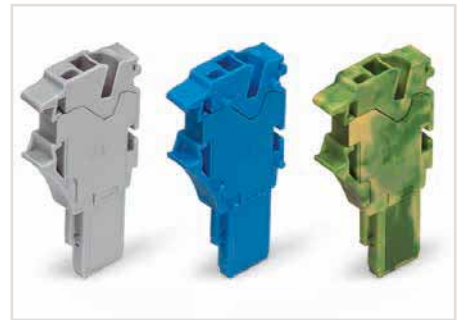

Base module

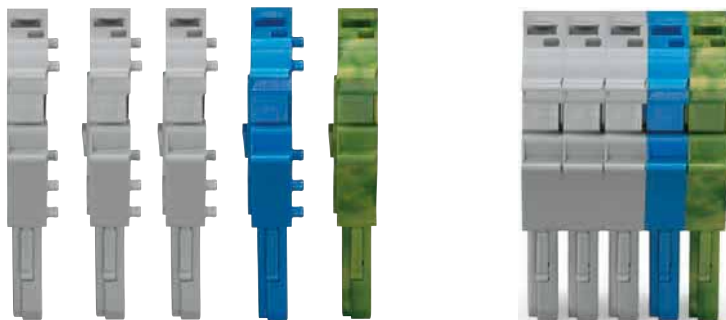
**Example: 5-Pole, 1-Conductor Female Plug**

Base module with integrated end plate  
2022-167

Center module  
2022-174

Center modules  
2022-171

End module  
2022-181

## X-COM®S-SYSTEM

### 1-Conductor Female Plugs with Locking Levers and Strain Relief Plates

2.5 (4) mm<sup>2</sup>, 2022 Series

2

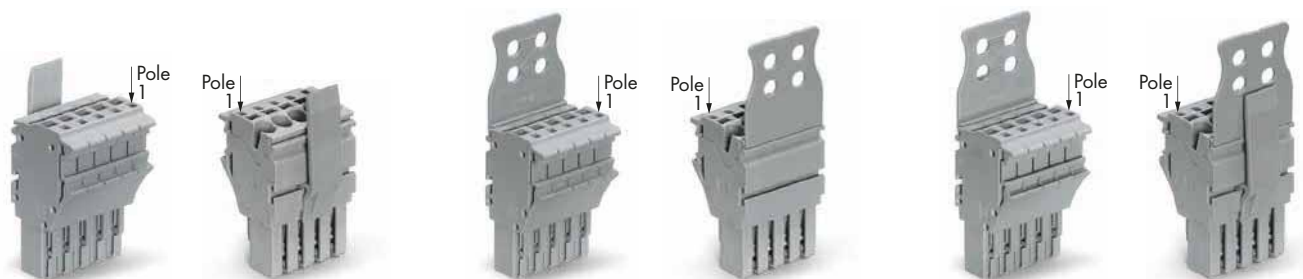

1-conductor female plug with locking lever, fits into carrier terminal blocks, with coding fingers, gray

Pole No.	Item No.	Pack. Unit
○ 1	2022-101/122-000	200
○ 2	2022-102/122-000	100
○ 3	2022-103/123-000	100
○ 4	2022-104/123-000	50
○ 5	2022-105/123-000	50
○ 6	2022-106/123-000	50
○ 7	2022-107/123-000	25
○ 8	2022-108/123-000	25
○ 9	2022-109/123-000	25
○ 10	2022-110/123-000	25
○ 11	2022-111/125-000	25
○ 12	2022-112/126-000	20
○ 13	2022-113/126-000	20
○ 14	2022-114/126-000	15
○ 15	2022-115/127-000	15

1-conductor female plug with strain relief plate, fits into carrier terminal blocks, with coding fingers, gray

Pole No.	Item No.	Pack. Unit
○ 1	2022-101/132-000	200
○ 2	2022-102/132-000	100
○ 3	2022-103/133-000	100
○ 4	2022-104/133-000	50
○ 5	2022-105/134-000	50
○ 6	2022-106/134-000	50
○ 7	2022-107/135-000	25
○ 8	2022-108/135-000	25
○ 9	2022-109/135-000	25
○ 10	2022-110/135-000	25
○ 11	2022-111/136-000	25
○ 12	2022-112/136-000	20
○ 13	2022-113/136-000	20
○ 14	2022-114/136-000	15
○ 15	2022-115/137-000	15

1-conductor female plug with strain relief plate and locking lever, fits into carrier terminal blocks, with coding fingers, gray

Pole No.	Item No.	Pack. Unit
○ 1	2022-101/142-000	200
○ 2	2022-102/142-000	100
○ 3	2022-103/143-000	100
○ 4	2022-104/143-000	50
○ 5	2022-105/144-000	50
○ 6	2022-106/144-000	50
○ 7	2022-107/144-000	25
○ 8	2022-108/145-000	25
○ 9	2022-109/145-000	25
○ 10	2022-110/145-000	25
○ 11	2022-111/146-000	25
○ 12	2022-112/146-000	20
○ 13	2022-113/146-000	20
○ 14	2022-114/146-000	15
○ 15	2022-115/147-000	15

1-conductor female plug with locking lever, fits into carrier terminal blocks, with coding fingers

Pole No.	Item No.	Pack. Unit
● 1 blue	2022-101/122-006	200
● 1 green-yellow	2022-101/122-016	200

1-conductor female plug with strain relief plate, fits into carrier terminal blocks, with coding fingers

Pole No.	Item No.	Pack. Unit
● 1 blue	2022-101/132-006	200
● 1 green-yellow	2022-101/132-016	200

1-conductor female plug with strain relief plate and locking lever, fits into carrier terminal blocks, with coding fingers

Pole No.	Item No.	Pack. Unit
● 1 blue	2022-101/142-006	200
● 1 green-yellow	2022-101/142-016	200

# X-COM®S-SYSTEM

## 1-Conductor Female Plugs with Locking Levers and Strain Relief Plates

2

Strain Relief Plates (SRP), Gray			Locking Levers (LL), Gray				SRP and LL, Gray	
			Assembled		Assembled		Assembled	
SRP			Pole No.	Quantity	1-Way	2-Way		
Item No. Suffix					Item No. Suffix		Item No. Suffix	
Item No.	Color	Width						
734-327	gray	6mm	/132-0xx	1 to 2	1	/122-0xx	-	/142-0xx
734-328	gray	12.5mm	/133-0xx	3 to 4	1	-	/123-0xx	/143-0xx
734-329	gray	25mm	/134-0xx	5 to 6	1	-	/123-0xx	/144-0xx
734-326	gray	35mm	/135-0xx	7 to 10	1	-	/123-0xx	/145-0xx
734-430	gray	55mm	/136-0xx	11 to 14	2	-	/123-0xx	/144-0xx
734-431	gray	75mm	/137-0xx	15	2	-	/123-0xx	/145-0xx

For colored female plugs, the item number suffix "xx" must be replaced by the blue "-006" and the green-yellow "-016" color suffix.

Dimensions of locking levers

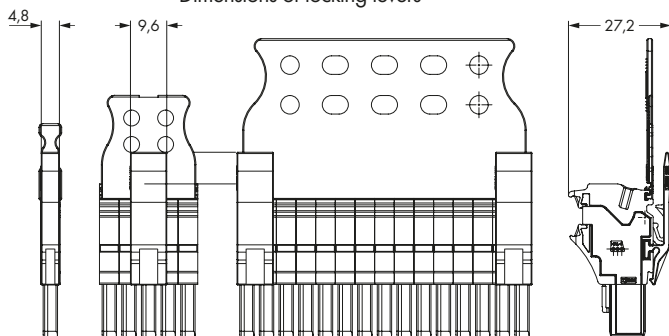

Description	Color	Item No.	Suffix No.
1-conductor female plug	gray	2022-101	none
1- to 15-pole	blue	to	/000-006
	green-yellow	2022-115	/000-016

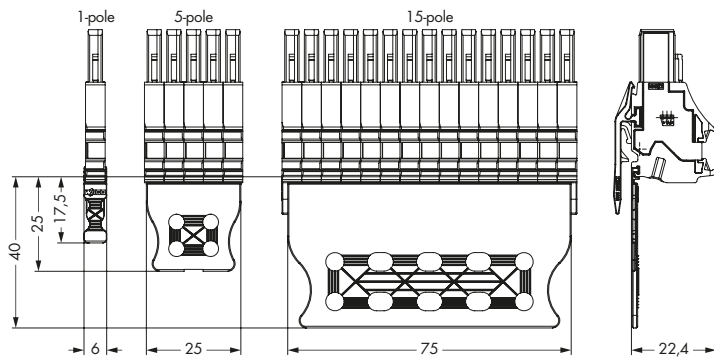
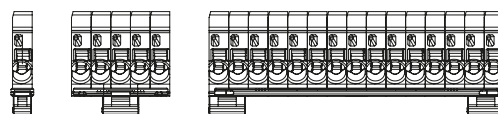

Dimensions of strain relief plates

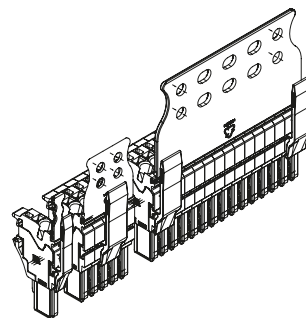

## X-COM®S-SYSTEM – 1-Conductor/1-Pin, 2-Conductor/1-Pin and 2-Conductor/2-Pin Carrier Terminal Blocks for Ex nA Applications

### 2.5 (4) mm<sup>2</sup>, 2022 Series

2

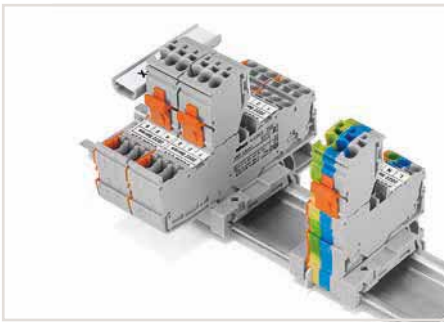

Each female plug is supplied with a locking lever.

Rail-mount terminal blocks with an Ex mark are suitable for Ex e II applications.

Current-carrying capacity curves upon request

#### Note:

When used as intended, female plugs shall not be connected/disconnected when live or under load.

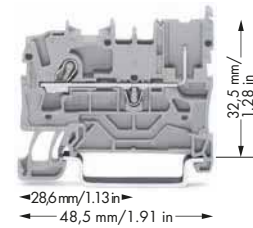

1-conductor/1-pin carrier terminal block, for DIN-35 rail, per EN 60715

Color	Item No.	Pack. Unit
gray	2022-1201/999-953	100
blue	2022-1204/999-953	100



630 V = rated voltage for use in Zone 2 hazardous areas, "nA" type of protection

"n" refers to an ignition protection class in Zone 2: This zone covers areas in which a dangerous, explosive atmosphere consisting of gases, vapors or dust is unlikely to exist and will only persist for a short period if it does.

"A" means: non-sparking (function modules without relays/switches)

Ex marking:

"Ex" sign and extended item number ".../999-953" are printed on the side of both carrier terminal blocks and female plugs with Ex approval.

Shorter locking lever (factory-mounted) makes accidental disconnection more difficult.

#### Technical Data

Ratings per	IEC/EN 60947-7-1
Rated voltage EN (Ex e II)	630 V
Rated current	20 A
Approval	600 V, 20 A <sup>Ⓔ</sup>
Nominal cross section	2.5 mm <sup>2</sup>
<b>Connection Data</b>	
Solid conductor	0.25 ... 4 mm <sup>2</sup> / 22 ... 12 AWG
Solid conductor, push-in termination	0.75 ... 4 mm <sup>2</sup> / 18 ... 12 AWG
Fine-stranded conductor	0.25 ... 4 mm <sup>2</sup> / 22 ... 12 AWG
Fine-stranded conductor with ferrule, push-in termination, min.	0.75 mm <sup>2</sup> / 18 AWG
Strip length	10 ... 12 mm / 0.39 ... 0.47 inch
Terminal block width	5.2 mm / 0.205 inch
Insulation material	Polyamide 66 (PA 66)

#### Accessories (Selection)

	Item No.	Page
Push-in type jumper bar, insulated, l <sub>n</sub> 25 A, light gray	2002-402	224
End and intermediate plate, 1 mm thick	orange 2022-1292	226
WMB Inline, plain, 1,500 WMB markers (5 mm) per reel, 5 ... 5.2 mm stretchable	white 2009-115	780
Marking strip, plain, 11 mm wide, 50 m reel	white 2009-110	783
Test pin, 1 mm Ø, with solder connection for test cable	859-500	225

Accessories (jumpers, end plates, test plugs, etc.), see page 224

Female plugs, see page 221

Carrier rails and tools, see Section 13

Appropriate marking system, WMB/WMB Inline/markings strips, see Full Line Catalog, Volume 6

Approvals and corresponding ratings, visit [www.wago.com](http://www.wago.com)

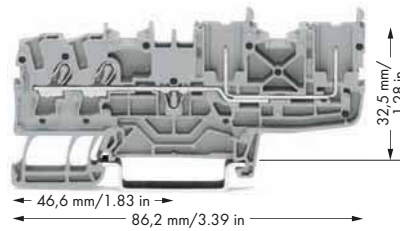
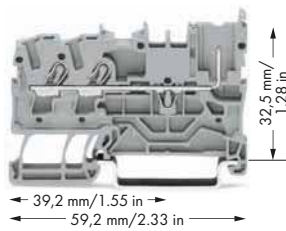

2-conductor/1-pin carrier terminal block, for DIN-35 rail, per EN 60715

Color	Item No.	Pack. Unit
gray	2022-1301/999-953	100
blue	2022-1304/999-953	100



IEC/EN 60947-7-1

630 V

20 A

600 V, 20 A

2.5 mm<sup>2</sup>

0.25 ... 4 mm<sup>2</sup> / 22 ... 12 AWG

0.75 ... 4 mm<sup>2</sup> / 18 ... 12 AWG

0.25 ... 4 mm<sup>2</sup> / 22 ... 12 AWG

0.75 mm<sup>2</sup> / 18 AWG

10 ... 12 mm / 0.39 ... 0.47 inch

5.2 mm / 0.205 inch

Polyamide 66 (PA 66)

	Item No.	Page
2-way	2002-402	224
orange	2022-1392	226
white	2009-115	780
white	2009-110	783
	859-500	225

2-conductor/2-pin carrier terminal block, for DIN-35 rail, per EN 60715

Color	Item No.	Pack. Unit
gray	2022-1401/999-953	50
blue	2022-1404/999-953	50



IEC/EN 60947-7-1

630 V

20 A

600 V, 20 A

2.5 mm<sup>2</sup>

0.25 ... 4 mm<sup>2</sup> / 22 ... 12 AWG

0.75 ... 4 mm<sup>2</sup> / 18 ... 12 AWG

0.25 ... 4 mm<sup>2</sup> / 22 ... 12 AWG

0.75 mm<sup>2</sup> / 18 AWG

10 ... 12 mm / 0.39 ... 0.47 inch

5.2 mm / 0.205 inch

Polyamide 66 (PA 66)

	Item No.	Page
2-way	2002-402	224
orange	2022-1492	226
white	2009-115	780
white	2009-110	783
	859-500	225



## X-COM®S-SYSTEM – 1-Conductor/1-Pin, 2-Conductor/1-Pin and 2-Conductor/2-Pin Ground Carrier Terminal Blocks for Ex nA Applications 2.5 (4) mm<sup>2</sup>, 2022 Series

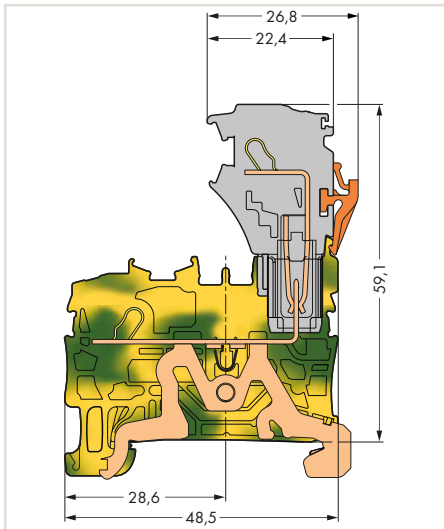

Ground carrier terminal block

Rail-mount terminal blocks with an Ex mark are suitable for Ex e II applications.

Current-carrying capacity curves upon request

### Note:

When used as intended, female plugs shall not be connected/disconnected when live or under load.

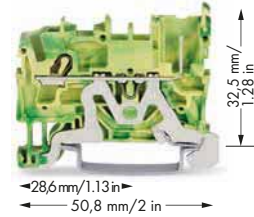

1-conductor/1-pin ground carrier terminal block, for DIN-35 rail, per EN 60715

Color	Item No.	Pack. Unit
green-yellow	2022-1207/999-953	100



### Technical Data

Ratings per	IEC/EN 60947-7-2
Nominal cross section	2.5 mm <sup>2</sup>
<b>Connection Data</b>	
Solid conductor	0.25 ... 4 mm <sup>2</sup> / 22 ... 12 AWG
Solid conductor, push-in termination	0.75 ... 4 mm <sup>2</sup> / 18 ... 12 AWG
Fine-stranded conductor	0.25 ... 4 mm <sup>2</sup> / 22 ... 12 AWG
Fine-stranded conductor with ferrule, push-in termination, min.	0.75 mm <sup>2</sup> / 18 AWG
Strip length	10 ... 12 mm / 0.39 ... 0.47 inch
Terminal block width	5.2 mm / 0.205 inch
Insulation material	Polyamide 66 (PA 66)

### Accessories (Selection)

	Item No.	Page
Push-in type jumper bar, insulated, I <sub>N</sub> 25 A, light gray	2002-402	224
End and intermediate plate, 1 mm thick	orange	226
WMB Inline, plain, 1,500 WMB markers (5 mm) per reel, 5 ... 5.2 mm stretchable	white	780
Marking strip, plain, 11 mm wide, 50 m reel	white	783
Test pin, 1 mm Ø, with solder connection for test cable	859-500	225

630 V = rated voltage for use in Zone 2 hazardous areas, "nA" type of protection

### "n" refers to an ignition protection class in Zone 2:

This zone covers areas in which a dangerous, explosive atmosphere consisting of gases, vapors or dust is unlikely to exist and will only persist for a short period if it does.

"A" means: non-sparking (function modules without relays/switches)

### Ex marking:

"Ex" sign and extended item number ".../999-953" are printed on the side of both carrier terminal blocks and female plugs with Ex approval.

Shorter locking lever (factory-mounted) makes accidental disconnection more difficult.

Accessories (jumpers, end plates, test plugs, etc.), see page 224

Female plugs, see page 221

Carrier rails and tools, see Section 13

Appropriate marking system, WMB/WMB Inline/markings strips, see Full Line Catalog, Volume 6

Approvals and corresponding ratings, visit [www.wago.com](http://www.wago.com)

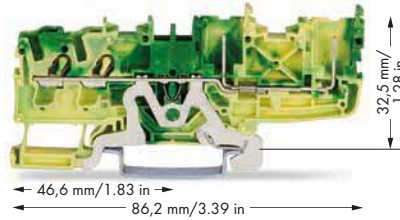
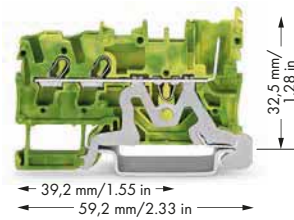

2-conductor/1-pin ground carrier terminal block, for DIN-35 rail, per EN 60715

Color	Item No.	Pack. Unit
● green-yellow ☺	2022-1307/999-953	100

2-conductor/2-pin ground carrier terminal block, for DIN-35 rail, per EN 60715

Color	Item No.	Pack. Unit
● green-yellow ☺	2022-1407/999-953	50

☺

IEC/EN 60947-7-2
2.5 mm <sup>2</sup>
0.25 ... 4 mm <sup>2</sup> / 22 ... 12 AWG
0.75 ... 4 mm <sup>2</sup> / 18 ... 12 AWG
0.25 ... 4 mm <sup>2</sup> / 22 ... 12 AWG
0.75 mm <sup>2</sup> / 18 AWG
10 ... 12 mm / 0.39 ... 0.47 inch
5.2 mm / 0.205 inch
Polyamide 66 (PA 66)

☺

IEC/EN 60947-7-2
2.5 mm <sup>2</sup>
0.25 ... 4 mm <sup>2</sup> / 22 ... 12 AWG
0.75 ... 4 mm <sup>2</sup> / 18 ... 12 AWG
0.25 ... 4 mm <sup>2</sup> / 22 ... 12 AWG
0.75 mm <sup>2</sup> / 18 AWG
10 ... 12 mm / 0.39 ... 0.47 inch
5.2 mm / 0.205 inch
Polyamide 66 (PA 66)

	Item No.	Page
2-way	2002-402	224
orange	2022-1392	226
white	2009-115	780
white	2009-110	783
	859-500	225

	Item No.	Page
2-way	2002-402	224
orange	2022-1492	226
white	2009-115	780
white	2009-110	783
	859-500	225

## X-COM®S-SYSTEM

## Double-deck carrier terminal blocks for Ex nA applications

2.5 (4) mm<sup>2</sup>, 2022 Series

2

Rail-mount terminal blocks with an Ex mark are suitable for Ex e II applications.

Current-carrying capacity curves upon request

**Note:**

When used as intended, female plugs shall not be connected/disconnected when live or under load.

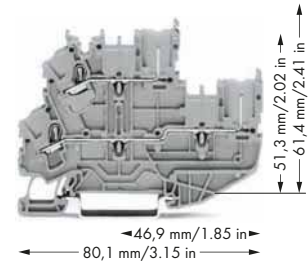

1-conductor/1-pin double-deck carrier block, through/through terminal block, without marker carrier

	Item No.	Pack. Unit
○ L/L ☞	2022-2201/999-953	50

**Technical Data**

Ratings per	IEC/EN 60947-7-1
Rated voltage EN (Ex e II)	630 V
Rated current	20 A
Approval	600 V, 20 A ☞
Nominal cross section	2.5 mm <sup>2</sup>

**Connection Data**

Solid conductor	0.25 ... 4 mm <sup>2</sup> / 22 ... 12 AWG
Solid conductor, push-in termination	0.75 ... 4 mm <sup>2</sup> / 18 ... 12 AWG
Fine-stranded conductor	0.25 ... 4 mm <sup>2</sup> / 22 ... 12 AWG
Fine-stranded conductor with ferrule, push-in termination, min.	0.75 mm <sup>2</sup> / 18 AWG
Strip length	10 ... 12 mm / 0.39 ... 0.47 inch
Terminal block width	5.2 mm / 0.205 inch
Insulation material	Polyamide 66 (PA 66)

**Accessories (Selection)**

Push-in type jumper bar, insulated, I <sub>n</sub> 25 A, light gray	2-way	2002-402	224
End and intermediate plate, 1 mm thick	orange	2022-2292	226
WMB Inline, plain, 1,500 WMB markers (5 mm) per reel, 5 ... 5.2 mm stretchable	white	2009-115	780
Marking strip, plain, 11 mm wide, 50 m reel	white	2009-110	783
Test pin, 1 mm Ø, with solder connection for test cable		859-500	225

630 V = rated voltage for use in Zone 2 hazardous areas, "nA" type of protection

"n" refers to an ignition protection class in Zone 2: This zone covers areas in which a dangerous, explosive atmosphere consisting of gases, vapors or dust is unlikely to exist and will only persist for a short period if it does.

"A" means: non-sparking (function modules without relays/switches)

**Ex marking:**

"Ex" sign and extended item number ".../999-953" are printed on the side of both carrier terminal blocks and female plugs with Ex approval.

Shorter locking lever (factory-mounted) makes accidental disconnection more difficult.

📖 Accessories (jumpers, end plates, test plugs, etc.), see page 224

📖 Female plugs, see page 221

📖 Carrier rails and tools, see Section 13

📖 Appropriate marking system, WMB/WMB Inline/marketing strips, see Full Line Catalog, Volume 6

📖 Approvals and corresponding ratings, visit [www.wago.com](http://www.wago.com)

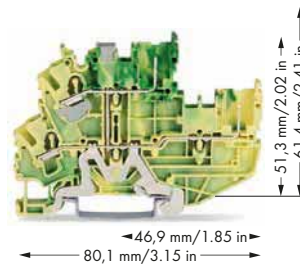
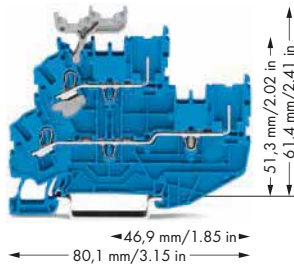

1-conductor/1-pin double-deck carrier terminal block, through/through terminal block, with marker carrier

	Item No.	Pack. Unit
● N/N ☒	2022-2234/999-953	50

2-conductor/2-pin double-deck carrier block, 2-conductor/2-pin ground conductor block, without marker carrier, internally commoned

	Item No.	Pack. Unit
● PE ☒	2022-2207/999-953	50

☒

IEC/EN 60947-7-1
630 V
20 A
600 V, 20 A ☒
2.5 mm <sup>2</sup>
0.25 ... 4 mm <sup>2</sup> / 22 ... 12 AWG
0.75 ... 4 mm <sup>2</sup> / 18 ... 12 AWG
0.25 ... 4 mm <sup>2</sup> / 22 ... 12 AWG
0.75 mm <sup>2</sup> / 18 AWG
10 ... 12 mm / 0.39 ... 0.47 inch
5.2 mm / 0.205 inch
Polyamide 66 (PA 66)

☒

IEC/EN 60947-7-2
630 V
20 A
600 V, 20 A ☒
2.5 mm <sup>2</sup>
0.25 ... 4 mm <sup>2</sup> / 22 ... 12 AWG
0.75 ... 4 mm <sup>2</sup> / 18 ... 12 AWG
0.25 ... 4 mm <sup>2</sup> / 22 ... 12 AWG
0.75 mm <sup>2</sup> / 18 AWG
10 ... 12 mm / 0.39 ... 0.47 inch
5.2 mm / 0.205 inch
Polyamide 66 (PA 66)

	Item No.	Page
2-way	2002-402	224
orange	2022-2292	226
white	2009-115	780
white	2009-110	783
	859-500	225

	Item No.	Page
2-way	2002-402	224
orange	2022-2292	226
white	2009-115	780
white	2009-110	783
	859-500	225

## X-COM®S-SYSTEM

### 1-Conductor Female Plugs for Ex nA Applications

#### 2.5 (4) mm<sup>2</sup>, 2022 Series

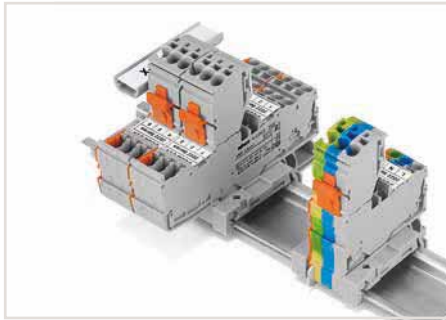

Each female plug is supplied with a locking lever.

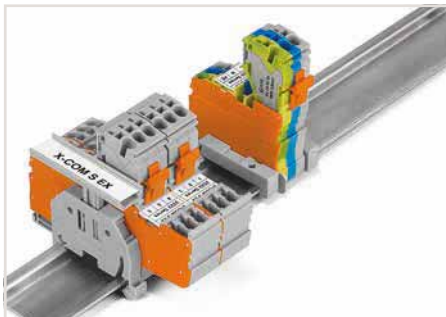

Group marking with height-adjustable group marker carrier (2009-163)

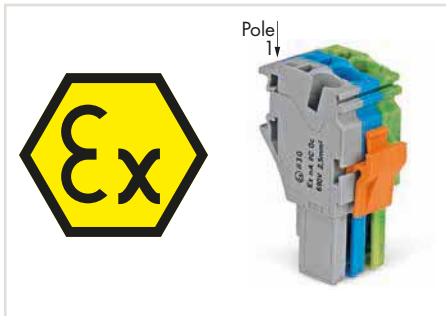

**Ex marking:**  
"Ex" sign and extended item number ".../999-953" are printed on the side of both carrier terminal blocks and female plugs with Ex approval. Shorter locking lever (factory-mounted) makes accidental disconnection more difficult.

#### Technical Data

Ratings per	IEC/EN 61984
Rated voltage (III / 3)	690 V
Rated surge voltage (III / 3)	6 kV
Rated current	24 A
<b>Connection Data</b>	
Connection technology	Push-in CAGE CLAMP®
Solid conductor	0.25 ... 4 mm <sup>2</sup> / 22 ... 12 AWG
Solid conductor, push-in termination	0.75 ... 4 mm <sup>2</sup> / 18 ... 12 AWG
Fine-stranded conductor	0.25 ... 4 mm <sup>2</sup> / 22 ... 12 AWG
Fine-stranded conductor with ferrule, push-in termination, min.	0.75 mm <sup>2</sup> / 18 AWG
Nominal cross section	2.5 mm <sup>2</sup>
Approval	600 V, 20 AⓈ
Module width	5.2 mm / 0.205 inch
Strip length	9 ... 11 mm / 0.35 ... 0.43 inch
Insulation material	Polyamide 66 (PA 66)

Current-carrying capacity curves, visit [www.wago.com](http://www.wago.com)

#### Note:

According to EN 61984, pluggable connectors without current interrupting capacity shall not be mated and unmated when live or under load.

630 V = rated voltage for use in Zone 2 hazardous areas, "nA" type of protection  
"n" refers to an ignition protection class in Zone 2:

This zone covers areas in which a dangerous, explosive atmosphere consisting of gases, vapors or dust is unlikely to exist and will only persist for a short period if it does.

"A" means: non-sparking (function modules without relays/switches)

#### Ex marking:

"Ex" sign and extended item number ".../999-953" are printed on the side of both carrier terminal blocks and female plugs with Ex approval.

Shorter locking lever (factory-mounted) makes accidental disconnection more difficult.

Accessories for female plugs, see page 227

Appropriate marking system, WMB/WMB Inline/marketing strips, see Full Line Catalog, Volume 6

Approvals and corresponding ratings, visit [www.wago.com](http://www.wago.com)

#### Accessories (Selection)

	Item No.	Page
WMB Inline, plain, 1,500 WMB markers (5 mm) per reel, 5 ... 5.2 mm stretchable	2009-115	780
Marking strip, plain, 11 mm wide, 50 m reel	2009-110	783
Protective warning marker, with black high-voltage symbol, for 5 terminal blocks	2002-115	225
Strain relief plate, gray	734-326	225

# X-COM®S-SYSTEM

## 1-Conductor Female Plugs for Ex nA Applications

### 2.5 (4) mm², 2022 Series



Dimensions (in mm):

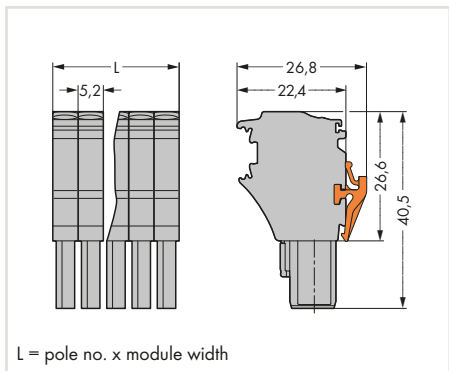

1-conductor female plug with shorter locking lever, fits into carrier terminal blocks, with coding fingers, gray

Pole No.	Item No.	Pack. Unit
2	2022-102/999-953	100
3	2022-103/999-953	100
4	2022-104/999-953	100
5	2022-105/999-953	50
6	2022-106/999-953	50
7	2022-107/999-953	50
8	2022-108/999-953	50

1-conductor female plug with shorter locking lever and ground base module (green-yellow), fits into carrier terminal blocks, with coding fingers, gray, blue, green-yellow

Pole No.	Item No.	Pack. Unit
3	2022-103/000-038/999-953	100
4	2022-104/000-038/999-953	100
5	2022-105/000-038/999-953	100
6	2022-106/000-038/999-953	50

1-conductor female plug with shorter locking lever and ground end module (green-yellow), fits into carrier terminal blocks, with coding fingers, green-yellow, blue, gray

Pole No.	Item No.	Pack. Unit
3	2022-103/000-039/999-953	100
4	2022-104/000-039/999-953	100
5	2022-105/000-039/999-953	100
6	2022-106/000-039/999-953	50



## X-COM®S-SYSTEM-MINI

Accessories, 2020 Series or a 3.5 mm Terminal Block Width  
Commoning, Mounting, Marking and Testing

Push-in type jumper bars,  
see page 179

Push-in type jumper bar, insulated, I<sub>N</sub> 14 A

	light gray Item No.	red Item No.	blue Item No.	yellow-green Item No.	Pack. Unit
2-way	2000-402	2000-402/000-005	2000-402/000-006	2000-402/000-018	200 (25)
3-way	2000-403	2000-403/000-005	2000-403/000-006		200 (25)
4-way	2000-404	2000-404/000-005	2000-404/000-006		200 (25)
5-way	2000-405	2000-405/000-005	2000-405/000-006		100 (25)
6-way	2000-406	2000-406/000-005	2000-406/000-006		100 (25)
7-way	2000-407	2000-407/000-005	2000-407/000-006		100 (25)
8-way	2000-408	2000-408/000-005	2000-408/000-006		100 (25)
9-way	2000-409	2000-409/000-005	2000-409/000-006		100 (25)
10-way	2000-410	2000-410/000-005	2000-410/000-006		100 (25)



Push-in type jumper bar, insulated, I<sub>N</sub> 14 A, light gray

	Item No.	Pack. Unit
1 to 3	2000-433	200 (25)
1 to 4	2000-434	200 (25)
1 to 5	2000-435	100 (25)
1 to 6	2000-436	100 (25)
1 to 7	2000-437	100 (25)
1 to 8	2000-438	100 (25)
1 to 9	2000-439	100 (25)
1 to 10	2000-440	100 (25)



Delta jumper, insulated, I<sub>N</sub> = I<sub>N</sub> terminal block, light gray

	Item No.	Pack. Unit
1-2 3-4 5-6	2000-406/020-000	100 (25)



Star point jumper, insulated, I<sub>N</sub> = I<sub>N</sub> terminal block, light gray

	Item No.	Pack. Unit
1-3-5	2000-405/011-000	100 (25)



Push-in type wire jumper,  
see page 179

Note: Push down the wire jumper until fully inserted.

Rated voltage (III / 3)	800 V
Rated surge voltage (III / 3)	8 kV

Push-in type wire jumper, insulated, 0.75 mm<sup>2</sup> conductor cross-section, for 2000 and 2020 Series rail-mount terminal blocks, I<sub>N</sub> 9 A

	Item No.	Pack. Unit
L = 60 mm	2009-402	100 (10)
L = 110 mm	2009-404	100 (10)
L = 250 mm	2009-406	100 (10)

Rated voltage (III / 3)	500 V
Rated surge voltage (III / 3)	6 kV

Double-deck vertical jumper, insulated, I<sub>N</sub> 13.5 A

Suitable for:	Color	Item No.	Pack. Unit
2020-2231	light gray	2000-492	100 (25)





## X-COM®S-SYSTEM-MINI

### Accessories, 2020 Series or a 3.5 mm Terminal Block Width Commoning, Mounting, Marking and Testing



End and intermediate plate, 1 mm thick			
Suitable for:	Color	Item No.	Pack. Unit
2020-1201	orange	2020-1292	100 (25)
	gray	2020-1291	100 (25)



End and intermediate plate, 1 mm thick			
Suitable for:	Color	Item No.	Pack. Unit
2020-1301	orange	2020-1392	100 (25)
	gray	2020-1391	100 (25)



End and intermediate plate, 1 mm thick			
Suitable for:	Color	Item No.	Pack. Unit
2020-1401	orange	2020-1492	100 (25)
	gray	2020-1491	100 (25)



End and intermediate plate, 1 mm thick			
Suitable for:	Color	Item No.	Pack. Unit
2020-2231	orange	2020-2292	100 (25)
	gray	2020-2291	100 (25)



Protective warning marker, with high-voltage symbol, for 5 terminal blocks			
Color		Item No.	Pack. Unit
yellow		2000-115	100 (25)



Carrier with 6 coding pins for coding female plugs			
Color		Item No.	Pack. Unit
orange		2020-100	100 (25)

## X-COM®S-SYSTEM

Accessories, 2022 Series or a 5.2 mm Terminal Block Width  
Commoning, Mounting, Marking and Testing

 Push-in type jumper bars,  
see page 179

Push-in type jumper bar, insulated,  $I_N$  25 A

	light gray Item No.	red Item No.	blue Item No.	Pack. Unit
2-way	2002-402	2002-402/000-005	2002-402/000-006	200 (25)
3-way	2002-403	2002-403/000-005	2002-403/000-006	200 (25)
4-way	2002-404	2002-404/000-005	2002-404/000-006	200 (25)
5-way	2002-405	2002-405/000-005	2002-405/000-006	100 (25)
6-way	2002-406	2002-406/000-005	2002-406/000-006	100 (25)
7-way	2002-407	2002-407/000-005	2002-407/000-006	100 (25)
8-way	2002-408	2002-408/000-005	2002-408/000-006	100 (25)
9-way	2002-409	2002-409/000-005	2002-409/000-006	100 (25)
10-way	2002-410	2002-410/000-005	2002-410/000-006	100 (25)



Push-in type jumper bar, insulated,  $I_N$  14 A, light gray

	Item No.	Pack. Unit
1 to 3	2002-433	200 (25)
1 to 4	2002-434	200 (25)
1 to 5	2002-435	100 (25)
1 to 6	2002-436	100 (25)
1 to 7	2002-437	100 (25)
1 to 8	2002-438	100 (25)
1 to 9	2002-439	100 (25)
1 to 10	2002-440	100 (25)



 Staggered jumper,  
see page 179

Note: Push down the staggered jumper until fully inserted.

Rated voltage (III / 3)	400 V
Rated surge voltage (III / 3)	6 kV

Staggered jumper, insulated,  $I_N$  25 A, light gray

	Item No.	Pack. Unit
2-way	2002-472	100 (25)
3-way	2002-473	100 (25)
4-way	2002-474	100 (25)
5-way	2002-475	50 (25)
6-way	2002-476	50 (25)
7-way	2002-477	50 (25)
8-way	2002-478	50 (25)
9-way	2002-479	50 (25)
10-way	2002-480	50 (25)
11-way	2002-481	50 (25)
12-way	2002-482	50 (25)

Note: Push down the staggered jumper until fully inserted.

Rated voltage (III / 3)	400 V
Rated surge voltage (III / 3)	6 kV



Pre-assembled staggered jumper, insulated, with contact lugs broken off at the factory and circuit printing,  $I_N$  25 A, light gray

	Item No.	Pack. Unit
2-way (1-3)	2002-473/011-000	100 (25)
3-way (1-3-5)	2002-475/011-000	50 (25)
4-way (1-3-5-7)	2002-477/011-000	50 (25)
5-way (1-3-5-7-9)	2002-479/011-000	50 (25)
6-way (1-3-5-7-9-11)	2002-481/011-000	50 (25)

## X-COM®S-SYSTEM

Accessories, 2022 Series or a 5.2 mm Terminal Block Width  
Commoning, Mounting, Marking and Testing

Adjacent jumper for continuous commoning, insulated, 800 V, I <sub>N</sub> 25 A, light gray		
	Item No.	Pack. Unit
2-way	2002-400	100 (25)



Rated voltage (III / 3)	800 V
Rated surge voltage (III / 3)	8 kV

Adjacent jumper for continuous commoning, insulated, I <sub>N</sub> 25 A, 1 to 3		
Color	Item No.	Pack. Unit
light gray	2002-423	100 (25)
red	2002-423/000-005	100 (25)
blue	2002-423/000-006	100 (25)



Delta jumper, insulated, I <sub>N</sub> = I <sub>N</sub> terminal block, light gray		
	Item No.	Pack. Unit
1-2 3-4 5-6	2002-406/020-000	100 (25)



Star point jumper, insulated, I <sub>N</sub> = I <sub>N</sub> terminal block, light gray		
	Item No.	Pack. Unit
1-3-5	2002-405/011-000	100 (25)



 Push-in type wire jumper,  
see page 179

Note: Push down the wire jumper until fully inserted.

Rated voltage (III / 3)	800 V
Rated surge voltage (III / 3)	8 kV

Push-in type wire jumper, insulated, 1.5 mm <sup>2</sup> conductor cross-section, for 2001, 2002, 2003 and 2022 Series rail-mount terminal blocks, I <sub>N</sub> 18 A		
	Item No.	Pack. Unit
L = 60 mm	2009-412	100 (10)
L = 110 mm	2009-414	100 (10)
L = 250 mm	2009-416	100 (10)

Rated voltage (III / 3)	500 V
Rated surge voltage (III / 3)	6 kV



Double-deck vertical jumper, insulated, I <sub>N</sub> 24 A			
Suitable for:	Color	Item No.	Pack. Unit
2022-2231	light gray	2002-492	100 (25)
2022-2201/999-953	orange	2002-492/000-012	100 (25)

## X-COM®S-SYSTEM

Accessories, 2022 Series or a 5.2 mm Terminal Block Width  
Commoning, Mounting, Marking and Testing

End and intermediate plate, 1 mm thick			
Suitable for:	Color	Item No.	Pack. Unit
2022-1201	orange	2022-1292	100 (25)
2022-1201/999-953	gray	2022-1291	100 (25)

2



End and intermediate plate, 1 mm thick			
Suitable for:	Color	Item No.	Pack. Unit
2022-1301	orange	2022-1392	100 (25)
2022-1301/999-953	gray	2022-1391	100 (25)



End and intermediate plate, 1 mm thick			
Suitable for:	Color	Item No.	Pack. Unit
2022-1401	orange	2022-1492	100 (25)
2022-1401/999-953	gray	2022-1491	100 (25)



End and intermediate plate, 1 mm thick			
Suitable for:	Color	Item No.	Pack. Unit
2022-2231	orange	2022-2292	100 (25)
2022-2201/999-953	gray	2022-2291	100 (25)



Protective warning marker, with high-voltage symbol, for 5 terminal blocks			
Color		Item No.	Pack. Unit
yellow		2002-115	100 (25)



Insulation stop, 0.25 ... 0.5 mm², 5 pcs/strip			
Color		Item No.	Pack. Unit
light gray		2002-171	200 (25)



Insulation stop, 0.75 ... 1 mm², 5 pcs/strip			
Color		Item No.	Pack. Unit
dark gray		2002-172	200 (25)



Carrier with 6 coding pins for coding female plugs			
Color		Item No.	Pack. Unit
orange		2022-100	100 (25)

## X-COM®S-SYSTEM

### General Accessories



Strain relief plate, gray		
	Item No.	Pack. Unit
35 mm wide	734-326	100 (25)
6 mm wide	734-327	100 (25)
12.5 mm wide	734-328	100 (25)
25 mm wide	734-329	100 (25)
55 mm wide	734-430	50 (25)
75 mm wide	734-431	50 (25)



Locking lever Width 4.8 mm		
Color	Item No.	Pack. Unit
orange	2022-142	100 (25)
gray	2022-141	100 (25)



Locking lever Width 9.6 mm		
Color	Item No.	Pack. Unit
orange	2022-152	100 (25)
gray	2022-151	100 (25)



Measurement range category	CAT I
Test voltage (AC)	30 V
Test voltage (DC)	60 V
Test current	1 A

Test pin, 1 mm Ø, with solder connection for test cable		
	Item No.	Pack. Unit
	859-500	1



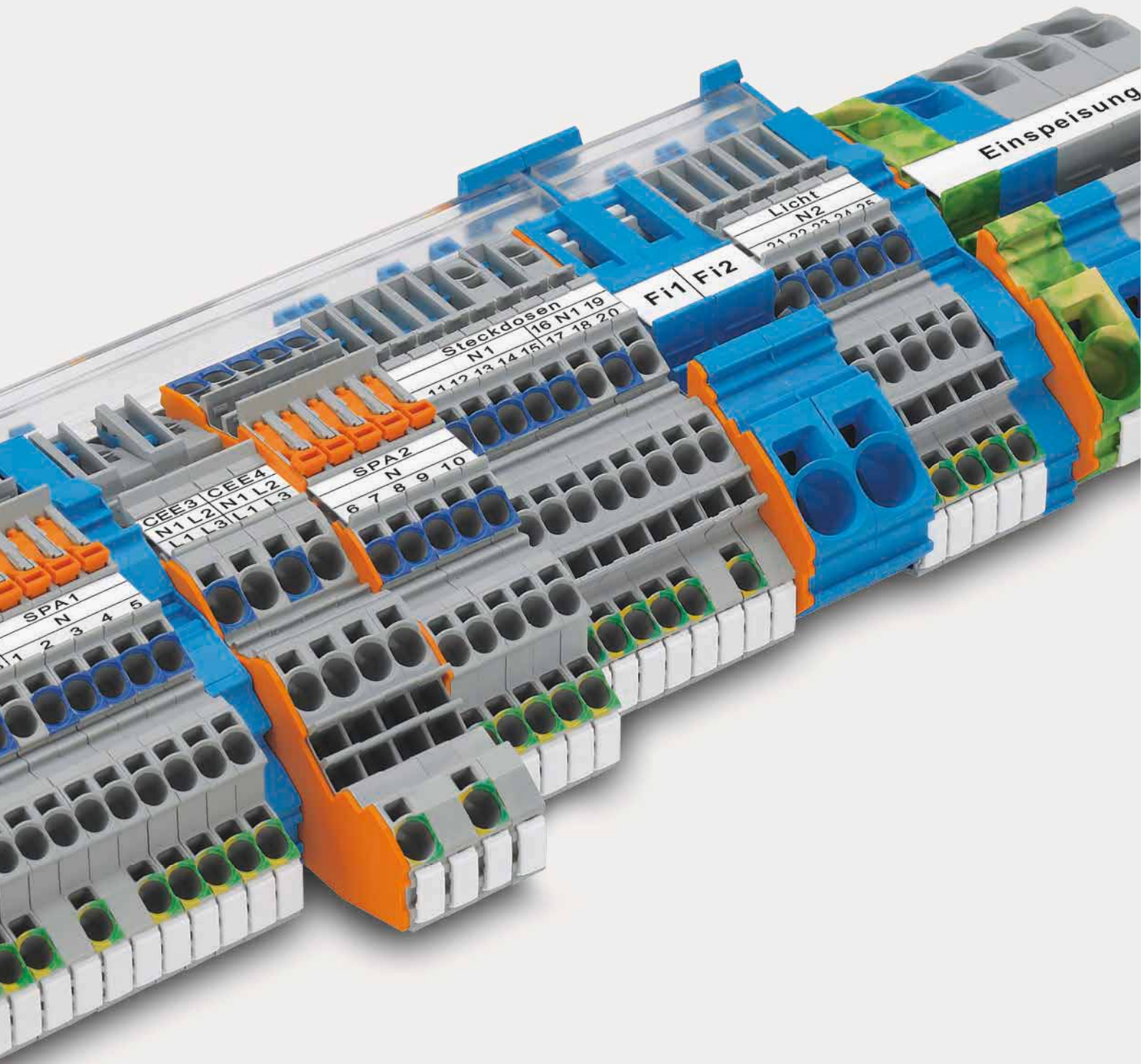

2



## Installation Rail-Mount Terminal Blocks, TOPJOB® S

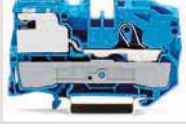

## Installation Rail-Mount Terminal Blocks, TOPJOB® S with Push-in CAGE CLAMP® Connection Front-Entry Wiring

			Page
	<b>Multilevel Installation Terminal Blocks with N-Disconnect Slide Links</b> 0.25 ... 2.5 (4) mm <sup>2</sup> (22 ... 12 AWG)	2003 Series	234
	<b>Multilevel Installation Terminal Blocks with Internal N-Disconnection</b> 0.25 ... 2.5 (4) mm <sup>2</sup> (22 ... 12 AWG)	2003 Series	236
	<b>Multilevel Installation Terminal Blocks with N-Disconnect Slide Links</b> 0.5 ... 4 (6) mm <sup>2</sup> (20 ... 10 AWG)	2005 Series	240
	<b>N-Conductor and Power Distribution Disconnect Terminal Blocks</b> 0.5 ... 16 (25 "f-st") mm <sup>2</sup> (20 ... 4 AWG)	2002/2006/2016 Series	242
	<b>Distribution Supply Terminal Blocks</b> 0.5 ... 16 (25 "f-st") mm <sup>2</sup> (20 ... 4 AWG)	2016 Series	244
	<b>Accessories for Installation Rail-Mount Terminal Blocks, TOPJOB® S</b>		246



# TOPJOB® S

## Installation Rail-Mount Terminal Blocks

### Installation

3



**Inserting conductors via push-in termination.**  
Solid conductors with cross-sections from either one size above, or up to two sizes below, the rated cross-section can be simply pushed in – no tools needed.



**Inserting a conductor via operating tool.**  
Connecting fine-stranded conductors without ferrules, or small cross-sectional conductors that cannot be pushed in, is performed similarly to the original CAGE CLAMP® – just use an operating tool.

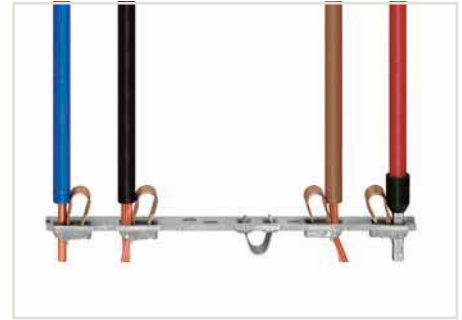

All conductor types at a glance

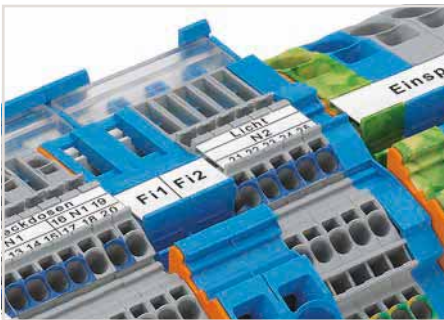

**Mounting busbars on busbar carriers:** Insert busbar ends onto large busbar carriers (2009-305) or onto supply terminal blocks with an integrated busbar carrier.

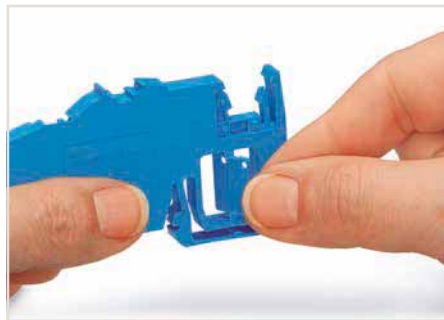

Removing the separator plate from the busbar carrier or from the N-disconnect terminal block.

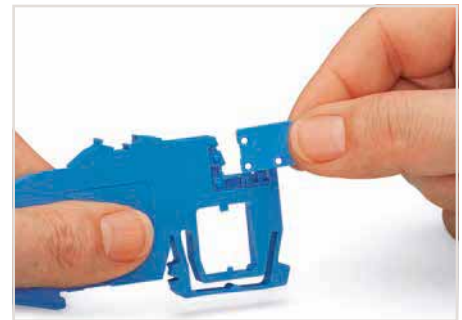

Inserting the separator plate into the busbar carrier to protect the N-busbar against accidental contact.



Inserting separator plate removed from N-disconnect terminal block.



Touch-proof N-busbar via inserted separator plate

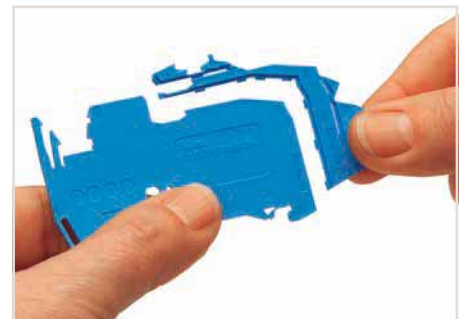

Perforations make it possible to fit the carrier to all TOPJOB® S Installation Rail-Mount Terminal Blocks using a single part.

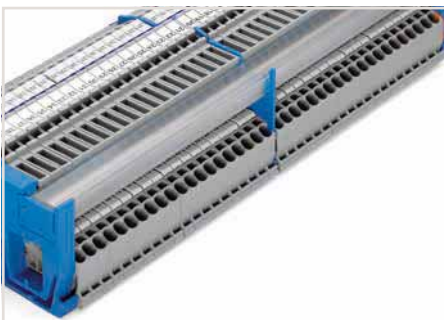

The compact busbar carrier (1.5 mm thick), which is placed every 200 mm, provides additional busbar support for longer assemblies.

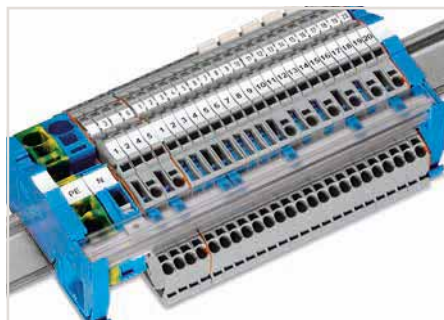

The busbar transparent cover (Item No. 777-303) protects the busbar against accidental contact and makes it easy to see which terminal blocks are connected to the busbar.



N-potential disconnection within a rail assembly via N-disconnect slide link

## TOPJOB® S

### Installation Rail-Mount Terminal Blocks

#### Installation



N-potential disconnection via N-knife disconnect within a terminal block assembly without a busbar.

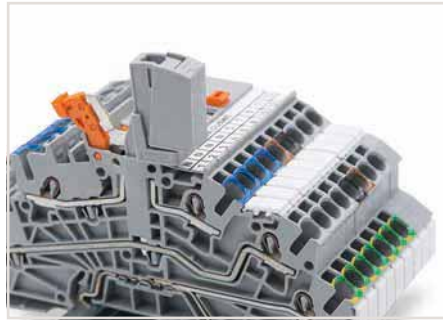

For multilevel installation terminal blocks with internal N-disconnection, test plug adapters can be inserted into the free jumper slot when the N-potential is disconnected.

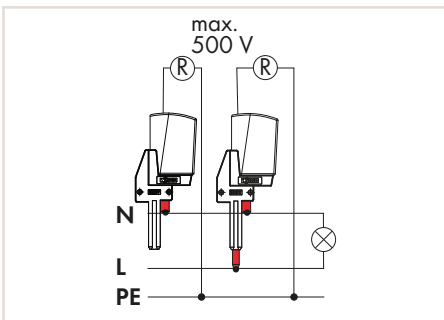

Test plug adapters for both individual N-potential measurement and insulation resistance measurement of the connected N- and L-potentials are available.

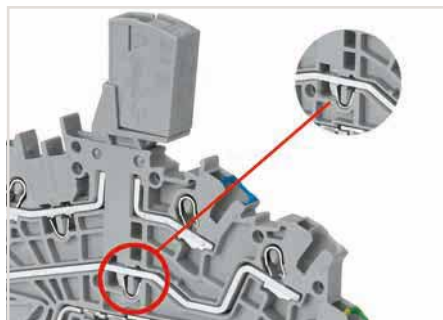

Multilevel installation terminal block fitted with an N/L-test plug adapter for quick and safe insulation resistance measurement of the connected N- and L-potentials

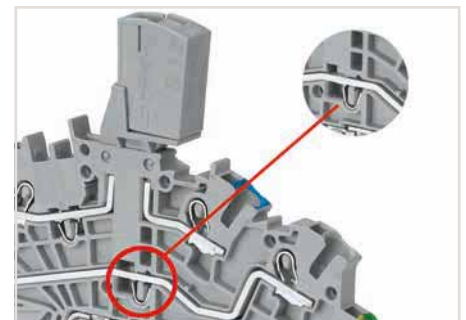

Multilevel installation terminal block fitted with an N-test plug adapter for insulation resistance measurement of the N-potential

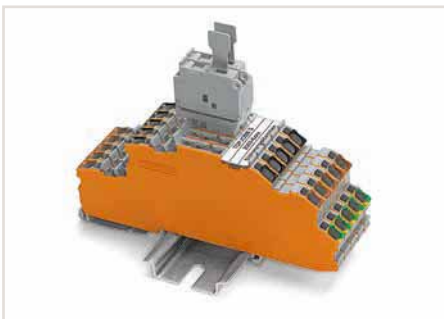

Single-fuse plugs can be used in combination with 1 mm thick end and intermediate plates on carrier terminal blocks without N-knife disconnect.



Double-fuse plugs with (5 x 25) mm miniature metric fuses can be used on carrier terminal blocks without N-knife disconnect in standard terminal block width.

# TOPJOB® S

## Staggered Jumpers, 2002 Series

### Installation

3



Staggered Jumpers, 2002 Series

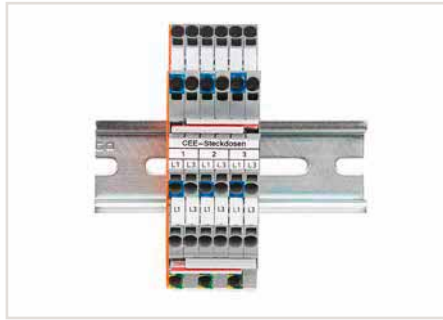

Commoning two potentials in one single jumper slot via extremely slim staggered jumpers.



Locate red stripes of the staggered jumpers on the inside. Insert staggered jumper and push down until it hits backstop. Custom staggered jumpers can be created, e.g., for bridging over a terminal block with a different potential.



Staggered jumpers (seven contacts)

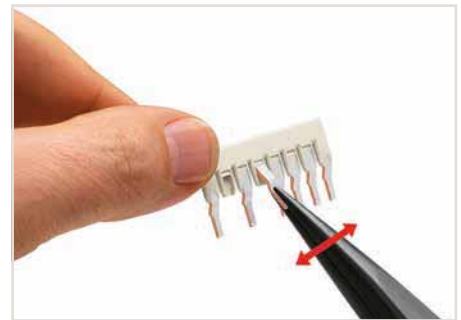

Individual jumper contacts can be broken off by bending them. The remaining piece of insulation will meet requirements for clearances and creepage distances.

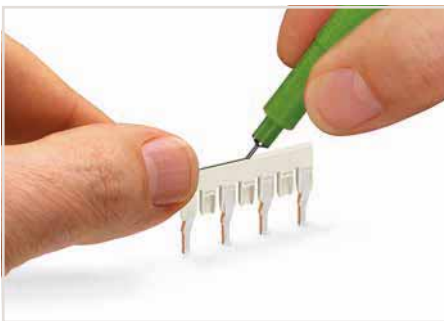

Marking with a felt-tip pen to clearly identify electrical connections.

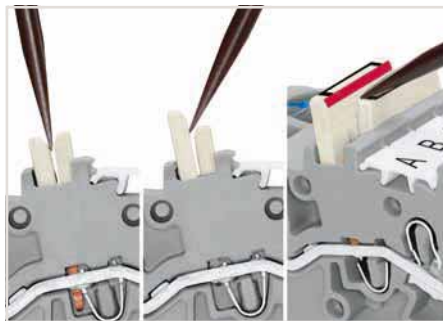

Insert the operating tool between the staggered jumpers, then lift up the jumper.

# TOPJOB® S Marking Accessories

Also see "Marking" Catalog, Volume 6.



Printing a marking strip (2009-110) via *smart*PRINTER.

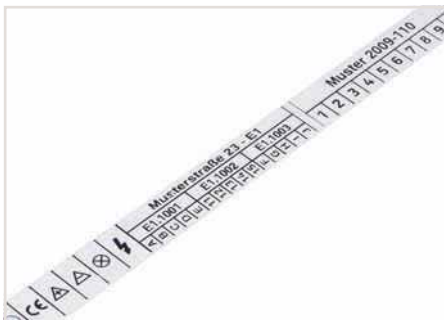

Multi-line printing of marking strips

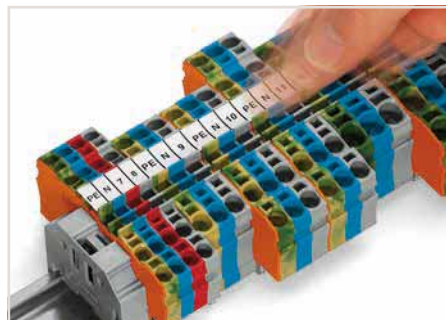

Snapping a marking strip into the marker slot.

3



Printing WMB markers via *smart*PRINTER.

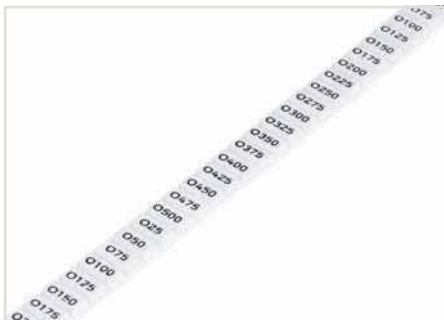

WMB markers

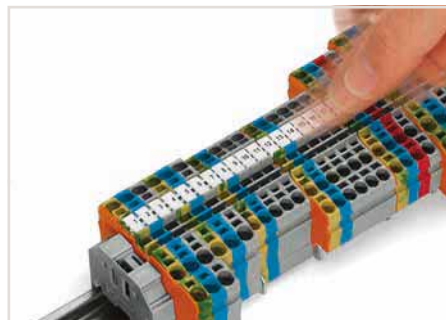

Snapping WMB Inline markers into marker slots.



## TOPJOB® S

## Multilevel Installation Terminal Blocks with N-Disconnect Slide Links

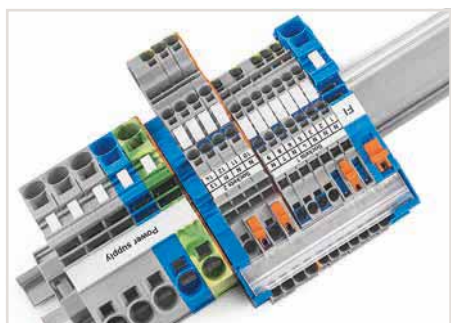
2.5 (4) mm<sup>2</sup>, 2003 Series

250 V/4 kV potential – ground  
400 V/6 kV potential – potential

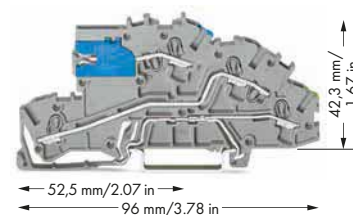

Multilevel installation terminal block, with N-disconnect slide link, gray

	Item No.	Pack. Unit
○ NT/L/PE	2003-7641	50

### TOPJOB® S – Terminal Blocks for Every Application

- Push-in termination of solid conductors in small distribution boards saves time and money.
- Operating errors can be prevented as all TOPJOB® S Terminal Blocks for building installations are equipped with push-in connection technology.
- Terminal blocks for building installations expand circuit design possibilities.
- The use of standard accessories reduces order-processing and warehousing costs.
- Accessories, shared with all terminal blocks, enhance safety by reducing the amount of components and installation techniques required.
- The busbar position is the same, making TOPJOB® S Installation Terminal Blocks compatible with standard TOPJOB® Installation Terminal Blocks.

#### Technical Data

Ratings, note	Potential – ground
Rated voltage (III / 3)	250 V
Rated surge voltage (III / 3)	4 kV
Ratings, note (2)	Potential - potential
Rated voltage (III / 3) (2)	400 V
Rated surge voltage (III / 3) (2)	6 kV
Rated current	32 A
Rated current (2)	32 A
Nominal cross section	2.5 mm <sup>2</sup>
<b>Connection Data</b>	
Solid conductor	0.25 ... 4 mm <sup>2</sup> / 22 ... 12 AWG
Solid conductor, push-in termination	0.75 ... 4 mm <sup>2</sup> / 18 ... 12 AWG
Fine-stranded conductor	0.25 ... 4 mm <sup>2</sup> / 22 ... 12 AWG
Fine-stranded conductor with ferrule, push-in termination, min.	0.75 mm <sup>2</sup> / 18 AWG
Strip length	10 ... 12 mm / 0.39 ... 0.47 inch
Terminal block width	5.2 mm / 0.205 inch
Insulation material	Polyamide 66 (PA 66)

#### Accessories (Selection)

Push-in type jumper bar, insulated, I <sub>N</sub> 25 A, light gray	
End and intermediate plate, 0.8 mm thick	
WMB Inline, plain, 1,500 WMB markers (5 mm) per reel, 5 ... 5.2 mm stretchable	
Marking strip, plain, 11 mm wide, 50 m reel	
Lock-out, prevents reclosing of slide link, snap-on type	
N-supply terminal block, I <sub>N</sub> 76 A, 16 mm <sup>2</sup> 12 mm wide	
Ground supply terminal block, 16 mm <sup>2</sup> , 12 mm wide	

#### Application note:

N-disconnect slide links, used in installation terminal blocks, consist of switch contacts that are opened and then closed as part of the regular circuit testing. To guarantee a reliable connection, a corrosion-resistant contact area is required on the N-busbar.

Historically, uninsulated copper busbars, that have been cleaned/stripped of any possible corrosion prior to install, can be used in dry, pollution-free locations.

According to DIN VDE 0100-520 (VDE 0100, Part 520), installation equipment exposed to contamination or corrosive substances (e.g., water) that promote corrosion or deterioration, must be protected or made of a corrosion- or wear-resistant material. In these cases, tinned copper busbars guarantee a reliable connection.

WAGO only offers tinned copper busbars.

Standard accessories for installation rail-mount terminal blocks, see page 250

Accessories (jumpers, end plates, etc.), see page 246

Carrier rails and tools, see Section 13

Appropriate marking system, WMB/WMB Inline/marketing strips, see Full Line Catalog, Volume 6

Approvals and corresponding ratings, visit [www.wago.com](http://www.wago.com)

	Item No.	Page
2-way	2002-402	246
orange	2003-7692	247
white	2009-115	780
white	2009-110	783
orange	2003-7300	248
blue	2016-7714	243
green-yellow	2016-7607	243

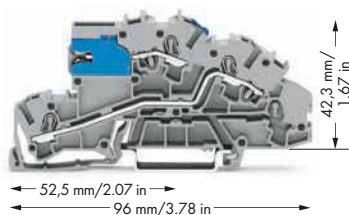

Multilevel installation terminal block, with N-disconnect slide link, gray

	Item No.	Pack. Unit
○ NT/L	2003-7640	50
○ LT/L	2003-7659	50

Multilevel installation terminal block, gray

	Item No.	Pack. Unit
○ N/L/PE	2003-7646	50
○ L/L/PE	2003-7645	50

Potential – ground

250 V  
4 kV

Potential - potential

400 V  
6 kV  
32 A  
32 A  
2.5 mm<sup>2</sup>

0.25 ... 4 mm<sup>2</sup> / 22 ... 12 AWG  
0.75 ... 4 mm<sup>2</sup> / 18 ... 12 AWG  
0.25 ... 4 mm<sup>2</sup> / 22 ... 12 AWG  
0.75 mm<sup>2</sup> / 18 AWG

10 ... 12 mm / 0.39 ... 0.47 inch  
5.2 mm / 0.205 inch  
Polyamide 66 (PA 66)

	Item No.	Page
2-way	2002-402	246
orange	2003-7692	247
white	2009-115	780
white	2009-110	783
orange	2003-7300	248
blue	2016-7714	243
green-yellow	2016-7607	243

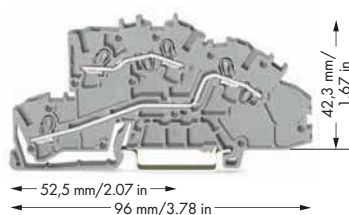

Multilevel installation terminal block, gray

	Item No.	Pack. Unit
○ L/L	2003-7642	50
○ N/L	2003-7649	50

400 V  
6 kV

32 A

2.5 mm<sup>2</sup>

0.25 ... 4 mm<sup>2</sup> / 22 ... 12 AWG  
0.75 ... 4 mm<sup>2</sup> / 18 ... 12 AWG  
0.25 ... 4 mm<sup>2</sup> / 22 ... 12 AWG  
0.75 mm<sup>2</sup> / 18 AWG

10 ... 12 mm / 0.39 ... 0.47 inch  
5.2 mm / 0.205 inch  
Polyamide 66 (PA 66)

	Item No.	Page
2-way	2002-402	246
orange	2003-7692	247
white	2009-115	780
white	2009-110	783
blue	2016-7714	243
green-yellow	2016-7607	243

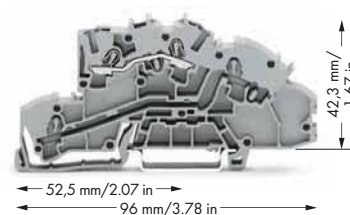

Multilevel installation terminal block, gray

	Item No.	Pack. Unit
○ L	2003-7650	50
○ N	2003-7651	50

400 V  
6 kV

32 A

2.5 mm<sup>2</sup>

0.25 ... 4 mm<sup>2</sup> / 22 ... 12 AWG  
0.75 ... 4 mm<sup>2</sup> / 18 ... 12 AWG  
0.25 ... 4 mm<sup>2</sup> / 22 ... 12 AWG  
0.75 mm<sup>2</sup> / 18 AWG

10 ... 12 mm / 0.39 ... 0.47 inch  
5.2 mm / 0.205 inch  
Polyamide 66 (PA 66)

	Item No.	Page
2-way	2002-402	246
orange	2003-7692	247
white	2009-115	780
white	2009-110	783
blue	2016-7714	243
green-yellow	2016-7607	243

## TOPJOB® S

## Multilevel Installation Terminal Blocks with Internal N-Disconnection

2.5 (4) mm<sup>2</sup>, 2003 Series

250 V/4 kV potential – ground  
400 V/6 kV potential – potential

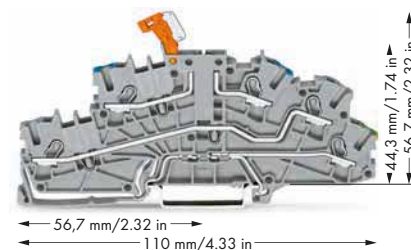

Multilevel installation terminal block, with pivoting knife disconnect, gray

	Item No.	Pack. Unit
○ NTi/L/PE	2003-6641	50
○ NTi/L/PE	2003-6644	50

#### Technical Data

Ratings, note	Potential – ground
Rated voltage (III / 3)	250 V
Rated surge voltage (III / 3)	4 kV
Ratings, note (2)	Potential - potential
Rated voltage (III / 3) (2)	400 V
Rated surge voltage (III / 3) (2)	6 kV
Rated current	20 A
Rated current (2)	25 A
Nominal cross section	2.5 mm <sup>2</sup>
<b>Connection Data</b>	
Solid conductor	0.25 ... 4 mm <sup>2</sup> / 22 ... 12 AWG
Solid conductor, push-in termination	0.75 ... 4 mm <sup>2</sup> / 18 ... 12 AWG
Fine-stranded conductor	0.25 ... 4 mm <sup>2</sup> / 22 ... 12 AWG
Fine-stranded conductor with ferrule, push-in termination, min.	0.75 mm <sup>2</sup> / 18 AWG
Strip length	10 ... 12 mm / 0.39 ... 0.47 inch
Terminal block width	5.2 mm / 0.205 inch
Insulation material	Polyamide 66 (PA 66)

#### Accessories (Selection)

	Item No.	Page
Push-in type jumper bar, insulated, I <sub>N</sub> 25 A, light gray	2002-402	246
End and intermediate plate, 0.8 mm thick	orange 2003-6692	247
WMB Inline, plain, 1,500 WMB markers (5 mm) per reel, 5 ... 5.2 mm stretchable	white 2009-115	780
Marking strip, plain, 11 mm wide, 50 m reel	white 2009-110	783
N/L-test plug adapter, for multilevel installation terminal blocks (2003-6641 and 2003-6640), for vertical test slot, gray	2-pole 2003-499	248
N-test plug adapter, for multilevel installation terminal blocks (2003-6641 and 2003-6640), for vertical test slot, gray	1-pole 2003-500	248
N-supply terminal block, I <sub>N</sub> 76 A, 16 mm <sup>2</sup> 12 mm wide	blue 2016-7714	243
Ground supply terminal block, 16 mm <sup>2</sup> , 12 mm wide	green-yellow 2016-7607	243

Standard accessories for installation rail-mount terminal blocks, see page 250

Accessories (jumpers, end plates, etc.), see page 246

Carrier rails and tools, see Section 13

Appropriate marking system, WMB/WMB Inline/marketing strips, see Full Line Catalog, Volume 6

Approvals and corresponding ratings, visit [www.wago.com](http://www.wago.com)



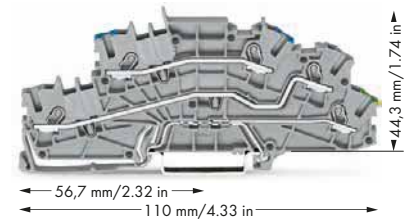
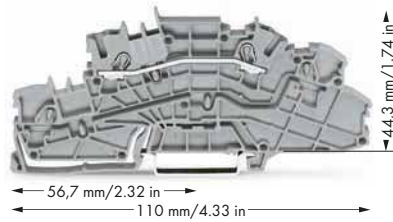
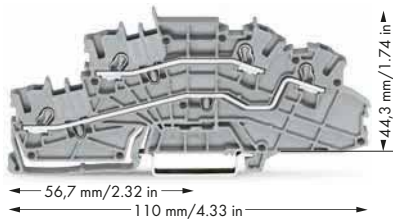

Multilevel installation terminal block, gray

	Item No.	Pack. Unit
○ L/L	2003-6642	50
○ N/L	2003-6649	50

400 V  
6 kV

24 A  
28 A  
2.5 mm<sup>2</sup>

0.25 ... 4 mm<sup>2</sup> / 22 ... 12 AWG  
0.75 ... 4 mm<sup>2</sup> / 18 ... 12 AWG  
0.25 ... 4 mm<sup>2</sup> / 22 ... 12 AWG  
0.75 mm<sup>2</sup> / 18 AWG

10 ... 12 mm / 0.39 ... 0.47 inch  
5.2 mm / 0.205 inch  
Polyamide 66 (PA 66)

	Item No.	Page
2-way	2002-402	246
orange	2003-6692	247
white	2009-115	780
white	2009-110	783
blue	2016-7714	243
green-yellow	2016-7607	243

Multilevel installation terminal block, gray

	Item No.	Pack. Unit
○ L	2003-6650	50
○ N	2003-6651	50

400 V  
6 kV

24 A  
28 A  
2.5 mm<sup>2</sup>

0.25 ... 4 mm<sup>2</sup> / 22 ... 12 AWG  
0.75 ... 4 mm<sup>2</sup> / 18 ... 12 AWG  
0.25 ... 4 mm<sup>2</sup> / 22 ... 12 AWG  
0.75 mm<sup>2</sup> / 18 AWG

10 ... 12 mm / 0.39 ... 0.47 inch  
5.2 mm / 0.205 inch  
Polyamide 66 (PA 66)

	Item No.	Page
2-way	2002-402	246
orange	2003-6692	247
white	2009-115	780
white	2009-110	783
blue	2016-7714	243
green-yellow	2016-7607	243

Multilevel installation terminal block, gray

	Item No.	Pack. Unit
○ N/L/PE	2003-6646	50
○ L/L/PE	2003-6645	50

Potential - ground  
250 V  
4 kV

Potential - potential  
400 V  
6 kV  
24 A  
28 A  
2.5 mm<sup>2</sup>

0.25 ... 4 mm<sup>2</sup> / 22 ... 12 AWG  
0.75 ... 4 mm<sup>2</sup> / 18 ... 12 AWG  
0.25 ... 4 mm<sup>2</sup> / 22 ... 12 AWG  
0.75 mm<sup>2</sup> / 18 AWG

10 ... 12 mm / 0.39 ... 0.47 inch  
5.2 mm / 0.205 inch  
Polyamide 66 (PA 66)

	Item No.	Page
2-way	2002-402	246
orange	2003-6692	247
white	2009-115	780
white	2009-110	783
blue	2016-7714	243
green-yellow	2016-7607	243

## TOPJOB® S

### Multilevel Installation Terminal Blocks

#### 2.5 (4) mm<sup>2</sup>, 2003 Series

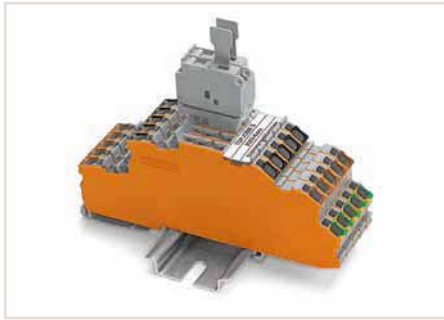

250 V/4 kV potential – ground  
400 V/6 kV potential – potential

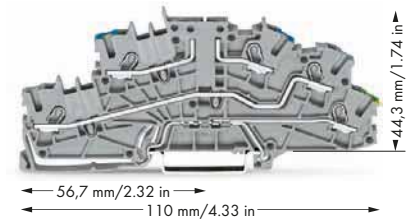

3

In combination with the 1 mm thick end and intermediate plate (2003-6693), the single fuse holder (2004-911) can also be used with the carrier terminal blocks (2003-6640 and 2003-6643).

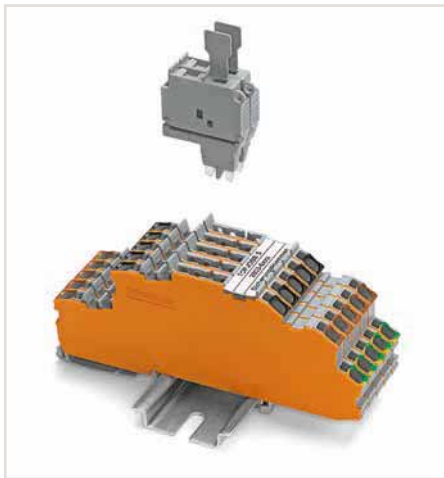

Multilevel installation terminal block, carrier terminal block without knife disconnect, gray

	Item No.	Pack. Unit
○ N/L/PE	2003-6640	50

Multilevel installation terminal block, carrier terminal block without knife disconnect, black upper-deck, brown middle-deck, green-yellow lower-deck printing, gray

	Item No.	Pack. Unit
○ P2/P1/PE	2003-6643	50

Multilevel installation terminal block, carrier terminal block without knife disconnect, brown upper-deck, black middle-deck, green-yellow lower-deck printing, gray

	Item No.	Pack. Unit
○ P1/P2/PE	2003-6660	50

#### Technical Data

Ratings, note	Potential – ground
Rated voltage (III / 3)	250 V
Rated surge voltage (III / 3)	4 kV
Ratings, note (2)	Potential - potential
Rated voltage (III / 3) (2)	400 V
Rated surge voltage (III / 3) (2)	6 kV
Rated current	10 A
Nominal cross section	2.5 mm <sup>2</sup>
<b>Connection Data</b>	
Solid conductor	0.25 ... 4 mm <sup>2</sup> / 22 ... 12 AWG
Solid conductor, push-in termination	0.75 ... 4 mm <sup>2</sup> / 18 ... 12 AWG
Fine-stranded conductor	0.25 ... 4 mm <sup>2</sup> / 22 ... 12 AWG
Fine-stranded conductor with ferrule, push-in termination, min.	0.75 mm <sup>2</sup> / 18 AWG
Strip length	10 ... 12 mm / 0.39 ... 0.47 inch
Terminal block width	5.2 mm / 0.205 inch
Insulation material	Polyamide 66 (PA 66)
<b>Note:</b>	Maximum current depends on accessories used.

#### Accessories (Selection)

Push-in type jumper bar, insulated, I <sub>n</sub> 25 A, light gray	2-way	2002-402	246
End and intermediate plate, 0.8 mm thick	orange	2003-6692	247
WMB Inline, plain, 1,500 WMB markers (5 mm) per reel, 5 ... 5.2 mm stretchable	white	2009-115	780
Marking strip, plain, 11 mm wide, 50 m reel	white	2009-110	783
Fuse plug with pull-tab, for (5 x 20) mm miniature metric fuses, 6.1 mm wide	gray	2004-911	121
Electrical ratings are given by the fuse.			
End and intermediate plate, 1 mm thick, only for use with fuse plugs	orange	2003-6693	247
Double-fuse plug, for (5 x 20) mm miniature metric fuse, 10.4 mm wide	gray	2003-911	239
Double-fuse plug, for (5 x 20) mm miniature metric fuse, with indicator lamp	gray	2003-911/1000-923	239

Standard accessories for installation rail-mount terminal blocks, see page 250

Accessories (jumpers, end plates, etc.), see page 246

Carrier rails and tools, see Section 13

Appropriate marking system, WMB/WMB Inline/marketing strips, see Full Line Catalog, Volume 6

Approvals and corresponding ratings, visit [www.wago.com](http://www.wago.com)

## TOPJOB® S

## Fuse Plugs (2003 Series) on Carrier Terminal Blocks (2002 and 2003 Series)



3

## Miniature metric fuses 5 x 20

Series Item No.	Overload and short circuit protection		Short circuit protection only	
	Individual argmt.	Group argmt.	Individual argmt.	Group argmt.
Fuse terminal blocks				
2003-911	1.6 W	1.6 W	2.5 W	2.5 W
2003-911/.....				

Double-fuse plug, for (5 x 20) mm miniature metric fuse, 10.4 mm wide  
Electrical ratings are given by the fuse.

Color	Item No.	Pack. Unit
○ gray	2003-911	25

Double-fuse plug, for (5 x 20) mm miniature metric fuse, with LED, gray  
Electrical ratings are given by the fuse and blown fuse indication. LED 0.25 mA

	Item No.	Pack. Unit
○ 230 V	2003-911/1000-923	25

## Technical Data

Rated voltage (III / 3)	250 V
Rated current	6.3 A
Plug width	10.4 mm / 0.409 inch

## Accessories (Selection)

	Item No.	Page
2-conductor carrier terminal block, 0.25 ... 4 mm <sup>2</sup> (22 ... 12 AWG), 5.2 mm (0.205 inch) wide	gray 2002-1661	83
3-conductor carrier terminal block, 0.25 ... 4 mm <sup>2</sup> (22 ... 12 AWG), 5.2 mm (0.205 inch) wide	gray 2002-1761	85
4-conductor carrier terminal block, 0.25 ... 4 mm <sup>2</sup> (22 ... 12 AWG), 5.2 mm (0.205 inch) wide	gray 2002-1861	87
2-conductor carrier terminal block, 0.25 ... 4 mm <sup>2</sup> (22 ... 12 AWG), 5.2 mm (0.205 inch) wide	gray 2002-1661	93
Double-deck carrier terminal block, 0.25 ... 4 mm <sup>2</sup> (22 ... 12 AWG), 5.2 mm (0.205 inch) wide	L/L 2002-2961	81
Double-deck carrier terminal block, 0.25 ... 4 mm <sup>2</sup> (22 ... 12 AWG), 5.2 mm (0.205 inch) wide	L/N 2002-2963	81
Double-deck carrier terminal block, 0.25 ... 4 mm <sup>2</sup> (22 ... 12 AWG), 5.2 mm (0.205 inch) wide	L/L 2002-2941	81
Multilevel installation terminal block, 0.25 ... 4 mm <sup>2</sup> (22 ... 12 AWG), 5.2 mm (0.205 inch) wide	N/L/PE 2003-6640	236
Multilevel installation terminal block, 0.25 ... 4 mm <sup>2</sup> (22 ... 12 AWG), 5.2 mm (0.205 inch) wide	P2/P1/PE 2003-6643	236
Multilevel installation terminal block, 0.25 ... 4 mm <sup>2</sup> (22 ... 12 AWG), 5.2 mm (0.205 inch) wide	P1/P2/PE 2003-6660	236
End plate for fuse terminal blocks, 2 mm thick	orange 2002-992	167
Shorting link, (5 x 20) mm, suitable when using the fuse plug as a disconnect plug, I <sub>n</sub> 6.3 A	281-503	175

 Carrier rails and tools, see Section 13

 Appropriate marking system, WMB/markings strips, see Full Line Catalog, Volume 6

 Approvals and corresponding ratings, visit [www.wago.com](http://www.wago.com)

## TOPJOB® S

## Multilevel Installation Terminal Blocks with N-Disconnect Slide Links

4 (6) mm<sup>2</sup>, 2005 Series

250 V/4 kV potential – ground  
400 V/6 kV potential – potential



Multilevel installation terminal block, with N-disconnect slide link, gray

	Item No.	Pack. Unit
○ NT/L/PE	2005-7641	50

#### Technical Data

Ratings, note	Potential – ground
Rated voltage (III / 3)	250 V
Rated surge voltage (III / 3)	4 kV
Ratings, note (2)	Potential - potential
Rated voltage (III / 3) (2)	400 V
Rated surge voltage (III / 3) (2)	6 kV
Rated current	36 A
Rated current (2)	36 A
Nominal cross section	4 mm <sup>2</sup>
<b>Connection Data</b>	
Solid conductor	0.5 ... 6 mm <sup>2</sup> / 20 ... 10 AWG
Solid conductor, push-in termination	1 ... 6 mm <sup>2</sup> / 14 ... 10 AWG
Fine-stranded conductor	0.5 ... 6 mm <sup>2</sup> / 20 ... 10 AWG
Fine-stranded conductor with ferrule, push-in termination, min.	0.75 mm <sup>2</sup> / 18 AWG
Strip length	11 ... 13 mm / 0.43 ... 0.51 inch
Terminal block width	6.2 mm / 0.244 inch
Insulation material	Polyamide 66 (PA 66)

#### Accessories (Selection)

	Item No.	Page
Push-in type jumper bar, insulated, I <sub>N</sub> 32 A, light gray	2004-402	249
End and intermediate plate, 0.8 mm thick	orange 2005-7692	249
WMB Inline, plain, 1,500 WMB markers (5 mm) per reel, 5 ... 5.2 mm stretchable	white 2009-115	780
Marking strip, plain, 11 mm wide, 50 m reel	white 2009-110	783
Lock-out, prevents reclosing of slide link, snap-on type	orange 2005-7300	249
N-supply terminal block, I <sub>N</sub> 76 A, 16 mm <sup>2</sup> 12 mm wide	blue 2016-7714	243
Ground supply terminal block, 16 mm <sup>2</sup> , 12 mm wide	green-yellow 2016-7607	243

#### Application note:

N-disconnect slide links, used in installation terminal blocks, consist of switch contacts that are opened and then closed as part of the regular circuit testing. To guarantee a reliable connection, a corrosion-resistant contact area is required on the N-busbar.

Historically, uninsulated copper busbars, that have been cleaned/stripped of any possible corrosion prior to install, can be used in dry, pollution-free locations.

According to DIN VDE 0100-520 (VDE 0100, Part 520), installation equipment exposed to contamination or corrosive substances (e.g., water) that promote corrosion or deterioration, must be protected or made of a corrosion- or wear-resistant material. In these cases, tinned copper busbars guarantee a reliable connection.

WAGO only offers tinned copper busbars.

Standard accessories for installation rail-mount terminal blocks, see page 250

Accessories (jumpers, end plates, etc.), see page 249

Carrier rails and tools, see Section 13

Appropriate marking system, WMB/WMB Inline/markings strips, see Full Line Catalog, Volume 6

Approvals and corresponding ratings, visit [www.wago.com](http://www.wago.com)

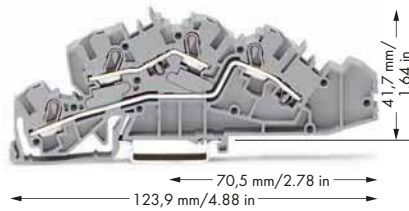
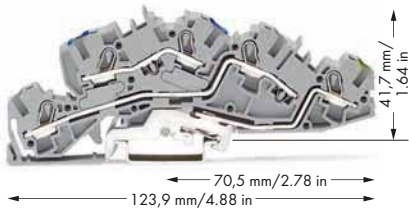

Multilevel installation terminal block, with N-disconnect slide link, gray

	Item No.	Pack. Unit
○ NT/L	2005-7640	50
○ LT/L	2005-7659	50

Multilevel installation terminal block, gray

	Item No.	Pack. Unit
○ L/L	2005-7642	50
○ N/L	2005-7649	50

Potential - ground

250 V

4 kV

Potential - potential

400 V

6 kV

32 A

32 A

4 mm<sup>2</sup>

400 V

6 kV

32 A

4 mm<sup>2</sup>

0.5 ... 6 mm<sup>2</sup> / 20 ... 10 AWG

1 ... 6 mm<sup>2</sup> / 14 ... 10 AWG

0.5 ... 6 mm<sup>2</sup> / 20 ... 10 AWG

0.75 mm<sup>2</sup> / 18 AWG

11 ... 13 mm / 0.43 ... 0.51 inch

6.2 mm / 0.244 inch

Polyamide 66 (PA 66)

0.5 ... 6 mm<sup>2</sup> / 20 ... 10 AWG

1 ... 6 mm<sup>2</sup> / 14 ... 10 AWG

0.5 ... 6 mm<sup>2</sup> / 20 ... 10 AWG

0.75 mm<sup>2</sup> / 18 AWG

11 ... 13 mm / 0.43 ... 0.51 inch

6.2 mm / 0.244 inch

Polyamide 66 (PA 66)

	Item No.	Page
2-way	2004-402	249
orange	2005-7692	249
white	2009-115	780
white	2009-110	783
orange	2005-7300	249
blue	2016-7714	243
green-yellow	2016-7607	243

	Item No.	Page
2-way	2004-402	249
orange	2005-7692	249
white	2009-115	780
white	2009-110	783
blue	2016-7714	243
green-yellow	2016-7607	243

## TOPJOB® S

## N-Conductor and Power Distribution Disconnect Terminal Blocks

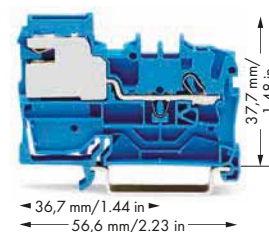
2.5 (4) mm<sup>2</sup>, 2002 Series and 4 (6) mm<sup>2</sup>, 2006 Series and 16 (25 "f-st") mm<sup>2</sup>, 2016 Series

## 1-conductor N-disconnect terminal block

Color	Item No.	Pack. Unit
● blue	2002-7114	50

## 1-conductor power distribution disconnect terminal block

Color	Item No.	Pack. Unit
● gray	2002-7111	50

## Technical Data

Rated voltage (III / 3)	250 V
Rated surge voltage (III / 3)	4 kV
Rated current	32 A
Nominal cross section	2.5 mm <sup>2</sup>

## Connection Data

Solid conductor	0.25 ... 4 mm <sup>2</sup> / 22 ... 12 AWG
Solid conductor, push-in termination	0.75 ... 4 mm <sup>2</sup> / 18 ... 12 AWG
Fine-stranded conductor	0.25 ... 4 mm <sup>2</sup> / 22 ... 12 AWG
Fine-stranded conductor with ferrule, push-in termination, min.	0.75 mm <sup>2</sup> / 18 AWG
Strip length	10 ... 12 mm / 0.39 ... 0.47 inch
Terminal block width	5.2 mm / 0.205 inch
Insulation material	Polyamide 66 (PA 66)

## Accessories (Selection)

	Item No.	Page
Push-in type jumper bar, insulated, I <sub>n</sub> 25 A, light gray	2002-402	246
Push-in type jumper bar, insulated, I <sub>n</sub> 41 A, light gray		
Push-in type jumper bar, insulated, I <sub>n</sub> 76 A, light gray		
End and intermediate plate, 0.8 mm thick	orange	2002-7192
End and intermediate plate, 0.8 mm thick		
End and intermediate plate, 1 mm thick		
End and intermediate plate, 1 mm thick		
WMB Inline, plain, 1,500 WMB markers (5 mm) per reel, 5 ... 5.2 mm stretchable	white	2009-115
Marking strip, plain, 11 mm wide, 50 m reel	white	2009-110
Lock-out, prevents reclosing of slide link, snap-on type	orange	2005-7300
Lock-out, prevents reclosing of slide link, snap-on type		

For the construction and operation of power installations in fire-prone, hazardous locations or public buildings – such as conference centers, stores, hospitals, schools, theaters or hotels – the DIN VDE 0100-710 or DIN VDE 0100-718 standards shall be observed. DIN VDE 0100-482 shall also be observed for fire-prone, hazardous locations. These VDE regulations mandate that every neutral conductor must be provided with a disconnection device so, e.g., insulation testing is possible for every circuit without disconnecting the N-conductor. WAGO N-disconnect terminal blocks meet this requirement.

According to DIN VDE 0100-710 "Requirements for operating facilities, rooms and special installations – medical facilities," equipotential bonding conductors shall be run on a potential equalization busbar. The potential equalization busbar and the protective ground conductor busbar must be mounted in a common housing and be connected to each other using a disconnectable copper conductor of minimum 16 mm<sup>2</sup> (AWG 6). Furthermore, all equipotential bonding conductors must be connected to the potential equalization busbar and clearly arranged so they can be disconnected individually and accessed at any time. Depending on their function, they must also be provided with captive marking. WAGO power distribution disconnect terminal blocks meet these requirements.

Standard accessories for installation rail-mount terminal blocks, see page 250

Accessories, 2002 Series (jumpers, end plates, etc.), see page 246

Accessories, 2006 Series (jumpers, end plates, etc.), see page 250

Accessories, 2016 Series (jumpers, end plates, etc.), see page 251

Carrier rails and tools, see Section 13

Appropriate marking system, WMB/WMB Inline/markings strips, see Full Line Catalog, Volume 6

Approvals and corresponding ratings, visit [www.wago.com](http://www.wago.com)



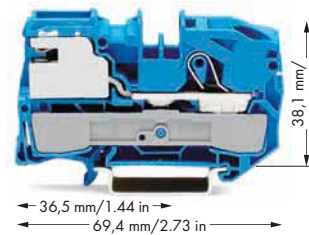
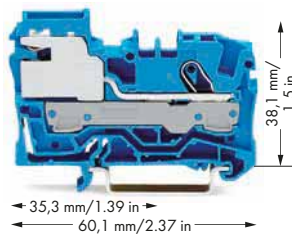
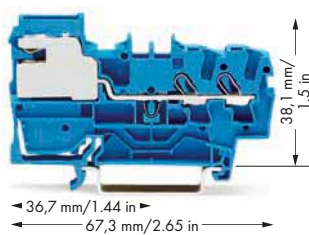

**2-conductor N-disconnect terminal block**

Color	Item No.	Pack. Unit
● blue	2002-7214	50

**1-conductor N-disconnect terminal block**

Color	Item No.	Pack. Unit
● blue	2006-7114	50

**1-conductor N-disconnect terminal block**

Color	Item No.	Pack. Unit
● blue	2016-7114	25

**2-conductor power distribution disconnect terminal block**

Color	Item No.	Pack. Unit
○ gray	2002-7211	50

**1-conductor power distribution disconnect terminal block**

Color	Item No.	Pack. Unit
○ gray	2006-7111	50

**1-conductor power distribution disconnect terminal block**

Color	Item No.	Pack. Unit
○ gray	2016-7111	25

250 V
4 kV
32 A
2.5 mm <sup>2</sup>

250 V
4 kV
51 A
6 mm <sup>2</sup>

250 V
4 kV
76 A
16 mm <sup>2</sup>

0.25 ... 4 mm <sup>2</sup> / 22 ... 12 AWG
0.75 ... 4 mm <sup>2</sup> / 18 ... 12 AWG
0.25 ... 4 mm <sup>2</sup> / 22 ... 12 AWG
0.75 mm <sup>2</sup> / 18 AWG

0.5 ... 10 mm <sup>2</sup> / 20 ... 8 AWG
1 ... 10 mm <sup>2</sup> / 14 ... 8 AWG
0.5 ... 10 mm <sup>2</sup> / 20 ... 8 AWG
1.5 mm <sup>2</sup> / 16 AWG

0.5 ... 16 mm <sup>2</sup> / 20 ... 6 AWG
2.5 ... 16 mm <sup>2</sup> / 14 ... 6 AWG
0.5 ... 16 mm <sup>2</sup> / 20 ... 6 AWG
2.5 mm <sup>2</sup> / 14 AWG

10 ... 12 mm / 0.39 ... 0.47 inch
5.2 mm / 0.205 inch
Polyamide 66 (PA 66)

13 ... 15 mm / 0.51 ... 0.59 inch
7.5 mm / 0.295 inch
Polyamide 66 (PA 66)

18 ... 20 mm / 0.71 ... 0.79 inch
12 mm / 0.472 inch
Polyamide 66 (PA 66)

	Item No.	Page
2-way	2002-402	246
orange	2002-7292	248
white	2009-115	780
white	2009-110	783
orange	2005-7300	248

	Item No.	Page
2-way	2006-402	250
orange	2006-7192	
white	2009-115	780
white	2009-110	783
orange	2006-7300	250

	Item No.	Page
2-way	2016-402	251
orange	2016-7192	
white	2009-115	780
white	2009-110	783
orange	2006-7300	251

## TOPJOB® S

## N-Conductor and Power Distribution Disconnect Terminal Blocks

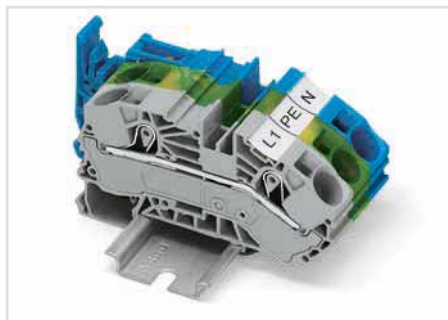
16 (25 "f") mm<sup>2</sup>, 2016 Series

3

With an angled conductor entry, the 2016 Series Supply Terminal Blocks simplify the wiring of solid conductors in distribution boxes. Solid conductors of the largest cross section can be connected easily, enabling the distribution box cover to fit without interfering with the conductors.

For the construction and operation of power installations in fire-prone, hazardous locations or public buildings – such as conference centers, stores, hospitals, schools, theaters or hotels – the DIN VDE 0100-710 or DIN VDE 0100-718 standards shall be observed. DIN VDE 0100-482 shall also be observed for fire-prone, hazardous locations. These VDE regulations mandate that every neutral conductor must be provided with a disconnection device so, e.g., insulation testing is possible for every circuit without disconnecting the N-conductor. WAGO N-disconnect terminal blocks meet this requirement.

According to DIN VDE 0100-710 "Requirements for operating facilities, rooms and special installations – medical facilities," equipotential bonding conductors shall be run on a potential equalization busbar. The potential equalization busbar and the protective ground conductor busbar must be mounted in a common housing and be connected to each other using a disconnectable copper conductor of minimum 16 mm<sup>2</sup> (AWG 6). Furthermore, all equipotential bonding conductors must be connected to the potential equalization busbar and clearly arranged so they can be disconnected individually and accessed at any time. Depending on their function, they must also be provided with captive marking.

WAGO power distribution disconnect terminal blocks meet these requirements.

Standard accessories for installation rail-mount terminal blocks, see page 250

Accessories (jumpers, end plates, etc.), see page 251

Carrier rails and tools, see Section 13

Appropriate marking system, WMB/WMB Inline/marketing strips, see Full Line Catalog, Volume 6

Approvals and corresponding ratings, visit [www.wago.com](http://www.wago.com)

Rail-mount terminal blocks with an Ex mark are suitable for Ex e II applications. Terminal blocks with a blue insulated housing are suitable for Ex i applications.



2-conductor supply terminal blocks for distribution boxes

Color	Item No.	Pack. Unit
gray	2016-7601	20
blue	2016-7604	20

#### Technical Data

Ratings per	IEC/EN 60947-7-1
Rated voltage (III / 3)	800 V
Rated surge voltage (III / 3)	8 kV
Rated current	76 A
Nominal cross section	16 mm <sup>2</sup>

#### Connection Data

Solid conductor	0.5 ... 16 mm <sup>2</sup> / 20 ... 6 AWG
Solid conductor, push-in termination	2.5 ... 16 mm <sup>2</sup> / 14 ... 6 AWG
Fine-stranded conductor	0.5 ... 25 mm <sup>2</sup> / 20 ... 4 AWG
Fine-stranded conductor with ferrule, push-in termination, min.	2.5 mm <sup>2</sup> / 14 AWG
Strip length	18 ... 20 mm / 0.71 ... 0.79 inch
Terminal block width	12 mm / 0.472 inch
Insulation material	Polyamide 66 (PA 66)

#### Note:

#### Accessories (Selection)

	Item No.	Page
Push-in type jumper bar, insulated, I <sub>n</sub> 76 A, light gray	2016-402	251
End and intermediate plate, 1 mm thick	2016-7692	251
End and intermediate plate, 1 mm thick		
WMB Multi marking system, white, 10 strips with 10 markers per card, 5 ... 5.2 mm stretchable	793-5501	780
Marking strip, plain, 11 mm wide, 50 m reel	2009-110	783
Lock-out, prevents reclosing of slide link, snap-on type		

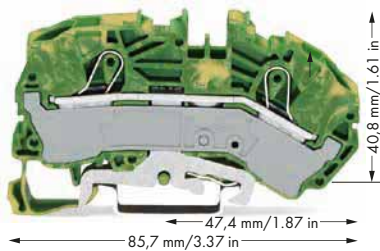

2-conductor ground terminal block

Color	Item No.	Pack. Unit
● green-yellow	2016-7607	

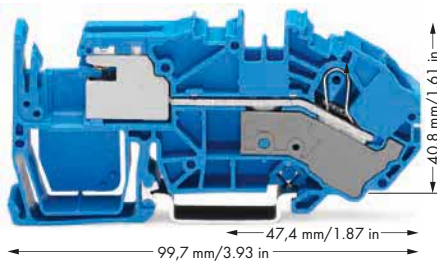

1-conductor N-disconnect terminal block

Color	Item No.	Pack. Unit
● blue	2016-7714	20

1-conductor power distribution disconnect terminal block

Color	Item No.	Pack. Unit
● gray	2016-7711	20

IEC/EN 60947-7-2

16 mm<sup>2</sup>

0.5 ... 16 mm<sup>2</sup> / 20 ... 6 AWG  
 2.5 ... 16 mm<sup>2</sup> / 14 ... 6 AWG  
 0.5 ... 25 mm<sup>2</sup> / 20 ... 4 AWG  
 2.5 mm<sup>2</sup> / 14 AWG

18 ... 20 mm / 0.71 ... 0.79 inch  
 12 mm / 0.472 inch  
 Polyamide 66 (PA 66)

15 mm high DIN-35 rails shall be used for a current load higher than 76 A!

	Item No.	Page
2-way	2016-402	251
orange	2016-7692	251
plain	793-5501	780
white	2009-110	783

250 V

4 kV

76 A

16 mm<sup>2</sup>

0.5 ... 16 mm<sup>2</sup> / 20 ... 6 AWG  
 2.5 ... 16 mm<sup>2</sup> / 14 ... 6 AWG  
 0.5 ... 25 mm<sup>2</sup> / 20 ... 4 AWG  
 2.5 mm<sup>2</sup> / 14 AWG

18 ... 20 mm / 0.71 ... 0.79 inch  
 12 mm / 0.472 inch  
 Polyamide 66 (PA 66)

	Item No.	Page
2-way	2016-402	251
orange	2016-7792	251
plain	793-5501	780
white	2009-110	783
orange	2006-7300	251

## TOPJOB® S

Accessories, 2003 and 2002 Series or a 5.2 mm Terminal Block Width  
Commoning, Mounting, Marking and Testing

 Push-in type jumper bars,  
see page 23

Push-in type jumper bar, insulated, I<sub>N</sub> 25 A

	light gray Item No.	red Item No.	blue Item No.	Pack. Unit
2-way	2002-402	2002-402/000-005	2002-402/000-006	200 (25)
3-way	2002-403	2002-403/000-005	2002-403/000-006	200 (25)
4-way	2002-404	2002-404/000-005	2002-404/000-006	200 (25)
5-way	2002-405	2002-405/000-005	2002-405/000-006	100 (25)
6-way	2002-406	2002-406/000-005	2002-406/000-006	100 (25)
7-way	2002-407	2002-407/000-005	2002-407/000-006	100 (25)
8-way	2002-408	2002-408/000-005	2002-408/000-006	100 (25)
9-way	2002-409	2002-409/000-005	2002-409/000-006	100 (25)
10-way	2002-410	2002-410/000-005	2002-410/000-006	100 (25)



Push-in type jumper bar, insulated, I<sub>N</sub> 14 A, light gray

	Item No.	Pack. Unit
1 to 3	2002-433	200 (25)
1 to 4	2002-434	200 (25)
1 to 5	2002-435	100 (25)
1 to 6	2002-436	100 (25)
1 to 7	2002-437	100 (25)
1 to 8	2002-438	100 (25)
1 to 9	2002-439	100 (25)
1 to 10	2002-440	100 (25)



 Staggered jumpers,  
see page 24

Note: Push down the staggered jumper until fully inserted.

Rated voltage (III / 3)	400 V
Rated surge voltage (III / 3)	6 kV

Staggered jumper, insulated, I<sub>N</sub> 25 A, light gray

	Item No.	Pack. Unit
2-way	2002-472	100 (25)
3-way	2002-473	100 (25)
4-way	2002-474	100 (25)
5-way	2002-475	50 (25)
6-way	2002-476	50 (25)
7-way	2002-477	50 (25)
8-way	2002-478	50 (25)
9-way	2002-479	50 (25)
10-way	2002-480	50 (25)
11-way	2002-481	50 (25)
12-way	2002-482	50 (25)

Note: Push down the staggered jumper until fully inserted.

Rated voltage (III / 3)	400 V
Rated surge voltage (III / 3)	6 kV

Customized staggered jumper, insulated, with contact lugs broken off at the factory and circuit printing, I<sub>N</sub> 25 A, light gray

	Item No.	Pack. Unit
2-way (1-3)	2002-473/011-000	100 (25)
3-way (1-3-5)	2002-475/011-000	50 (25)
4-way (1-3-5-7)	2002-477/011-000	50 (25)
5-way (1-3-5-7-9)	2002-479/011-000	50 (25)
6-way (1-3-5-7-9-11)	2002-481/011-000	50 (25)



## TOPJOB® S

Accessories, 2003 and 2002 Series or a 5.2 mm Terminal Block Width  
Commoning, Mounting, Marking and Testing

Adjacent jumper for continuous commoning, see page 25

Adjacent jumper for continuous commoning, insulated, 800 V, I <sub>N</sub> 25 A, light gray		
	Item No.	Pack. Unit
2-way	2002-400	100 (25)



Adjacent jumper for continuous commoning, see page 25

Rated voltage (III / 3)	800 V
Rated surge voltage (III / 3)	8 kV

Adjacent jumper for continuous commoning, insulated, I <sub>N</sub> 25 A, 1 to 3		
Color	Item No.	Pack. Unit
light gray	2002-423	100 (25)
red	2002-423/000-005	100 (25)
blue	2002-423/000-006	100 (25)



Delta jumper, see page 26

Delta jumper, insulated, I <sub>N</sub> = I <sub>N</sub> terminal block, light gray		
	Item No.	Pack. Unit
1-2 3-4 5-6	2002-406/020-000	100 (25)



Star point jumper, see page 26

Star point jumper, insulated, I <sub>N</sub> = I <sub>N</sub> terminal block, light gray		
	Item No.	Pack. Unit
1-3-5	2002-405/011-000	100 (25)



Push-in type wire jumpers, see page 26

Note: Push down the wire jumper until fully inserted.

Rated voltage (III / 3)	800 V
Rated surge voltage (III / 3)	8 kV

Push-in type wire jumper, insulated, 1.5 mm <sup>2</sup> conductor cross-section, for 2001, 2002, 2003 and 2022 Series rail-mount terminal blocks, I <sub>N</sub> 18 A		
	Item No.	Pack. Unit
L = 60 mm	2009-412	100 (10)
L = 110 mm	2009-414	100 (10)
L = 250 mm	2009-416	100 (10)



End and intermediate plate, 0.8 mm thick			
Suitable for:	Color	Item No.	Pack. Unit
2003-7641	orange	2003-7692	100 (25)



End and intermediate plate, 0.8 mm thick			
Suitable for:	Color	Item No.	Pack. Unit
2003-6641	orange	2003-6692	100 (25)



End and intermediate plate, 1 mm thick, only for use with fuse plugs			
Suitable for:	Color	Item No.	Pack. Unit
2003-6640	orange	2003-6693	100 (25)



End and intermediate plate, 0.8 mm thick			
Suitable for:	Color	Item No.	Pack. Unit
2002-7114	orange	2002-7192	100 (25)

## TOPJOB® S

Accessories, 2003 and 2002 Series or a 5.2 mm Terminal Block Width  
Commoning, Mounting, Marking and Testing

End and intermediate plate, 0.8 mm thick			
Suitable for:	Color	Item No.	Pack. Unit
2002-7214	orange	2002-7292	100 (25)



N/L-test plug adapter, for multilevel installation terminal blocks (2003-6641 and 2003-6640), for vertical test slot, gray			
Suitable for:	Color	Item No.	Pack. Unit
2003-6641	gray	2003-499	100 (25)



N-test plug adapter, for multilevel installation terminal blocks (2003-6641 and 2003-6640), for vertical test slot, gray			
Suitable for:	Color	Item No.	Pack. Unit
2003-6641	gray	2003-500	100 (25)



 Technical data,  
see page 121

Fuse plug with pull-tab, for (5 x 20) mm miniature metric fuses, 6.1 mm wide			
Suitable for:	Color	Item No.	Pack. Unit
2003-6640	gray	2004-911	50



Lock-out, prevents reclosing of slide link, snap-on type			
Suitable for:	Color	Item No.	Pack. Unit
2003-6641	orange	2003-7300	100 (25)



Lock-out, prevents reclosing of slide link, snap-on type			
Suitable for:	Color	Item No.	Pack. Unit
2002-7114	orange	2005-7300	100 (25)



Protective warning marker, with black high-voltage symbol, for 5 terminal blocks			
Color		Item No.	Pack. Unit
yellow		2002-115	100 (25)



Insulation stop, 0.25 ... 0.5 mm <sup>2</sup> , 5 pcs/strip			
Color		Item No.	Pack. Unit
light gray		2002-171	200 (25)



Insulation stop, 0.75 ... 1 mm <sup>2</sup> , 5 pcs/strip			
Color		Item No.	Pack. Unit
dark gray		2002-172	200 (25)

3



## TOPJOB® S

Accessories, 2005 Series or a 6.2 mm Terminal Block Width  
Commoning, Mounting, Marking and Testing

 Push-in type jumper bars,  
see page 23

Push-in type jumper bar, insulated, I<sub>N</sub> 32 A, light gray

	Item No.	Pack. Unit
2-way	2004-402	200 (25)
3-way	2004-403	200 (25)
4-way	2004-404	100 (25)
5-way	2004-405	100 (25)
6-way	2004-406	100 (25)
7-way	2004-407	100 (25)
8-way	2004-408	100 (25)
9-way	2004-409	100 (25)
10-way	2004-410	100 (25)

Push-in type jumper bar, insulated, I<sub>N</sub> 32 A, light gray

	Item No.	Pack. Unit
1 to 3	2004-433	200 (25)
1 to 4	2004-434	200 (25)
1 to 5	2004-435	100 (25)
1 to 6	2004-436	100 (25)
1 to 7	2004-437	100 (25)
1 to 8	2004-438	100 (25)
1 to 9	2004-439	100 (25)
1 to 10	2004-440	100 (25)



 Delta jumper,  
see page 26

Delta jumper, insulated, I<sub>N</sub> = I<sub>N</sub> terminal block, light gray

	Item No.	Pack. Unit
1-2-3-4-5-6	2004-406/020-000	100 (25)



 Star point jumper,  
see page 26

Star point jumper, insulated, I<sub>N</sub> = I<sub>N</sub> terminal block, light gray

	Item No.	Pack. Unit
1-3-5	2004-405/011-000	100 (25)



## End and intermediate plate, 1 mm thick

Suitable for:	Color	Item No.	Pack. Unit
2005-7641	orange	2005-7692	100 (25)



## Lock-out, prevents reclosing of slide link, snap-on type

Suitable for:	Color	Item No.	Pack. Unit
2002-7114	orange	2005-7300	100 (25)



## Protective warning marker, with black high-voltage symbol, for 5 terminal blocks

Color	Item No.	Pack. Unit
yellow	2004-115	100 (25)

Insulation stop, 0.25 ... 0.5 mm<sup>2</sup>, 5 pcs/strip

Color	Item No.	Pack. Unit
light gray	2004-171	200 (25)

Insulation stop, 0.75 ... 1 mm<sup>2</sup>, 5 pcs/strip

Color	Item No.	Pack. Unit
dark gray	2004-172	200 (25)

## TOPJOB® S

Accessories, 2006 Series or a 7.5 mm Terminal Block Width  
Commoning, Mounting, Marking and Testing

 Push-in type jumper bars,  
see page 23

Push-in type jumper bar, insulated, I<sub>N</sub> 41 A, light gray

	Item No.	Pack. Unit
2-way	2006-402	50 (25)
3-way	2006-403	50 (25)
4-way	2006-404	50 (25)
5-way	2006-405	50 (25)

3



Push-in type jumper bar, insulated, I<sub>N</sub> 41 A, light gray

	Item No.	Pack. Unit
1 to 3	2006-433	50 (25)
1 to 4	2006-434	50 (25)
1 to 5	2006-435	50 (25)



 Star point jumper,  
see page 26

Star point jumper, insulated, I<sub>N</sub> = I<sub>N</sub> terminal block, light gray

	Item No.	Pack. Unit
1-3-5	2006-405/011-000	50 (25)



End and intermediate plate, 1 mm thick

Suitable for:	Color	Item No.	Pack. Unit
2006-7114	orange	2006-7192	100 (25)



Lock-out, prevents reclosing of slide link, snap-on type

Suitable for:	Color	Item No.	Pack. Unit
2006-7114	orange	2006-7300	100 (25)



Protective warning marker, with black high-voltage symbol, for 5 terminal blocks

Color	Item No.	Pack. Unit
yellow	2006-115	100 (25)

## TOPJOB® S

Accessories, 2016 Series or a 12 mm Terminal Block Width  
Commoning, Mounting, Marking and Testing

 Push-in type jumper bars,  
see page 23

Push-in type jumper bar, insulated, I<sub>N</sub> 76 A, light gray

	Item No.	Pack. Unit
2-way	2016-402	50 (25)
3-way	2016-403	50 (25)
4-way	2016-404	50 (25)
5-way	2016-405	50 (25)



Push-in type jumper bar, insulated, I<sub>N</sub> 76 A, light gray

	Item No.	Pack. Unit
1 to 3	2016-433	50 (25)
1 to 4	2016-434	50 (25)
1 to 5	2016-435	50 (25)



 Star point jumper,  
see page 26

Star point jumper, insulated, I<sub>N</sub> = I<sub>N</sub> terminal block, light gray

	Item No.	Pack. Unit
1-3-5	2016-405/011-000	50 (25)



End and intermediate plate, 1 mm thick

Suitable for:	Color	Item No.	Pack. Unit
2016-7114	orange	2016-7192	100 (25)



End and intermediate plate, 1 mm thick

Suitable for:	Color	Item No.	Pack. Unit
2016-7601	orange	2016-7692	100 (25)



End and intermediate plate, 1 mm thick

Suitable for:	Color	Item No.	Pack. Unit
2016-7714	orange	2016-7792	100 (25)



Lock-out, prevents reclosing of slide link, snap-on type

Suitable for:	Color	Item No.	Pack. Unit
2006-7114	orange	2006-7300	100 (25)



Protective warning marker, with black high-voltage symbol, for 5 terminal blocks

Color	Item No.	Pack. Unit
yellow	2016-115	50 (25)



Finger guard, touch-proof cover protects unused conductor entries

Color	Item No.	Pack. Unit
yellow	2016-100	100 (25)

## TOPJOB® S

## General Accessories for Installation Rail-Mount Terminal Blocks



Busbar carrier, not suitable as an end stop, snaps onto DIN-35 rail, 1.5 mm thick

Color	Item No.	Pack. Unit
blue	2009-304	100 (25)



Busbar carrier, with end stop function and detachable separator plate, snaps onto DIN-35 rail, 7.5 mm thick

Color	Item No.	Pack. Unit
blue	2009-305	25



Busbar cover, 1,000 mm long

Color	Item No.	Pack. Unit
transparent	777-303	1



Straight busbar, tin-plated, 1,000 mm long, copper (10 x 3) mm, I<sub>n</sub> 140 A

Item No.	Pack. Unit
210-133	1



Connector, for busbar, with blue cover, 2.5 ... 16 mm<sup>2</sup>

Color	Item No.	Pack. Unit
blue	210-281	100 (50)



Connector, for busbar, 2.5 ... 35 mm<sup>2</sup>

Color	Item No.	Pack. Unit
unplated	209-105	50



Operating tool, 3.5 mm and 2.5 mm blade width, for TOPJOB® S Installation Terminal Blocks

Item No.	Pack. Unit
2009-309	1



Operating tool, 3.5 mm and 5.5 mm blade width, for TOPJOB® S Installation Terminal Blocks

Item No.	Pack. Unit
2009-310	1



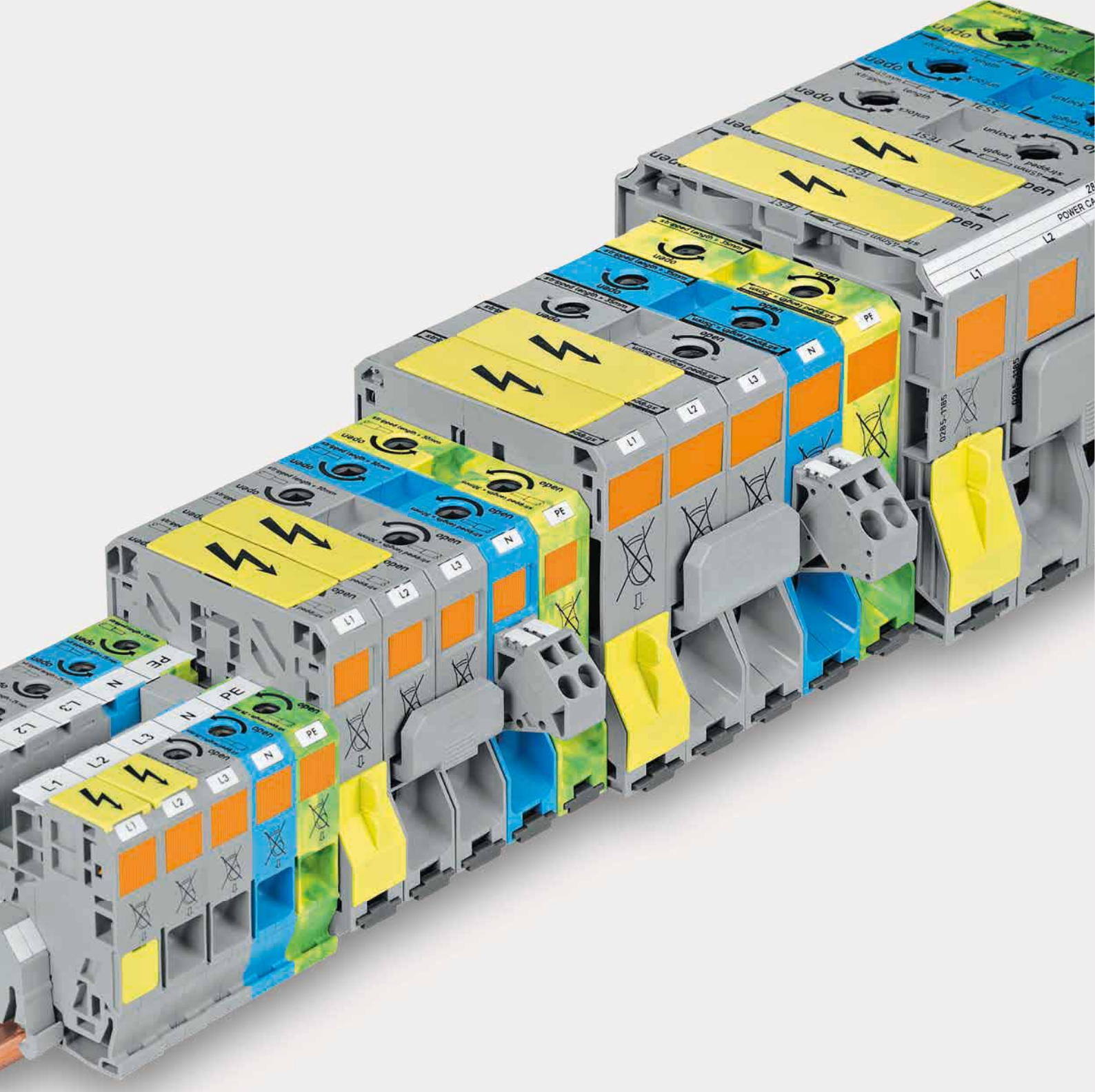

## High-Current, Rail-Mount Terminal Blocks High-Current Connectors



## High-Current, Rail-Mount Terminal Blocks

### High-Current Connectors

#### Side-Entry Wiring

			Page
	<b>Through and Ground Conductor Terminal Blocks</b> 6 ... 35 mm <sup>2</sup> (10 ... 2 AWG)	285 Series	258
	<b>Power Tap for 35 mm<sup>2</sup> (2 AWG) Terminal Blocks</b> 0.2 ... 6 mm <sup>2</sup> (24 ... 10 AWG)	285 Series	259
	<b>Through and Ground Conductor Terminal Blocks</b> 10 ... 50 (70) mm <sup>2</sup> (8 ... 2/0 AWG)	285 Series	262
	<b>Power Tap for 50 mm<sup>2</sup> (1 AWG) Terminal Blocks</b> 0.2 ... 6 mm <sup>2</sup> (24 ... 10 AWG)	285 Series	263
	<b>Through and Ground Conductor Terminal Blocks</b> 25 ... 95 mm <sup>2</sup> (4 ... 4/0 AWG)	285 Series	264
	<b>Power Tap for 95 mm<sup>2</sup> (3/0 AWG) Terminal Blocks</b> 0.2 ... 10 mm <sup>2</sup> (24 ... 8 AWG)	285 Series	265
	<b>Through and Ground Conductor Terminal Blocks</b> 50 ... 185 mm <sup>2</sup> (1/0 AWG ... 350 kcmil)	285 Series	266
	<b>Power Tap for 185 mm<sup>2</sup> (350 kcmil) Terminal Blocks</b> 0.2 ... 10 (16) mm <sup>2</sup> (24 ... 8 AWG)	285 Series	267
	<b>Through Terminal Blocks with Screw Flanges</b> 50 ... 185 mm <sup>2</sup> (1/0 AWG ... 350 kcmil)	285 Series	268
	<b>Connectors</b> 6 ... 35 mm <sup>2</sup> (10 ... 2 AWG)	834 Series	272

## High-Current, Rail-Mount Terminal Blocks, 35 mm<sup>2</sup>, 285 Series Description and Installation

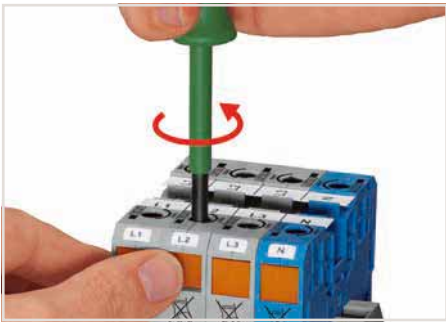

**Conductor termination – step 1**  
Rotate the operating tool (5.5 mm blade width) counter-clockwise. Next, push in the orange locking tab. The clamp is locked open for hands-free wiring.

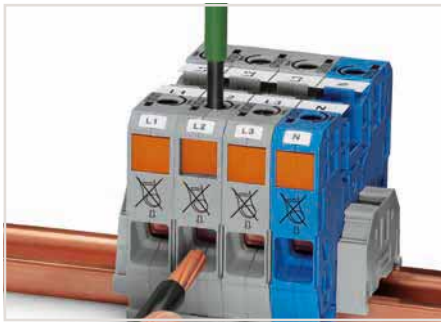

**Conductor termination – step 2**  
Insert a stripped conductor into the clamping unit until it hits backstop. Hold in this position.

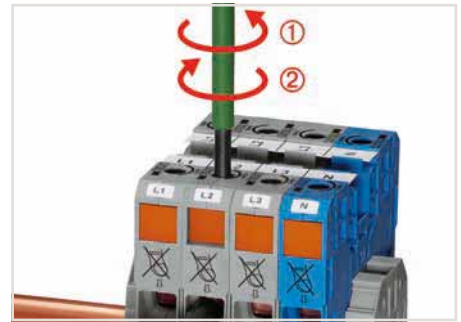

**Conductor termination – step 3**  
A small counter-clockwise rotation closes the clamp, securing conductor ①. When unlocked, allow operating tool to rotate clockwise ② to securely terminate the conductor.

4



The power tap is inserted into the jumper contact slot. It can be fitted with a strain relief plate.



Testing



Testing with test plug adapter (283-404)



High-Current, Rail-Mount Terminal Blocks, 35 mm<sup>2</sup> (2 AWG) and 50 mm<sup>2</sup> (2/0 AWG)



Commoning adjacent terminal blocks using a centrally positioned push-in jumper.



Slide the marking strip laterally to remove the jumper.



Commoning 35 mm<sup>2</sup> (2 AWG) POWER CAGE CLAMP Terminal Blocks with 10/16 mm<sup>2</sup> (8/6 AWG) 2010 and 2016 Series TOPJOP® S Terminal Blocks using step-down jumpers (not valid for 2016-76xx and 2016-77xx).



Step-down jumpers may common terminal blocks of different sizes, without losing a conductor clamping point. This can be beneficial on long conductor runs where voltage drops may be problematic. A large conductor can be easily connected to smaller conductors at the distribution point.

Step-down jumpers are simply pushed down for full insertion, similar to adjacent jumpers. Commoning may be made in either direction using the special thin end plate to cover the open side. Additional through terminal blocks having a smaller cross-section may be commoned using adjacent jumpers.

In this case, pay attention that:  
The total current of the outgoing circuits does not exceed the nominal current of the step-down jumper.



Side-entry wiring means that even larger conductors, which have limited flexibility, can be easily connected.



WMB markers or self-adhesive, printable marking strips can be accommodated on 35, 50 and 95 mm<sup>2</sup> high-current terminal blocks.



Marker carrier for marking strip or 2 x WMB markers for 285-13x, 285-15x and 285-19x terminal blocks

## High-Current, Through/Ground Conductor and Ex Terminal Blocks

### 35 mm<sup>2</sup>, 285 Series



Step-down jumpers may common terminal blocks of different sizes, without losing a conductor clamping point. This can be beneficial on long conductor runs where voltage drops may be problematic. A large conductor can be easily connected to smaller conductors at the distribution point.

4

Step-down jumpers are simply pushed down for full insertion, similar to adjacent jumpers. Commoning may be made in either direction using the special thin end plate to cover the open side. Additional through terminal blocks having a smaller cross-section may be commoned using adjacent jumpers.

In this case, pay attention that:  
The total current of the outgoing circuits does not exceed the nominal current of the step-down jumper.

Rail-mount terminal blocks with Ex mark are suitable for Ex e II applications.  
800 V, 101 A



2-conductor through terminal block

Color	Item No.	Pack. Unit
○ gray	285-135	15
● blue	285-134	15
○ light gray <sup>Ⓔ</sup>	285-935	15



#### Technical Data

Ratings per	IEC/EN 60947-7-1
Rated voltage (III / 3)	1000 V
Rated surge voltage (III / 3)	8 kV
Rated current	125 A
Approval	600 V, 115 A <sup>Ⓐ</sup> ; 600 V, 115 A <sup>Ⓒ</sup>

#### Connection Data

Connection technology	POWER CAGE CLAMP
Solid conductor	6 ... 35 mm <sup>2</sup> / 10 ... 2 AWG
Fine-stranded conductor	6 ... 35 mm <sup>2</sup> / 10 ... 2 AWG
Strip length	25 mm / 0.98 inch
Terminal block width	16 mm / 0.63 inch

Module width	Polyamide 66 (PA 66)
Insulation material	only on DIN 35 x 15 rail

#### Note:

#### Accessories (Selection)

Adjacent jumper, insulated, I <sub>N</sub> 85 A
WMB Inline, plain, 1,500 WMB markers (5 mm) per reel, 5 ... 5.2 mm stretchable
WMB Multi marking system, white, 10 strips with 10 markers per card, 5 ... 5.2 mm stretchable
Marking strip, plain, 11 mm wide, 50 m reel
Marker carrier, for 35 / 50 / 95 mm <sup>2</sup> POWER CAGE CLAMP Width 10.4 mm
Test plug adapter, 11.6 mm wide, for 4 mm Ø test plug, for 1.5 ... 16 mm <sup>2</sup> terminal blocks
Strain relief plate, gray

	Item No.	Page
gray	285-435	274
white	2009-115	780
plain	793-5501	780
white	2009-110	783
gray	285-442	783
gray	283-404	274

Accessories (jumpers, etc.),  
see page 274

Carrier rails and tools,  
see Section 13

Appropriate marking system,  
WMB/WMB Inline/marketing strips,  
see Full Line Catalog, Volume 6

Information on hazardous locations,  
see Section 14

Approvals and corresponding ratings,  
visit [www.wago.com](http://www.wago.com)

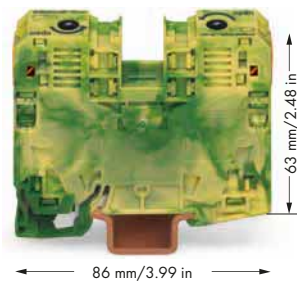

2-conductor ground terminal block

Color	Item No.	Pack. Unit
● green-yellow	285-137	15
● green-yellow ☺	285-137/999-950	15



IEC/EN 60947-7-2

POWER CAGE CLAMP

6 ... 35 mm<sup>2</sup> / 10 ... 2 AWG  
 6 ... 35 mm<sup>2</sup> / 10 ... 2 AWG  
 25 mm / 0.98 inch  
 16 mm / 0.63 inch

Polyamide 66 (PA 66)  
 only on DIN 35 x 15 rail; 2.3 mm thick

	Item No.	Page
gray	285-435	274
white	2009-115	780
plain	793-5501	780
white	2009-110	783
gray	285-442	783
gray	283-404	274

Power tap, for 35 mm<sup>2</sup> high-current terminal blocks

Color	Item No.	Pack. Unit
○ gray	285-427	5



IEC/EN 60947-7-1

800 V  
 8 kV  
 32 A  
 600 V, 30 A ; 600 V, 30 A

CAGE CLAMP®

0.2 ... 6 mm<sup>2</sup> / 24 ... 10 AWG  
 0.2 ... 6 mm<sup>2</sup> / 24 ... 10 AWG  
 12 ... 13 mm / 0.47 ... 0.51 inch  
 8 mm / 0.315 inch

	Item No.	Page
plain	793-5501	780
1-pole	769-410	274

Power tap, with 500 mm cable, for 16 mm<sup>2</sup> (283/783 Series) and 35 mm<sup>2</sup> (285/785 Series) rail-mount terminal blocks

Color	Item No.	Pack. Unit
○ gray	283-407	25

800 V  
 8 kV  
 24 A



## High-Current, Rail-Mount Terminal Blocks, 50 ... 185 mm<sup>2</sup>, 285 Series

### Description and Installation



**Conductor termination – step 1**  
Rotate the T-wrench counter-clockwise to the stop ①. Next, push in the orange locking tab. The clamp is locked open for hands-free wiring.



**Conductor termination – step 2**  
Insert a stripped conductor into the clamping unit until it hits backstop. Hold in this position.



**Conductor termination – step 3**  
A short counter-clockwise rotation ② releases the locking tab. When unlocked, the T-wrench rotates clockwise, securely clamping the conductor.

4



For the optimal clamping force:

- Bend conductor.
- Cut conductor to length (conductor end must be straight).
- Strip conductor.



Always observe the printed strip length!



**Grounding foot**  
Ground conductor terminal blocks (limited to max. 120 mm<sup>2</sup>/250 kcmil per EN 60947-7-2) must be snapped onto a 2.3 mm thick copper carrier rail.



Protective warning marker may indicate:  
Notice: Power is still on even after switching off the main switch!



**Risk of Injury!**  
Do not insert fingers in the conductor entry!



Yellow, detachable finger guards provide touch-proof safety by shielding jumper contact slots and/or unused conductor entries.





Commoning with an adjacent jumper: Insert the jumper above the conductor entry hole – prior to conductor termination. The nominal cross-section remains unchanged.



Removing jumper via operating tool.

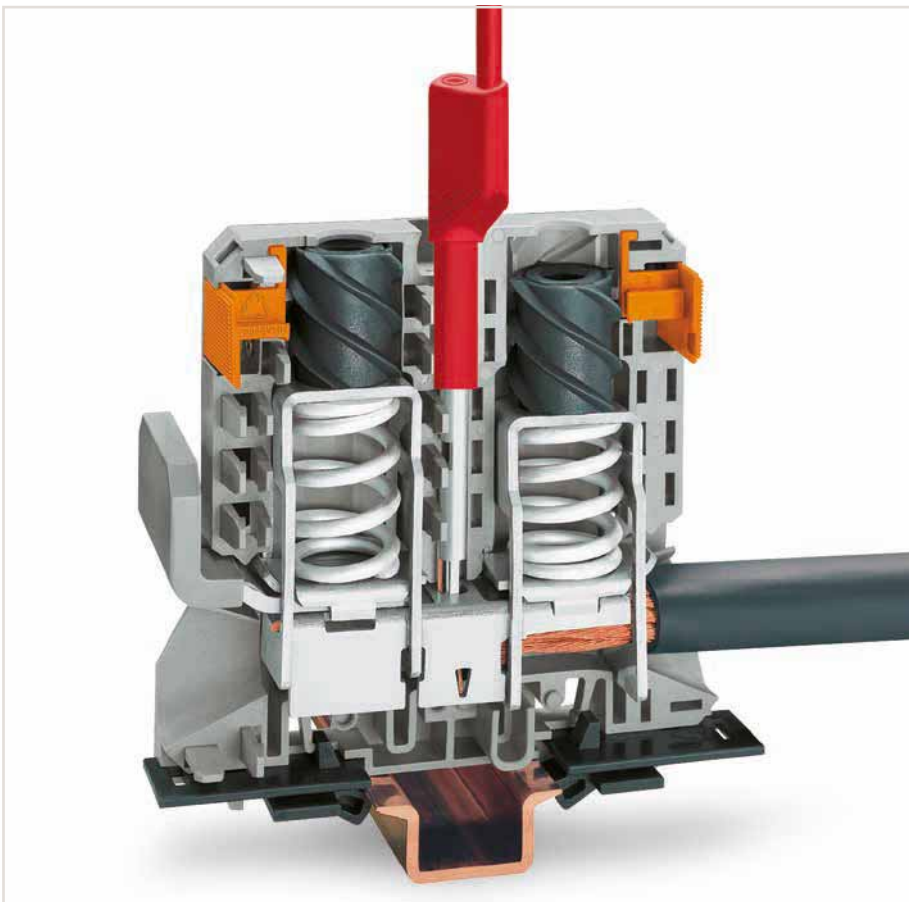

Testing via touch-proof 4 mm Ø test plugs (not available from WAGO, but offered by industry suppliers such as, Multi-Contact Deutschland GmbH).



Prüfen



WMB markers or self-adhesive, printable marking strips can be accommodated on 35, 50 and 95 mm<sup>2</sup> high-current terminal blocks.



In addition to WMB markers, marking strips can be directly applied to 185 mm<sup>2</sup> (350 kcmil) high-current terminal blocks.



Reliably and easily tap directly into the power supply. Insert the unwired tap before opening the clamping unit.

## High-Current, Through/Ground Conductor and Ex Terminal Blocks

### 50 (70 "f-st") mm<sup>2</sup>, 285 Series



High-current, rail-mount terminal blocks for conductors rated 35 mm<sup>2</sup> (2 AWG), 50 mm<sup>2</sup> (1/0 AWG), 95 mm<sup>2</sup> (4/0 AWG) and 185 mm<sup>2</sup> (350 kcmil)

Rail-mount terminal blocks with an Ex mark are suitable for Ex e II applications. 800 V, 134 A

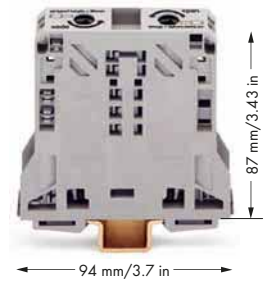

2-conductor through terminal block

Color	Item No.	Pack. Unit
gray	285-150	5
blue	285-154	5
light gray <sup>Ⓢ</sup>	285-950	5

**Ex**

#### Technical Data

Ratings per	IEC/EN 60947-7-1
Rated voltage (III / 3)	1000 V
Rated surge voltage (III / 3)	8 kV
Rated current	150 A
Approval	600 V, 150 A <b>Ex</b> ; 600 V, 150 A <b>Ex</b>

#### Connection Data

Connection technology	POWER CAGE CLAMP
Solid conductor	10 ... 50 mm <sup>2</sup> / 8 ... 1/0 AWG
Fine-stranded conductor	10 ... 70 mm <sup>2</sup> / 8 ... 2/0 AWG
Strip length	30 mm / 1.18 inch
Terminal block width	20 mm / 0.787 inch

Module width

Insulation material

Polyamide 66 (PA 66)

#### Note:

only on DIN 35 x 15 rail

#### Accessories (Selection)

Adjacent jumper, insulated, I <sub>N</sub> 150 A	gray	285-450	275
WMB Inline, plain, 1,500 WMB markers (5 mm) per reel, 5 ... 5.2 mm stretchable	white	2009-115	780
WMB Multi marking system, white, 10 strips with 10 markers per card, 5 ... 5.2 mm stretchable	plain	793-5501	780
Marking strip, plain, 11 mm wide, 50 m reel	white	2009-110	783
Marker carrier, for 35 / 50 / 95 mm <sup>2</sup> POWER CAGE CLAMP Width 10.4 mm	gray	285-442	783
Protective warning marker, with black high-voltage symbol, for 5 terminal blocks			

Accessories (jumpers, etc.), see page 275

Carrier rails and tools, see Section 13

Appropriate marking system, WMB/WMB Inline/marketing strips, see Full Line Catalog, Volume 6

Information on hazardous locations, see Section 14

Approvals and corresponding ratings, visit [www.wago.com](http://www.wago.com)



## High-Current, Through/Ground Conductor and Ex Terminal Blocks

### 95 mm<sup>2</sup>, 285 Series



Rail-mount terminal blocks with an Ex mark are suitable for Ex e II applications.  
 25 ... 95 mm<sup>2</sup> / 4 ... 4/0 AWG  
 880 V, 211 A  
 1 jumper, 211 A  
 2 ... 4 jumpers, 175 A  
 35 ... 70 mm<sup>2</sup> / 2 ... 2/0 AWG ground conductor terminal blocks

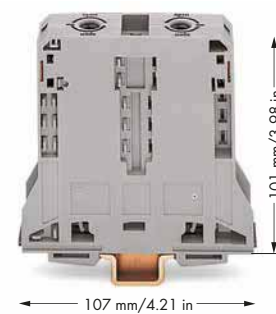

2-conductor through terminal block

Color	Item No.	Pack. Unit
○ gray	285-195	5
● blue	285-194	5
○ light gray ☺	285-995	5

**UL**

#### Technical Data

Ratings per	IEC/EN 60947-7-1
Rated voltage (III / 3)	1000 V
Rated surge voltage (III / 3)	8 kV
Rated current	232 A
Approval	600 V, 115 A <b>UL</b> ; 600 V, 115 A <b>CE</b>

#### Connection Data

Connection technology	POWER CAGE CLAMP
Solid conductor	25 ... 95 mm <sup>2</sup> / 4 ... 4/0 AWG

Fine-stranded conductor

#### Connection Data (2)

Solid conductor (2)	
Fine-stranded conductor (2)	

Strip length 35 mm / 1.38 inch

Terminal block width 25 mm / 0.984 inch

Module width

Insulation material Polyamide 66 (PA 66)

**Note:** only on DIN 35 x 15 rail

#### Accessories (Selection)

	Item No.	Page
Adjacent jumper, insulated, I <sub>n</sub> 232 A	gray 285-495	276
WMB Inline, plain, 1,500 WMB markers (5 mm) per reel, 5 ... 5.2 mm stretchable	white 2009-115	780
WMB Multi marking system, white, 10 strips with 10 markers per card, 5 ... 5.2 mm stretchable	plain 793-5501	780
Marking strip, plain, 11 mm wide, 50 m reel	white 2009-110	783
Marker carrier, for 35 / 50 / 95 mm <sup>2</sup> POWER CAGE CLAMP Width 10.4 mm	gray 285-442	783
Protective warning marker, with black high-voltage symbol, for 5 terminal blocks		

Accessories (jumpers, etc.), see page 276

Carrier rails and tools, see Section 13

Appropriate marking system, WMB/WMB Inline/marketing strips, see Full Line Catalog, Volume 6

Information on hazardous locations, see Section 14

Approvals and corresponding ratings, visit [www.wago.com](http://www.wago.com)

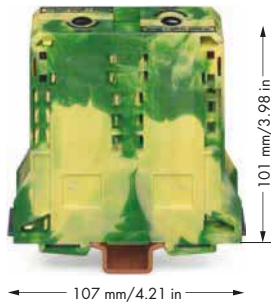

2-conductor ground terminal block

Color	Item No.	Pack. Unit
● green-yellow	285-197	5
● green-yellow Ⓢ	285-197/999-950	5

UL®

IEC/EN 60947-7-2

POWER CAGE CLAMP

25 ... 95 mm² / 4 ... 3/0 AWG

35 mm / 1.38 inch

25 mm / 0.984 inch

Polyamide 66 (PA 66)

only on DIN 35 x 15 rail; 2.3 mm thick, copper

	Item No.	Page
gray	285-495	276
white	2009-115	780
plain	793-5501	780
white	2009-110	783
gray	285-442	783

Power tap, for 95 mm² high-current terminal blocks

Color	Item No.	Pack. Unit
● gray	285-407	5

UL

IEC/EN 60947-7-1

1000 V

8 kV

57 A

600 V, 50 A

CAGE CLAMP®

0.2 ... 10 mm² / 24 ... 8 AWG

0.2 ... 10 mm² / 24 ... 8 AWG

0.2 ... 16 mm² / 24 ... 8 AWG

0.2 ... 16 mm² / 24 ... 8 AWG

12 ... 13 mm / 0.47 ... 0.51 inch

20 mm / 0.787 inch

Polyamide 66 (PA 66)

	Item No.	Page
plain	793-5501	780
yellow	284-415	276



## High-Current, Through and Ground Conductor Terminal Blocks

### 185 mm<sup>2</sup>, 285 Series



In addition to WMB markers, marking strips can be directly applied to 185 mm<sup>2</sup> (350 kcmil) high-current terminal blocks.

4



Tapping directly into the power supply.

Rail-mount terminal blocks with an Ex mark are suitable for Ex e II applications. 800 V, 101 A



2-conductor through terminal block

Color	Item No.	Pack. Unit
gray	285-1185	5
blue	285-1184	5

Ⓔ

#### Technical Data

Ratings per	IEC/EN 60947-7-1
Voltage type	AC/DC
Rated voltage (III / 3)	1000 V
Rated surge voltage (III / 3)	12 kV
Voltage type (2)	DC
Rated voltage (III / 3) (2)	1500 V
Rated surge voltage (III / 3) (2)	12 kV
Rated current	353 A
Approval	1000 V, 310 AⒺ

#### Connection Data

Connection technology	POWER CAGE CLAMP
Solid conductor	50 ... 185 mm <sup>2</sup> / 1/0 AWG ... 350 kcmil
Stranded conductor	50 ... 185 mm <sup>2</sup> / 1/0 AWG ... 350 kcmil
Fine-stranded conductor	50 ... 185 mm <sup>2</sup> / 1/0 AWG ... 350 kcmil
Fine-stranded conductor with insulated ferrule	50 ... 150 mm <sup>2</sup> / 1/0 AWG ... 300 kcmil, 45 mm
Fine-stranded conductor with uninsulated ferrule	50 ... 185 mm <sup>2</sup> / 1/0 AWG ... 350 kcmil

#### Connection Data (2)

Solid conductor (2)	
Fine-stranded conductor (2)	
Strip length	45 ... 47 mm / 1.77 ... 1.85 inch
Terminal block width	32 mm / 1.26 inch
Module width	
Insulation material	Polyamide 66 (PA 66)
Note:	only on DIN 35 x 15 rail

#### Accessories (Selection)

	Item No.	Page
Adjacent jumper, insulated, I <sub>n</sub> 309 A	gray 285-1171	277
WMB Inline, plain, 1,500 WMB markers (5 mm) per reel, 5 ... 5.2 mm stretchable	white 2009-115	780
WMB Multi marking system, white, 10 strips with 10 markers per card, 5 ... 5.2 mm stretchable	plain 793-5501	780
Marking strip, plain, 11 mm wide, 50 m reel	white 2009-110	783
Protective warning marker, with black high-voltage symbol, for 5 terminal blocks		

Accessories (jumpers, etc.), see page 277

Carrier rails and tools, see Section 13

Appropriate marking system, WMB/WMB Inline/marketing strips, see Full Line Catalog, Volume 6

Approvals and corresponding ratings, visit [www.wago.com](http://www.wago.com)



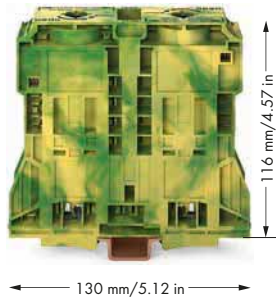

2-conductor ground terminal block

Color	Item No.	Pack. Unit
● green-yellow	285-1187	5

Power tap, for 95 mm² high-current terminal blocks

Color	Item No.	Pack. Unit
● gray	285-1175	5



IEC/EN 60947-7-2

IEC/EN 60947-7-1

1000 V  
8 kV  
  
57 A

1000 V  
8 kV  
  
57 A

POWER CAGE CLAMP  
50 ... 120 mm² / 1/0 AWG ... 250 kcmil  
50 ... 120 mm² / 1/0 AWG ... 250 kcmil  
50 ... 120 mm² / 1/0 AWG ... 250 kcmil  
50 ... 120 mm² / 1/0 AWG ... 250 kcmil, 45 mm  
50 ... 120 mm² / 1/0 AWG ... 250 kcmil

CAGE CLAMP®  
0.2 ... 10 mm² / 24 ... 8 AWG  
0.2 ... 10 mm² / 24 ... 8 AWG

45 ... 47 mm / 1.77 ... 1.85 inch  
32 mm / 1.26 inch

0.2 ... 16 mm² / 24 ... 8 AWG  
0.2 ... 16 mm² / 24 ... 8 AWG  
12 ... 13 mm / 0.47 ... 0.51 inch

Polyamide 66 (PA 66)  
only on DIN 35 x 15 rail; 2.3 mm thick, copper

20 mm / 0.787 inch  
Polyamide 66 (PA 66)

	Item No.	Page
gray	285-1171	277
white	2009-115	780
plain	793-5501	780
white	2009-110	783

	Item No.	Page
plain	793-5501	780
yellow	284-415	277

## High-Current, Through Terminal Blocks with Screw Flanges 185 mm<sup>2</sup>, 285 Series

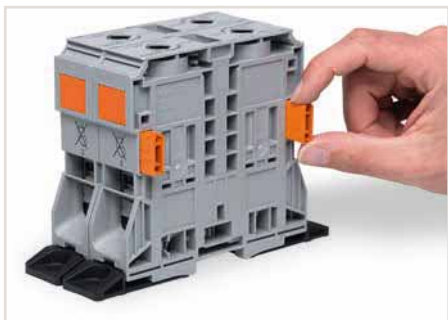

Optionally, insert block-to-block connector (285-1179) into housing slot.

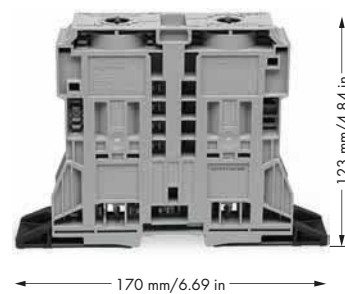

2-conductor through terminal block with screw flanges

Color	Item No.	Pack. Unit
gray	285-1161	4
blue	285-1164	4

4



Align and snap high-current, through terminal blocks together.

### Technical Data

Ratings per	IEC/EN 60947-7-1
Voltage type	AC/DC
Rated voltage (III / 3)	1000 V
Rated surge voltage (III / 3)	12 kV
Voltage type (2)	DC
Rated voltage (III / 3) (2)	1500 V
Rated surge voltage (III / 3) (2)	12 kV
Rated current	353 A

### Connection Data

Solid conductor	50 ... 185 mm <sup>2</sup> / 1/0 AWG ... 350 kcmil
Stranded conductor	50 ... 185 mm <sup>2</sup> / 1/0 AWG ... 350 kcmil
Fine-stranded conductor	50 ... 185 mm <sup>2</sup> / 1/0 AWG ... 350 kcmil
Fine-stranded conductor with insulated ferrule	50 ... 150 mm <sup>2</sup> / 1/0 AWG ... 300 kcmil, 45 mm
Fine-stranded conductor with uninsulated ferrule	50 ... 185 mm <sup>2</sup> / 1/0 AWG ... 350 kcmil
Strip length	45 ... 47 mm / 1.77 ... 1.85 inch
Terminal block width	32 mm / 1.26 inch
Insulation material	Polyamide 66 (PA 66)
Note:	only on DIN 35 x 15 rail

### Accessories (Selection)

	Item No.	Page
Adjacent jumper, insulated, I <sub>n</sub> 309 A	gray 285-1171	277
Block-to-block connector, for 185 mm <sup>2</sup> high-current terminal blocks	orange 285-1179	277
WMB Inline, plain, 1,500 WMB markers (5 mm) per reel, 5 ... 5.2 mm stretchable	white 2009-115	780
WMB Multi marking system, white, 10 strips with 10 markers per card, 5 ... 5.2 mm stretchable	plain 793-5501	780
Marking strip, plain, 11 mm wide, 50 m reel	white 2009-110	783



Secure the terminal block to a mounting plate using two M8 cylinder-head screws and appropriate washers.

Accessories (jumpers, etc.), see page 277

Appropriate marking system, WMB/WMB Inline/marketing strips, see Full Line Catalog, Volume 6

Approvals and corresponding ratings, visit [www.wago.com](http://www.wago.com)

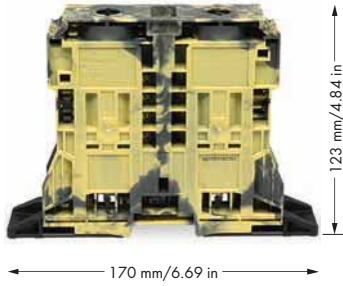

2-conductor ground terminal block with screw flanges

Color	Item No.	Pack. Unit
dark gray/yellow	285-1167	4

IEC/EN 60947-7-2
AC/DC
1000 V
12 kV
DC
1500 V
12 kV
353 A
50 ... 185 mm <sup>2</sup> / 1/0 AWG ... 350 kcmil
50 ... 185 mm <sup>2</sup> / 1/0 AWG ... 350 kcmil
50 ... 185 mm <sup>2</sup> / 1/0 AWG ... 350 kcmil
50 ... 150 mm <sup>2</sup> / 1/0 AWG ... 300 kcmil, 45 mm
50 ... 185 mm <sup>2</sup> / 1/0 AWG ... 350 kcmil
45 ... 47 mm / 1.77 ... 1.85 inch
32 mm / 1.26 inch
Polyamide 66 (PA 66)
only on DIN 35 x 15 rail; 2.3 mm thick, copper

	Item No.	Page
gray	285-1171	277
orange	285-1179	277
white	2009-115	780
plain	793-5501	780
white	2009-110	783

## High-Current Connectors, 35 mm<sup>2</sup>, 834 Series Description and Installation

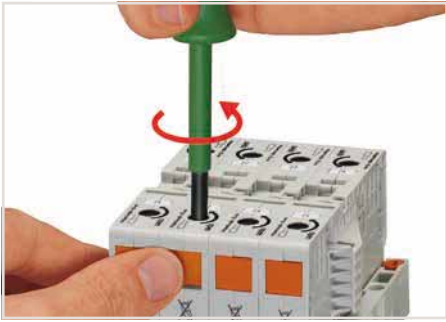

Opening the clamping unit:  
Rotate the operating tool (5.5 mm blade width) counter-clockwise. Press the orange locking tab for hands-free wiring.



Conductor termination:  
Insert a stripped conductor into the clamping unit until it hits backstop. Hold in this position.



Unlock the locking tab with a short counterclockwise turn of the operating tool ①. When unlocked, allow operating tool to rotate clockwise ② to securely terminate the conductor.

4

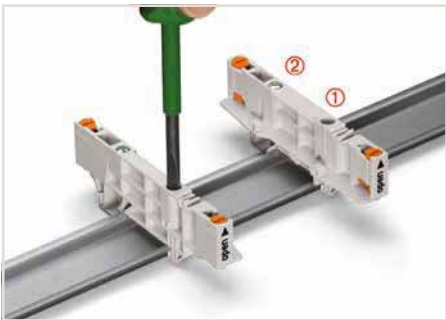

Position the mounting adapter and fix it using locking screw ①. Screw down locking device ② to the stop.

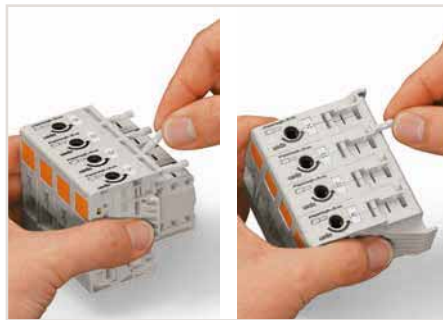

Coding both female and male connector:  
The coding pins removed from the female connector can be used to code the male connector.

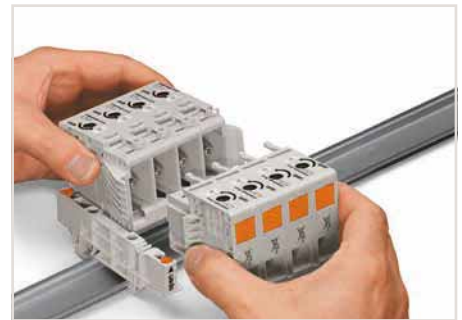

Connection:  
Secure the male connector to the mounting adapters. Tilt the male connector to plug the female connector.

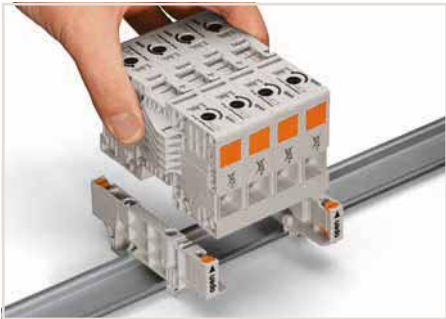

Mounting a male and female connector assembly:  
Fit the assembly perpendicularly between the mounting adapters.



Securing the assembly:  
Turn the orange locking tab from the open to the closed position.

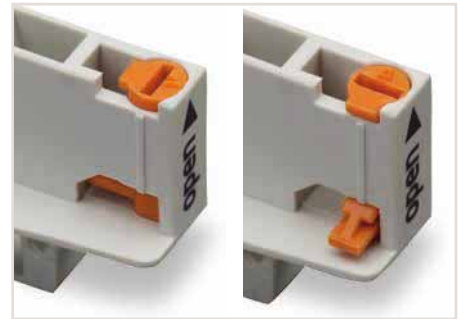

Orange locking tab: open position (see picture, left)  
Orange locking tab: closed position (see picture, right)



Mounted and secured connector assembly



Removing the assembly:  
Turn the orange locking tab to the open position. Lift the assembly between the mounting adapters and remove it.



Removing the assembly: Insert two operating tools into the separator slots between male and female connectors and unlatch the assembly.



## Product discontinuation: December 31, 2016

### Male and Female Connectors – 100% Protected Against Mismatching

#### 35 mm<sup>2</sup>, 834 Series

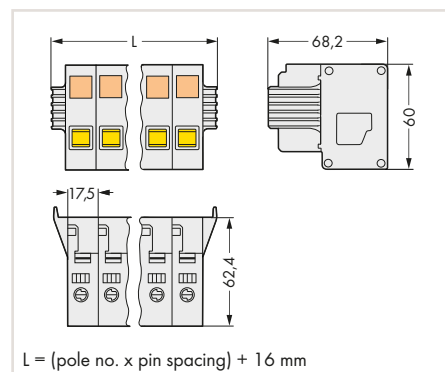

Male connector, 100% protected against mismatching, light gray

Pole No.	Item No.	Pack. Unit
○ 2	834-1202	10
○ 3	834-1203	5
○ 4	834-1204	5
○ 5	834-1205	5
○ 6	834-1206	5
○ 7	834-1207	4
○ 8	834-1208	4



#### Technical Data

Ratings per	IEC/EN 60664-1
Rated voltage (III / 3)	1000 V
Rated surge voltage (III / 3)	8 kV
Rated current	125 A
Approval	600 V, 105 A ; 600 V, 50 A

#### Connection Data

Solid conductor	6 ... 35 mm <sup>2</sup> / 8 ... 2 AWG
Fine-stranded conductor	6 ... 35 mm <sup>2</sup> / 8 ... 2 AWG
Strip length	45 ... 47 mm / 1.77 ... 1.85 inch
Pin spacing	17.5 mm / 0.689 inch
Module width	
Insulation material	Polyamide 66 (PA 66)

#### Accessories (Selection)

WMB Multi marking system, white, 10 strips with 10 markers per card, 5 ... 5.2 mm stretchable	
---	--

	Item No.	Page
plain	793-5501	780

4

Tools, see Section 13

Appropriate marking system, WMB see Full Line Catalog, Volume 6

Approvals and corresponding ratings, visit [www.wago.com](http://www.wago.com)





Dimensions (in mm):

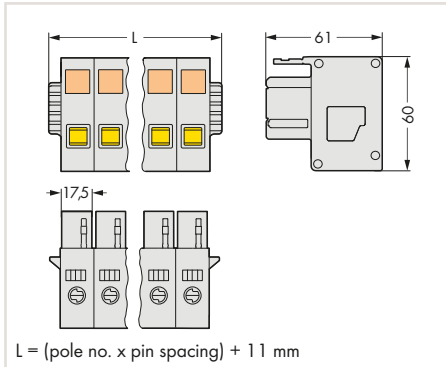

Female connector, 100 % protected against mis-mating, light gray

Pole No.	Item No.	Pack. Unit
○ 2	834-1102	10
○ 3	834-1103	5
○ 4	834-1104	5
○ 5	834-1105	5
○ 6	834-1106	5
○ 7	834-1107	4
○ 8	834-1108	4



IEC/EN 60664-1

1000 V

8 kV

125 A

600 V, 105 A; 600 V, 50 A

6 ... 35 mm<sup>2</sup> / 8 ... 2 AWG

6 ... 35 mm<sup>2</sup> / 8 ... 2 AWG

45 ... 47 mm / 1.77 ... 1.85 inch

17.5 mm / 0.689 inch

Polyamide 66 (PA 66)

	Item No.	Page
plain	793-5501	780

Dimensions (in mm):

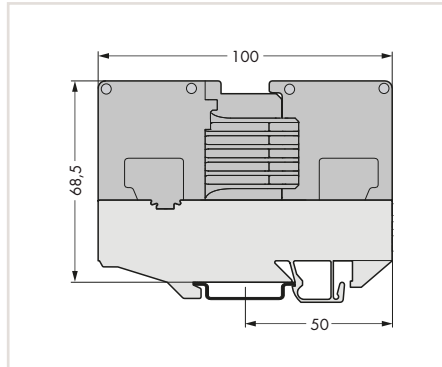

Mounting adapter, for DIN-35 rail

Color	Item No.	Pack. Unit
○ light gray	834-137	10

## High-Current, Rail-Mount Terminal Blocks

### Accessories, 285 Series (35 mm<sup>2</sup> Terminal Blocks)

#### Commoning, Mounting, Marking and Testing



Adjacent jumper, insulated, I <sub>n</sub> 85 A			
Suitable for:	Color	Item No.	Pack. Unit
285-135	gray	285-435	50 (25)



Step-down jumper, insulated, 800 V, I <sub>n</sub> 90 A			
Suitable for:	Color	Item No.	Pack. Unit
285-135	gray	285-430	50 (25)

4



Rated voltage (III / 3)	1000 V
Rated surge voltage (III / 3)	8 kV

Three-phase set, with 35 mm <sup>2</sup> high-current terminal blocks		
	Item No.	Pack. Unit
	285-139	1



Protective warning marker, with black high-voltage symbol			
Suitable for:	Color	Item No.	Pack. Unit
285-135	yellow	285-420	100 (25)



Test plug adapter, 11.6 mm wide, for 4 mm Ø test plug, for 1.5 ... 16 mm <sup>2</sup> terminal blocks			
Suitable for:	Color	Item No.	Pack. Unit
283-901	gray	283-404	25



Finger guard, touch-proof cover protects unused conductor entries			
Suitable for:	Color	Item No.	Pack. Unit
285-135	yellow	285-421	100 (25)



Strain relief plate, gray			
Suitable for:		Item No.	Pack. Unit
285-427	1-pole	769-410	100 (25)

## High-Current, Rail-Mount Terminal Blocks

### Accessories, 285 Series (50 mm<sup>2</sup> Terminal Blocks)

#### Commoning, Mounting, Marking and Testing



Jumper can only be removed or inserted when the clamp is closed.

$I_N$  150 A for 1 jumper,

$I_N$  130 A for 2 ... 4 jumpers

Adjacent jumper, insulated,  $I_N$  150 A

Suitable for:	Color	Item No.	Pack. Unit
285-150	gray	285-450	100 (25)

Rated voltage (III / 3)

1000 V

Rated surge voltage (III / 3)

8 kV

Three-phase set, with 50 mm<sup>2</sup> high-current terminal blocks

Item No.	Pack. Unit
285-159	1



Protective warning marker, with black high-voltage symbol

Suitable for:	Color	Item No.	Pack. Unit
285-150	yellow	285-440	50 (25)



Finger guard, touch-proof cover protects unused conductor entries and jumper slots

Suitable for:	Color	Item No.	Pack. Unit
285-150	yellow	285-441	100 (25)



Protective warning marker, with high-voltage symbol, for 5 terminal blocks

Suitable for:	Color	Item No.	Pack. Unit
285-447	yellow	282-415	50 (25)



Allen wrench with partially insulated shaft

Suitable for:	Item No.	Pack. Unit
285-150	285-172	1



## High-Current, Rail-Mount Terminal Blocks

### Accessories, 285 Series (95 mm<sup>2</sup> Terminal Blocks)

#### Commoning, Mounting, Marking and Testing



I<sub>N</sub> 232 A for 1 jumper,  
I<sub>N</sub> 192 A for 2 ... 4 jumpers

Adjacent jumper, insulated, I<sub>N</sub> 232 A

Suitable for:	Color	Item No.	Pack. Unit
285-195	gray	285-495	25

Rated voltage (III / 3) 1000 V

Rated surge voltage (III / 3) 8 kV

Three-phase set, with 95 mm<sup>2</sup> high-current terminal blocks

Item No.	Pack. Unit
285-199	1



4



Protective warning marker, with black high-voltage symbol

Suitable for:	Color	Item No.	Pack. Unit
285-195	yellow	285-170	50 (25)



Finger guard, touch-proof cover protects unused conductor entries and jumper slots

Suitable for:	Color	Item No.	Pack. Unit
285-195	yellow	285-169	25

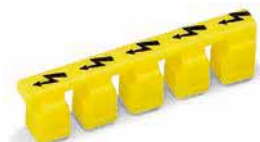

Protective warning marker, with high-voltage symbol, for 5 terminal blocks

Suitable for:	Color	Item No.	Pack. Unit
285-407	yellow	284-415	50 (25)



Allen wrench with partially insulated shaft

Suitable for:	Item No.	Pack. Unit
285-195	285-172	1

## High-Current, Rail-Mount Terminal Blocks Accessories, 285 Series (185 mm<sup>2</sup> Terminal Blocks) Commoning, Mounting, Marking and Testing



$I_N$  309 A for 1 jumper

Adjacent jumper, insulated,  $I_N$  309 A

Suitable for:	Color	Item No.	Pack. Unit
285-1185	gray	285-1171	25
285-1161			



Rated voltage (III / 3) 1000 V

Rated surge voltage (III / 3) 8 kV

Three-phase set, with 185 mm<sup>2</sup> high-current terminal blocks

Item No.	Pack. Unit
285-1169	1



Protective warning marker, with black high-voltage symbol

Suitable for:	Color	Item No.	Pack. Unit
285-1185	yellow	285-1177	50 (25)
285-1161			



Finger guard, touch-proof cover protects unused conductor entries and jumper slots

Suitable for:	Color	Item No.	Pack. Unit
285-1185	yellow	285-1178	25
285-1161			



Protective warning marker, with high-voltage symbol, for 5 terminal blocks

Suitable for:	Color	Item No.	Pack. Unit
285-407	yellow	284-415	50 (25)



Block-to-block connector, for 185 mm<sup>2</sup> high-current terminal blocks

Suitable for:	Color	Item No.	Pack. Unit
285-1161	orange	285-1179	25



Allen wrench with partially insulated shaft

Suitable for:	Item No.	Pack. Unit
285-1185	285-172	1
285-1161		

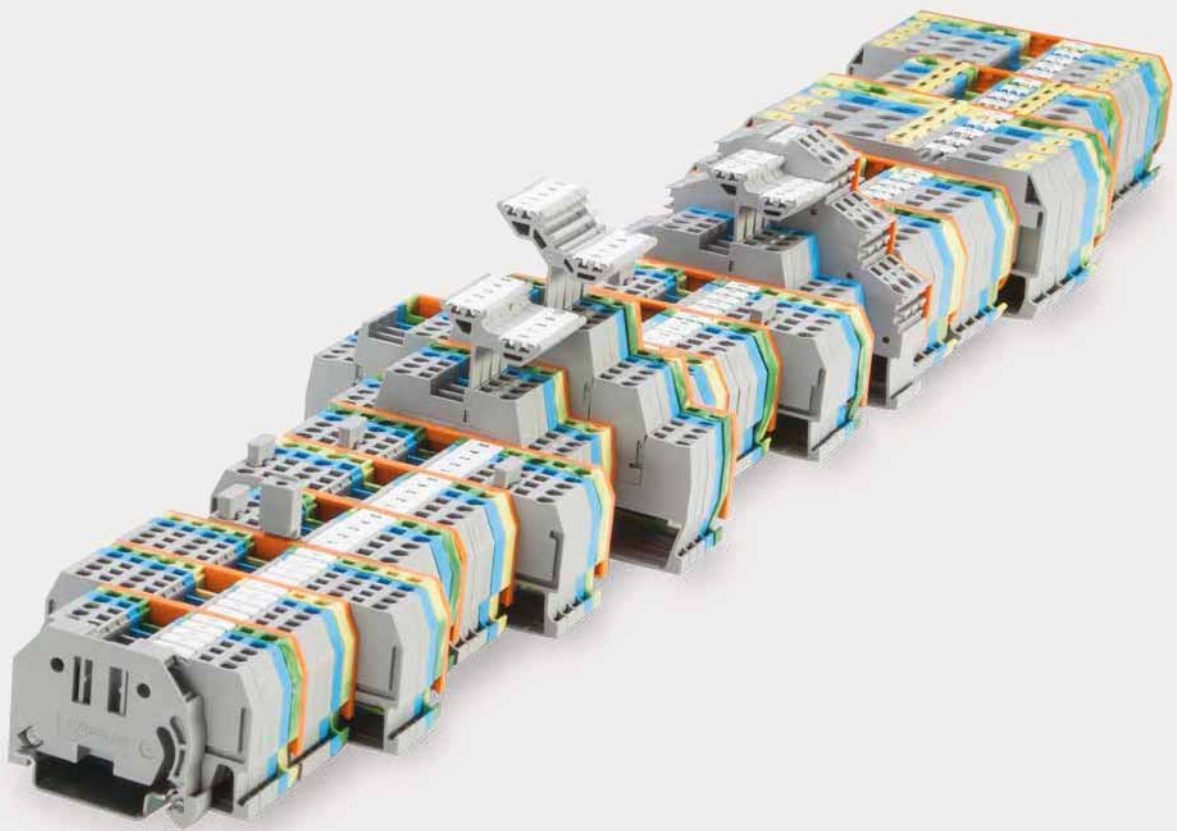

**Rail-Mount Terminal Blocks, Classic**



## Rail-Mount Terminal Blocks, Classic

### Installation Rail-Mount Terminal Blocks, TOPJOB®, Classic

#### Front-Entry Wiring

			Page
	<b>Through, Ground/Shield Conductor, Ex and Distribution Terminal Blocks</b> 0.08 ... 35 mm <sup>2</sup> (28 ... 2 AWG)	279 ... 285/880 Series	286
	<b>Multilevel Rail-Mount Terminal Blocks</b> 1.5/2.5/4 mm <sup>2</sup> (16/12 AWG)	279/2280/281 Series	314
	<b>TOPJOB®, Classic Through, Ground/Shield Conductor and Ex Terminal Blocks</b> 0.08 ... 35 mm <sup>2</sup> (28 ... 2 AWG)	780 ... 785 Series	332
	<b>Disconnect/Test Terminal Blocks</b> 0.08 ... 4 mm <sup>2</sup> (28 ... 12 AWG) and 0.2 ... 6 mm <sup>2</sup> (24 ... 10 AWG)	280/281 and 282 Series	346
	<b>Disconnect, Ground Conductor Disconnect and Fuse Terminal Blocks</b> 0.2 ... 6 mm <sup>2</sup> (24 ... 10 AWG)	282 Series	367
	<b>Fused Disconnect Terminal Blocks with a Pivoting Fuse Holder</b> 0.08 ... 4 mm <sup>2</sup> (28 ... 12 AWG)	281 Series	376
	<b>Fuse Plugs on Carrier Terminal Blocks</b>	281/280 Series	380
	<b>Sensor and Actuator Terminal Blocks</b> 0.08 ... 2.5 mm <sup>2</sup> (28 ... 12 AWG)	280 Series	396
	<b>Diode and LED Terminal Blocks</b> 0.08 ... 4 mm <sup>2</sup> (28 ... 12 AWG)	279 ... 281 Series	418
	<b>Multilevel Diode and LED Terminal Blocks</b> 0.08 ... 4 mm <sup>2</sup> (28 ... 12 AWG)	280/281 Series	428
	<b>Diode and LED Modules</b>	280 Series	434
	<b>Accessories for Rail-Mount Terminal Blocks</b>		438

## Rail-Mount Terminal Blocks, 279 ... 285 and 880 Series Description and Installation

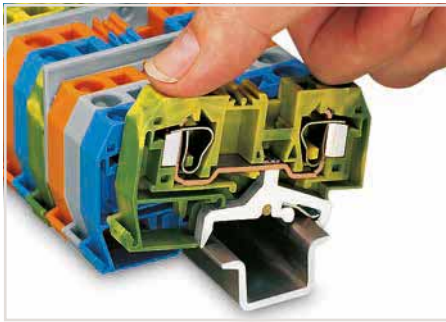

By snapping a ground conductor terminal block onto the carrier rail, a direct electrical connection is automatically made to the rail.

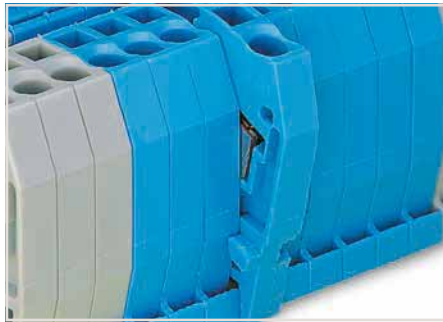

Quick assembly keys prevent reverse mounting.

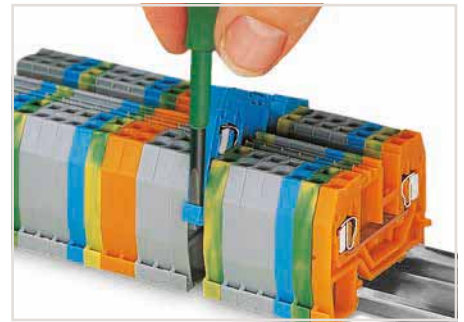

Removing a terminal block from the assembly.

5

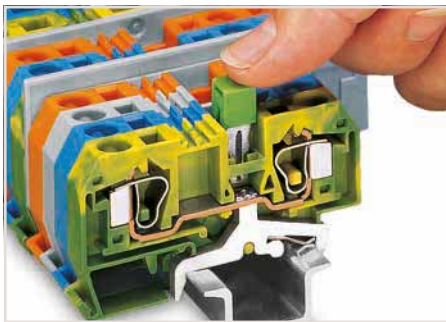

Commoning ground conductor terminal blocks with through terminal blocks is possible in one direction only (via rear side of terminal block) using adjacent jumpers. In addition to the required marking of these blocks, use yellow-green adjacent jumpers.

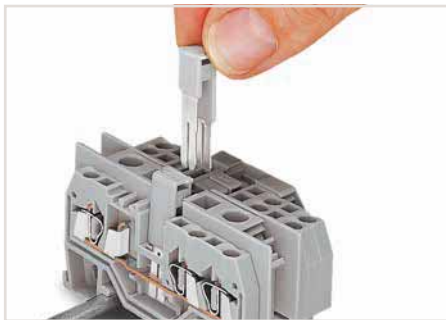

Commoning terminal blocks of different sizes via step-down jumpers.

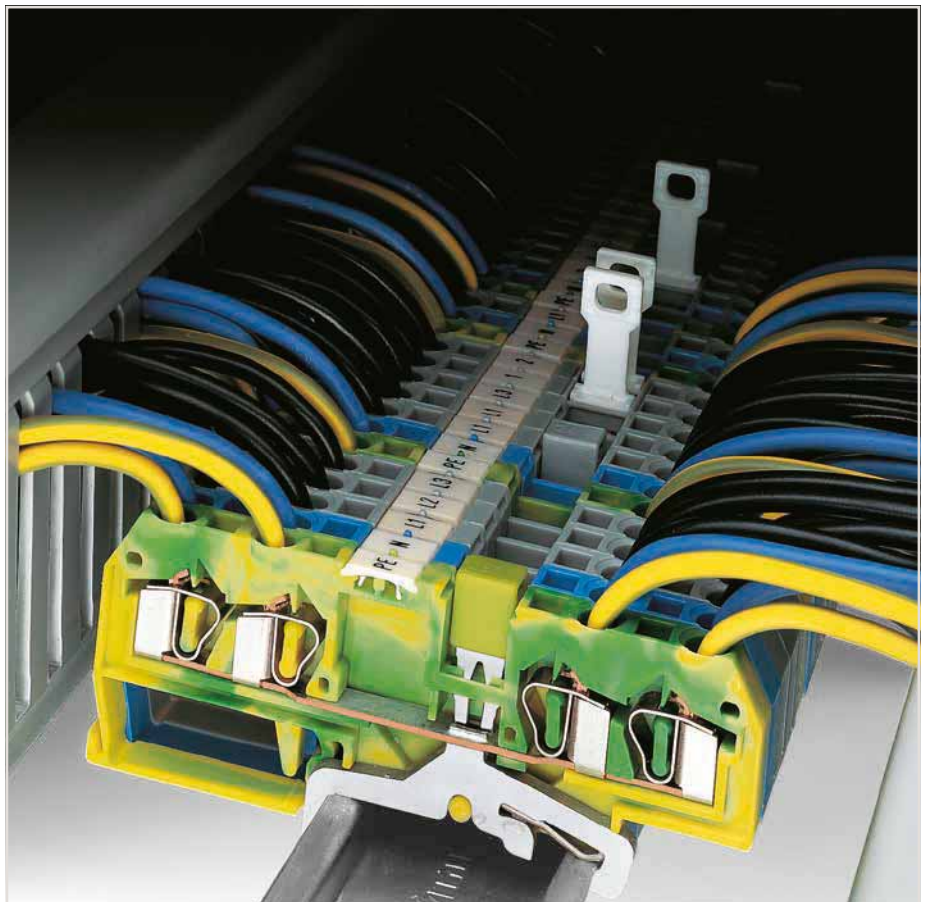

Steel carrier rails are not suited for PEN (ground and N-conductor) applications per EN 60947-7-2 (VDE 0611, Part 3).

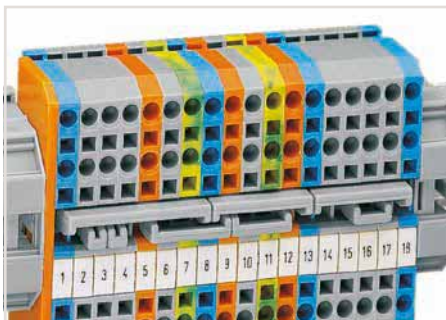

Staggered jumpers for sophisticated circuit requirements – push jumpers down until fully inserted.

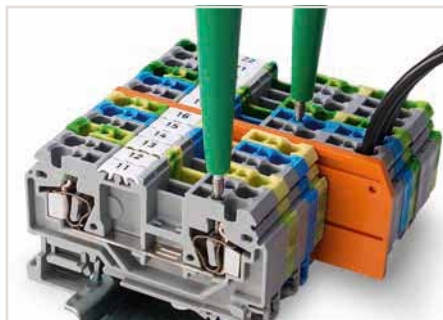

880 Series terminal blocks have an additional test slot for 2-pole voltage tester



Protective warning markers inserted into the operating slots.



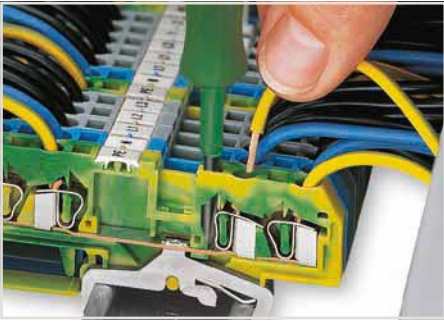

CAGE CLAMP® connection  
Inserting a conductor.



CAGE CLAMP® connection  
Inserting a conductor.  
With ferruled conductors, it is necessary to use a terminal block one size larger than the conductor's nominal cross-section.



Testing with a test plug  
(picture shows a test plug fitted with CAGE CLAMP®).

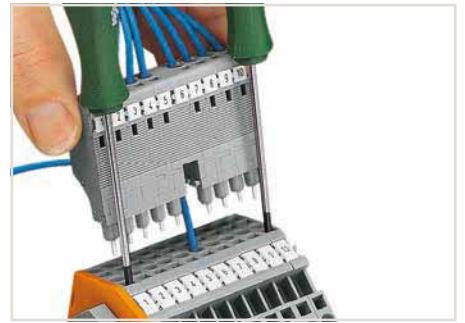
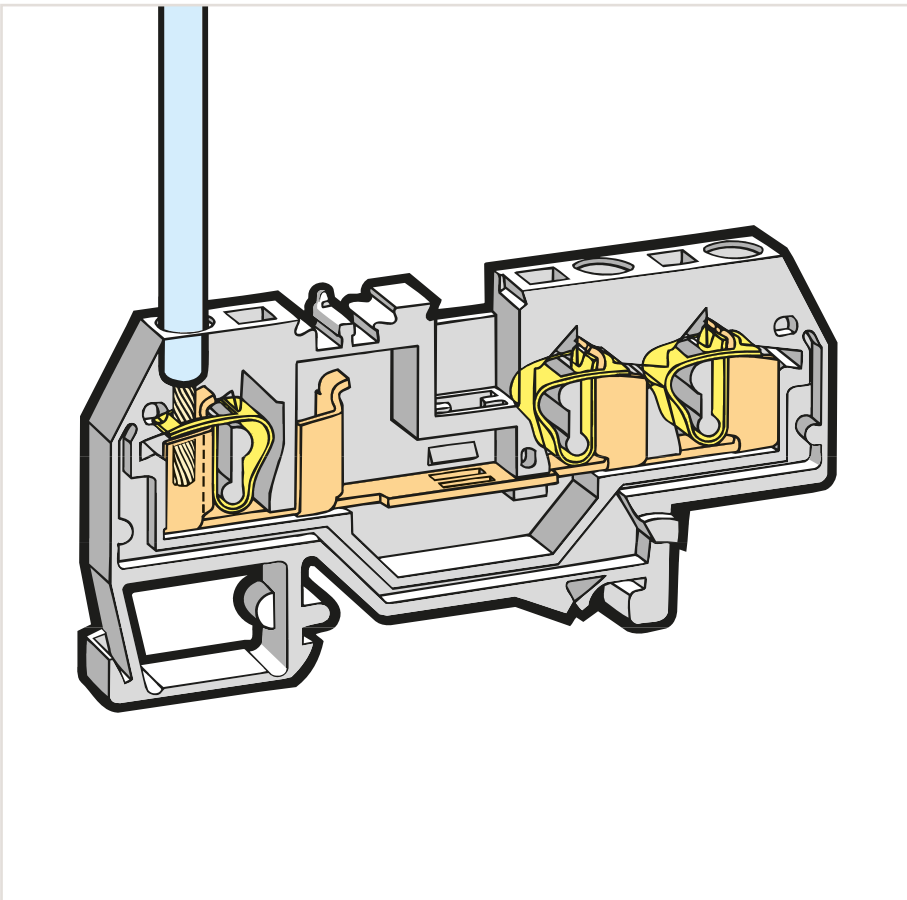

L-type test plug modules fitted with CAGE CLAMP®

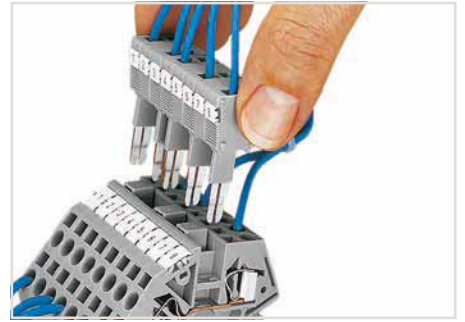

B-type test plug modules fitted with CAGE CLAMP®



Marking via WMB Multi Marking System.

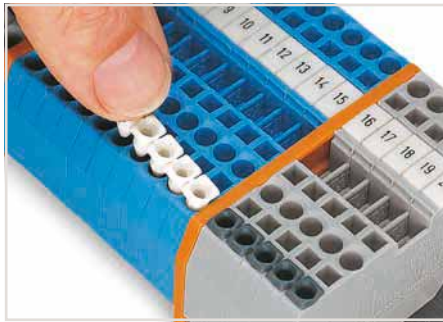

Inserting insulation stops.

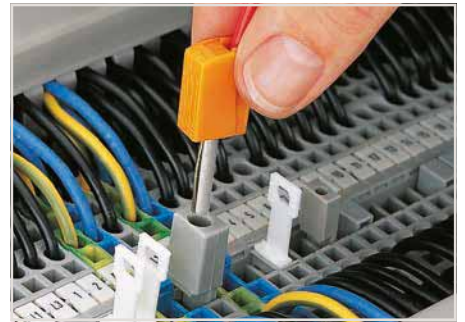

Testing with a test plug  
(picture shows 209-170 Test Plug Adapter).

## Test Plug Modules for Testing Rail-Mount Terminal Blocks Installation

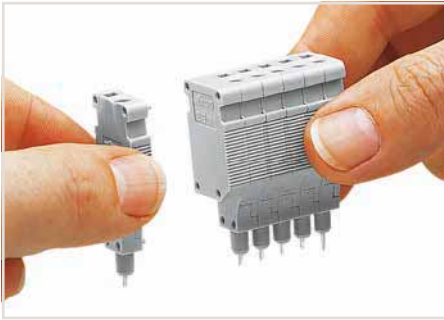

Snapping test plug and spacer modules together to assemble a multipole test plug module (max. 10 poles).

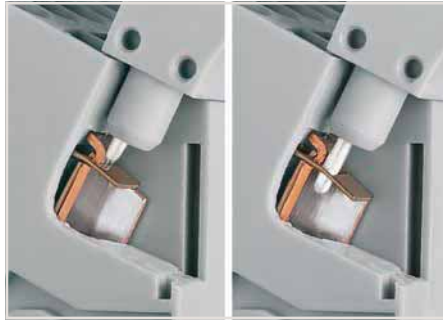

A = Center module with a spring-loaded contact pin  
B = End module with a rigid contact pin



CAGE CLAMP® connection  
0.08 ... 1.5 mm<sup>2</sup>; 5 mm wide module  
0.08 ... 2.5 mm<sup>2</sup>; 6 mm wide module

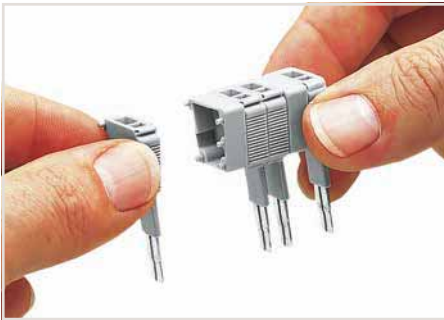

Snapping test plug and spacer modules together to assemble a multipole test plug module (max. 10 poles).

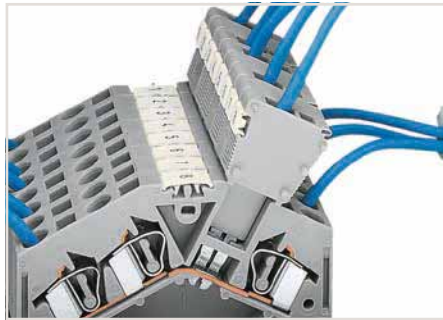

B-type test plugs are directly plugged into the jumper contact slot of the current bar.

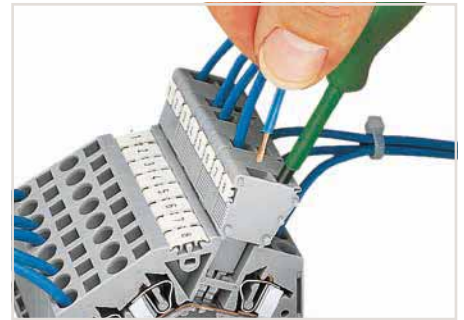

CAGE CLAMP® connection  
0.08 ... 1.5 mm<sup>2</sup>; 5 mm wide module  
0.08 ... 2.5 mm<sup>2</sup>; 6 mm wide module

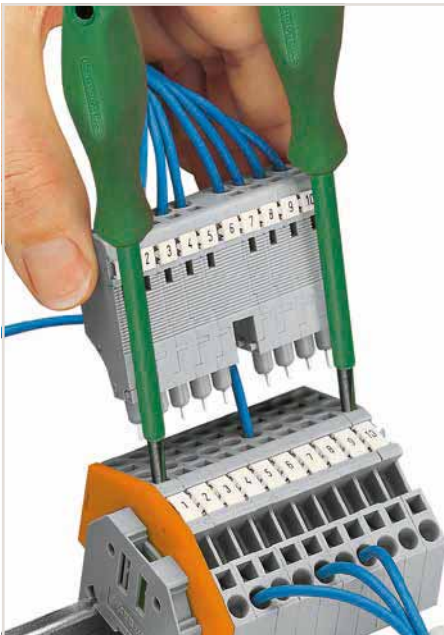

For easily testing terminal block assemblies, WAGO's L-type test plug modules with CAGE CLAMP® may be used on unwired terminal blocks. For testing, the module is assembled with spring-loaded pins in the center positions and rigid pin modules at the ends. The terminal blocks corresponding to the end position modules are opened using operating tools (as shown) – these rigid pins are then held in place by the CAGE CLAMP®.

The intermediate pins are spring-loaded and make contact with the current bars of the unwired clamping units.

Clamping units needing to remain wired may be skipped by assembling a spacer in the test plug module.

### Notice:

Mating direction must be observed (see picture).

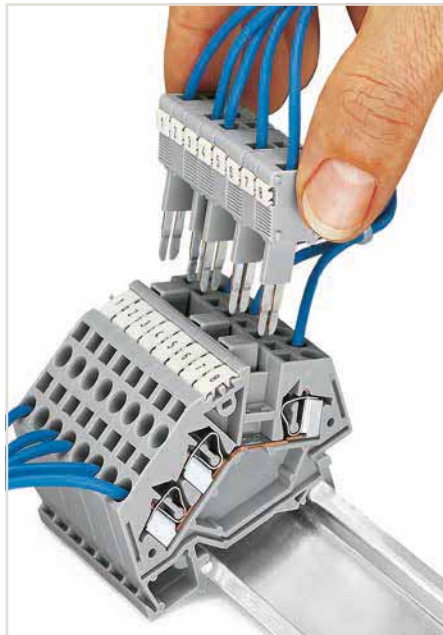

For testing individual circuits, WAGO offers a single-pole test plug accessory with CAGE CLAMP® up to 2.5 mm<sup>2</sup> (14 AWG) for direct contact with the current bar of a terminal block, or 1-pole test plug adapters for 4 mm Ø test plugs.

For serial testing on terminal block assemblies, WAGO has developed special multipole (max. 10-pole) modular test plug modules. WAGO's B-type test plug modules with CAGE CLAMP® connection are ideal for testing completely wired terminal blocks – even when using adjacent jumpers. For this testing type, the module assembly exactly matches the terminal block assembly. The test plug modules make direct contact to the jumper contact slots of the terminal blocks to be tested.



## Test Plug Modules for Testing Rail-Mount Terminal Blocks Installation

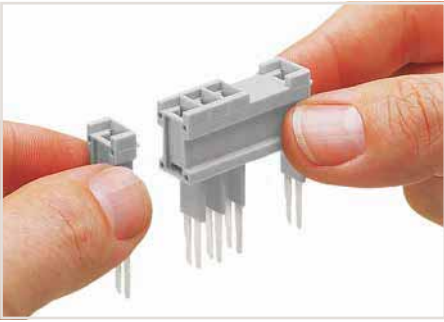

Snapping test plug and spacer modules together to assemble a multipole test plug module.

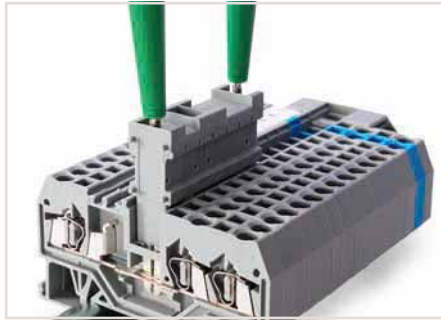

The test plug modules are directly plugged into the jumper contact slot of the current bar.

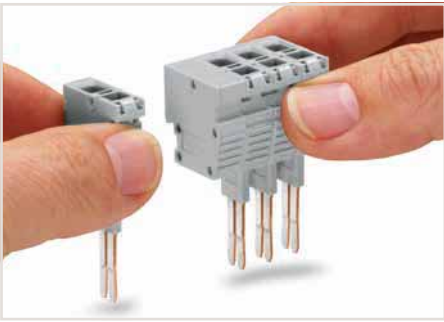

Snapping test plug and spacer modules together to assemble a multi-pole test plug module (max. 10 poles) for 8 mm terminal block width.

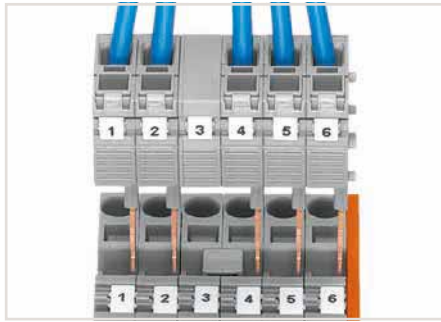

The test plug modules are directly plugged into the jumper contact slot of the current bar (picture shows 282 Series).

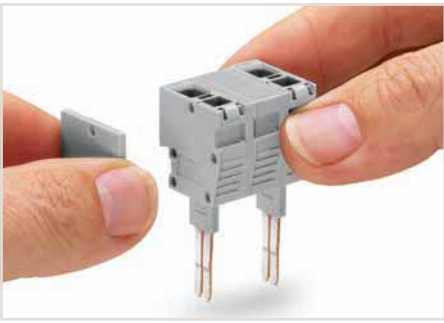
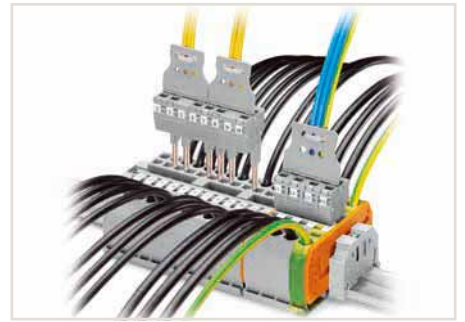

Snapping test plug and spacer modules (each with a spacer plate) together to assemble a multi-pole test plug module (max. 10 poles) for 10 mm terminal block width.



The test plug modules are directly plugged into the jumper contact slot of the current bar (picture shows 284 Series).



For testing individual circuits, WAGO offers a single-pole test plug accessory with CAGE CLAMP® up to 6 mm<sup>2</sup> (10 AWG) for direct contact with the current bar of a terminal block, or 1-pole test plug adapters for 4 mm Ø test plugs.

For serial testing on terminal block assemblies, WAGO has developed special multipole (max. 10-pole) modular test plug modules. WAGO's B-type test plug modules with CAGE CLAMP® connection are ideal for testing completely wired terminal blocks – even when using adjacent jumpers. For this testing type, the module assembly exactly matches the terminal block assembly. The test plug modules make direct contact to the jumper contact slots of the terminal blocks to be tested.

## Push-In Type Wire Jumpers and Comb-Style Jumper Bars Installation

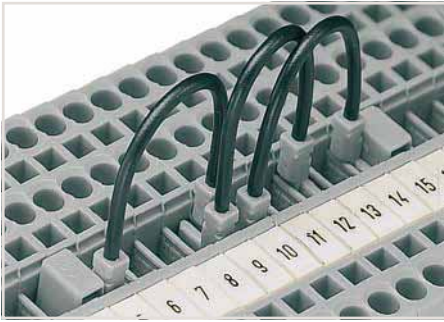

### Wire jumpers

When installing machines or control systems, it is often necessary to make an additional connection between two terminal blocks that are not next to each other on the rail. In such cases, WAGO's touch-proof, push-in type wire jumpers are the ideal solution.

These jumpers are compatible with the following rail-mount terminal blocks:

- 279 Series (1.5 mm<sup>2</sup>/16 AWG),
- 280/775/780 Series (2.5 mm<sup>2</sup>/14 AWG)
- 281/769/776/777/781 and 880 Series (4 mm<sup>2</sup>/12 AWG)

They are available in three conductor lengths (60, 110 and 250 mm), allowing up to 60 terminal blocks to be commoned depending on their width (see table on the right).

Compared with the 279 Series, the 280/775/780 and 281/776/777/781 Series can also accommodate two wire jumpers, allowing the use of commoning chains. Furthermore, the 280/769/775/780/880 and 281/776/777/781 Series allow both wire jumper and adjacent jumper to be simultaneously plugged into a same terminal block.

Terminal Blocks Series	Wire Jumpers Item No.	"n"
279 (1.5 mm <sup>2</sup> /16 AWG)	249-125	13
	249-126	25
	249-127	60
280, 775, 780 (2.5 mm <sup>2</sup> /14 AWG) 769, 880 (4 mm <sup>2</sup> /12 AWG)	249-125	10
	249-126	20
	249-127	48
281, 781, 776, 777 (4 mm <sup>2</sup> /12 AWG)	249-125	9
	249-126	17
	249-127	40

"n" = number of 279, 280/769/780/880 and 281/781 Series Rail-Mount Terminal Blocks that can be skipped with a wire jumper.

5



Disconnect/test terminal blocks, 10-way, comb-style jumper bar



4-conductor through terminal blocks, angled type – formation of groups with 3-way, comb-style jumper bars



Carrier terminal blocks with component plugs, alternate comb-style jumper bars, 3-way, comb-style jumper bar



## Banana Plugs and Insulation Stops Installation

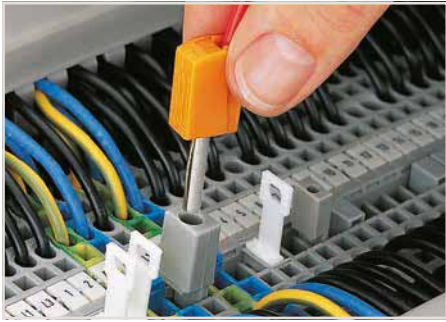

Testing with a test plug  
(picture shows 209-170 Test Plug Adapter).



Conductor termination: Press button fully, insert stripped conductor into square entry and release.

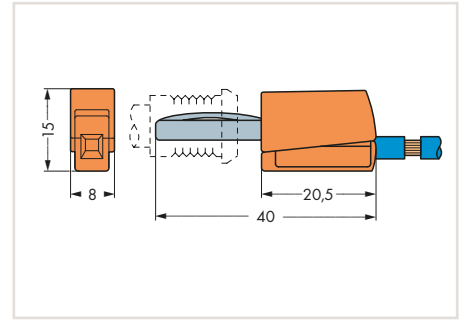

Dimensions (in mm):

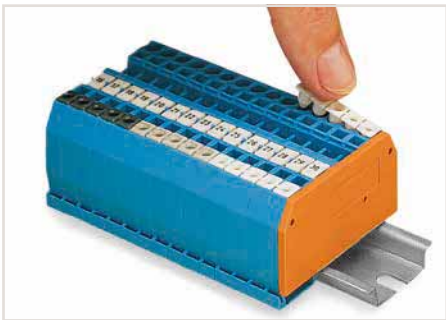

The wiring of programmable logic controllers and microprocessor-operated control circuits often relies on very small, fine-stranded conductors. These conductors are highly flexible and deform when pushed against the conductor stop in terminal blocks. As a result, the conductor insulation – not the copper conductor – may be clamped, causing intermittent contact or no contact at all. Common to all terminal block types currently offered, this problem creates unnecessary downtime for troubleshooting.

The solution: an insulation stop for rail-mount terminal blocks. Insulation stops automatically bundle the cores of fine-stranded conductors when inserted into the clamping unit, preventing splaying. This also limits the conductor entry to a defined cross-sectional area – ensuring the actual conductor, not the insulation, will enter the clamping unit.

Insulation stops are available as dividable 5-pole strips for 279, 280/780/870/880 and 281/781 Series Rail-Mount Terminal Blocks.

Insulation stop usage will not affect the conductor strip lengths for the aforementioned rail-mount terminal blocks.



Insulation stops for all rail-mount terminal blocks featuring:

Terminal block width: 4 mm (0.157 inch)	
0.08 ... 0.2 mm <sup>2</sup> "s" (0.14 mm <sup>2</sup> "f-st")	279-470
0.25 mm <sup>2</sup>	279-471
Terminal block width: 5 mm (0.197 inch)	
0.08 ... 0.2 mm <sup>2</sup> "s" (0.14 mm <sup>2</sup> "f-st")	280-470
0.25 ... 0.5 mm <sup>2</sup>	280-471
0.75 ... 1 mm <sup>2</sup>	280-472
Terminal block width: 6 mm (0.236 inch)	
0.08 ... 0.2 mm <sup>2</sup> "s" (0.14 mm <sup>2</sup> "f-st")	281-470
0.25 ... 0.5 mm <sup>2</sup>	281-471
0.75 ... 1.5 mm <sup>2</sup>	281-472

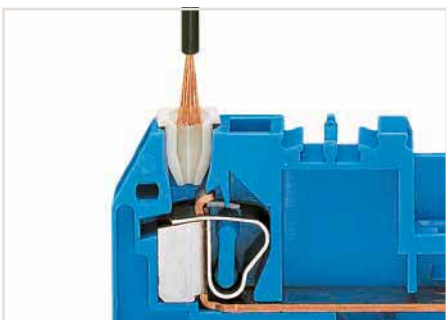

Insert stripped, untwisted conductor into insulation stop.

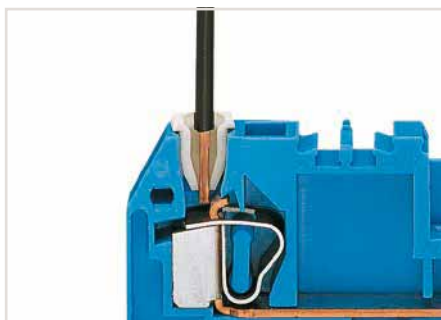

The conductor is bundled.

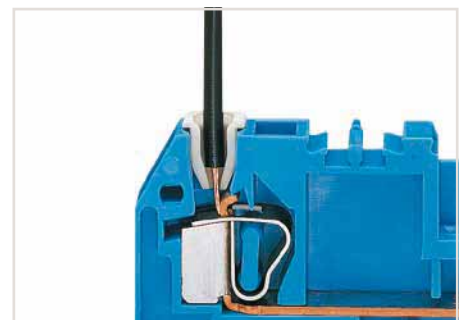

The conductor insulation is prevented from being pushed into the clamping unit by the positive stop.

## Through/Double Potential Through and Ex Terminal Blocks 1.5 mm<sup>2</sup>, 279 Series

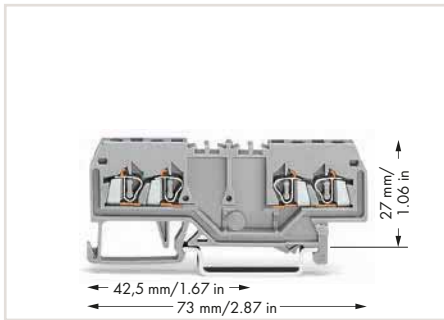

**Notice:** This double potential terminal block cannot be commoned via adjacent jumpers. Double-potential terminal blocks save space. Two independent feedthrough circuits are placed in one insulated housing on one level in just 4 mm. This achieves a width of just 2 mm versus standard through terminal blocks. Input and output of a circuit are placed on the same side of the terminal block. Both circuits can be individually marked according to input and output.

Rail-mount terminal blocks with an Ex mark are suitable for Ex e II applications.  
0.2 ... 1.5 mm<sup>2</sup> / 24 ... 16 AWG  
550 V, 15 A  
Terminal blocks with a blue insulated housing are suitable for Ex i applications.

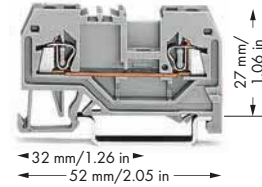

2-conductor through terminal block

Color	Item No.	Pack. Unit
○ gray	279-901	100
● blue	279-904	100
○ light gray ☺	279-992	100

WAGO

### Technical Data

Ratings per	IEC/EN 60947-7-1
Rated voltage (III / 3)	800 V
Rated surge voltage (III / 3)	8 kV
Rated current	18 A
Approval	600 V, 10 A <b>W</b> ; 600 V, 10 A <b>C</b>

### Connection Data

Solid conductor	0.08 ... 1.5 mm <sup>2</sup> / 28 ... 16 AWG
Fine-stranded conductor	0.08 ... 1.5 mm <sup>2</sup> / 28 ... 16 AWG
Strip length	8 ... 9 mm / 0.31 ... 0.35 inch
Terminal block width	4 mm / 0.157 inch
Insulation material	Polyamide 66 (PA 66)

### Note:

### Accessories (Selection)

Adjacent jumper, insulated, I <sub>n</sub> 15 A
End and intermediate plate, 2 mm thick
WMB Inline, plain, 2,000 WMB markers (4 mm) per reel, 4 ... 4.2 mm stretchable
Test plug adapter, 5 mm wide, for 210-137 Test Plug (2.3 mm Ø), for 1.5 ... 4 mm <sup>2</sup> terminal blocks

IEC/EN 60947-7-1
800 V
8 kV
18 A
600 V, 10 A <b>W</b> ; 600 V, 10 A <b>C</b>

	Item No.	Page
gray	279-402	438
orange	279-328	438
white	2009-114	780
gray	280-404	460



### End and intermediate plate

In order to meet creepage and clearance requirements for Ex e applications, it is necessary to insert an end or intermediate plate between a through and a ground conductor terminal block.

Additional colors, visit [www.wago.com](http://www.wago.com)

Accessories (jumpers, end plates, test plugs, etc.), see page 438

Carrier rails and tools, see Section 13

Appropriate marking system, WMB/WMB Inline/WFB, see Full Line Catalog, Volume 6

Information on hazardous locations, see Section 14

Approvals and corresponding ratings, visit [www.wago.com](http://www.wago.com)

5

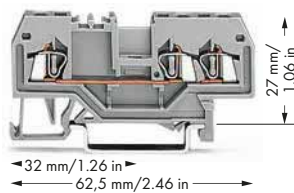

3-conductor through terminal block

Color	Item No.	Pack. Unit
● gray	279-681	100
● blue	279-684	100
○ light gray ☺	279-993	100



IEC/EN 60947-7-1
800 V
8 kV
18 A
600 V, 10 A ; 600 V, 10 A
0.08 ... 1.5 mm <sup>2</sup> / 28 ... 16 AWG
0.08 ... 1.5 mm <sup>2</sup> / 28 ... 16 AWG
8 ... 9 mm / 0.31 ... 0.35 inch
4 mm / 0.157 inch
Polyamide 66 (PA 66)

	Item No.	Page
gray	279-402	438
orange	279-339	439
white	2009-114	780
gray	280-404	460

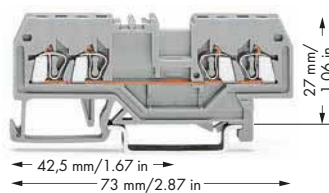

4-conductor through terminal block

Color	Item No.	Pack. Unit
● gray	279-831	100
● blue	279-834	100
○ light gray ☺	279-994	100



IEC/EN 60947-7-1
800 V
8 kV
18 A
600 V, 10 A ; 600 V, 10 A
0.08 ... 1.5 mm <sup>2</sup> / 28 ... 16 AWG
0.08 ... 1.5 mm <sup>2</sup> / 28 ... 16 AWG
8 ... 9 mm / 0.31 ... 0.35 inch
4 mm / 0.157 inch
Polyamide 66 (PA 66)

	Item No.	Page
gray	279-402	438
orange	279-346	439
white	2009-114	780
gray	280-404	460

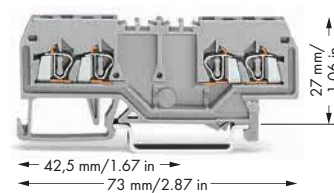

Double potential terminal block, with double, center marker slot

Color	Item No.	Pack. Unit
● gray	279-826	100
○ light gray ☺	279-995	100



IEC/EN 60947-7-1
800 V
8 kV
18 A
600 V, 10 A ; 600 V, 10 A
0.08 ... 1.5 mm <sup>2</sup> / 28 ... 16 AWG
0.08 ... 1.5 mm <sup>2</sup> / 28 ... 16 AWG
8 ... 9 mm / 0.31 ... 0.35 inch
4 mm / 0.157 inch
Polyamide 66 (PA 66)

Notice: This double potential terminal block cannot be commoned via adjacent jumpers.

	Item No.	Page
orange	279-346	439
white	2009-114	780

## Ground/Shield Conductor and Ex Terminal Blocks

### 1.5 mm<sup>2</sup>, 279 Series

Rail-mount terminal blocks with an Ex mark are suitable for Ex e II applications.  
0.2 ... 1.5 mm<sup>2</sup> / 24 ... 16 AWG

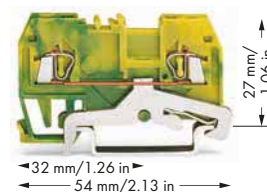

2-conductor ground terminal block

Color	Item No.	Pack. Unit
● green-yellow	279-907	100
● green-yellow Ⓜ	279-907/999-950	100

5

#### Technical Data

Ratings per	
<b>Connection Data</b>	
Solid conductor	
Fine-stranded conductor	
Strip length	
Terminal block width	
Insulation material	

Ⓜ

IEC/EN 60947-7-2
0.08 ... 1.5 mm <sup>2</sup> / 28 ... 16 AWG
0.08 ... 1.5 mm <sup>2</sup> / 28 ... 16 AWG
8 ... 9 mm / 0.31 ... 0.35 inch
4 mm / 0.157 inch
Polyamide 66 (PA 66)

#### Accessories (Selection)

Adjacent jumper, insulated, I <sub>n</sub> 15 A
End and intermediate plate, 2 mm thick
WMB Inline, plain, 2,000 WMB markers (4 mm) per reel, 4 ... 4.2 mm stretchable
Test plug adapter, 5 mm wide, for 210-137 Test Plug (2.3 mm Ø), for 1.5 ... 4 mm <sup>2</sup> terminal blocks

	Item No.	Page
gray	279-402	438
orange	279-328	438
white	2009-114	780
gray	280-404	460

📖 Accessories (jumpers, end plates, test plugs, etc.), see page 438

📖 Carrier rails and tools, see Section 13

📖 Appropriate marking system, WMB/WMB Inline/WFB, see Full Line Catalog, Volume 6

📖 Information on hazardous locations, see Section 14

📖 Approvals and corresponding ratings, visit [www.wago.com](http://www.wago.com)

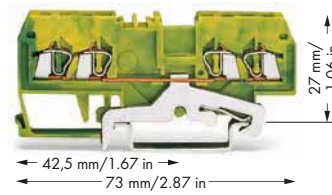
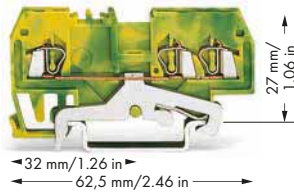

3-conductor ground terminal block		
Color	Item No.	Pack. Unit
● green-yellow	279-687	100
● green-yellow ☉	279-687/999-950	100

4-conductor ground terminal block		
Color	Item No.	Pack. Unit
● green-yellow	279-837	100
● green-yellow ☉	279-837/999-950	100

4-conductor shield terminal block		
Color	Item No.	Pack. Unit
○ white	279-838	100



IEC/EN 60947-7-2

IEC/EN 60947-7-2

0.08 ... 1.5 mm<sup>2</sup> / 28 ... 16 AWG

0.08 ... 1.5 mm<sup>2</sup> / 28 ... 16 AWG

0.08 ... 1.5 mm<sup>2</sup> / 28 ... 16 AWG

0.08 ... 1.5 mm<sup>2</sup> / 28 ... 16 AWG

8 ... 9 mm / 0.31 ... 0.35 inch

8 ... 9 mm / 0.31 ... 0.35 inch

4 mm / 0.157 inch

4 mm / 0.157 inch

Polyamide 66 (PA 66)

Polyamide 66 (PA 66)

	Item No.	Page
gray	279-402	438
orange	279-339	439
white	2009-114	780
gray	280-404	460

	Item No.	Page
gray	279-402	438
orange	279-346	439
white	2009-114	780
gray	280-404	460

## Through/Double Potential Through and Ex Terminal Blocks 2.5 mm<sup>2</sup>, 280 Series

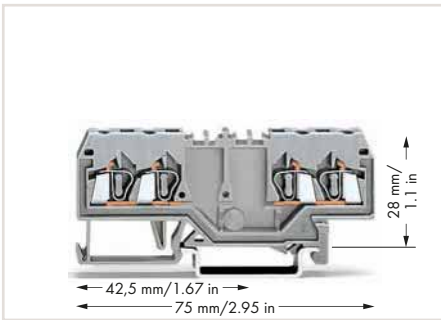

**Notice:** This double potential terminal block cannot be commoned via adjacent jumpers. Double-potential terminal blocks save space. Two independent feedthrough circuits are placed in one insulated housing on one level in just 5 mm. This achieves a width of just 2.5 mm versus standard through terminal blocks. Input and output of a circuit are placed on the same side of the terminal block. Both circuits can be individually marked according to input and output.

\*12 AWG: THHN, THWN  
Rail-mount terminal blocks with an Ex mark are suitable for Ex e II applications.  
0.2 ... 2.5 mm<sup>2</sup> / 24 ... 12 AWG\*  
550 V  
23 A for 2-conductor terminal blocks  
22 A for 3-conductor terminal blocks  
20 A for 4-conductor terminal blocks  
Using staggered jumpers reduces the maximum rated voltage to 275 V.  
Terminal blocks with a blue insulated housing are suitable for Ex i applications.

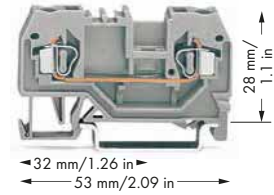

2-conductor through terminal block

Color	Item No.	Pack. Unit
○ gray	280-901	100
● blue	280-904	100
○ light gray ☺	280-992	100

WAGO

### Technical Data

Ratings per	IEC/EN 60947-7-1
Rated voltage (III / 3)	800 V
Rated surge voltage (III / 3)	8 kV
Rated current	24 A
Approval	600 V, 20 A <b>W</b> ; 600 V, 25 A <b>Ⓢ</b>

### Connection Data

Solid conductor	0.08 ... 2.5 mm <sup>2</sup> / 28 ... 12 AWG
Fine-stranded conductor	0.08 ... 2.5 mm <sup>2</sup> / 28 ... 12 AWG
Note (conductor cross section)	12 AWG: THHN, THWN
Strip length	8 ... 9 mm / 0.31 ... 0.35 inch
Terminal block width	5 mm / 0.197 inch
Insulation material	Polyamide 66 (PA 66)

**Note:**

### Accessories (Selection)

Adjacent jumper, insulated, I <sub>N</sub> = I <sub>N</sub> terminal block	
End and intermediate plate, 2.5 mm thick	
WMB Inline, plain, 1,500 WMB markers (5 mm) per reel, 5 ... 5.2 mm stretchable	
Test plug adapter, 5 mm wide, for 210-137 Test Plug (2.3 mm Ø), for 1.5 ... 4 mm <sup>2</sup> terminal blocks	

	Item No.	Page
gray	280-402	440
orange	280-309	441
white	2009-115	780
gray	280-404	460

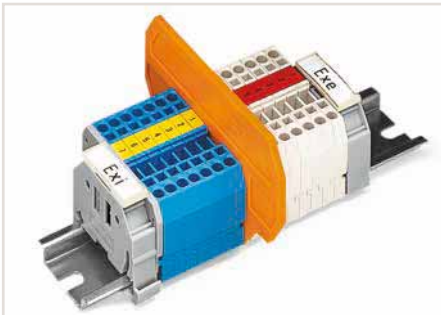

### Separator for Ex e/Ex i applications

According to EN 50020, a minimum distance of 50 mm must be kept between live parts of Ex e and Ex i circuits. The use of Ex e/Ex i separators is a space-saving solution when Ex e and Ex i terminal blocks are mounted on a common carrier rail. Compatible with 279 ... 282 Series: 209-190 for 2-conductor terminal blocks 209-191 for 2-, 3-, 4-conductor terminal blocks

Additional colors, visit [www.wago.com](http://www.wago.com)

Accessories (jumpers, end plates, test plugs, etc.), see page 440

Carrier rails and tools, see Section 13

Appropriate marking system, WMB/WMB Inline/WFB, see Full Line Catalog, Volume 6

Information on hazardous locations, see Section 14

Approvals and corresponding ratings, visit [www.wago.com](http://www.wago.com)



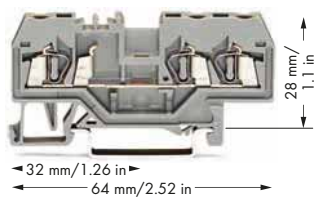

3-conductor through terminal block

Color	Item No.	Pack. Unit
● gray	280-681	100
● blue	280-684	100
○ light gray ☉	280-993	100



IEC/EN 60947-7-1
800 V
8 kV
24 A
600 V, 20 A ; 600 V, 15 A
0.08 ... 2.5 mm <sup>2</sup> / 28 ... 12 AWG
0.08 ... 2.5 mm <sup>2</sup> / 28 ... 12 AWG
12 AWG: THHN, THWN
8 ... 9 mm / 0.31 ... 0.35 inch
5 mm / 0.197 inch
Polyamide 66 (PA 66)

	Item No.	Page
gray	280-402	440
orange	280-326	441
white	2009-115	780
gray	280-404	460

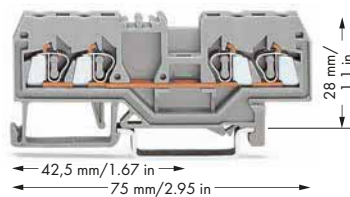

4-conductor through terminal block

Color	Item No.	Pack. Unit
● gray	280-833	100
● blue	280-834	100
○ light gray ☉	280-994	100



IEC/EN 60947-7-1
800 V
8 kV
20 A
600 V, 20 A ; 600 V, 25 A
0.08 ... 2.5 mm <sup>2</sup> / 28 ... 12 AWG
0.08 ... 2.5 mm <sup>2</sup> / 28 ... 12 AWG
12 AWG: THHN, THWN
8 ... 9 mm / 0.31 ... 0.35 inch
5 mm / 0.197 inch
Polyamide 66 (PA 66)

	Item No.	Page
gray	280-402	440
orange	280-315	442
white	2009-115	780
gray	280-404	460

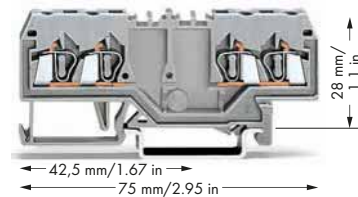

Double potential terminal block, with double, center marker slot

Color	Item No.	Pack. Unit
● gray	280-826	100
○ light gray ☉	280-995	100



IEC/EN 60947-7-1
800 V
8 kV
24 A
600 V, 15 A
0.08 ... 2.5 mm <sup>2</sup> / 28 ... 12 AWG
0.08 ... 2.5 mm <sup>2</sup> / 28 ... 12 AWG
12 AWG: THHN, THWN
8 ... 9 mm / 0.31 ... 0.35 inch
5 mm / 0.197 inch
Polyamide 66 (PA 66)

Notice: This double potential terminal block cannot be commoned via adjacent jumpers.

	Item No.	Page
orange	280-315	442
white	2009-115	780

## Ground/Shield Conductor and Ex Terminal Blocks

### 2.5 mm<sup>2</sup>, 280 Series



\*12 AWG: THHN, THWN  
 Rail-mount terminal blocks with an Ex mark are suitable for Ex e II applications.  
 0.2 ... 2.5 mm<sup>2</sup> / 24 ... 12 AWG\*

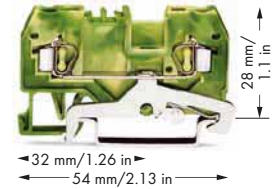

2-conductor ground terminal block		
Color	Item No.	Pack. Unit
● green-yellow	280-907	100
● green-yellow Ⓢ	280-907/999-950	100

5

#### Technical Data

Ratings per	IEC/EN 60947-7-2
<b>Connection Data</b>	
Solid conductor	0.08 ... 2.5 mm <sup>2</sup> / 28 ... 12 AWG
Fine-stranded conductor	0.08 ... 2.5 mm <sup>2</sup> / 28 ... 12 AWG
Note (conductor cross section)	12 AWG: THHN, THWN
Strip length	8 ... 9 mm / 0.31 ... 0.35 inch
Terminal block width	5 mm / 0.197 inch
Insulation material	Polyamide 66 (PA 66)

#### Accessories (Selection)

Adjacent jumper, insulated, I <sub>N</sub> = I <sub>N</sub> terminal block	
End and intermediate plate, 2.5 mm thick	
WMB Inline, plain, 1,500 WMB markers (5 mm) per reel, 5 ... 5.2 mm stretchable	
Test plug adapter, 5 mm wide, for 210-137 Test Plug (2.3 mm Ø), for 1.5 ... 4 mm <sup>2</sup> terminal blocks	

Ⓢ

	Item No.	Page
gray	280-402	440
orange	280-309	441
white	2009-115	780
gray	280-404	460

📖 Accessories (jumpers, end plates, test plugs, etc.), see page 440

📖 Carrier rails and tools, see Section 13

📖 Appropriate marking system, WMB/WMB Inline/WFB, see Full Line Catalog, Volume 6

📖 Information on hazardous locations, see Section 14

📖 Approvals and corresponding ratings, visit [www.wago.com](http://www.wago.com)

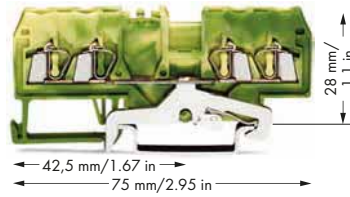
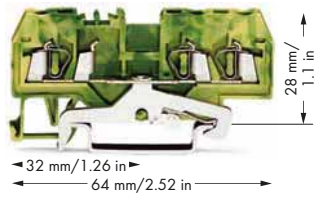

3-conductor ground terminal block		
Color	Item No.	Pack. Unit
● green-yellow	280-687	100
● green-yellow ☉	280-687/999-950	100

4-conductor ground terminal block		
Color	Item No.	Pack. Unit
● green-yellow	280-837	100
● green-yellow ☉	280-837/999-950	100

4-conductor shield terminal block		
Color	Item No.	Pack. Unit
○ white	280-838	100



IEC/EN 60947-7-2

IEC/EN 60947-7-2

0.08 ... 2.5 mm<sup>2</sup> / 28 ... 12 AWG  
 0.08 ... 2.5 mm<sup>2</sup> / 28 ... 12 AWG  
 12 AWG: THHN, THWN  
 8 ... 9 mm / 0.31 ... 0.35 inch  
 5 mm / 0.197 inch  
 Polyamide 66 (PA 66)

0.08 ... 2.5 mm<sup>2</sup> / 28 ... 12 AWG  
 0.08 ... 2.5 mm<sup>2</sup> / 28 ... 12 AWG  
 12 AWG: THHN, THWN  
 8 ... 9 mm / 0.31 ... 0.35 inch  
 5 mm / 0.197 inch  
 Polyamide 66 (PA 66)

	Item No.	Page
gray	280-402	440
orange	280-326	441
white	2009-115	780
gray	280-404	460

	Item No.	Page
gray	280-402	440
orange	280-315	442
white	2009-115	780
gray	280-404	460

## Through, Ground/Shield Conductor and Ex Terminal Blocks 2.5 mm<sup>2</sup>, 280 Series

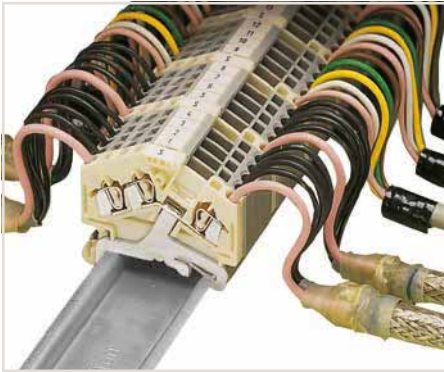

Application example for shield conductor terminal blocks

Shielded control cables are becoming an increasingly common solution to external signal interference. Front-entry shield conductor terminal blocks are ideal for connecting braided cables. Like front-entry ground conductor terminal blocks, they are equipped with a grounding foot for direct electrical connection to the rail, however they differ significantly by their white insulated housing. Shield conductor terminal blocks for front-entry wiring can be directly mounted beside signal-conductor terminal blocks, providing excellent deflection of interfering signals.

\*12 AWG: THHN, THWN  
Rail-mount terminal blocks with an Ex mark are suitable for Ex e II applications.  
0.2 ... 2.5 mm<sup>2</sup> / 24 ... 12 AWG\*  
550 V, 23 A  
Using staggered jumpers reduces the maximum rated voltage to 275 V.  
Terminal blocks with a blue insulated housing are suitable for Ex i applications.

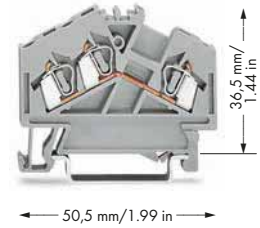

3-conductor through terminal block		
Color	Item No.	Pack. Unit
○ gray	280-641	100
● blue	280-651	100
○ light gray	280-998	100

### Technical Data

Ratings per	IEC/EN 60947-7-1
Rated voltage (III / 3)	800 V
Rated surge voltage (III / 3)	8 kV
Rated current	24 A
Approval	600 V, 20 A ; 600 V, 25 A

### Connection Data

Solid conductor	0.08 ... 2.5 mm <sup>2</sup> / 28 ... 12 AWG
Fine-stranded conductor	0.08 ... 2.5 mm <sup>2</sup> / 28 ... 12 AWG
Note (conductor cross section)	12 AWG: THHN, THWN
Strip length	8 ... 9 mm / 0.31 ... 0.35 inch
Terminal block width	5 mm / 0.197 inch
Insulation material	Polyamide 66 (PA 66)

### Note:

### Accessories (Selection)

Adjacent jumper, insulated, I <sub>N</sub> = I <sub>N</sub> terminal block	gray	280-402	440
Comb-style jumper bar, insulated, IN = IN terminal block, gray			
End and intermediate plate, 2.5 mm thick	orange	280-313	442
WMB Inline, plain, 1,500 WMB markers (5 mm) per reel, 5 ... 5.2 mm stretchable	white	2009-115	780
Test plug adapter, 5 mm wide, for 210-137 Test Plug (2.3 mm Ø), for 1.5 ... 4 mm <sup>2</sup> terminal blocks	gray	280-404	460
L-type test plug module with spring-loaded contact pin and CAGE CLAMP®, center module, snaps together Module width 5 mm	gray	249-141	444

Additional colors, visit [www.wago.com](http://www.wago.com)

Accessories (jumpers, end plates, test plugs, etc.), see page 440

Carrier rails and tools, see Section 13

Appropriate marking system, WMB/WMB Inline/WFB, see Full Line Catalog, Volume 6

Information on hazardous locations, see Section 14

Approvals and corresponding ratings, visit [www.wago.com](http://www.wago.com)

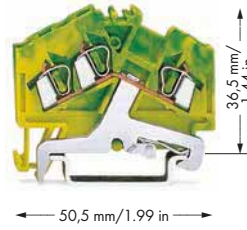
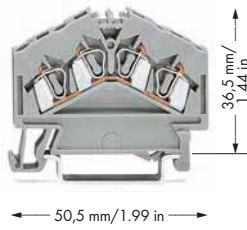

4-conductor through terminal block		
Color	Item No.	Pack. Unit
○ gray	280-646	100
● blue	280-656	100
○ light gray ☺	280-996	100

3-conductor ground terminal block		
Color	Item No.	Pack. Unit
● green-yellow	280-637	100
● green-yellow ☺	280-637/999-950	100

3-conductor shield terminal block		
Color	Item No.	Pack. Unit
○ white	280-640	100



IEC/EN 60947-7-1  
 800 V  
 8 kV  
 24 A  
 600 V, 20 A ; 600 V, 25 A

IEC/EN 60947-7-2

0.08 ... 2.5 mm<sup>2</sup> / 28 ... 12 AWG  
 0.08 ... 2.5 mm<sup>2</sup> / 28 ... 12 AWG  
 12 AWG: THHN, THWN  
 8 ... 9 mm / 0.31 ... 0.35 inch  
 5 mm / 0.197 inch  
 Polyamide 66 (PA 66)

0.08 ... 2.5 mm<sup>2</sup> / 28 ... 12 AWG  
 0.08 ... 2.5 mm<sup>2</sup> / 28 ... 12 AWG  
 12 AWG: THHN, THWN  
 8 ... 9 mm / 0.31 ... 0.35 inch  
 5 mm / 0.197 inch  
 Polyamide 66 (PA 66)

Notice: This terminal block cannot be commoned with adjacent jumpers.

	Item No.	Page
2-way	280-482	440
orange	280-313	442
white	2009-115	780
gray	249-141	444

	Item No.	Page
gray	280-402	440
orange	280-313	442
white	2009-115	780
gray	280-404	460
gray	249-141	444

## Through Terminal Blocks, 5 mm Wide, for 12 AWG Specialty Conductors with Ferrules (216-206)

### 4 mm<sup>2</sup>, 880 Series

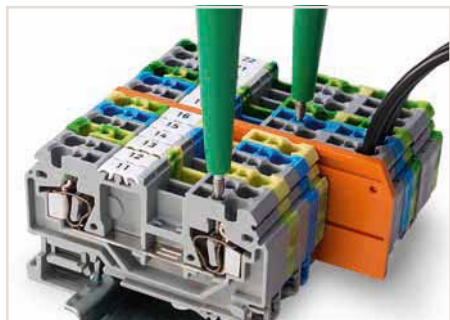

880 Series terminal blocks have an additional test slot for 2-pole voltage tester

Terminal blocks with a blue insulated housing are suitable for Ex i applications.

Through terminal blocks with shield contacts are available upon request.

400 V/6 kV/3  
 eULus 300 V, 10 A

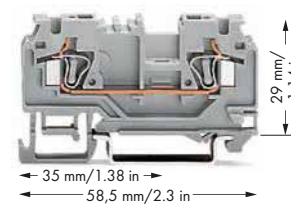

2-conductor through terminal block, no shield contact, with test slot for 2 and 2.3 mm Ø test plugs, for specialty conductors, 4.4 mm insulation diameter (max.)

Color	Item No.	Pack. Unit
○ gray	880-901/999-940	100
● blue	880-904/999-940	100

eULus

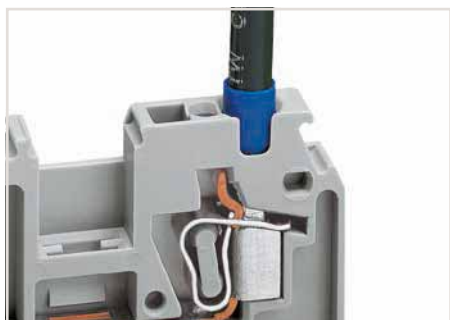

Using a 12 AWG conductor with ferrule.  
 Item No. 216-206

#### Technical Data

Ratings per	IEC/EN 60947-7-1
Rated voltage (III / 3)	800 V
Rated surge voltage (III / 3)	8 kV
Rated current	25 A
Approval	600 V, 20 A, eULus

#### Connection Data

Solid conductor	0.08 ... 4 mm <sup>2</sup> / 28 ... 12 AWG
Fine-stranded conductor	0.08 ... 4 mm <sup>2</sup> / 28 ... 12 AWG
Strip length	8 ... 9 mm / 0.31 ... 0.35 inch
Terminal block width	5 mm / 0.197 inch
Insulation material	Polyamide 66 (PA 66)

#### Accessories (Selection)

Adjacent jumper, insulated, I <sub>N</sub> = I <sub>N</sub> terminal block	gray	280-402	440
End and intermediate plate, 2.5 mm thick	orange	880-328	442
WMB Inline, plain, 1,500 WMB markers (5 mm) per reel, 5 ... 5.2 mm stretchable	white	2009-115	780
Test plug adapter, 5 mm wide, for 210-137 Test Plug (2.3 mm Ø), for 1.5 ... 4 mm <sup>2</sup> terminal blocks	gray	280-404	460

#### Features:

- 2-, 3- and 4-conductor terminal blocks, just 5 mm wide
- Conductor cross section up to 4 mm<sup>2</sup> (per VDE 0281) or 12 AWG with ferrule (Item No. 216-206) 2.5 mm<sup>2</sup> rubber-insulated conductors with outer diameter up to 4.4 mm
- Shield contact, solder/quick-connect contact 6.3 (2 x 2.8) mm
- Test plug, red, 2 mm Ø
- Test plug, yellow, 2.3 mm Ø
- WMB markers
- Mini-WSB markers, on both sides
- Commoning with WAGO jumper systems

Additional colors, visit [www.wago.com](http://www.wago.com)

Accessories (jumpers, end plates, test plugs, etc.), see page 440

Carrier rails and tools, see Section 13

Appropriate marking system, WMB/WMB Inline/WFB, see Full Line Catalog, Volume 6

Approvals and corresponding ratings, visit [www.wago.com](http://www.wago.com)

5



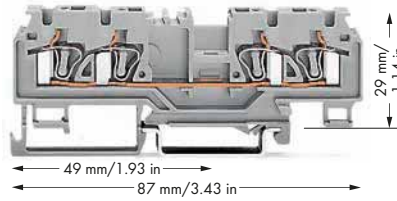
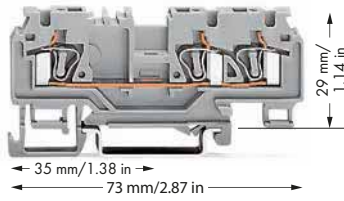

3-conductor through terminal block, no shield contact, with test slot for 2 and 2.3 mm Ø test plugs, for specialty conductors, 4.4 mm insulation diameter (max.)

Color	Item No.	Pack. Unit
○ gray	880-681/999-940	100
● blue	880-684/999-940	100



IEC/EN 60947-7-1

800 V

8 kV

25 A

600 V, 20 A

0.08 ... 4 mm<sup>2</sup> / 28 ... 12 AWG

0.08 ... 4 mm<sup>2</sup> / 28 ... 12 AWG

8 ... 9 mm / 0.31 ... 0.35 inch

5 mm / 0.197 inch

Polyamide 66 (PA 66)

	Item No.	Page
gray	280-402	440
orange	880-339	442
white	2009-115	780
gray	280-404	460

4-conductor through terminal block, no shield contact, with test slot for 2 and 2.3 mm Ø test plugs, for specialty conductors, 4.4 mm insulation diameter (max.)

Color	Item No.	Pack. Unit
○ gray	880-831/999-940	50
● blue	880-834/999-940	50



IEC/EN 60947-7-1

800 V

8 kV

20 A

600 V, 20 A

0.08 ... 4 mm<sup>2</sup> / 28 ... 12 AWG

0.08 ... 4 mm<sup>2</sup> / 28 ... 12 AWG

8 ... 9 mm / 0.31 ... 0.35 inch

5 mm / 0.197 inch

Polyamide 66 (PA 66)

	Item No.	Page
gray	280-402	440
orange	880-346	442
white	2009-115	780
gray	280-404	460

## Ground Conductor Terminal Blocks, 5 mm Wide, for 12 AWG Specialty Conductors with Ferrules (216-206)

### 4 mm<sup>2</sup>, 880 Series

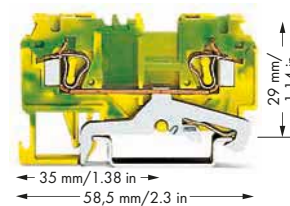

2-conductor ground terminal block, with test slot for 2 and 2.3 mm Ø test plugs, for specialty conductors, 4.4 mm insulation diameter (max.)

Color	Item No.	Pack. Unit
● green-yellow	880-907/999-940	100



5

#### Technical Data

Ratings per	IEC/EN 60947-7-2
<b>Connection Data</b>	
Solid conductor	0.08 ... 4 mm <sup>2</sup> / 28 ... 12 AWG
Fine-stranded conductor	0.08 ... 4 mm <sup>2</sup> / 28 ... 12 AWG
Strip length	8 ... 9 mm / 0.31 ... 0.35 inch
Terminal block width	5 mm / 0.197 inch
Insulation material	Polyamide 66 (PA 66)

#### Accessories (Selection)

	Item No.	Page
Adjacent jumper, insulated, I <sub>N</sub> = I <sub>N</sub> terminal block	gray 280-402	440
End and intermediate plate, 2.5 mm thick	orange 880-328	442
WMB Inline, plain, 1,500 WMB markers (5 mm) per reel, 5 ... 5.2 mm stretchable	white 2009-115	780
Test plug adapter, 5 mm wide, for 210-137 Test Plug (2.3 mm Ø), for 1.5 ... 4 mm <sup>2</sup> terminal blocks	gray 280-404	460

Accessories (jumpers, end plates, test plugs, etc.), see page 440

Carrier rails and tools, see Section 13

Appropriate marking system, WMB/WMB Inline/WFB, see Full Line Catalog, Volume 6

Approvals and corresponding ratings, visit [www.wago.com](http://www.wago.com)

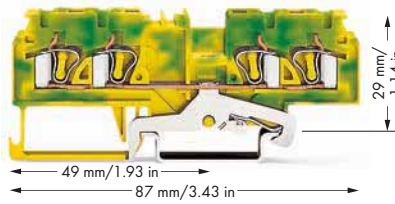
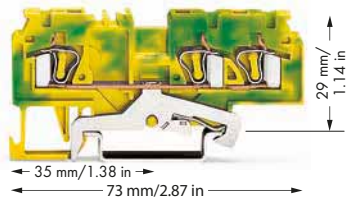

3-conductor ground terminal block, with test slot for 2 and 2.3 mm Ø test plugs, for specialty conductors, 4.4 mm insulation diameter (max.)

Color	Item No.	Pack. Unit
● green-yellow	880-687/999-940	100



IEC/EN 60947-7-2

0.08 ... 4 mm<sup>2</sup> / 28 ... 12 AWG

0.08 ... 4 mm<sup>2</sup> / 28 ... 12 AWG

8 ... 9 mm / 0.31 ... 0.35 inch

5 mm / 0.197 inch

Polyamide 66 (PA 66)

	Item No.	Page
gray	280-402	440
orange	880-339	442
white	2009-115	780
gray	280-404	460

4-conductor ground terminal block, with test slot for 2 and 2.3 mm Ø test plugs, for specialty conductors, 4.4 mm insulation diameter (max.)

Color	Item No.	Pack. Unit
● green-yellow	880-837/999-940	50



IEC/EN 60947-7-2

0.08 ... 4 mm<sup>2</sup> / 28 ... 12 AWG

0.08 ... 4 mm<sup>2</sup> / 28 ... 12 AWG

8 ... 9 mm / 0.31 ... 0.35 inch

5 mm / 0.197 inch

Polyamide 66 (PA 66)

	Item No.	Page
gray	280-402	440
orange	880-346	442
white	2009-115	780
gray	280-404	460

## Through and Ex Terminal Blocks

### 4 mm<sup>2</sup>, 281 Series

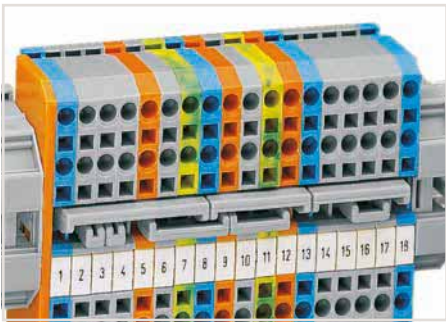

Staggered jumpers for sophisticated circuit requirements – push jumpers down until fully inserted.

Rail-mount terminal blocks with an Ex mark are suitable for Ex e II applications.  
0.5 ... 4 mm<sup>2</sup> / 24 ... 12 AWG  
550 V, 30 A  
Using staggered jumpers reduces the maximum rated voltage to 275 V.  
Terminal blocks with a blue insulated housing are suitable for Ex i applications.

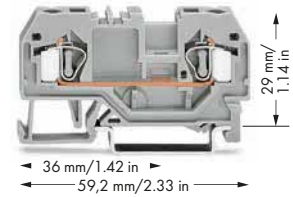

2-conductor through terminal block		
Color	Item No.	Pack. Unit
○ gray	281-901	50
● blue	281-904	50
○ light gray <sup>Ⓔ</sup>	281-992	50



#### Technical Data

Ratings per	IEC/EN 60947-7-1
Rated voltage (III / 3)	800 V
Rated surge voltage (III / 3)	8 kV
Rated current	32 A
Approval	600 V, 20 A <sup>Ⓐ</sup> ; 600 V, 25 A <sup>Ⓒ</sup>

#### Connection Data

Solid conductor	0.08 ... 4 mm <sup>2</sup> / 28 ... 12 AWG
Fine-stranded conductor	0.08 ... 4 mm <sup>2</sup> / 28 ... 12 AWG
Strip length	9 ... 10 mm / 0.35 ... 0.39 inch
Terminal block width	6 mm / 0.236 inch
Insulation material	Polyamide 66 (PA 66)

#### Accessories (Selection)

Adjacent jumper, insulated, I <sub>N</sub> = I <sub>N</sub> terminal block
End and intermediate plate, 2.5 mm thick
WMB Inline, plain, 1,500 WMB markers (5 mm) per reel, 5 ... 5.2 mm stretchable
Test plug adapter, 5 mm wide, for 210-137 Test Plug (2.3 mm Ø), for 1.5 ... 4 mm <sup>2</sup> terminal blocks

	Item No.	Page
gray	281-402	447
orange	281-329	448
white	2009-115	780
gray	280-404	460

Additional colors, visit [www.wago.com](http://www.wago.com)

Accessories (jumpers, end plates, test plugs, etc.), see page 447

Carrier rails and tools, see Section 13

Appropriate marking system, WMB/WMB Inline/WFB, see Full Line Catalog, Volume 6

Information on hazardous locations, see Section 14

Approvals and corresponding ratings, visit [www.wago.com](http://www.wago.com)

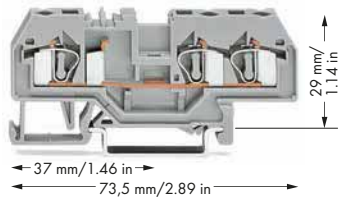

3-conductor through terminal block

Color	Item No.	Pack. Unit
○ gray	281-681	50
● blue	281-684	50
○ light gray ☹	281-993	50



IEC/EN 60947-7-1
800 V
8 kV
32 A
600 V, 20 A ; 600 V, 25 A ☹

0.08 ... 4 mm <sup>2</sup> / 28 ... 12 AWG
0.08 ... 4 mm <sup>2</sup> / 28 ... 12 AWG
9 ... 10 mm / 0.35 ... 0.39 inch
6 mm / 0.236 inch
Polyamide 66 (PA 66)

	Item No.	Page
gray	281-402	447
orange	281-326	448
white	2009-115	780
gray	280-404	460

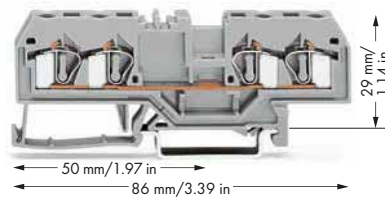

4-conductor through terminal block

Color	Item No.	Pack. Unit
○ gray	281-652	50
● blue	281-654	50
○ light gray ☹	281-994	50



IEC/EN 60947-7-1
800 V
8 kV
26 A
600 V, 20 A ; 600 V, 25 A ☹

0.08 ... 4 mm <sup>2</sup> / 28 ... 12 AWG
0.08 ... 4 mm <sup>2</sup> / 28 ... 12 AWG
9 ... 10 mm / 0.35 ... 0.39 inch
6 mm / 0.236 inch
Polyamide 66 (PA 66)

	Item No.	Page
gray	281-402	447
orange	281-335	448
white	2009-115	780
gray	280-404	460

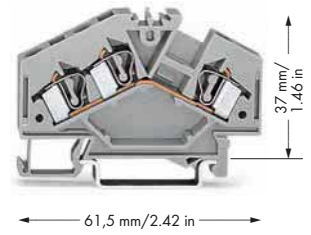

3-conductor through terminal block

Color	Item No.	Pack. Unit
○ gray	281-631	100
● blue	281-651	100
○ light gray ☹	281-998	100



IEC/EN 60947-7-1
800 V
8 kV
32 A
600 V, 20 A ; 600 V, 25 A ☹

0.08 ... 4 mm <sup>2</sup> / 28 ... 12 AWG
0.08 ... 2.5 mm <sup>2</sup> / 28 ... 12 AWG
9 ... 10 mm / 0.35 ... 0.39 inch
6 mm / 0.236 inch
Polyamide 66 (PA 66)

	Item No.	Page
gray	281-402	447
orange	281-313	448
white	2009-115	780
gray	280-404	460

## Ground/Shield Conductor and Ex Terminal Blocks

### 4 mm<sup>2</sup>, 281 Series



Rail-mount terminal blocks with an Ex mark are suitable for Ex e II applications.  
0.5 ... 4 mm<sup>2</sup> / 24 ... 12 AWG

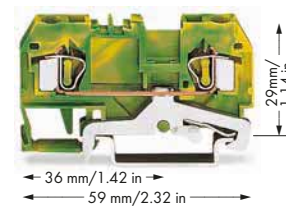

2-conductor ground terminal block

Color	Item No.	Pack. Unit
● green-yellow	281-907	50
● green-yellow Ⓢ	281-907/999-950	50

5

#### Technical Data

Ratings per

#### Connection Data

Solid conductor

Fine-stranded conductor

Strip length

Terminal block width

Insulation material

IEC/EN 60947-7-2

0.08 ... 4 mm<sup>2</sup> / 28 ... 12 AWG

0.08 ... 4 mm<sup>2</sup> / 28 ... 12 AWG

9 ... 10 mm / 0.35 ... 0.39 inch

6 mm / 0.236 inch

Polyamide 66 (PA 66)

#### Accessories (Selection)

Adjacent jumper, insulated, I<sub>N</sub> = I<sub>N</sub> terminal block

End and intermediate plate, 2.5 mm thick

WMB Inline, plain, 1,500 WMB markers (5 mm) per reel, 5 ... 5.2 mm stretchable

Test plug adapter, 5 mm wide, for 210-137 Test Plug (2.3 mm Ø), for 1.5 ... 4 mm<sup>2</sup> terminal blocks

	Item No.	Page
gray	281-402	447
orange	281-329	448
white	2009-115	780
gray	280-404	460

Accessories (jumpers, end plates, test plugs, etc.), see page 447

Carrier rails and tools, see Section 13

Appropriate marking system, WMB/WMB Inline/WFB, see Full Line Catalog, Volume 6

Information on hazardous locations, see Section 14

Approvals and corresponding ratings, visit [www.wago.com](http://www.wago.com)



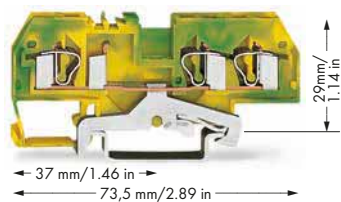

3-conductor ground terminal block		
Color	Item No.	Pack. Unit
● green-yellow	281-687	50
● green-yellow ☉	281-687/999-950	50

UL®

IEC/EN 60947-7-2

0.08 ... 4 mm<sup>2</sup> / 28 ... 12 AWG

0.08 ... 4 mm<sup>2</sup> / 28 ... 12 AWG

9 ... 10 mm / 0.35 ... 0.39 inch

6 mm / 0.236 inch

Polyamide 66 (PA 66)

	Item No.	Page
gray	281-402	447
orange	281-326	448
white	2009-115	780
gray	280-404	460

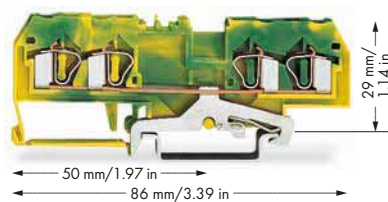

4-conductor ground terminal block		
Color	Item No.	Pack. Unit
● green-yellow	281-657	50
● green-yellow ☉	281-657/999-950	50

4-conductor shield terminal block

Color	Item No.	Pack. Unit
○ white	281-658	50

UL®

IEC/EN 60947-7-2

0.08 ... 4 mm<sup>2</sup> / 28 ... 12 AWG

0.08 ... 4 mm<sup>2</sup> / 28 ... 12 AWG

9 ... 10 mm / 0.35 ... 0.39 inch

6 mm / 0.236 inch

Polyamide 66 (PA 66)

	Item No.	Page
gray	281-402	447
orange	281-335	448
white	2009-115	780
gray	280-404	460

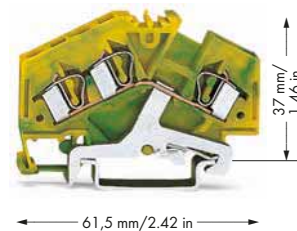

3-conductor ground terminal block		
Color	Item No.	Pack. Unit
● green-yellow	281-637	100
● green-yellow ☉	281-637/999-950	100

UL®

IEC/EN 60947-7-2

0.08 ... 4 mm<sup>2</sup> / 28 ... 12 AWG

0.08 ... 2.5 mm<sup>2</sup> / 28 ... 12 AWG

9 ... 10 mm / 0.35 ... 0.39 inch

6 mm / 0.236 inch

Polyamide 66 (PA 66)

	Item No.	Page
gray	281-402	447
orange	281-313	448
white	2009-115	780
gray	280-404	460

## Through/Ground Conductor and Ex Terminal Blocks 6 mm<sup>2</sup>, 282 Series

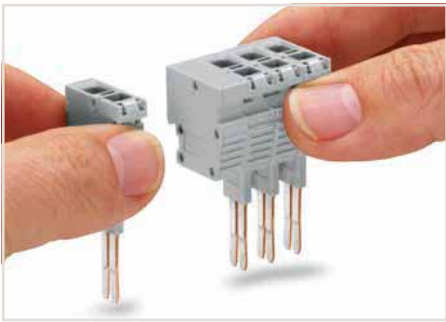

Snapping test plug and spacer modules together to assemble a multi-pole test plug module (max. 10 poles) for 8 mm terminal block width.

Rail-mount terminal blocks with an Ex mark are suitable for Ex e II applications.  
0.5 ... 6 mm<sup>2</sup> / 20 ... 10 AWG  
550 V, 39 A  
35 A jumper  
Terminal blocks with a blue insulated housing are suitable for Ex i applications.

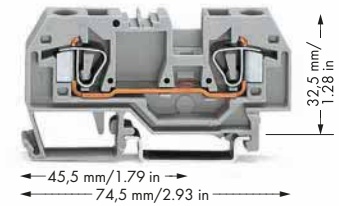

### 2-conductor through terminal block

Color	Item No.	Pack. Unit
○ gray	282-901	50
● blue	282-904	50
○ light gray	282-992	50



5



The test plug modules are directly plugged into the jumper contact slot of the current bar (picture shows 282 Series).

### Technical Data

Ratings per	IEC/EN 60947-7-1
Rated voltage (III / 3)	800 V
Rated surge voltage (III / 3)	8 kV
Rated current	41 A
Approval	600 V, 30 A ; 600 V, 40 A
<b>Connection Data</b>	
Solid conductor	0.2 ... 6 mm <sup>2</sup> / 24 ... 10 AWG
Fine-stranded conductor	0.2 ... 6 mm <sup>2</sup> / 24 ... 10 AWG
Strip length	12 ... 13 mm / 0.47 ... 0.51 inch
Terminal block width	8 mm / 0.315 inch
Insulation material	Polyamide 66 (PA 66)

### Accessories (Selection)

Adjacent jumper, insulated, I <sub>N</sub> 41 A
End and intermediate plate, 2.5 mm thick
WMB Multi marking system, white, 10 strips with 10 markers per card, 5 ... 5.2 mm stretchable
B-type test plug module with CAGE CLAMP®, snaps together
Module width 8 mm

	Item No.	Page
gray	282-402	453
orange	282-328	453
plain	793-5501	780
gray	709-310	454

Additional colors, visit [www.wago.com](http://www.wago.com)

Accessories (jumpers, end plates, test plugs, etc.), see page 453

Carrier rails and tools, see Section 13

Appropriate marking system, WMB/WMB Inline/WFB, see Full Line Catalog, Volume 6

Information on hazardous locations, see Section 14

Approvals and corresponding ratings, visit [www.wago.com](http://www.wago.com)

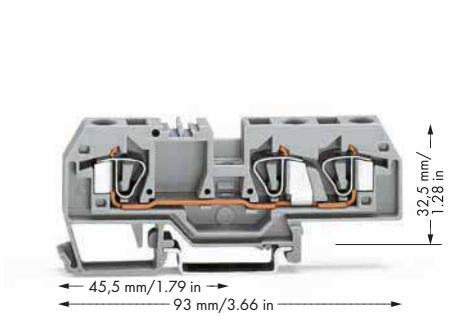

3-conductor through terminal block		
Color	Item No.	Pack. Unit
○ gray	282-681	50
● blue	282-684	50
○ light gray ☺	282-993	50



IEC/EN 60947-7-1
800 V
8 kV
41 A
600 V, 30 A <b>UL</b> ; 600 V, 40 A ☺
0.2 ... 6 mm <sup>2</sup> / 24 ... 10 AWG
0.2 ... 6 mm <sup>2</sup> / 24 ... 10 AWG
12 ... 13 mm / 0.47 ... 0.51 inch
8 mm / 0.315 inch
Polyamide 66 (PA 66)

	Item No.	Page
gray	282-402	453
orange	282-339	453
plain	793-5501	780
gray	709-310	454

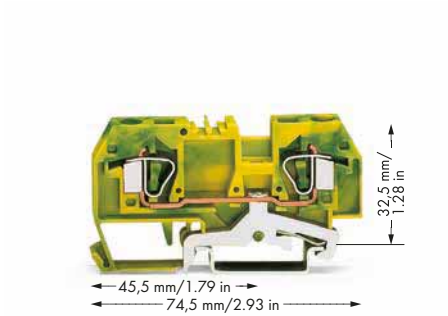

2-conductor ground terminal block		
Color	Item No.	Pack. Unit
● green-yellow	282-907	50
● green-yellow ☺	282-907/999-950	50



IEC/EN 60947-7-2
0.2 ... 10 mm <sup>2</sup> / 24 ... 8 AWG
0.2 ... 6 mm <sup>2</sup> / 24 ... 10 AWG
12 ... 13 mm / 0.47 ... 0.51 inch
8 mm / 0.315 inch
Polyamide 66 (PA 66)

	Item No.	Page
gray	282-402	453
orange	282-328	453
plain	793-5501	780
gray	709-310	454

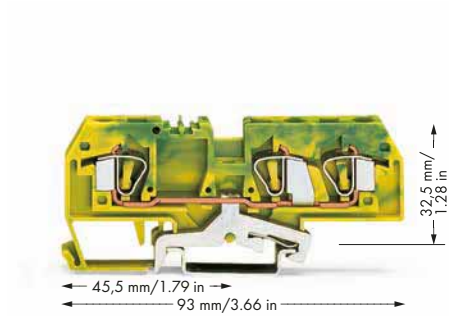

3-conductor ground terminal block		
Color	Item No.	Pack. Unit
● green-yellow	282-687	50
● green-yellow ☺	282-687/999-950	50



IEC/EN 60947-7-2
0.2 ... 6 mm <sup>2</sup> / 24 ... 10 AWG
0.2 ... 6 mm <sup>2</sup> / 24 ... 10 AWG
12 ... 13 mm / 0.47 ... 0.51 inch
8 mm / 0.315 inch
Polyamide 66 (PA 66)

	Item No.	Page
gray	282-402	453
orange	282-339	453
plain	793-5501	780
gray	709-310	454

## Through/Ground Conductor and Ex Terminal Blocks 10 mm<sup>2</sup>, 284 Series

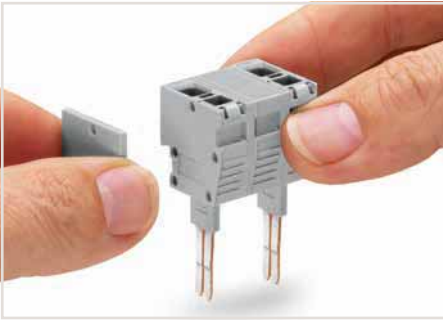

Snapping test plug and spacer modules (each with a spacer plate) together to assemble a multi-pole test plug module (max. 10 poles) for 10 mm terminal block width.

Rail-mount terminal blocks with an Ex mark are suitable for Ex e II applications.  
0.5 ... 10 mm<sup>2</sup> / 20 ... 8 AWG  
550 V, 53 A

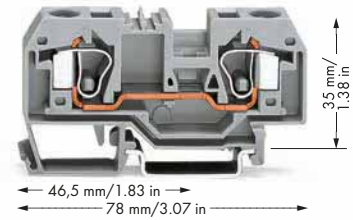

### 2-conductor through terminal block

Color	Item No.	Pack. Unit
○ gray	284-901	25
● blue	284-904	25
○ light gray	284-992	25



### Technical Data

Ratings per	IEC/EN 60947-7-1
Rated voltage (III / 3)	800 V
Rated surge voltage (III / 3)	8 kV
Rated current	57 A
Approval	600 V, 50 A ; 600 V, 54 A
<b>Connection Data</b>	
Solid conductor	0.2 ... 10 mm <sup>2</sup> / 24 ... 8 AWG
Fine-stranded conductor	0.2 ... 10 mm <sup>2</sup> / 24 ... 8 AWG
Strip length	12 ... 13 mm / 0.47 ... 0.51 inch
Terminal block width	10 mm / 0.394 inch
Insulation material	Polyamide 66 (PA 66)

### Accessories (Selection)

Adjacent jumper, insulated, I <sub>N</sub> 57 A	
End and intermediate plate, 2.5 mm thick	
WMB Multi marking system, white, 10 strips with 10 markers per card, 5 ... 5.2 mm stretchable	
B-type test plug module with CAGE CLAMP®, snaps together	
Module width 8 mm	
B-type spacer plate, snaps together, snaps on B-type test plug modules (709-310) and B-type spacer modules (709-311)	
Module width 2 mm	

	Item No.	Page
gray	284-402	455
orange	284-328	455
plain	793-5501	780
gray	709-310	456
gray	709-312	456



The test plug modules are directly plugged into the jumper contact slot of the current bar (picture shows 284 Series).

5

Additional colors, visit [www.wago.com](http://www.wago.com)

Accessories (jumpers, end plates, test plugs, etc.), see page 455

Carrier rails and tools, see Section 13

Appropriate marking system, WMB/WMB Inline/WFB, see Full Line Catalog, Volume 6

Information on hazardous locations, see Section 14

Approvals and corresponding ratings, visit [www.wago.com](http://www.wago.com)

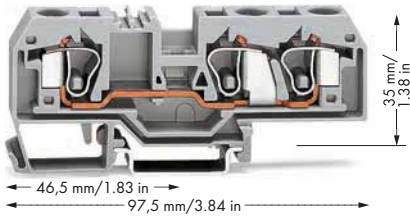

3-conductor through terminal block		
Color	Item No.	Pack. Unit
○ gray	284-681	25
● blue	284-684	25
○ light gray ☺	284-993	25



IEC/EN 60947-7-1
800 V
8 kV
57 A
600 V, 50 A ; 600 V, 54 A

0.2 ... 10 mm <sup>2</sup> / 24 ... 8 AWG
0.2 ... 10 mm <sup>2</sup> / 24 ... 8 AWG
12 ... 13 mm / 0.47 ... 0.51 inch
10 mm / 0.394 inch
Polyamide 66 (PA 66)

	Item No.	Page
gray	284-402	455
orange	284-339	455
plain	793-5501	780
gray	709-310	456
gray	709-312	456

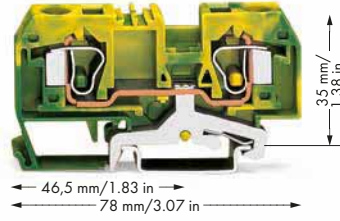

2-conductor ground terminal block		
Color	Item No.	Pack. Unit
● green-yellow	284-907	25
● green-yellow ☺	284-907/999-950	25



IEC/EN 60947-7-2

0.2 ... 10 mm <sup>2</sup> / 24 ... 8 AWG
0.2 ... 10 mm <sup>2</sup> / 24 ... 8 AWG
12 ... 13 mm / 0.47 ... 0.51 inch
10 mm / 0.394 inch
Polyamide 66 (PA 66)

	Item No.	Page
gray	284-402	455
orange	284-328	455
plain	793-5501	780
gray	709-310	456
gray	709-312	456

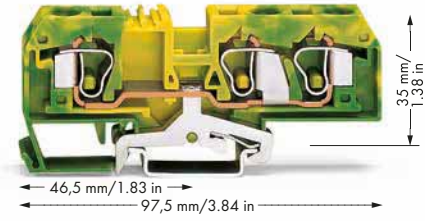

3-conductor ground terminal block		
Color	Item No.	Pack. Unit
● green-yellow	284-687	25
● green-yellow ☺	284-687/999-950	25



IEC/EN 60947-7-2

0.2 ... 10 mm <sup>2</sup> / 24 ... 8 AWG
0.2 ... 10 mm <sup>2</sup> / 24 ... 8 AWG
12 ... 13 mm / 0.47 ... 0.51 inch
10 mm / 0.394 inch
Polyamide 66 (PA 66)

	Item No.	Page
gray	284-402	455
orange	284-339	455
plain	793-5501	780
gray	709-310	456
gray	709-312	456

## Through/Ground Conductor and Ex Terminal Blocks 16 mm<sup>2</sup>, 283 Series



1-conductor supply terminal block (283-609) with an end plate (283-320)

Rail-mount terminal blocks with an Ex mark are suitable for Ex e II applications.  
0.5 ... 16 mm<sup>2</sup> / 20 ... 6 AWG  
550 V, 63 A  
63 A jumper

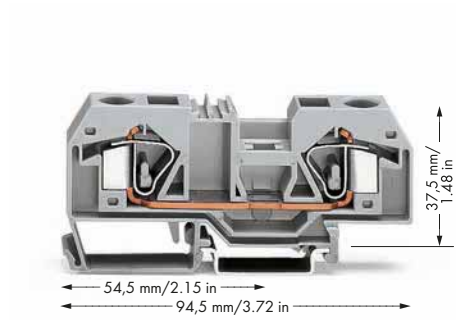

2-conductor through terminal block

Color	Item No.	Pack. Unit
○ gray	283-901	20
● blue	283-904	20
○ light gray <sup>Ⓢ</sup>	283-992	20

**WAGO**

### Technical Data

Ratings per	IEC/EN 60947-7-1
Rated voltage (III / 3)	800 V
Rated surge voltage (III / 3)	8 kV
Rated current	76 A
Approval	600 V, 65 A <b>W</b> , 600 V, 70 A <b>Ⓢ</b>

### Connection Data

Solid conductor	0.2 ... 16 mm <sup>2</sup> / 24 ... 6 AWG
Fine-stranded conductor	0.2 ... 16 mm <sup>2</sup> / 24 ... 6 AWG
Strip length	16 ... 17 mm / 0.63 ... 0.67 inch
Terminal block width	12 mm / 0.472 inch
Insulation material	Polyamide 66 (PA 66)

### Note:

### Accessories (Selection)

Adjacent jumper, insulated, I <sub>n</sub> 70 A
End and intermediate plate, 2.5 mm thick
WMB Multi marking system, white, 10 strips with 10 markers per card, 5 ... 5.2 mm stretchable
Test plug adapter, 11.6 mm wide, for 4 mm Ø test plug, for 1.5 ... 16 mm <sup>2</sup> terminal blocks
Power tap, with 500 mm cable, for 16 mm <sup>2</sup> /6 AWG (283/783 Series) and 35 mm <sup>2</sup> /2 AWG (285/785 Series) rail-mount terminal blocks

	Item No.	Page
gray	283-402	457
orange	283-328	457
plain	793-5501	780
gray	283-404	458
gray	283-407	458

Additional colors, visit [www.wago.com](http://www.wago.com)

Accessories (jumpers, end plates, test plugs, etc.), see page 457

Carrier rails and tools, see Section 13

Appropriate marking system, WMB/WMB Inline/WFB, see Full Line Catalog, Volume 6

Information on hazardous locations, see Section 14

Approvals and corresponding ratings, visit [www.wago.com](http://www.wago.com)



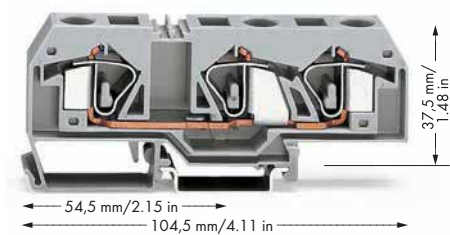

3-conductor through terminal block		
Color	Item No.	Pack. Unit
○ gray	283-671	20
● blue	283-674	20
○ light gray ☺	283-998	20



IEC/EN 60947-7-1
800 V
8 kV
76 A
600 V, 65 A ; 600 V, 70 A

0.2 ... 16 mm <sup>2</sup> / 24 ... 6 AWG
0.2 ... 16 mm <sup>2</sup> / 24 ... 6 AWG
16 ... 17 mm / 0.63 ... 0.67 inch
12 mm / 0.472 inch
Polyamide 66 (PA 66)
Notice: This terminal block cannot be commoned with adjacent jumpers.

	Item No.	Page
orange	283-352	457
plain	793-5501	780

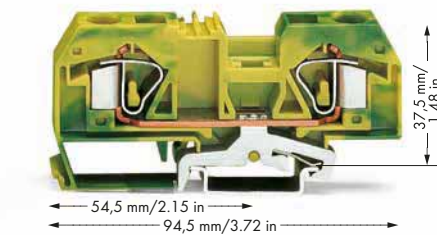

2-conductor ground terminal block		
Color	Item No.	Pack. Unit
● green-yellow	283-907	20
● green-yellow ☺	283-907/999-950	20



IEC/EN 60947-7-2
------------------

0.2 ... 16 mm <sup>2</sup> / 24 ... 6 AWG
0.2 ... 16 mm <sup>2</sup> / 24 ... 6 AWG
16 ... 17 mm / 0.63 ... 0.67 inch
12 mm / 0.472 inch
Polyamide 66 (PA 66)

	Item No.	Page
gray	283-402	457
orange	283-328	457
plain	793-5501	780
gray	283-404	458
gray	283-407	458

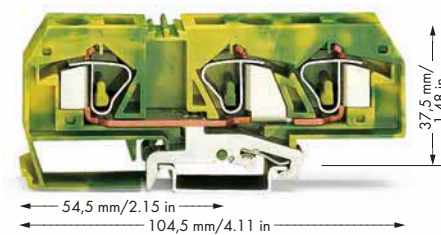

3-conductor ground terminal block		
Color	Item No.	Pack. Unit
● green-yellow	283-677	20
● green-yellow ☺	283-677/999-950	20



IEC/EN 60947-7-2
------------------

0.2 ... 16 mm <sup>2</sup> / 24 ... 6 AWG
0.2 ... 16 mm <sup>2</sup> / 24 ... 6 AWG
16 ... 17 mm / 0.63 ... 0.67 inch
12 mm / 0.472 inch
Polyamide 66 (PA 66)
Notice: This terminal block cannot be commoned with adjacent jumpers.

	Item No.	Page
orange	283-352	457
plain	793-5501	780

## Through/Ground Conductor and Ex Terminal Blocks

### 35 mm<sup>2</sup>, 285 Series

Terminating a 35 mm<sup>2</sup> (2 AWG) conductor.

Rail-mount terminal blocks with an Ex mark are suitable for Ex e II applications.  
6 ... 35 mm<sup>2</sup> / 8 ... 2 AWG  
880 V, 85 A  
6 ... 25 mm<sup>2</sup> / 8 ... 4 AWG  
for ground conductor terminal blocks

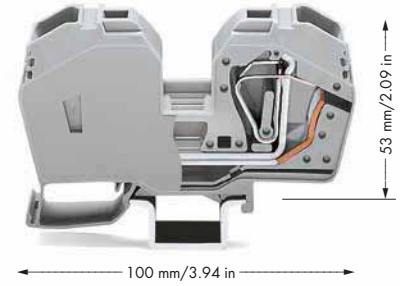

2-conductor through terminal block, with integrated end plate

Color	Item No.	Pack. Unit
○ gray	285-635	15
● blue	285-634	15
○ light gray ☺	285-992	15

2-conductor ground terminal block, with integrated end plate

Color	Item No.	Pack. Unit
● green-yellow	285-637	15
● green-yellow ☺	285-637/999-950	15

UL®

IEC/EN 60947-7-1

1000 V

8 kV

125 A

600 V, 115 A ; 600 V, 120 A ☺

6 ... 35 mm<sup>2</sup> / 8 ... 2 AWG

6 ... 35 mm<sup>2</sup> / 8 ... 2 AWG

23 mm / 0.91 inch

16 mm / 0.63 inch

16 mm / 0.63 inch

Polyamide 66 (PA 66)

only on DIN 35 x 15 rail

	Item No.	Page
gray	285-435	459
gray	283-414	459
yellow	285-416	459
yellow	285-401	459
plain	793-5501	780
plain	248-501	781
gray	283-407	459



Protective warning markers inserted into the operating slots.



Finger guard seals an unused conductor entry.

#### Technical Data

Ratings per

Rated voltage (III / 3)

Rated surge voltage (III / 3)

Rated current

Approval

#### Connection Data

Solid conductor

Fine-stranded conductor

Strip length

Strip length (2)

Terminal block width

Insulation material

**Note:**

#### Accessories (Selection)

Adjacent jumper, insulated, I<sub>n</sub> 85 A

Step-down jumper, insulated, 16 mm<sup>2</sup>/6 AWG to 4 mm<sup>2</sup>/12 AWG, I<sub>n</sub> 32 A

Protective warning marker, with black high-voltage symbol, for 5 terminal blocks

Finger guard, touch-proof cover protects unused conductor entries

WMB Multi marking system, white, 10 strips with 10 markers per card, 5 ... 5.2 mm stretchable

Mini-WSB Quick marking system, white, 10 strips with 10 markers per card, 5 mm wide markers

Power tap, with 500 mm cable, for 16 mm<sup>2</sup>/6 AWG (283/783 Series) and 35 mm<sup>2</sup>/2 AWG (285/785 Series) rail-mount terminal blocks

Accessories (jumpers, etc.), see page 459

Commoning with step-down jumpers, see page 312

Carrier rails and tools, see Section 13

Appropriate marking system, WMB/Mini-WSB/WFB, see Full Line Catalog, Volume 6

Information on hazardous locations, see Section 14

Approvals and corresponding ratings, visit [www.wago.com](http://www.wago.com)

## Distribution Terminal Blocks, 3 x 10 mm<sup>2</sup> CAGE CLAMP® Connection and 1 x 35 mm<sup>2</sup> Screw Clamp Connection 284 Series

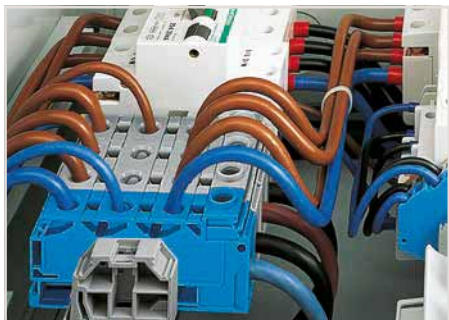

Side-entry distribution terminal block with screw clamp connection (35 mm<sup>2</sup>/2 AWG) and front-entry CAGE CLAMP® connection (3 x 10 mm<sup>2</sup>/8 AWG) snaps onto DIN-35 rails per EN 60715. This terminal block is enclosed on both sides and requires no end or intermediate plate.

When connecting 3 x 10 mm<sup>2</sup> (8 AWG) conductors on the distribution side, make sure that the nominal current of 125 A is not exceeded.



Terminating a 35 mm<sup>2</sup> (2 AWG) conductor – screw clamp connection, side-entry wiring.



Terminating a 10 mm<sup>2</sup> (8 AWG) conductor – CAGE CLAMP® connection, front-entry wiring.



Commoning with comb-style jumper bar.

I<sub>N</sub> 125 A for one jumper,  
I<sub>N</sub> 100 A for two jumpers  
Individual arrangement: 125 A  
Two jumpers combined in one clamping  
unit: 100 A

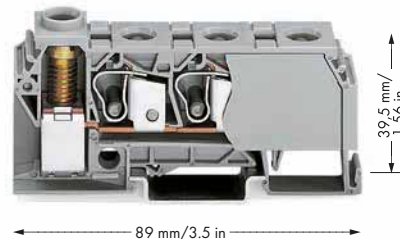

Distribution terminal block, 3 x CAGE CLAMP® connection (10 mm<sup>2</sup>/8 AWG), 1 x screw clamp connection (35 mm<sup>2</sup>/2 AWG) and 3.5 Nm screw torque

Color	Item No.	Pack. Unit
○ gray	284-621	15
● blue	284-624	15

### Technical Data

Ratings per	IEC/EN 60947-7-1
Rated voltage (III / 3)	800 V
Rated surge voltage (III / 3)	8 kV
Rated current	125 A
<b>Connection Data</b>	
Connection technology	CAGE CLAMP®
Solid conductor	0.2 ... 10 mm <sup>2</sup> / 24 ... 8 AWG
Fine-stranded conductor	0.2 ... 10 mm <sup>2</sup> / 24 ... 8 AWG
<b>Connection Data (2)</b>	
Connection technology (2)	Screw clamp connection
Solid conductor (2)	6 ... 35 mm <sup>2</sup> / 10 ... 2 AWG
Fine-stranded conductor (2)	6 ... 35 mm <sup>2</sup> / 10 ... 2 AWG
Strip length	12 ... 14 mm / 0.47 ... 0.55 inch
Terminal block width	17.5 mm / 0.689 inch
Insulation material	Polyamide 66 (PA 66)

### Accessories (Selection)

	Item No.	Page
Comb-style jumper bar, insulated, I <sub>N</sub> 125 A	gray 284-412	455
WMB Multi marking system, white, 10 strips with 10 markers per card, 5 ... 5.2 mm stretchable	plain 793-5501	780

## Step-Down Jumpers for Front-Entry Through Terminal Blocks up to 16 mm<sup>2</sup> Installation

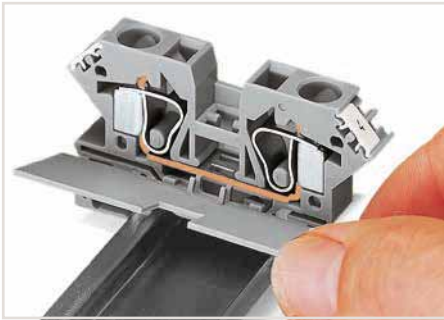

Snapping cover plate onto open side of terminal block.

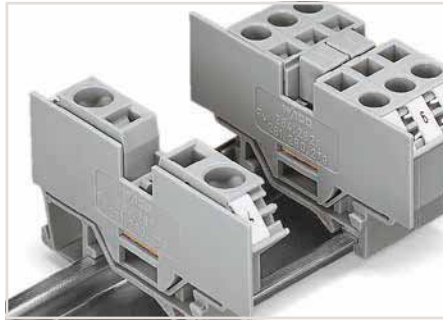

A cover plate must also be snapped onto the other side of the larger terminal block.



Commoning terminal blocks of different sizes – step down. Push down the step-down jumper until fully inserted.

Step-down jumpers common terminal blocks of different sizes, without losing a conductor clamping point. This can be beneficial on long conductor runs where voltage drop can be a problem. A large conductor can be easily connected to smaller conductors at the distribution point.

Step-down jumpers are simply pushed down for full insertion, similar to adjacent jumpers. Commoning may be made in either direction using the special thin end plate to cover the open side. Additional through terminal blocks having a smaller cross-section may be commoned using adjacent jumpers.



Note: Jumpers are marked with suitable terminal block sizes for correct installation.

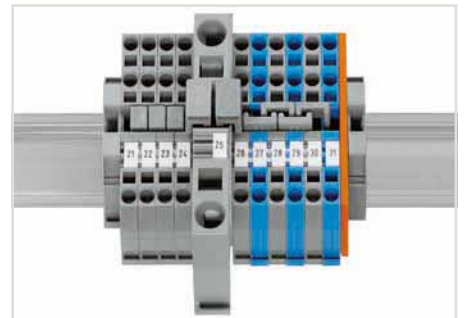

In this case, pay attention that:

- The total current of the outgoing circuits does not exceed the nominal current of the step-down jumper.
- The standard or special thin cover plate is installed on the open side of the larger block.

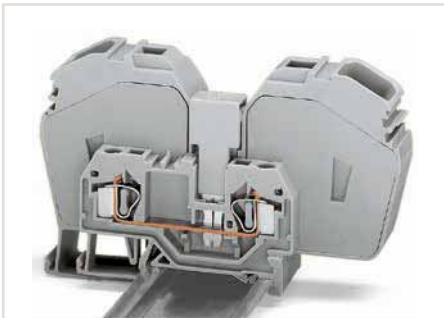

Commoning with step-down jumper (283-414) from 285 Series (35 mm<sup>2</sup>/2 AWG) to 281 Series terminal blocks (4 mm<sup>2</sup>/12 AWG).

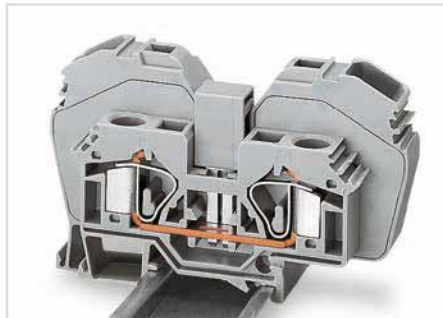

The following 285 Series Through Terminal Blocks can be commoned with 283 Series Through Terminal Blocks:  
285-635 or 285-634 with 283-601 or 283-604 (terminal blocks with side marking, visit [www.wagocatalog.com](http://www.wagocatalog.com))  
Adjacent jumper required: 285-435

Please note that the nominal current of the adjacent jumper shall not exceed 63 A.



Step-down jumper from 10/6 mm<sup>2</sup> (8/10 AWG) to 4/2.5/1.5 mm<sup>2</sup> (12/14/16 AWG); I<sub>N</sub> 15 A, Item No. 284-414



Step-down jumper from 10/6 mm<sup>2</sup> (8/10 AWG) to 6/4 mm<sup>2</sup> (10/12 AWG); I<sub>N</sub> 30 A, Item No. 284-413



Step-down jumper from 16 mm<sup>2</sup> (6 AWG) to 4 mm<sup>2</sup> (12 AWG); I<sub>N</sub> 32 A, Item No. 283-414

5



## Assembly Examples

### Step-Down Jumpers for Front-Entry Through Terminal Blocks

Terminal blocks with side marking, visit [www.wagocatalog.com](http://www.wagocatalog.com)



Commoning from 6 mm<sup>2</sup>/10 AWG (282 Series) to 1.5 mm<sup>2</sup>/16 AWG (279 Series) front-entry rail-mount terminal blocks.



Commoning from 10 mm<sup>2</sup>/8 AWG (284 Series) to 6 mm<sup>2</sup>/10 AWG (282 Series) rail-mount terminal blocks via step-down jumpers.

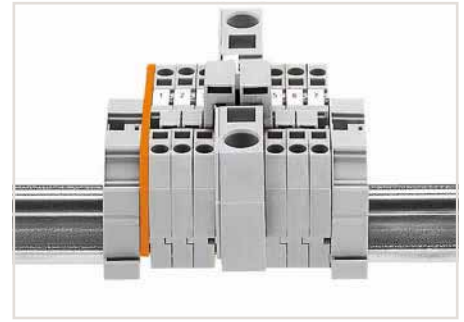

Commoning from 16 mm<sup>2</sup>/6 AWG (283 Series) to 4 mm<sup>2</sup>/12 AWG (281 Series) rail-mount terminal blocks via step-down jumpers.

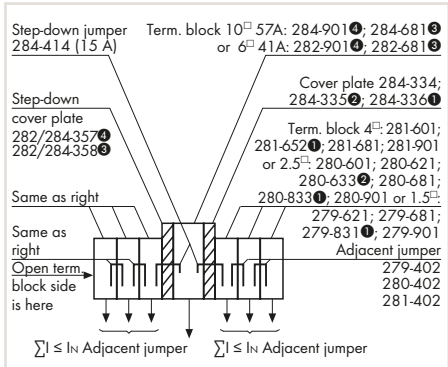

Assembly example: Commoning from 10/6 mm<sup>2</sup> (8/10 AWG) to 4/2.5/1.5 mm<sup>2</sup> (12/14/16 AWG) rail-mount terminal blocks via step-down jumper (284-414).

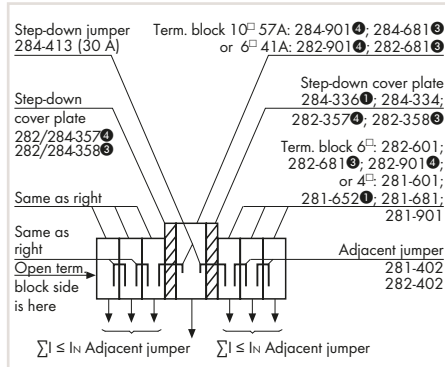

Assembly example: Commoning from 10/6 mm<sup>2</sup> (8/10 AWG) to 6 mm<sup>2</sup> (10 AWG) rail-mount terminal blocks via step-down jumper (284-413).

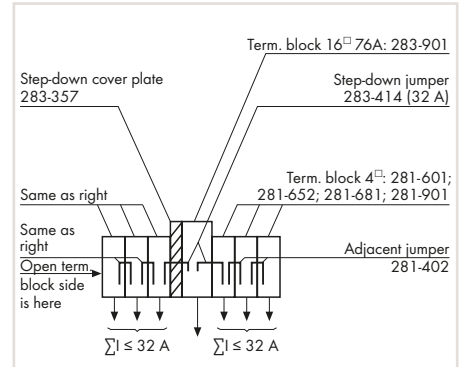

Assembly example: Commoning from 16 mm<sup>2</sup>/6 AWG to 4 mm<sup>2</sup>/12 AWG rail-mount terminal blocks via step-down jumper (283-414).

5



Commoning from 6 mm<sup>2</sup>/10 AWG (282 Series) to 1.5 mm<sup>2</sup>/16 AWG (279 Series) front-entry rail-mount terminal blocks.



Commoning from 10 mm<sup>2</sup>/8 AWG (284 Series) to 6 mm<sup>2</sup>/10 AWG (282 Series) rail-mount terminal blocks via step-down jumpers.

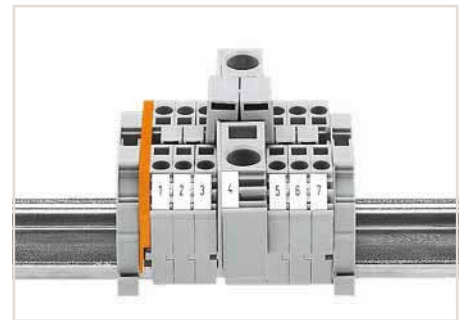

Commoning from 16 mm<sup>2</sup>/6 AWG (283 Series) to 4 mm<sup>2</sup>/12 AWG (281 Series) rail-mount terminal blocks via step-down jumpers.

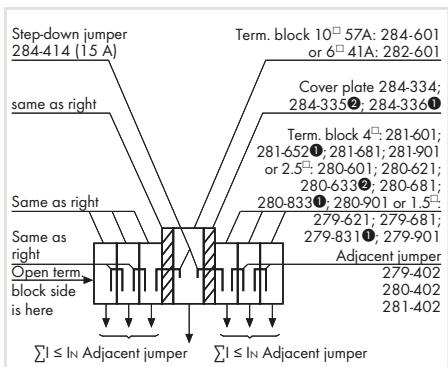

Assembly example: Commoning from 10/6 mm<sup>2</sup> (8/10 AWG) to 4/2.5/1.5 mm<sup>2</sup> (12/14/16 AWG) rail-mount terminal blocks via step-down jumper (284-414).

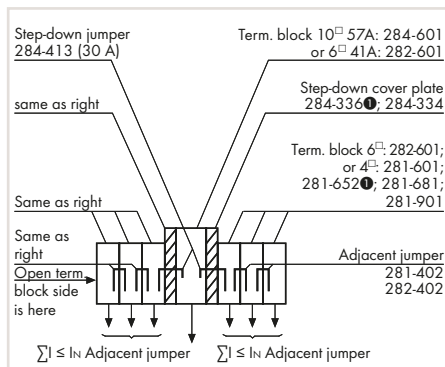

Assembly example: Commoning from 10/6 mm<sup>2</sup> (8/10 AWG) to 6 mm<sup>2</sup> (10 AWG) rail-mount terminal blocks via step-down jumper (284-413).

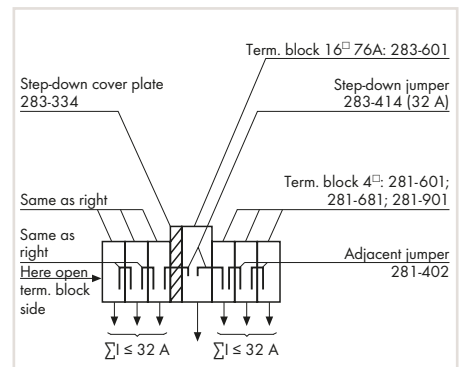

Assembly example: Commoning from 16 mm<sup>2</sup>/6 AWG to 4 mm<sup>2</sup>/12 AWG rail-mount terminal blocks via step-down jumper (283-414).

## Double-Deck Terminal Blocks

### 1.5 mm<sup>2</sup>, 279 Series

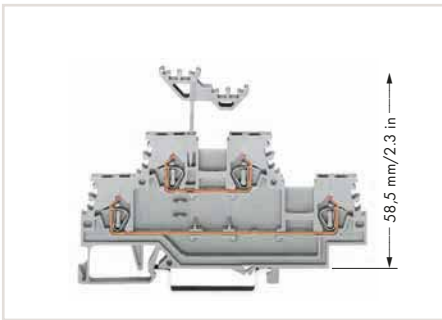

Double-deck marker carrier  
(height including marker carrier)

Terminal blocks with a blue insulated housing are suitable for Ex i applications.

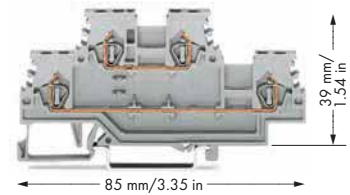

Double-deck terminal block, through/through terminal block

	Item No.	Pack. Unit
○ L/L	279-501	50
○ N/L	279-512	50
○ L/N	279-513	50
● N/N	279-504	50



#### Technical Data

Ratings per	IEC/EN 60947-7-1
Rated voltage (III / 3)	500 V
Rated surge voltage (III / 3)	6 kV
Rated current	18 A
Approval	300 V, 10 A

#### Connection Data

Solid conductor	0.08 ... 1.5 mm <sup>2</sup> / 28 ... 16 AWG
Fine-stranded conductor	0.08 ... 1.5 mm <sup>2</sup> / 28 ... 16 AWG
Strip length	8 ... 9 mm / 0.31 ... 0.35 inch
Terminal block width	4 mm / 0.157 inch
Insulation material	Polyamide 66 (PA 66)

#### Accessories (Selection)

Adjacent jumper, insulated, I <sub>n</sub> 15 A	
End and intermediate plate, 2 mm thick	
WMB Inline, plain, 2,000 WMB markers (4 mm) per reel, 4 ... 4.2 mm stretchable	
Double-deck marker carrier	

	IEC/EN 60947-7-1
	500 V
	6 kV
	18 A
	300 V, 10 A
	0.08 ... 1.5 mm <sup>2</sup> / 28 ... 16 AWG
	0.08 ... 1.5 mm <sup>2</sup> / 28 ... 16 AWG
	8 ... 9 mm / 0.31 ... 0.35 inch
	4 mm / 0.157 inch
	Polyamide 66 (PA 66)

	Item No.	Page
gray	279-402	438
orange	279-519	439
white	2009-114	780
gray	279-529	Volume 6

Accessories (jumpers, end plates, etc.), see page 438

Carrier rails and tools, see Section 13

Appropriate marking system, WMB/WMB Inline, see Full Line Catalog, Volume 6

Approvals and corresponding ratings, visit [www.wago.com](http://www.wago.com)



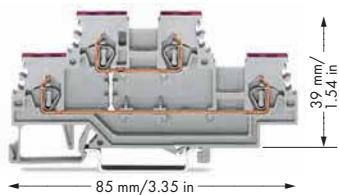

Double-deck terminal block, 4-conductor through terminal block, internally commoned, violet conductor entry

	Item No.	Pack. Unit
○ L	279-508	50
● N	279-509	50

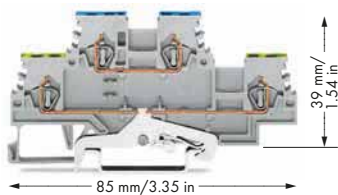

Double-deck terminal block, ground conductor/through terminal block

	Item No.	Pack. Unit
○ PE/N	279-517	50
● PE/L	279-527	50

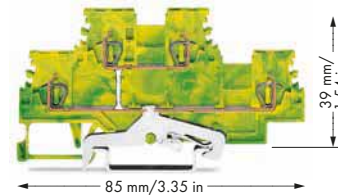

Double-deck terminal block, 4-conductor ground terminal block, internally commoned

	Item No.	Pack. Unit
● PE	279-507	50



IEC/EN 60947-7-1  
500 V  
6 kV  
18 A  
300 V, 10 A

0.08 ... 1.5 mm<sup>2</sup> / 28 ... 16 AWG  
0.08 ... 1.5 mm<sup>2</sup> / 28 ... 16 AWG  
8 ... 9 mm / 0.31 ... 0.35 inch  
4 mm / 0.157 inch  
Polyamide 66 (PA 66)

	Item No.	Page
gray	279-402	438
orange	279-519	439
white	2009-114	780
gray	279-529	Volume 6



IEC/EN 60947-7-1  
500 V  
6 kV  
18 A  
300 V, 10 A

0.08 ... 1.5 mm<sup>2</sup> / 28 ... 16 AWG  
0.08 ... 1.5 mm<sup>2</sup> / 28 ... 16 AWG  
8 ... 9 mm / 0.31 ... 0.35 inch  
4 mm / 0.157 inch  
Polyamide 66 (PA 66)

	Item No.	Page
gray	279-402	438
orange	279-519	439
white	2009-114	780
gray	279-529	Volume 6



IEC/EN 60947-7-2

0.08 ... 1.5 mm<sup>2</sup> / 28 ... 16 AWG  
0.08 ... 1.5 mm<sup>2</sup> / 28 ... 16 AWG  
8 ... 9 mm / 0.31 ... 0.35 inch  
4 mm / 0.157 inch  
Polyamide 66 (PA 66)

	Item No.	Page
gray	279-402	438
orange	279-519	439
white	2009-114	780
gray	279-529	Volume 6

## Double- and Triple-Deck Terminal Blocks, 280 and 281 Series Description and Installation

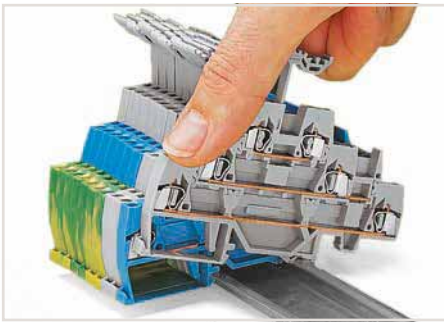

Snapping a terminal block onto the carrier rail.

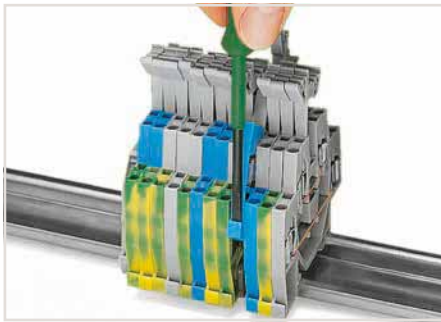

Removing a terminal block from the assembly.

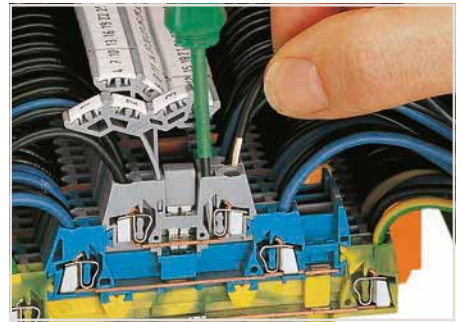

CAGE CLAMP® connection  
Inserting a conductor via screwdriver.

5



Commoning using an adjacent jumper (280-402).  
Push jumper down until fully inserted.

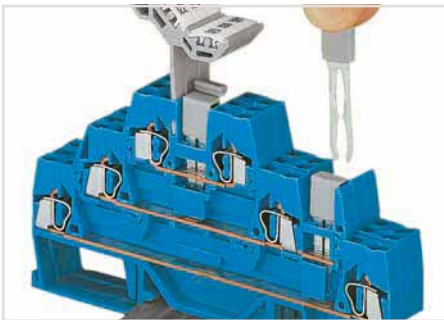

Combining vertical and adjacent jumpers.

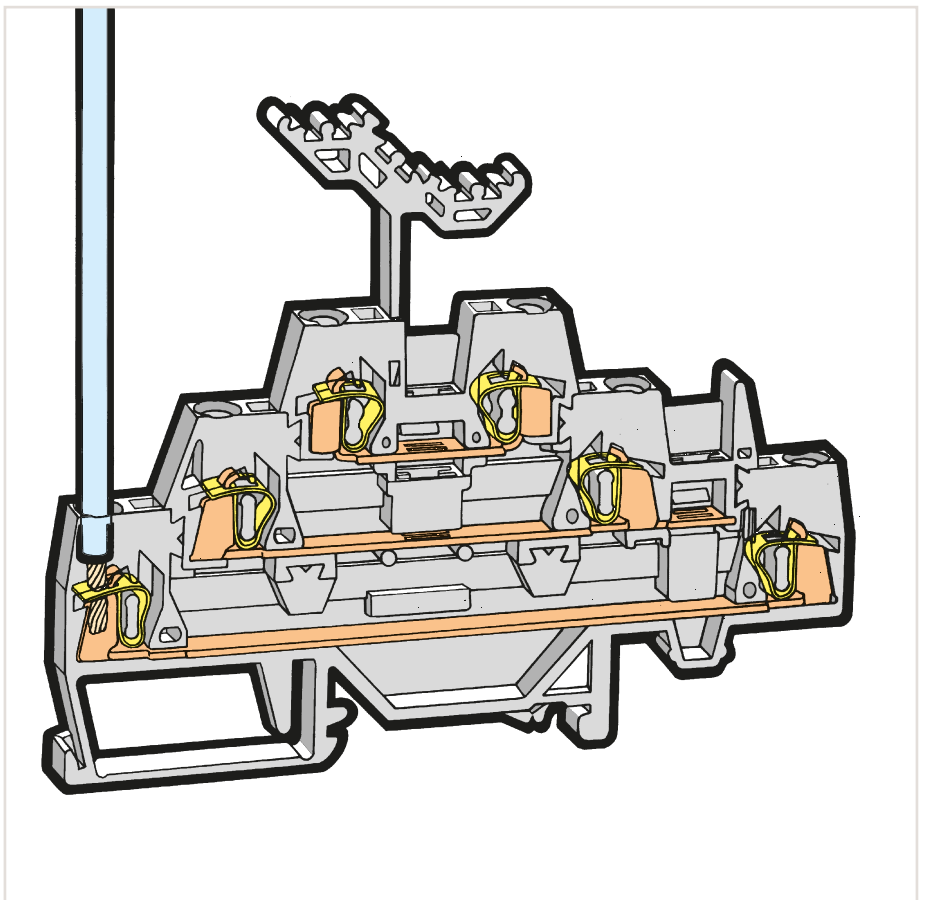

Labeling via WMB Multi Marking System.

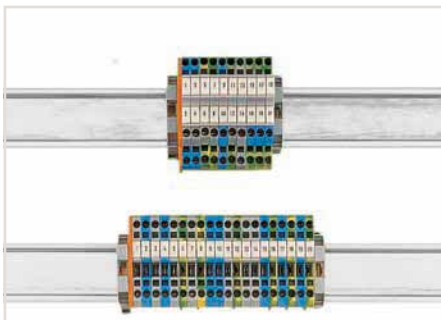

Save 50 % of rail space via double-deck terminal blocks.

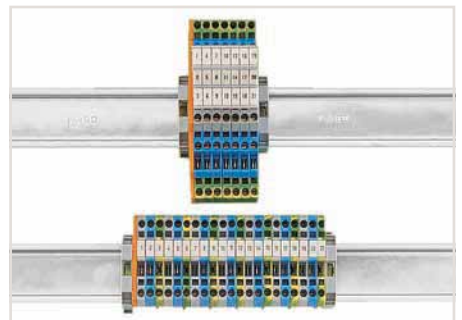

Save 67 % of rail space via triple-deck terminal blocks.

## Installation

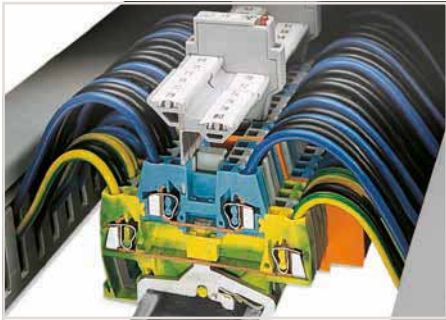

Example of a mixed assembly with double-deck terminal blocks. The 280 Series Double-Deck Terminal Blocks are available with decks of same or different color according to their function. This is an additional visual aid during wiring, service or maintenance.

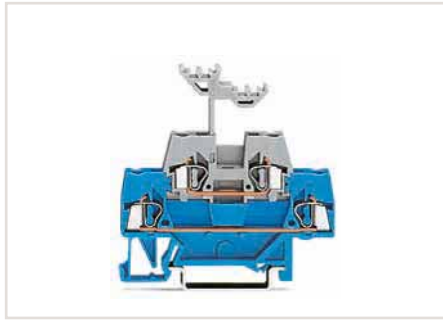

Double-deck terminal blocks accommodate two circuits of different potentials on two decks; different circuits can be differentiated by color coding either deck (280 Series). The lower deck is wider than the upper for ease of wiring.

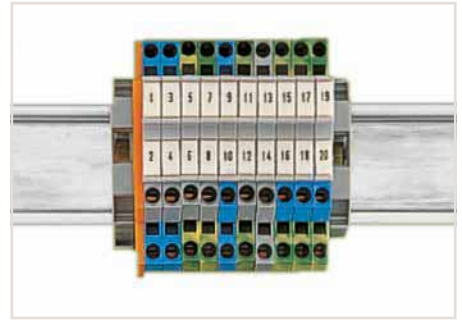

With a terminal block width of just 5 mm, an effective width of just 2.5 mm for terminal blocks of same or different potentials can be realized for conductors ranging 0.08 mm<sup>2</sup> ... 2.5 mm<sup>2</sup> (28 ... 14 AWG).

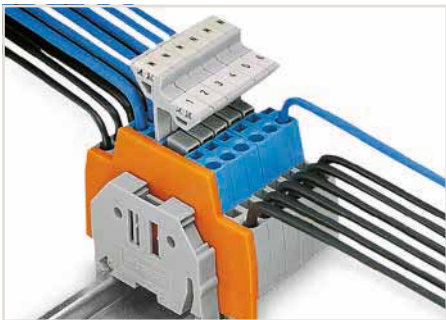

Double-deck terminal blocks used as control conductor terminal blocks (e.g., for magnetic valves) with the upper deck commoned.

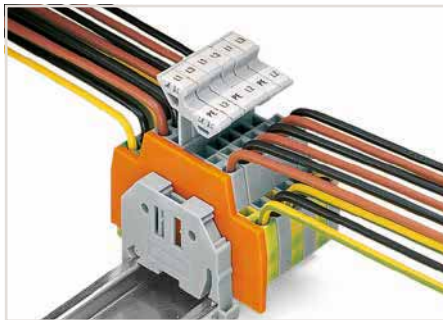

Double-deck terminal blocks used for connecting a three-phase motor.

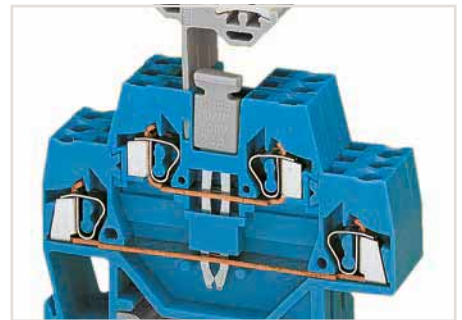

Commoning with a vertical jumper (281-421). Push vertical jumper down until fully inserted.

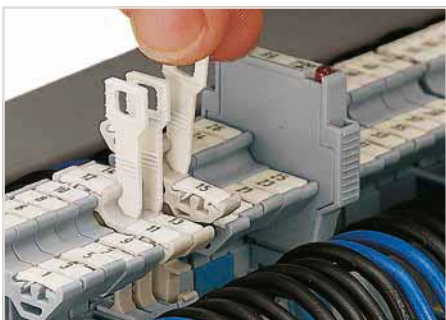

Pulling the disconnect tab.

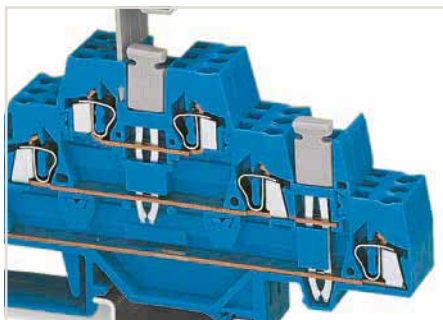

A vertical jumper allows commoning of the upper and lower levels, providing a 6-conductor feed-through terminal block in one housing. Two adjacent triple-deck terminal blocks may be commoned together on the same level using a push-in adjacent jumper.

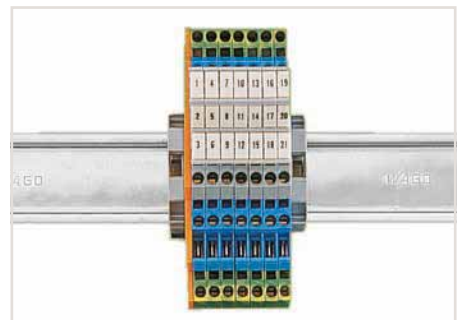

Double-deck (triple-deck) terminal blocks accommodate two (three) circuits of different potentials on two (three) decks; different circuits can be differentiated by color coding either deck (280 Series). The lower deck is wider than the upper, for ease of wiring.

5

## Double-Deck Terminal Blocks

### 2.5 mm<sup>2</sup>, 280 Series

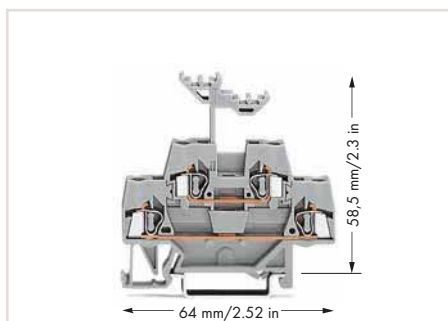

Double-deck terminal block, through/through terminal block (280-519, gray and 280-529, blue)

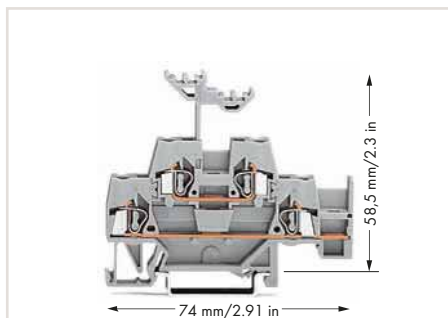

Double-deck terminal block, through/through terminal block (280-520, gray and 280-530, blue)

Terminal blocks with a blue insulated housing are suitable for Ex i applications.

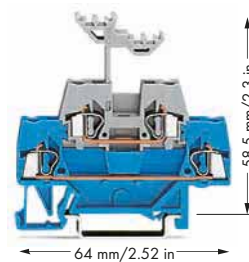

Double-deck terminal block, through/through terminal block

Color	Item No.	Pack. Unit
blue/gray	280-523	50
gray/blue	280-533	50
○ gray	280-519	50
● blue	280-529	50



#### Technical Data

Ratings per	IEC/EN 60947-7-1
Rated voltage (III / 3)	500 V
Rated surge voltage (III / 3)	6 kV
Rated current	20 A
Approval	300 V, 15 A ; 300 V, 20 A

#### Connection Data

Solid conductor	0.08 ... 2.5 mm <sup>2</sup> / 28 ... 12 AWG
Fine-stranded conductor	0.08 ... 2.5 mm <sup>2</sup> / 28 ... 12 AWG
Note (conductor cross section)	12 AWG: THHN, THWN
Strip length	8 ... 9 mm / 0.31 ... 0.35 inch
Terminal block width	5 mm / 0.197 inch
Insulation material	Polyamide 66 (PA 66)

#### Accessories (Selection)

Adjacent jumper, insulated, I <sub>N</sub> = I <sub>N</sub> terminal block	
End and intermediate plate, 2.5 mm thick	
WMB Inline, plain, 1,500 WMB markers (5 mm) per reel, 5 ... 5.2 mm stretchable	

	Item No.	Page
gray	280-402	440
orange	280-341	443
white	2009-115	780

5

Accessories (jumpers, end plates, etc.), see page 440

Carrier rails and tools, see Section 13

Appropriate marking system, WMB/WMB Inline, see Full Line Catalog, Volume 6

Approvals and corresponding ratings, visit [www.wago.com](http://www.wago.com)



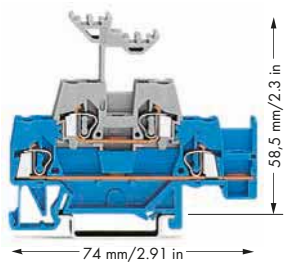

Double-deck terminal block, through/through terminal block, with horizontal jumpering on lower level

Color	Item No.	Pack. Unit
blue/gray	280-524	50
gray/blue	280-534	50
○ gray	280-520	50
● blue	280-530	50



IEC/EN 60947-7-1  
 500 V  
 6 kV  
 20 A  
 300 V, 15 A **W**; 300 V, 20 A **Ⓢ**

0.08 ... 2.5 mm<sup>2</sup> / 28 ... 12 AWG  
 0.08 ... 2.5 mm<sup>2</sup> / 28 ... 12 AWG  
 12 AWG: THHN, THWN  
 8 ... 9 mm / 0.31 ... 0.35 inch  
 5 mm / 0.197 inch  
 Polyamide 66 (PA 66)

	Item No.	Page
gray	280-402	440
orange	280-343	443
white	2009-115	780

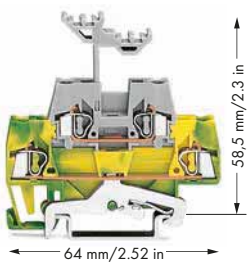

Double-deck terminal block, ground conductor/through terminal block

Color	Item No.	Pack. Unit
green-yellow/gray	280-527	50
green-yellow/blue	280-537	50



IEC/EN 60947-7-1  
 500 V  
 6 kV  
 20 A  
 300 V, 15 A **W**; 300 V, 20 A **Ⓢ**

0.08 ... 2.5 mm<sup>2</sup> / 28 ... 12 AWG  
 0.08 ... 2.5 mm<sup>2</sup> / 28 ... 12 AWG  
 12 AWG: THHN, THWN  
 8 ... 9 mm / 0.31 ... 0.35 inch  
 5 mm / 0.197 inch  
 Polyamide 66 (PA 66)

	Item No.	Page
gray	280-402	440
orange	280-341	443
white	2009-115	780

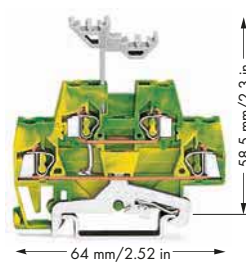

Double-deck terminal block, 4-conductor ground terminal block, internally commoned

Color	Item No.	Pack. Unit
● green-yellow	280-517	50



IEC/EN 60947-7-2  
 300 V, 15 A **W**; 300 V, 20 A **Ⓢ**

0.08 ... 2.5 mm<sup>2</sup> / 28 ... 12 AWG  
 0.08 ... 2.5 mm<sup>2</sup> / 28 ... 12 AWG  
 12 AWG: THHN, THWN  
 8 ... 9 mm / 0.31 ... 0.35 inch  
 5 mm / 0.197 inch  
 Polyamide 66 (PA 66)

	Item No.	Page
gray	280-402	440
orange	280-341	443
white	2009-115	780

## Double-Deck Terminal Blocks

### 2.5 mm<sup>2</sup>, 280 Series

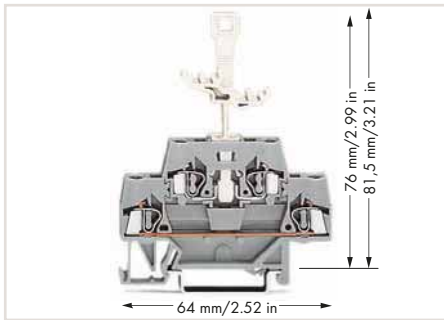

Double-deck terminal block, through/disconnect terminal block (280-521, gray)

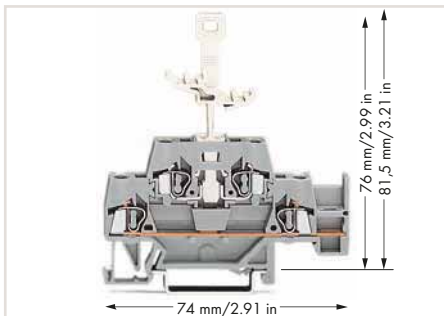

Double-deck terminal block, through/disconnect terminal block with horizontal jumpering on lower level (280-522, gray)

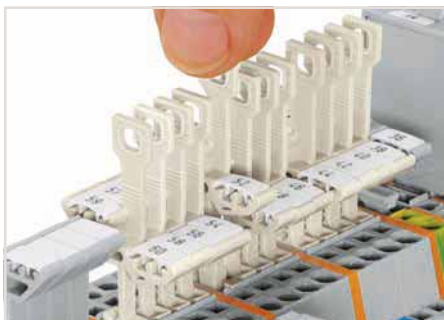

Pulling the disconnect tab.

#### Technical Data

Ratings per	IEC/EN 60947-7-1
Rated voltage (III / 3)	400 V
Rated surge voltage (III / 3)	6 kV
Rated current	10 A
Approval	300 V, 15 A ; 300 V, 20 A

#### Connection Data

Solid conductor	0.08 ... 2.5 mm <sup>2</sup> / 28 ... 12 AWG
Fine-stranded conductor	0.08 ... 2.5 mm <sup>2</sup> / 28 ... 12 AWG
Note (conductor cross section)	12 AWG: THHN, THWN
Strip length	8 ... 9 mm / 0.31 ... 0.35 inch
Terminal block width	5 mm / 0.197 inch
Insulation material	Polyamide 66 (PA 66)

#### Accessories (Selection)

Adjacent jumper, insulated, I <sub>N</sub> = I <sub>N</sub> terminal block	
End and intermediate plate, 2.5 mm thick	
WMB Inline, plain, 1,500 WMB markers (5 mm) per reel, 5 ... 5.2 mm stretchable	

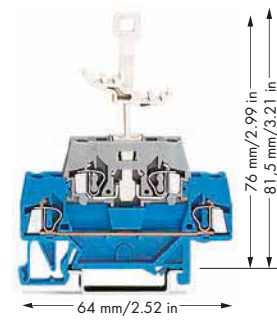

Double-deck terminal block, through/disconnect terminal block

Color	Item No.	Pack. Unit
blue/gray	280-525	50
gray/gray	280-521	50



IEC/EN 60947-7-1
400 V
6 kV
10 A
300 V, 15 A ; 300 V, 20 A

0.08 ... 2.5 mm <sup>2</sup> / 28 ... 12 AWG
0.08 ... 2.5 mm <sup>2</sup> / 28 ... 12 AWG
12 AWG: THHN, THWN
8 ... 9 mm / 0.31 ... 0.35 inch
5 mm / 0.197 inch
Polyamide 66 (PA 66)

	Item No.	Page
gray	280-402	440
orange	280-341	443
white	2009-115	780

Accessories (jumpers, end plates, etc.), see page 440

Carrier rails and tools, see Section 13

Appropriate marking system, WMB/WMB Inline, see Full Line Catalog, Volume 6

Approvals and corresponding ratings, visit [www.wago.com](http://www.wago.com)



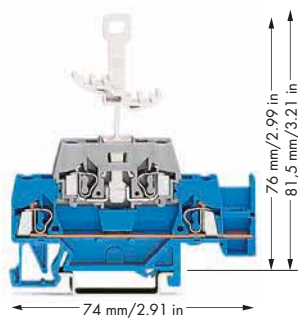

Double-deck terminal block, through/disconnect terminal block with horizontal jumpering on lower level

Color	Item No.	Pack. Unit
blue/gray	280-526	50
○ gray/gray	280-522	50



IEC/EN 60947-7-1
400 V
6 kV
10 A
300 V, 15 A <b>UL</b> ; 300 V, 20 A <b>CE</b>

0.08 ... 2.5 mm <sup>2</sup> / 28 ... 12 AWG
0.08 ... 2.5 mm <sup>2</sup> / 28 ... 12 AWG
12 AWG: THHN, THWN
8 ... 9 mm / 0.31 ... 0.35 inch
5 mm / 0.197 inch
Polyamide 66 (PA 66)

	Item No.	Page
gray	280-402	440
orange	280-343	443
white	2009-115	780

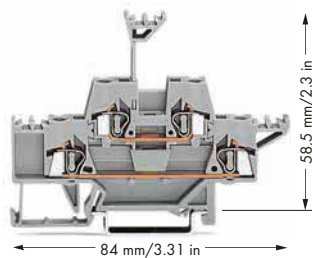

Double-deck terminal block, through/through terminal block, with additional marking options on both terminal block sides

Color	Item No.	Pack. Unit
○ gray	280-513	50



IEC/EN 60947-7-1
500 V
6 kV
20 A
300 V, 15 A <b>UL</b> ; 300 V, 20 A <b>CE</b>

0.08 ... 2.5 mm <sup>2</sup> / 28 ... 12 AWG
0.08 ... 2.5 mm <sup>2</sup> / 28 ... 12 AWG
12 AWG: THHN, THWN
8 ... 9 mm / 0.31 ... 0.35 inch
5 mm / 0.197 inch
Polyamide 66 (PA 66)

	Item No.	Page
gray	280-402	440
orange	280-341	443
white	2009-115	780

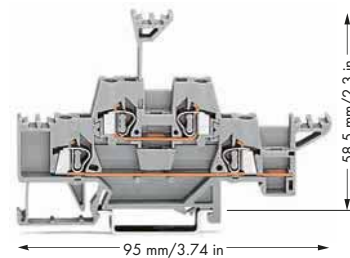

Double-deck terminal block, through/through terminal block, with additional marking options on both terminal block sides, with horizontal jumpering on lower level

Color	Item No.	Pack. Unit
○ gray	280-543	50



IEC/EN 60947-7-1
500 V
6 kV
20 A
300 V, 15 A <b>UL</b> ; 300 V, 20 A <b>CE</b>

0.08 ... 2.5 mm <sup>2</sup> / 28 ... 12 AWG
0.08 ... 2.5 mm <sup>2</sup> / 28 ... 12 AWG
12 AWG: THHN, THWN
8 ... 9 mm / 0.31 ... 0.35 inch
5 mm / 0.197 inch
Polyamide 66 (PA 66)

	Item No.	Page
gray	280-402	440
orange	280-343	443
white	2009-115	780

## Double- and Triple-Deck Carrier Terminal Blocks for Fuse Plugs 2.5 mm<sup>2</sup>, 280 Series

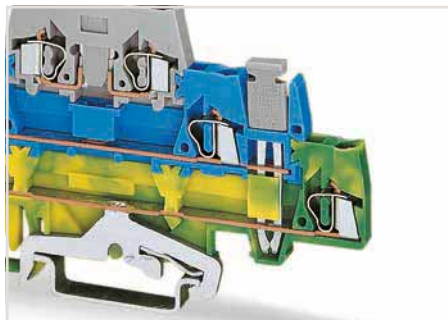

Grounding to carrier rail:  
Connecting N-level to ground level via vertical jumper.

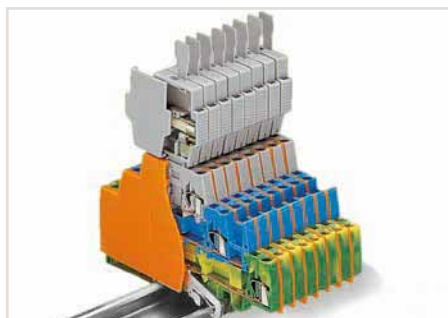

When triple-deck terminal blocks are used with a fuse plug (6 mm wide) in the receptacle (top) level, the extra width can be compensated for the 280 Series (5 mm wide) via an intermediate plate (1.1 mm thick).

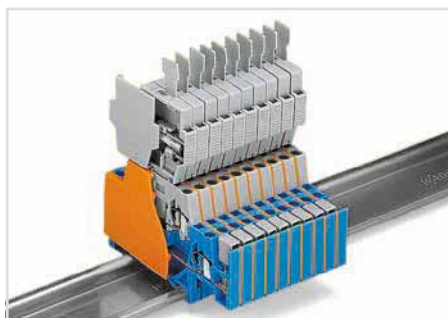

When double-deck terminal blocks are used with a fuse plug (6 mm wide) in the receptacle (top) level, the extra width can be compensated for the 280 Series (5 mm wide) via an intermediate plate (1.1 mm thick). If required, this special intermediate plate still allows commoning on the lower level via push-in adjacent jumpers (280-402).

Electrical ratings are given by the fuse or LED nominal voltage.

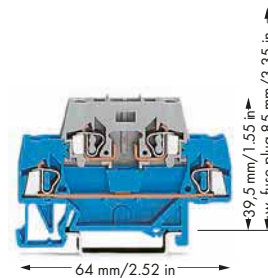

Double-deck terminal block, through/carrier terminal block for fuse plugs

Color	Item No.	Pack. Unit
blue/gray	280-531	50
○ gray/gray	280-514	50

WAGO

### Technical Data

Ratings per	IEC/EN 60947-7-1
Rated voltage (III / 3)	400 V
Rated surge voltage (III / 3)	6 kV
Rated current	10 A
Rated current (2)	20 A
Approval	300 V, 15 A ; 300 V, 20 A

### Connection Data

Solid conductor	0.08 ... 2.5 mm <sup>2</sup> / 28 ... 12 AWG
Fine-stranded conductor	0.08 ... 2.5 mm <sup>2</sup> / 28 ... 12 AWG
Note (conductor cross section)	12 AWG: THHN, THWN
Strip length	8 ... 9 mm / 0.31 ... 0.35 inch
Terminal block width	5 mm / 0.197 inch
Insulation material	Polyamide 66 (PA 66)

### Accessories (Selection)

Adjacent jumper, insulated, I <sub>N</sub> = I <sub>N</sub> terminal block	
End and intermediate plate, 2.5 mm thick	
Fuse plug with pull-tab, 6 mm wide	
WSB Quick marking system, 10 strips with 10 markers per card, 4 mm wide WSB markers, plain	

	Item No.	Page
orange	280-341	443
gray	281-511	380
white	209-701	782

Accessories (jumpers, end plates, etc.), see page 440

Carrier rails and tools, see Section 13

Appropriate marking system for fuse plugs, WSB Quick marking system, see page 782

Approvals and corresponding ratings, visit [www.wago.com](http://www.wago.com)

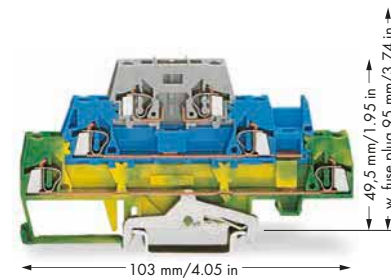
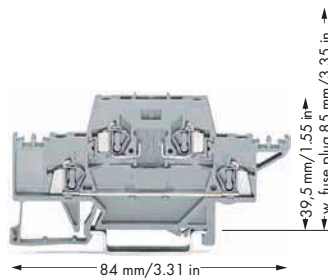
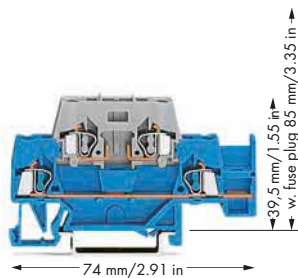

Double-deck terminal block, through/carrier terminal block for fuse plugs, with horizontal jumpering on lower level

Color	Item No.	Pack. Unit
blue/gray	280-532	50
○ gray/gray	280-891	50

Double-deck terminal block, through/carrier terminal block for fuse plugs

Color	Item No.	Pack. Unit
○ gray/gray	280-528	50

Triple-deck terminal block, ground conductor/through/carrier terminal block for fuse plugs

Color	Item No.	Pack. Unit
○ green-yellow/blue/gray	280-510	50

Triple-deck terminal block, through/through/carrier terminal block for fuse plugs

Color	Item No.	Pack. Unit
gray/gray/gray	280-889	50



IEC/EN 60947-7-1
400 V
6 kV
10 A
20 A
300 V, 15 A ; 300 V, 20 A

IEC/EN 60947-7-1
400 V
6 kV
10 A
10 A

IEC/EN 60947-7-1
400 V
6 kV
20 A
20 A
300 V, 15 A ; 600 V, 20 A

0.08 ... 2.5 mm <sup>2</sup> / 28 ... 12 AWG
0.08 ... 2.5 mm <sup>2</sup> / 28 ... 12 AWG
12 AWG: THHN, THWN
8 ... 9 mm / 0.31 ... 0.35 inch
5 mm / 0.197 inch
Polyamide 66 (PA 66)

0.08 ... 2.5 mm <sup>2</sup> / 28 ... 12 AWG
0.08 ... 2.5 mm <sup>2</sup> / 28 ... 12 AWG
12 AWG: THHN, THWN
8 ... 9 mm / 0.31 ... 0.35 inch
5 mm / 0.197 inch
Polyamide 66 (PA 66)

0.08 ... 2.5 mm <sup>2</sup> / 28 ... 12 AWG
0.08 ... 2.5 mm <sup>2</sup> / 28 ... 12 AWG
12 AWG: THHN, THWN
8 ... 9 mm / 0.31 ... 0.35 inch
5 mm / 0.197 inch
Polyamide 66 (PA 66)

	Item No.	Page
gray	280-402	440
orange	280-343	443
gray	281-511	380
white	209-701	782

	Item No.	Page
orange	280-341	443
gray	281-511	380
white	209-701	782

	Item No.	Page
gray	280-402	440
orange	280-304	443
gray	281-511	380
white	209-701	782

## Double-Deck Terminal Blocks

### 4 mm<sup>2</sup>, 281 Series



The flexible marker carrier, which is placed above the wiring level, can be pushed aside during wiring or commoning. The carrier has two staggered levels for WMB markers that perfectly align with the terminal block decks.

Terminal blocks with a blue insulated housing are suitable for Ex i applications.

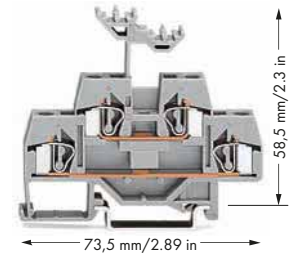

Double-deck terminal block, through/through terminal block

Color	Item No.	Pack. Unit
○ gray	281-619	50
● blue	281-629	50

**UL**

IEC/EN 60947-7-1

500 V

6 kV

26 A

600 V, 20 A **UL**; 600 V, 25 A **CE**

0.08 ... 4 mm<sup>2</sup> / 28 ... 12 AWG

0.08 ... 4 mm<sup>2</sup> / 28 ... 12 AWG

9 ... 10 mm / 0.35 ... 0.39 inch

6 mm / 0.236 inch

Polyamide 66 (PA 66)

	Item No.	Page
gray	281-402	447
orange	281-341	449
white	2009-115	780

5

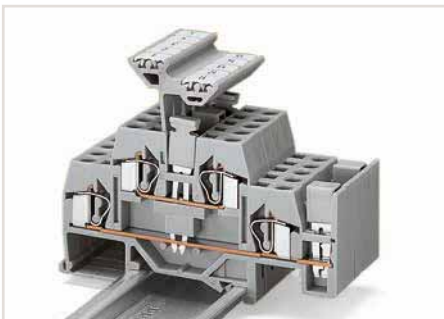

Standard insulated push-in jumpers can be used for the commoning. A vertical jumper allows commoning of upper and lower levels, providing a 4-conductor feedthrough terminal block in one housing.

#### Technical Data

Ratings per

Rated voltage (III / 3)

Rated surge voltage (III / 3)

Rated current

Approval

#### Connection Data

Solid conductor

Fine-stranded conductor

Strip length

Terminal block width

Insulation material

#### Accessories (Selection)

Adjacent jumper, insulated, I<sub>N</sub> = I<sub>N</sub> terminal block

End and intermediate plate, 2.5 mm thick

WMB Inline, plain, 1,500 WMB markers (5 mm) per reel, 5 ... 5.2 mm stretchable

Accessories (jumpers, end plates, etc.), see page 447

Carrier rails and tools, see Section 13

Appropriate marking system, WMB/WMB Inline, see Full Line Catalog, Volume 6

Approvals and corresponding ratings, visit [www.wago.com](http://www.wago.com)

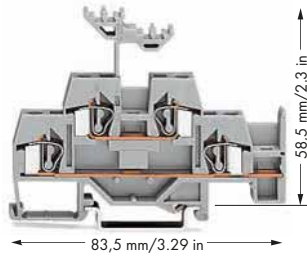

Double-deck terminal block, through/through terminal block, with horizontal jumpering on lower level

Color	Item No.	Pack. Unit
○ gray	281-620	50
● blue	281-630	50

UL®

IEC/EN 60947-7-1

500 V

6 kV

26 A

600 V, 20 A<sup>UL</sup>; 600 V, 25 A<sup>UL</sup>

0.08 ... 4 mm<sup>2</sup> / 28 ... 12 AWG

0.08 ... 4 mm<sup>2</sup> / 28 ... 12 AWG

9 ... 10 mm / 0.35 ... 0.39 inch

6 mm / 0.236 inch

Polyamide 66 (PA 66)

	Item No.	Page
gray	281-402	447
orange	281-343	449
white	2009-115	780

## Triple-Deck Terminal Blocks

### 2.5 mm<sup>2</sup>, 280 Series

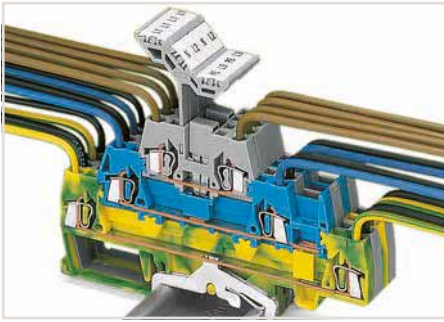

Three-conductor power circuit with additional branch circuit tapping

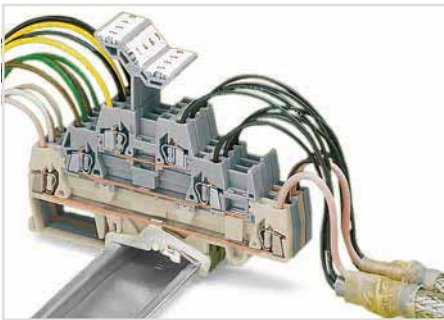

Shielded twisted pair cables



Both ground and shield conductor terminal blocks have a contact foot in the bottom level, automatically establishing direct contact to the carrier rail or busbar.

The flexible marker carrier, which is placed above the wiring level, can be pushed aside during wiring. The carrier has two staggered levels for WMB markers that perfectly align with the terminal block decks. With a terminal block width of just 5 mm, an effective width of just 1.67 mm for terminal blocks of same or different potentials can be realized for conductors ranging 0.08 mm<sup>2</sup> ... 2.5 mm<sup>2</sup> (28 ... 14 AWG).

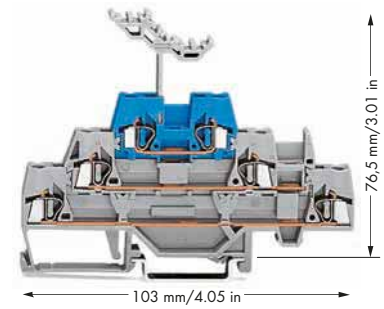

Triple-deck terminal block, through/through/through terminal block

Color	Item No.	Pack. Unit
gray/gray/gray	280-552	40
○ gray	280-549	40
● blue	280-551	40



#### Technical Data

Ratings per	IEC/EN 60947-7-1
Rated voltage (III / 3)	500 V
Rated surge voltage (III / 3)	6 kV
Rated current	20 A
Approval	300 V, 15 A ; 300 V, 20 A

#### Connection Data

Solid conductor	0.08 ... 2.5 mm <sup>2</sup> / 28 ... 12 AWG
Fine-stranded conductor	0.08 ... 2.5 mm <sup>2</sup> / 28 ... 12 AWG
Note (conductor cross section)	12 AWG: THHN, THWN
Strip length	8 ... 9 mm / 0.31 ... 0.35 inch
Terminal block width	5 mm / 0.197 inch
Insulation material	Polyamide 66 (PA 66)

#### Note:

#### Accessories (Selection)

Adjacent jumper, insulated, I <sub>N</sub> = I <sub>N</sub> terminal block
End and intermediate plate, 2.5 mm thick
WMB Inline, plain, 1,500 WMB markers (5 mm) per reel, 5 ... 5.2 mm stretchable

	Item No.	Page
gray	280-402	440
orange	280-304	443
white	2009-115	780

Accessories (jumpers, end plates, test plugs, etc.), see page 440

Carrier rails and tools, see Section 13

Appropriate marking system, WMB/WMB Inline, see Full Line Catalog, Volume 6

Approvals and corresponding ratings, visit [www.wago.com](http://www.wago.com)



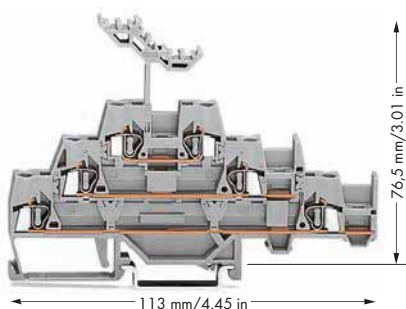

Triple-deck terminal block, through/through/through terminal block, with additional jumper position on lower level

Color	Item No.	Pack. Unit
○ gray	280-550	40

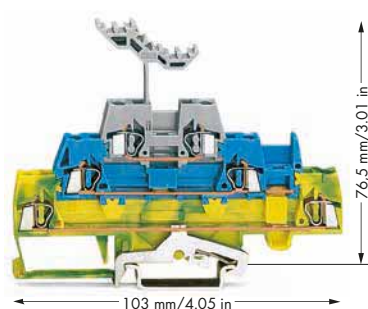

Triple-deck terminal block, ground conductor/through/through terminal block

Color	Item No.	Pack. Unit
green-yellow/blue/gray	280-547	40
green-yellow/gray/gray	280-557	40

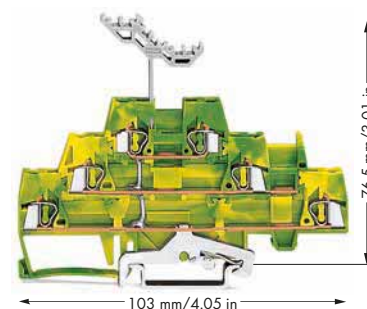

Triple-deck terminal block, 6-conductor ground terminal block, internally commoned

Color	Item No.	Pack. Unit
● green-yellow	280-597	40

Triple-deck terminal block, shield conductor/through/through terminal block

Color	Item No.	Pack. Unit
white/gray/gray	280-548	40
white/blue/gray	280-558	40

RAE

Ⓔ

Ⓔ

IEC/EN 60947-7-1
500 V
6 kV
20 A
300 V, 15 A <b>RAE</b> ; 300 V, 20 A <b>Ⓔ</b>

IEC/EN 60947-7-1
500 V
6 kV
20 A
300 V, 20 A <b>Ⓔ</b>

IEC/EN 60947-7-1

0.08 ... 2.5 mm <sup>2</sup> / 28 ... 12 AWG
0.08 ... 2.5 mm <sup>2</sup> / 28 ... 12 AWG
12 AWG: THHN, THWN
8 ... 9 mm / 0.31 ... 0.35 inch
5 mm / 0.197 inch
Polyamide 66 (PA 66)

0.08 ... 2.5 mm <sup>2</sup> / 28 ... 12 AWG
0.08 ... 2.5 mm <sup>2</sup> / 28 ... 12 AWG
12 AWG: THHN, THWN
8 ... 9 mm / 0.31 ... 0.35 inch
5 mm / 0.197 inch
Polyamide 66 (PA 66)

0.08 ... 2.5 mm <sup>2</sup> / 28 ... 12 AWG
0.08 ... 2.5 mm <sup>2</sup> / 28 ... 12 AWG
12 AWG: THHN, THWN
8 ... 9 mm / 0.31 ... 0.35 inch
5 mm / 0.197 inch
Polyamide 66 (PA 66)

Notice: This double potential terminal block cannot be commoned via adjacent jumpers.

	Item No.	Page
gray	280-402	440
orange	280-306	443
white	2009-115	780

	Item No.	Page
gray	280-402	440
orange	280-304	443
white	2009-115	780

	Item No.	Page
orange	280-304	443
white	2009-115	780

## Quadruple-Deck, Rail-Mount Terminal Blocks for Electric Motor Wiring

### 4 mm<sup>2</sup>, 281 Series



Compact design: Three phases and one ground conductor in a single terminal block



Commoning using comb-style jumper bars. Push comb-style jumper bars down until fully inserted. Group marking via marking strips (Item No. 709-177)

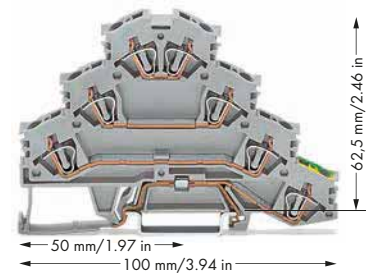

Quadruple-deck, rail-mount terminal block, electric motor wiring rail-mount terminal block, gray

	Item No.	Pack. Unit
○ L1 - L2 - L3 - PE	281-530	50



#### Technical Data

Ratings per	IEC/EN 60947-7-1
Rated voltage (III / 3)	800 V
Rated surge voltage (III / 3)	8 kV
Rated current	32 A
Approval	600 V, 20 A ; 300 V, 25 A

#### Connection Data

Solid conductor	0.08 ... 4 mm <sup>2</sup> / 28 ... 12 AWG
Fine-stranded conductor	0.08 ... 4 mm <sup>2</sup> / 28 ... 12 AWG
Strip length	8 ... 9 mm / 0.31 ... 0.35 inch
Terminal block width	6 mm / 0.236 inch
Insulation material	Polyamide 66 (PA 66)

#### Accessories (Selection)

Comb-style jumper bar, insulated, I <sub>N</sub> = I <sub>N</sub> terminal block, gray	281-482	447
End and intermediate plate, 2.5 mm thick	281-366	449
WMB Inline, plain, 1,500 WMB markers (5 mm) per reel, 5 ... 5.2 mm stretchable	2009-115	780
Marking strip, plain, 1,500 WMB markers (5 mm) on reel, 50 m reel	709-177	783

In addition to rail-mount terminal blocks for electric motor wiring, special versions are also available.

- Version **without** ground contact and only two potentials:

These terminal blocks were custom designed to support additional functions, such as engine brakes or temperature sensors. Sharing a common profile, this terminal block version can be put next to the appropriate electric motor wiring terminal block without using intermediate plates. That makes the rail assembly easier to understand and wire. This also prevents wiring errors as no conductor entry is unused.

- Version **without** ground contact and with three potentials:

Clearly designated clamping units are the primary advantage to this terminal block design. When using devices with protective insulation for example, there are no open ground clamping units that could create confusion.

Accessories (comb-style jumper bars, end plates, etc.), see page 447

Carrier rails and tools, see Section 13

Appropriate marking system, WMB/Marking strips, see Full Line Catalog, Volume 6

Information on hazardous locations, see Section 14

Approvals and corresponding ratings, visit [www.wago.com](http://www.wago.com)

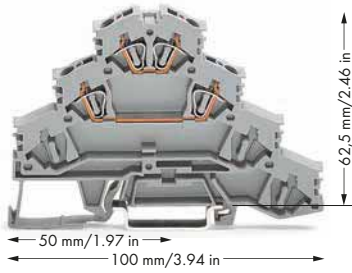

Quadruple-deck, rail-mount terminal block, electric motor wiring rail-mount terminal block, gray

	Item No.	Pack. Unit
○ L1 - L2	281-531	50



IEC/EN 60947-7-1
800 V
8 kV
32 A
600 V, 20 A ; 300 V, 25 A

0.08 ... 4 mm <sup>2</sup> / 28 ... 12 AWG
0.08 ... 4 mm <sup>2</sup> / 28 ... 12 AWG
8 ... 9 mm / 0.31 ... 0.35 inch
6 mm / 0.236 inch
Polyamide 66 (PA 66)

	Item No.	Page
2-way	281-482	447
orange	281-366	449
white	2009-115	780
translucent	709-177	783

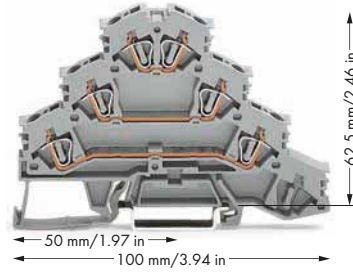

Quadruple-deck, rail-mount terminal block, electric motor wiring rail-mount terminal block, gray

	Item No.	Pack. Unit
○ L1 - L2 - L3	281-532	50



IEC/EN 60947-7-1
800 V
8 kV
26 A
600 V, 20 A ; 300 V, 25 A

0.08 ... 4 mm <sup>2</sup> / 28 ... 12 AWG
0.08 ... 4 mm <sup>2</sup> / 28 ... 12 AWG
8 ... 9 mm / 0.31 ... 0.35 inch
6 mm / 0.236 inch
Polyamide 66 (PA 66)

	Item No.	Page
2-way	281-482	447
orange	281-366	449
white	2009-115	780
translucent	709-177	783

## TOPJOB® Classic Rail-Mount Terminal Blocks, 780 ... 785 Series

### Description and Installation

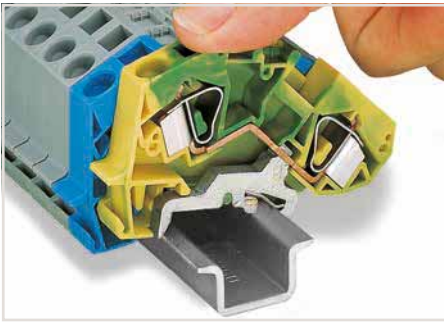

By snapping a ground conductor terminal block onto the carrier rail, a direct electrical connection is automatically made to the rail.



Removing a terminal block from the assembly.

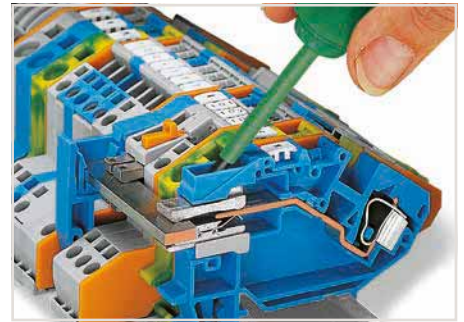

Operating an N-disconnect slide link.

5



Commoning ground conductor terminal blocks with through terminal blocks is possible in one direction only (via rear side of terminal block) using adjacent jumpers. In addition to the required marking of these blocks, use yellow-green adjacent jumpers.



Staggered jumpers for sophisticated circuit requirements – push jumpers down until fully inserted.

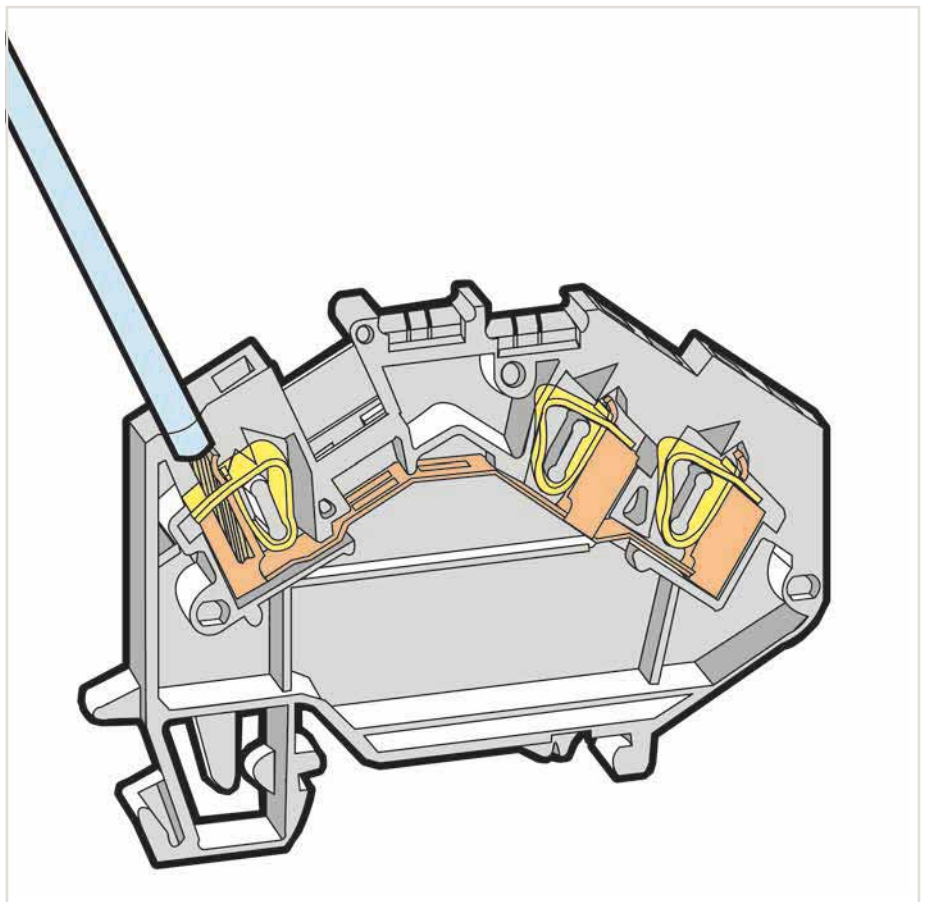

Test plug module assembly – combining test plug and spacer modules.



Insulation stop – prevents the conductor insulation from being pushed into the clamping unit (available for terminal blocks up to 4 mm<sup>2</sup>/12 AWG).



Labeling via WMB Multi markers and WFB continuous marking strips.



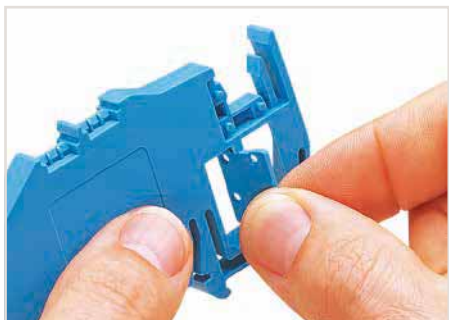

Removing the separator plate from the busbar carrier.

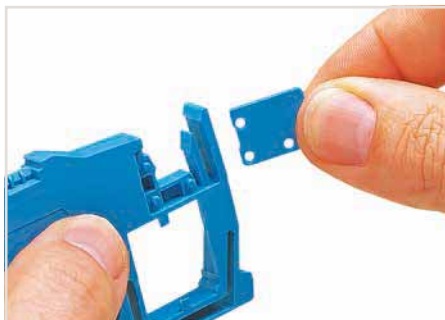

Inserting the separator plate to protect the N-busbar against accidental contact.

For the construction and operation of power installations in fire-prone, hazardous locations or public buildings – such as conference centers, stores, hospitals, schools, theaters or hotels – the DIN VDE 0100-710 or DIN VDE 0100-718 standards shall be observed. DIN VDE 0100-482 shall also be observed for fire-prone, hazardous locations. These VDE regulations mandate that every neutral conductor must be provided with a disconnection device so, e.g., insulation testing is possible for every circuit without disconnecting the N-conductor.

WAGO N-disconnect terminal blocks meet this requirement.

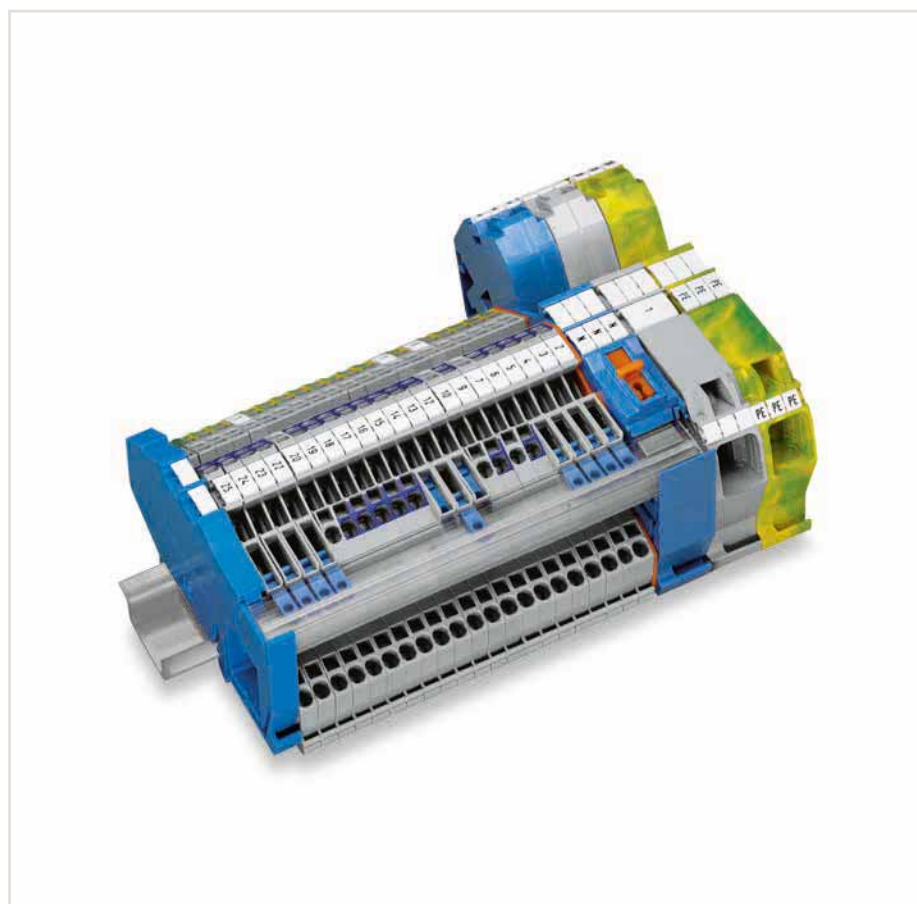

The 35 mm<sup>2</sup> (2 AWG) terminal blocks are the latest addition to WAGO TOPJOB®, the professional range of rail-mount terminal blocks for building installations. These terminal blocks, which include an end plate, are just 16 mm wide. Their compact design allows them to fit into standard distribution boxes. The lower conductor entry angle makes it much easier to terminate 35 mm<sup>2</sup> (2 AWG) conductors. Furthermore, the N-busbar holder is integrated into the terminal block, eliminating separate holders.

According to DIN VDE 0100-710, "Requirements for operating facilities, rooms and special installations – medical facilities," equipotential bonding conductors shall be run on a potential equalization busbar. The potential equalization busbar and the protective ground conductor busbar must be mounted in a common housing and be connected to each other using a disconnectable copper conductor of minimum 16 mm<sup>2</sup> (6 AWG). Furthermore, all equipotential bonding conductors must be connected to the potential equalization busbar and clearly arranged so they can be disconnected individually and accessed at any time. Depending on their function, they must be provided with captive marking.

WAGO's power distribution disconnect terminal blocks meet these requirements.

## TOPJOB® Classic

### Through, Ground/Shield Conductor and Ex Terminal Blocks

#### 2.5 mm<sup>2</sup>, 780 Series

\*12 AWG: THHN, THWN  
 Rail-mount terminal blocks with an Ex mark are suitable for Ex e II applications.  
 Conductor range for 780 Series:  
 0.2 ... 2.5 mm<sup>2</sup> / 24 ... 12 AWG\*  
 690 V, 23 A  
 Using staggered jumpers reduces the maximum rated voltage to 275 V.  
 Terminal blocks with a blue insulated housing are suitable for Ex i applications.

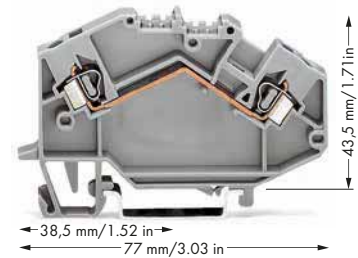

2-conductor through terminal block		
Color	Item No.	Pack. Unit
gray	780-601	50
blue	780-604	50
orange	780-602	50
light gray	780-992	50

5

#### Technical Data

Ratings per	
Rated voltage (III / 3)	
Rated surge voltage (III / 3)	
Rated current	
Approval	

#### Connection Data

Solid conductor	0.08 ... 2.5 mm <sup>2</sup> / 28 ... 12 AWG
Fine-stranded conductor	0.08 ... 2.5 mm <sup>2</sup> / 28 ... 12 AWG
Note (conductor cross section)	12 AWG: THHN, THWN
Strip length	8 ... 9 mm / 0.31 ... 0.35 inch
Terminal block width	5 mm / 0.197 inch
Insulation material	Polyamide 66 (PA 66)

#### Accessories (Selection)

Adjacent jumper, insulated, I <sub>N</sub> = I <sub>N</sub> terminal block	
End and intermediate plate, 1.5 mm thick	
WMB Inline, plain, 1,500 WMB markers (5 mm) per reel, 5 ... 5.2 mm stretchable	
WFB continuous marking strip, 1000 mm long	
Test plug adapter, 5 mm wide, for 210-137 Test Plug (2.3 mm Ø), for 1.5 ... 4 mm <sup>2</sup> terminal blocks	
TOPJOB® Tool, specialty blade, for all TOPJOB® Terminal Blocks	



IEC/EN 60947-7-1
1000 V
8 kV
24 A
600 V, 20 A ; 600 V, 20 A

	Item No.	Page
gray	280-402	440
orange	780-317	443
white	2009-115	780
transparent	210-612	783
gray	280-404	460
	777-310	462

Accessories for 780 Series, see page 440

Standard accessories for installation rail-mount terminal blocks, see page 461

Carrier rails and tools, see Section 13

Appropriate marking system, WMB/WMB Inline/WFB, see Full Line Catalog, Volume 6

Information on hazardous locations, see Section 14

Approvals and corresponding ratings, visit [www.wago.com](http://www.wago.com)



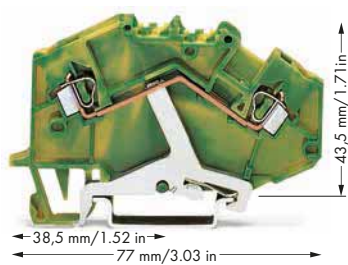
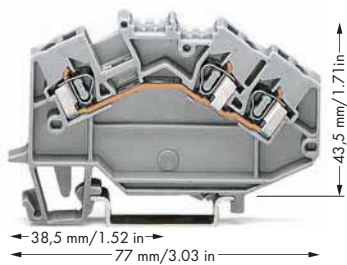

3-conductor through terminal block		
Color	Item No.	Pack. Unit
○ gray	780-631	50
● blue	780-651	50
● orange	780-654	50
○ light gray ⊕	780-993	50

2-conductor ground terminal block		
Color	Item No.	Pack. Unit
● green-yellow	780-607	50
● green-yellow ⊕	780-607/999-950	50

3-conductor ground terminal block		
Color	Item No.	Pack. Unit
● green-yellow	780-637	50
● green-yellow ⊕	780-637/999-950	50

3-conductor shield terminal block		
Color	Item No.	Pack. Unit
○ white	780-640	50



IEC/EN 60947-7-1  
1000 V  
8 kV  
24 A  
600 V, 20 A ; 600 V, 25 A

IEC/EN 60947-7-2  
0.08 ... 2.5 mm<sup>2</sup> / 28 ... 12 AWG  
0.08 ... 2.5 mm<sup>2</sup> / 28 ... 12 AWG  
12 AWG: THHN, THWN  
8 ... 9 mm / 0.31 ... 0.35 inch  
5 mm / 0.197 inch  
Polyamide 66 (PA 66)

IEC/EN 60947-7-2  
0.08 ... 2.5 mm<sup>2</sup> / 28 ... 12 AWG  
0.08 ... 2.5 mm<sup>2</sup> / 28 ... 12 AWG  
12 AWG: THHN, THWN  
8 ... 9 mm / 0.31 ... 0.35 inch  
5 mm / 0.197 inch  
Polyamide 66 (PA 66)

	Item No.	Page
gray	280-402	440
orange	780-317	443
white	2009-115	780
transparent	210-612	783
gray	280-404	460
	777-310	462

	Item No.	Page
gray	280-402	440
orange	780-317	443
white	2009-115	780
transparent	210-612	783
gray	280-404	460
	777-310	462

	Item No.	Page
gray	280-402	440
orange	780-317	443
white	2009-115	780
transparent	210-612	783
gray	280-404	460
	777-310	462

## TOPJOB® Classic Through/Ground Conductor and Ex Terminal Blocks 4 mm<sup>2</sup>, 781 Series

Rail-mount terminal blocks with an Ex mark are suitable for Ex e II applications.  
Conductor range for 781 Series:  
0.2 ... 4 mm<sup>2</sup> / 24 ... 12 AWG\*  
690 V  
30 A for 2-conductor terminal blocks  
27 A for 3-conductor terminal blocks  
Using staggered jumpers reduces the maximum rated voltage to 275 V.  
Terminal blocks with a blue insulated housing are suitable for Ex i applications.

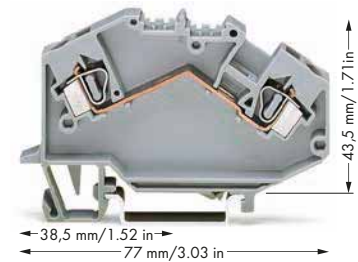

2-conductor through terminal block		
Color	Item No.	Pack. Unit
○ gray	781-601	50
● blue	781-604	50
○ light gray <sup>Ⓢ</sup>	781-992	50

**VA**

### Technical Data

Ratings per	IEC/EN 60947-7-1
Rated voltage (III / 3)	1000 V
Rated surge voltage (III / 3)	8 kV
Rated current	32 A
Approval	600 V, 20 A <b>VA</b> ; 600 V, 20 A <b>Ⓢ</b>

### Connection Data

Solid conductor	0.08 ... 4 mm <sup>2</sup> / 28 ... 12 AWG
Fine-stranded conductor	0.08 ... 4 mm <sup>2</sup> / 28 ... 12 AWG
Strip length	9 ... 10 mm / 0.35 ... 0.39 inch
Terminal block width	6 mm / 0.236 inch
Insulation material	Polyamide 66 (PA 66)

### Accessories (Selection)

Adjacent jumper, insulated, I <sub>N</sub> = I <sub>N</sub> terminal block
End and intermediate plate, 1.5 mm thick
WMB Inline, plain, 1,500 WMB markers (5 mm) per reel, 5 ... 5.2 mm stretchable
WFB continuous marking strip, 1000 mm long
Test plug adapter, 5 mm wide, for 210-137 Test Plug (2.3 mm Ø), for 1.5 ... 4 mm <sup>2</sup> terminal blocks
TOPJOB® Tool, specialty blade, for all TOPJOB® Terminal Blocks

	Item No.	Page
gray	280-402	447
orange	780-317	449
white	2009-115	780
transparent	210-612	783
gray	280-404	460
	777-310	462

Accessories for 781 Series, see page 447

Standard accessories for installation rail-mount terminal blocks, see page 461

Carrier rails and tools, see Section 13

Appropriate marking system, WMB/WMB Inline/WFB, see Full Line Catalog, Volume 6

Information on hazardous locations, see Section 14

Approvals and corresponding ratings, visit [www.wago.com](http://www.wago.com)

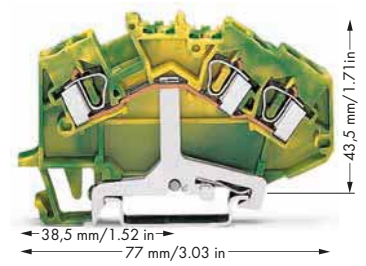
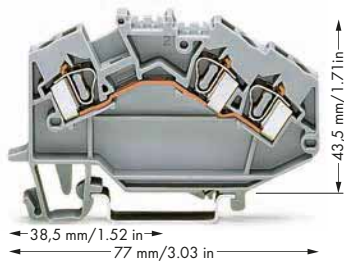

3-conductor through terminal block		
Color	Item No.	Pack. Unit
○ gray	781-631	50
● blue	781-651	50
○ light gray ☺	781-993	50

2-conductor ground terminal block		
Color	Item No.	Pack. Unit
● green-yellow	781-607	50
● green-yellow ☺	781-607/999-950	50

3-conductor ground terminal block		
Color	Item No.	Pack. Unit
● green-yellow	781-637	50
● green-yellow ☺	781-637/999-950	50



IEC/EN 60947-7-1  
1000 V  
8 kV  
32 A  
600 V, 20 A **UL**; 600 V, 20 A **UL**

IEC/EN 60947-7-2

IEC/EN 60947-7-2

0.08 ... 4 mm<sup>2</sup> / 28 ... 12 AWG  
0.08 ... 4 mm<sup>2</sup> / 28 ... 12 AWG  
9 ... 10 mm / 0.35 ... 0.39 inch  
6 mm / 0.236 inch  
Polyamide 66 (PA 66)

0.08 ... 4 mm<sup>2</sup> / 28 ... 12 AWG  
0.08 ... 4 mm<sup>2</sup> / 28 ... 12 AWG  
9 ... 10 mm / 0.35 ... 0.39 inch  
6 mm / 0.236 inch  
Polyamide 66 (PA 66)

0.08 ... 4 mm<sup>2</sup> / 28 ... 12 AWG  
0.08 ... 4 mm<sup>2</sup> / 28 ... 12 AWG  
9 ... 10 mm / 0.35 ... 0.39 inch  
6 mm / 0.236 inch  
Polyamide 66 (PA 66)

	Item No.	Page
gray	280-402	447
orange	780-317	449
white	2009-115	780
transparent	210-612	783
gray	280-404	460
	777-310	462

	Item No.	Page
gray	280-402	447
orange	780-317	449
white	2009-115	780
transparent	210-612	783
gray	280-404	460
	777-310	462

	Item No.	Page
gray	280-402	447
orange	780-317	449
white	2009-115	780
transparent	210-612	783
gray	280-404	460
	777-310	462

## TOPJOB® Classic

### Through/Ground Conductor and Ex Terminal Blocks

#### 6 mm<sup>2</sup>, 782 Series and 10 (16) mm<sup>2</sup>, 784 Series

Rail-mount terminal blocks with an Ex mark are suitable for Ex e II applications.

Conductor range for 782 Series:

0.2 ... 6 mm<sup>2</sup> / 24 ... 10 AWG

690 V, 39 A

Conductor range for 784 Series:

0.2 ... 10 mm<sup>2</sup> / 24 ... 8 AWG

690 V, 53 A

Terminal blocks with a blue insulated housing are suitable for Ex i applications.

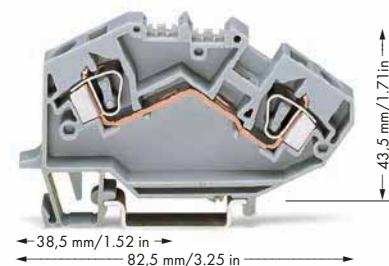

2-conductor through terminal block

Color	Item No.	Pack. Unit
○ gray	782-601	25
● blue	782-604	25
○ light gray <sup>Ⓔ</sup>	782-992	50



#### Technical Data

Ratings per	IEC/EN 60947-7-1
Rated voltage (III / 3)	1000 V
Rated surge voltage (III / 3)	8 kV
Rated current	41 A
Approval	600 V, 30 A <sup>Ⓐ</sup> , 600 V, 25 A <sup>Ⓒ</sup>

#### Connection Data

Solid conductor	0.2 ... 6 mm <sup>2</sup> / 24 ... 10 AWG
Fine-stranded conductor	0.2 ... 6 mm <sup>2</sup> / 24 ... 10 AWG

#### Connection Data (2)

Solid conductor (2)	
Fine-stranded conductor (2)	
Strip length	12 ... 13 mm / 0.47 ... 0.51 inch
Terminal block width	8 mm / 0.315 inch
Insulation material	Polyamide 66 (PA 66)

#### Accessories (Selection)

Adjacent jumper, insulated, I <sub>n</sub> 41 A	
Adjacent jumper, insulated, I <sub>n</sub> 57 A	
End and intermediate plate, 1.5 mm thick	
WMB Multi marking system, white, 10 strips with 10 markers per card, 5 ... 5.2 mm stretchable	
WFB continuous marking strip, 1000 mm long	
B-type test plug module with CAGE CLAMP®, snaps together Module width 8 mm	
B-type spacer plate, snaps together, snaps on B-type test plug modules (709-310) and B-type spacer modules (709-311) Module width 2 mm	
TOPJOB® Tool, specialty blade, for all TOPJOB® Terminal Blocks	

	Item No.	Page
gray	282-402	453
orange	782-317	454
plain	793-5501	780
transparent	210-612	783
gray	709-310	454
	777-310	462

Accessories for 784 Series, see page 453

Accessories for 782 Series, see page 455

Standard accessories for installation rail-mount terminal blocks, see page 461

Carrier rails and tools, see Section 13

Appropriate marking system, WMB/WMB Inline/WFB, see Full Line Catalog, Volume 6

Information on hazardous locations, see Section 14

Approvals and corresponding ratings, visit [www.wago.com](http://www.wago.com)

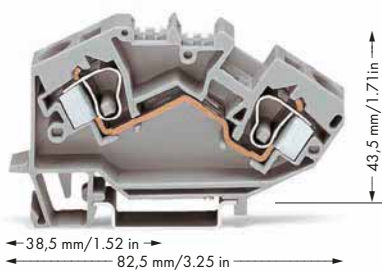
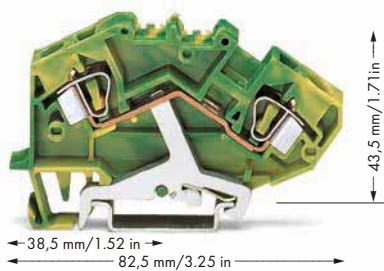

**2-conductor ground terminal block**

Color	Item No.	Pack. Unit
● green-yellow	782-607	25
● green-yellow ☉	782-607/999-950	25



IEC/EN 60947-7-2

0.2 ... 6 mm<sup>2</sup> / 24 ... 10 AWG  
0.2 ... 6 mm<sup>2</sup> / 24 ... 10 AWG

12 ... 13 mm / 0.47 ... 0.51 inch  
8 mm / 0.315 inch  
Polyamide 66 (PA 66)

	Item No.	Page
gray	282-402	453
orange	782-317	454
plain	793-5501	780
transparent	210-612	783
gray	709-310	454
	777-310	462

**3-conductor through terminal block**

Color	Item No.	Pack. Unit
● gray	784-601	25
● blue	784-604	25
● light gray ☉	784-992	25



IEC/EN 60947-7-1

1000 V  
8 kV  
57 A  
600 V, 50 A ; 600 V, 30 A ☉

0.2 ... 10 mm<sup>2</sup> / 24 ... 8 AWG  
0.2 ... 10 mm<sup>2</sup> / 24 ... 8 AWG

0.2 ... 16 mm<sup>2</sup> / 24 ... 6 AWG  
0.2 ... 16 mm<sup>2</sup> / 24 ... 6 AWG  
12 ... 13 mm / 0.47 ... 0.51 inch  
10 mm / 0.394 inch  
Polyamide 66 (PA 66)

	Item No.	Page
gray	284-402	455
orange	782-317	456
plain	793-5501	780
transparent	210-612	783
gray	709-310	456
gray	709-312	456
	777-310	462

**3-conductor ground terminal block**

Color	Item No.	Pack. Unit
● green-yellow	784-607	25
● green-yellow ☉	784-607/999-950	25



IEC/EN 60947-7-2

0.2 ... 10 mm<sup>2</sup> / 24 ... 8 AWG  
0.2 ... 10 mm<sup>2</sup> / 24 ... 8 AWG

0.2 ... 16 mm<sup>2</sup> / 24 ... 6 AWG  
0.2 ... 16 mm<sup>2</sup> / 24 ... 6 AWG  
12 ... 13 mm / 0.47 ... 0.51 inch  
10 mm / 0.394 inch  
Polyamide 66 (PA 66)

	Item No.	Page
gray	284-402	455
orange	782-317	456
plain	793-5501	780
transparent	210-612	783
gray	709-310	456
gray	709-312	456
	777-310	462

## TOPJOB® Classic

### Through/Ground Conductor and Ex Terminal Blocks

#### 16 mm<sup>2</sup>, 783 Series and 35 mm<sup>2</sup>, 785 Series

Rail-mount terminal blocks with an Ex mark are suitable for Ex e II applications.  
 Conductor range for 783 Series:  
 0.2 ... 16 mm<sup>2</sup> / 24 ... 6 AWG  
 690 V, 68 A  
 0.2 ... 10 mm<sup>2</sup> / 24 ... 8 AWG  
 for ground conductor terminal blocks  
 Terminal blocks with a blue insulated housing are suitable for Ex i applications.

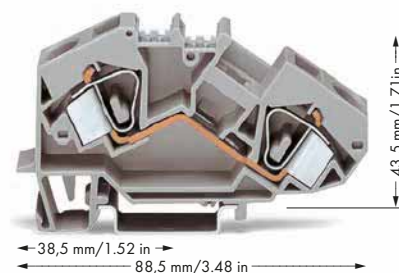

2-conductor through terminal block

Color	Item No.	Pack. Unit
○ gray	783-601	25
● blue	783-604	25
○ light gray ☺	783-992	25

WAGO

#### Technical Data

Ratings per	IEC/EN 60947-7-1
Rated voltage (III / 3)	1000 V
Rated surge voltage (III / 3)	8 kV
Rated current	76 A
Approval	600 V, 65 A <b>W</b> ; 600 V, 50 A <b>CE</b>

#### Connection Data

Solid conductor	0.2 ... 16 mm <sup>2</sup> / 24 ... 6 AWG
Fine-stranded conductor	0.2 ... 16 mm <sup>2</sup> / 24 ... 6 AWG
Strip length	16 ... 17 mm / 0.63 ... 0.67 inch
Strip length (2)	
Terminal block width	12 mm / 0.472 inch
Insulation material	Polyamide 66 (PA 66)

#### Note:

#### Accessories (Selection)

Adjacent jumper, insulated, I <sub>n</sub> 70 A
Adjacent jumper, insulated, I <sub>n</sub> 85 A
End and intermediate plate, 1.5 mm thick
WMB Multi marking system, white, 10 strips with 10 markers per card, 5 ... 5.2 mm stretchable
WFB continuous marking strip, 1000 mm long
Power tap, with 500 mm cable, for 16 mm <sup>2</sup> /6 AWG (283/783 Series) and 35 mm <sup>2</sup> /2 AWG (285/785 Series) rail-mount terminal blocks
TOPJOB® Tool, specialty blade, for all TOPJOB® Terminal Blocks

	Item No.	Page
gray	283-402	457
orange	783-317	457
plain	793-5501	780
transparent	210-612	783
gray	283-407	458
	777-310	462

📖 Accessories for 783 Series, see page 457

📖 Accessories for 785 Series, see page 459

📖 Standard accessories for installation rail-mount terminal blocks, see page 461

📖 Carrier rails and tools, see Section 13

📖 Appropriate marking system, WMB/WMB Inline/WFB, see Full Line Catalog, Volume 6

📖 Information on hazardous locations, see Section 14

📖 Approvals and corresponding ratings, visit [www.wago.com](http://www.wago.com)





## TOPJOB® Classic

### N-Conductor and Power Distribution Disconnect Terminal Blocks

2.5 mm<sup>2</sup>, 780 Series and 4 mm<sup>2</sup>, 781 Series and 6 mm<sup>2</sup>, 782 Series



1-conductor N-disconnect terminal block		
Color	Item No.	Pack. Unit
● blue	780-613	50

5

For the construction and operation of power installations in fire-prone, hazardous locations or public buildings – such as conference centers, stores, hospitals, schools, theaters or hotels – the DIN VDE 0100-710 or DIN VDE 0100-718 standards shall be observed. DIN VDE 0100-482 shall also be observed for fire-prone, hazardous locations. These VDE regulations mandate that every neutral conductor must be provided with a disconnection device so, e.g., insulation testing is possible for every circuit without disconnecting the N-conductor. WAGO N-disconnect terminal blocks meet this requirement.

According to DIN VDE 0100-710, "Requirements for operating facilities, rooms and special installations – medical facilities," equipotential bonding conductors shall be run on a potential equalization busbar. The potential equalization busbar and the protective ground conductor busbar must be mounted in a common housing and be connected to each other using a disconnectable copper conductor of minimum 16 mm<sup>2</sup> (6 AWG). Furthermore, all equipotential bonding conductors must be connected to the potential equalization busbar and clearly arranged so they can be disconnected individually and accessed at any time. Depending on their function, they must be provided with captive marking. WAGO's power distribution disconnect terminal blocks meet these requirements.

Standard accessories for installation rail-mount terminal blocks, see page 461

Accessories for 780 Series, see page 440

Accessories for 781 Series, see page 447

Accessories for 782 Series, see page 453

Carrier rails and tools, see Section 13

Appropriate marking system, WMB/WMB Inline/Marking strips, see Full Line Catalog, Volume 6

Approvals and corresponding ratings, visit [www.wago.com](http://www.wago.com)

#### Technical Data

Rated voltage (III / 3)	400 V
Rated surge voltage (III / 3)	6 kV
Rated current	23 A

#### Connection Data

Solid conductor	0.08 ... 2.5 mm <sup>2</sup> / 28 ... 12 AWG
Fine-stranded conductor	0.08 ... 2.5 mm <sup>2</sup> / 28 ... 12 AWG
Note (conductor cross section)	12 AWG: THHN, THWN
Strip length	8 ... 9 mm / 0.31 ... 0.35 inch
Terminal block width	5 mm / 0.197 inch
Insulation material	Polyamide 66 (PA 66)

#### Accessories (Selection)

Adjacent jumper, insulated, I <sub>N</sub> = I <sub>N</sub> terminal block	gray	280-402	440
Adjacent jumper, insulated, I <sub>N</sub> = I <sub>N</sub> terminal block			
Adjacent jumper, insulated, I <sub>N</sub> 41 A			
End and intermediate plate, 1.5 mm thick	orange	780-317	443
End and intermediate plate, 1.5 mm thick			
Busbar carrier, not suitable as an end stop, snaps onto DIN-35 rail, 1.5 mm thick	blue	780-321	461
Busbar carrier, not suitable as an end stop, snaps onto DIN-35 rail, 1.5 mm thick			
Busbar carrier, with end stop function and detachable separator plate, snaps onto DIN-35 rail, 8 mm thick	blue	777-305	461
WMB Inline, plain, 1,500 WMB markers (5 mm) per reel, 5 ... 5.2 mm stretchable	white	2009-115	780
WMB Multi marking system, white, 10 strips with 10 markers per card, 5 ... 5.2 mm stretchable			
WFB continuous marking strip, 1000 mm long	transparent	210-612	783
Lock-out, prevents reclosing of slide link, snap-on type	orange	777-300	462

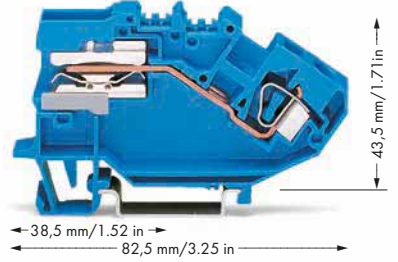
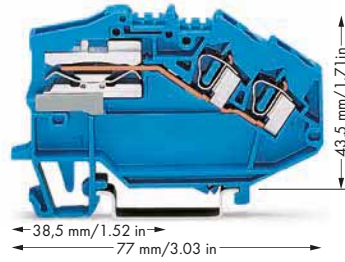
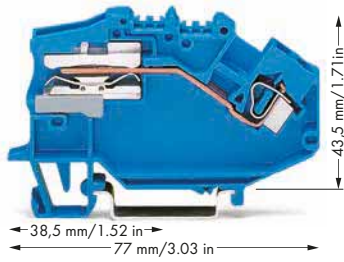

1-conductor N-disconnect terminal block		
Color	Item No.	Pack. Unit
● blue	781-613	50

2-conductor N-disconnect terminal block		
Color	Item No.	Pack. Unit
● blue	781-643	50

1-conductor N-disconnect terminal block		
Color	Item No.	Pack. Unit
● blue	782-613	25

1-conductor power distribution disconnect terminal block		
Color	Item No.	Pack. Unit
○ gray	781-623	50

2-conductor power distribution disconnect terminal block		
Color	Item No.	Pack. Unit
○ gray	781-653	50

1-conductor power distribution disconnect terminal block		
Color	Item No.	Pack. Unit
○ gray	782-623	25

400 V
6 kV
32 A

400 V
6 kV
32 A

400 V
6 kV
41 A

0.08 ... 4 mm <sup>2</sup> / 28 ... 12 AWG
0.08 ... 4 mm <sup>2</sup> / 28 ... 12 AWG

0.08 ... 4 mm <sup>2</sup> / 28 ... 12 AWG
0.08 ... 4 mm <sup>2</sup> / 28 ... 12 AWG

0.2 ... 6 mm <sup>2</sup> / 24 ... 10 AWG
0.2 ... 6 mm <sup>2</sup> / 24 ... 10 AWG

9 ... 10 mm / 0.35 ... 0.39 inch
6 mm / 0.236 inch
Polyamide 66 (PA 66)

9 ... 10 mm / 0.35 ... 0.39 inch
6 mm / 0.236 inch
Polyamide 66 (PA 66)

12 ... 13 mm / 0.47 ... 0.51 inch
8 mm / 0.315 inch
Polyamide 66 (PA 66)

	Item No.	Page
gray	281-402	447
orange	780-317	449
blue	780-321	461
blue	777-305	461
white	2009-115	780
transparent	210-612	783
orange	777-300	462

	Item No.	Page
gray	281-402	447
orange	780-317	449
blue	780-321	461
blue	777-305	461
white	2009-115	780
transparent	210-612	783
orange	777-300	462

	Item No.	Page
gray	282-402	453
orange	780-317	454
blue	782-321	461
blue	777-305	461
plain	783-5501	780
transparent	210-612	783
orange	777-300	462

## TOPJOB® Classic

### N-Conductor and Power Distribution Disconnect Terminal Blocks

2.5 mm<sup>2</sup>, 780 Series and 4 mm<sup>2</sup>, 781 Series and 6 mm<sup>2</sup>, Serie 782

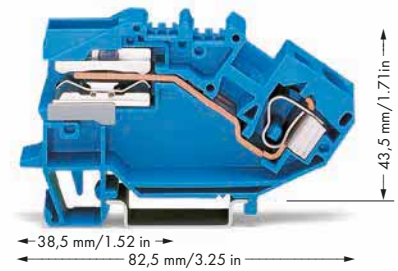

1-conductor N-disconnect terminal block

Color	Item No.	Pack. Unit
● blue	784-613	25

1-conductor power distribution disconnect terminal block

Color	Item No.	Pack. Unit
○ gray	784-623	25

**Technical Data**

Rated voltage (III / 3)	400 V
Rated surge voltage (III / 3)	6 kV
Rated current	57 A

**Connection Data**

Solid conductor	0.2 ... 10 mm <sup>2</sup> / 24 ... 8 AWG
Fine-stranded conductor	0.2 ... 10 mm <sup>2</sup> / 24 ... 8 AWG

**Connection Data (2)**

Solid conductor (2)	0.2 ... 16 mm <sup>2</sup> / 24 ... 6 AWG
Fine-stranded conductor (2)	0.2 ... 16 mm <sup>2</sup> / 24 ... 6 AWG
Strip length	12 ... 13 mm / 0.47 ... 0.51 inch

**Strip length (2)**

Terminal block width	10 mm / 0.394 inch
Insulation material	Polyamide 66 (PA 66)

**Accessories (Selection)**

	Item No.	Page	
Adjacent jumper, insulated, I <sub>N</sub> 57 A	gray	284-402	455
Adjacent jumper, insulated, I <sub>N</sub> 70 A			
Adjacent jumper, insulated, I <sub>N</sub> 85 A			
End and intermediate plate, 1.5 mm thick	orange	782-317	456
End and intermediate plate, 1.5 mm thick	blue	782-321	461
Busbar carrier, not suitable as an end stop, snaps onto DIN-35 rail, 1.5 mm thick			
Busbar carrier, not suitable as an end stop, snaps onto DIN-35 rail, 1.5 mm thick	blue	777-305	461
Busbar carrier, with end stop function and detachable separator plate, snaps onto DIN-35 rail, 8 mm thick			
WMB Multi marking system, white, 10 strips with 10 markers per card, 5 ... 5.2 mm stretchable	plain	783-5501	780
WFB continuous marking strip, 1000 mm long	transparent	210-612	783
Lock-out, prevents reclosing of slide link, snap-on type	orange	782-300	462

For the construction and operation of power installations in fire-prone, hazardous locations or public buildings – such as conference centers, stores, hospitals, schools, theaters or hotels – the DIN VDE 0100-710 or DIN VDE 0100-718 standards shall be observed. DIN VDE 0100-482 shall also be observed for fire-prone, hazardous locations. These VDE regulations mandate that every neutral conductor must be provided with a disconnection device so, e.g., insulation testing is possible for every circuit without disconnecting the N-conductor. WAGO N-disconnect terminal blocks meet this requirement.

According to DIN VDE 0100-710 "Requirements for operating facilities, rooms and special installations – medical facilities," equipotential bonding conductors shall be run on a potential equalization busbar. The potential equalization busbar and the protective ground conductor busbar must be mounted in a common housing and be connected to each other using a disconnectable copper conductor of minimum 16 mm<sup>2</sup> (6 AWG). Furthermore, all equipotential bonding conductors must be connected to the potential equalization busbar and clearly arranged so they can be disconnected individually and accessed at any time. Depending on their function, they must be provided with captive marking. WAGO's power distribution disconnect terminal blocks meet these requirements.

Standard accessories for installation rail-mount terminal blocks, see page 461

Accessories for 784 Series, see page 455

Accessories for 783 Series, see page 457

Accessories for 785 Series, see page 459

Carrier rails and tools, see Section 13

Appropriate marking system, WMB/WMB Inline/Marking strips, see Full Line Catalog, Volume 6

Approvals and corresponding ratings, visit [www.wago.com](http://www.wago.com)

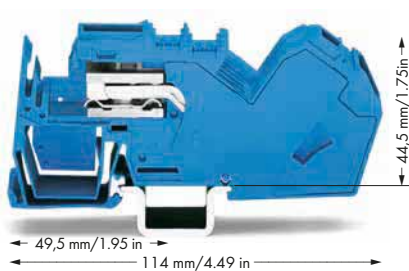
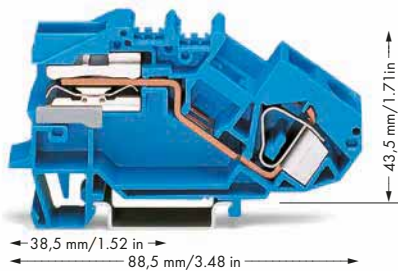

**1-conductor N-disconnect terminal block**

Color	Item No.	Pack. Unit
● blue	783-613	25

**1-conductor power distribution disconnect terminal block**

Color	Item No.	Pack. Unit
○ gray	783-623	25

400 V  
6 kV  
68 A

0.2 ... 16 mm<sup>2</sup> / 24 ... 6 AWG  
0.2 ... 16 mm<sup>2</sup> / 24 ... 6 AWG

16 ... 17 mm / 0.63 ... 0.67 inch

12 mm / 0.472 inch  
Polyamide 66 (PA 66)

	Item No.	Page
gray	283-402	457
orange	783-317	457
blue	783-321	461
blue	777-305	461
plain	783-5501	780
transparent	210-612	783
orange	782-300	462

**1-conductor N-disconnect terminal block , with integrated end plate**

Color	Item No.	Pack. Unit
● blue	785-613	15

**1-conductor power distribution disconnect terminal block , with integrated end plate**

Color	Item No.	Pack. Unit
○ gray	785-623	15

400 V  
6 kV  
125 A

6 ... 35 mm<sup>2</sup> / 8 ... 2 AWG  
6 ... 35 mm<sup>2</sup> / 8 ... 2 AWG

23 mm / 0.91 inch  
16 mm / 0.63 inch  
16 mm / 0.63 inch  
Polyamide 66 (PA 66)

	Item No.	Page
gray	285-435	459
blue	783-321	461
blue	777-305	461
plain	783-5501	780
transparent	210-612	783
orange	782-300	462



## Disconnect/Test Terminal Blocks with a Pivoting Knife Disconnect, 280 Series Description and Installation

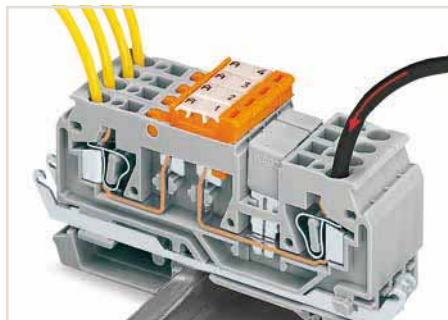

Power distribution using an adjacent jumper – knife disconnect used to disconnect individual outputs.

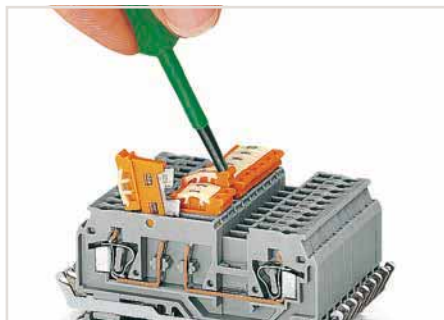

Pivoting a knife disconnect.

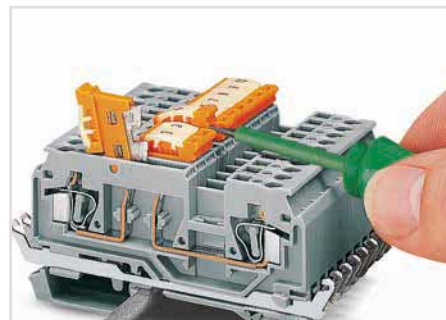

Pivoting knife disconnect clearly indicates circuit state by defined, notched positions "ON" <—> "OFF."

5

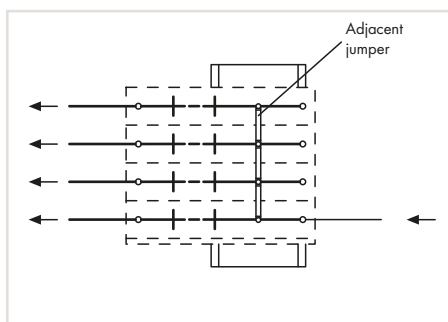

Diagram of the assembly as shown in the picture above.



Power distribution using disconnect link in supply line – disconnection of all outputs.

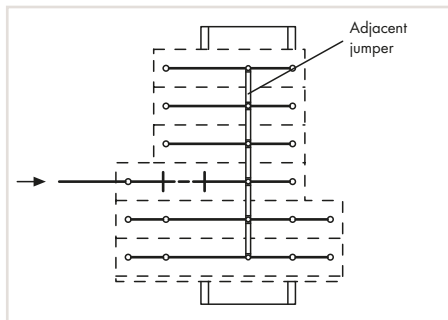
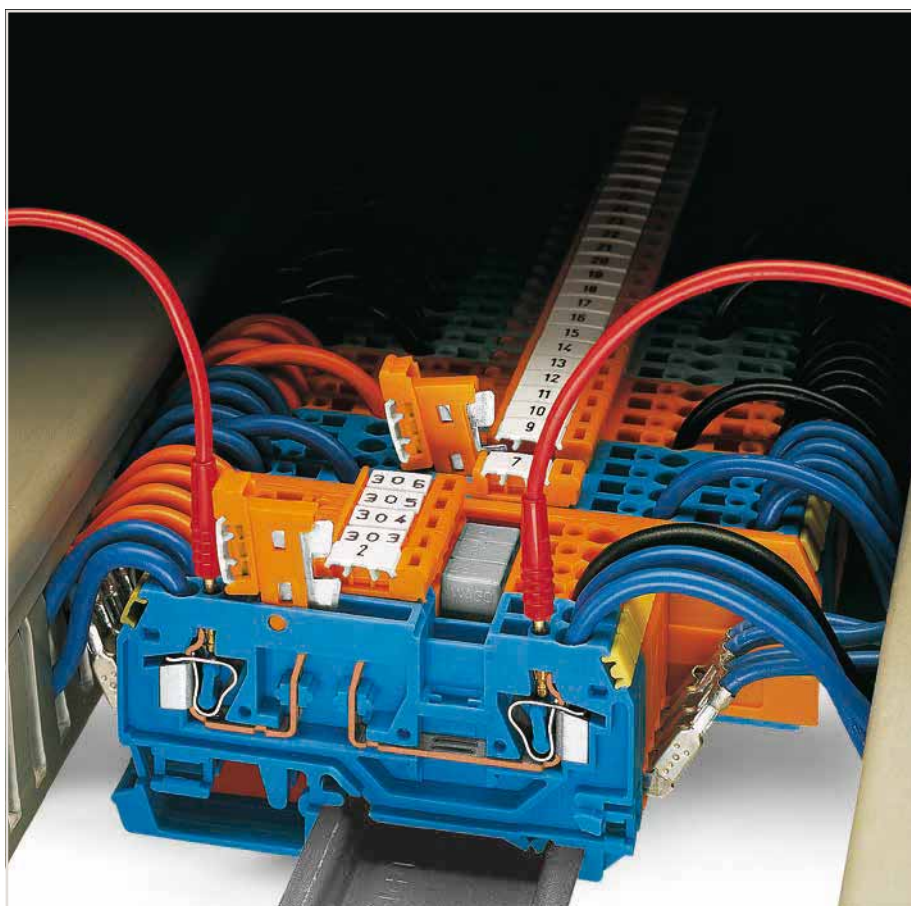

Diagram of the assembly as shown in the picture above.



Staggered jumpers for sophisticated circuit requirements – push jumpers down until fully inserted.

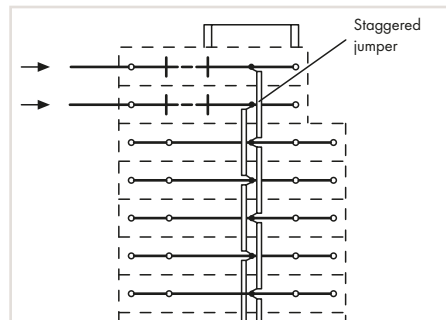
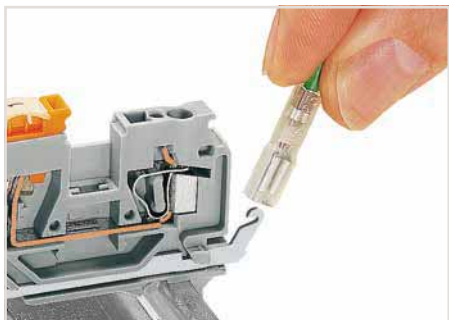

Diagram of the assembly as shown in the picture above.





Shield contact via (2.5 x 0.8) mm solder/crimp quick disconnect terminal



Testing with voltage tester.



Terminal block labeling – via WMB (center position) and Mini-WSB markers (on the sides)

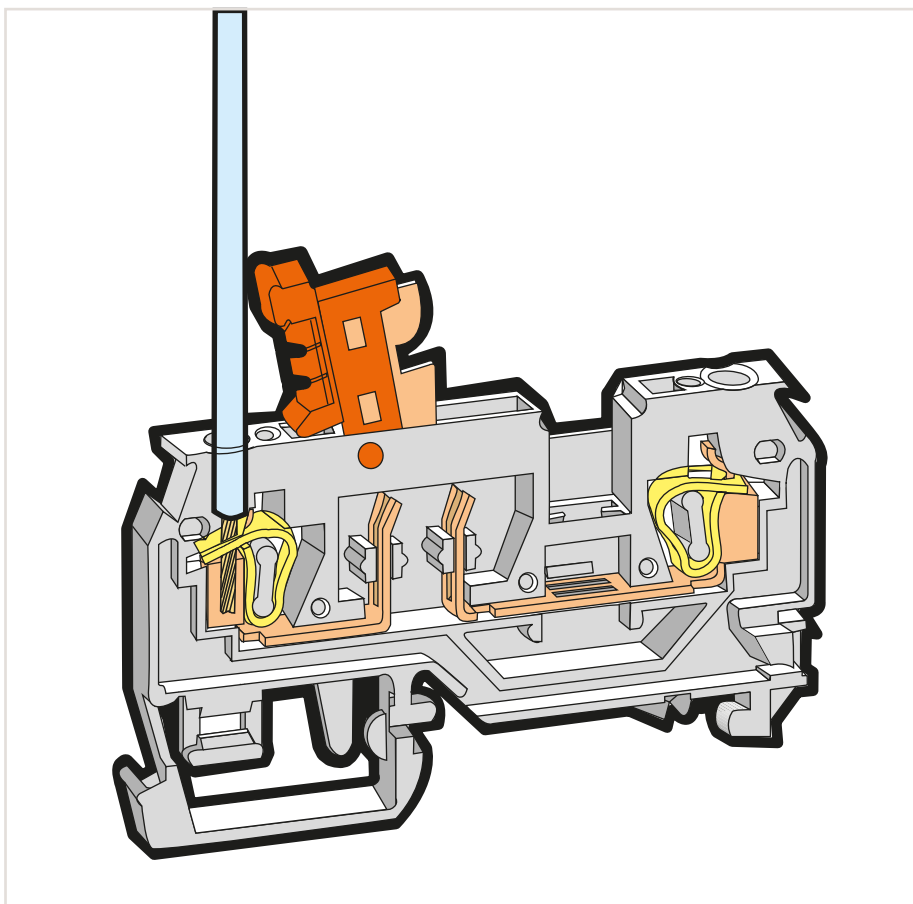

## 2- and 4-Conductor Disconnect/Test Terminal Blocks without/with Shield Contact

### 2.5 mm<sup>2</sup>, 280 Series

Terminal blocks with a blue insulated housing are suitable for Ex i applications.



2-conductor disconnect/test terminal block, with test slots for 2 and 2.3 mm Ø test plugs, with pivoting knife disconnect, orange disconnect link

Color	Item No.	Pack. Unit
○ gray	280-870	100

#### Gray disconnect link

Color	Item No.	Pack. Unit
○ gray	280-868	100

#### Orange disconnect link

Color	Item No.	Pack. Unit
● blue	280-876	100

#### Orange disconnect link

Color	Item No.	Pack. Unit
● orange	280-879	100



#### Technical Data

Rated voltage (III / 3)	400 V
Rated surge voltage (III / 3)	6 kV
Rated current	16 A
Approval	600 V, 15 A ; 300 V, 15 A
Nominal cross section	1 mm <sup>2</sup>

#### Connection Data

Solid conductor	0.08 ... 2.5 mm <sup>2</sup> / 28 ... 12 AWG
Fine-stranded conductor	0.08 ... 2.5 mm <sup>2</sup> / 28 ... 12 AWG
Note (conductor cross section)	12 AWG: THHN, THWN
Strip length	8 ... 9 mm / 0.31 ... 0.35 inch
Terminal block width	5 mm / 0.197 inch
Insulation material	Polyamide 66 (PA 66)

#### Accessories (Selection)

	Item No.	Page
Adjacent jumper, insulated, I <sub>N</sub> = I <sub>N</sub> terminal block	gray 280-402	440
End and intermediate plate, 2.5 mm thick	orange 280-371	443
WMB Inline, plain, 1,500 WMB markers (5 mm) per reel, 5 ... 5.2 mm stretchable	white 2009-115	780
Test plug adapter, 5 mm wide, for 210-137 Test Plug (2.3 mm Ø), for 1.5 ... 4 mm <sup>2</sup> terminal blocks	gray 280-404	460

Accessories (jumpers, end plates, test plugs, etc.), see page 440

Carrier rails and tools, see Section 13

Appropriate marking system, WMB/WMB Inline/WFB, see Full Line Catalog, Volume 6

Approvals and corresponding ratings, visit [www.wago.com](http://www.wago.com)

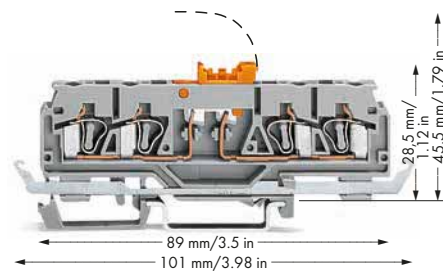
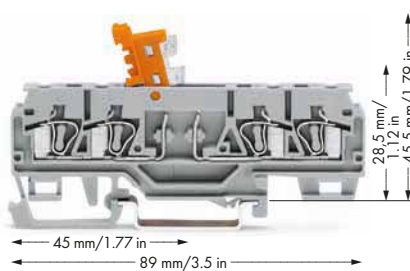
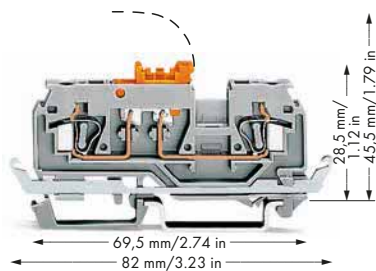

2-conductor disconnect/test terminal block with shield contact, with test slots for 2 and 2.3 mm Ø test plugs, with pivoting knife disconnect, orange disconnect link

Color	Item No.	Pack. Unit
○ gray	280-871	100

Gray disconnect link

Color	Item No.	Pack. Unit
○ gray	280-869	100

Orange disconnect link

Color	Item No.	Pack. Unit
● orange	280-880	100

4-conductor disconnect/test terminal block, with test slots for 2 and 2.3 mm Ø test plugs, with pivoting knife disconnect, orange disconnect link

Color	Item No.	Pack. Unit
○ gray	280-874	50

Gray disconnect link

Color	Item No.	Pack. Unit
○ gray	280-881	50

Orange disconnect link

Color	Item No.	Pack. Unit
● blue	280-885	50

Orange disconnect link

Color	Item No.	Pack. Unit
● orange	280-883	50

4-conductor disconnect/test terminal block with shield contact, with test slots for 2 and 2.3 mm Ø test plugs, with pivoting knife disconnect, orange disconnect link

Color	Item No.	Pack. Unit
○ gray	280-875	50

Gray disconnect link

Color	Item No.	Pack. Unit
○ gray	280-882	50

Orange disconnect link

Color	Item No.	Pack. Unit
● orange	280-884	50



250 V  
4 kV  
16 A  
600 V, 15 A ; 300 V, 15 A

0.08 ... 2.5 mm<sup>2</sup> / 28 ... 12 AWG  
0.08 ... 2.5 mm<sup>2</sup> / 28 ... 12 AWG  
12 AWG: THHN, THWN  
8 ... 9 mm / 0.31 ... 0.35 inch  
5 mm / 0.197 inch  
Polyamide 66 (PA 66)

	Item No.	Page
gray	280-402	440
orange	280-371	443
white	2009-115	780
gray	280-404	460



400 V  
6 kV  
16 A  
600 V, 15 A ; 300 V, 15 A

0.08 ... 2.5 mm<sup>2</sup> / 28 ... 12 AWG  
0.08 ... 2.5 mm<sup>2</sup> / 28 ... 12 AWG  
12 AWG: THHN, THWN  
8 ... 9 mm / 0.31 ... 0.35 inch  
5 mm / 0.197 inch  
Polyamide 66 (PA 66)

	Item No.	Page
orange	280-373	443
white	2009-115	780



250 V  
4 kV  
16 A  
600 V, 15 A ; 300 V, 15 A

0.08 ... 2.5 mm<sup>2</sup> / 28 ... 12 AWG  
0.08 ... 2.5 mm<sup>2</sup> / 28 ... 12 AWG  
12 AWG: THHN, THWN  
8 ... 9 mm / 0.31 ... 0.35 inch  
5 mm / 0.197 inch  
Polyamide 66 (PA 66)

	Item No.	Page
orange	280-373	443
white	2009-115	780

## Disconnect/Test Terminal Blocks

### 2.5 mm<sup>2</sup>, 280 Series

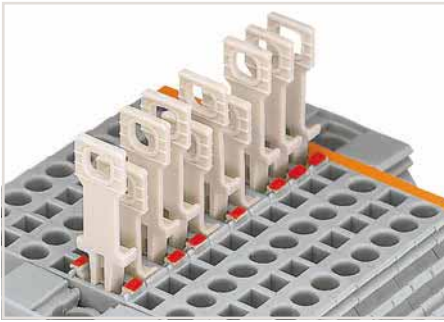

Disconnect terminal block with colored tab to indicate the switching status (red = disconnected)

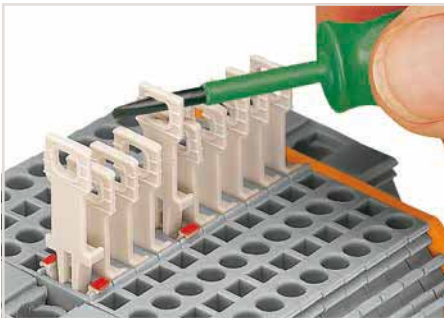

Pulling the disconnect tab via operating tool.



Pulling the disconnect tab by hand.

Terminal blocks with a blue insulated housing are suitable for Ex i applications.

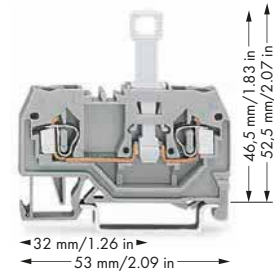

2-conductor disconnect terminal block, with disconnect tab

Color	Item No.	Pack. Unit
● gray	280-912	50
● blue	280-914	50

**WAGO**

#### Technical Data

Rated voltage (III / 3)	400 V
Rated surge voltage (III / 3)	6 kV
Rated current	10 A
Approval	300 V, 15 A <b>WAGO</b> ; 300 V, 15 A <b>CE</b>

#### Connection Data

Solid conductor	0.08 ... 2.5 mm <sup>2</sup> / 28 ... 12 AWG
Fine-stranded conductor	0.08 ... 2.5 mm <sup>2</sup> / 28 ... 12 AWG
Note (conductor cross section)	12 AWG: THHN, THWN
Strip length	8 ... 9 mm / 0.31 ... 0.35 inch
Terminal block width	5 mm / 0.197 inch
Insulation material	Polyamide 66 (PA 66)

#### Note

#### Accessories (Selection)

Comb-style jumper bar, insulated, I <sub>N</sub> = I <sub>N</sub> terminal block, gray
End and intermediate plate, 2.5 mm thick
WMB Inline, plain, 1,500 WMB markers (5 mm) per reel, 5 ... 5.2 mm stretchable
Test socket, insulated, 2 mm Ø
Disconnect lock, for disconnect tab used on disconnect terminal blocks (280/281 and 769 Series)

	Item No.	Page
2-way	280-482	440
orange	280-309	441
white	2009-115	780
red	209-107	445
red	709-170	445

Additional colors, visit [www.wago.com](http://www.wago.com)

Accessories (comb-style jumper bars, end plates, etc.), see page 440

Carrier rails and tools, see Section 13

Appropriate marking system, WMB/WMB Inline/WFB, see Full Line Catalog, Volume 6

Approvals and corresponding ratings, visit [www.wago.com](http://www.wago.com)

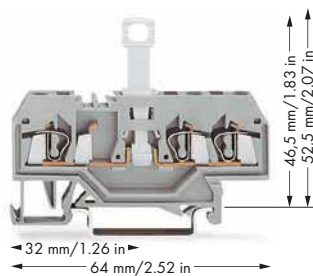

3-conductor disconnect terminal block, with disconnect tab

Color	Item No.	Pack. Unit
gray	280-683	50

UL®

400 V
6 kV
10 A
300 V, 15 A <b>UL</b> ; 300 V, 15 A <b>CE</b>

0.08 ... 2.5 mm <sup>2</sup> / 28 ... 12 AWG
0.08 ... 2.5 mm <sup>2</sup> / 28 ... 12 AWG
12 AWG: THHN, THWN
8 ... 9 mm / 0.31 ... 0.35 inch
5 mm / 0.197 inch
Polyamide 66 (PA 66)

	Item No.	Page
2-way	280-482	440
orange	280-326	441
white	2009-115	780
red	209-107	445
red	709-170	445

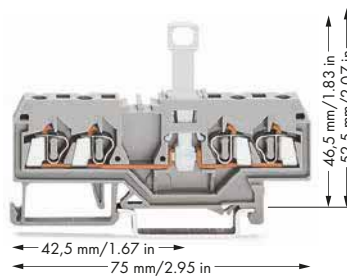

4-conductor disconnect terminal block, with disconnect tab

Color	Item No.	Pack. Unit
gray	280-836	50
blue	280-839	50

UL®

400 V
6 kV
10 A
300 V, 15 A <b>UL</b> ; 300 V, 15 A <b>CE</b>

0.08 ... 2.5 mm <sup>2</sup> / 28 ... 12 AWG
0.08 ... 2.5 mm <sup>2</sup> / 28 ... 12 AWG
12 AWG: THHN, THWN
8 ... 9 mm / 0.31 ... 0.35 inch
5 mm / 0.197 inch
Polyamide 66 (PA 66)

	Item No.	Page
2-way	280-482	440
orange	280-315	441
white	2009-115	780
red	209-107	445
red	709-170	445

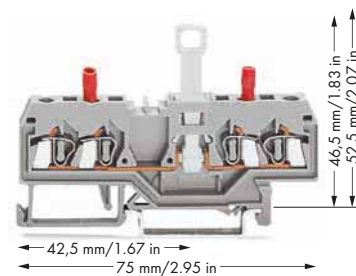

2-conductor disconnect/test terminal block, with disconnect tab, with integrated test sockets

Color	Item No.	Pack. Unit
gray	280-829	50

CE

400 V
6 kV
10 A
300 V, 15 A <b>UL</b> ; 300 V, 15 A <b>CE</b>

0.08 ... 2.5 mm <sup>2</sup> / 28 ... 12 AWG
0.08 ... 2.5 mm <sup>2</sup> / 28 ... 12 AWG
12 AWG: THHN, THWN
8 ... 9 mm / 0.31 ... 0.35 inch
5 mm / 0.197 inch
Polyamide 66 (PA 66)

Notice: This double potential terminal block cannot be commoned via adjacent jumpers.

	Item No.	Page
orange	280-315	442
white	2009-115	780
red	709-170	445

## Disconnect/Test Terminal Blocks

### 4 mm<sup>2</sup>, 281 Series

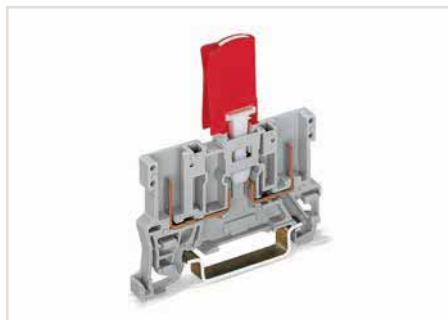

#### Double Safety:

The disconnect tab has been designed for maximum operational safety.

As soon as the disconnect tab is in the disconnect position, it can be protected against unintentional reconnection by using the disconnect lock.

Only through intentional and focused use of a tool, can the disconnect lock be removed and the circuit reconnected.

5

#### Features/Benefits:

- Easy to use
- Install/remove disconnect lock with just one hand
- Clearly identify disconnect tab position
- Higher safety
- Intentional effort is required to reconnect the circuit

Terminal blocks with a blue insulated housing are suitable for Ex i applications.

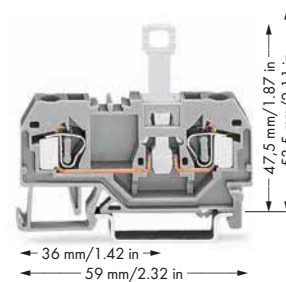

2-conductor disconnect terminal block, with disconnect tab

Color	Item No.	Pack. Unit
gray	281-912	50

WAGO

#### Technical Data

Rated voltage (III / 3)	400 V
Rated surge voltage (III / 3)	6 kV
Rated current	10 A
Approval	300 V, 15 A <b>W</b> ; 300 V, 15 A <b>E</b>

#### Connection Data

Solid conductor	0.08 ... 4 mm <sup>2</sup> / 28 ... 12 AWG
Fine-stranded conductor	0.08 ... 4 mm <sup>2</sup> / 28 ... 12 AWG
Strip length	9 ... 10 mm / 0.35 ... 0.39 inch
Terminal block width	6 mm / 0.236 inch
Insulation material	Polyamide 66 (PA 66)

#### Accessories (Selection)

Comb-style jumper bar, insulated, I <sub>N</sub> = I <sub>N</sub> terminal block, gray
End and intermediate plate, 2.5 mm thick
WMB Inline, plain, 1,500 WMB markers (5 mm) per reel, 5 ... 5.2 mm stretchable
Test socket, insulated, 2 mm Ø
Disconnect lock, for disconnect tab used on disconnect terminal blocks (280/281 and 769 Series)

	Item No.	Page
2-way	281-482	447
orange	281-329	448
white	2009-115	780
red	209-107	451
red	709-170	451

Accessories (comb-style jumper bars, end plates, etc.), see page 447

Carrier rails and tools, see Section 13

Appropriate marking system, WMB/WMB Inline/WFB, see Full Line Catalog, Volume 6

Approvals and corresponding ratings, visit [www.wago.com](http://www.wago.com)



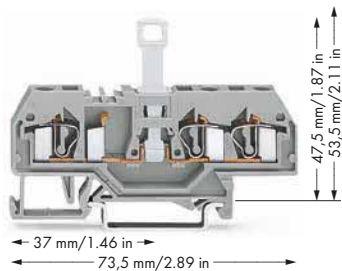

3-conductor disconnect terminal block, with disconnect tab

Color	Item No.	Pack. Unit
gray	281-683	50



400 V  
6 kV  
10 A  
300 V, 15 A **UL**; 300 V, 15 A **CE**

0.08 ... 4 mm<sup>2</sup> / 28 ... 12 AWG  
0.08 ... 4 mm<sup>2</sup> / 28 ... 12 AWG  
9 ... 10 mm / 0.35 ... 0.39 inch  
6 mm / 0.236 inch  
Polyamide 66 (PA 66)

	Item No.	Page
2-way	281-482	447
orange	281-326	448
white	2009-115	780
red	209-107	451
red	709-170	451

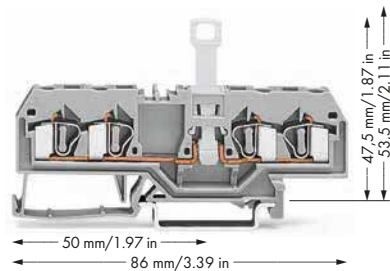

4-conductor disconnect terminal block, with disconnect tab

Color	Item No.	Pack. Unit
gray	281-659	50
blue	281-660	50



400 V  
6 kV  
10 A  
300 V, 15 A **UL**; 300 V, 15 A **CE**

0.08 ... 4 mm<sup>2</sup> / 28 ... 12 AWG  
0.08 ... 4 mm<sup>2</sup> / 28 ... 12 AWG  
9 ... 10 mm / 0.35 ... 0.39 inch  
6 mm / 0.236 inch  
Polyamide 66 (PA 66)

	Item No.	Page
2-way	281-482	447
orange	281-335	448
white	2009-115	780
red	209-107	451
red	709-170	451

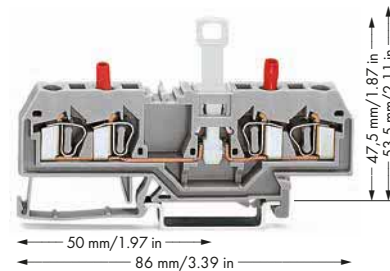

2-conductor disconnect/test terminal block, with disconnect tab, with integrated test sockets

Color	Item No.	Pack. Unit
gray	281-666	100



400 V  
6 kV  
10 A  
300 V, 15 A **UL**; 300 V, 15 A **CE**

0.08 ... 4 mm<sup>2</sup> / 28 ... 12 AWG  
0.08 ... 2.5 mm<sup>2</sup> / 28 ... 12 AWG  
9 ... 10 mm / 0.35 ... 0.39 inch  
6 mm / 0.236 inch  
Polyamide 66 (PA 66)

	Item No.	Page
orange	281-335	448
white	2009-115	780
red	709-170	451

## Disconnect/Test Terminal Blocks for Transformer Circuits, 282 Series Description and Installation



Inserting insulated, touch-proof adjacent jumpers into the protected shorting position.



Terminal strip permanently prepared for current transformer circuits.

5



Lock-out snaps into one of two notched positions, preventing accidental operation of the disconnect link.

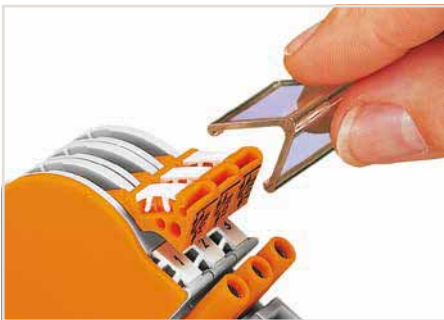

Snapping a transparent locking cover onto 1–8 disconnect links:  
a) Mechanically lock several links for multi-pole switching applications  
b) Protect markers

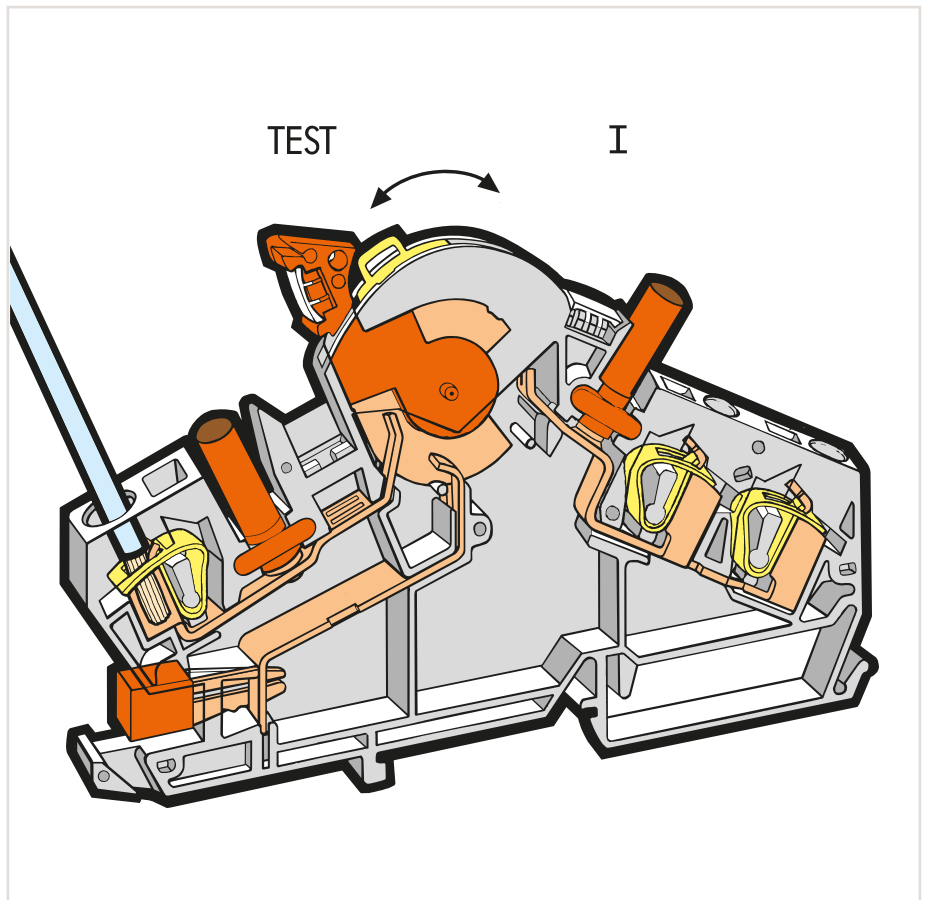

Interlocking link mechanically locks multiple links for multi-pole switching applications.

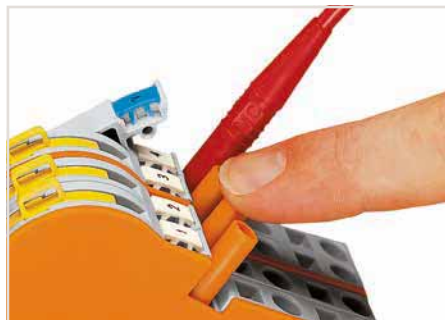

Touch-proof test sockets for touch-proof 4 mm Ø test plugs (not available from WAGO, but are offered by industry suppliers such as, Fabrikat Multi-Contact)



Labeling via WMB Multi Marking System. For other systems, see Section 13.

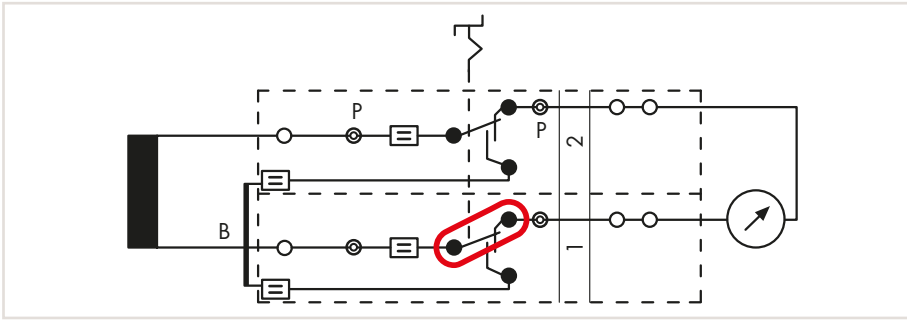

**Disconnect link in notched "I" position**  
 In "I" operating position, the measurement device is connected to the transformer.  
 B = shorting jumper, P = test socket

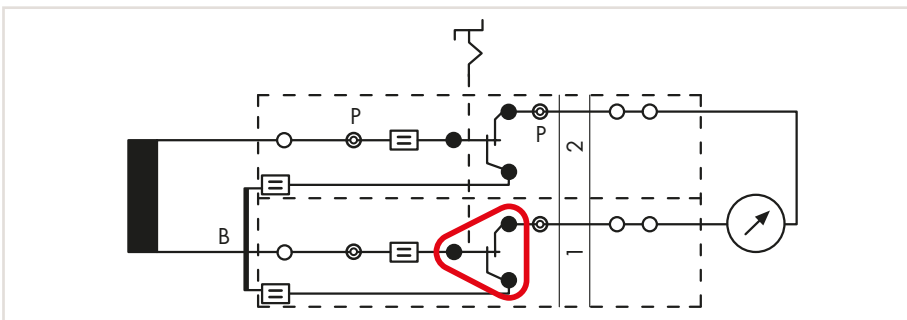
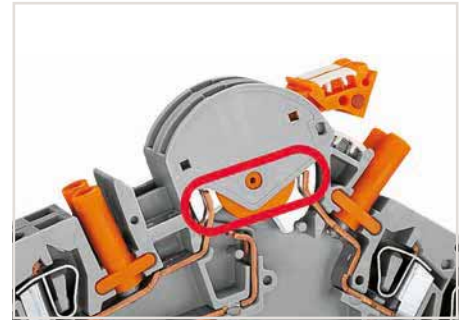

**Disconnect link in transition from "I" to "TEST" (terminal blocks 1 + 2)**  
 The transformer is not disconnected from the measurement device, yet the shorting path is activated by moving the disconnect link from "I" to "TEST."

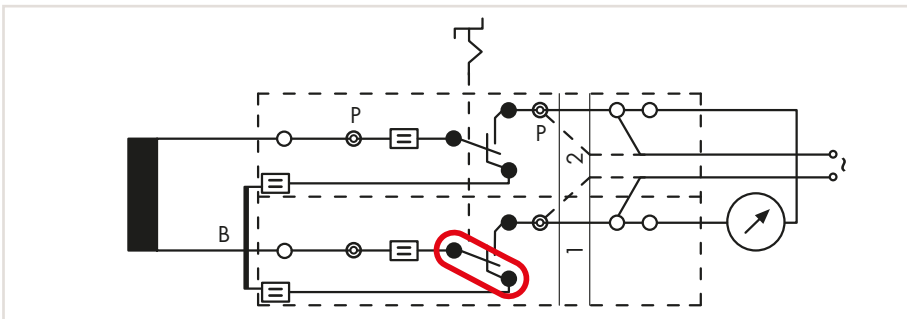
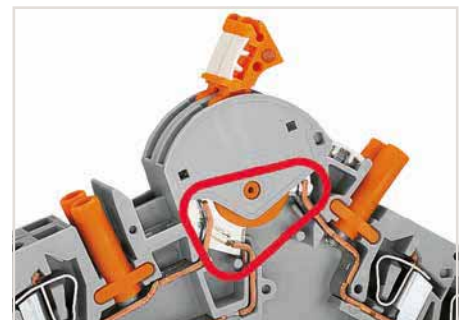

**Disconnect link in notched "TEST" position (terminal blocks 1 + 2)**  
 The measurement device/relay is electrically disconnected from the transformer. If required, external voltage can be applied to the measurement device/relay via the test socket, or the 2nd CAGE CLAMP® connection.

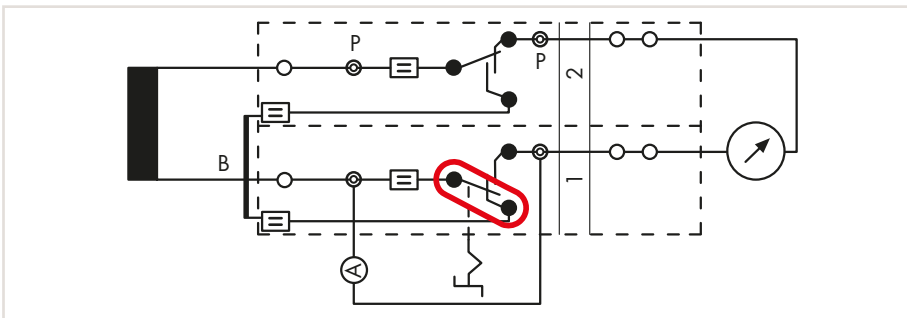
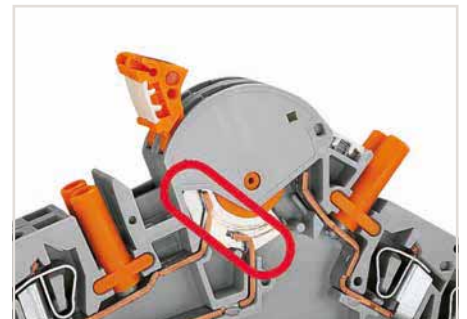

**Disconnect link in notched "I" position (terminal block 2)**  
**Disconnect link in notched "TEST" position (terminal block 1) – measurement testing**  
 Before moving the disconnect link of terminal block 1 into the notched "TEST" position, the reference current meter must be inserted into the test socket of terminal block 1.

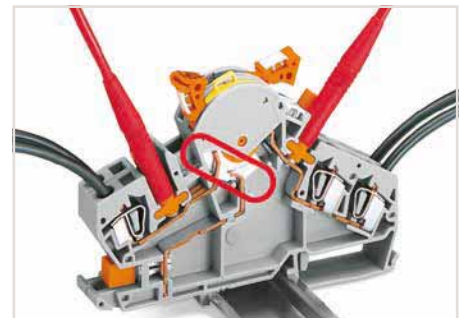

5

## Circuit Configuration Examples

5

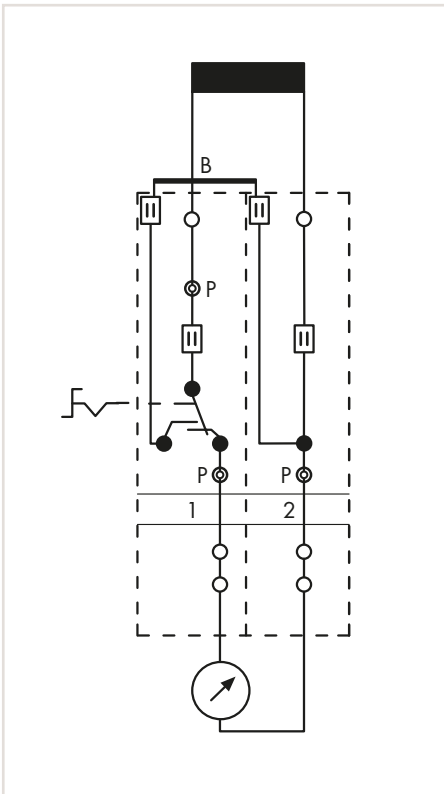

Measuring set for a single-phase current transformer (without measurement testing)



Terminal blocks required:  
 1 x disconnect/test terminal block (282-870)  
 1 x through terminal block (282-865)  
 1 x jumper, orange (282-424)  
 1 x end plate, orange (282-386)  
 In addition: locking cover, lock-out

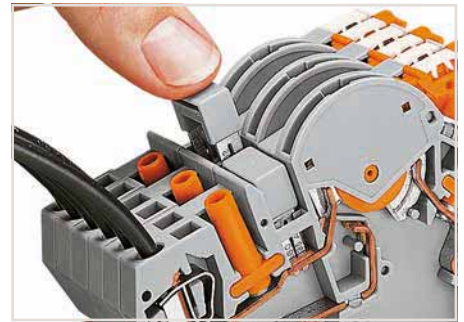

Additional commoning possible with circuit-related adjacent jumpers or testing option via test plug adapter (209-170) on transformer side.

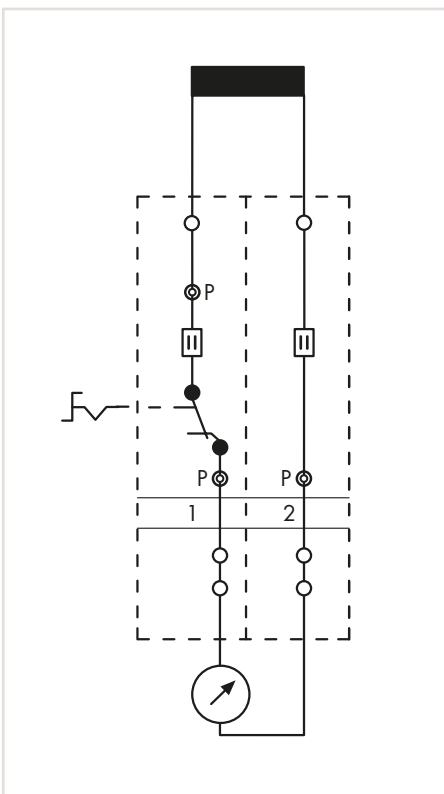

Measuring set for a single-phase voltage transformer



Terminal blocks required:  
 1 x disconnect/test terminal block (282-860)  
 1 x through terminal block (282-866)  
 1 x end plate, orange (282-386)  
 In addition: locking cover, lock-out



A lock-out seal can be used on the disconnect link in notched "I" position.



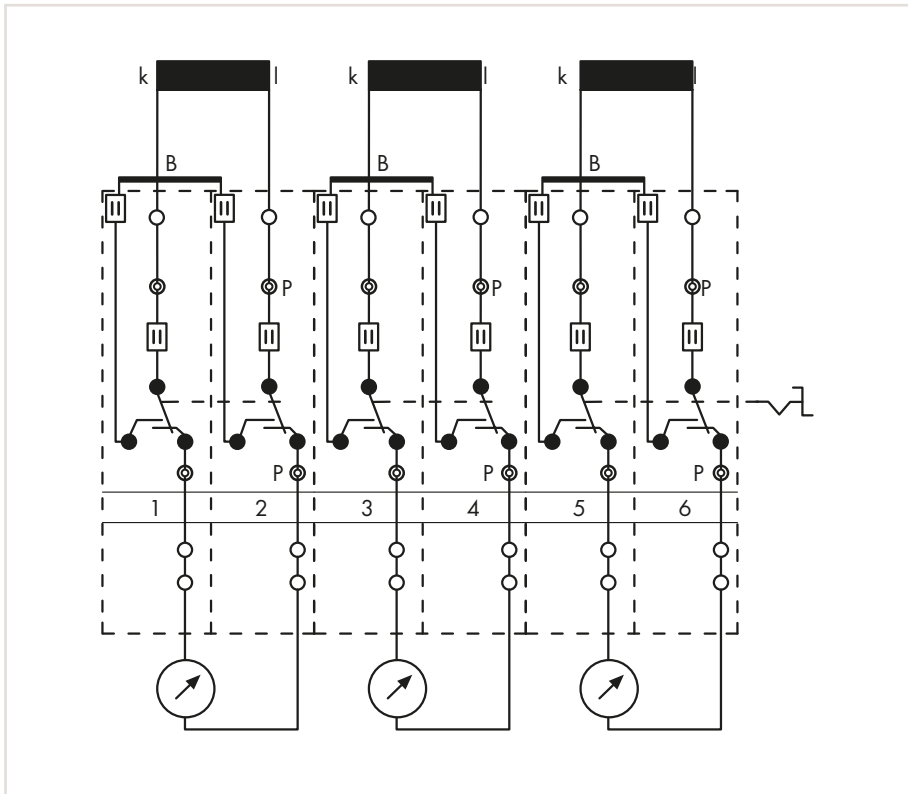

**Measuring set for a three-phase current transformer**

Pairs of disconnect links are interconnected via interlocking link or locking cover. Measurement testing is performed after the interlocking is released.

B = shorting jumper, P = test socket

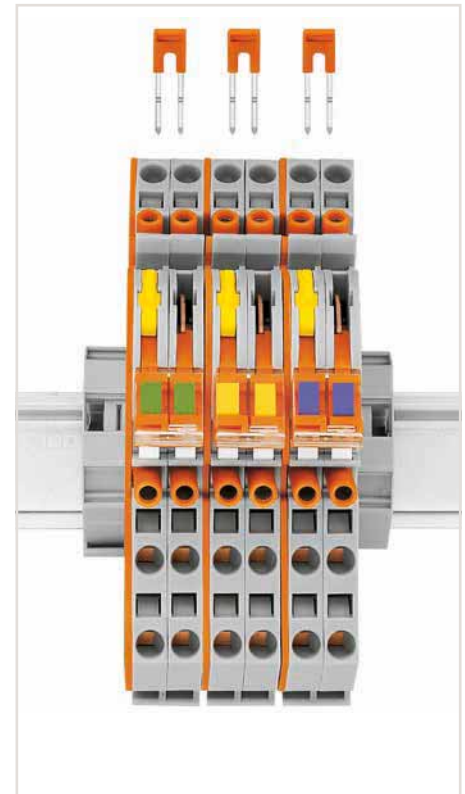

**Terminal blocks required:**

- 6 x disconnect/test terminal block (282-870)
  - 3 x jumper, orange (282-424)
  - 3 x end plate, orange (282-386)
- In addition: interlocking link, locking cover, lock-out

5

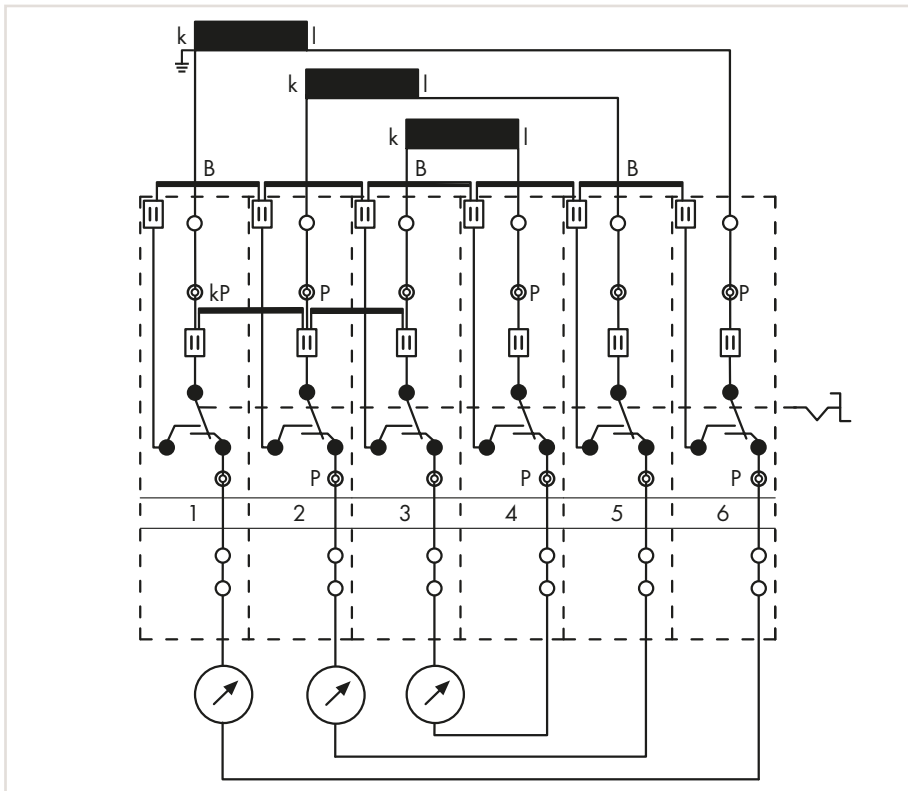

**Measuring set for a three-phase current transformer with 'Y' point**

All six disconnect links are interconnected via interlocking link.

kP = 'Y' point jumper



**Terminal blocks required:**

- 6 x disconnect/test terminal block (282-870)
  - 5 x jumper, orange (282-424)
  - 2 x jumper, gray (282-402)
  - 1 x end plate, orange (282-386)
- In addition: interlocking link, locking cover, lock-out

# Disconnect/Test Terminal Blocks, 30 A, Through Terminal Blocks for Current and Voltage Transformer Circuits 6 mm<sup>2</sup>, 282 Series

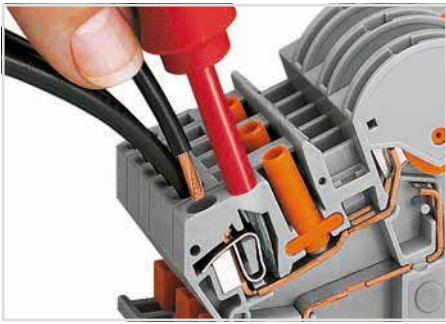

**CAGE CLAMP® connection**  
Inserting a conductor via operating tool (5.5 x 0.8 mm blade).



Additional CAGE CLAMP® connection on the measurement device side, e.g., when connecting wire commoning chains or applying an external voltage.

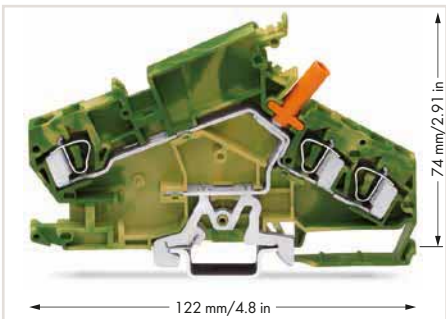

Ground conductor terminal block (282-868)

For operating stickers, please refer to our online catalog:  
for 282-870 (Item No. 210-412)  
for 282-865 (Item No. 210-415)  
for 282-860 (Item No. 210-414)  
for 282-866 (Item No. 210-413)

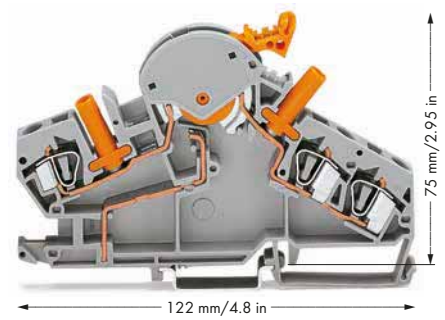

Disconnect/test terminal block, with touch-proof test sockets, for 4 mm Ø test plugs, e.g., for current transformer circuits, orange disconnect link

Color	Item No.	Pack. Unit
○ gray	282-870	20



### Technical Data

Ratings per	
Rated voltage (III / 3)	500 V
Rated surge voltage (III / 3)	6 kV
Rated current	30 A
Approval	600 V, 30 A  300 V, 5 A

### Connection Data

Solid conductor	0.2 ... 6 mm <sup>2</sup> / 24 ... 10 AWG
Fine-stranded conductor	0.2 ... 6 mm <sup>2</sup> / 24 ... 10 AWG
Strip length	12 ... 13 mm / 0.47 ... 0.51 inch
Terminal block width	8 mm / 0.315 inch
Insulation material	Polyamide 66 (PA 66)

### Note

92 mm / 3.62 inch max. height when rotating the disconnect link (incl. locking cover)

### Accessories (Selection)

Adjacent jumper, insulated, I <sub>N</sub> 41 A	
Adjacent jumper, insulated, I <sub>N</sub> 41 A	
End and separator plate, 1.5 mm thick, without lock-out seal option	
End and separator plate, 1.5 mm thick, with lock-out seal option	
End and separator plate, 1.5 mm thick	
WMB Multi marking system, white, 10 strips with 10 markers per card, 5 ... 5.2 mm stretchable	
Group marker carrier, angled, e.g., for transformer terminal blocks (282 Series)	

	Item No.	Page
orange	282-424	358
gray	282-402	358
orange	282-386	358
orange	282-387	358
plain	793-5501	780
gray	209-144	359

Accessories for transformer terminal blocks, see page 358

Carrier rails and tools, see Section 13

Appropriate marking system, WMB/WMB Inline, see Full Line Catalog, Volume 6

Approvals and corresponding ratings, visit [www.wago.com](http://www.wago.com)

5



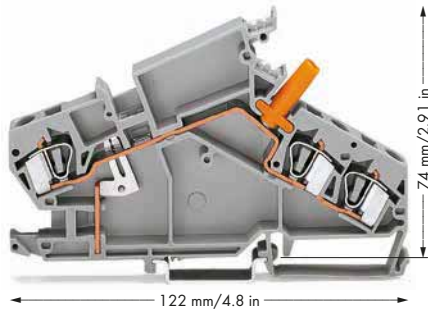

Through terminal block, with touch-proof test socket, for 4 mm Ø test plugs, e.g., for current transformer circuits

Color	Item No.	Pack. Unit
○ gray	282-865	20



IEC/EN 60947-7-1

500 V

6 kV

30 A

600 V, 30 A ; 300 V, 5 A

0.2 ... 6 mm<sup>2</sup> / 24 ... 10 AWG

0.2 ... 6 mm<sup>2</sup> / 24 ... 10 AWG

12 ... 13 mm / 0.47 ... 0.51 inch

8 mm / 0.315 inch

Polyamide 66 (PA 66)

	Item No.	Page
gray	282-402	358
orange	282-385	
plain	793-5501	780
gray	209-144	359

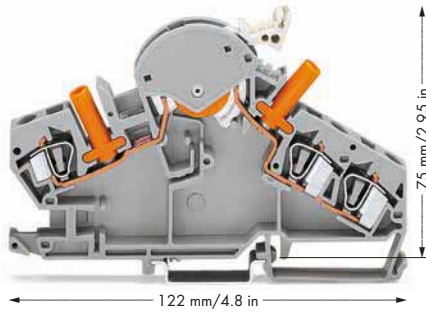

Disconnect/test terminal block, with touch-proof test sockets, for 4 mm Ø test plugs, e.g., for voltage transformer circuits, disconnect link, light gray

Color	Item No.	Pack. Unit
○ gray	282-860	20



IEC/EN 60947-7-1

500 V

6 kV

30 A

600 V, 30 A ; 300 V, 5 A

0.2 ... 6 mm<sup>2</sup> / 24 ... 10 AWG

0.2 ... 6 mm<sup>2</sup> / 24 ... 10 AWG

12 ... 13 mm / 0.47 ... 0.51 inch

8 mm / 0.315 inch

Polyamide 66 (PA 66)

92 mm / 3.62 inch max. height when rotating the disconnect link (incl. locking cover)

	Item No.	Page
gray	282-402	358
orange	282-386	358
orange	282-387	358
plain	793-5501	780
gray	209-144	359

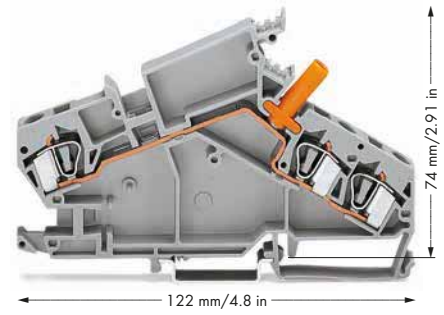

Through terminal block, with touch-proof test socket, for 4 mm Ø test plugs, e.g., for voltage transformer circuits

Color	Item No.	Pack. Unit
○ gray	282-866	20



IEC/EN 60947-7-1

500 V

6 kV

30 A

600 V, 30 A ; 300 V, 5 A

0.2 ... 6 mm<sup>2</sup> / 24 ... 10 AWG

0.2 ... 6 mm<sup>2</sup> / 24 ... 10 AWG

12 ... 13 mm / 0.47 ... 0.51 inch

8 mm / 0.315 inch

Polyamide 66 (PA 66)

	Item No.	Page
gray	282-402	358
orange	282-385	358
plain	793-5501	780
gray	209-144	359

## Ground Conductor Terminal Blocks for Current and Voltage Transformer Circuits

### 6 mm<sup>2</sup>, 282 Series

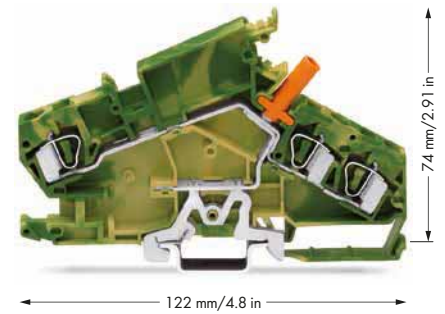

Ground conductor terminal block, with touch-proof test socket, for 4 mm Ø test plugs, e.g., for voltage transformer circuits

Color	Item No.	Pack. Unit
● green-yellow	282-868	20

UL®

#### Technical Data

Ratings per	
Connection Data	
Solid conductor	
Fine-stranded conductor	
Strip length	
Terminal block width	
Insulation material	

IEC/EN 60947-7-2
0.2 ... 6 mm <sup>2</sup> / 24 ... 10 AWG
0.2 ... 6 mm <sup>2</sup> / 24 ... 10 AWG
12 ... 13 mm / 0.47 ... 0.51 inch
8 mm / 0.315 inch
Polyamide 66 (PA 66)

#### Accessories (Selection)

Adjacent jumper, insulated, I <sub>N</sub> 41 A
End and separator plate, 1.5 mm thick
WMB Multi marking system, white, 10 strips with 10 markers per card, 5 ... 5.2 mm stretchable
Group marker carrier, angled, e.g., for transformer terminal blocks (282 Series)

	Item No.	Page
gray	282-402	358
orange	282-385	358
plain	793-5501	780
gray	209-144	359

5

Accessories for transformer terminal blocks, see page 358

Carrier rails and tools, see Section 13

Appropriate marking system, WMB/WMB Inline, see Full Line Catalog, Volume 6

Approvals and corresponding ratings, visit [www.wago.com](http://www.wago.com)



## Accessories: Disconnect/Test Terminal Blocks for Current and Voltage Transformer Circuits

### Commoning, Mounting and Marking



Adjacent jumper, insulated, I <sub>N</sub> 41 A			
Suitable for:	Color	Item No.	Pack. Unit
282-870	orange	282-424	100 (25)



Adjacent jumper, insulated, I <sub>N</sub> 41 A			
Color		Item No.	Pack. Unit
gray		282-402	100 (25)
yellow-green		282-422	100 (25)



Alternate jumper, insulated, I <sub>N</sub> 41 A			
Color		Item No.	Pack. Unit
gray		282-409	100 (25)

5



Wire commoning chain, insulated, 4 connections, 3 x 110 mm, I <sub>N</sub> 24 A			
Color		Item No.	Pack. Unit
black		709-110	1



Wire commoning chain, insulated, 3 connections, 2 x 120 mm, I <sub>N</sub> 24 A			
Color		Item No.	Pack. Unit
black		709-111	1



Wire commoning chain, insulated, 3 connections, 2 x 170 mm, I <sub>N</sub> 24 A			
Color		Item No.	Pack. Unit
black		709-112	1



End and separator plate, 1.5 mm thick, without lock-out seal option			
Suitable for:	Color	Item No.	Pack. Unit
282-870	orange	282-386	50 (10)
282-860	gray	282-391	50 (10)



End and separator plate, 1.5 mm thick, with lock-out seal option			
Suitable for:	Color	Item No.	Pack. Unit
282-870	orange	282-387	50 (10)
282-860	gray	282-392	50 (10)



End and separator plate, 1.5 mm thick			
Suitable for:	Color	Item No.	Pack. Unit
282-865	orange	282-385	50 (10)
282-866	gray	282-390	50 (10)
282-868			

## Accessories: Disconnect/Test Terminal Blocks for Current and Voltage Transformer Circuits

### Commoning, Mounting and Marking



Lock-out device, for disconnect link		
Color	Item No.	Pack. Unit
yellow	282-384	100 (20)



Locking cover, mechanically locks multiple links, transparent		
	Item No.	Pack. Unit
1-pole	282-881	50 (10)
2-pole	282-882	50 (10)
3-pole	282-883	50 (10)
4-pole	282-884	50 (10)
5-pole	282-885	50 (10)
6-pole	282-886	50 (10)
7-pole	282-887	50 (10)
8-pole	282-888	50 (10)



Interlocking link, mechanically locks multiple links, 1 m long		
Color	Item No.	Pack. Unit
transparent	210-254	1

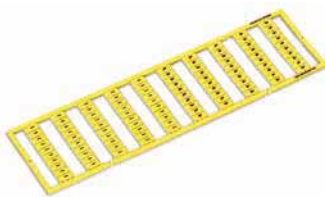

WMB Multi marking system, yellow, 10 strips with 10 markers per card, for 5 ... 17.5 mm terminal block width		
Marking	Item No.	Pack. Unit
k/I (50x each)	794-5553/000-002	5

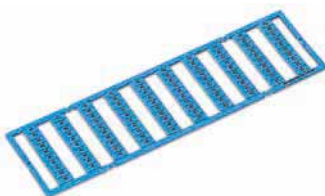

WMB Multi marking system, blue, 10 strips with 10 markers per card, for 5 ... 17.5 mm terminal block width		
Marking	Item No.	Pack. Unit
U/V (50x each)	794-5554/000-006	5



Group marker carrier, angled, e.g., for transformer terminal blocks (282 Series)		
Color	Item No.	Pack. Unit
gray	209-144	50 (25)

# Transverse Switching Terminal Blocks and Longitudinal Switching Disconnect Terminal Blocks, 282 Series

## Description and Installation



Transverse switching terminal blocks  
 Left: Adjacent jumper for commoning of switching lever  
 Right: Commoning with orange jumper

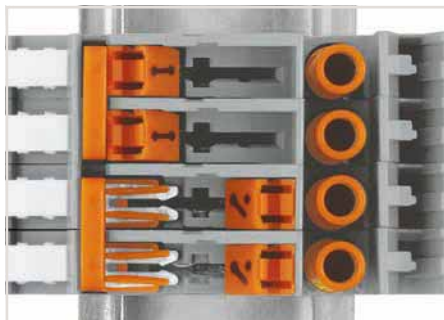

Left: closed  
 Right: open

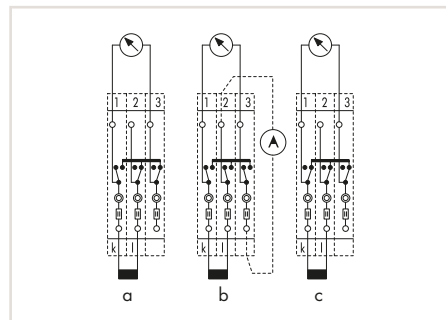

Current transformer circuit with transverse switching terminal blocks  
 a = Normal operation b = Measured value test  
 c = Transformer short circuit

5



Testing via touch-proof 4 mm Ø test plugs (not available from WAGO, but offered by industry suppliers such as, Multi-Contact Deutschland GmbH).

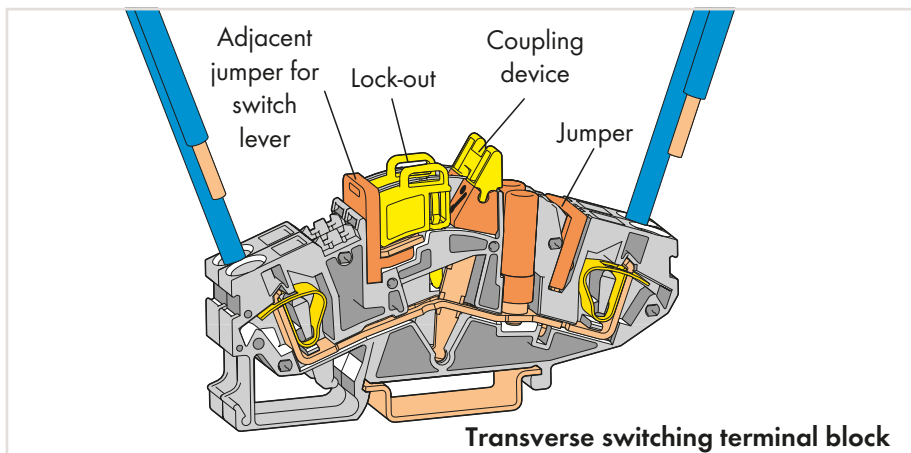

CAGE CLAMP® connection  
 Inserting a conductor via screwdriver.

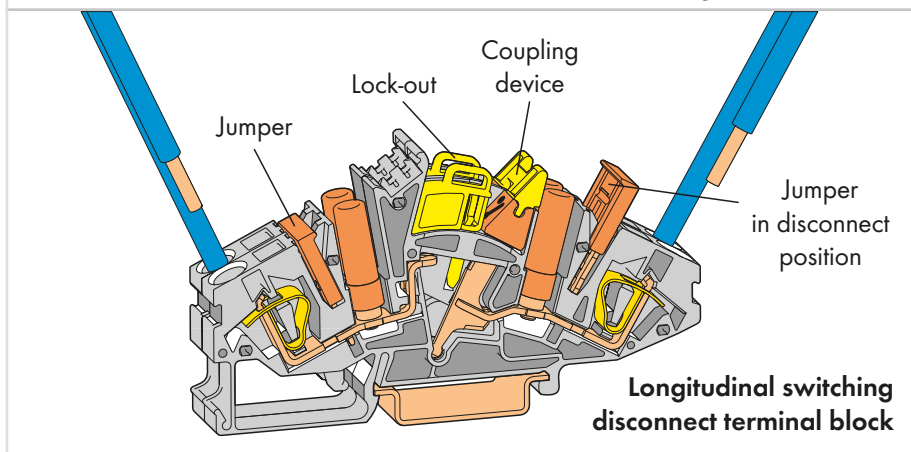

Inserting a lock-out.

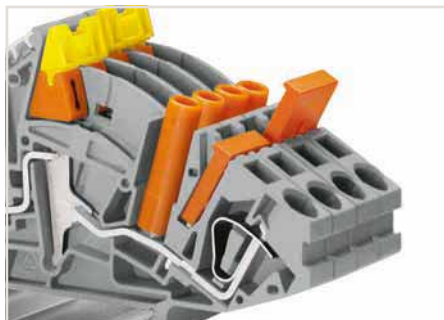

Longitudinal switching disconnect terminal blocks

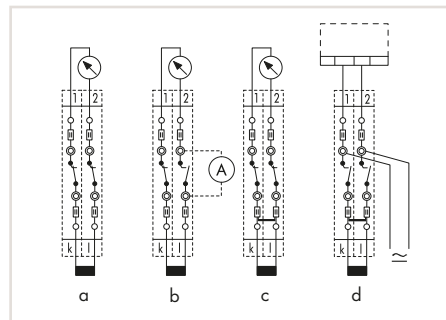

Current transformer circuit with longitudinal switching disconnect terminal blocks  
 a = Normal operation b = Measured value test  
 c = Transformer short circuit d = Relay test



## Accessories: Transverse Switching Terminal Blocks and Longitudinal Switching Disconnect Terminal Blocks Commoning and Mounting



Circuit jumper, insulated, I <sub>N</sub> 30 A, orange			
Suitable for:		Item No.	Pack. Unit
282-811	2-way	282-442	50 (10)
	3-way	282-443	50 (10)
	4-way	282-444	50 (10)
	5-way	282-445	50 (10)
	6-way	282-446	50 (10)



Jumper, insulated, I <sub>N</sub> 30 A, orange		
	Item No.	Pack. Unit
2-way	282-432	50 (10)
3-way	282-433	50 (10)
4-way	282-434	50 (10)
5-way	282-435	50 (10)
6-way	282-436	50 (10)
7-way	282-437	50 (10)
8-way	282-438	50 (10)
9-way	282-439	50 (10)
10-way	282-440	50 (10)



Jumper with safety lid, insulated, I <sub>N</sub> 30 A, orange		
	Item No.	Pack. Unit
2-way	282-432/100-000	50 (10)
3-way	282-433/100-000	50 (10)
4-way	282-434/100-000	50 (10)



Jumper, insulated, I <sub>N</sub> 30 A, orange		
	Item No.	Pack. Unit
1-3-5	282-435/011-000	50 (10)
1-4-5	282-435/301-000	50 (10)
1-2-4-6	282-436/301-000	50 (10)
1-4-6	282-436/304-000	50 (10)
1-3-5-7	282-437/011-000	50 (10)
1-4-7	282-437/012-000	50 (10)
1-2-5-8	282-438/300-000	50 (10)
1-4-7-8	282-438/301-000	50 (10)
1-3-5-7-9	282-439/011-000	50 (10)



End and separator plate, 1.5 mm thick			
Suitable for:	Color	Item No.	Pack. Unit
282-811	orange	282-366	50 (10)
	gray	282-361	50 (10)



End and separator plate, 1.5 mm thick, with lock-out seal option			
Suitable for:	Color	Item No.	Pack. Unit
282-821	orange	282-365	50 (10)
	gray	282-360	50 (10)



Lock-out device, for disconnect link		
Color	Item No.	Pack. Unit
yellow	282-370	100 (25)



Coupling device, mechanically locks multiple links		
	Item No.	Pack. Unit
2-way	282-372	50 (10)
3-way	282-373	50 (10)
4-way	282-374	50 (10)

## Transverse Switching Terminal Blocks and Longitudinal Switching Disconnect Terminal Blocks, Through Terminal Blocks (e.g., for Current Transformer Circuits) 6 mm<sup>2</sup>, 282 Series

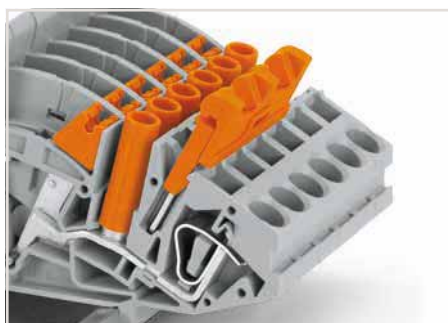

Jumper with safety lid in pre-locked position

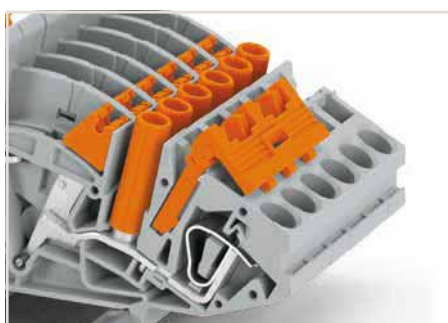

Longitudinal switching disconnect terminal blocks with inserted jumper, including safety lid



Jumper with raised safety lid



Removing a jumper via safety lid.

For operating stickers, please refer to our online catalog:  
for 282-811 (Item No. 210-424)  
for 282-821 (Item No. 210-423)



Transverse switching terminal block, with touch-proof test socket, for 4 mm Ø test plug

Color	Item No.	Pack. Unit
○ gray	282-811	20

**UL**

### Technical Data

Ratings per	
Rated voltage (III / 3)	500 V
Rated surge voltage (III / 3)	6 kV
Rated current	30 A
Approval	600 V, 30 A <b>UL</b> ; 300 V, 36 A <b>CE</b>

### Connection Data

Solid conductor	0.2 ... 6 mm <sup>2</sup> / 24 ... 10 AWG
Fine-stranded conductor	0.2 ... 6 mm <sup>2</sup> / 24 ... 10 AWG
Strip length	12 ... 13 mm / 0.47 ... 0.51 inch
Terminal block width	8 mm / 0.315 inch
Insulation material	Polyamide 66 (PA 66)

### Note

45 mm / 1.77 inch max. height when rotating the disconnect link (incl. locking cover)

### Accessories (Selection)

	Item No.	Page
Circuit jumper, insulated, I <sub>N</sub> 30 A	282-442	361
Jumper, insulated, I <sub>N</sub> 30 A, orange	282-432	361
End and separator plate, 1.5 mm thick	orange 282-366	361
End and separator plate, 1.5 mm thick	plain 793-5501	780
WMB Multi marking system, white, 10 strips with 10 markers per card, 5 ... 5.2 mm stretchable	k/l (50x each) 794-5553/000-002	359
WMB Multi marking system, yellow, 10 strips with 10 markers per card, for 5 ... 17.5 mm terminal block width	U/V (50x each) 794-5554/000-006	359
WMB Multi marking system, blue, 10 strips with 10 markers per card, for 5 ... 17.5 mm terminal block width	gray 282-369	460
Collective jumper carrier, for DIN-35 rail, compatible with jumpers for transverse switching terminal block (282-811) and longitudinal switching disconnect terminal block (282-821)		

Accessories for transverse switching terminal blocks and longitudinal switching disconnect terminal blocks, see page 361

Carrier rails and tools, see Section 13

Appropriate marking system, WMB/WMB Inline, see Full Line Catalog, Volume 6

Approvals and corresponding ratings, visit [www.wago.com](http://www.wago.com)

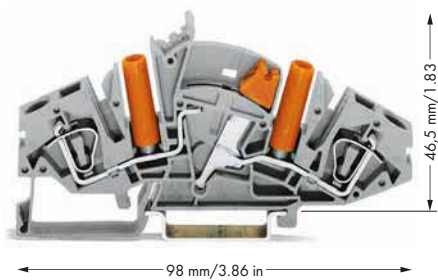

Longitudinal switching disconnect terminal block, with touch-proof test sockets, for 4 mm Ø test plugs

Color	Item No.	Pack. Unit
○ gray	282-821	20



IEC/EN 60947-7-1  
 500 V  
 6 kV  
 30 A  
 600 V, 30 A ; 300 V, 36 A

0.2 ... 6 mm<sup>2</sup> / 24 ... 10 AWG  
 0.2 ... 6 mm<sup>2</sup> / 24 ... 10 AWG  
 12 ... 13 mm / 0.47 ... 0.51 inch  
 8 mm / 0.315 inch  
 Polyamide 66 (PA 66)

45 mm / 1.77 inch max. height when rotating the disconnect link (incl. locking cover)

	Item No.	Page
2-way	282-432	361
orange	282-365	361
plain	793-5501	780
k/l (50x each)	794-5553/000-002	359
U/V (50x each)	794-5554/000-006	359
gray	282-369	460

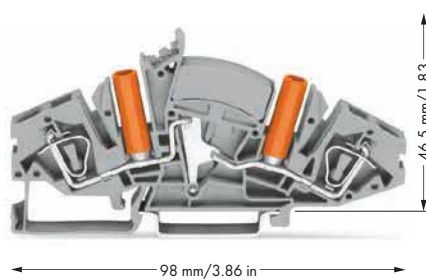

2-conductor through terminal block, with touch-proof test sockets, for 4 mm Ø test plugs

Color	Item No.	Pack. Unit
○ gray	282-841	20



500 V  
 6 kV  
 30 A

0.2 ... 6 mm<sup>2</sup> / 24 ... 10 AWG  
 0.2 ... 6 mm<sup>2</sup> / 24 ... 10 AWG  
 12 ... 13 mm / 0.47 ... 0.51 inch  
 8 mm / 0.315 inch  
 Polyamide 66 (PA 66)

	Item No.	Page
2-way	282-432	361
orange	282-365	361
plain	793-5501	780
k/l (50x each)	794-5553/000-002	359
U/V (50x each)	794-5554/000-006	359
gray	282-369	460

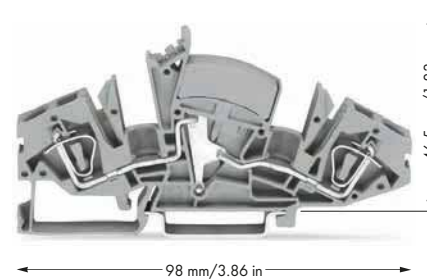

2-conductor through terminal block, without test sockets

Color	Item No.	Pack. Unit
○ gray	282-841/049-000	20



IEC/EN 60947-7-1  
 500 V  
 6 kV  
 30 A

0.2 ... 6 mm<sup>2</sup> / 24 ... 10 AWG  
 0.2 ... 6 mm<sup>2</sup> / 24 ... 10 AWG  
 12 ... 13 mm / 0.47 ... 0.51 inch  
 8 mm / 0.315 inch  
 Polyamide 66 (PA 66)

	Item No.	Page
2-way	282-432	361
orange	282-365	361
plain	793-5501	780
k/l (50x each)	794-5553/000-002	359
U/V (50x each)	794-5554/000-006	359
gray	282-369	460

## Disconnect and Ground Conductor Disconnect Terminal Blocks Installation



Ground conductor disconnect terminal block – top view

5

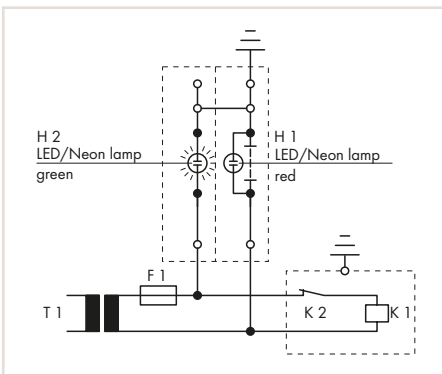

**Operating condition**  
Slide link closed, auxiliary circuit grounded, green LED/neon lamp illuminates.

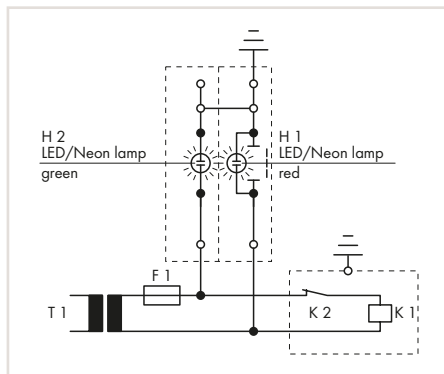

**Test condition – no grounding**  
Slide link open, auxiliary circuit not grounded.

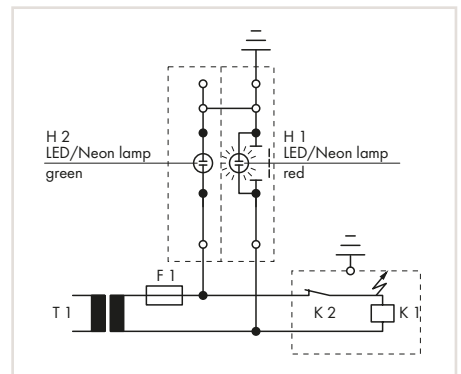

**Test condition – grounding**  
Slide link open, auxiliary circuit not grounded, red LED/neon lamp illuminates.



Testing via conductor entry.



Testing via jumper contact slot.

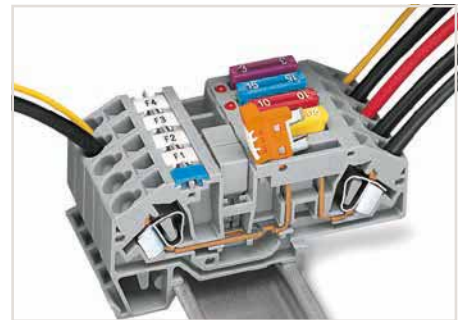

Power supply via disconnect link – disconnecting all outputs.

## Ground Conductor Disconnect Terminal Blocks, 30 A 6 mm<sup>2</sup>, 282 Series

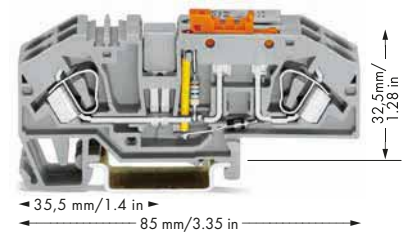

Ground conductor disconnect terminal block, with test point, orange disconnect link, gray

	Item No.	Pack. Unit
○ 24 V	282-640	12
○ 48 V	282-641	12
○ 120 V	282-638	12
○ 230 V	282-639	12

### Technical Data

#### Connection Data

Solid conductor	0.2 ... 6 mm <sup>2</sup> / 24 ... 10 AWG
Fine-stranded conductor	0.2 ... 6 mm <sup>2</sup> / 24 ... 10 AWG
Strip length	12 ... 13 mm / 0.47 ... 0.51 inch
Terminal block width	16 mm / 0.63 inch
Insulation material	Polyamide 66 (PA 66)

#### Accessories (Selection)

End plate, 2 mm thick
WMB Multi marking system, white, 10 strips with 10 markers per card, 5 ... 5.2 mm stretchable

	Item No.	Page
orange	282-333	454
plain	793-5501	780

IEC 60204/DIN VDE 0113 "Safety of machinery – Electrical equipment of machines – Part 1: General requirements," Section 9.4.3.1: Ground faults on control circuits shall not cause unintentional starting, hazardous movements or prevent stopping of the machine.

In order to fulfill this requirement, bonding to the protective bonding circuit shall be provided in accordance with Section 8.2 and the devices shall be connected as described in Section 9.1.4. Control circuits fed from a transformer and not connected to the protective bonding circuit shall be provided with an insulation monitoring device (e.g., residual current device), which either indicates a ground fault or interrupts the circuit automatically after a ground fault.

In the case of electronic circuits, the connection of one side of the control circuit to the protective bonding circuit in accordance with Section 9.1.4 can prevent unintentional operation. When this does not help, or if due to other reasons that electronic circuits cannot be connected to the protective bonding circuit, other measures shall be taken to achieve the same level of safety.

Multipole control switches that interrupt all live conductors shall be used where the control circuit is directly connected between the phase conductors of the supply or between a phase conductor and a neutral conductor, which is either not grounded or grounded through a high impedance. This is required for starting or stopping those machine functions, which can cause a hazardous situation including: damaging the machine or halting work in progress in the event of unintentional starting or failure to stop.

 Accessories (jumpers, end plates, test plugs, etc.), see page 454

 Carrier rails and tools, see Section 13

 Appropriate marking system, WMB/WMB Inline, see Full Line Catalog, Volume 6

 Approvals and corresponding ratings, visit [www.wago.com](http://www.wago.com)

## Disconnect and Ground Conductor Disconnect Terminal Blocks, 30 A, Through Terminal Blocks of Same Profile

### 6 mm<sup>2</sup>, 282 Series

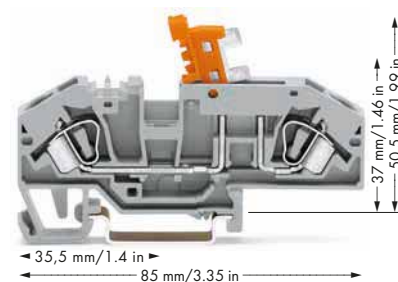

2-conductor disconnect terminal block, with test point, orange disconnect link

Color	Item No.	Pack. Unit
gray	282-697	25
blue	282-695	25

**UL**

#### Technical Data

Ratings per	
Rated voltage (III / 3)	400 V
Rated surge voltage (III / 3)	6 kV
Rated current	30 A
Approval	600 V, 30 A <b>UL</b> ; 300 V, 36 A <b>CE</b>

#### Connection Data

Solid conductor	0.2 ... 6 mm <sup>2</sup> / 24 ... 10 AWG
Fine-stranded conductor	0.2 ... 6 mm <sup>2</sup> / 24 ... 10 AWG
Strip length	12 ... 13 mm / 0.47 ... 0.51 inch
Terminal block width	8 mm / 0.315 inch
Insulation material	Polyamide 66 (PA 66)

#### Accessories (Selection)

	Item No.	Page
Adjacent jumper, insulated, I <sub>N</sub> 41 A	gray 282-402	453
End and intermediate plate, 2 mm thick	orange 282-333	454
WMB Multi marking system, white, 10 strips with 10 markers per card, 5 ... 5.2 mm stretchable	plain 793-5501	780
Test plug adapter, 8.3 mm wide, for 4 mm Ø test plug, for 1.5 ... 10 mm <sup>2</sup> terminal blocks	gray 209-170	460

5

Accessories (jumpers, end plates, test plugs, etc.), see page 453

Carrier rails and tools, see Section 13

Appropriate marking system, WMB/WMB Inline, see Full Line Catalog, Volume 6

Approvals and corresponding ratings, visit [www.wago.com](http://www.wago.com)



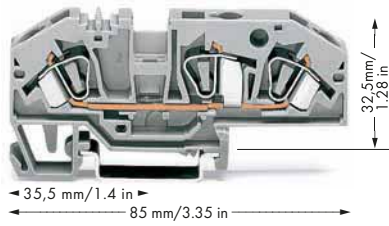

3-conductor through terminal block, with test point, same profile as disconnect terminal blocks

Color	Item No.	Pack. Unit
○ gray	282-699	25
● blue	282-694	25

RAE

IEC/EN 60947-7-1
800 V
8 kV
41 A
600 V, 30 A <b>RAE</b> ; 600 V, 40 A <b>AE</b>
0.2 ... 6 mm <sup>2</sup> / 24 ... 10 AWG
0.2 ... 6 mm <sup>2</sup> / 24 ... 10 AWG
12 ... 13 mm / 0.47 ... 0.51 inch
8 mm / 0.315 inch
Polyamide 66 (PA 66)

	Item No.	Page
gray	282-402	453
orange	282-333	454
plain	793-5501	780
gray	209-170	460

# Fuse Terminal Blocks for Mini-Automotive Fuses

## Technical Information

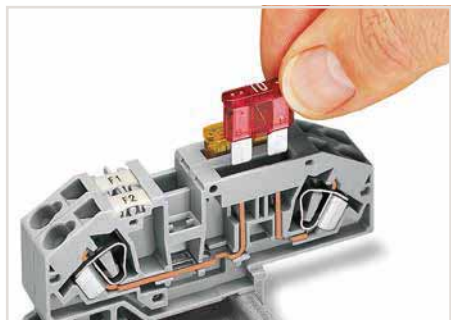

Inserting a fuse.



Blown fuse indication by LED

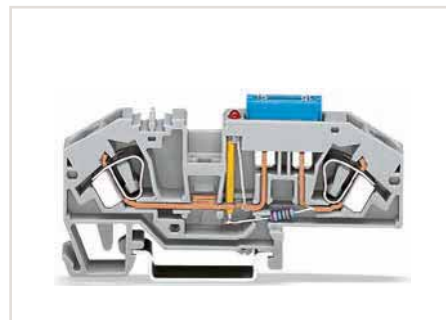

2-conductor fuse terminal block with mini-automotive blade-style fuse

5

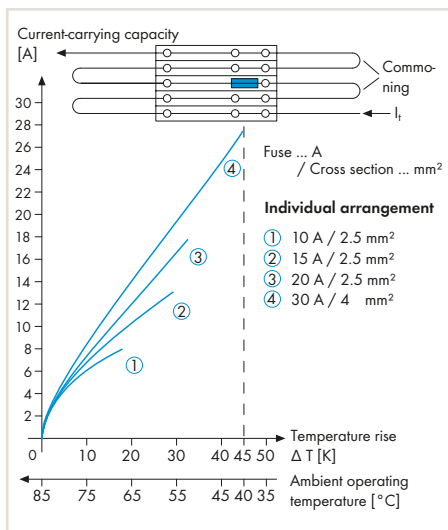

Diagram: Individual arrangement

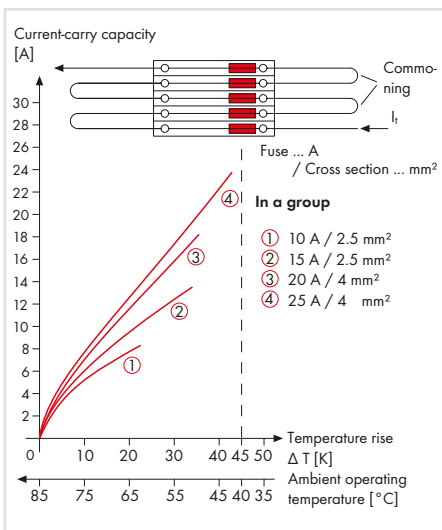

Diagram: Block arrangement

### Information from the mini-automotive, blade-type fuse manufacturers

Derating T <sub>amb</sub> / °C	%	F <sub>T</sub>
- 25	14	0.877
- 20	13	0.885
- 15	12	0.893
- 10	11	0.901
- 5	10	0.909
0	9	0.917
5	8	0.926
10	6	0.943
15	4	0.962
20	2	0.980
23	0	1.000
30	- 2	1.020
35	- 4	1.042
40	- 6	1.064
45	- 8	1.087
50	- 10	1.111
55	- 13	1.149
60	- 16	1.190
65	- 19	1.235
70	- 22	1.282



## Fuse Terminal Blocks for Mini-Automotive Fuses

### 6 mm<sup>2</sup>, 282 Series

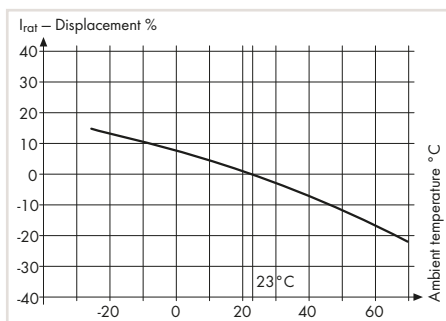

Nominal current ratings for fuse cartridges are defined differently in international standards. This is why the recommended continuous current-carrying capacity of the fuses is a max. 80 % of their nominal current according to DIN 72581/Part 3 (for an ambient operating temperature of 23 °C). Selecting the correct fuse cartridge is important for product safety within applications, as well as for fuse cartridge service life and reliability. Fuse cartridges will only operate perfectly as protection components (break-off point) if they are properly selected and used as intended (i.e., according to the state of the technology and valid specifications, as well as data sheet characteristics), according to basic safety requirements (i.e., persons, animals and property must be protected against hazards).

Blade-style fuses are not offered by WAGO.  
Thermal automotive circuit breakers are not offered by WAGO.  
WAGO recommends automotive circuit breakers from ETA.

Electrical ratings are given by the fuse.

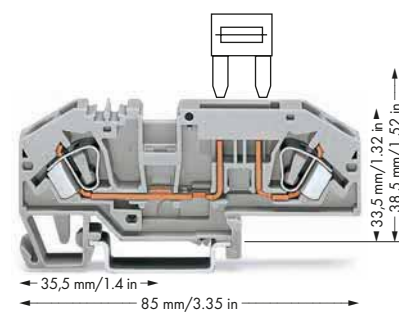

2-conductor fuse terminal block for mini-automotive fuses, with test point, without blown fuse indication

Color	Item No.	Pack. Unit
○ gray	282-696	25



#### Technical Data

Ratings per	IEC/EN 60947-7-3
Rated voltage (III / 3)	400 V
Rated surge voltage (III / 3)	6 kV
Rated current	25 A
Rated current (2)	30 A
Approval	600 V, 30 A ; 24 V, 30 A

#### Connection Data

Solid conductor	0.2 ... 6 mm <sup>2</sup> / 24 ... 10 AWG
Fine-stranded conductor	0.2 ... 6 mm <sup>2</sup> / 24 ... 10 AWG
Strip length	12 ... 13 mm / 0.47 ... 0.51 inch
Terminal block width	8 mm / 0.315 inch
Insulation material	Polyamide 66 (PA 66)

#### Note

Electrical ratings are given by the fuse.  
Blade-style fuses: Observe touch-proof protection for 42 V and higher voltages!

#### Accessories (Selection)

Adjacent jumper, insulated, I <sub>n</sub> 41 A
End and intermediate plate, 2 mm thick
WMB Multi marking system, white, 10 strips with 10 markers per card, 5 ... 5.2 mm stretchable
Test plug adapter, 8.3 mm wide, for 4 mm Ø test plug, for 1.5 ... 10 mm <sup>2</sup> terminal blocks

	Item No.	Page
gray	282-402	453
orange	282-333	454
plain	793-5501	780
gray	209-170	460

Application notes on miniature metric fuses, see page 388

Accessories (jumpers, end plates, test plugs, etc.), see page 453

Carrier rails and tools, see Section 13

Appropriate marking system, WMB/WMB Inline, see Full Line Catalog, Volume 6

Information on hazardous locations, see Section 14

Approvals and corresponding ratings, visit [www.wago.com](http://www.wago.com)

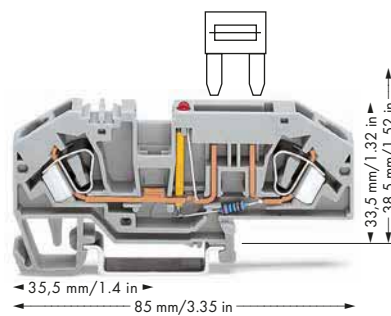
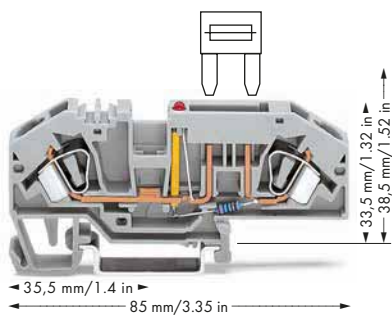

282-698/281-429

282-698/281-449

282-698/281-413

282-698/281-434

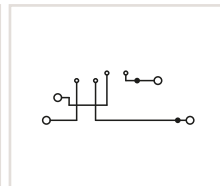
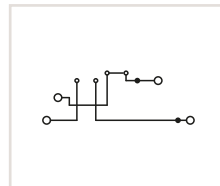
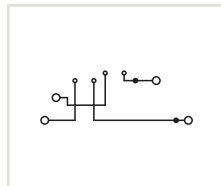
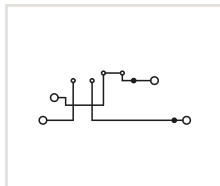

2-conductor fuse terminal block for mini-automotive fuses, 12 V, with test point, with blown fuse indication by LED, LED power consumption: 4.8 mA

Color	Item No.	Pack. Unit
gray	282-698/281-429	25
gray	282-698/281-449	25

2-conductor fuse terminal block for mini-automotive fuses, 24 V, with test point, with blown fuse indication by LED, LED power consumption: 4.8 mA

Color	Item No.	Pack. Unit
gray	282-698/281-413	25
gray	282-698/281-434	25



IEC/EN 60947-7-3  
400 V  
6 kV  
25 A  
30 A  
12 V, 30 A **UL**; 24 V, 12 A **UL**

IEC/EN 60947-7-3  
400 V  
6 kV  
25 A  
30 A  
24 V, 30 A **UL**

0.2 ... 6 mm<sup>2</sup> / 24 ... 10 AWG  
0.2 ... 6 mm<sup>2</sup> / 24 ... 10 AWG  
12 ... 13 mm / 0.47 ... 0.51 inch  
8 mm / 0.315 inch  
Polyamide 66 (PA 66)

0.2 ... 10 mm<sup>2</sup> / 24 ... 8 AWG  
0.2 ... 6 mm<sup>2</sup> / 24 ... 10 AWG  
12 ... 13 mm / 0.47 ... 0.51 inch  
8 mm / 0.315 inch  
Polyamide 66 (PA 66)

Electrical ratings are given by the fuse.  
Blade-style fuses: Observe touch-proof protection for 42 V and higher voltages!

Electrical ratings are given by the fuse.  
Blade-style fuses: Observe touch-proof protection for 42 V and higher voltages!

	Item No.	Page
gray	282-402	453
orange	282-333	454
plain	793-5501	780
gray	209-170	460

	Item No.	Page
gray	282-402	453
orange	282-333	454
plain	793-5501	780
gray	209-170	460

## Fused Disconnect Terminal Blocks with a Pivoting Fuse Holder, for Miniature Metric Fuses, 282 Series

### Description and Installation



Blown fuse indication by LED or neon lamp



**Fuse replacement:**  
Before replacing a fuse, pivot the fuse holder into the locked open position.

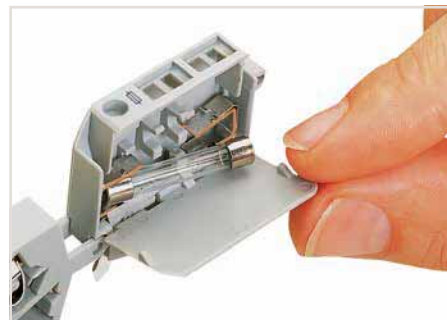

**Fuse replacement:**  
One end of the fuse is automatically ejected from the holder when opening the cover.

5



**CAGE CLAMP® connection**  
Inserting a conductor via screwdriver. With ferruled conductors, it is necessary to use a terminal block one size smaller than the conductor's nominal cross section.

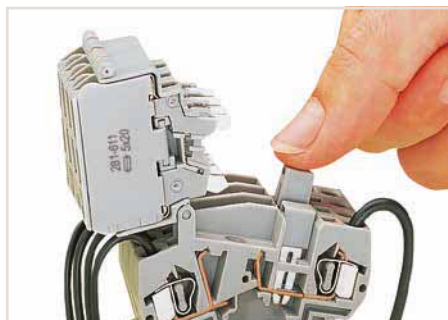

**Commoning:**  
Distributing current to several fuse-protected circuits via insulated push-in type jumpers.

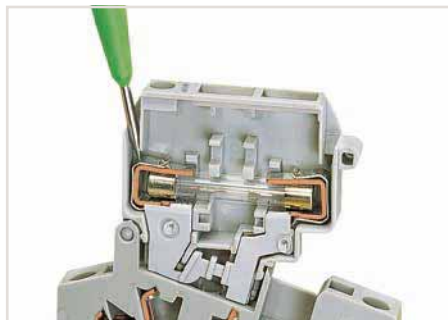

Voltage test, either at input or output with fuse holder in closed position (live)



Through test with fuse holder in open position (no voltage)

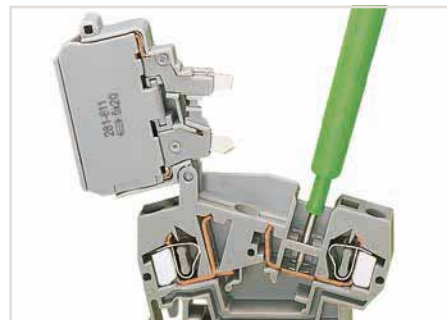

Voltage test at input in the test slot of the current bar





Fuse replacement:  
Easily removing a fuse by hand.



Fuse replacement:  
Insert a new fuse and snap the cover closed.



Storing a spare fuse (fuse holder without blown fuse indication).

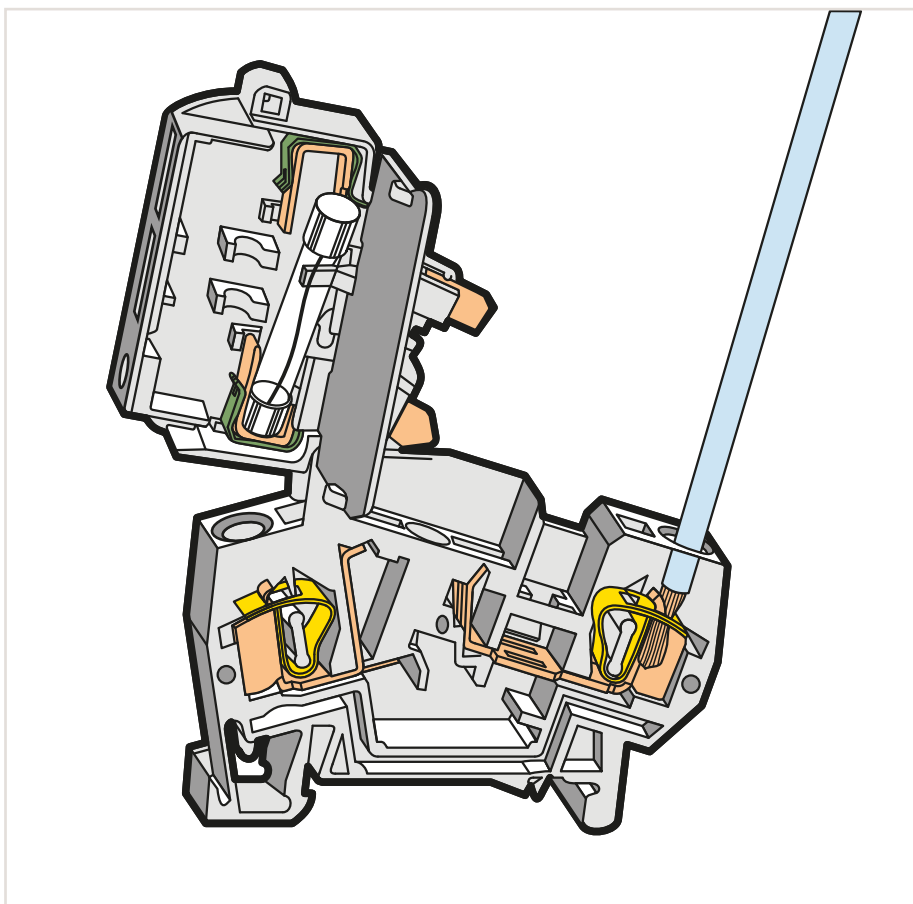

Touch-proof protection in all positions of the fuse holder



Fuse holder will remain safely locked open in vertical assemblies.

5



Testing voltage at the output via separate test slot.



Measuring current between jumper slot and separate test slot.

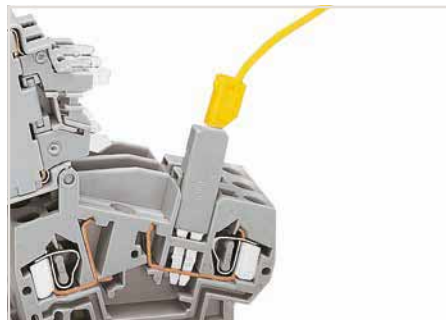

Testing voltage (input side) via test plug adapter (280-404, shown) or test plug (281-407).

## Fused Disconnect Terminal Blocks with a Pivoting Fuse Holder, for 5 x 20 mm, 5 x 25 mm and 5 x 30 mm Miniature Metric Fuses 4 mm<sup>2</sup>, 281 Series



Fused disconnect or disconnect terminal blocks with a width of 8 mm can be assembled adjacently. At the end of an assembly or if there is no adjacent fused disconnect or disconnect terminal block, an end or intermediate plate must be used.

Electrical ratings are given by the fuse. Miniature metric fuses are available upon request.



Fused disconnect terminal block with a pivoting fuse holder, without blown fuse indication, for (5 x 20) mm miniature metric fuse

Color	Item No.	Pack. Unit
○ gray	281-611	50
● orange	281-616	50

for (5 x 25) mm miniature metric fuse

Color	Item No.	Pack. Unit
○ gray	281-612	50

for (5 x 30) mm miniature metric fuse

Color	Item No.	Pack. Unit
○ gray	281-622	50



### Technical Data

Ratings per	IEC/EN 60947-7-3
Rated voltage (III / 3)	800 V
Rated surge voltage (III / 3)	8 kV
Rated current	10 A
Approval	600 V, 10 A  600 V, 10 A

### Connection Data

Solid conductor	0.08 ... 4 mm <sup>2</sup> / 28 ... 12 AWG
Fine-stranded conductor	0.08 ... 4 mm <sup>2</sup> / 28 ... 12 AWG
Strip length	9 ... 10 mm / 0.35 ... 0.39 inch
Terminal block width	8 mm / 0.315 inch
Insulation material	Polyamide 66 (PA 66)

### Note

Electrical ratings are given by the fuse.

### Accessories (Selection)

Adjacent jumper, insulated, I <sub>N</sub> = I <sub>N</sub> terminal block	gray	281-402	447
End and intermediate plate, 2.5 mm thick	orange	281-309	449
WMB Multi marking system, white, 10 strips with 10 markers per card, 5 ... 5.2 mm stretchable	plain	793-5501	780
Test plug adapter, 5 mm wide, for 2.3 mm Ø test plug (210-137), for 1.5 ... 4 mm <sup>2</sup> terminal blocks	gray	280-404	460

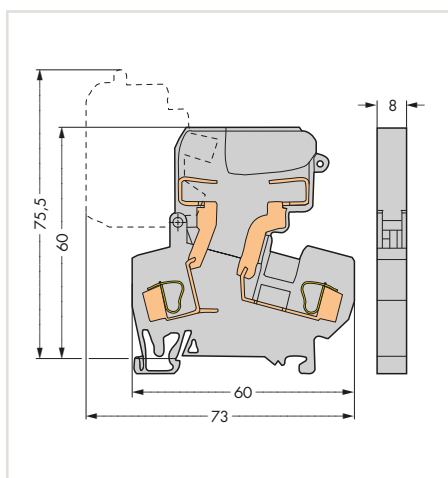

Fused disconnect terminal block with a pivoting fuse holder, for (5 x 20) mm miniature metric fuse, without blown fuse indication (281-611)



Ganging several fuse holders with an interlocking link (example shows 8 mm wide terminal blocks).

Application notes on miniature metric fuses, see page 388

Accessories (jumpers, end plates, test plugs, etc.), see page 447

Carrier rails and tools, see Section 13

Appropriate marking system, WMB, see Full Line Catalog, Volume 6

Approvals and corresponding ratings, visit [www.wago.com](http://www.wago.com)

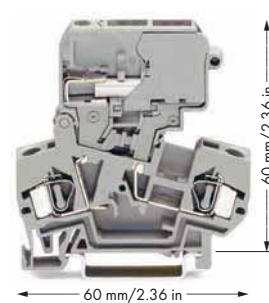
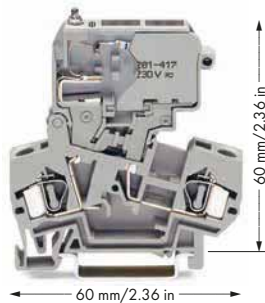

Fused disconnect terminal block with a pivoting fuse holder, with blown fuse indication by LED, gray, for (5 x 20) mm miniature metric fuse

	Item No.	Pack. Unit
○ 15 ... 30 V	281-611/281-541	50
○ 30 ... 65 V	281-611/281-542	50

Fused disconnect terminal block with a pivoting fuse holder, with blown fuse indication by neon lamp, gray, for (5 x 20) mm miniature metric fuse

	Item No.	Pack. Unit
○ 230 V	281-611/281-417	50
○ 120 V	281-611/281-418	50

Disconnect terminal block with a pivoting disconnect link

Color	Item No.	Pack. Unit
○ gray	281-624	50
● orange	281-672	50

for (5 x 25) mm miniature metric fuse

	Item No.	Pack. Unit
○ 15 ... 30 V	281-612/281-541	50
○ 30 ... 65 V	281-612/281-542	50

for (5 x 25) mm miniature metric fuse

	Item No.	Pack. Unit
○ 230 V	281-612/281-417	50
○ 120 V	281-612/281-418	50

for (5 x 30) mm miniature metric fuse

	Item No.	Pack. Unit
○ 15 ... 30 V	281-622/281-541	50
○ 30 ... 65 V	281-622/281-542	50

for (5 x 30) mm miniature metric fuse

	Item No.	Pack. Unit
○ 230 V	281-622/281-417	50
○ 120 V	281-622/281-418	50



IEC/EN 60947-7-3

800 V

8 kV

10 A

30 V, 10 A<sup>RU</sup>; 230 V, 10 A<sup>RE</sup>

IEC/EN 60947-7-3

800 V

8 kV

10 A

220 V, 10 A<sup>RU</sup>; 230 V, 10 A<sup>RE</sup>

800 V

8 kV

16 A

600 V, 16 A<sup>RU</sup>; 600 V, 10 A<sup>RE</sup>

0.08 ... 4 mm<sup>2</sup> / 28 ... 12 AWG

0.08 ... 4 mm<sup>2</sup> / 28 ... 12 AWG

9 ... 10 mm / 0.35 ... 0.39 inch

8 mm / 0.315 inch

Polyamide 66 (PA 66)

Electrical ratings are given by the fuse and blown fuse indication.  
Leakage current in case of a blown fuse: LED 6 mA

0.08 ... 4 mm<sup>2</sup> / 28 ... 12 AWG

0.08 ... 4 mm<sup>2</sup> / 28 ... 12 AWG

9 ... 10 mm / 0.35 ... 0.39 inch

8 mm / 0.315 inch

Polyamide 66 (PA 66)

Electrical ratings are given by the fuse and blown fuse indication.  
Leakage current in case of a blown fuse: Neon lamp < 0.4 mA

0.08 ... 4 mm<sup>2</sup> / 28 ... 12 AWG

0.08 ... 4 mm<sup>2</sup> / 28 ... 12 AWG

9 ... 10 mm / 0.35 ... 0.39 inch

8 mm / 0.315 inch

Polyamide 66 (PA 66)

	Item No.	Page
gray	281-402	447
orange	281-309	449
plain	793-5501	780
gray	280-404	460

	Item No.	Page
gray	281-402	447
orange	281-309	449
plain	793-5501	780
gray	280-404	460

	Item No.	Page
gray	281-402	447
orange	281-309	449
plain	793-5501	780
gray	280-404	460

## Fused Disconnect Terminal Blocks with a Pivoting Fuse Holder, for ¼" x 1" and ¼" x 1¼" Miniature Metric Fuses

### 4 mm<sup>2</sup>, 281 Series



An intermediate plate is supplied with all 10 mm wide fused disconnect terminal blocks. At the end of an assembly or if there is no adjacent fused disconnect terminal block, an end or intermediate plate must be used.

Electrical ratings are given by the fuse. Miniature metric fuses are available upon request.



Fused disconnect terminal block with a pivoting fuse holder, without blown fuse indication, for ¼" x 1" miniature metric fuse

Color	Item No.	Pack. Unit
○ gray	281-613	50

for ¼" x 1¼" miniature metric fuse

Color	Item No.	Pack. Unit
○ gray	281-623	50



#### Technical Data

Ratings per	IEC/EN 60947-7-3
Rated voltage (III / 3)	800 V
Rated surge voltage (III / 3)	8 kV
Rated current	10 A
Approval	600 V, 10 A  600 V, 10 A

#### Connection Data

Solid conductor	0.08 ... 4 mm <sup>2</sup> / 28 ... 12 AWG
Fine-stranded conductor	0.08 ... 4 mm <sup>2</sup> / 28 ... 12 AWG
Strip length	9 ... 10 mm / 0.35 ... 0.39 inch
Terminal block width	8 mm / 0.315 inch
Insulation material	Polyamide 66 (PA 66)

#### Note

Electrical ratings are given by the fuse.

#### Accessories (Selection)

Adjacent jumper, insulated, I <sub>N</sub> = I <sub>N</sub> terminal block	gray	281-402	447
End and intermediate plate, 2.5 mm thick	orange	281-309	449
WMB Multi marking system, white, 10 strips with 10 markers per card, 5 ... 5.2 mm stretchable	plain	793-5501	780
Test plug adapter, 5 mm wide, for 2.3 mm Ø test plug (210-137), for 1.5 ... 4 mm <sup>2</sup> terminal blocks	gray	280-404	460

	Item No.	Page
gray	281-402	447
orange	281-309	449
plain	793-5501	780
gray	280-404	460

5

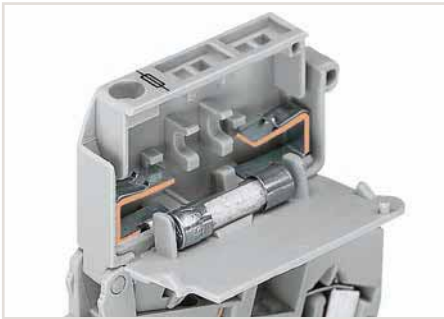

5 x 20 mm, 5 x 25 mm and ¼" x 1" fuse holders are fitted with stops on the inside of the cover.

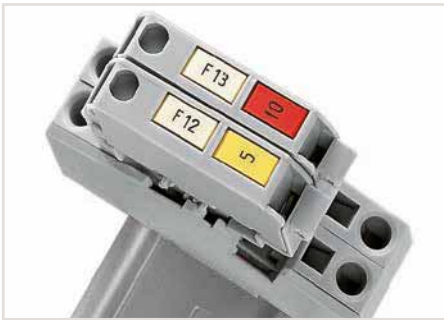

Each fuse holder features two marker slots for custom WMB Multi markers (example shows 8 mm wide terminal blocks).

Application notes on miniature metric fuses, see page 388

Accessories (jumpers, end plates, test plugs, etc.), see page 447

Carrier rails and tools, see Section 13

Appropriate marking system, WMB, see Full Line Catalog, Volume 6

Approvals and corresponding ratings, visit [www.wago.com](http://www.wago.com)



Fused disconnect terminal block with a pivoting fuse holder, with blown fuse indication by LED, gray, for 1/4" x 1" miniature metric fuse

	Item No.	Pack. Unit
○ 15 ... 30 V	281-613/281-541	50
○ 30 ... 65 V	281-613/281-542	50

for 1/4" x 1 1/4" miniature metric fuse

	Item No.	Pack. Unit
○ 15 ... 30 V	281-623/281-541	50
○ 30 ... 65 V	281-623/281-542	50



IEC/EN 60947-7-3  
 800 V  
 8 kV  
 10 A  
 30 V, 10 A ; 30 V, 10 A

0.08 ... 4 mm<sup>2</sup> / 28 ... 12 AWG  
 0.08 ... 4 mm<sup>2</sup> / 28 ... 12 AWG  
 9 ... 10 mm / 0.35 ... 0.39 inch  
 8 mm / 0.315 inch  
 Polyamide 66 (PA 66)

Electrical ratings are given by the fuse and blown fuse indication.  
 Leakage current in case of a blown fuse: LED 6 mA

	Item No.	Page
gray	281-402	447
orange	281-309	449
plain	793-5501	780
gray	280-404	460

Fused disconnect terminal block with a pivoting fuse holder, with blown fuse indication by neon lamp, gray, for 1/4" x 1" miniature metric fuse

	Item No.	Pack. Unit
○ 230 V	281-613/281-417	50
○ 120 V	281-613/281-418	50

for 1/4" x 1 1/4" miniature metric fuse

	Item No.	Pack. Unit
○ 230 V	281-623/281-417	50
○ 120 V	281-623/281-418	50



IEC/EN 60947-7-3  
 800 V  
 8 kV  
 10 A  
 220 V, 10 A ; 100 V, 10 A

0.08 ... 4 mm<sup>2</sup> / 28 ... 12 AWG  
 0.08 ... 4 mm<sup>2</sup> / 28 ... 12 AWG  
 9 ... 10 mm / 0.35 ... 0.39 inch  
 8 mm / 0.315 inch  
 Polyamide 66 (PA 66)

Electrical ratings are given by the fuse and blown fuse indication.  
 Leakage current in case of a blown fuse: Neon lamp < 0.4 mA

	Item No.	Page
gray	281-402	447
orange	281-309	449
plain	793-5501	780
gray	280-404	460



## Fuse Plugs on Carrier Terminal Blocks, 4 mm<sup>2</sup> 281 Series

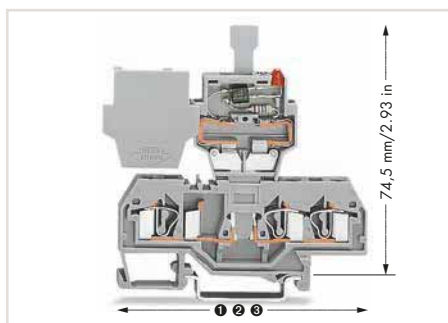

Length of carrier terminal blocks with a fuse plug:

- ❶ 59 mm / 2.32 inch for 281-916
- ❷ 73.5 mm / 2.89 inch for 281-610
- ❸ 86 mm / 3.39 inch for 281-656

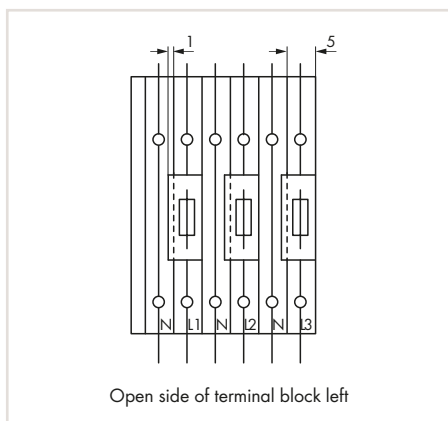

Open side of terminal block left

When a corresponding neutral circuit is adjacent to the fuse plug, a 5 mm wide space-saving terminal block may be used, as a 6 mm wide fuse plug may overlap the terminal block (see diagram).

For 5 mm wide carrier terminal blocks, see page 446 (can be used with end plates, for example).

Fuse plug features for quick and safe applications:

- Optional LED indicates blown fuse
- Top-of-unit marking slot provides clear carrier terminal block identification
- Two test slots with touch contacts
- Terminal blocks/plugs provide high-density wiring in a width of just 6 mm
- May be used as a disconnect plug in combination with a shorting link

Application notes on miniature metric fuses, see page 388

Accessories (comb-style jumper bars, end plates, etc.), see page 447

Appropriate marking system, 4 mm wide WSB (plug) and WMB (terminal block) markers, see Full Line Catalog, Volume 6

Approvals and corresponding ratings, visit [www.wago.com](http://www.wago.com)

Using fuse plugs with rail-mount terminal blocks for control circuit protection is highly advantageous because the function and wiring levels are separated:

- No additional cost for assembly and wiring
- No risk of accidental contact with live parts when disconnecting the fuse plug
- The fuse plug is completely separated from the carrier terminal block when replacing a fuse – away from current carrying parts
- The fuse plug can be removed by service personnel
- No unintentional reclosing of the circuit by another person
- Quickly exchange a fuse by using a prepared “stand-by plug”



281-511

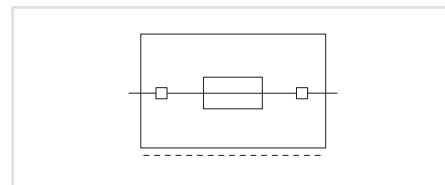

Fuse plug with pull-tab, for (5 x 20) mm and (5 x 25) mm miniature metric fuses, 6 mm wide

Color	Item No.	Pack. Unit
● gray	281-511	50

### Technical Data

Rated voltage (III / 3)	250 V
Rated current	6.3 A
Plug width	6 mm / 0.236 inch
Insulation material	Polyamide 66 (PA 66)

### Note

Electrical ratings are given by the fuse.

### Accessories (Selection)

2-conductor carrier terminal block, 0.08 ... 4 mm <sup>2</sup> (28 ... 12 AWG), 6 mm (0.236 inch) wide	gray	281-916	452
3-conductor carrier terminal block, 0.08 ... 4 mm <sup>2</sup> (28 ... 12 AWG), 6 mm (0.236 inch) wide	gray	281-610	452
4-conductor carrier terminal block, 0.08 ... 4 mm <sup>2</sup> (28 ... 12 AWG), 6 mm (0.236 inch) wide	gray	281-656	452
Comb-style jumper bar, insulated, I <sub>N</sub> = I <sub>N</sub> terminal block, gray	2-way	281-482	447
Wire commoning chain, insulated, 50 connections, I <sub>N</sub> 8 A	black	210-103	460
Shorting link, (5 x 20) mm, allows the fuse plug to be used as a disconnect plug, I <sub>N</sub> 6.3 A		281-503	460
WSB Quick marking system, 10 strips with 10 markers per card, 4 mm wide WSB markers, plain	white	209-701	782





281-512

281-512/281-501

281-512/281-418

281-512/281-417

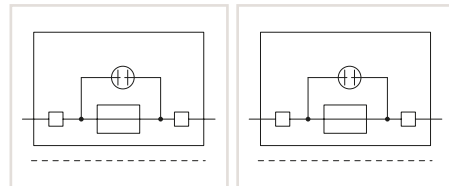
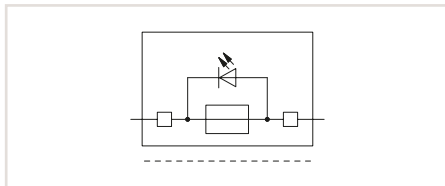
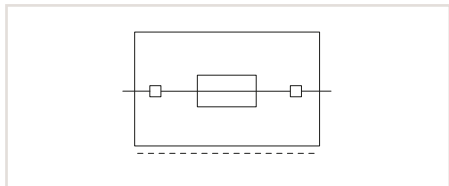

Fuse plug with pull-tab, for (5 x 20) mm and (5 x 25) mm miniature metric fuses, with hole for one LED (for self-assembly), 6 mm wide

Fuse plug with pull-tab, for (5 x 20) mm and (5 x 25) mm miniature metric fuses, with LED, 24 VAC/DC, 6 mm wide

Fuse plug with pull-tab, for (5 x 20) mm and (5 x 25) mm miniature metric fuses, with neon lamp, 120 VAC/DC, 6 mm wide

Color	Item No.	Pack. Unit
○ gray	281-512	50

Color	Item No.	Pack. Unit
○ gray	281-512/281-501	50

Color	Item No.	Pack. Unit
○ gray	281-512/281-418	50

Fuse plug with pull-tab, for (5 x 20) mm and (5 x 25) mm miniature metric fuses, with neon lamp, 230 VAC/DC, 6 mm wide

Color	Item No.	Pack. Unit
○ gray	281-512/281-417	50

250 V  
6.3 A  
6 mm / 0.236 inch  
Polyamide 66 (PA 66)  
Electrical ratings are given by the fuse.

250 V  
6.3 A  
6 mm / 0.236 inch  
Polyamide 66 (PA 66)  
Electrical ratings are given by the fuse and blown fuse indication.  
Leakage current in case of a blown fuse: LED 5 ... 20 mA

250 V  
6.3 A  
6 mm / 0.236 inch  
Polyamide 66 (PA 66)  
Electrical ratings are given by the fuse and blown fuse indication.  
Leakage current in case of a blown fuse: LED 5 ... 20 mA

	Item No.	Page
gray	281-916	452
gray	281-610	452
gray	281-656	452
2-way	281-482	447
black	210-103	460
	281-503	460
white	209-701	782

	Item No.	Page
gray	281-916	452
gray	281-610	452
gray	281-656	452
2-way	281-482	447
black	210-103	460
	281-503	460
white	209-701	782

	Item No.	Page
gray	281-916	452
gray	281-610	452
gray	281-656	452
2-way	281-482	447
black	210-103	460
	281-503	460
white	209-701	782

## Fuse Plugs on Carrier Terminal Blocks, 2.5 mm<sup>2</sup> 280 Series

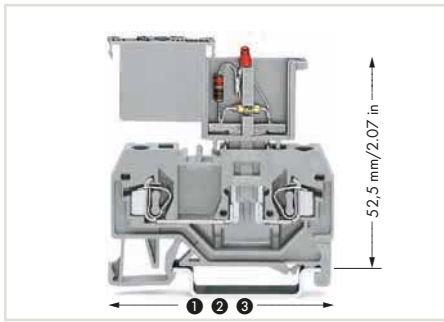

Length of carrier terminal blocks with a fuse plug:

- ① 53 mm / 2.09 inch for 280-916
- ② 64 mm / 2.52 inch for 280-610
- ③ 75 mm / 2.95 inch for 280-816

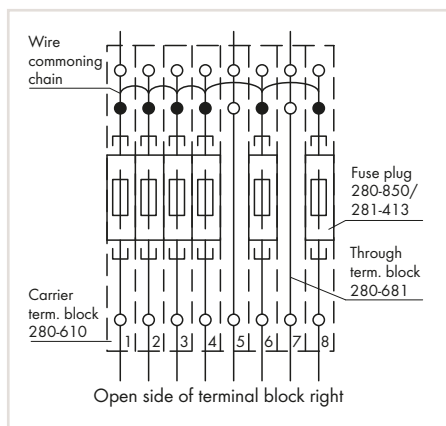

Fuse protection of individual outputs – supply via wire commoning chain

Using fuse plugs with rail-mount terminal blocks (280/281 and 769 Series) for control circuit protection is highly advantageous because the function and wiring levels are separated:

- No additional cost for assembly and wiring
- No risk of accidental contact with live parts when disconnecting the fuse plug
- Quick plug replacement in case of a blown fuse
- The fuse plug can be removed by service personnel
- No unintentional reclosing of the circuit by another person



280-850

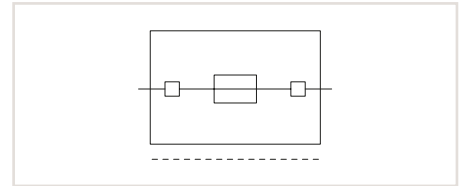

Fuse plug, with soldered miniature fuse, 5 mm wide, gray

	Item No.	Pack. Unit
○ 250 mA FF	280-850	100
○ 500 mA FF	280-852	100
○ 1 A FF	280-854	100
○ 2 A FF	280-856	100

### Technical Data

Rated voltage (III / 3)

125 V

Rated current

5 A

Plug width

5 mm / 0.197 inch

Insulation material

Polyamide 66 (PA 66)

Note

Electrical ratings are given by the fuse.

### Accessories (Selection)

2-conductor carrier terminal block, 0.08 ... 2.5 mm<sup>2</sup> / 28 ... 12 AWG (12 AWG: THHN, THWN), 5 mm (0.197 inch) wide

3-conductor carrier terminal block, 0.08 ... 2.5 mm<sup>2</sup> / 28 ... 12 AWG (12 AWG: THHN, THWN), 5 mm (0.197 inch) wide

4-conductor carrier terminal block, 0.08 ... 2.5 mm<sup>2</sup> / 28 ... 12 AWG (12 AWG: THHN, THWN), 5 mm (0.197 inch) wide

Comb-style jumper bar, insulated, I<sub>N</sub> = I<sub>N</sub> terminal block, gray

Wire commoning chain, insulated, 50 connections, I<sub>N</sub> 8 A

Shorting link, (5 x 20) mm, allows the fuse plug to be used as a disconnect plug, I<sub>N</sub> 6.3 A

	Item No.	Page
gray	280-916	446
gray	280-610	446
gray	280-816	446
2-way	280-482	440
black	210-103	460
	281-503	460

Additional advantages:

- Terminal blocks/plugs provide ultra high-density wiring in a width of just 5 mm
- Optional LED indicates blown fuse

Application notes on miniature metric fuses, see page 388

Accessories (comb-style jumper bars, end plates, etc.), see page 440

Appropriate marking systems: 4 mm wide WSB (plug) and WMB (terminal block) markers, see Full Line Catalog, Volume 6

Approvals and corresponding ratings, visit [www.wago.com](http://www.wago.com)



280-850/281-413

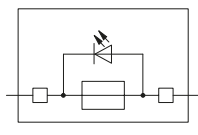

Fuse plug, with soldered miniature fuse, with additional indicator lamp, red LED, 15 ... 30 VDC, 5 mm wide, gray

	Item No.	Pack. Unit
○ 250 mA FF	280-850/281-413	100
○ 500 mA FF	280-852/281-413	100
○ 1 A FF	280-854/281-413	100
○ 2 A FF	280-856/281-413	100

125 V

5 A

5 mm / 0.197 inch

Polyamide 66 (PA 66)

Electrical ratings are given by the fuse.

	Item No.	Page
gray	280-916	446
gray	280-610	446
gray	280-816	446
2-way	280-482	440
black	210-103	460
	281-503	460

# Fuse Terminal Blocks for Class CC Fuses and 10 x 38 mm (1 3/32" x 1 1/2") Cylindrical Fuses, 811Series

## Description and Installation



**CAGE CLAMP® connection**  
Inserting a conductor via screwdriver.  
Opening the clamping unit via integrated lever.



Terminating ferruled conductors up to 10 mm² (8 AWG).



Opening/closing lever via screwdriver.

5



Inserting a fuse.



Removing a terminal block from the carrier rail.



Jumper bar for quick and convenient commoning



WMB marking location for convenient identification



Marker carriers (285-442) for continuous marking strips



Creating a 2- or 3-pole fuse terminal block via coupling kit.

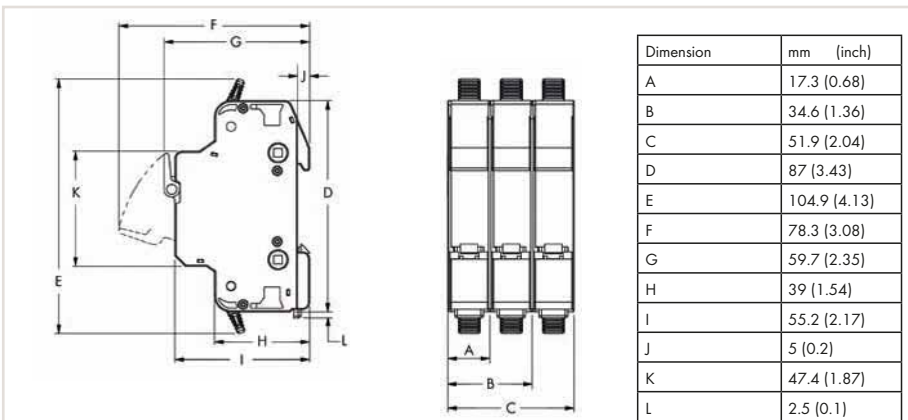

## TOPJOB® S

### Accessories, 811 Series

#### Commoning, Mounting, Marking and Testing



Push-in type jumper bar, insulated, I <sub>N</sub> 63 A, 1000 V, light gray		
	Item No.	Pack. Unit
2-way	811-472	50 (10)
3-way	811-473	40 (10)
4-way	811-474	40 (10)
5-way	811-475	40 (10)
6-way	811-476	30 (10)
7-way	811-477	20 (10)
8-way	811-478	20 (10)
9-way	811-479	20 (10)
10-way	811-480	20 (10)
11-way	811-481	20 (10)
12-way	811-482	20 (10)



Supply module, 35 mm <sup>2</sup> , 600 VAC, 1000 VDC		
Color	Item No.	Pack. Unit
light gray	811-471	16 (4)



Coupling kit, for 12 poles		
	Item No.	Pack. Unit
	811-612	1



Twin ferrule, only for 811 Series, insulated, length l = 12 mm		
	Item No.	Pack. Unit
Sleeve for 2 x 2.5 mm <sup>2</sup> (14 AWG), blue	216-545	100
Sleeve for 2 x 4 mm <sup>2</sup> (12 AWG), gray	216-546	100
Sleeve for 2 x 6 mm <sup>2</sup> (10 AWG), yellow	216-547	100

# Fuse Terminal Blocks for Class CC Fuses and 10 x 38 mm (1 3/32" x 1 1/2") Cylindrical Fuses

## 16 mm<sup>2</sup>, 811 Series

Cylindrical fuses are not offered by WAGO.



Fuse terminal block for (10 x 38) mm (1 3/32" x 1 1/2") cylindrical fuses, for photovoltaic applications, without blown fuse indication, for DIN-35 rail per EN 60715, light gray  
Electrical ratings are given by the fuse.  
Operating temperature range: -35°C ... +85°C

Pole No.	Item No.	Pack. Unit
○ 1	811-316	12

Fuse terminal block for (10 x 38) mm (1 3/32" x 1 1/2") cylindrical fuses, for photovoltaic applications, with blown fuse indication, 230 ... 1000 VDC, for DIN-35 rail per EN 60715, light gray  
Electrical ratings are given by the fuse and blown fuse indication.  
Operating temperature range: -35°C ... +85°C

Pole No.	Item No.	Pack. Unit
○ 1	811-317	12

5

### Technical Data

Ratings per	IEC/EN 60947-7-3
Voltage type	DC
Rated voltage (III / 3)	1000 V
Voltage type (2)	
Rated voltage (III / 3) (2)	
Rated current	32 A
Rated current (2)	
Approval	1000 VDC, 30 A®

### Connection Data

Solid conductor	2.5 ... 16 mm <sup>2</sup> / 16 ... 6 AWG
Fine-stranded conductor	2.5 ... 16 mm <sup>2</sup> / 16 ... 6 AWG
Strip length	12 ... 13 mm / 0.47 ... 0.51 inch
Terminal block width	17 mm / 0.669 inch
Insulation material	Polyamide 66 (PA 66)

Application notes on miniature metric fuses, see page 388

Accessories (jumpers, etc.), see page 385

Carrier rails and tools, see Section 13

Appropriate marking system, WMB, see Full Line Catalog, Volume 6

Approvals and corresponding ratings, visit [www.wago.com](http://www.wago.com)





Fuse terminal block for (10 x 38) mm (1 3/32" x 1 1/2") cylindrical fuses, without blown fuse indication, for DIN-35 rail per EN 60715, light gray  
Electrical ratings are given by the fuse.  
Operating temperature range: -35°C ... +85°C

Pole No.	Item No.	Pack. Unit
○ 1	811-310	12
○ 2	811-320	6
○ 3	811-330	4

Fuse terminal block for class CC fuses, without blown fuse indication, for DIN-35 rail per EN 60715, light gray  
Electrical ratings are given by the fuse.  
Operating temperature range: -35°C ... +85°C

Pole No.	Item No.	Pack. Unit
○ 1	811-410	12
○ 2	811-420	6
○ 3	811-430	4

Fuse terminal block for (10 x 38) mm (1 3/32" x 1 1/2") cylindrical fuses, with blown fuse indication, 90 ... 600 VAC, 115 ... 600 VDC, for DIN-35 rail per EN 60715, light gray  
Electrical ratings are given by the fuse and blown fuse indication.  
Operating temperature range: -35°C ... +85°C

Pole No.	Item No.	Pack. Unit
○ 1	811-311	12
○ 2	811-321	6
○ 3	811-331	4

Fuse terminal block for class CC fuses, with blown fuse indication, 90 ... 600 VAC, 115 ... 600 VDC, for DIN-35 rail per EN 60715, light gray  
Electrical ratings are given by the fuse and blown fuse indication.  
Operating temperature range: -35°C ... +85°C

Pole No.	Item No.	Pack. Unit
○ 1	811-411	12
○ 2	811-421	6
○ 3	811-431	4

Fuse terminal block for (10 x 38) mm (1 3/32" x 1 1/2") cylindrical fuses, with blown fuse indication, 24 VDC, for DIN-35 rail per EN 60715, light gray  
Electrical ratings are given by the fuse and blown fuse indication.  
Operating temperature range: -35°C ... +85°C

Pole No.	Item No.	Pack. Unit
○ 1	811-314	12

Fuse terminal block for class CC fuses, with blown fuse indication, 24 VDC, for DIN-35 rail per EN 60715, light gray  
Electrical ratings are given by the fuse and blown fuse indication.  
Operating temperature range: -35°C ... +85°C

Pole No.	Item No.	Pack. Unit
○ 1	811-414	12



IEC/EN 60947-7-3
AC
690 V
DC
1000 V
32 A
32 A
750 VAC, 30 AⓈ; 1000 VDC, 30 AⓈ; 600 VAC, 30 AⓈ; 1000 VDC, 30 AⓈ
2.5 ... 16 mm² / 16 ... 6 AWG
2.5 ... 16 mm² / 16 ... 6 AWG
12 ... 13 mm / 0.47 ... 0.51 inch
17 mm / 0.669 inch
Polyamide 66 (PA 66)

IEC/EN 60947-7-3
600 V, 30 AⓈ; 600 V, 30 AⓈ
2.5 ... 16 mm² / 16 ... 6 AWG
2.5 ... 16 mm² / 16 ... 6 AWG
12 ... 13 mm / 0.47 ... 0.51 inch
17 mm / 0.669 inch
Polyamide 66 (PA 66)

## Application Notes on Terminal Blocks for Miniature Metric Fuses

### Terminal Blocks for Miniature Metric Fuses Tested per IEC or EN 60947-7-3/VDE 0611-6

When selecting miniature metric fuses, make sure that the maximum power loss listed below is not exceeded.

The power loss is determined per IEC or EN 60947-7-3/VDE 0611-6 at 23 °C.

The temperature rise of the terminal blocks must be checked according to their application and mounting.

Higher ambient temperatures represent an additional impact on miniature fuses.

Therefore, in such applications, the rated current must be reduced if necessary.

More details are available from the manufacturers.

#### Miniature Metric Fuses, (5 x 20) mm

Series Item No.	Overload and Short-Circuit Protection		Short-Circuit Protection Only	
	Individual Arrangement	Block Arrangement	Individual Arrangement	Block Arrangement
Fuse terminal blocks (with screw cap), front-entry (5 x 20 mm)				
282-122 282-124	2.5 W	2.5 W	4 W	4 W
Fused disconnect terminal block with a pivoting fuse holder for miniature metric fuses (5 x 20 mm)				
281-611 281-616 281-611/281-541 281-611/281-542 281-611/281-417 281-611/281-418	2.5 W	1.6 W	4 W	4 W
Fuse plugs for miniature metric fuses (5 x 20 mm)				
281-511 281-512 281-512/281-501 281-512/281-418 281-512/281-417	2.5 W	1.6 W	4 W	4 W

5

**Miniature Metric Fuses, (6.3 x 32) mm**

Series Item No.	Overload and Short-Circuit Protection		Short-Circuit Protection Only	
	Individual Arrangement	Block Arrangement	Individual Arrangement	Block Arrangement
Fuse terminal blocks (with screw cap), front-entry (1/4" x 11/4" ≈ 6.3 x 32 mm)				
282-128 282-128/281-418 282-128/281-413 282-128/281-417	2.5 W	2.5 W	4 W	4 W
Fused disconnect terminal block with a pivoting fuse holder for miniature metric fuses (1/4" x 11/4" ≈ 6.3 x 32 mm)				
281-623 281-623/281-541 281-623/281-542 281-623/281-417 281-623/281-418	2.5 W	1.6 W	4 W	2.5 W

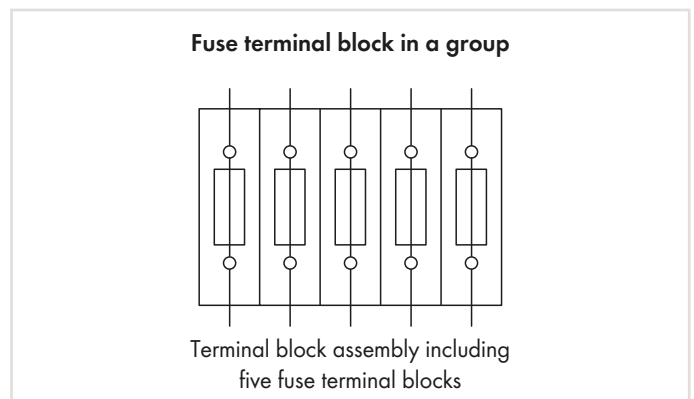
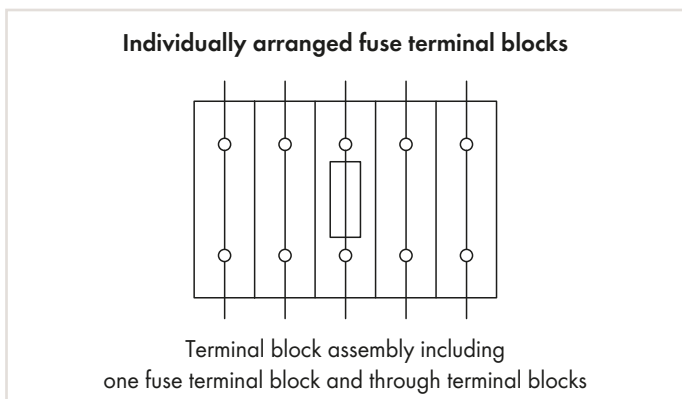

## Sensor and Actuator Terminal Blocks, 280 Series Description and Installation

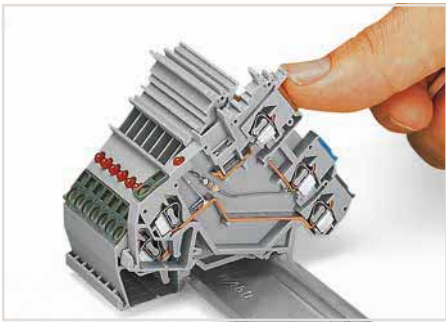

Snapping a terminal block onto the carrier rail – terminal blocks with a grounding foot automatically establish a direct contact to the rail.

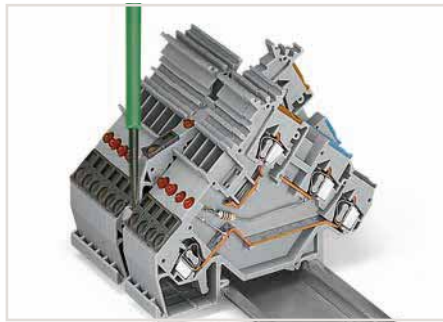

Removing a terminal block from the carrier rail. Notice: Remove jumper contacts first.

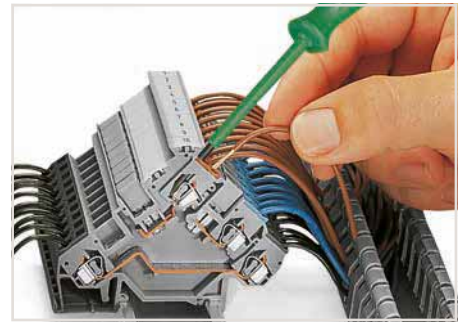

**CAGE CLAMP® connection**  
Inserting a conductor via straight operating tool (210-720).

5

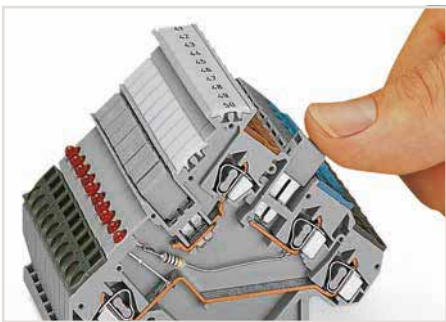

Commoning using an adjacent jumper (280-402). Push jumper down until fully inserted.

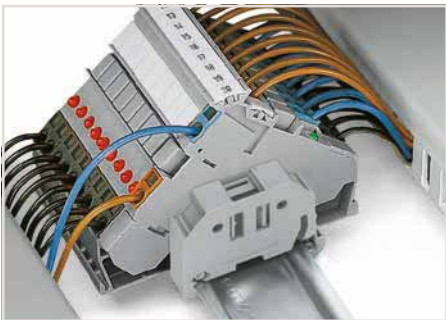

Sensor terminal blocks – power supply from control panel side

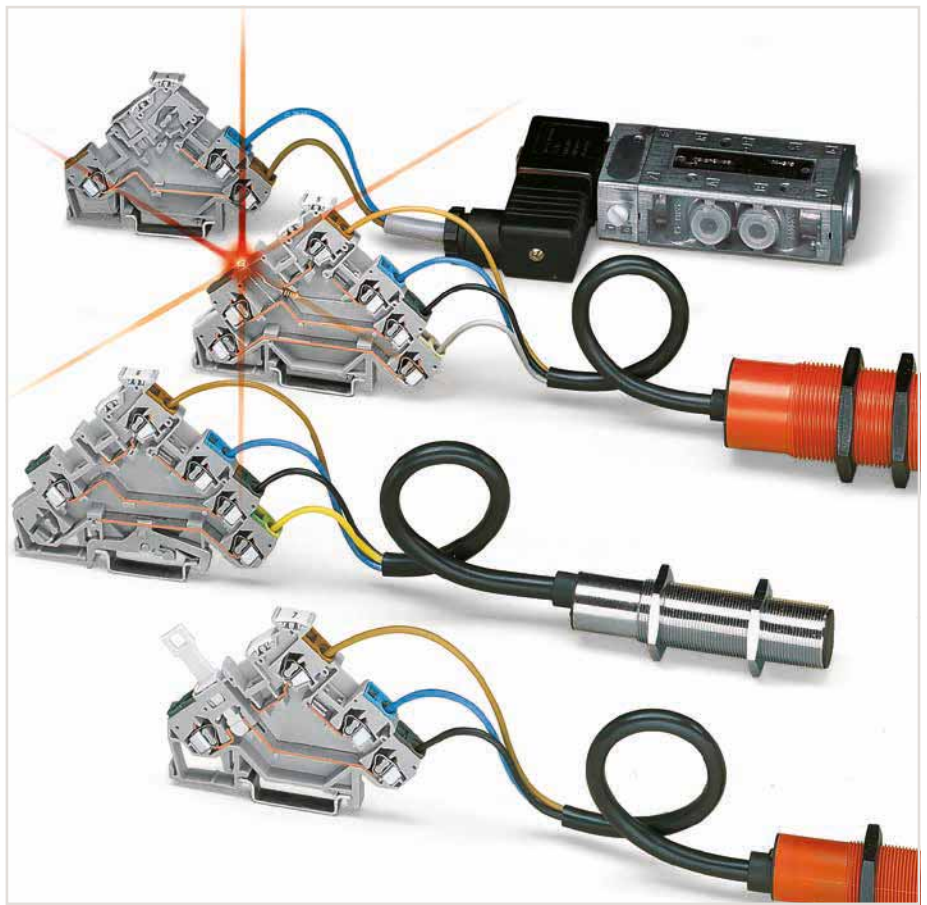

Sensor terminal blocks – power supply from sensor side

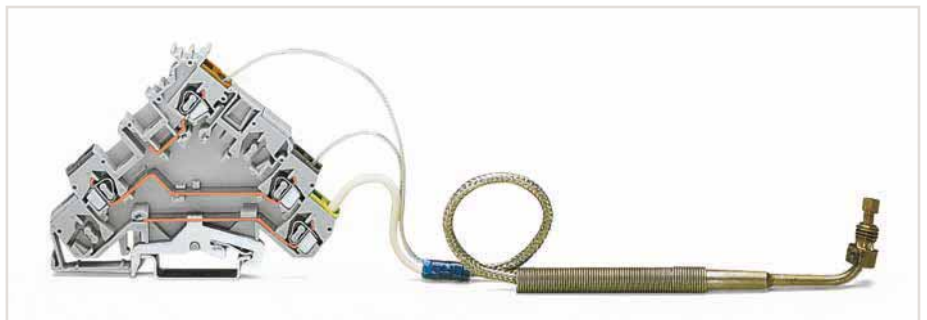

Actuator terminal block with thermocouple (shield connection)



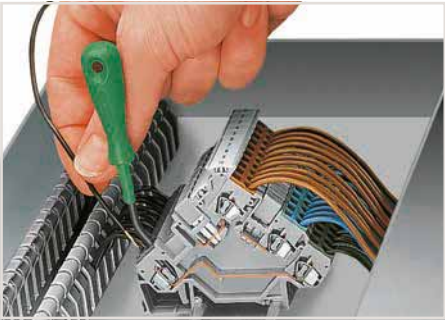

**CAGE CLAMP® connection**  
Inserting a conductor via angled operating tool (210-658).

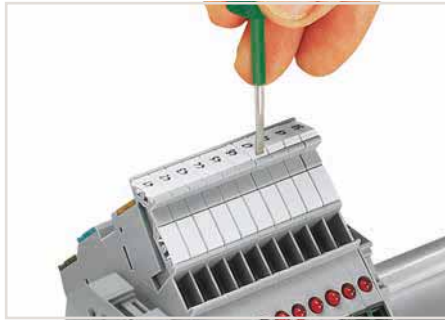

Labeling via WMB Multi Marking System.

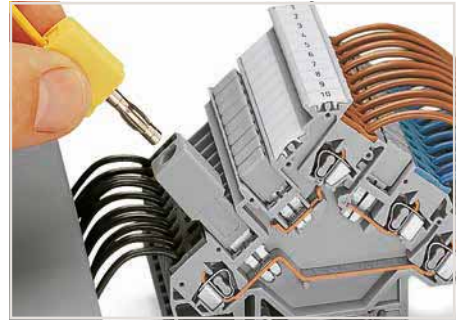

Testing via banana plug and test plug adapter (209-170).

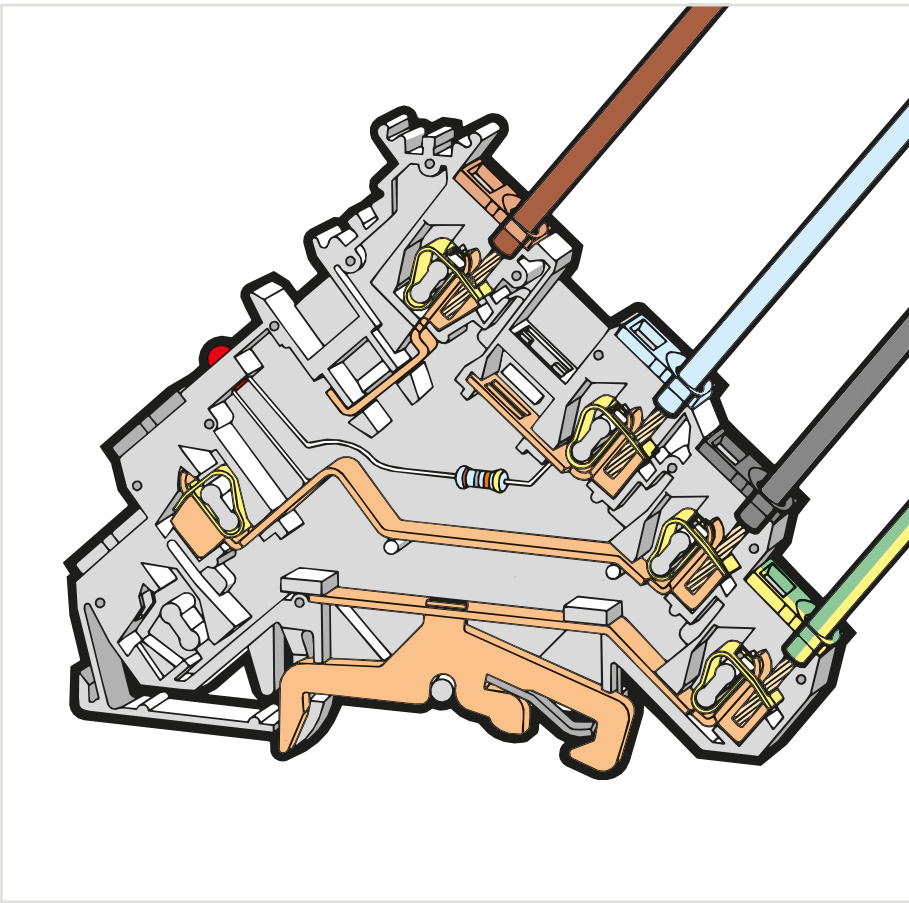

Testing via voltage tester directly on the current bar.



Actuator terminal blocks with fuse holders (281-511) – intermediate plates are required!



Actuator terminal block with thermocouple

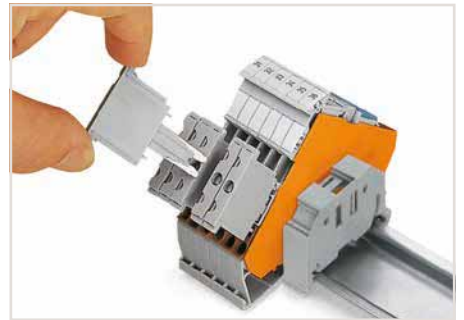

Actuator terminal blocks with component plugs (280-801)

5

## Sensor and Actuator Terminal Blocks, 280 Series Application Examples

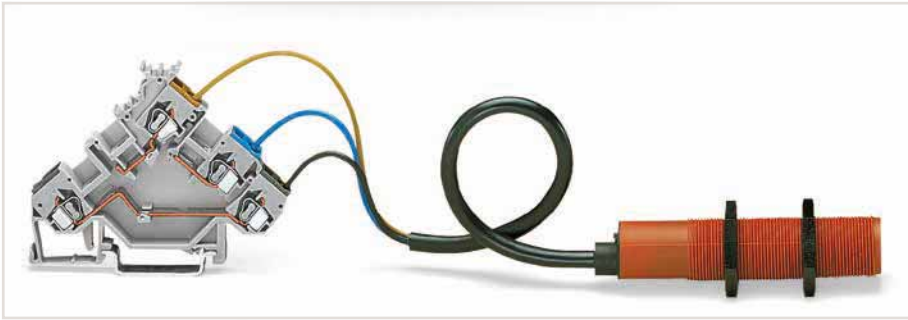

Sensor terminal block paired with a 3-conductor sensor

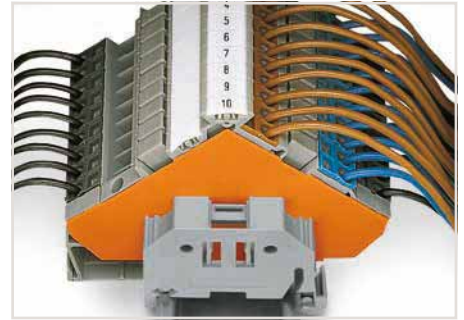

5

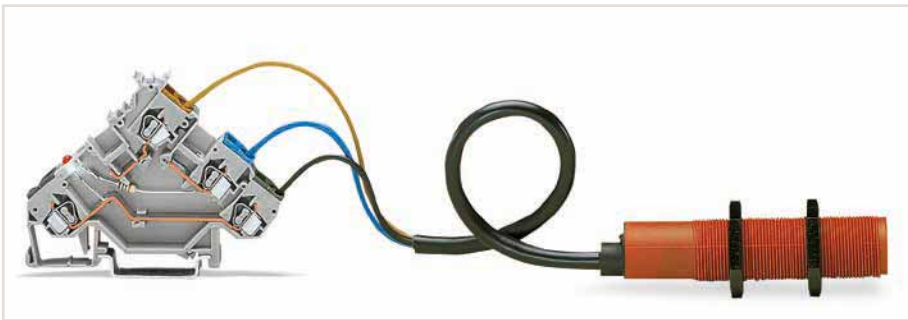

Sensor LED terminal block paired with a 3-conductor sensor

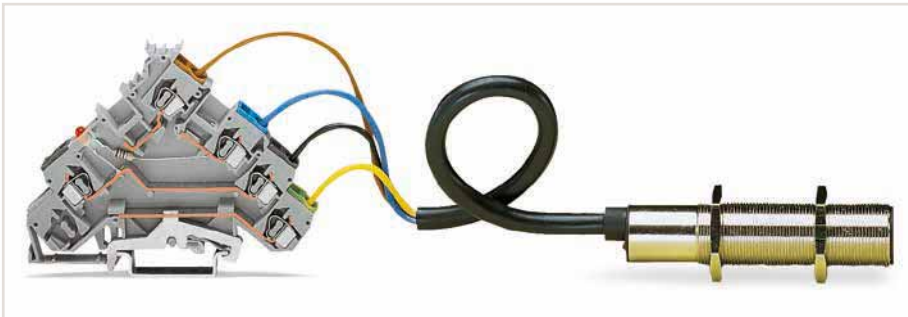
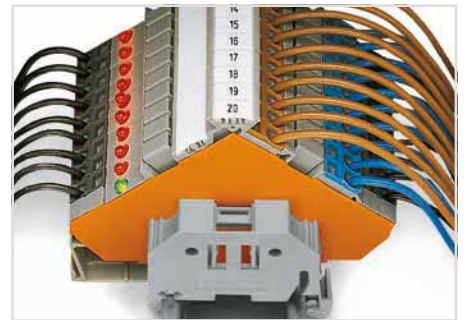

Sensor LED terminal block paired with a 3-conductor sensor (ground connection)

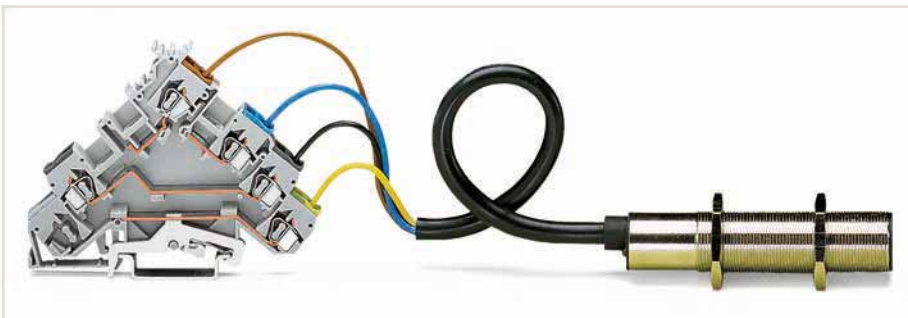

Sensor terminal block paired with a 3-conductor sensor (ground connection)





## Sensor and Actuator Terminal Blocks, 280 Series Application Examples

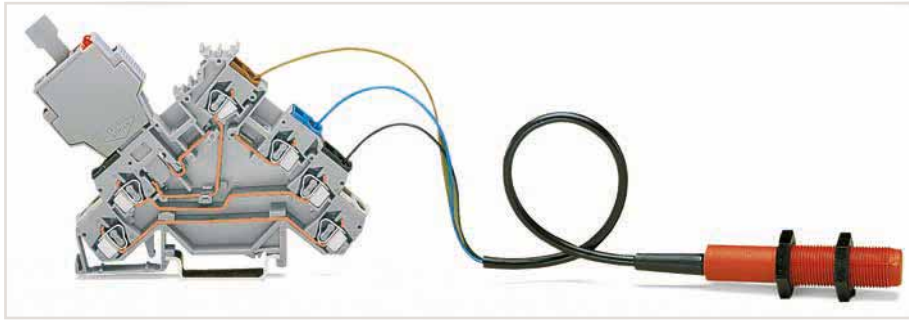

Sensor terminal block (with a fuse plug) paired with a 3-conductor sensor

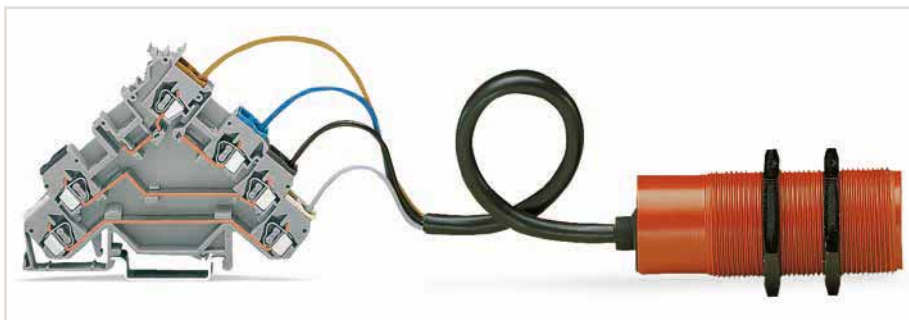

Sensor terminal block paired with a 4-conductor sensor

## Sensor and Actuator Terminal Blocks, 280 Series Application Examples

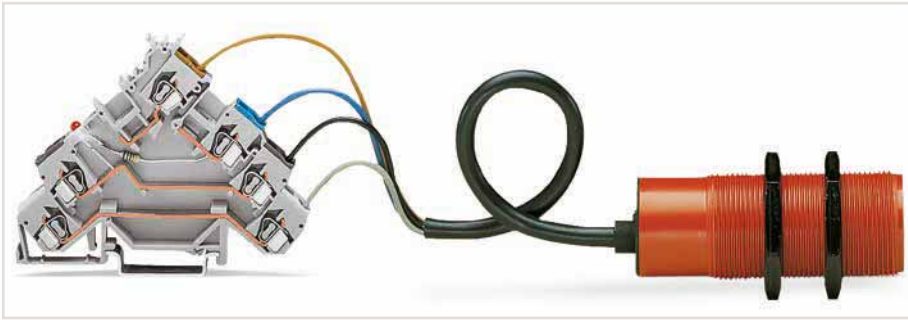

Sensor LED terminal block paired with a 4-conductor sensor



Actuator terminal block paired with a magnetic valve

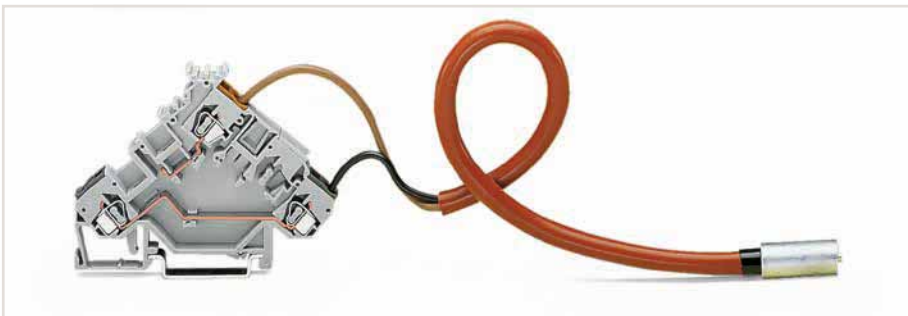
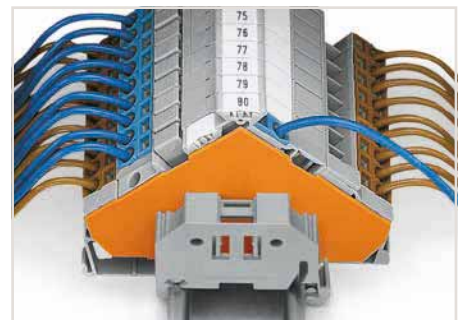

Actuator terminal block paired with a thermocouple

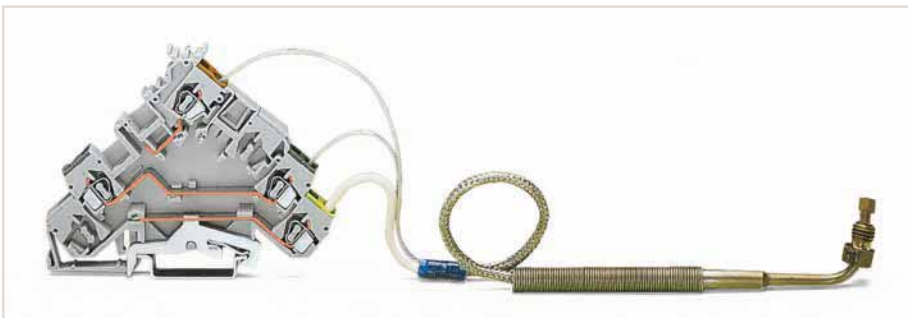

Actuator terminal block (ground connection) paired with a thermocouple



5

## Sensor and Actuator Terminal Blocks, 280 Series Application Examples

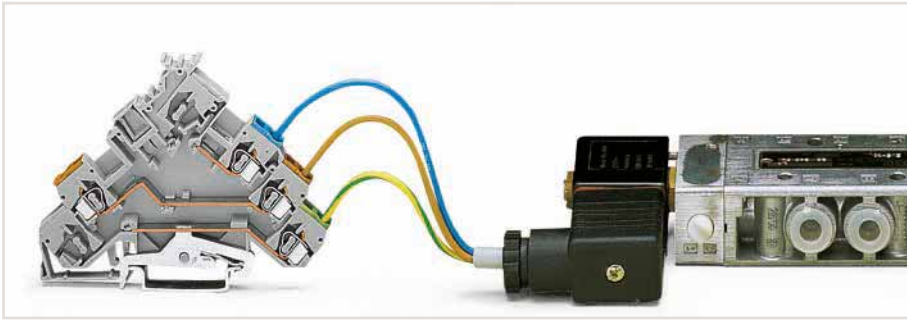

Actuator terminal block (ground connection) paired with a magnetic valve

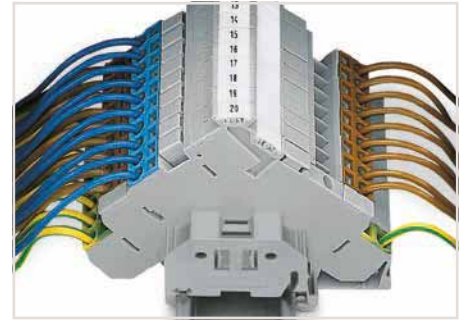

# Sensor Terminal Blocks for 3-Conductor Sensors 2.5 mm<sup>2</sup>, 280 Series

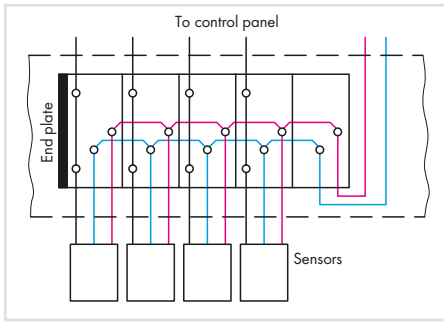

Power supply from sensor side

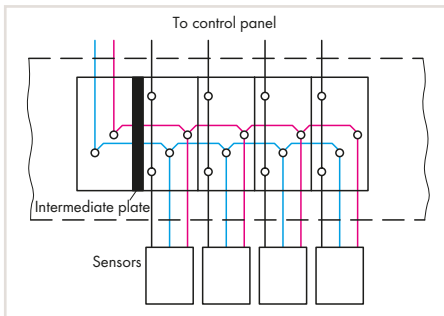

Power supply from control panel side

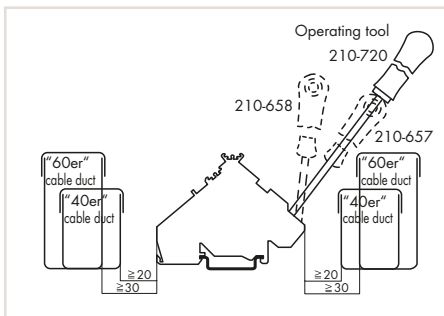

Min. mounting distance – terminal blocks to cable duct

Electrical ratings are given by the fuse plug or empty component plug housing.

Empty component plug housings, see Full Line Catalog, Interface Modules, Volume 4

x = 12 mm / 0.472 inch

Fuse plug (280-850), see page 380

x = 20 mm / 0.787 inch

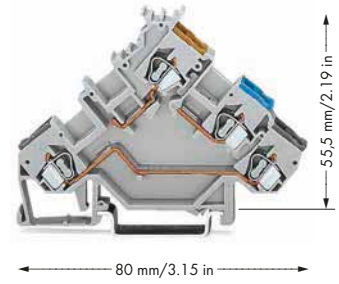

280-560

280-553



Sensor terminal block, with ground connection

Color	Item No.	Pack. Unit
gray	280-560	50
gray	280-553	50



### Technical Data

Rated voltage (III / 3)	400 V
Rated surge voltage (III / 3)	6 kV
Rated current	20 A
Approval	300 V, 15 A ; 300 V, 15 A
<b>Connection Data</b>	
Solid conductor	0.08 ... 2.5 mm <sup>2</sup> / 28 ... 12 AWG
Fine-stranded conductor	0.08 ... 2.5 mm <sup>2</sup> / 28 ... 12 AWG
Note (conductor cross section)	12 AWG: THHN, THWN
Strip length	8 ... 9 mm / 0.31 ... 0.35 inch
Terminal block width	5 mm / 0.197 inch
Insulation material	Polyamide 66 (PA 66)

### Note

### Accessories (Selection)

Adjacent jumper, insulated, I <sub>N</sub> = I <sub>N</sub> terminal block	gray	280-402	440
End and intermediate plate, for triple-deck terminal blocks, 1 mm thick	orange	280-321	444
Fuse plug, with soldered miniature fuse, 5 mm wide, gray			
WMB Inline, plain, 1,500 WMB markers (5 mm) per reel, 5 ... 5.2 mm stretchable	white	2009-115	780

Accessories (jumpers, end plates, etc.), see page 440

Carrier rails and tools, see Section 13

Appropriate marking system, WMB/WMB Inline, see Full Line Catalog, Volume 6

Approvals and corresponding ratings, visit [www.wago.com](http://www.wago.com)

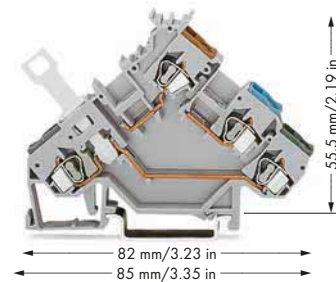
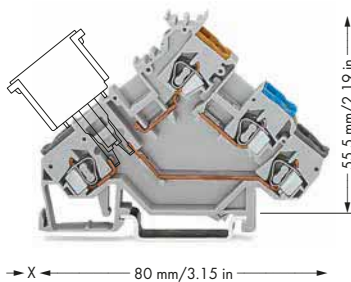
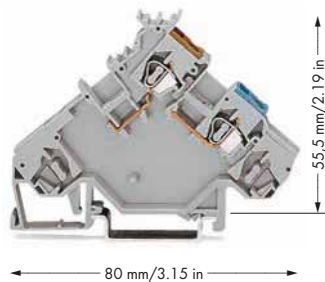

280-564

280-561

280-563

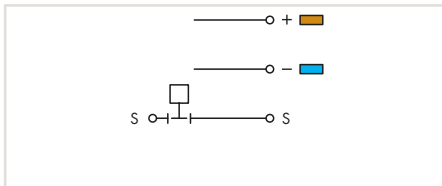

Sensor terminal block, with ground connection, for component plugs

Sensor disconnect terminal block, with ground connection, for signal interruption

Sensor supply terminal block, with ground connection, power supply from control panel side, with end plate

Color	Item No.	Pack. Unit
gray	280-564	10

Color	Item No.	Pack. Unit
gray	280-561	50

Color	Item No.	Pack. Unit
gray	280-563	50



400 V
6 kV
20 A
300 V, 15 A ; 300 V, 15 A

250 V
4 kV
6 A
300 V, 6 A ; 300 V, 15 A

400 V
6 kV
10 A
300 V, 10 A ; 300 V, 15 A

0.08 ... 2.5 mm <sup>2</sup> / 28 ... 12 AWG
0.08 ... 2.5 mm <sup>2</sup> / 28 ... 12 AWG
12 AWG: THHN, THWN
8 ... 9 mm / 0.31 ... 0.35 inch
5 mm / 0.197 inch
Polyamide 66 (PA 66)

0.08 ... 2.5 mm <sup>2</sup> / 28 ... 12 AWG
0.08 ... 2.5 mm <sup>2</sup> / 28 ... 12 AWG
12 AWG: THHN, THWN
8 ... 9 mm / 0.31 ... 0.35 inch
5 mm / 0.197 inch
Polyamide 66 (PA 66)

0.08 ... 2.5 mm <sup>2</sup> / 28 ... 12 AWG
0.08 ... 2.5 mm <sup>2</sup> / 28 ... 12 AWG
12 AWG: THHN, THWN
8 ... 9 mm / 0.31 ... 0.35 inch
5 mm / 0.197 inch
Polyamide 66 (PA 66)

Electrical ratings are given by the fuse plug or empty component plug housing.

	Item No.	Page
gray	280-402	440
orange	280-321	444
white	2009-115	780

	Item No.	Page
gray	280-402	440
orange	280-321	444
gray	280-850	382
white	2009-115	780

	Item No.	Page
gray	280-402	440
orange	280-321	444
white	2009-115	780

## Sensor Terminal Blocks for 3-Conductor Sensors and Spacers 2.5 mm<sup>2</sup>, 280 Series

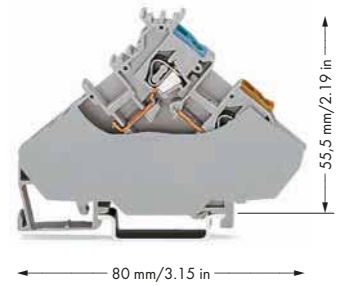
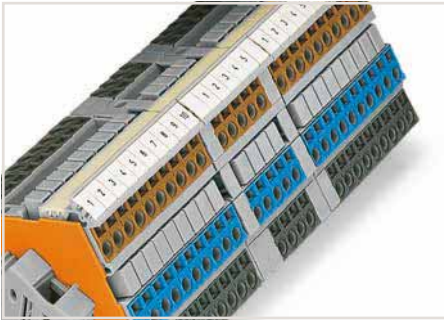

280-567



Sensor supply terminal block, power supply from control panel side, with end plate

Color	Item No.	Pack. Unit
○ gray	280-567	20



### Technical Data

Rated voltage (III / 3)	400 V
Rated surge voltage (III / 3)	6 kV
Rated current	20 A
Approval	300 V, 15 A ; 300 V, 15 A
<b>Connection Data</b>	
Solid conductor	0.08 ... 2.5 mm <sup>2</sup> / 28 ... 12 AWG
Fine-stranded conductor	0.08 ... 2.5 mm <sup>2</sup> / 28 ... 12 AWG
Note (conductor cross section)	12 AWG: THHN, THWN
Strip length	8 ... 9 mm / 0.31 ... 0.35 inch
Terminal block width	6 mm / 0.236 inch
Insulation material	Polyamide 66 (PA 66)

### Note

### Accessories (Selection)

Adjacent jumper, insulated, I <sub>N</sub> = I <sub>N</sub> terminal block	gray	280-402	440
End and intermediate plate, for triple-deck terminal blocks, 1 mm thick	orange	280-321	444
End and intermediate plate, for quadruple-deck terminal blocks, 1 mm thick			
WMB Inline, plain, 1,500 WMB markers (5 mm) per reel, 5 ... 5.2 mm stretchable	white	2009-115	780

5

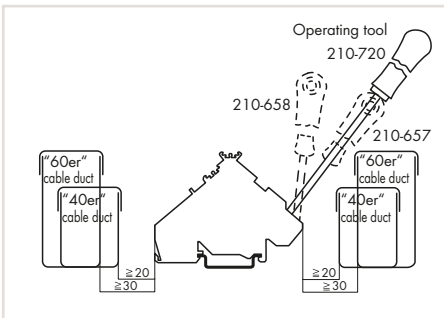

Min. mounting distance – terminal blocks to cable duct

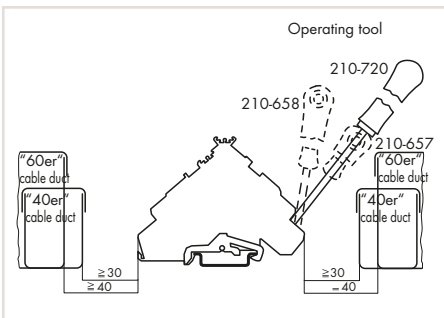

Min. mounting distance – terminal blocks to cable duct

Accessories (jumpers, end plates, etc.), see page 440

Carrier rails and tools, see Section 13

Appropriate marking system, WMB/WMB Inline, see Full Line Catalog, Volume 6

Approvals and corresponding ratings, visit [www.wago.com](http://www.wago.com)



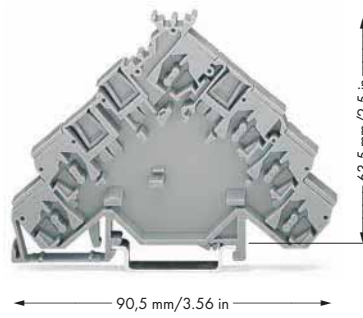
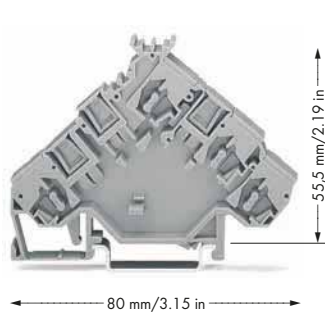

Spacer, same profile as 3-conductor sensor terminal blocks or corresponding actuator terminal blocks

Color	Item No.	Pack. Unit
○ gray	280-564	50

Spacer, same profile as 4-conductor sensor terminal blocks, 3-conductor sensor terminal blocks with ground connection or corresponding actuator terminal blocks

Color	Item No.	Pack. Unit
○ gray	280-582	50

5 mm / 0.197 inch

Polyamide 66 (PA 66)

Spacers with the same profile clearly differentiate between sensor or actuator terminal groups, e.g., of different power supply.

5 mm / 0.197 inch

Polyamide 66 (PA 66)

Spacers with the same profile clearly differentiate between sensor or actuator terminal groups, e.g., of different power supply.

	Item No.	Page
orange	280-321	444
white	2009-115	780

	Item No.	Page
orange	280-323	444
white	2009-115	780

## Sensor LED Terminal Blocks for 3- and 4-Conductor Sensors 2.5 mm<sup>2</sup>, 280 Series



Other voltages are available upon request.

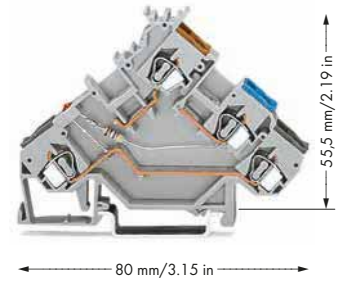

280-560/281-434

280-561/281-413

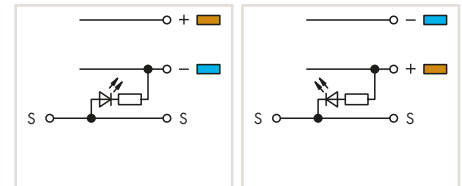

Sensor LED terminal block, for PNP (high-side) switching sensors, red LED

Color	Item No.	Pack. Unit
● gray	280-560/281-434	50

Sensor LED terminal block, for NPN (low-side) switching sensors, red LED

Color	Item No.	Pack. Unit
● gray	280-561/281-413	50

5

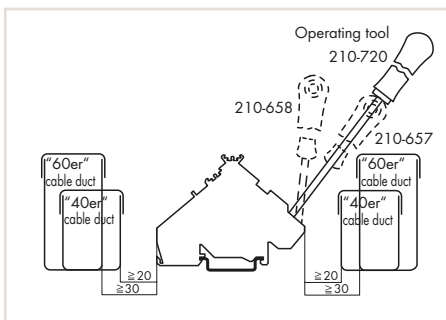

Min. mounting distance – terminal blocks to cable duct

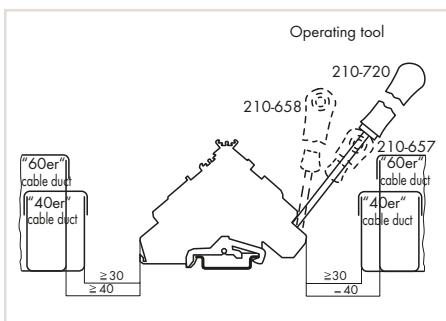

Min. mounting distance – terminal blocks to cable duct

### Technical Data

Voltage type	DC
Nominal voltage	24 V
Rated current	20 A
Approval	24 V, 15 A ; 300 V, 15 A

### Connection Data

Solid conductor	0.08 ... 2.5 mm <sup>2</sup> / 28 ... 12 AWG
Fine-stranded conductor	0.08 ... 2.5 mm <sup>2</sup> / 28 ... 12 AWG
Note (conductor cross section)	12 AWG: THHN, THWN
Strip length	8 ... 9 mm / 0.31 ... 0.35 inch
Terminal block width	5 mm / 0.197 inch
Insulation material	Polyamide 66 (PA 66)

### Note



DC
24 V
20 A
24 V, 15 A ; 300 V, 15 A

0.08 ... 2.5 mm <sup>2</sup> / 28 ... 12 AWG
0.08 ... 2.5 mm <sup>2</sup> / 28 ... 12 AWG
12 AWG: THHN, THWN
8 ... 9 mm / 0.31 ... 0.35 inch
5 mm / 0.197 inch
Polyamide 66 (PA 66)
LED power consumption: 4.8 mA

### Accessories (Selection)

Adjacent jumper, insulated, I <sub>N</sub> = I <sub>N</sub> terminal block
End and intermediate plate, for triple-deck terminal blocks, 1 mm thick
End and intermediate plate, for quadruple-deck terminal blocks, 1 mm thick
WMB Inline, plain, 1,500 WMB markers (5 mm) per reel, 5 ... 5.2 mm stretchable

	Item No.	Page
gray	280-402	440
orange	280-321	444
white	2009-115	780

Accessories (jumpers, end plates, etc.), see page 440

Carrier rails and tools, see Section 13

Appropriate marking system, WMB/WMB Inline, see Full Line Catalog, Volume 6

Approvals and corresponding ratings, visit [www.wago.com](http://www.wago.com)

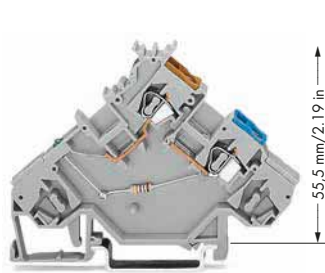

80 mm/3.15 in

55,5 mm/2.19 in

280-564/281-483

280-566/281-496

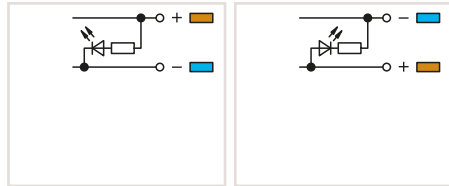

Sensor LED supply terminal block, power supply from sensor side, for PNP (high-side) switching sensors, green LED

Color	Item No.	Pack. Unit
gray	280-564/281-483	10

Sensor LED supply terminal block, power supply from sensor side, for NPN (low-side) switching sensors, green LED

Color	Item No.	Pack. Unit
gray	280-566/281-496	10



90,5 mm/3.56 in

63,5 mm/2.5 in

280-570/281-434

280-571/281-413

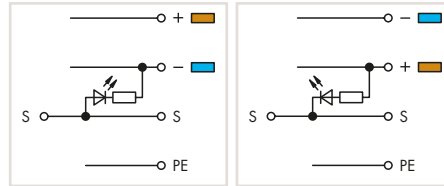

Sensor LED terminal block, for PNP (high-side) switching sensors, red LED

Color	Item No.	Pack. Unit
gray	280-570/281-434	50

Sensor LED terminal block, for NPN (low-side) switching sensors, red LED

Color	Item No.	Pack. Unit
gray	280-571/281-413	50



90,5 mm/3.56 in

63,5 mm/2.5 in

280-574/281-483

280-576/281-496

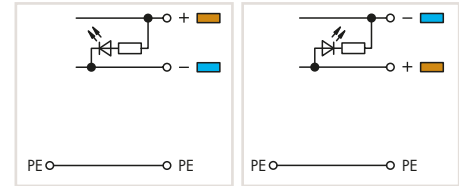

Sensor LED supply terminal block, power supply from sensor side, for PNP (high-side) switching sensors, green LED

Color	Item No.	Pack. Unit
gray	280-574/281-483	10

Sensor LED supply terminal block, power supply from control panel side, with end plate, for PNP (high-side) switching sensors, green LED  
Terminal block width: 6 mm (0.236 inch)

Color	Item No.	Pack. Unit
gray	280-576/281-496	10

Sensor LED supply terminal block, power supply from control panel side, with end plate, for PNP (high-side) switching sensors, green LED  
Terminal block width: 6 mm (0.236 inch)

Color	Item No.	Pack. Unit
gray	280-577/281-496	20



DC  
24 V  
20 A  
24 V, 15 A ; 300 V, 15 A

0.08 ... 2.5 mm<sup>2</sup> / 28 ... 12 AWG  
0.08 ... 2.5 mm<sup>2</sup> / 28 ... 12 AWG  
12 AWG: THHN, THWN  
8 ... 9 mm / 0.31 ... 0.35 inch  
5 mm / 0.197 inch  
Polyamide 66 (PA 66)  
LED power consumption: 4.8 mA

	Item No.	Page
gray	280-402	440
orange	280-321	444
white	2009-115	780



DC  
24 V  
20 A  
24 V, 15 A ; 300 V, 15 A

0.08 ... 2.5 mm<sup>2</sup> / 28 ... 12 AWG  
0.08 ... 2.5 mm<sup>2</sup> / 28 ... 12 AWG  
12 AWG: THHN, THWN  
8 ... 9 mm / 0.31 ... 0.35 inch  
5 mm / 0.197 inch  
Polyamide 66 (PA 66)  
LED power consumption: 4.8 mA

	Item No.	Page
gray	280-402	440
orange	280-323	444
white	2009-115	780



DC  
24 V  
20 A  
24 V, 15 A ; 300 V, 15 A

0.08 ... 2.5 mm<sup>2</sup> / 28 ... 12 AWG  
0.08 ... 2.5 mm<sup>2</sup> / 28 ... 12 AWG  
12 AWG: THHN, THWN  
8 ... 9 mm / 0.31 ... 0.35 inch  
5 mm / 0.197 inch  
Polyamide 66 (PA 66)  
LED power consumption: 4.8 mA

	Item No.	Page
gray	280-402	440
orange	280-323	444
white	2009-115	780

# Sensor Terminal Blocks with Ground Connection for 3-Conductor Sensors 2.5 mm<sup>2</sup>, 280 Series

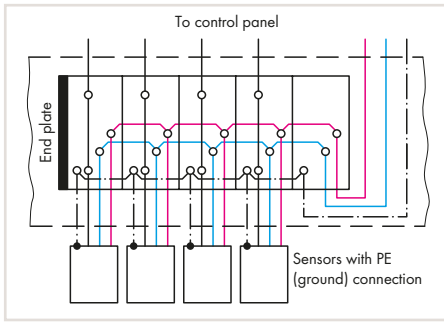

Power supply from sensor side

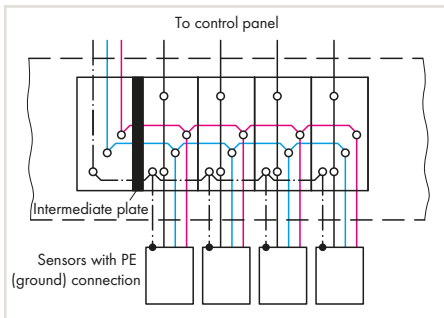

Power supply from control panel side

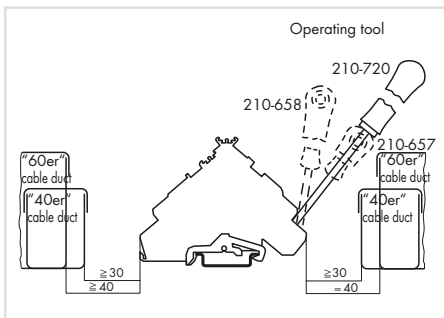

Min. mounting distance – terminal blocks to cable duct

Electrical ratings are given by the fuse plug or empty component plug housing.

Empty component plug housings, see Full Line Catalog, Interface Modules, Volume 4

x = 12 mm / 0.472 inch

Fuse plug (280-850), see page 380

x = 20 mm / 0.787 inch

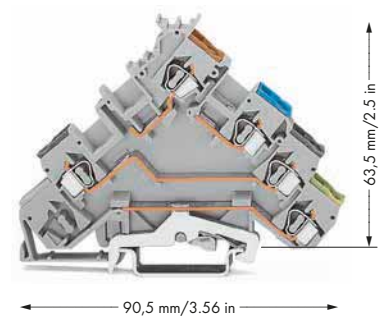

280-570

280-574

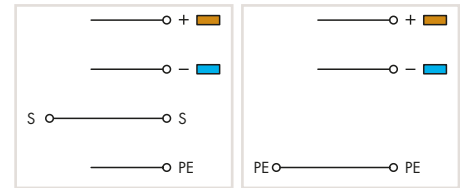

**Sensor terminal block**

Color	Item No.	Pack. Unit
gray	280-570	50

**Sensor supply terminal block, with ground connection, power supply from sensor side**

Color	Item No.	Pack. Unit
gray	280-574	10



**Technical Data**

Rated voltage (III / 3)	400 V
Rated surge voltage (III / 3)	6 kV
Rated current	20 A
Approval	300 V, 15 A  300 V, 15 A
<b>Connection Data</b>	
Solid conductor	0.08 ... 2.5 mm <sup>2</sup> / 28 ... 12 AWG
Fine-stranded conductor	0.08 ... 2.5 mm <sup>2</sup> / 28 ... 12 AWG
Note (conductor cross section)	12 AWG: THHN, THWN
Strip length	8 ... 9 mm / 0.31 ... 0.35 inch
Terminal block width	5 mm / 0.197 inch
Insulation material	Polyamide 66 (PA 66)

**Note**

**Accessories (Selection)**

- Adjacent jumper, insulated, I<sub>N</sub> = I<sub>N</sub> terminal block
- End and intermediate plate, for quadruple-deck terminal blocks, 1 mm thick
- Fuse plug, with soldered miniature fuse, 5 mm wide, gray
- WMB Inline, plain, 1,500 WMB markers (5 mm) per reel, 5 ... 5.2 mm stretchable

	Item No.	Page
gray	280-402	440
orange	280-323	444
white	2009-115	780

Accessories (jumpers, end plates, etc.), see page 440

Carrier rails and tools, see Section 13

Appropriate marking system, WMB/WMB Inline, see Full Line Catalog, Volume 6

Approvals and corresponding ratings, visit [www.wago.com](http://www.wago.com)

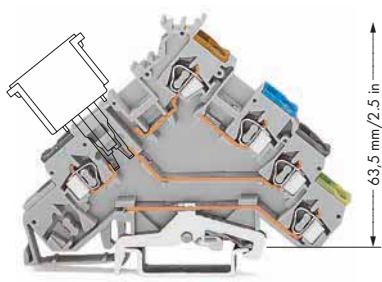

→ X ← 90,5 mm/3.56 in

63,5 mm/2.5 in

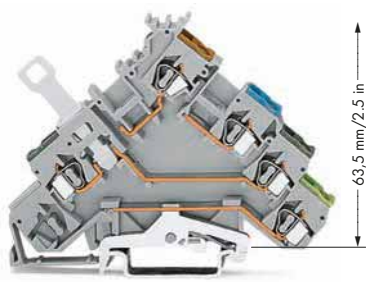

→ X ← 90,5 mm/3.56 in

63,5 mm/2.5 in

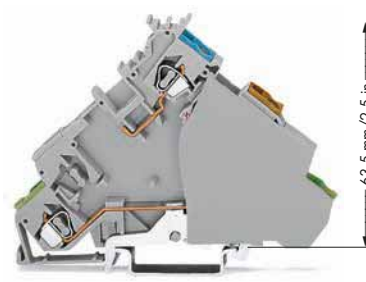

→ X ← 90,5 mm/3.56 in

63,5 mm/2.5 in

280-571

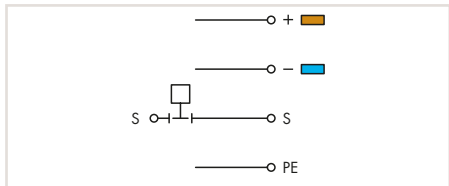

Sensor terminal block, with ground connection, for component plugs

Color	Item No.	Pack. Unit
gray	280-571	50

280-573

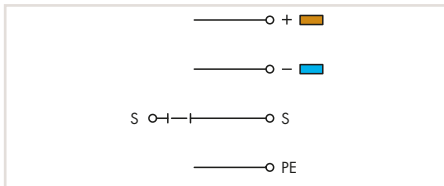

Sensor disconnect terminal block, with ground connection, for signal interruption

Color	Item No.	Pack. Unit
gray	280-573	50

280-577

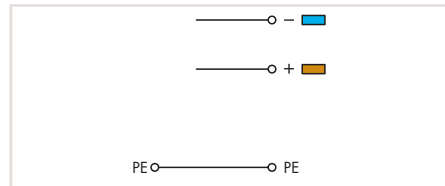

Sensor supply terminal block, with ground connection, power supply from control panel side, with end plate

Color	Item No.	Pack. Unit
gray	280-577	20



400 V  
6 kV  
20 A  
300 V, 15 A ; 300 V, 15 A

0.08 ... 2.5 mm<sup>2</sup> / 28 ... 12 AWG  
0.08 ... 2.5 mm<sup>2</sup> / 28 ... 12 AWG  
12 AWG: THHN, THWN  
8 ... 9 mm / 0.31 ... 0.35 inch  
5 mm / 0.197 inch  
Polyamide 66 (PA 66)

	Item No.	Page
gray	280-402	440
orange	280-323	444
gray	280-850	382
white	2009-115	780



250 V  
4 kV  
6 A  
300 V, 6 A ; 300 V, 15 A

0.08 ... 2.5 mm<sup>2</sup> / 28 ... 12 AWG  
0.08 ... 2.5 mm<sup>2</sup> / 28 ... 12 AWG  
12 AWG: THHN, THWN  
8 ... 9 mm / 0.31 ... 0.35 inch  
5 mm / 0.197 inch  
Polyamide 66 (PA 66)

Electrical ratings are given by the fuse plug or empty component plug housing.

	Item No.	Page
gray	280-402	440
orange	280-323	444
white	2009-115	780



400 V  
6 kV  
10 A  
300 V, 10 A ; 300 V, 15 A

0.08 ... 2.5 mm<sup>2</sup> / 28 ... 12 AWG  
0.08 ... 2.5 mm<sup>2</sup> / 28 ... 12 AWG  
12 AWG: THHN, THWN  
8 ... 9 mm / 0.31 ... 0.35 inch  
6 mm / 0.236 inch  
Polyamide 66 (PA 66)

	Item No.	Page
gray	280-402	440
orange	280-323	444
white	2009-115	780

## Sensor Terminal Blocks for 4-Conductor Sensors 2.5 mm<sup>2</sup>, 280 Series



The fuse plug is 1 mm wider than the terminal block, so an intermediate plate must be installed.

Electrical ratings are given by the fuse plug or empty component plug housing.

Empty component plug housings, see Full Line Catalog, Interface Modules, Volume 4

x = 12 mm / 0.472 inch

Fuse plug (281-511), see page 378

x = 15.5 mm / 0.61 inch

y = 10 mm / 0.394 inch

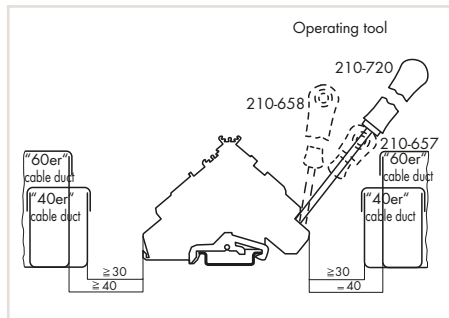
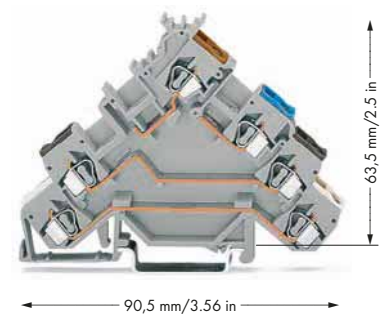

Min. mounting distance – terminal blocks to cable duct

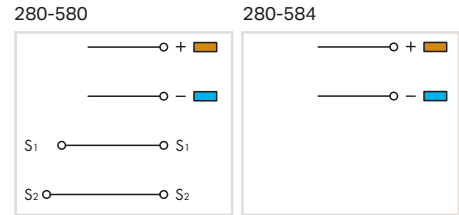

Sensor terminal block		
Color	Item No.	Pack. Unit
gray	280-580	50

Sensor supply terminal block, power supply from sensor side, without end plate		
Color	Item No.	Pack. Unit
gray	280-584	10



### Technical Data

Rated voltage (III / 3)	400 V
Rated surge voltage (III / 3)	6 kV
Rated voltage (III / 3) (2)	
Rated current	20 A
Rated current (2)	
Approval	300 V, 15 A ; 300 V, 15 A
<b>Connection Data</b>	
Solid conductor	0.08 ... 2.5 mm <sup>2</sup> / 28 ... 12 AWG
Fine-stranded conductor	0.08 ... 2.5 mm <sup>2</sup> / 28 ... 12 AWG
Note (conductor cross section)	12 AWG: THHN, THWN
Strip length	8 ... 9 mm / 0.31 ... 0.35 inch
Terminal block width	5 mm / 0.197 inch
Insulation material	Polyamide 66 (PA 66)

### Accessories (Selection)

	Item No.	Page
Adjacent jumper, insulated, I <sub>N</sub> = I <sub>N</sub> terminal block	gray 280-402	440
End and intermediate plate, for quadruple-deck terminal blocks, 1 mm thick	orange 280-323	444
Fuse plug with pull-tab, 6 mm wide		
WMB Inline, plain, 1,500 WMB markers (5 mm) per reel, 5 ... 5.2 mm stretchable	white 2009-115	780

Accessories (jumpers, end plates, etc.), see page 440

Carrier rails and tools, see Section 13

Appropriate marking system, WMB/WMB Inline, see Full Line Catalog, Volume 6

Approvals and corresponding ratings, visit [www.wago.com](http://www.wago.com)





## Sensor LED Terminal Blocks for 4-Conductor Sensors 2.5 mm<sup>2</sup>, 280 Series



Other voltages are available upon request.

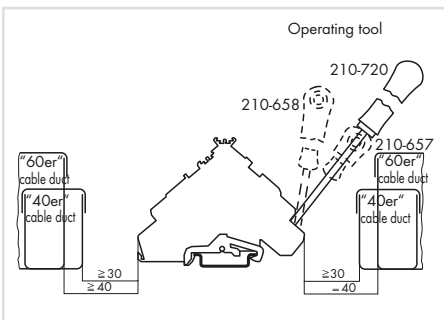
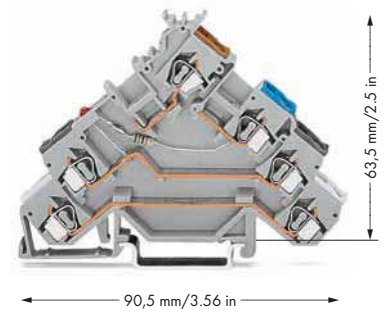

Min. mounting distance – terminal blocks to cable duct

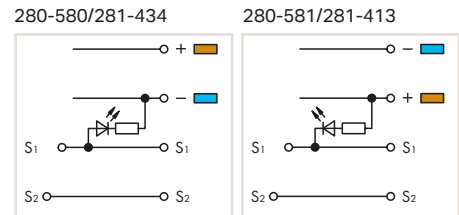

Sensor LED terminal block, for PNP (high-side) switching sensors, red LED

Color	Item No.	Pack. Unit
● gray	280-580/281-434	50

Sensor LED terminal block, for NPN (low-side) switching sensors, red LED

Color	Item No.	Pack. Unit
● gray	280-581/281-413	50



### Technical Data

Voltage type	DC
Nominal voltage	24 V
Rated current	20 A
Approval	24 V, 15 A
<b>Connection Data</b>	
Solid conductor	0.08 ... 2.5 mm <sup>2</sup> / 28 ... 12 AWG
Fine-stranded conductor	0.08 ... 2.5 mm <sup>2</sup> / 28 ... 12 AWG
Note (conductor cross section)	12 AWG: THHN, THWN
Strip length	8 ... 9 mm / 0.31 ... 0.35 inch
Terminal block width	5 mm / 0.197 inch
Insulation material	Polyamide 66 (PA 66)
<b>Note</b>	LED power consumption: 4.8 mA

### Accessories (Selection)

Adjacent jumper, insulated, I <sub>N</sub> = I <sub>N</sub> terminal block	
End and intermediate plate, for quadruple-deck terminal blocks, 1 mm thick	
WMB Inline, plain, 1,500 WMB markers (5 mm) per reel, 5 ... 5.2 mm stretchable	

	Item No.	Page
gray	280-402	440
orange	280-323	444
white	2009-115	780

Accessories (jumpers, end plates, etc.), see page 440

Carrier rails and tools, see Section 13

Appropriate marking system, WMB/WMB Inline, see Full Line Catalog, Volume 6

Approvals and corresponding ratings, visit [www.wago.com](http://www.wago.com)

5

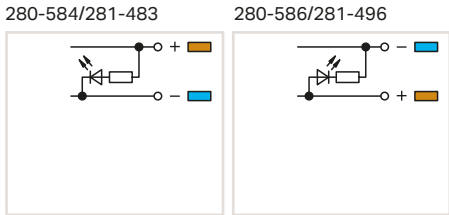
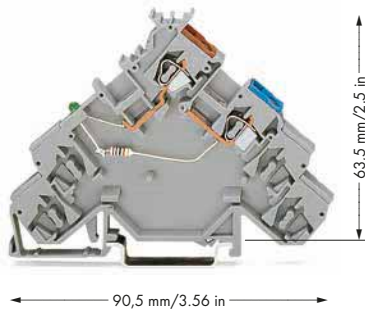

Sensor LED supply terminal block, power supply from sensor side, for PNP (high-side) switching sensors, green LED

Color	Item No.	Pack. Unit
○ gray	280-584/281-483	10

Sensor LED supply terminal block, power supply from sensor side, for NPN (low-side) switching sensors, green LED

Color	Item No.	Pack. Unit
○ gray	280-586/281-496	10



DC  
 24 V  
 20 A  
 24 V, 15 A ; 300 V, 15 A

0.08 ... 2.5 mm<sup>2</sup> / 28 ... 12 AWG  
 0.08 ... 2.5 mm<sup>2</sup> / 28 ... 12 AWG  
 12 AWG: THHN, THWN  
 8 ... 9 mm / 0.31 ... 0.35 inch  
 5 mm / 0.197 inch  
 Polyamide 66 (PA 66)  
 LED power consumption: 4.8 mA

	Item No.	Page
gray	280-402	440
orange	280-323	444
white	2009-115	780

# Actuator Terminal Blocks for Magnetic Valves and Servomotors

## 2.5 mm<sup>2</sup>, 280 Series

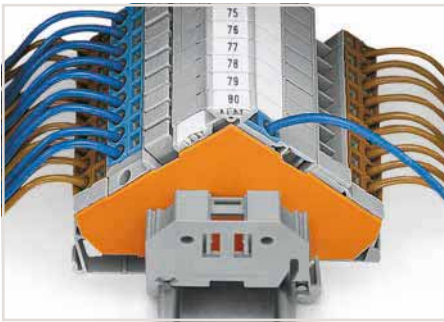

Electrical ratings are given by the fuse plug or empty component plug housing.

Empty component plug housings, see Full Line Catalog, Interface Modules, Volume 4

x = 12 mm / 0.472 inch  
 Fuse plug (281-511), see page 378  
 x = 15.5 mm / 0.61 inch  
 y = 10 mm / 0.394 inch

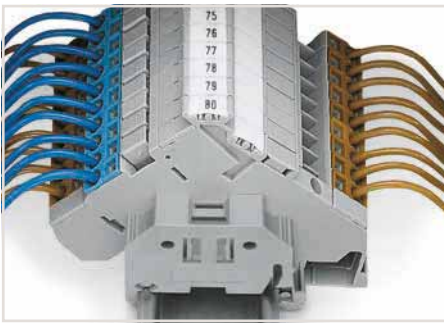
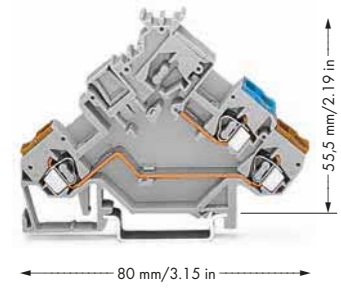

5

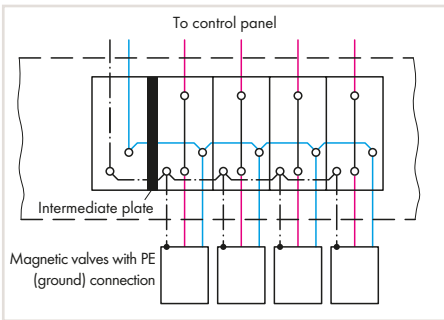

Power supply from control panel side

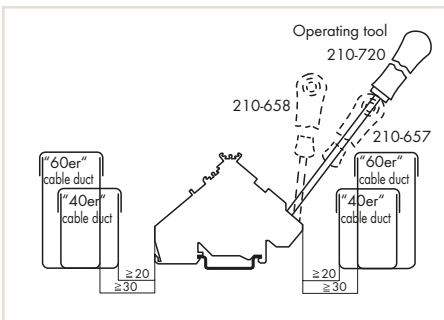

Min. mounting distance – terminal blocks to cable duct

### Technical Data

Rated voltage (III / 3)	400 V
Rated surge voltage (III / 3)	6 kV
Rated voltage (III / 3) (2)	250 V
Rated surge voltage (III / 3) (2)	4 kV
Rated current	20 A
Rated current (2)	20 A
Approval	300 V, 15 A ; 300 V, 15 A

### Connection Data

Solid conductor	0.08 ... 2.5 mm <sup>2</sup> / 28 ... 12 AWG
Fine-stranded conductor	0.08 ... 2.5 mm <sup>2</sup> / 28 ... 12 AWG
Note (conductor cross section)	12 AWG: THHN, THWN
Strip length	8 ... 9 mm / 0.31 ... 0.35 inch
Terminal block width	5 mm / 0.197 inch
Insulation material	Polyamide 66 (PA 66)

### Note

### Accessories (Selection)

Adjacent jumper, insulated, I <sub>N</sub> = I <sub>N</sub> terminal block	gray	280-402	440
End and intermediate plate, for triple-deck terminal blocks, 1 mm thick	orange	280-321	444
Fuse plug with pull-tab, 6 mm wide	white	2009-115	780
WMB Inline, plain, 1,500 WMB markers (5 mm) per reel, 5 ... 5.2 mm stretchable			

280-562

280-562/281-411

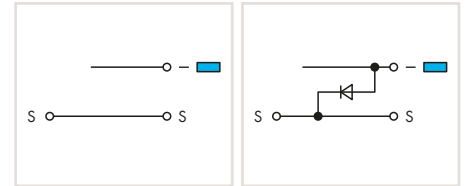

### Actuator terminal block

Color	Item No.	Pack. Unit
gray	280-562	50

### Actuator terminal block, with 1N4007 recovery diode

Color	Item No.	Pack. Unit
gray	280-562/281-411	50



Accessories (jumpers, end plates, etc.), see page 440

Carrier rails and tools, see Section 13

Appropriate marking system, WMB/WMB Inline, see Full Line Catalog, Volume 6

Approvals and corresponding ratings, visit [www.wago.com](http://www.wago.com)

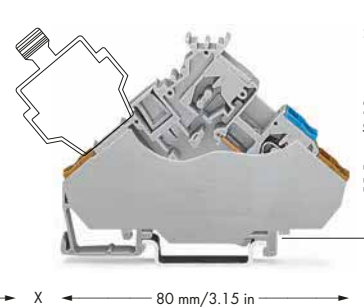
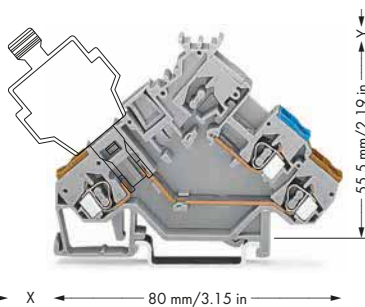
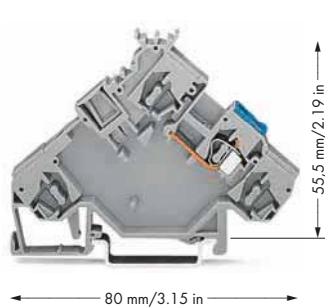

280-592

280-565

280-565/280-319

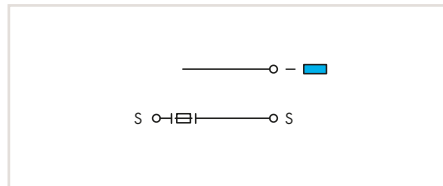
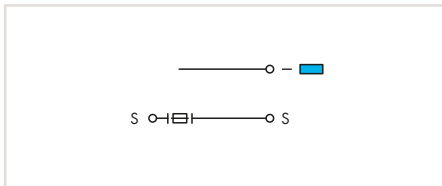
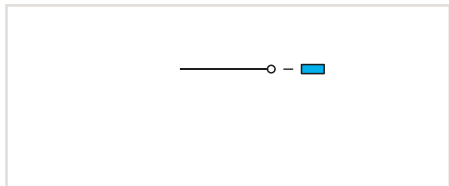

Actuator supply terminal block, power supply from actuator side

Color	Item No.	Pack. Unit
gray	280-592	50

Actuator terminal block, for fuse plugs, for phase protection, without end plate

Color	Item No.	Pack. Unit
gray	280-565	50

Actuator terminal block, for fuse plugs, for phase protection, with gray end plate

Color	Item No.	Pack. Unit
gray	280-565/280-319	50

Actuator terminal block, for fuse plugs, for phase protection, with orange end plate

Color	Item No.	Pack. Unit
gray	280-565/280-321	50



400 V  
6 kV

20 A

300 V, 15 A ; 300 V, 15 A

0.08 ... 2.5 mm<sup>2</sup> / 28 ... 12 AWG  
0.08 ... 2.5 mm<sup>2</sup> / 28 ... 12 AWG  
12 AWG: THHN, THWN  
8 ... 9 mm / 0.31 ... 0.35 inch  
5 mm / 0.197 inch  
Polyamide 66 (PA 66)

	Item No.	Page
gray	280-402	440
orange	280-321	444
white	2009-115	780



125 V  
250 V

5 A  
6.3 A

300 V, 6 A ; 300 V, 15 A

0.08 ... 2.5 mm<sup>2</sup> / 28 ... 12 AWG  
0.08 ... 2.5 mm<sup>2</sup> / 28 ... 12 AWG  
12 AWG: THHN, THWN  
8 ... 9 mm / 0.31 ... 0.35 inch  
5 mm / 0.197 inch  
Polyamide 66 (PA 66)

Electrical ratings are given by the fuse plug or empty component plug housing.

	Item No.	Page
gray	280-402	440
orange	280-321	444
gray	281-511	380
white	2009-115	780



125 V  
250 V

5 A  
6.3 A

0.08 ... 2.5 mm<sup>2</sup> / 28 ... 12 AWG  
0.08 ... 2.5 mm<sup>2</sup> / 28 ... 12 AWG  
12 AWG: THHN, THWN  
8 ... 9 mm / 0.31 ... 0.35 inch  
6 mm / 0.236 inch  
Polyamide 66 (PA 66)

Electrical ratings are given by the fuse plug or empty component plug housing.

	Item No.	Page
gray	280-402	440
orange	280-321	444
gray	281-511	380
white	2009-115	780

# Actuator Terminal Blocks for Magnetic Valves and Servomotors

## 2.5 mm<sup>2</sup>, 280 Series

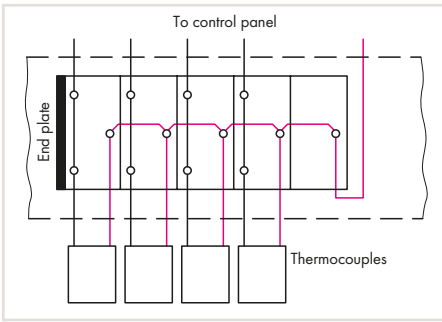

Power supply from actuator side

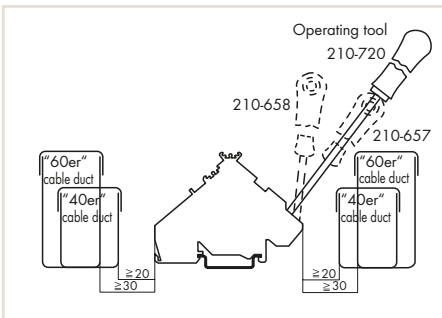

Min. mounting distance – terminal blocks to cable duct

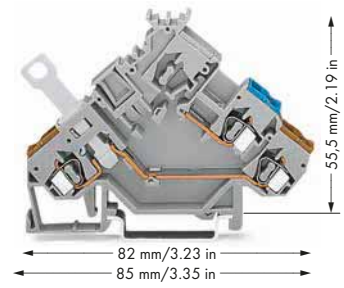

280-566

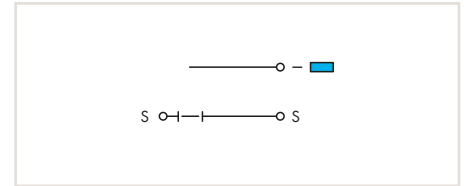

Actuator disconnect terminal block, for phase interruption

Color	Item No.	Pack. Unit
○ gray	280-566	50



### Technical Data

Rated voltage (III / 3)	400 V
Rated surge voltage (III / 3)	6 kV
Rated current	10 A
Approval	300 V, 10 A ; 300 V, 15 A

### Connection Data

Solid conductor	0.08 ... 2.5 mm <sup>2</sup> / 28 ... 12 AWG
Fine-stranded conductor	0.08 ... 2.5 mm <sup>2</sup> / 28 ... 12 AWG
Note (conductor cross section)	12 AWG: THHN, THWN
Strip length	8 ... 9 mm / 0.31 ... 0.35 inch
Terminal block width	5 mm / 0.197 inch
Insulation material	Polyamide 66 (PA 66)

### Accessories (Selection)

Adjacent jumper, insulated, I <sub>N</sub> = I <sub>N</sub> terminal block	
End and intermediate plate, for triple-deck terminal blocks, 1 mm thick	
WMB Inline, plain, 1,500 WMB markers (5 mm) per reel, 5 ... 5.2 mm stretchable	

Rated voltage (III / 3)	400 V
Rated surge voltage (III / 3)	6 kV
Rated current	10 A
Approval	300 V, 10 A ; 300 V, 15 A

Solid conductor	0.08 ... 2.5 mm <sup>2</sup> / 28 ... 12 AWG
Fine-stranded conductor	0.08 ... 2.5 mm <sup>2</sup> / 28 ... 12 AWG
Note (conductor cross section)	12 AWG: THHN, THWN
Strip length	8 ... 9 mm / 0.31 ... 0.35 inch
Terminal block width	5 mm / 0.197 inch
Insulation material	Polyamide 66 (PA 66)

	Item No.	Page
gray	280-402	440
orange	280-321	444
white	2009-115	780

5

Accessories (jumpers, end plates, etc.), see page 440

Carrier rails and tools, see Section 13

Appropriate marking system, WMB/WMB Inline, see Full Line Catalog, Volume 6

Approvals and corresponding ratings, visit [www.wago.com](http://www.wago.com)



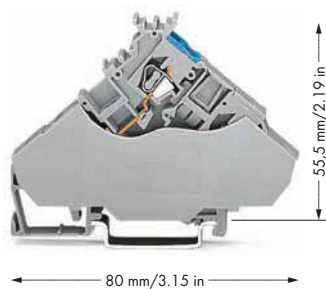

280-568



Actuator supply terminal block, power supply from control panel side, with end plate

Color	Item No.	Pack. Unit
○ gray	280-568	20

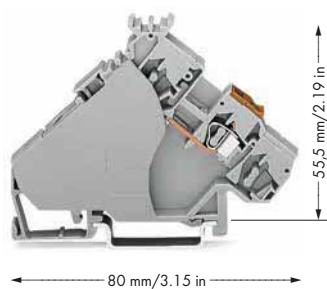

280-556

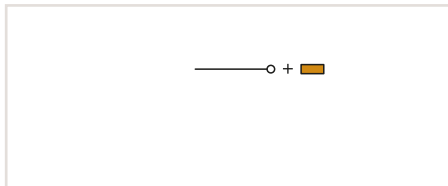

Actuator supply terminal block, in connection with 280-555: power supply from control panel side, in connection with 280-554: power supply from actuator side, with end plate

Color	Item No.	Pack. Unit
○ gray	280-556	20

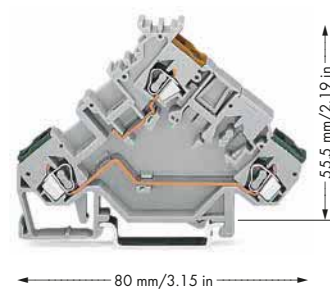

280-555

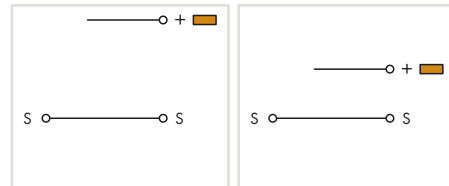

Actuator terminal block

Color	Item No.	Pack. Unit
○ gray	280-555	50

Actuator terminal block

Color	Item No.	Pack. Unit
○ gray	280-554	50

UL®

400 V
6 kV
20 A
300 V, 10 A <b>UL</b> ; 300 V, 15 A <b>UL</b>

0.08 ... 2.5 mm <sup>2</sup> / 28 ... 12 AWG
0.08 ... 2.5 mm <sup>2</sup> / 28 ... 12 AWG
12 AWG: THHN, THWN
8 ... 9 mm / 0.31 ... 0.35 inch
6 mm / 0.236 inch
Polyamide 66 (PA 66)

	Item No.	Page
gray	280-402	440
orange	280-321	444
white	2009-115	780

UL®

400 V
6 kV
20 A
300 V, 15 A <b>UL</b> ; 300 V, 15 A <b>UL</b>

0.08 ... 2.5 mm <sup>2</sup> / 28 ... 12 AWG
0.08 ... 2.5 mm <sup>2</sup> / 28 ... 12 AWG
12 AWG: THHN, THWN
8 ... 9 mm / 0.31 ... 0.35 inch
6 mm / 0.236 inch
Polyamide 66 (PA 66)

	Item No.	Page
gray	280-402	440
orange	280-321	444
white	2009-115	780

UL®

400 V
6 kV
20 A
300 V, 15 A <b>UL</b> ; 300 V, 15 A <b>UL</b>

0.08 ... 2.5 mm <sup>2</sup> / 28 ... 12 AWG
0.08 ... 2.5 mm <sup>2</sup> / 28 ... 12 AWG
12 AWG: THHN, THWN
8 ... 9 mm / 0.31 ... 0.35 inch
5 mm / 0.197 inch
Polyamide 66 (PA 66)

	Item No.	Page
gray	280-402	440
orange	280-321	444
white	2009-115	780

# Actuator Terminal Blocks with Ground Connection for Magnetic Valves and Servomotors

## 2.5 mm<sup>2</sup>, 280 Series

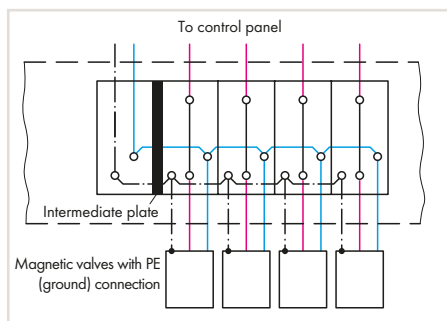

Power supply from control panel side

Electrical ratings are given by the fuse plug or empty component plug housing.

Empty component plug housings, see Full Line Catalog, Interface Modules, Volume 4

x = 12 mm / 0.472 inch

Fuse plug (281-511), see page 378

x = 15.5 mm / 0.61 inch

y = 10 mm / 0.394 inch

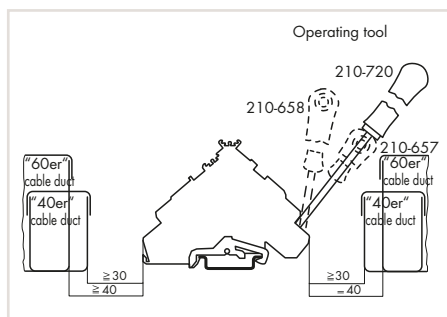

Min. mounting distance – terminal blocks to cable duct

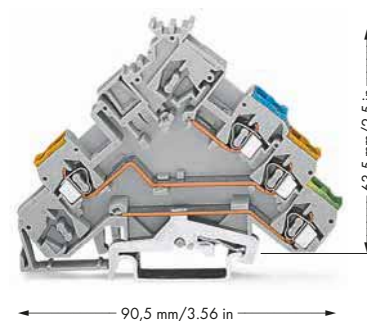

280-572

280-572/281-411



Actuator terminal block, with ground connection

Color	Item No.	Pack. Unit
○ gray	280-572	50

Actuator terminal block, with ground connection, with 1N4007 recovery diode

Color	Item No.	Pack. Unit
○ gray	280-572/281-411	50

WAGO

### Technical Data

Rated voltage (III / 3)	400 V
Rated surge voltage (III / 3)	6 kV
Rated voltage (III / 3) (2)	250 V
Rated surge voltage (III / 3) (2)	4 kV
Rated current	20 A
Rated current (2)	20 A
Approval	300 V, 15 A  300 V, 15 A

### Connection Data

Solid conductor	0.08 ... 2.5 mm <sup>2</sup> / 28 ... 12 AWG
Fine-stranded conductor	0.08 ... 2.5 mm <sup>2</sup> / 28 ... 12 AWG
Note (conductor cross section)	12 AWG: THHN, THWN
Strip length	8 ... 9 mm / 0.31 ... 0.35 inch
Terminal block width	5 mm / 0.197 inch
Insulation material	Polyamide 66 (PA 66)

### Note

### Accessories (Selection)

Adjacent jumper, insulated, I <sub>N</sub> = I <sub>N</sub> terminal block	gray	280-402	440
End and intermediate plate, for quadruple-deck terminal blocks, 1 mm thick	orange	280-323	444
Fuse plug with pull-tab, 6 mm wide			
WMB Inline, plain, 1,500 WMB markers (5 mm) per reel, 5 ... 5.2 mm stretchable	white	2009-115	780

Accessories (jumpers, end plates, etc.), see page 440

Carrier rails and tools, see Section 13

Appropriate marking system, WMB/WMB Inline, see Full Line Catalog, Volume 6

Approvals and corresponding ratings, visit [www.wago.com](http://www.wago.com)

5

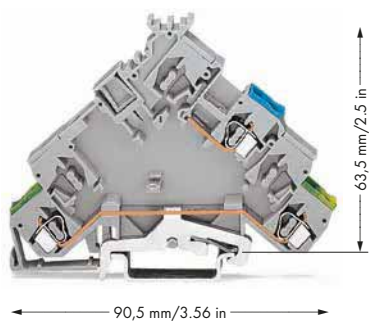

280-593

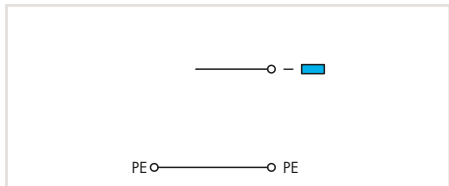

Actuator supply terminal block, with ground connection, power supply from actuator side

Color	Item No.	Pack. Unit
gray	280-593	10

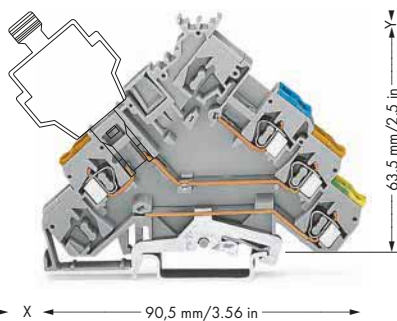

280-575

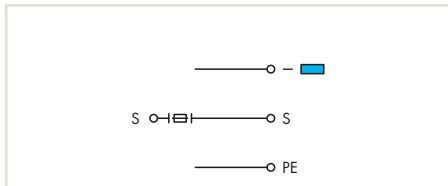

Actuator terminal block, with ground connection, for fuse plugs, for phase protection, without end plate

Color	Item No.	Pack. Unit
gray	280-575	50

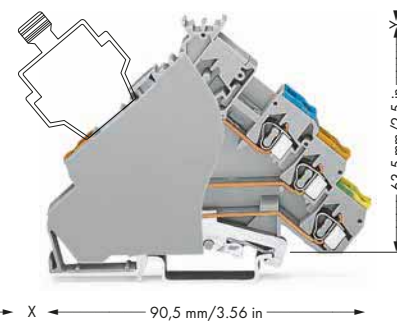

280-575/280-320

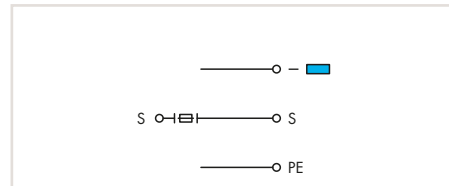

Actuator terminal block, with ground connection, for fuse plugs, for phase protection, with gray end plate

Color	Item No.	Pack. Unit
gray	280-575/280-320	50

Actuator terminal block, with ground connection, for fuse plugs, for phase protection, with orange end plate

Color	Item No.	Pack. Unit
gray	280-575/280-323	50

UL

400 V
6 kV
20 A
6.3 A
300 V, 15 A <b>UL</b> ; 300 V, 15 A <b>CE</b>
0.08 ... 2.5 mm <sup>2</sup> / 28 ... 12 AWG
0.08 ... 2.5 mm <sup>2</sup> / 28 ... 12 AWG
12 AWG: THHN, THWN
8 ... 9 mm / 0.31 ... 0.35 inch
5 mm / 0.197 inch
Polyamide 66 (PA 66)

	Item No.	Page
gray	280-402	440
orange	280-323	444
white	2009-115	780

UL

125 V
250 V
5 A
6.3 A
300 V, 6 A <b>UL</b> ; 300 V, 15 A <b>CE</b>
0.08 ... 2.5 mm <sup>2</sup> / 28 ... 12 AWG
0.08 ... 2.5 mm <sup>2</sup> / 28 ... 12 AWG
12 AWG: THHN, THWN
8 ... 9 mm / 0.31 ... 0.35 inch
5 mm / 0.197 inch
Polyamide 66 (PA 66)

Electrical ratings are given by the fuse plug or empty component plug housing.

	Item No.	Page
gray	280-402	440
orange	280-323	444
gray	281-511	380
white	2009-115	780

UL

125 V
250 V
5 A
6.3 A
300 V, 6 A <b>UL</b>
0.08 ... 2.5 mm <sup>2</sup> / 28 ... 12 AWG
0.08 ... 2.5 mm <sup>2</sup> / 28 ... 12 AWG
12 AWG: THHN, THWN
8 ... 9 mm / 0.31 ... 0.35 inch
6 mm / 0.236 inch
Polyamide 66 (PA 66)

Electrical ratings are given by the fuse plug or empty component plug housing.

	Item No.	Page
gray	280-402	440
orange	280-323	444
gray	281-511	380
white	2009-115	780

# Actuator Terminal Blocks with Ground Connection and Actuator LED Terminal Blocks for Magnetic Valves and Servomotors

## 2.5 mm<sup>2</sup>, 280 Series



Other voltages are available upon request.

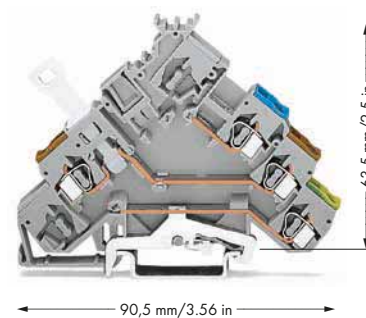

280-576



Actuator disconnect terminal block, with ground connection, for phase interruption

Color	Item No.	Pack. Unit
gray	280-576	50

5

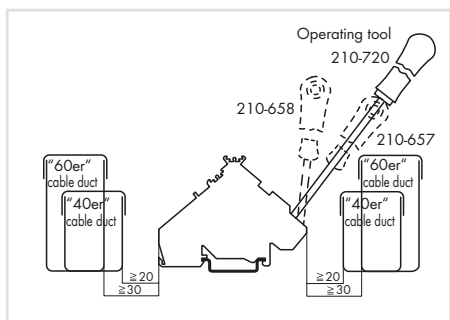

Min. mounting distance – terminal blocks to cable duct

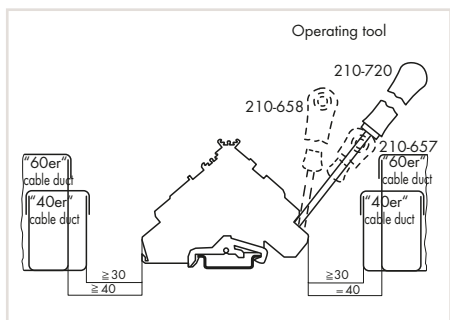

Min. mounting distance – terminal blocks to cable duct

### Technical Data

Voltage type	
Nominal voltage	
Rated voltage (III / 3)	400 V
Rated surge voltage (III / 3)	6 kV
Rated current	10 A
Approval	300 V, 15 A ; 300 V, 15 A
<b>Connection Data</b>	
Solid conductor	0.08 ... 2.5 mm <sup>2</sup> / 28 ... 12 AWG
Fine-stranded conductor	0.08 ... 2.5 mm <sup>2</sup> / 28 ... 12 AWG
Note (conductor cross section)	12 AWG: THHN, THWN
Strip length	8 ... 9 mm / 0.31 ... 0.35 inch
Terminal block width	5 mm / 0.197 inch
Insulation material	Polyamide 66 (PA 66)

### Note

### Accessories (Selection)

- Adjacent jumper, insulated, I<sub>N</sub> = I<sub>N</sub> terminal block
- End and intermediate plate, for triple-deck terminal blocks, 1 mm thick
- End and intermediate plate, for quadruple-deck terminal blocks, 1 mm thick
- WMB Inline, plain, 1,500 WMB markers (5 mm) per reel, 5 ... 5.2 mm stretchable

	Item No.	Page
gray	280-402	440
orange	280-323	444
white	2009-115	780

Accessories (jumpers, end plates, etc.), see page 440

Carrier rails and tools, see Section 13

Appropriate marking system, WMB/WMB Inline, see Full Line Catalog, Volume 6

Approvals and corresponding ratings, visit [www.wago.com](http://www.wago.com)

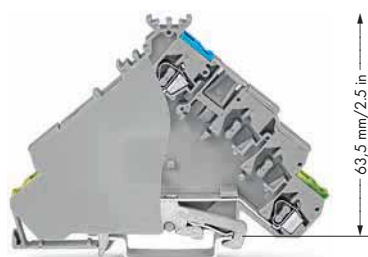

90,5 mm/3.56 in

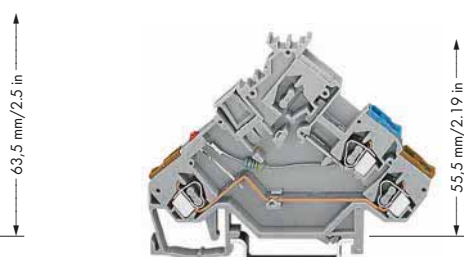

80 mm/3.15 in



90,5 mm/3.56 in

280-578

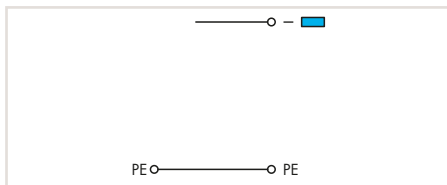

Actuator supply terminal block, with ground connection, power supply from control panel side, with end plate

Color	Item No.	Pack. Unit
gray	280-578	20

280-562/281-434

280-562/281-420

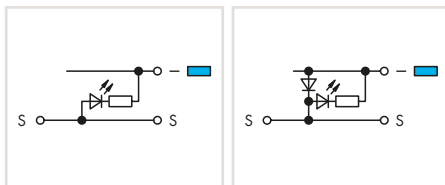

Actuator LED terminal block, red LED

Color	Item No.	Pack. Unit
gray	280-562/281-434	50

280-572/281-434

280-572/281-420

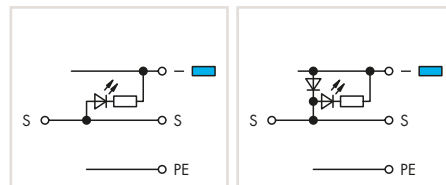

Actuator LED terminal block, with ground connection, red LED

Color	Item No.	Pack. Unit
gray	280-572/281-434	50

Actuator LED terminal block, with 1N4007 recovery diode, red LED

Color	Item No.	Pack. Unit
gray	280-562/281-420	50

Actuator LED terminal block, with ground connection, with 1N4007 recovery diode, red LED

Color	Item No.	Pack. Unit
gray	280-572/281-420	50



400 V  
6 kV  
20 A

0.08 ... 2.5 mm<sup>2</sup> / 28 ... 12 AWG  
0.08 ... 2.5 mm<sup>2</sup> / 28 ... 12 AWG  
12 AWG: THHN, THWN  
8 ... 9 mm / 0.31 ... 0.35 inch  
6 mm / 0.236 inch  
Polyamide 66 (PA 66)

DC  
24 V  
  
20 A  
24 V, 6 A ; 300 V, 15 A

0.08 ... 2.5 mm<sup>2</sup> / 28 ... 12 AWG  
0.08 ... 2.5 mm<sup>2</sup> / 28 ... 12 AWG  
12 AWG: THHN, THWN  
8 ... 9 mm / 0.31 ... 0.35 inch  
5 mm / 0.197 inch  
Polyamide 66 (PA 66)  
LED power consumption: 4.8 mA

DC  
24 V  
  
20 A  
24 V, 6 A ; 300 V, 15 A

0.08 ... 2.5 mm<sup>2</sup> / 28 ... 12 AWG  
0.08 ... 2.5 mm<sup>2</sup> / 28 ... 12 AWG  
12 AWG: THHN, THWN  
8 ... 9 mm / 0.31 ... 0.35 inch  
5 mm / 0.197 inch  
Polyamide 66 (PA 66)  
LED power consumption: 4.8 mA

	Item No.	Page
gray	280-402	440
orange	280-323	444
white	2009-115	780

	Item No.	Page
gray	280-402	440
orange	280-321	444
white	2009-115	780

	Item No.	Page
gray	280-402	440
orange	280-323	444
white	2009-115	780

# Actuator Terminal Blocks for Actuators with Shield Connection and Actuators with Shield Conductor Through Contact (e.g., for Thermocouples)

## 2.5 mm<sup>2</sup>, 280 Series

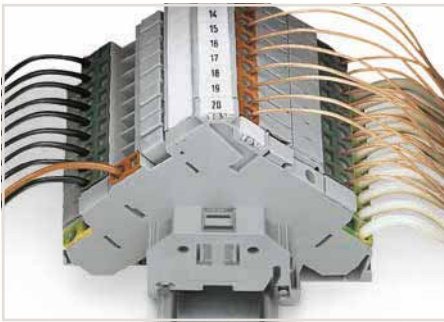

Green-yellow clamping unit = shield connection



White clamping unit = shield conductor through contact

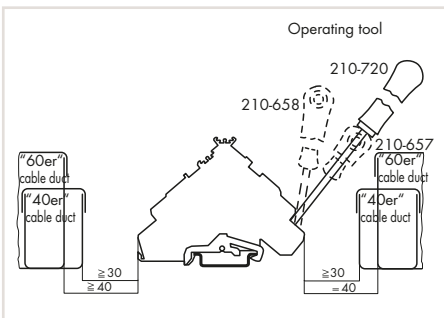

Min. mounting distance – terminal blocks to cable duct



280-585

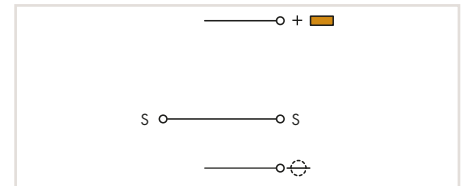

Actuator terminal block, with shield connection

Color	Item No.	Pack. Unit
gray	280-585	50



### Technical Data

Rated voltage (III / 3)	400 V
Rated surge voltage (III / 3)	6 kV
Rated current	20 A
Approval	300 V, 15 A ; 300 V, 15 A

### Connection Data

Solid conductor	0.08 ... 2.5 mm <sup>2</sup> / 28 ... 12 AWG
Fine-stranded conductor	0.08 ... 2.5 mm <sup>2</sup> / 28 ... 12 AWG
Note (conductor cross section)	12 AWG: THHN, THWN
Strip length	8 ... 9 mm / 0.31 ... 0.35 inch
Terminal block width	5 mm / 0.197 inch
Insulation material	Polyamide 66 (PA 66)

### Note

### Accessories (Selection)

Adjacent jumper, insulated, I <sub>N</sub> = I <sub>N</sub> terminal block
End and intermediate plate, for quadruple-deck terminal blocks, 1 mm thick
WMB Inline, plain, 1,500 WMB markers (5 mm) per reel, 5 ... 5.2 mm stretchable

	Item No.	Page
gray	280-402	440
orange	280-323	444
white	2009-115	780

Accessories (jumpers, end plates, etc.), see page 440

Carrier rails and tools, see Section 13

Appropriate marking system, WMB/WMB Inline, see Full Line Catalog, Volume 6

Approvals and corresponding ratings, visit [www.wago.com](http://www.wago.com)



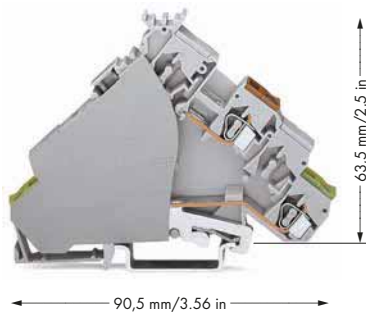

280-586

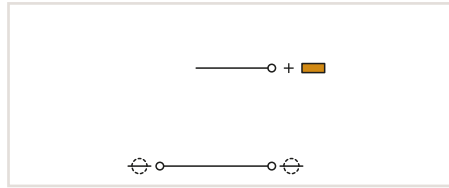

Actuator supply terminal block, with shield connection, power supply from control panel side, with end plate

Color	Item No.	Pack. Unit
○ gray	280-586	50

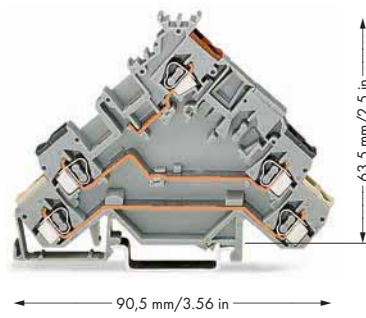

280-583

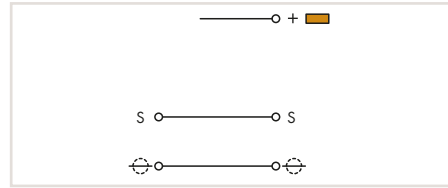

Actuator terminal block, with shield conductor through contact

Color	Item No.	Pack. Unit
○ gray	280-583	50

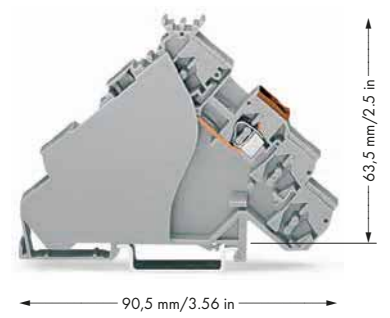

280-515

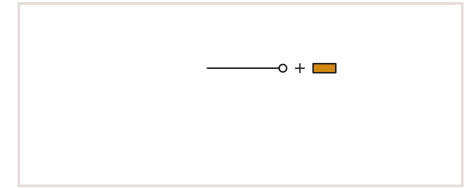

Actuator supply terminal block, power supply from control panel side, with end plate, for actuators with shield conductor through contact

Color	Item No.	Pack. Unit
○ gray	280-515	20

5



400 V
6 kV
20 A
300 V, 15 A <b>UL</b> ; 300 V, 15 A <b>UL</b>

0.08 ... 2.5 mm <sup>2</sup> / 28 ... 12 AWG
0.08 ... 2.5 mm <sup>2</sup> / 28 ... 12 AWG
12 AWG: THHN, THWN
8 ... 9 mm / 0.31 ... 0.35 inch
6 mm / 0.236 inch
Polyamide 66 (PA 66)

	Item No.	Page
gray	280-402	440
orange	280-323	444
white	2009-115	780



400 V
6 kV
20 A
300 V, 15 A <b>UL</b>

0.08 ... 2.5 mm <sup>2</sup> / 28 ... 12 AWG
0.08 ... 2.5 mm <sup>2</sup> / 28 ... 12 AWG
12 AWG: THHN, THWN
8 ... 9 mm / 0.31 ... 0.35 inch
5 mm / 0.197 inch
Polyamide 66 (PA 66)

Electrical ratings are given by the fuse plug or empty component plug housing.

	Item No.	Page
gray	280-402	440
orange	280-323	444
white	2009-115	780



400 V
6 kV
20 A
300 V, 15 A <b>UL</b> ; 300 V, 15 A <b>UL</b>

0.08 ... 2.5 mm <sup>2</sup> / 28 ... 12 AWG
0.08 ... 2.5 mm <sup>2</sup> / 28 ... 12 AWG
12 AWG: THHN, THWN
8 ... 9 mm / 0.31 ... 0.35 inch
6 mm / 0.236 inch
Polyamide 66 (PA 66)

Electrical ratings are given by the fuse plug or empty component plug housing.

	Item No.	Page
gray	280-402	440
orange	280-323	444
white	2009-115	780

## Diode Terminal Blocks 1.5 mm<sup>2</sup>, 279 Series

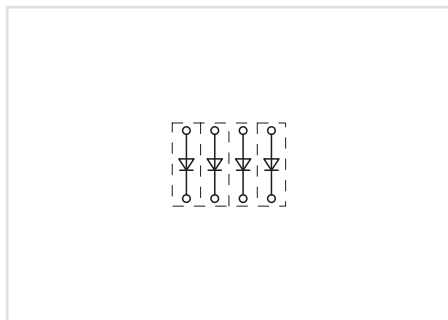

Open diode gates can be created using the following terminal blocks:  
279-915/281-410 or 279-915/281-411

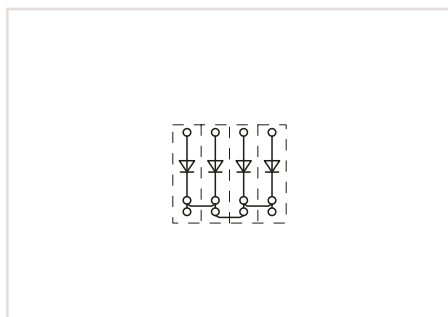

Polarized diode gates with a common cathode can be created using the following terminal blocks:  
279-673/281-410 or 279-673/281-411

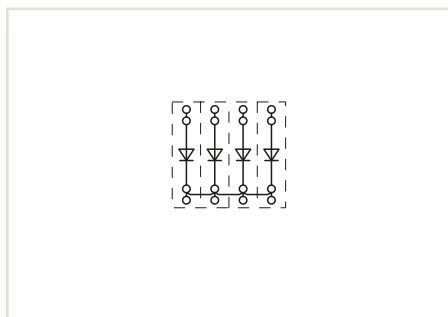

Polarized diode gates with a common cathode can be created using the following terminal blocks:  
279-815/281-410 or 279-815/281-411

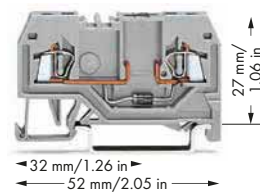

279-915/281-410

279-915/281-411

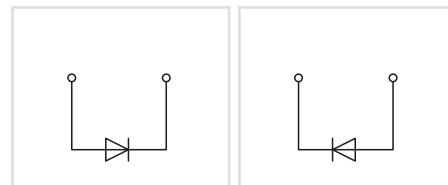

2-conductor diode terminal block, with 1N4007 diode

Color	Item No.	Pack. Unit
● gray	279-915/281-410	100
● gray	279-915/281-411	100

### Technical Data

Ratings per	
Nominal voltage	
Reverse voltage	
Rated current	
<b>Connection Data</b>	
Solid conductor	
Fine-stranded conductor	
Strip length	
Terminal block width	
Insulation material	

IEC/EN 60947-7-1
250 V
1000 V
0.5 A
0.08 ... 1.5 mm <sup>2</sup> / 28 ... 16 AWG
0.08 ... 1.5 mm <sup>2</sup> / 28 ... 16 AWG
8 ... 9 mm / 0.31 ... 0.35 inch
4 mm / 0.157 inch
Polyamide 66 (PA 66)

### Accessories (Selection)

Comb-style jumper bar, insulated, I <sub>N</sub> = I <sub>N</sub> terminal block, gray
End and intermediate plate, 2 mm thick
WMB Inline, plain, 2,000 WMB markers (4 mm) per reel, 4 ... 4.2 mm stretchable

	Item No.	Page
2-way	279-482	438
orange	279-328	438
white	2009-114	780

Accessories (comb-style jumper bars, end plates, etc.), see page 438

Carrier rails and tools, see Section 13

Appropriate marking system, WMB/WMB Inline, see Full Line Catalog, Volume 6

Approvals and corresponding ratings, visit [www.wago.com](http://www.wago.com)

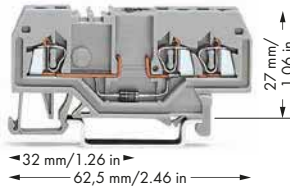

279-673/281-410

279-673/281-411

279-815/281-410

279-815/281-411

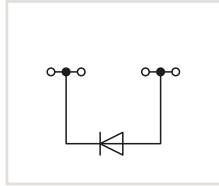
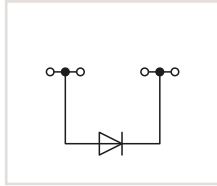
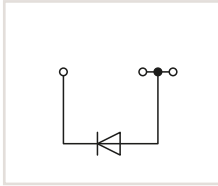
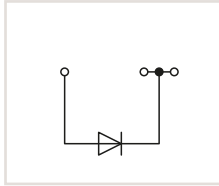

3-conductor diode terminal block, with 1N4007 diode

Color	Item No.	Pack. Unit
gray	279-673/281-410	100
gray	279-673/281-411	100

4-conductor diode terminal block, with 1N4007 diode

Color	Item No.	Pack. Unit
gray	279-815/281-410	100
gray	279-815/281-411	100

IEC/EN 60947-7-1

250 V

1000 V

0.5 A

0.08 ... 1.5 mm<sup>2</sup> / 28 ... 16 AWG

0.08 ... 1.5 mm<sup>2</sup> / 28 ... 16 AWG

8 ... 9 mm / 0.31 ... 0.35 inch

4 mm / 0.157 inch

Polyamide 66 (PA 66)

IEC/EN 60947-7-1

250 V

1000 V

0.5 A

0.08 ... 1.5 mm<sup>2</sup> / 28 ... 16 AWG

0.08 ... 1.5 mm<sup>2</sup> / 28 ... 16 AWG

8 ... 9 mm / 0.31 ... 0.35 inch

4 mm / 0.157 inch

Polyamide 66 (PA 66)

	Item No.	Page
2-way	279-482	438
orange	279-339	439
white	2009-114	780

	Item No.	Page
2-way	279-482	438
orange	279-346	439
white	2009-114	780

## LED Terminal Blocks

### 1.5 mm<sup>2</sup>, 279 Series

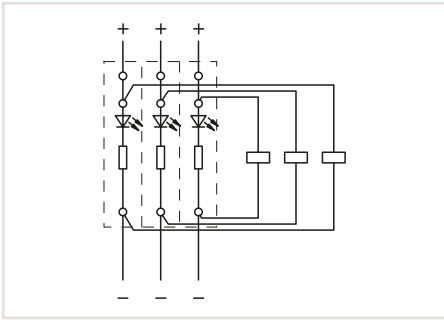

Circuit-related voltage indications can be created using the following terminal blocks:  
279-674/281-434 or 279-674/281-413

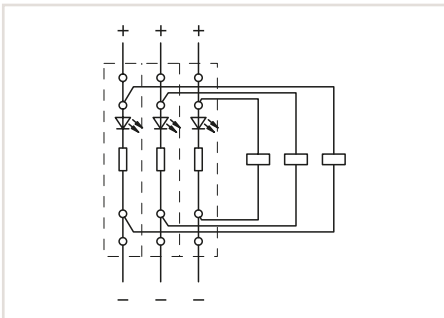

Circuit-related voltage indications can be created using the following terminal blocks:  
279-809/281-434 or 279-809/281-413

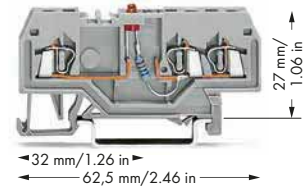

279-674/281-434

279-674/281-413

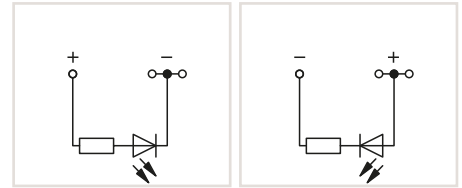

3-conductor LED terminal block, with red LED

Color	Item No.	Pack. Unit
○ gray	279-674/281-434	100
○ gray	279-674/281-413	100

#### Technical Data

Ratings per

Voltage type

Nominal voltage

Rated current

#### Connection Data

Solid conductor

Fine-stranded conductor

Strip length

Terminal block width

Insulation material

IEC/EN 60947-7-1

DC

24 V

0.025 A

0.08 ... 1.5 mm<sup>2</sup> / 28 ... 16 AWG

0.08 ... 1.5 mm<sup>2</sup> / 28 ... 16 AWG

8 ... 9 mm / 0.31 ... 0.35 inch

4 mm / 0.157 inch

Polyamide 66 (PA 66)

#### Accessories (Selection)

Comb-style jumper bar, insulated, I<sub>N</sub> = I<sub>N</sub> terminal block, gray

End and intermediate plate, 2 mm thick

WMB Inline, plain, 2,000 WMB markers (4 mm) per reel, 4 ... 4.2 mm stretchable

	Item No.	Page
2-way	279-482	438
orange	279-339	439
white	2009-114	780

Accessories (comb-style jumper bars, end plates, etc.), see page 438

Carrier rails and tools, see Section 13

Appropriate marking system, WMB/WMB Inline/Marking strips, see Full Line Catalog, Volume 6

Approvals and corresponding ratings, visit [www.wago.com](http://www.wago.com)

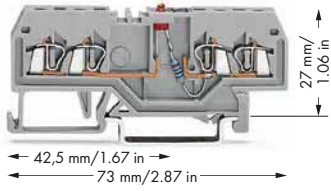

279-809/281-434

279-809/281-413

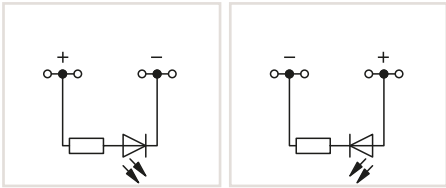

4-conductor LED terminal block, with red LED

Color	Item No.	Pack. Unit
○ gray	279-809/281-434	100
○ gray	279-809/281-413	100

IEC/EN 60947-7-1

DC

24 V

0.025 A

0.08 ... 1.5 mm<sup>2</sup> / 28 ... 16 AWG

0.08 ... 1.5 mm<sup>2</sup> / 28 ... 16 AWG

8 ... 9 mm / 0.31 ... 0.35 inch

4 mm / 0.157 inch

Polyamide 66 (PA 66)

	Item No.	Page
2-way	279-482	438
orange	279-346	439
white	2009-114	780

## Diode Terminal Blocks 2.5 mm<sup>2</sup>, 280 Series

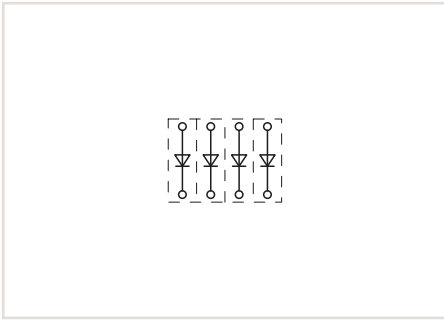

Open diode gates can be created using the following terminal blocks:  
280-915/281-410 or 280-915/281-411

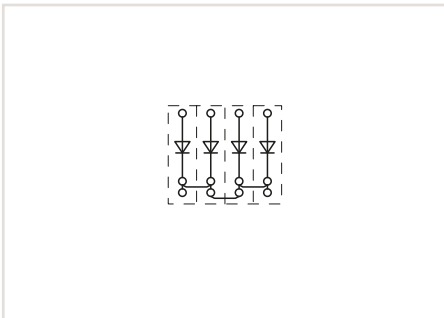

Polarized diode gates with a common cathode can be created using the following terminal blocks:  
280-673/281-410 or 280-673/281-411

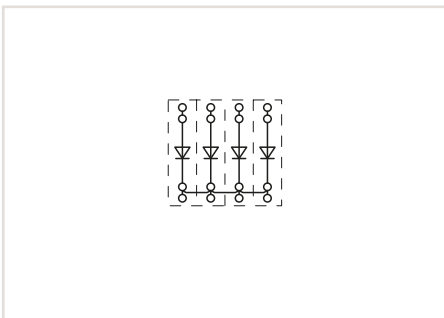

Polarized diode gates with a common cathode can be created using the following terminal blocks:  
280-815/281-410 or 280-815/281-411

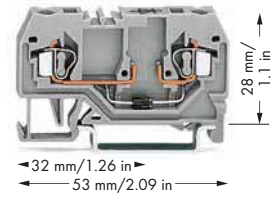

280-915/281-410

280-915/281-411

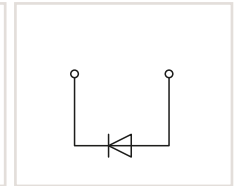
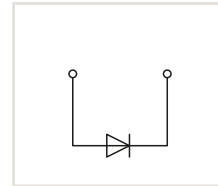

2-conductor diode terminal block, with 1N4007 diode

Color	Item No.	Pack. Unit
● gray	280-915/281-410	100
● gray	280-915/281-411	100

### Technical Data

Ratings per	IEC/EN 60947-7-1
Nominal voltage	250 V
Reverse voltage	1000 V
Rated current	0.5 A
<b>Connection Data</b>	
Solid conductor	0.08 ... 2.5 mm <sup>2</sup> / 28 ... 14 AWG
Fine-stranded conductor	0.08 ... 2.5 mm <sup>2</sup> / 28 ... 14 AWG
Strip length	8 ... 9 mm / 0.31 ... 0.35 inch
Terminal block width	5 mm / 0.197 inch
Insulation material	Polyamide 66 (PA 66)

### Accessories (Selection)

Comb-style jumper bar, insulated, I <sub>N</sub> = I <sub>N</sub> terminal block, gray	2-way	280-482	440
End and intermediate plate, 2.5 mm thick	orange	280-309	441
Wire commencing chain, insulated, 50 connections, I <sub>N</sub> 8 A	black	210-103	460
WMB Inline, plain, 1,500 WMB markers (5 mm) per reel, 5 ... 5.2 mm stretchable	white	2009-115	780

Accessories (comb-style jumper bars, end plates, etc.), see page 440

Carrier rails and tools, see Section 13

Appropriate marking system, WMB/WMB Inline, see Full Line Catalog, Volume 6

Approvals and corresponding ratings, visit [www.wago.com](http://www.wago.com)



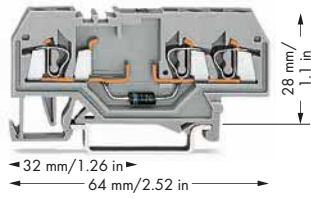

280-673/281-410

280-673/281-411

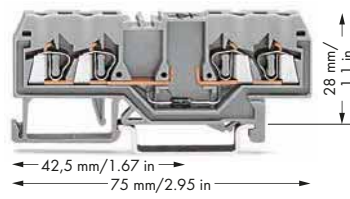

280-815/281-410

280-815/281-411

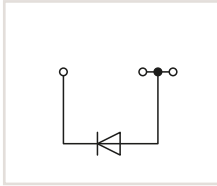
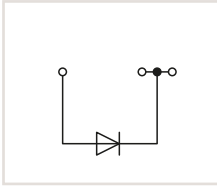

3-conductor diode terminal block, with 1N4007 diode		
Color	Item No.	Pack. Unit
● gray	280-673/281-410	100
● gray	280-673/281-411	100

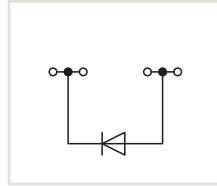
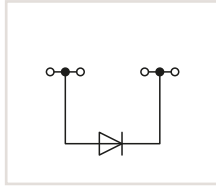

4-conductor diode terminal block, with 1N4007 diode		
Color	Item No.	Pack. Unit
● gray	280-815/281-410	100
● gray	280-815/281-411	100

IEC/EN 60947-7-1
250 V
1000 V
0.5 A
0.08 ... 2.5 mm <sup>2</sup> / 28 ... 14 AWG
0.08 ... 2.5 mm <sup>2</sup> / 28 ... 14 AWG
8 ... 9 mm / 0.31 ... 0.35 inch
5 mm / 0.197 inch
Polyamide 66 (PA 66)

	Item No.	Page
2-way	280-482	440
orange	280-326	442
black	210-103	460
white	2009-115	780

IEC/EN 60947-7-1
250 V
1000 V
0.5 A
0.08 ... 2.5 mm <sup>2</sup> / 28 ... 14 AWG
0.08 ... 2.5 mm <sup>2</sup> / 28 ... 14 AWG
8 ... 9 mm / 0.31 ... 0.35 inch
5 mm / 0.197 inch
Polyamide 66 (PA 66)

	Item No.	Page
2-way	280-482	440
orange	280-315	442
black	210-103	460
white	2009-115	780

## LED Terminal Blocks

### 2.5 mm<sup>2</sup>, 280 Series

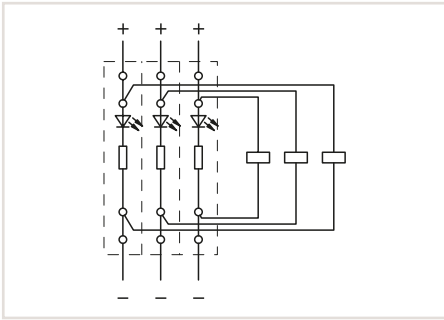

Circuit-related voltage indications can be created using the following terminal blocks:  
279-674/281-434 or 279-674/281-413

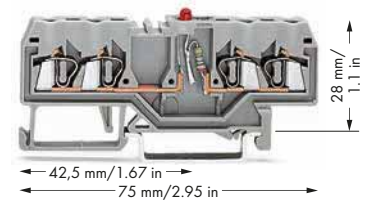

280-809/281-434

280-809/281-413

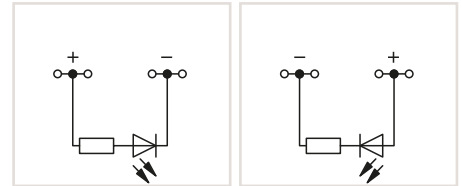

4-conductor LED terminal block, with red LED

Color	Item No.	Pack. Unit
○ gray	280-809/281-434	100
○ gray	280-809/281-413	100

#### Technical Data

Ratings per	IEC/EN 60947-7-1
Voltage type	DC
Nominal voltage	24 V
Rated current	0.025 A
<b>Connection Data</b>	
Solid conductor	0.08 ... 2.5 mm <sup>2</sup> / 28 ... 14 AWG
Fine-stranded conductor	0.08 ... 2.5 mm <sup>2</sup> / 28 ... 14 AWG
Strip length	8 ... 9 mm / 0.31 ... 0.35 inch
Terminal block width	5 mm / 0.197 inch
Insulation material	Polyamide 66 (PA 66)

#### Accessories (Selection)

Comb-style jumper bar, insulated, I <sub>N</sub> = I <sub>N</sub> terminal block, gray	280-482	440	
End and intermediate plate, 2.5 mm thick	orange	280-315	442
Wire commoning chain, insulated, 50 connections, I <sub>N</sub> 8 A	black	210-103	460
WMB Inline, plain, 1,500 WMB markers (5 mm) per reel, 5 ... 5.2 mm stretchable	white	2009-115	780

Accessories (comb-style jumper bars, end plates, etc.), see page 440

Carrier rails and tools, see Section 13

Appropriate marking system, WMB/WMB Inline/Marking strips, see Full Line Catalog, Volume 6

Approvals and corresponding ratings, visit [www.wago.com](http://www.wago.com)

## Variable Resistor Terminal Blocks

### 2.5 mm<sup>2</sup>, 280 Series

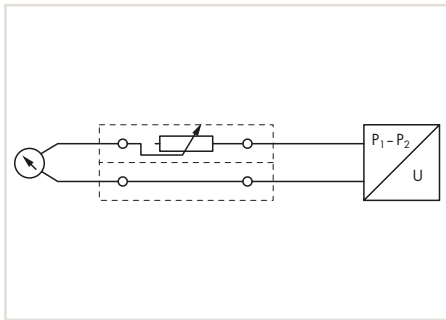

Variable Resistor Terminal Blocks  
Trimming circuit for differential pressure

Other resistors are available upon request.

In connection with an end and intermediate plate (280-331), the variable resistor terminal block (280-645/281-412) can also be used for Ex i applications.

Terminal blocks with side marking (e.g., 280-601), visit [www.wagocatalog.com](http://www.wagocatalog.com)

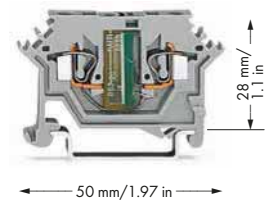

280-615/281-412

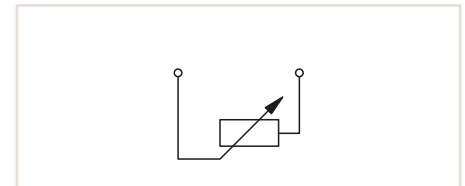

Variable resistor terminal block with balancing resistor, 0.5 ... 20 Ohm, 0.75 W

Color	Item No.	Pack. Unit
gray	280-615/281-412	100

Variable resistor terminal block with balancing resistor, 0.5 ... 20 Ohm, 0.75 W

Color	Item No.	Pack. Unit
gray	280-645/281-412	100

Variable resistor terminal block, with balancing resistor, 20 Ohm ... 1 kOhm, 0.75 W

Color	Item No.	Pack. Unit
gray	280-615/281-428	100

#### Technical Data

Ratings per	IEC/EN 60947-7-1
Rated voltage (III / 3)	250 V

#### Connection Data

Solid conductor	0.08 ... 2.5 mm <sup>2</sup> / 28 ... 14 AWG
Fine-stranded conductor	0.08 ... 2.5 mm <sup>2</sup> / 28 ... 14 AWG
Strip length	8 ... 9 mm / 0.31 ... 0.35 inch
Terminal block width	5 mm / 0.197 inch
Insulation material	Polyamide 66 (PA 66)

#### Accessories (Selection)

End and intermediate plate, 2.5 mm thick	orange	280-331	–
End and intermediate plate, 2.5 mm thick	gray	280-330	–
WMB Inline, plain, 1,500 WMB markers (5 mm) per reel, 5 ... 5.2 mm stretchable	white	2009-115	780

IEC/EN 60947-7-1	
250 V	

0.08 ... 2.5 mm <sup>2</sup> / 28 ... 14 AWG	
0.08 ... 2.5 mm <sup>2</sup> / 28 ... 14 AWG	
8 ... 9 mm / 0.31 ... 0.35 inch	
5 mm / 0.197 inch	
Polyamide 66 (PA 66)	

	Item No.	Page
orange	280-331	–
gray	280-330	–
white	2009-115	780

Carrier rails and tools, see Section 13

Appropriate marking system, WMB/WMB Inline/Marking strips, see Full Line Catalog, Volume 6

Approvals and corresponding ratings, visit [www.wago.com](http://www.wago.com)

## Diode Terminal Blocks 4 mm<sup>2</sup>, 281 Series

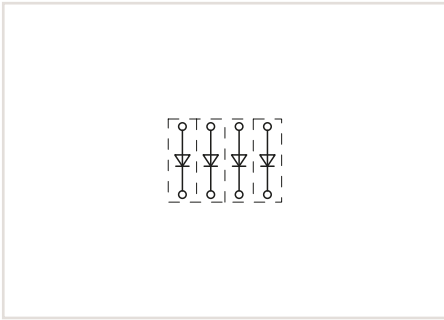

Open diode gates can be created using the following terminal blocks:  
281-915/281-410 or 281-915/281-411  
281-915/281-400 or 281-915/281-401

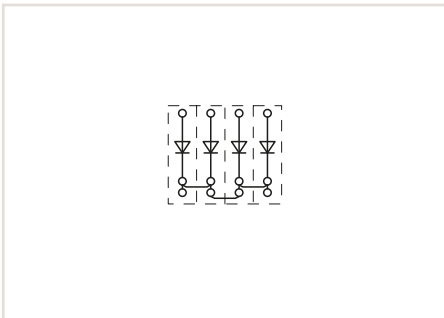

Polarized diode gates with a common cathode can be created using the following terminal blocks:  
281-673/281-410 or 281-673/281-411  
281-673/281-400 or 281-673/281-401

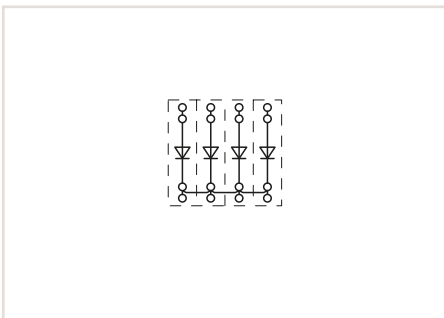

Polarized diode gates with a common cathode can be created using the following terminal blocks:  
281-815/281-410 or 281-815/281-411  
281-815/281-400 or 281-815/281-401

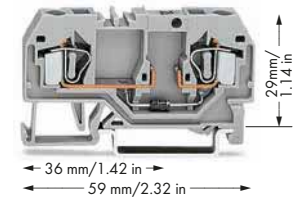

281-915/281-410

281-915/281-411

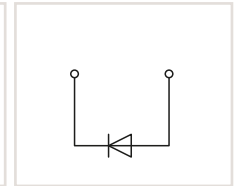
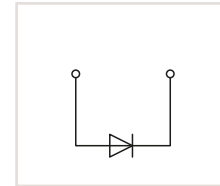

2-conductor diode terminal block, with 1N4007 diode, 0.5 A continuous current

Color	Item No.	Pack. Unit
○ gray	281-915/281-410	50
○ gray	281-915/281-411	50

2-conductor diode terminal block, with 1N5408 diode, 1.5 A continuous current

Color	Item No.	Pack. Unit
○ gray	281-915/281-400	50
○ gray	281-915/281-401	50

### Technical Data

Ratings per	IEC/EN 60947-7-1
Nominal voltage	250 V
Reverse voltage	1000 V
<b>Connection Data</b>	
Solid conductor	0.08 ... 4 mm <sup>2</sup> / 28 ... 12 AWG
Fine-stranded conductor	0.08 ... 4 mm <sup>2</sup> / 28 ... 12 AWG
Strip length	9 ... 10 mm / 0.35 ... 0.39 inch
Terminal block width	6 mm / 0.236 inch
Insulation material	Polyamide 66 (PA 66)

### Accessories (Selection)

Comb-style jumper bar, insulated, I <sub>N</sub> = I <sub>N</sub> terminal block, gray	
End and intermediate plate, 2.5 mm thick	
Wire commoning chain, insulated, 50 connections, I <sub>N</sub> 8 A	
WMB Inline, plain, 1,500 WMB markers (5 mm) per reel, 5 ... 5.2 mm stretchable	

	Item No.	Page
2-way	280-482	447
orange	280-309	448
black	210-103	460
white	2009-115	780

Accessories (comb-style jumper bars, end plates, etc.), see page 447

Carrier rails and tools, see Section 13

Appropriate marking system, WMB/WMB Inline, see Full Line Catalog, Volume 6

Approvals and corresponding ratings, visit [www.wago.com](http://www.wago.com)

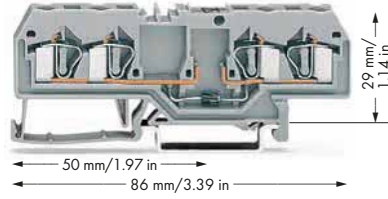
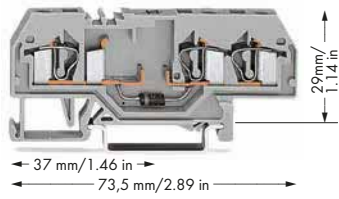

281-673/281-410

281-673/281-411

281-815/281-410

281-815/281-411

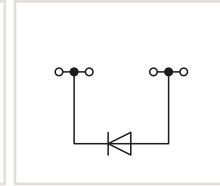
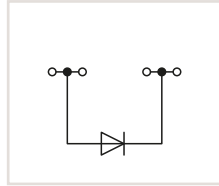
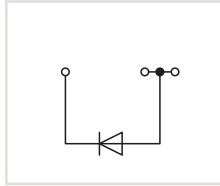
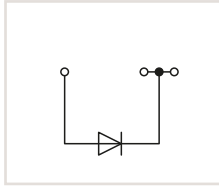

3-conductor diode terminal block, with 1N4007 diode, 0.5 A continuous current

Color	Item No.	Pack. Unit
● gray	281-673/281-410	50
● gray	281-673/281-411	50

4-conductor diode terminal block, with 1N4007 diode, 0.5 A continuous current

Color	Item No.	Pack. Unit
● gray	281-815/281-410	50
● gray	281-815/281-411	50

3-conductor diode terminal block, with 1N5408 diode, 1.5 A continuous current

Color	Item No.	Pack. Unit
● gray	281-673/281-400	50
● gray	281-673/281-401	50

4-conductor diode terminal block, with 1N5408 diode, 1.5 A continuous current

Color	Item No.	Pack. Unit
● gray	281-815/281-400	50
● gray	281-815/281-401	50

IEC/EN 60947-7-1

250 V

1000 V

0.08 ... 4 mm<sup>2</sup> / 28 ... 12 AWG

0.08 ... 4 mm<sup>2</sup> / 28 ... 12 AWG

9 ... 10 mm / 0.35 ... 0.39 inch

6 mm / 0.236 inch

Polyamide 66 (PA 66)

IEC/EN 60947-7-1

250 V

1000 V

0.08 ... 4 mm<sup>2</sup> / 28 ... 12 AWG

0.08 ... 4 mm<sup>2</sup> / 28 ... 12 AWG

9 ... 10 mm / 0.35 ... 0.39 inch

6 mm / 0.236 inch

Polyamide 66 (PA 66)

	Item No.	Page
2-way	280-482	447
orange	280-326	448
black	210-103	460
white	2009-115	780

	Item No.	Page
2-way	280-482	447
orange	280-315	448
black	210-103	460
white	2009-115	780

## Double-Deck Diode Terminal Blocks 2.5 mm<sup>2</sup>, 280 Series

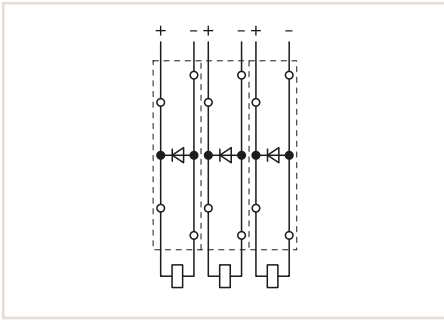

Recovery diodes can be created using the following terminal blocks:  
280-940/281-410 or 280-940/281-411

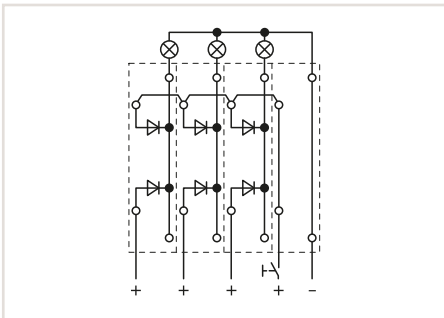

Lamp test circuits can be created using the following terminal blocks:  
280-942/281-487 or 280-942/281-488

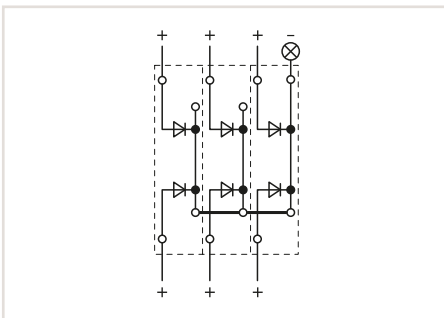

Collective fault signals can be created using the following terminal blocks:  
280-941/281-489 or 280-941/281-490

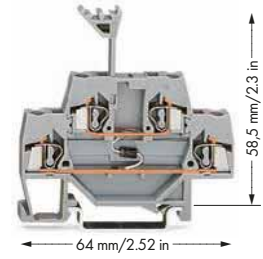

280-940/281-410

280-940/281-411

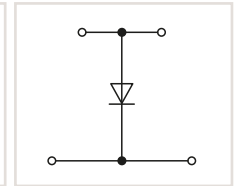
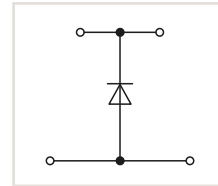

Double-deck diode terminal block, with 1N4007 diode

Color	Item No.	Pack. Unit
gray	280-940/281-410	50
gray	280-940/281-411	50

### Technical Data

Ratings per	IEC/EN 60947-7-1
Nominal voltage	250 V
Reverse voltage	1000 V
Rated current	0.5 A
<b>Connection Data</b>	
Solid conductor	0.08 ... 2.5 mm <sup>2</sup> / 28 ... 14 AWG
Fine-stranded conductor	0.08 ... 2.5 mm <sup>2</sup> / 28 ... 14 AWG
Strip length	8 ... 9 mm / 0.31 ... 0.35 inch
Terminal block width	5 mm / 0.197 inch
Insulation material	Polyamide 66 (PA 66)

### Accessories (Selection)

Comb-style jumper bar, insulated, I <sub>N</sub> = I <sub>N</sub> terminal block, gray	
End and intermediate plate, 2.5 mm thick	
Wire commoning chain, insulated, 50 connections, I <sub>N</sub> 8 A	
WMB Inline, plain, 1,500 WMB markers (5 mm) per reel, 5 ... 5.2 mm stretchable	

	Item No.	Page
2-way	280-482	447
orange	280-341	443
black	210-103	460
white	2009-115	780

Double-deck diode terminal blocks were specifically developed for custom diode circuits, such as lamp test and collective fault signal circuits. These terminal blocks provide high-density wiring in a width of just 5 mm.

Accessories (comb-style jumper bars, end plates, etc.), see page 447

Carrier rails and tools, see Section 13

Appropriate marking system, WMB/WMB Inline, see Full Line Catalog, Volume 6

Approvals and corresponding ratings, visit [www.wago.com](http://www.wago.com)



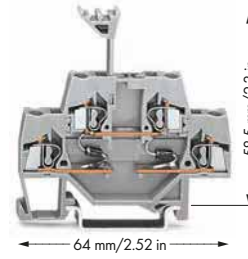
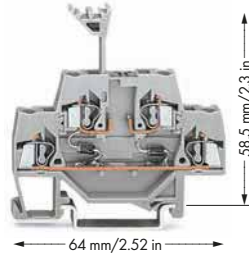
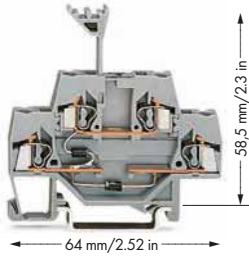

280-941/281-492

280-941/281-491

280-942/281-487

280-942/281-488

280-941/281-489

280-941/281-490

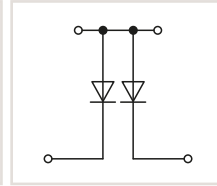
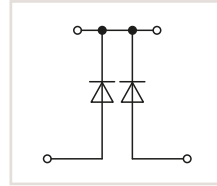
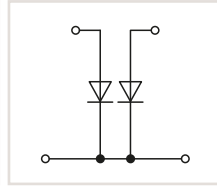
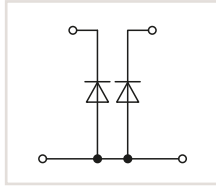
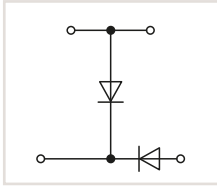
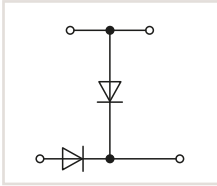

Double-deck diode terminal block, with two 1N4007 diodes

Color	Item No.	Pack. Unit
gray	280-941/281-492	50
gray	280-941/281-491	50

Double-deck diode terminal block, with two 1N4007 diodes

Color	Item No.	Pack. Unit
gray	280-941/281-487	50
gray	280-941/281-488	50

Double-deck diode terminal block, with two 1N4007 diodes

Color	Item No.	Pack. Unit
gray	280-941/281-489	50
gray	280-941/281-490	50

IEC/EN 60947-7-1
250 V
1000 V
0.5 A
0.08 ... 2.5 mm <sup>2</sup> / 28 ... 14 AWG
0.08 ... 2.5 mm <sup>2</sup> / 28 ... 14 AWG
8 ... 9 mm / 0.31 ... 0.35 inch
5 mm / 0.197 inch
Polyamide 66 (PA 66)

IEC/EN 60947-7-1
250 V
1000 V
0.5 A
0.08 ... 2.5 mm <sup>2</sup> / 28 ... 14 AWG
0.08 ... 2.5 mm <sup>2</sup> / 28 ... 14 AWG
8 ... 9 mm / 0.31 ... 0.35 inch
5 mm / 0.197 inch
Polyamide 66 (PA 66)

IEC/EN 60947-7-1
250 V
1000 V
0.5 A
0.08 ... 2.5 mm <sup>2</sup> / 28 ... 14 AWG
0.08 ... 2.5 mm <sup>2</sup> / 28 ... 14 AWG
8 ... 9 mm / 0.31 ... 0.35 inch
5 mm / 0.197 inch
Polyamide 66 (PA 66)

	Item No.	Page
2-way	280-482	447
orange	280-341	443
black	210-103	460
white	2009-115	780

	Item No.	Page
2-way	280-482	447
orange	280-341	443
black	210-103	460
white	2009-115	780

	Item No.	Page
2-way	280-482	447
orange	280-341	443
black	210-103	460
white	2009-115	780

## Double-Deck Diode Terminal Blocks

### 4 mm<sup>2</sup>, 281 Series

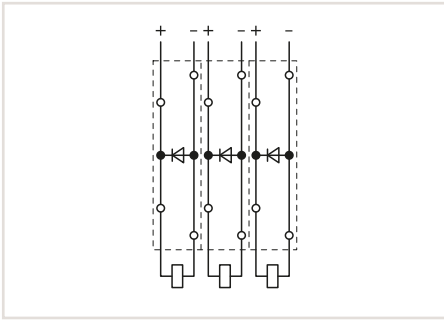

Recovery diodes can be created using the following terminal blocks:  
281-633/281-410 or 281-633/281-411

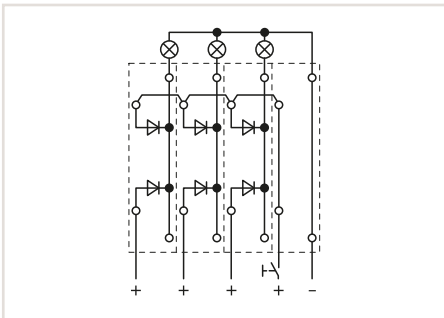

Lamp test circuits can be created using the following terminal blocks:  
281-636/281-487 or 281-636/281-488

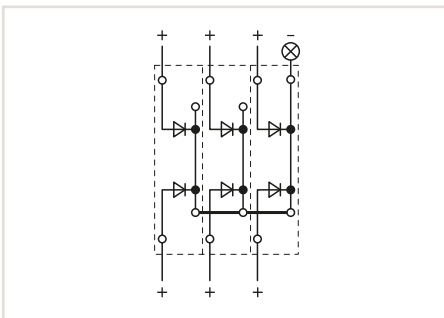

Collective fault signals can be created using the following terminal blocks:  
281-635/281-489 or 281-635/281-490

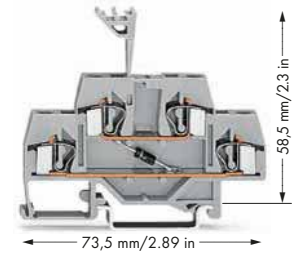

281-633/281-410

281-633/281-410

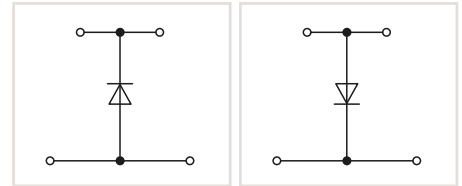

Double-deck diode terminal block, with 1N4007 diode

Color	Item No.	Pack. Unit
gray	281-633/281-410	50
gray	281-633/281-411	50

#### Technical Data

Ratings per	IEC/EN 60947-7-1
Nominal voltage	250 V
Reverse voltage	1000 V
Rated current	0.5 A
<b>Connection Data</b>	
Solid conductor	0.08 ... 4 mm <sup>2</sup> / 28 ... 12 AWG
Fine-stranded conductor	0.08 ... 4 mm <sup>2</sup> / 28 ... 12 AWG
Strip length	9 ... 10 mm / 0.35 ... 0.39 inch
Terminal block width	6 mm / 0.236 inch
Insulation material	Polyamide 66 (PA 66)

#### Accessories (Selection)

Comb-style jumper bar, insulated, I <sub>N</sub> = I <sub>N</sub> terminal block, gray	2-way	281-482	447
End and intermediate plate, 2.5 mm thick	orange	281-341	449
Wire comming chain, insulated, 50 connections, I <sub>N</sub> 8 A	black	210-103	460
WMB Inline, plain, 1,500 WMB markers (5 mm) per reel, 5 ... 5.2 mm stretchable	white	2009-115	780

Double-deck diode terminal blocks were specifically developed for custom diode circuits, such as lamp test and collective fault signal circuits. These terminal blocks provide high-density wiring in a width of just 6 mm.

Accessories (comb-style jumper bars, end plates, etc.), see page 447

Carrier rails and tools, see Section 13

Appropriate marking system, WMB/WMB Inline, see Full Line Catalog, Volume 6

Approvals and corresponding ratings, visit [www.wago.com](http://www.wago.com)

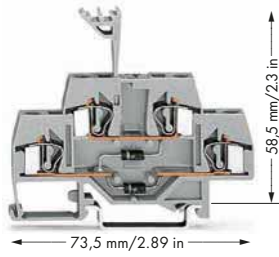

281-635/281-492

281-635/281-491

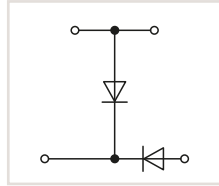
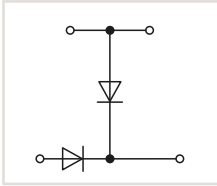

Double-deck diode terminal block, with two 1N4007 diodes

Color	Item No.	Pack. Unit
gray	281-635/281-492	50
gray	281-635/281-491	50

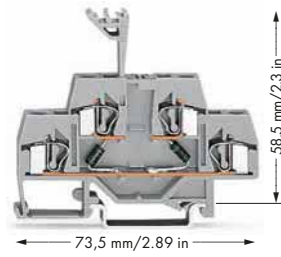

281-636/281-487

281-636/281-488

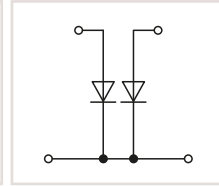
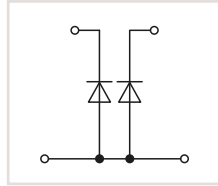

Double-deck diode terminal block, with two 1N4007 diodes

Color	Item No.	Pack. Unit
gray	281-636/281-487	50
gray	281-636/281-488	50

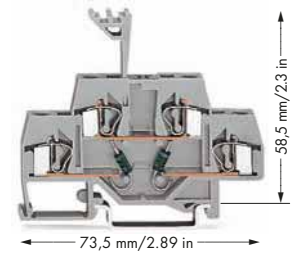

281-635/281-489

281-635/281-490

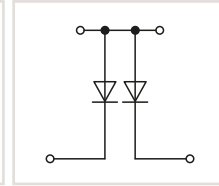
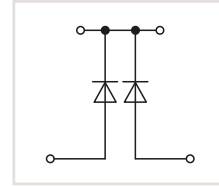

Double-deck diode terminal block, with two 1N4007 diodes

Color	Item No.	Pack. Unit
gray	281-635/281-489	50
gray	281-635/281-490	50

IEC/EN 60947-7-1
250 V
1000 V
0.5 A
0.08 ... 4 mm <sup>2</sup> / 28 ... 12 AWG
0.08 ... 4 mm <sup>2</sup> / 28 ... 12 AWG
9 ... 10 mm / 0.35 ... 0.39 inch
6 mm / 0.236 inch
Polyamide 66 (PA 66)

IEC/EN 60947-7-1
250 V
1000 V
0.5 A
0.08 ... 4 mm <sup>2</sup> / 28 ... 12 AWG
0.08 ... 4 mm <sup>2</sup> / 28 ... 12 AWG
9 ... 10 mm / 0.35 ... 0.39 inch
6 mm / 0.236 inch
Polyamide 66 (PA 66)

IEC/EN 60947-7-1
250 V
1000 V
0.5 A
0.08 ... 4 mm <sup>2</sup> / 28 ... 12 AWG
0.08 ... 4 mm <sup>2</sup> / 28 ... 12 AWG
9 ... 10 mm / 0.35 ... 0.39 inch
6 mm / 0.236 inch
Polyamide 66 (PA 66)

	Item No.	Page
2-way	281-482	447
orange	281-341	449
black	210-103	460
white	2009-115	780

	Item No.	Page
2-way	281-482	447
orange	281-341	449
black	210-103	460
white	2009-115	780

	Item No.	Page
2-way	281-482	447
orange	281-341	449
black	210-103	460
white	2009-115	780

## Double-Deck LED Terminal Blocks

### 2.5 mm<sup>2</sup>, 280 Series

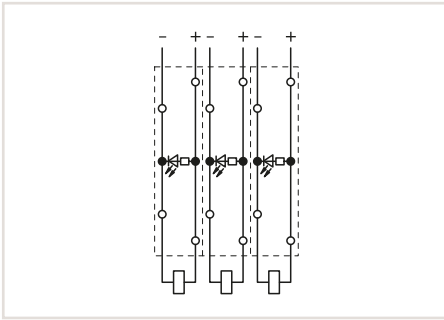

Circuit-related voltage indications can be created using the following terminal blocks:  
280-943/281-434 or 280-943/281-413

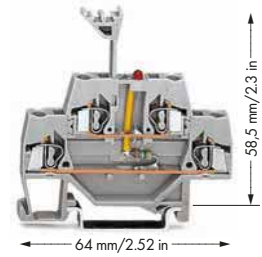

280-943/281-434

280-943/281-413

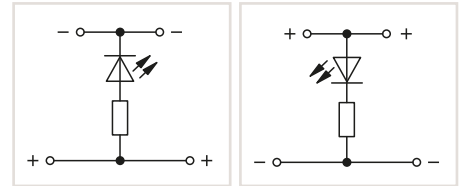

Double-deck LED terminal block, with red LED

Color	Item No.	Pack. Unit
○ gray	280-943/281-434	50
○ gray	280-943/281-413	50

#### Technical Data

Ratings per	IEC/EN 60947-7-1
Voltage type	DC
Nominal voltage	24 V
Rated current	0.025 A

#### Connection Data

Solid conductor	0.08 ... 2.5 mm <sup>2</sup> / 28 ... 14 AWG
Fine-stranded conductor	0.08 ... 2.5 mm <sup>2</sup> / 28 ... 14 AWG
Strip length	8 ... 9 mm / 0.31 ... 0.35 inch
Terminal block width	5 mm / 0.197 inch
Insulation material	Polyamide 66 (PA 66)

#### Accessories (Selection)

Comb-style jumper bar, insulated, I <sub>N</sub> = I <sub>N</sub> terminal block, gray	
End and intermediate plate, 2.5 mm thick	
Wire commoning chain, insulated, 50 connections, I <sub>N</sub> 8 A	
WMB Inline, plain, 1,500 WMB markers (5 mm) per reel, 5 ... 5.2 mm stretchable	

	Item No.	Page
2-way	280-482	440
orange	280-315	443
black	210-103	460
white	2009-115	780

Using LED terminal blocks, monitoring units can be designed, e.g., for control and operating circuits. These terminal blocks provide high-density wiring in a width of just 5 mm.

Accessories (comb-style jumper bars, end plates, etc.), see page 440

Carrier rails and tools, see Section 13

Appropriate marking system, WMB/WMB Inline/Marking strips, see Full Line Catalog, Volume 6

Approvals and corresponding ratings, visit [www.wago.com](http://www.wago.com)

## Double-Deck LED Terminal Blocks 4 mm<sup>2</sup>, 281 Series

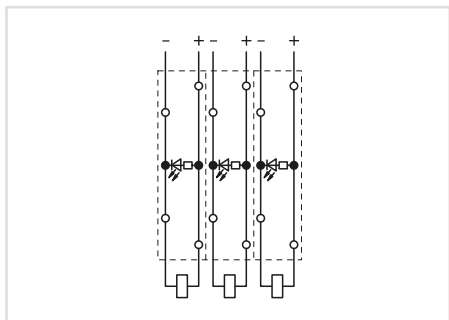

Circuit-related voltage indications can be created using the following terminal blocks:  
280-943/281-434 or 280-943/281-413

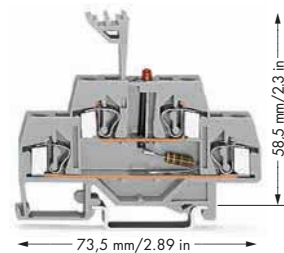

281-634/281-434

281-634/281-413

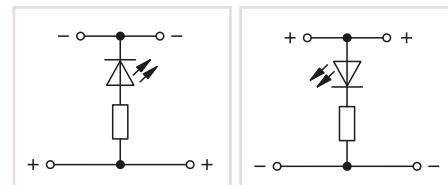

Double-deck LED terminal block, with red LED

Color	Item No.	Pack. Unit
○ gray	281-634/281-434	50
○ gray	281-634/281-413	50

### Technical Data

Ratings per	IEC/EN 60947-7-1
Voltage type	DC
Nominal voltage	24 V
Rated current	0.025 A

### Connection Data

Solid conductor	0.08 ... 2.5 mm <sup>2</sup> / 28 ... 14 AWG
Fine-stranded conductor	0.08 ... 2.5 mm <sup>2</sup> / 28 ... 14 AWG
Strip length	8 ... 9 mm / 0.31 ... 0.35 inch
Terminal block width	5 mm / 0.197 inch
Insulation material	Polyamide 66 (PA 66)

### Accessories (Selection)

Comb-style jumper bar, insulated, I <sub>N</sub> = I <sub>N</sub> terminal block, gray	2-way	281-482	447
End and intermediate plate, 2.5 mm thick	orange	281-341	449
Wire commoning chain, insulated, 50 connections, I <sub>N</sub> 8 A	black	210-103	460
WMB Inline, plain, 1,500 WMB markers (5 mm) per reel, 5 ... 5.2 mm stretchable	white	2009-115	780

	Item No.	Page
2-way	281-482	447
orange	281-341	449
black	210-103	460
white	2009-115	780

Using LED terminal blocks, monitoring units can be designed, e.g., for control and operating circuits. These terminal blocks provide high-density wiring in a width of just 6 mm.

Accessories (comb-style jumper bars, end plates, etc.), see page 447

Carrier rails and tools, see Section 13

Appropriate marking system, WMB/WMB Inline/Marking strips, see Full Line Catalog, Volume 6

Approvals and corresponding ratings, visit [www.wago.com](http://www.wago.com)

# Pluggable Diode Modules on Carrier Terminal Blocks, 2.5 mm<sup>2</sup> 280 Series

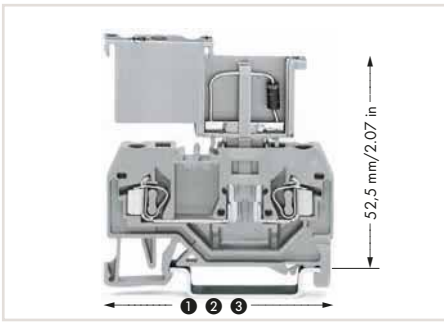

Lengths of carrier terminal blocks with a pluggable diode module:

- ① 53 mm / 2.09 inch for 280-916
- ② 64 mm / 2.52 inch for 280-610
- ③ 75 mm / 2.95 inch for 280-816

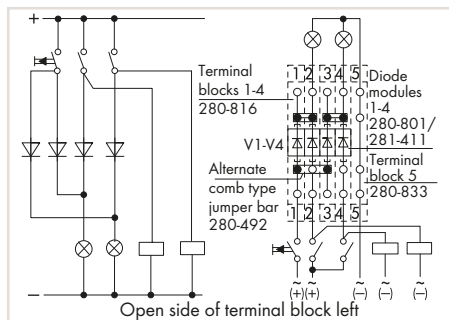

Lamp test circuit with blocking diodes

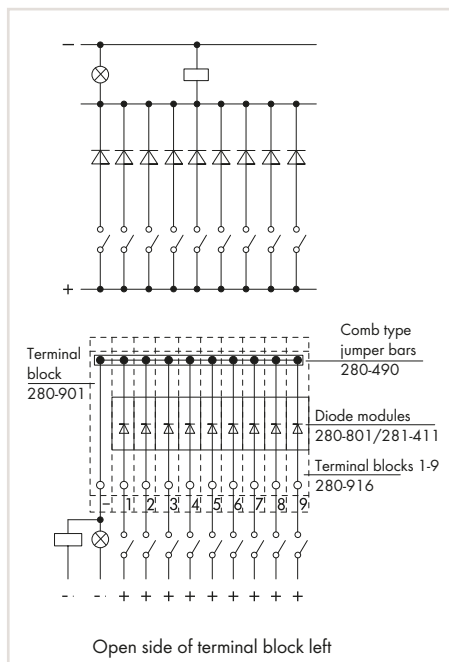

These diode modules are ideal for custom diode circuits (e.g., lamp test and collective fault signal circuits) and offer the following advantages:

- Separation into functional and wiring levels
- Polarized switching direction
- Quick and easy module replacement
- Terminal blocks/modules provide high-density wiring in a width of just 5 mm



280-801/281-411

280-801/281-420

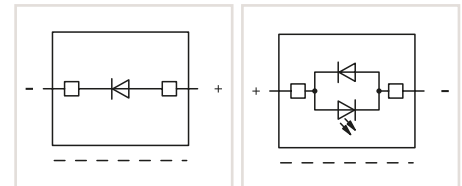

Diode module, with 1N4007 diode		
Color	Item No.	Pack. Unit
○ gray	280-801/281-411	100

Diode module, with 1N4007 recovery diode, red LED, gray		
	Item No.	Pack. Unit
○ 24 VDC	280-801/281-420	100
○ 48 VDC	280-801/281-421	100

### Technical Data

Nominal voltage	250 V
Reverse voltage	1000 V
Rated current	0.5 A
Plug width	5 mm / 0.197 inch
Insulation material	Polyamide 66 (PA 66)

### Accessories (Selection)

2-conductor carrier terminal block, 0.08 ... 2.5 mm <sup>2</sup> / 28 ... 12 AWG (12 AWG: THHN, THWN), 5 mm (0.197 inch) wide	gray	Item No. 280-916	Page 446
3-conductor carrier terminal block, 0.08 ... 2.5 mm <sup>2</sup> / 28 ... 12 AWG (12 AWG: THHN, THWN), 5 mm (0.197 inch) wide	gray	Item No. 280-610	Page 446
4-conductor carrier terminal block, 0.08 ... 2.5 mm <sup>2</sup> / 28 ... 12 AWG (12 AWG: THHN, THWN), 5 mm (0.197 inch) wide	gray	Item No. 280-816	Page 446
Comb-style jumper bar, insulated, I <sub>N</sub> = I <sub>N</sub> terminal block, gray	2-way	Item No. 280-482	Page 440
Wire commoning chain, insulated, 50 connections, I <sub>N</sub> 8 A	black	Item No. 210-103	Page 460

Accessories (comb-style jumper bars, end plates, etc.), see page 440

Carrier rails and tools, see Section 13

Approvals and corresponding ratings, visit [www.wago.com](http://www.wago.com)



## Pluggable Diode Modules on Through Terminal Blocks , 2.5 mm<sup>2</sup> 280 Series

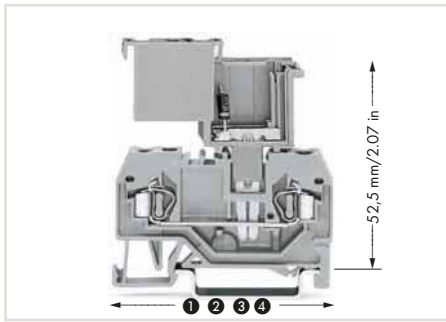

Lengths of through terminal blocks with a pluggable diode module:

- ① 53 mm / 2.09 inch for 280-901
- ② 64 mm / 2.52 inch for 280-681
- ③ 75 mm / 2.95 inch for 280-833
- ④ 42.5 mm / 1.67 inch for 280-101

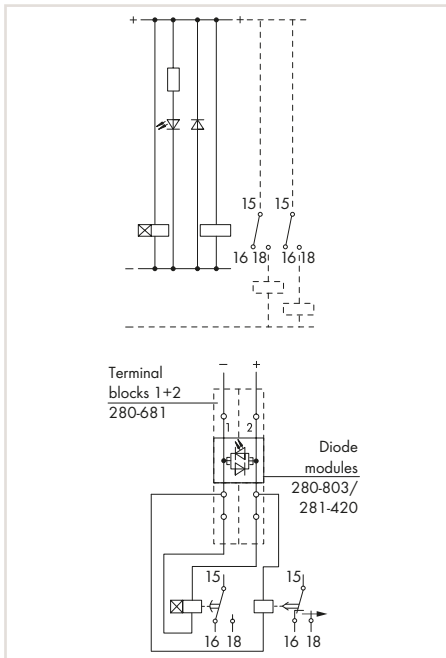

Free-wheeling diode and voltage check

Similar to push-in type jumpers, these diode modules are simply pushed into the current bar's contact slots of two adjacent through terminal blocks, providing the following advantages:

- Compatibility with all 280 Series Through Terminal Blocks
- Easy retrofits for existing systems
- Additional advantages:
  - Separation into functional and wiring levels
  - Fast replacement of other functional units



280-803/281-411

280-803/281-420

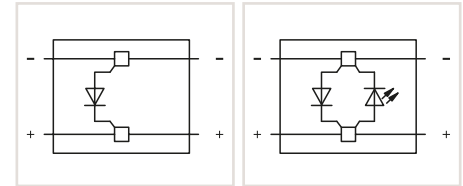

Diode module, with 1N4007 diode, 5 mm wide		
Color	Item No.	Pack. Unit
○ gray	280-803/281-411	50

Diode module, with 1N4007 recovery diode, red LED, gray		
	Item No.	Pack. Unit
○ 24 VDC	280-803/281-420	50
○ 48 VDC	280-803/281-421	50

### Technical Data

Nominal voltage	250 V
Reverse voltage	1000 V
Rated current	0.5 A
Plug width	10 mm / 0.394 inch
Insulation material	Polyamide 66 (PA 66)

### Accessories (Selection)

2-conductor through terminal block, 0.08 ... 2.5 mm <sup>2</sup> / 28 ... 12 AWG (12 AWG: THHN, THWN), 5 mm (0.197 inch) wide	gray	280-901	290
3-conductor through terminal block, 0.08 ... 2.5 mm <sup>2</sup> / 28 ... 12 AWG (12 AWG: THHN, THWN), 5 mm (0.197 inch) wide	gray	280-681	291
4-conductor through terminal block, 0.08 ... 2.5 mm <sup>2</sup> / 28 ... 12 AWG (12 AWG: THHN, THWN), 5 mm (0.197 inch) wide	gray	280-833	291
2-conductor through terminal block, 0.08 ... 2.5 mm <sup>2</sup> / 28 ... 12 AWG (12 AWG: THHN, THWN), 5 mm (0.197 inch) wide	gray	280-101	655
Adjacent jumper, insulated, I <sub>N</sub> = I <sub>N</sub> terminal block	gray	280-402	440
Wire commoning chain, insulated, 50 connections, I <sub>N</sub> 8 A	black	210-103	460

	Item No.	Page
gray	280-901	290
gray	280-681	291
gray	280-833	291
gray	280-101	655
gray	280-402	440
black	210-103	460

Accessories (jumpers, end plates, etc.), see page 440

Carrier rails and tools, see Section 13

Approvals and corresponding ratings, visit [www.wago.com](http://www.wago.com)

# Pluggable LED Modules on Carrier Terminal Blocks, 2.5 mm<sup>2</sup> 280 Series

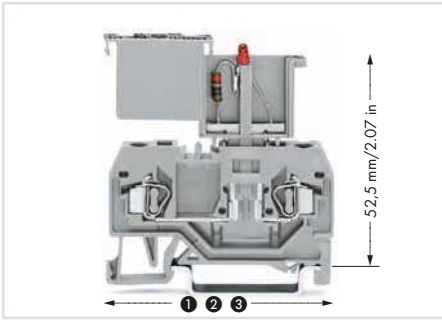

LED module  
 $I_N$  5.6 mA;  $I_F$  25 mA

Neon indicator module  
 $I_N$  0.5 mA



Lengths of carrier terminal blocks with a pluggable LED module:

- ① 53 mm / 2.09 inch for 280-916
- ② 64 mm / 2.52 inch for 280-610
- ③ 75 mm / 2.95 inch for 280-816



The monitoring of control and operating current circuits with LED modules on rail-mount terminal blocks provides several advantages:

- No additional cost for assembly and wiring
- Separation into functional and wiring levels
- Modules can be replaced quickly by other types of modules

Additional advantages:

- Polarized switching direction
- Terminal blocks/modules provide high-density wiring in a width of just 5 mm

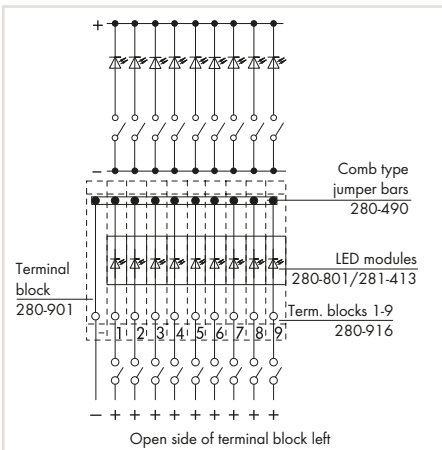

LED gate for collective fault indication – individual display

280-801/281-413

280-801/281-418

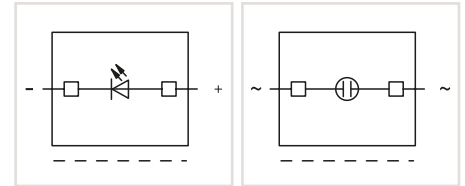

LED module, with red LED, gray

	Item No.	Pack. Unit
○ 24 VDC	280-801/281-413	100
○ 48 VDC	280-801/281-414	100

LED module, with red LED, gray

	Item No.	Pack. Unit
○ 24 VAC/DC	280-801/281-415	100
○ 48 VAC/DC	280-801/281-416	100

Neon indicator module, gray

	Item No.	Pack. Unit
○ 120 VAC/DC	280-801/281-418	100
○ 230 VAC/DC	280-801/281-417	100

### Technical Data

Plug width

5 mm / 0.197 inch

Insulation material

Polyamide 66 (PA 66)

### Accessories (Selection)

2-conductor carrier terminal block, 0.08 ... 2.5 mm<sup>2</sup> / 28 ... 12 AWG (12 AWG: THHN, THWN), 5 mm (0.197 inch) wide

	Item No.	Page
gray	280-916	446

3-conductor carrier terminal block, 0.08 ... 2.5 mm<sup>2</sup> / 28 ... 12 AWG (12 AWG: THHN, THWN), 5 mm (0.197 inch) wide

gray	280-610	446
------	---------	-----

4-conductor carrier terminal block, 0.08 ... 2.5 mm<sup>2</sup> / 28 ... 12 AWG (12 AWG: THHN, THWN), 5 mm (0.197 inch) wide

gray	280-816	446
------	---------	-----

Comb-style jumper bar, insulated,  $I_N = I_N$  terminal block, gray

2-way	280-482	440
-------	---------	-----

Wire commoning chain, insulated, 50 connections,  $I_N$  8 A

black	210-103	460
-------	---------	-----

Accessories (comb-style jumper bars, end plates, etc.), see page 440

Carrier rails and tools, see Section 13

Approvals and corresponding ratings, visit [www.wago.com](http://www.wago.com)

# Pluggable LED Modules on Through Terminal Blocks, 2.5 mm<sup>2</sup> 280 Series

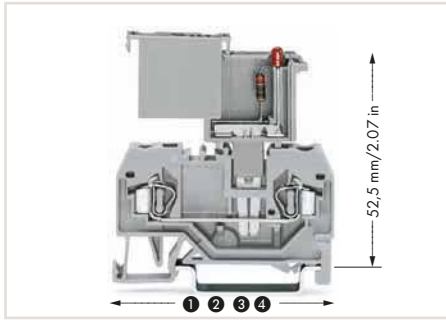

LED module  
 $I_N$  5.6 mA;  $I_F$  25 mA

Neon indicator module  
 $I_N$  0.5 mA



Lengths of through terminal blocks with a pluggable LED module:

- ① 53 mm / 2.09 inch for 280-901
- ② 64 mm / 2.52 inch for 280-681
- ③ 75 mm / 2.95 inch for 280-833
- ④ 42.5 mm / 1.67 inch for 280-101



Similar to push-in type jumpers, these LED and neon indicator modules are simply pushed into the current bar's contact slots of two adjacent through terminal blocks, providing the following advantages:

- Compatibility with all 280 Series Through Terminal Blocks
  - Easy retrofits for existing systems
- Additional advantages:
- Separation into functional and wiring levels
  - Fast replacement of other functional units

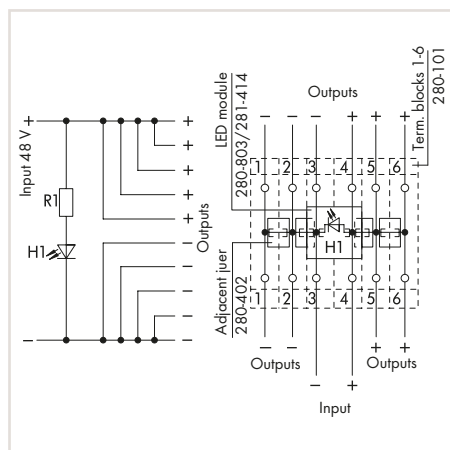

Multiple outputs with indicator lamp

280-803/281-413

280-803/281-418

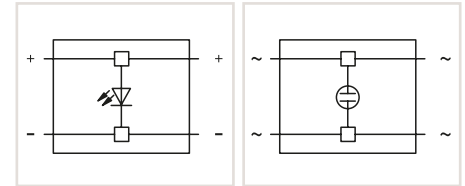

LED module, with red LED, gray		
	Item No.	Pack. Unit
○ 24 VDC	280-803/281-413	50
○ 48 VDC	280-803/281-414	50

LED module, with red LED, gray		
	Item No.	Pack. Unit
○ 24 VAC/DC	280-803/281-415	50
○ 48 VAC/DC	280-803/281-416	50

Neon indicator module, gray		
	Item No.	Pack. Unit
○ 120 VAC/DC	280-803/281-418	50
○ 230 VAC/DC	280-803/281-417	50

### Technical Data

Plug width

10 mm / 0.394 inch

Insulation material

Polyamide 66 (PA 66)

### Accessories (Selection)

2-conductor through terminal block, 0.08 ... 2.5 mm<sup>2</sup> / 28 ... 12 AWG (12 AWG: THHN, THWN), 5 mm (0.197 inch) wide

3-conductor through terminal block, 0.08 ... 2.5 mm<sup>2</sup> / 28 ... 12 AWG (12 AWG: THHN, THWN), 5 mm (0.197 inch) wide

4-conductor through terminal block, 0.08 ... 2.5 mm<sup>2</sup> / 28 ... 12 AWG (12 AWG: THHN, THWN), 5 mm (0.197 inch) wide

2-conductor through terminal block, 0.08 ... 2.5 mm<sup>2</sup> / 28 ... 12 AWG (12 AWG: THHN, THWN), 5 mm (0.197 inch) wide

Adjacent jumper, insulated,  $I_N = I_N$  terminal block

Wire commoning chain, insulated, 50 connections,  $I_N$  8 A

	Item No.	Page
gray	280-901	290
gray	280-681	291
gray	280-833	291
gray	280-101	655
gray	280-402	440
black	210-103	460

Accessories (jumpers, end plates, etc.), see page 440

Carrier rails and tools, see Section 13

Approvals and corresponding ratings, visit [www.wago.com](http://www.wago.com)

## Accessories, 279 Series or a 4 mm Terminal Block Width Commoning, Mounting, Marking and Testing



Adjacent jumper, insulated, I <sub>N</sub> 15 A		
Color	Item No.	Pack. Unit
gray	279-402	200 (25)
yellow-green	279-422	200 (25)



Alternate jumper, insulated, I <sub>N</sub> 15 A		
Color	Item No.	Pack. Unit
gray	279-409	100 (25)



 Comb-style jumper bars,  
see page 284

Comb-style jumper bar, insulated, I <sub>N</sub> = I <sub>N</sub> terminal block, gray		
	Item No.	Pack. Unit
2-way	279-482	200 (25)
3-way	279-483	200 (25)
10-way	279-490	50 (25)



Alternate comb-style jumper bar, insulated, I <sub>N</sub> = I <sub>N</sub> terminal block, gray		
	Item No.	Pack. Unit
2-way	279-492	200 (25)



Operating tool, insulated		
	Item No.	Pack. Unit
2-way	279-432	1
3-way	279-433	1
10-way	279-440	1



 Push-in type wire jumpers,  
see page 284

Push-in type wire jumper, insulated, 0.75 mm <sup>2</sup> conductor cross section, I <sub>N</sub> 9 A		
	Item No.	Pack. Unit
L = 60 mm	249-125	10
L = 110 mm	249-126	10
L = 250 mm	249-127	10



 Step-down jumpers,  
see page 312

Step-down jumper, insulated, commons 10/6 mm <sup>2</sup> (8/10 AWG) down to 4/2.5/1.5 mm <sup>2</sup> (12/14/16 AWG), I <sub>N</sub> 15 A		
Color	Item No.	Pack. Unit
gray	284-414	50 (25)



Step-down cover plate, 1 mm thick		
Color	Item No.	Pack. Unit
gray	284-334	100
orange	284-344	100



Step-down cover plate, 1 mm thick			
Suitable for:	Color	Item No.	Pack. Unit
279-831	gray	284-336	100
	orange	284-346	100



End and intermediate plate, 2 mm thick			
Suitable for:	Color	Item No.	Pack. Unit
279-901	orange	279-328	100 (25)
279-915/281-410	gray	279-325	100 (25)
	light gray	279-330	100 (25)

5

## Accessories, 279 Series or a 4 mm Terminal Block Width Commoning, Mounting, Marking and Testing



Separator, oversized, 2 mm thick			
Suitable for:	Color	Item No.	Pack. Unit
279-901	orange	279-329	100 (25)
279-915/281-410	gray	279-326	100 (25)
	light gray	279-331	100 (25)



End and intermediate plate, 2 mm thick			
Suitable for:	Color	Item No.	Pack. Unit
279-681	orange	279-339	100 (25)
279-673/281-410	gray	279-308	100 (25)
	light gray	279-341	100 (25)



Separator, oversized, 2 mm thick			
Suitable for:	Color	Item No.	Pack. Unit
279-681	orange	279-340	100 (25)
279-673/281-410	gray	279-309	100 (25)
	light gray	279-342	100 (25)



End and intermediate plate, 2 mm thick			
Suitable for:	Color	Item No.	Pack. Unit
279-831	orange	279-346	100 (25)
279-826	gray	279-344	100 (25)
279-815/281-410	light gray	279-348	100 (25)



Separator, oversized, 2 mm thick			
Suitable for:	Color	Item No.	Pack. Unit
279-831	orange	279-347	100 (25)
279-826	gray	279-345	100 (25)
279-815/281-410	light gray	279-349	100 (25)



End and intermediate plate, 2 mm thick			
Suitable for:	Color	Item No.	Pack. Unit
279-501	orange	279-519	100 (25)
	gray	279-518	100 (25)

 Application notes,  
see page 288



Separator for Ex e/Ex i applications, 3 mm thick, orange			
	Item No.	Pack. Unit	
90 mm wide	209-190	50 (25)	
120 mm wide	209-191	50 (25)	

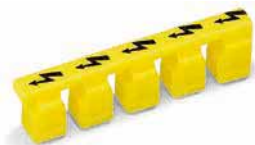

Protective warning marker, with black high-voltage symbol, for 5 terminal blocks			
Color	Item No.	Pack. Unit	
yellow	279-415	100 (25)	



Insulation stop, 5 pcs/strip, 0.08 ... 0.2 mm² "s" (0.14 mm² "f-st")			
Color	Item No.	Pack. Unit	
white	279-470	200 (25)	



Insulation stop, 5 pcs/strip, 0.25 mm²			
Color	Item No.	Pack. Unit	
dark gray	279-471	200 (25)	

## Accessories, 280, 880 and 780 Series or a 5.2 mm Terminal Block Width Commoning, Mounting, Marking and Testing



Adjacent jumper, insulated, $I_N = I_N$ terminal block		
Color	Item No.	Pack. Unit
gray	280-402	200 (25)
yellow-green	280-422	200 (25)



Alternate jumper, insulated, $I_N = I_N$ terminal block		
Color	Item No.	Pack. Unit
gray	280-409	100 (25)



 Staggered jumpers,  
see page 280

Note: Push down the staggered jumper until fully inserted.  
Using staggered jumpers reduces the maximum rated voltage to 275 V.

Rated voltage (III / 3)	400 V
Rated surge voltage (III / 3)	6 kV

Staggered jumper, insulated, 5 mm wide, $I_N$ 24 A, gray		
	Item No.	Pack. Unit
1 to 2	780-452	100 (25)
1 to 3	780-453	100 (25)
1 to 4	780-454	100 (25)
1 to 5	780-455	50 (25)
1 to 6	780-456	50 (25)
1 to 7	780-457	50 (25)
1 to 8	780-458	50 (25)



Vertical jumper, insulated, $I_N$ 24 A			
Suitable for:	Color	Item No.	Pack. Unit
Double- and triple-deck terminal blocks.	gray	281-421	200 (25)



 Comb-style jumper bars,  
see page 284

Comb-style jumper bar, insulated, $I_N = I_N$ terminal block, gray		
	Item No.	Pack. Unit
2-way	280-482	200 (25)
3-way	280-483	200 (25)
4-way	280-484	200 (25)
5-way	280-485	100 (25)
10-way	280-490	50 (25)



Alternate comb-style jumper bar, insulated, $I_N = I_N$ terminal block, gray		
	Item No.	Pack. Unit
2-way	280-492	200 (25)



Operating tool, insulated		
	Item No.	Pack. Unit
2-way	280-432	1
3-way	280-433	1
10-way	280-440	1

5



## Accessories, 280, 880 and 780 Series or a 5.2 mm Terminal Block Width Commoning, Mounting, Marking and Testing



 Push-in type wire jumpers,  
see page 284

Push-in type wire jumper, insulated, 0.75 mm<sup>2</sup> conductor cross section, I<sub>N</sub> 9 A

	Item No.	Pack. Unit
L = 60 mm	249-125	10
L = 110 mm	249-126	10
L = 250 mm	249-127	10



 Step-down jumpers,  
see page 312

Step-down jumper, insulated, commons 10/6 mm<sup>2</sup> (8/10 AWG) down to 4/2.5/1.5 mm<sup>2</sup> (12/14/16 AWG), I<sub>N</sub> 15 A

Color	Item No.	Pack. Unit
gray	284-414	50 (25)



Step-down cover plate, 1 mm thick

Color	Item No.	Pack. Unit
gray	284-334	100
orange	284-344	100



Step-down cover plate, 1 mm thick

Suitable for:	Color	Item No.	Pack. Unit
280-833	gray	284-336	100
	orange	284-346	100



End and intermediate plate, 2.5 mm thick

Suitable for:	Color	Item No.	Pack. Unit
280-901	orange	280-309	100 (25)
280-915/281-410	gray	280-308	100 (25)
	light gray	280-356	100 (25)



Separator, oversized, 2 mm thick

Suitable for:	Color	Item No.	Pack. Unit
280-901	orange	280-311	100 (25)
280-915/281-410	gray	280-310	100 (25)
	light gray	280-357	100 (25)



Spacer with same profile, for 2-conductor terminal blocks of horizontal type

Suitable for:	Color	Item No.	Pack. Unit
280-901	orange	280-902/056-000	100 (25)



End and intermediate plate, 2.5 mm thick

Suitable for:	Color	Item No.	Pack. Unit
280-681	orange	280-326	100 (25)
280-673/281-410	gray	280-324	100 (25)
	light gray	280-358	100 (25)



Separator, oversized, 2 mm thick

Suitable for:	Color	Item No.	Pack. Unit
280-681	orange	280-346	100 (25)
280-673/281-410	gray	280-344	100 (25)
	light gray	280-359	100 (25)



Spacer with same profile, for 3-conductor terminal blocks of horizontal type

Suitable for:	Color	Item No.	Pack. Unit
280-681	orange	280-650/056-000	100

## Accessories, 280, 880 and 780 Series or a 5.2 mm Terminal Block Width Commoning, Mounting, Marking and Testing



End and intermediate plate, 2.5 mm thick			
Suitable for:	Color	Item No.	Pack. Unit
280-833	orange	280-315	100 (25)
280-826	gray	280-314	100 (25)
280-815/281-410	light gray	280-352	100 (25)



Separator, oversized, 2 mm thick			
Suitable for:	Color	Item No.	Pack. Unit
280-833	orange	280-335	100 (25)
280-826	gray	280-334	100 (25)
280-815/281-410	light gray	280-353	100 (25)



Spacer with same profile, for 3-conductor terminal blocks of horizontal type			
Suitable for:	Color	Item No.	Pack. Unit
280-833	orange	280-835/056-000	100 (25)

5



End and intermediate plate, 2.5 mm thick			
Suitable for:	Color	Item No.	Pack. Unit
280-641	orange	280-313	100 (25)
280-646	gray	280-312	100 (25)
	light gray	280-354	100 (25)



Separator, oversized, 2 mm thick			
Suitable for:	Color	Item No.	Pack. Unit
280-641	orange	280-318	100 (25)
280-646	gray	280-348	100 (25)
	light gray	280-355	100 (25)



Spacer with same profile, for 3- and 4-conductor terminal blocks of angled type			
Suitable for:	Color	Item No.	Pack. Unit
280-641	orange	280-654/056-000	100 (25)



End and intermediate plate, 2.5 mm thick			
Suitable for:	Color	Item No.	Pack. Unit
880-901/999-940	orange	880-328	100 (25)
	gray	880-325	100 (25)



Separator, oversized, 2 mm thick			
Suitable for:	Color	Item No.	Pack. Unit
880-901/999-940	orange	880-329	100 (25)
	gray	880-326	100 (25)



End and intermediate plate, 2.5 mm thick			
Suitable for:	Color	Item No.	Pack. Unit
880-681/999-940	orange	880-339	100 (25)
	gray	880-308	100 (25)



Separator, oversized, 2 mm thick			
Suitable for:	Color	Item No.	Pack. Unit
880-681/999-940	orange	880-340	100 (25)
	gray	880-309	100 (25)



End and intermediate plate, 2.5 mm thick			
Suitable for:	Color	Item No.	Pack. Unit
880-831/999-940	orange	880-346	100 (25)
	gray	880-344	100 (25)

## Accessories, 280, 880 and 780 Series or a 5.2 mm Terminal Block Width Commoning, Mounting, Marking and Testing



Separator, oversized, 2 mm thick			
Suitable for:	Color	Item No.	Pack. Unit
880-831/999-940	orange	880-347	100 (25)
	gray	880-345	100 (25)



End and intermediate plate, 2.5 mm thick			
Suitable for:	Color	Item No.	Pack. Unit
Double-deck terminal blocks	orange	280-341	100 (25)
	gray	280-340	100 (25)



Intermediate plate, 1.1 mm thick			
Suitable for:	Color	Item No.	Pack. Unit
Double-deck terminal blocks	orange	280-366	100 (25)



End and intermediate plate, 2.5 mm thick			
Suitable for:	Color	Item No.	Pack. Unit
Double-deck terminal blocks with additional jumper position	orange	280-343	100 (25)
	gray	280-342	100 (25)



Intermediate plate, 1.1 mm thick			
Suitable for:	Color	Item No.	Pack. Unit
Double-deck terminal blocks with additional jumper position	orange	280-369	100 (25)



End and intermediate plate, 2.5 mm thick			
Suitable for:	Color	Item No.	Pack. Unit
Triple-deck terminal blocks	orange	280-304	50 (25)
	gray	280-303	50 (25)



Intermediate plate, 1.1 mm thick			
Suitable for:	Color	Item No.	Pack. Unit
Triple-deck terminal blocks	orange	280-336	50 (25)



End and intermediate plate, 2.5 mm thick			
Suitable for:	Color	Item No.	Pack. Unit
Triple-deck terminal blocks with additional jumper position	orange	280-306	50 (25)
	gray	280-305	50 (25)



Intermediate plate, 1.1 mm thick			
Suitable for:	Color	Item No.	Pack. Unit
Triple-deck terminal blocks with additional jumper position	orange	280-339	50 (25)



End and intermediate plate, 1.5 mm thick			
Suitable for:	Color	Item No.	Pack. Unit
780-601	orange	780-317	100 (25)



End and intermediate plate, 2.5 mm thick			
Suitable for:	Color	Item No.	Pack. Unit
280-870	orange	280-371	100 (25)
280-871	gray	280-374	100 (25)



End and intermediate plate, 2.5 mm thick			
Suitable for:	Color	Item No.	Pack. Unit
280-874	orange	280-373	100 (25)
280-875	gray	280-376	100 (25)

5

## Accessories, 280, 880 and 780 Series or a 5.2 mm Terminal Block Width Commoning, Mounting, Marking and Testing



End and intermediate plate, for triple-deck terminal blocks, 1 mm thick			
Suitable for:	Color	Item No.	Pack. Unit
Sensor and actuator terminal blocks	orange	280-321	100 (25)
	gray	280-319	100 (25)



End and intermediate plate, for quadruple-deck terminal blocks, 1 mm thick			
Suitable for:	Color	Item No.	Pack. Unit
Sensor and actuator terminal blocks	orange	280-323	100 (25)
	gray	280-320	100 (25)



 Application notes, see page 288

Separator for Ex e/Ex i applications, 3 mm thick, orange		
	Item No.	Pack. Unit
90 mm wide	209-190	50 (25)
120 mm wide	209-191	50 (25)



Separator for Ex e/Ex i applications, 3 mm thick, orange			
Suitable for:		Item No.	Pack. Unit
Rail-mount terminal blocks, TOPJOB® Classic, 780 ... 782, 784 Series	125.5 mm wide	209-192	50 (25)



 Test plugs, see page 283

These test plugs are not suitable for Ex e applications.

Test voltage	400 V
Test current	6 A

Test plug module, snaps together, for all WAGO 280 and 780 Series Rail-Mount Terminal Blocks with jumper slots in the current bar  
Module width 5 mm

Color	Item No.	Pack. Unit
gray	280-418	100 (25)



Spacer module, snaps together, bridges terminal blocks  
Module width 5 mm

Color	Item No.	Pack. Unit
gray	280-419	100 (25)



 Test plugs, see page 282

Power must be switched off when installing the test plug adapter. The safety rules for working on live installations must be observed. These test plugs are not suitable for Ex e applications.

Test voltage	630 V
Test current	6 A

L-type test plug module with spring-loaded contact pin and CAGE CLAMP®, center module, snaps together  
Module width 5 mm

Color	Item No.	Pack. Unit
gray	249-141	100 (25)

## Accessories, 280, 880 and 780 Series or a 5.2 mm Terminal Block Width

### Commoning, Mounting, Marking and Testing



Power must be switched off when installing the test plug adapter. The safety rules for working on live installations must be observed. These test plugs are not suitable for Ex e applications.

Test voltage	630 V
Test current	6 A

L-type end test plug module with rigid contact pin and CAGE CLAMP®, end module, snaps together  
Module width 5 mm

Color	Item No.	Pack. Unit
gray	249-142	100 (25)



L-type spacer module, snaps together, bridges wired terminal blocks  
Module width 5 mm

Color	Item No.	Pack. Unit
gray	249-143	100 (25)



 Test plugs,  
see page 282

Power must be switched off when installing the test plug adapter. The safety rules for working on live installations must be observed. These test plugs are not suitable for Ex e applications.

Test voltage	630 V
Test current	6 A

B-type test plug module, snaps together  
Module width 5 mm

Color	Item No.	Pack. Unit
gray	249-106	100 (25)



B-type spacer module, snaps together, bridges commoned terminal blocks  
Module width 5 mm

Color	Item No.	Pack. Unit
gray	249-107	100 (25)



Measurement range category	CAT I
Test voltage (AC)	30 V
Test voltage (DC)	60 V
Test current	1 A

Test socket, insulated, 2 mm Ø

Suitable for:	Color	Item No.	Pack. Unit
Disconnect terminal blocks, 280 and 281 Series	red	209-107	100 (50)



Measurement range category	CAT I
Test voltage (AC)	30 V
Test voltage (DC)	60 V
Test current	1 A

Test socket, insulated, 2,3 mm Ø

Suitable for:	Color	Item No.	Pack. Unit
Disconnect terminal blocks, 280 and 281 Series	yellow	209-108	100 (50)

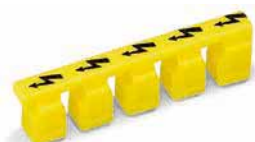

Protective warning marker, with black high-voltage symbol, for 5 terminal blocks

Color	Item No.	Pack. Unit
yellow	280-415	100 (25)

## Accessories, 280, 880 and 780 Series or a 5.2 mm Terminal Block Width Commoning, Mounting, Marking and Testing



Insulation stop, 5 pcs/strip, 0.08 ... 0.2 mm <sup>2</sup> "s" (0.14 mm <sup>2</sup> "f-st")			
Color	Item No.	Pack. Unit	
white	280-470	200 (25)	



Insulation stop, 5 pcs/strip, 0.25 ... 0.5 mm <sup>2</sup>			
Color	Item No.	Pack. Unit	
light gray	280-471	200 (25)	



Insulation stop, 5 pcs/strip, 0.75 ... 1 mm <sup>2</sup>			
Color	Item No.	Pack. Unit	
dark gray	280-472	200 (25)	



Disconnect lock, for disconnect tab used on disconnect terminal blocks (280/281 and 769 Series)			
Suitable for:	Color	Item No.	Pack. Unit
Disconnect terminal blocks, 280 and 281 Series	red	709-170	200 (25)

5



2-conductor carrier terminal block, 0.08 ... 2.5 mm <sup>2</sup> / 28 ... 12 AWG (12 AWG: THHN, THWN), 5 mm (0.197 inch) wide			
Suitable for:	Color	Item No.	Pack. Unit
280-850 280-801/281-411 280-801/281-413	gray	280-916	100



3-conductor carrier terminal block, 0.08 ... 2.5 mm <sup>2</sup> / 28 ... 12 AWG (12 AWG: THHN, THWN), 5 mm (0.197 inch) wide			
Suitable for:	Color	Item No.	Pack. Unit
280-850 280-801/281-411 280-801/281-413	gray	280-610	0.75 mm 100



4-conductor carrier terminal block, 0.08 ... 2.5 mm <sup>2</sup> / 28 ... 12 AWG (12 AWG: THHN, THWN), 5 mm (0.197 inch) wide			
Suitable for:	Color	Item No.	Pack. Unit
280-850 280-801/281-411 280-801/281-413	gray	280-816	100



## Accessories, 281 and 781 Series or a 6 mm Terminal Block Width Commoning, Mounting, Marking and Testing



Adjacent jumper, insulated, $I_N = I_N$ terminal block		
Color	Item No.	Pack. Unit
gray	281-402	200 (25)
yellow-green	281-422	200 (25)



Alternate jumper, insulated, $I_N = I_N$ terminal block		
Color	Item No.	Pack. Unit
gray	281-409	100 (25)



 Staggered jumpers,  
see page 280

Note: Push down the staggered jumper until fully inserted.  
Using staggered jumpers reduces the maximum rated voltage to 275 V.

Rated voltage (III / 3)	400 V
Rated surge voltage (III / 3)	6 kV

Staggered jumper, insulated, 6 mm wide, $I_N$ 32 A, gray		
	Item No.	Pack. Unit
1 to 2	781-452	100 (25)
1 to 3	781-453	100 (25)
1 to 4	781-454	100 (25)
1 to 5	781-455	50 (25)
1 to 6	781-456	50 (25)



Vertical jumper, insulated, $I_N$ 24 A			
Suitable for:	Color	Item No.	Pack. Unit
Double-deck terminal blocks	gray	281-421	200 (25)



 Comb-style jumper bars,  
see page 284

Comb-style jumper bar, insulated, $I_N = I_N$ terminal block, gray		
	Item No.	Pack. Unit
2-way	281-482	100 (25)
3-way	281-483	100 (25)
5-way	281-485	100 (25)
10-way	281-490	50 (25)



Alternate comb-style jumper bar, insulated, $I_N = I_N$ terminal block, gray		
	Item No.	Pack. Unit
2-way	281-492	100 (25)



Operating tool, insulated		
	Item No.	Pack. Unit
2-way	280-432	1
3-way	280-433	1
10-way	281-440	1

## Accessories, 281 and 781 Series or a 6 mm Terminal Block Width Commoning, Mounting, Marking and Testing



Push-in type wire jumpers, see page 284

Push-in type wire jumper, insulated, 0.75 mm <sup>2</sup> conductor cross section, I <sub>N</sub> 9 A		
	Item No.	Pack. Unit
L = 60 mm	249-125	10
L = 110 mm	249-126	10
L = 250 mm	249-127	10



Step-down jumpers, see page 312

Step-down jumper, insulated, commons 10/6 mm <sup>2</sup> (8/10 AWG) down to 4/2.5/1.5 mm <sup>2</sup> (12/14/16 AWG), I <sub>N</sub> 15 A		
Color	Item No.	Pack. Unit
gray	284-414	50 (25)



Step-down jumpers, see page 312

Step-down jumper, insulated, commons 10/6 mm <sup>2</sup> (8/10 AWG) down to 6/4 mm <sup>2</sup> (10/12 AWG), I <sub>N</sub> 30 A		
Color	Item No.	Pack. Unit
gray	284-413	50 (25)



Step-down cover plate, 1 mm thick		
Color	Item No.	Pack. Unit
gray	284-334	100
orange	284-344	100



Step-down cover plate, 1 mm thick			
Suitable for:	Color	Item No.	Pack. Unit
281-652	gray	284-336	100
	orange	284-346	100



End and intermediate plate, 2.5 mm thick			
Suitable for:	Color	Item No.	Pack. Unit
281-901	orange	281-329	100 (25)
281-915/281-410	gray	281-328	100 (25)
	light gray	281-349	100 (25)



Separator, oversized, 2 mm thick			
Suitable for:	Color	Item No.	Pack. Unit
281-901	orange	281-331	100 (25)
281-915/281-410	gray	281-330	100 (25)
	light gray	281-350	100 (25)



End and intermediate plate, 2.5 mm thick			
Suitable for:	Color	Item No.	Pack. Unit
281-681	orange	281-326	100 (25)
281-673/281-410	gray	281-324	100 (25)
	light gray	281-355	100 (25)



Separator, oversized, 2 mm thick			
Suitable for:	Color	Item No.	Pack. Unit
281-681	orange	281-346	100 (25)
281-673/281-410	gray	281-344	100 (25)
	light gray	281-356	100 (25)



End and intermediate plate, 2.5 mm thick			
Suitable for:	Color	Item No.	Pack. Unit
281-652	orange	281-335	100 (25)
281-665/281-410	gray	281-334	100 (25)
	light gray	281-345	100 (25)

5

## Accessories, 281 and 781 Series or a 6 mm Terminal Block Width Commoning, Mounting, Marking and Testing



Separator, oversized, 2 mm thick			
Suitable for:	Color	Item No.	Pack. Unit
281-652	orange	281-339	100 (25)
281-665/281-410	gray	281-338	100 (25)
	light gray	281-347	100 (25)



End and intermediate plate, 2.5 mm thick			
Suitable for:	Color	Item No.	Pack. Unit
281-631	orange	281-313	100 (25)
	gray	281-312	100 (25)
	light gray	281-357	100 (25)



Separator, oversized, 2 mm thick			
Suitable for:	Color	Item No.	Pack. Unit
281-631	orange	281-318	100 (25)
	gray	281-348	100 (25)
	light gray	281-358	100 (25)



End and intermediate plate, 2.5 mm thick			
Suitable for:	Color	Item No.	Pack. Unit
Double-deck terminal blocks	orange	281-341	100 (25)
	gray	281-340	100 (25)



End and intermediate plate, 2.5 mm thick			
Suitable for:	Color	Item No.	Pack. Unit
Double-deck terminal blocks with additional jumper position	orange	281-343	100 (25)
	gray	281-342	100 (25)



End and intermediate plate, 1 mm thick			
Suitable for:	Color	Item No.	Pack. Unit
Quadruple-deck terminal blocks	orange	281-366	100 (25)
	gray	281-365	100 (25)



End and intermediate plate, 1.5 mm thick			
Suitable for:	Color	Item No.	Pack. Unit
781-601	orange	780-317	100 (25)

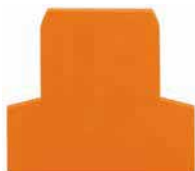

End and intermediate plate, 2.5 mm thick			
Suitable for:	Color	Item No.	Pack. Unit
281-611	orange	281-309	100 (25)
281-613	gray	281-311	100 (25)

 Application notes, see page 288



Separator for Ex e/Ex i applications, 3 mm thick, orange			
	Item No.	Pack. Unit	
90 mm wide	209-190	50 (25)	
120 mm wide	209-191	50 (25)	

## Accessories, 281 and 781 Series or a 6 mm Terminal Block Width Commoning, Mounting, Marking and Testing



Separator for Ex e/Ex i applications, 3 mm thick, orange

Suitable for:	Item No.	Pack. Unit
Rail-mount terminal blocks, 125.5 mm wide TOPJOB® Classic, 780 ... 782, 784 Series	209-192	50 (25)



Test plugs,  
see page 283

These test plugs are not suitable for Ex e applications.

Test voltage	400 V
Test current	6 A

Test plug module, snaps together, for all WAGO 281, 776, 777 and 781 Series Rail-Mount Terminal Blocks with jumper slots in the current bar  
Module width 6 mm

Color	Item No.	Pack. Unit
gray	281-418	100 (25)

5



Spacer module, snaps together, bridges terminal blocks  
Module width 6 mm

Color	Item No.	Pack. Unit
gray	281-419	100 (25)



Test plugs,  
see page 282

Power must be switched off when installing the test plug adapter. The safety rules for working on live installations must be observed. These test plugs are not suitable for Ex e applications.

Test voltage	630 V
Test current	6 A

L-type test plug module with spring-loaded contact pin and CAGE CLAMP®, center module, snaps together  
Module width 6 mm

Color	Item No.	Pack. Unit
gray	249-144	100 (25)



Power must be switched off when installing the test plug adapter. The safety rules for working on live installations must be observed. These test plugs are not suitable for Ex e applications.

Test voltage	630 V
Test current	6 A

L-type end test plug module with rigid contact pin and CAGE CLAMP®, end module, snaps together  
Module width 6 mm

Color	Item No.	Pack. Unit
gray	249-145	100 (25)



L-type spacer module, snaps together, bridges wired terminal blocks  
Module width 6 mm

Color	Item No.	Pack. Unit
gray	249-146	100 (25)

## Accessories, 281 and 781 Series or a 6 mm Terminal Block Width Commoning, Mounting, Marking and Testing



 Test plugs,  
see page 282

Power must be switched off when installing the test plug adapter. The safety rules for working on live installations must be observed. These test plugs are not suitable for Ex e applications.

Test voltage	630 V
Test current	6 A

B-type test plug module, snaps together  
Module width 6 mm

Color	Item No.	Pack. Unit
gray	249-147	100 (25)



B-type spacer module, snaps together, bridges commoned terminal blocks  
Module width 6 mm

Color	Item No.	Pack. Unit
gray	249-148	100 (25)



Measurement range category	CAT I
Test voltage (AC)	30 V
Test voltage (DC)	60 V
Test current	1 A

Test socket, insulated, 2 mm Ø

Suitable for:	Color	Item No.	Pack. Unit
Disconnect terminal blocks, 280 and 281 Series	red	209-107	100 (50)



Measurement range category	CAT I
Test voltage (AC)	30 V
Test voltage (DC)	60 V
Test current	1 A

Test socket, insulated, 2,3 mm Ø

Suitable for:	Color	Item No.	Pack. Unit
Disconnect terminal blocks, 280 and 281 Series	yellow	209-108	100 (50)

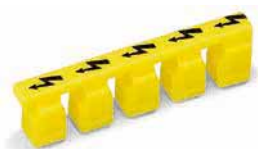

Protective warning marker, with black high-voltage symbol, for 5 terminal blocks

Color	Item No.	Pack. Unit
yellow	281-415	100 (25)



Insulation stop, 5 pcs/strip, 0.08 ... 0.2 mm<sup>2</sup> "s" (0.14 mm<sup>2</sup> "f-st")

Color	Item No.	Pack. Unit
white	281-470	200 (25)



Insulation stop, 5 pcs/strip, 0.25 ... 0.5 mm<sup>2</sup>

Color	Item No.	Pack. Unit
light gray	281-471	200 (25)



Insulation stop, 5 pcs/strip, 0.75 ... 1 mm<sup>2</sup>

Color	Item No.	Pack. Unit
dark gray	281-472	200 (25)

## Accessories, 281 and 781 Series or a 6 mm Terminal Block Width Commoning, Mounting, Marking and Testing



Disconnect lock, for disconnect tab used on disconnect terminal blocks (280/281 and 769 Series)			
Suitable for:	Color	Item No.	Pack. Unit
Disconnect terminal blocks, 280 and 281 Series	red	709-170	200 (25)



Interlocking link, mechanically locks multiple links, 1 m long			
Suitable for:	Color	Item No.	Pack. Unit
281-611 281-613	transparent	210-254	1

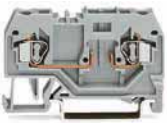

2-conductor carrier terminal block, 0.08 ... 4 mm <sup>2</sup> (28 ... 12 AWG), 6 mm (0.236 inch) wide			
Suitable for:	Color	Item No.	Pack. Unit
281-511	gray	281-916	50



3-conductor carrier terminal block, 0.08 ... 4 mm <sup>2</sup> (28 ... 12 AWG), 6 mm (0.236 inch) wide			
Suitable for:	Color	Item No.	Pack. Unit
281-511	gray	281-610	50



4-conductor carrier terminal block, 0.08 ... 4 mm <sup>2</sup> (28 ... 12 AWG), 6 mm (0.236 inch) wide			
Suitable for:	Color	Item No.	Pack. Unit
281-511	gray	281-656	50

5



## Accessories, 282 and 782 Series or a 8 mm Terminal Block Width Commoning, Mounting, Marking and Testing



Adjacent jumper, insulated, I <sub>N</sub> 41 A			
Color	Item No.	Pack.	Unit
gray	282-402	100	(25)
yellow-green	282-422	100	(25)
orange	282-424	100	(25)



Alternate jumper, insulated, I <sub>N</sub> 41 A			
Color	Item No.	Pack.	Unit
gray	282-409	100	(25)



Step-down jumpers, see page 312

Step-down jumper, insulated, commons 10/6 mm <sup>2</sup> (8/10 AWG) down to 4/2.5/1.5 mm <sup>2</sup> (12/14/16 AWG), I <sub>N</sub> 15 A			
Color	Item No.	Pack.	Unit
gray	284-414	50	(25)



Step-down jumpers, see page 312

Step-down jumper, insulated, commons 10/6 mm <sup>2</sup> (8/10 AWG) down to 6/4 mm <sup>2</sup> (10/12 AWG), I <sub>N</sub> 30 A			
Color	Item No.	Pack.	Unit
gray	284-413	50	(25)



Step-down cover plate, 1 mm thick			
Suitable for:	Color	Item No.	Pack. Unit
282-901	gray	282-357	25
	orange	282-367	25



Step-down cover plate, 1 mm thick			
Suitable for:	Color	Item No.	Pack. Unit
282-681	gray	282-358	25
	orange	282-368	25



End and intermediate plate, 2.5 mm thick			
Suitable for:	Color	Item No.	Pack. Unit
282-901	orange	282-328	100 (25)
	gray	282-325	100 (25)
	light gray	282-330	100 (25)



Separator, oversized, 2 mm thick			
Suitable for:	Color	Item No.	Pack. Unit
282-901	orange	282-329	100 (25)
	gray	282-326	100 (25)
	light gray	282-331	100 (25)



End and intermediate plate, 2.5 mm thick			
Suitable for:	Color	Item No.	Pack. Unit
282-681	orange	282-339	100 (25)
	gray	282-308	100 (25)
	light gray	282-341	100 (25)



Separator, oversized, 2 mm thick			
Suitable for:	Color	Item No.	Pack. Unit
282-681	orange	282-340	100 (25)
	gray	282-309	100 (25)
	light gray	282-342	100 (25)

## Accessories, 282 and 782 Series or a 8 mm Terminal Block Width Commoning, Mounting, Marking and Testing



End and intermediate plate, 1.5 mm thick			
Suitable for:	Color	Item No.	Pack. Unit
782-601	orange	782-317	100 (25)



End plate, 2 mm thick			
Suitable for:	Color	Item No.	Pack. Unit
282-640	orange	282-333	100 (25)
282-697	gray	282-334	100 (25)



 Application notes,  
see page 288

Separator for Ex e/Ex i applications, 3 mm thick, orange			
		Item No.	Pack. Unit
120 mm wide		209-191	50 (25)

5



 Test plugs,  
see page 283

Power must be switched off when installing the test plug adapter. The safety rules for working on live installations must be observed. These test plugs are not suitable for Ex e applications.

Test voltage	800 V
Test current	32 A

B-type test plug module, snaps together Module width 8 mm		
Color	Item No.	Pack. Unit
gray	709-310	100 (25)



B-type spacer module, snaps together, bridges commoned terminal blocks Module width 8 mm		
Color	Item No.	Pack. Unit
gray	709-311	100 (25)



Strain relief plate, gray, for 8 mm wide terminal blocks			
Suitable for:		Item No.	Pack. Unit
709-310	2-pole	709-322	100 (25)
	4-pole	709-324	100 (25)
	6-pole	709-326	100 (25)



Protective warning marker, with black high-voltage symbol, for 5 terminal blocks		
Color	Item No.	Pack. Unit
yellow	282-415	100 (25)

## Accessories, 284 and 784 Series or a 10 mm Terminal Block Width Commoning, Mounting, Marking and Testing



Adjacent jumper, insulated, I <sub>N</sub> 57 A			
Color	Item No.	Pack. Unit	
gray	284-402	100 (25)	
yellow-green	284-422	100 (25)	



Alternate jumper, insulated, I <sub>N</sub> 57 A			
Color	Item No.	Pack. Unit	
gray	284-409	50 (25)	



Comb-style jumper bar, insulated, I <sub>N</sub> 125 A			
Suitable for:	Color	Item No.	Pack. Unit
284-621	gray	284-412	100 (25)



Step-down jumpers,  
see page 312

Step-down jumper, insulated, commons 10/6 mm <sup>2</sup> (8/10 AWG) down to 4/2.5/1.5 mm <sup>2</sup> (12/14/16 AWG), I <sub>N</sub> 15 A			
Color	Item No.	Pack. Unit	
gray	284-414	50 (25)	



Step-down jumpers,  
see page 312

Step-down jumper, insulated, commons 10/6 mm <sup>2</sup> (8/10 AWG) down to 6/4 mm <sup>2</sup> (10/12 AWG), I <sub>N</sub> 30 A			
Color	Item No.	Pack. Unit	
gray	284-413	50 (25)	



Step-down cover plate, 1 mm thick			
Suitable for:	Color	Item No.	Pack. Unit
284-901	gray	284-357	25
	orange	284-367	25



Step-down cover plate, 1 mm thick			
Suitable for:	Color	Item No.	Pack. Unit
284-681	gray	284-358	25
	orange	284-368	25



End and intermediate plate, 2.5 mm thick			
Suitable for:	Color	Item No.	Pack. Unit
284-901	orange	284-328	100 (25)
	gray	284-325	100 (25)
	light gray	284-330	100 (25)



Separator, oversized, 2 mm thick			
Suitable for:	Color	Item No.	Pack. Unit
284-901	orange	284-329	100 (25)
	gray	284-326	100 (25)
	light gray	284-331	100 (25)



End and intermediate plate, 2.5 mm thick			
Suitable for:	Color	Item No.	Pack. Unit
284-681	orange	284-339	100 (25)
	gray	284-308	100 (25)
	light gray	284-341	100 (25)

## Accessories, 284 and 784 Series or a 10 mm Terminal Block Width Commoning, Mounting, Marking and Testing



Separator, oversized, 2 mm thick			
Suitable for:	Color	Item No.	Pack. Unit
284-681	orange	284-340	100 (25)
	gray	284-309	100 (25)
	light gray	284-342	100 (25)



End and intermediate plate, 1.5 mm thick			
Suitable for:	Color	Item No.	Pack. Unit
784-601	orange	782-317	100 (25)



Application notes, see page 288

Separator for Ex e/Ex i applications, 3 mm thick, orange			
		Item No.	Pack. Unit
120 mm wide		209-191	50 (25)

5



Test plugs, see page 283

Power must be switched off when installing the test plug adapter. The safety rules for working on live installations must be observed. These test plugs are not suitable for Ex e applications.

Test voltage	800 V
Test current	32 A

B-type test plug module, snaps together Module width 8 mm			
Color		Item No.	Pack. Unit
gray		709-310	100 (25)



B-type spacer module, snaps together, bridges commoned terminal blocks Module width 8 mm			
Color		Item No.	Pack. Unit
gray		709-311	100 (25)



B-type spacer plate, snaps together, snaps on B-type test plug modules (709-310) and B-type spacer modules (709-311) Module width 2 mm			
Color		Item No.	Pack. Unit
gray		709-312	100 (25)



Strain relief plate, gray, for 10 mm wide terminal blocks			
Suitable for:		Item No.	Pack. Unit
709-310 + 709-312	2-pole	709-332	100 (25)
	4-pole	709-334	100 (25)
	6-pole	709-336	100 (25)

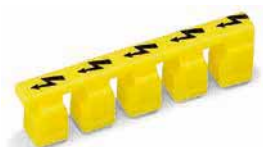

Protective warning marker, with black high-voltage symbol, for 5 terminal blocks			
Color		Item No.	Pack. Unit
yellow		284-415	50 (25)



Finger guard, touch-proof cover protects unused conductor entries			
Color		Item No.	Pack. Unit
yellow		284-400	100 (25)

## Accessories, 283 and 783 Series or a 12 mm Terminal Block Width Commoning, Mounting, Marking and Testing



Adjacent jumper, insulated, I <sub>N</sub> 70 A		
Color	Item No.	Pack. Unit
gray	283-402	50 (25)
yellow-green	283-422	50 (25)



Alternate jumper, insulated, I <sub>N</sub> 76 A		
Color	Item No.	Pack. Unit
gray	283-409	50 (25)



 Step-down jumpers,  
see page 312

Step-down jumper, insulated, commons 16 mm <sup>2</sup> (6 AWG) down to 4 mm <sup>2</sup> (12 AWG), I <sub>N</sub> 32 A		
Color	Item No.	Pack. Unit
gray	283-414	50 (25)



Step-down cover plate, 1 mm thick			
Suitable for:	Color	Item No.	Pack. Unit
283-901	gray	283-357	25
	orange	283-367	25



End and intermediate plate, 2.5 mm thick			
Suitable for:	Color	Item No.	Pack. Unit
283-901	orange	283-328	50 (25)
	gray	283-325	50 (25)
	light gray	283-330	50 (25)



Separator, oversized, 2 mm thick			
Suitable for:	Color	Item No.	Pack. Unit
283-901	orange	283-329	50 (25)
	gray	283-326	50 (25)
	light gray	283-331	50 (25)



End and intermediate plate, 2.5 mm thick			
Suitable for:	Color	Item No.	Pack. Unit
283-671	orange	283-352	50 (25)
	gray	283-350	50 (25)
	light gray	283-354	50 (25)



Separator, oversized, 2 mm thick			
Suitable for:	Color	Item No.	Pack. Unit
283-671	orange	283-353	50 (25)
	gray	283-351	50 (25)
	light gray	283-355	50 (25)



End and intermediate plate, 1.5 mm thick			
Suitable for:	Color	Item No.	Pack. Unit
783-601	orange	783-317	100 (25)

## Accessories, 283 and 783 Series or a 12 mm Terminal Block Width Commoning, Mounting, Marking and Testing



Test plug adapter, 11.6 mm wide, for 4 mm Ø test plug, for 1.5 ... 16 mm <sup>2</sup> terminal blocks			
Suitable for:	Color	Item No.	Pack. Unit
283-901	gray	283-404	25



Power tap, with 500 mm cable, for 16 mm <sup>2</sup> /6 AWG (283/783 Series) and 35 mm <sup>2</sup> /2 AWG (285/785 Series) rail-mount terminal blocks			
Suitable for:	Color	Item No.	Pack. Unit
283-901	gray	283-407	25



Protective warning marker, with black high-voltage symbol, for 5 terminal blocks			
Color	Item No.	Pack. Unit	
yellow	283-415	50 (25)	



Finger guard, touch-proof cover protects unused conductor entries			
Color	Item No.	Pack. Unit	
yellow	283-400	100 (25)	

5



## Accessories, 285 and 785 Series or a 16 mm Terminal Block Width Commoning, Mounting, Marking and Testing



Adjacent jumper, insulated, I <sub>N</sub> 85 A			
Suitable for:	Color	Item No.	Pack. Unit
285-635	gray	285-435	50 (25)



 Step-down jumpers,  
see page 312

Step-down jumper, insulated, commons 16 mm <sup>2</sup> (6 AWG) down to 4 mm <sup>2</sup> (12 AWG), I <sub>N</sub> 32 A			
Color		Item No.	Pack. Unit
gray		283-414	50 (25)



Power tap, with 500 mm cable, for 16 mm <sup>2</sup> /6 AWG (283/783 Series) and 35 mm <sup>2</sup> /2 AWG (285/785 Series) rail-mount terminal blocks			
Suitable for:	Color	Item No.	Pack. Unit
285-635	gray	283-407	25



Protective warning marker, with black high-voltage symbol, for 5 terminal blocks			
Color		Item No.	Pack. Unit
yellow		285-416	50 (25)



Finger guard, touch-proof cover protects unused conductor entries			
Color		Item No.	Pack. Unit
yellow		283-400	100 (25)

## Rail-Mount Terminal Blocks, Classic

### General Accessories



Collective carrier for adjacent jumpers, for DIN-35 rail, for 279 to 284 Series Adjacent Jumpers and 215 Series Banana Plugs		
Color	Item No.	Pack. Unit
gray	209-100	50 (25)



Collective jumper carrier, for DIN-35 rail, compatible with jumpers for transverse switching terminal block (282-811) and longitudinal switching disconnect terminal block (282-821)		
Color	Item No.	Pack. Unit
gray	282-369	25



Shorting link, (5 x 20) mm, allows the fuse plug to be used as a disconnect plug, I <sub>N</sub> 6.3 A		
	Item No.	Pack. Unit
	281-503	250 (25)

5



Wire commoning chain, insulated, 50 connections, I <sub>N</sub> 8 A		
Color	Item No.	Pack. Unit
black	210-103	5 (1)
blue	210-123	5 (1)



 Test plug adapters, see page 281

Power must be switched off when installing the test plug adapter. The safety rules for working on live installations must be observed.

Test plug adapter, 8.3 mm wide, for 4 mm Ø test plug, for 1.5 ... 10 mm <sup>2</sup> terminal blocks			
Suitable for:	Color	Item No.	Pack. Unit
279 Series	gray	209-170	50 (25)
280 Series			
880 Series			
281 Series			
282 Series			
284 Series			



Power must be switched off when installing the test plug adapter. The safety rules for working on live installations must be observed.

Test plug adapter, 5 mm wide, for 210-137 Test Plug (2.3 mm Ø), for 1.5 ... 4 mm <sup>2</sup> terminal blocks			
Suitable for:	Color	Item No.	Pack. Unit
279 Series	gray	280-404	100 (25)
280 Series			
880 Series			
281 Series			



Power must be switched off when installing the test plug adapter. The safety rules for working on live installations must be observed.

Test plug adapter, 6 mm wide, with CAGE CLAMP®, for 0.08 ... 2.5 mm <sup>2</sup> , I <sub>N</sub> 24 A			
Suitable for:	Color	Item No.	Pack. Unit
280 Series	gray	281-407	100 (25)
880 Series			
281 Series			

## Rail-Mount Terminal Blocks, TOPJOB® Classic

### General Accessories for Rail-Mount Installation Terminal Blocks

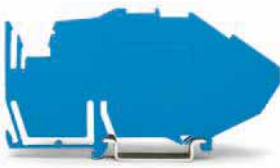

Busbar carrier, not suitable as an end stop, snaps onto DIN-35 rail, 1.5 mm thick			
Suitable for:	Color	Item No.	Pack. Unit
780 and 781 Series	blue	780-321	100 (25)



Busbar carrier, not suitable as an end stop, snaps onto DIN-35 rail, 1.5 mm thick			
Suitable for:	Color	Item No.	Pack. Unit
782 and 784 Series	blue	782-321	100 (25)



Busbar carrier, not suitable as an end stop, snaps onto DIN-35 rail, 1.5 mm thick			
Suitable for:	Color	Item No.	Pack. Unit
783 and 785 Series	blue	783-321	100 (25)



Busbar carrier, with end stop function and detachable separator plate, snaps onto DIN-35 rail, 8 mm thick			
Color		Item No.	Pack. Unit
blue		777-305	25



Busbar cover, 1000 mm long			
Color		Item No.	Pack. Unit
transparent		777-303	1



Straight busbar, tin-plated, 1000 mm long, copper (10 x 3) mm, I <sub>N</sub> 140 A			
		Item No.	Pack. Unit
		210-133	1



Connector, for busbar, with blue cover, 2.5 ... 16 mm <sup>2</sup>			
Color		Item No.	Pack. Unit
blue		210-281	100 (50)



Connector, for busbar, 2.5 ... 35 mm <sup>2</sup>			
Color		Item No.	Pack. Unit
unplated		209-105	50



Measurement range category	CAT I
Test voltage (AC)	30 V
Test voltage (DC)	60 V
Test current	10 A

Step-down test plug, from 4 mm socket to 2 mm plug			
Color		Item No.	Pack. Unit
red		210-297	100 (25)

## Rail-Mount Terminal Blocks, TOPJOB® , Classic

### General Accessories for Rail-Mount Installation Terminal Blocks



Lock-out, prevents reclosing of slide link, snap-on type			
Suitable for:	Color	Item No.	Pack. Unit
780 and 781 Series	orange	777-300	100 (25)



Lock-out, prevents reclosing of slide link, snap-on type			
Suitable for:	Color	Item No.	Pack. Unit
780 and 781 Series	orange	782-300	100 (25)



TOPJOB® Tool, specialty blade, compatible with all TOPJOB® Terminal Blocks			
		Item No.	Pack. Unit
		777-310	1

5



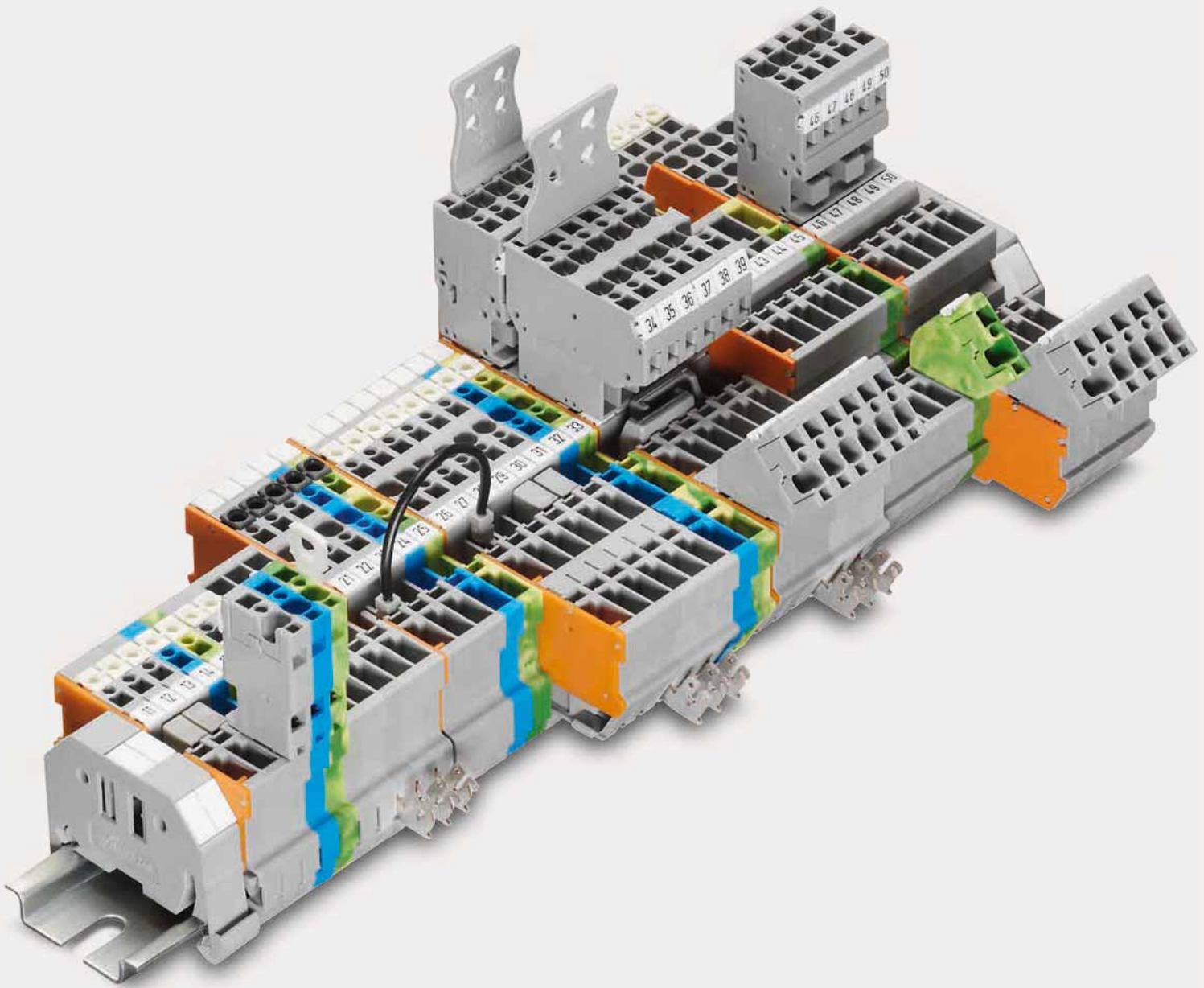

**Rail-Mount Terminal Blocks with a Pluggable Connector, X-COM<sup>®</sup>-SYSTEM, Classic**



## Rail-Mount Terminal Blocks with a Pluggable Connector, X-COM®-SYSTEM, Classic

### Front-Entry Wiring

			Page
	<b>Carrier Terminal Blocks</b> 0.08 ... 4 mm <sup>2</sup> (28 ... 12 AWG)	769 Series	470
	<b>Carrier Terminal Blocks with Three Jumper Positions</b> 0.08 ... 4 mm <sup>2</sup> (28 ... 12 AWG)	769 Series	479
	<b>Disconnect Carrier Terminal Blocks with Two Jumper Positions</b> 0.08 ... 4 mm <sup>2</sup> (28 ... 12 AWG)	769 Series	482
	<b>Diode and LED Carrier Terminal Blocks</b> 0.08 ... 4 mm <sup>2</sup> (28 ... 12 AWG)	769 Series	484
	<b>Carrier Terminal Blocks for Pluggable Modules</b> 0.08 ... 4 mm <sup>2</sup> (28 ... 12 AWG)	769 Series	492
	<b>Double-Deck Carrier Terminal Blocks</b> 0.08 ... 2.5 (4 "f-st") mm <sup>2</sup> (28 ... 12 AWG)	870 Series	498
	<b>Male Connectors with CAGE CLAMP® Connection</b> 0.08 ... 4 mm <sup>2</sup> (28 ... 12 AWG)	769 Series	508
	<b>Male Headers with Solder Pins</b> 0.08 ... 4 mm <sup>2</sup> (28 ... 12 AWG)	769 Series	512
	<b>Female Plugs with and without Lateral Locking Levers</b> 0.08 ... 4 mm <sup>2</sup> (28 ... 12 AWG)	769 Series	518
	<b>Female Plugs for Self-Assembly</b> 0.08 ... 4 mm <sup>2</sup> (28 ... 12 AWG)	769 Series	522
	<b>Pre-Assembled Female Plugs</b> 0.08 ... 4 mm <sup>2</sup> (28 ... 12 AWG)	769 Series	519
	<b>Strain Relief Housings</b>		524

## WAGO-X-COM®-SYSTEM COM-bining Connectors and Rail-Mount Terminal Blocks

The WAGO-X-COM®-SYSTEM is the perfect solution for switchgear and control applications.

X-COM® is designed for a **rated current up to 16/32 A at U<sub>N</sub> 500 V and 4 mm<sup>2</sup> (12 AWG) rated cross section (up to 600 V, 10 A, and 12 AWG UL)**. This offers an alternative to heavy-duty rectangular and circular connectors used in power wiring applications where electrical compliance is more important than a high degree of protection.

X-COM® conveniently enables the use of pre-assembled connector systems and offers the following advantages:

- During manufacturing: Pre-wired sub-assemblies can be tested before installation.
- During assembly: Pre-assembled pluggable cable harnesses help solve time and space issues on site. Connector systems with protection against mismatching can be handled by installers of all skill levels.
- During maintenance: Subassemblies can be replaced quickly and without errors.

The X-COM®-SYSTEM consists of rail-mount carrier terminal blocks, male connectors and female plugs with different mounting systems, as well as male headers with solder pins. Pin spacing is generally 5 mm (0.197 inch).

### Protection Against Mismatching and Accidental Contact

The WAGO-X-COM®-SYSTEM is **fully protected against accidental contact – even when plugs are disconnected**. This significantly simplifies the planning of power distribution.

Furthermore, the whole system is **100 % protected against mismatching**. Its coding, without the loss of any poles, prevents mismatching of male connectors and female plugs having the same number of poles.

### Carrier Terminal Blocks

Carrier terminal blocks are available as through terminal blocks, double-deck terminal blocks and ground conductor terminal blocks with automatic contact to the carrier rail.

Carrier terminal blocks with specialty functions are available in disconnect, diode and LED versions. Carrier terminal blocks equipped with an additional socket can accommodate a wide range of pluggable electronic modules (e.g., relays, optocouplers, signal conditioners). Depending on the type of terminal block, the carrier terminal blocks are equipped with one to three jumper positions for commoning signals via insulated push-in type jumpers.

### Applications

Equipment connection to the WAGO-X-COM®-SYSTEM for:

- Frequency converters
- Thyristor actuators
- Soft start motor controllers
- Motors
- Phase filters
- Power subassemblies
- Power supply units
- Uninterruptible power supply (UPS)
- "Panel-to-door" wiring
- Pluggable high-current, feed-through connections
- Flying leads

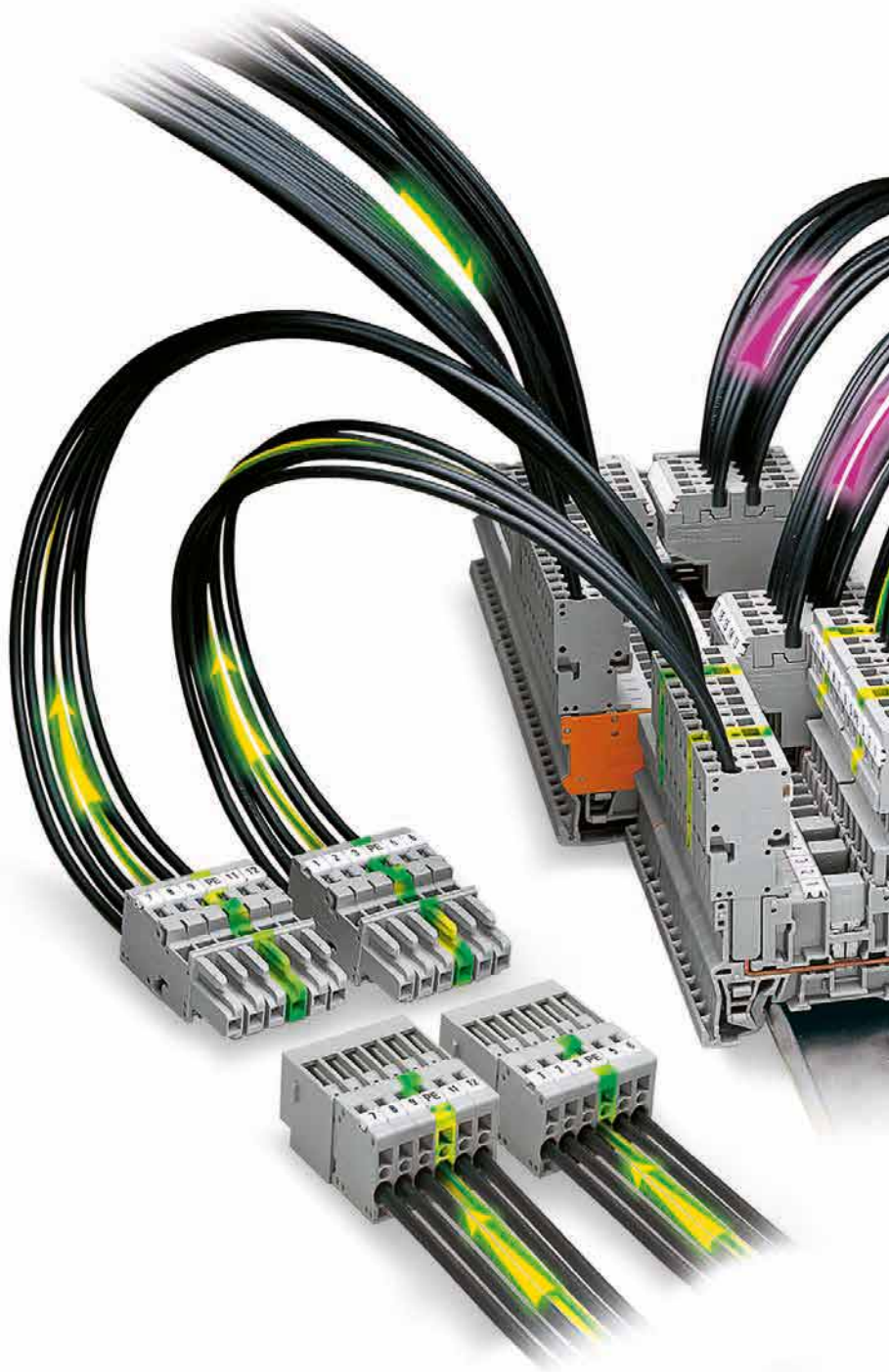

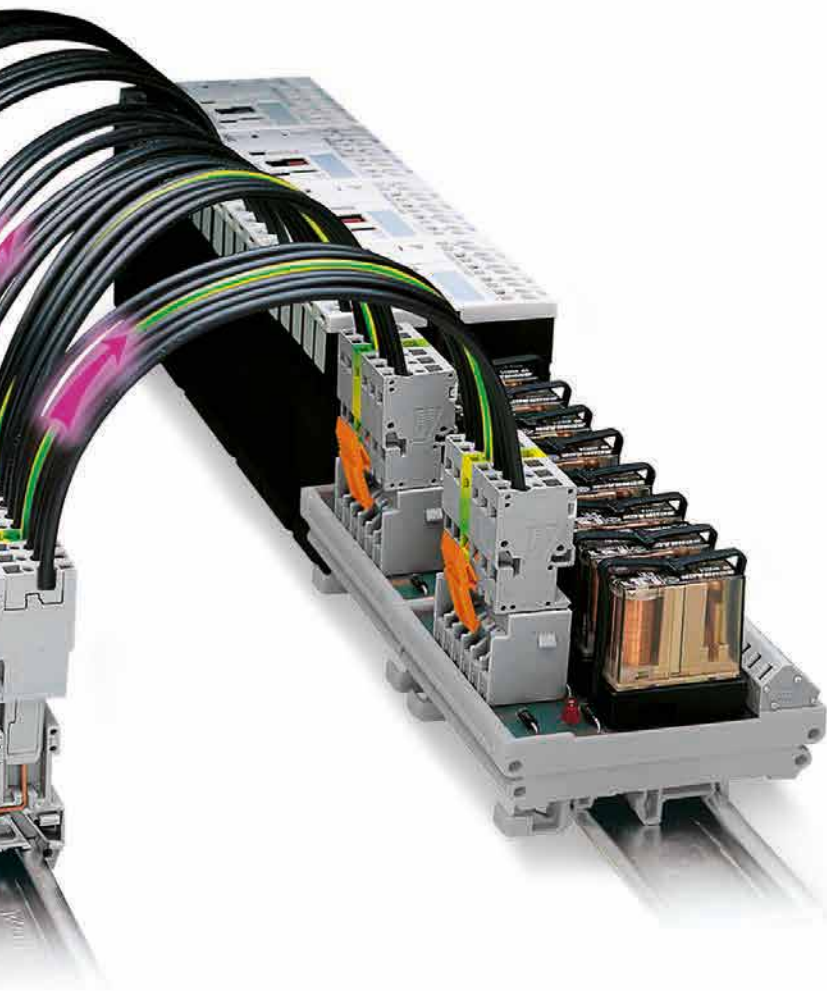

### Female Plugs

The mating half of the carrier terminal blocks consists of modular female plugs (1- to 15-pole, 1-/2-conductor, straight/angled). Angled female plugs combined with double-deck terminal blocks offer high-density wiring and reduce overall terminal block height. A jumper slot simplifies potential distribution. This makes commoning supply lines particularly easy as the power supply of downstream subassemblies is maintained even after female plugs have been removed.

### 1-Pole Female Plugs

Special 1-pole female plugs can carry the full rated current of the terminal blocks for many applications:

- as test plug adapters
- as connectors for motor lead tests
- for all types of patchboard applications
- for the creation of multipole prototypes
- for phase selection of 230 V loads in a three-phase network without interfering with the wiring
- for single-pole power supply in commercial or recreational vehicles. The grounding of all electrical components is connected through the chassis

### Male Connectors/Headers

Male connectors are available with snap-in mounting feet for panel mounting, with mounting flanges for feedthrough applications or without mounting elements for flying leads. Strain relief plates are available as accessories.

Subassemblies on printed circuit boards can be integrated into the system wiring using male headers with solder pins. As a result, parts can be exchanged quickly without wiring errors.

### Degree of Protection

Mated: IP20

Unmated: IP20

Temperature range:

-35 ... +100 °C



# X-COM®-SYSTEM

## Carrier Terminal Blocks and Female Plugs, 769 Series

### Description and Installation

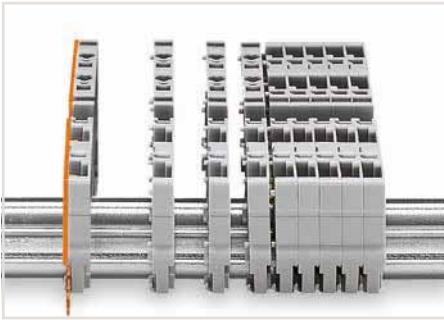

Snap individual carrier terminal blocks onto the carrier rail and slide together.



Open the assembly by laterally sliding a block via operating tool and remove terminal block via release lever.

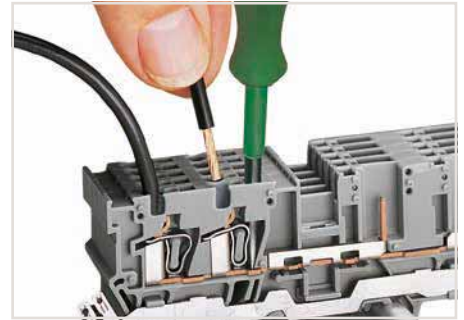

Carrier terminal block: Insert/remove conductor via operating tool (3.5 x 0.5 mm blade).



Coding a female plug by removing coding finger(s) via cutting tool. Do not remove the first and last coding fingers or use an additional locking lever.

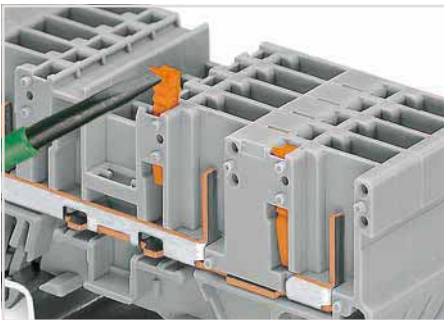

Snap coding pin in proper direction on carrier terminal block.  
Shown: Coding pin removal from carrier terminal block.

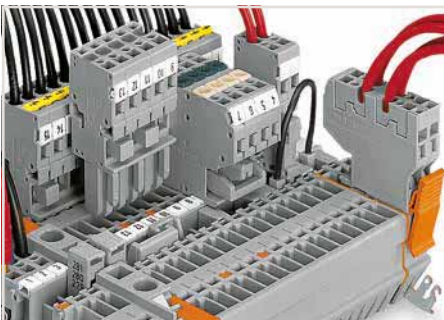
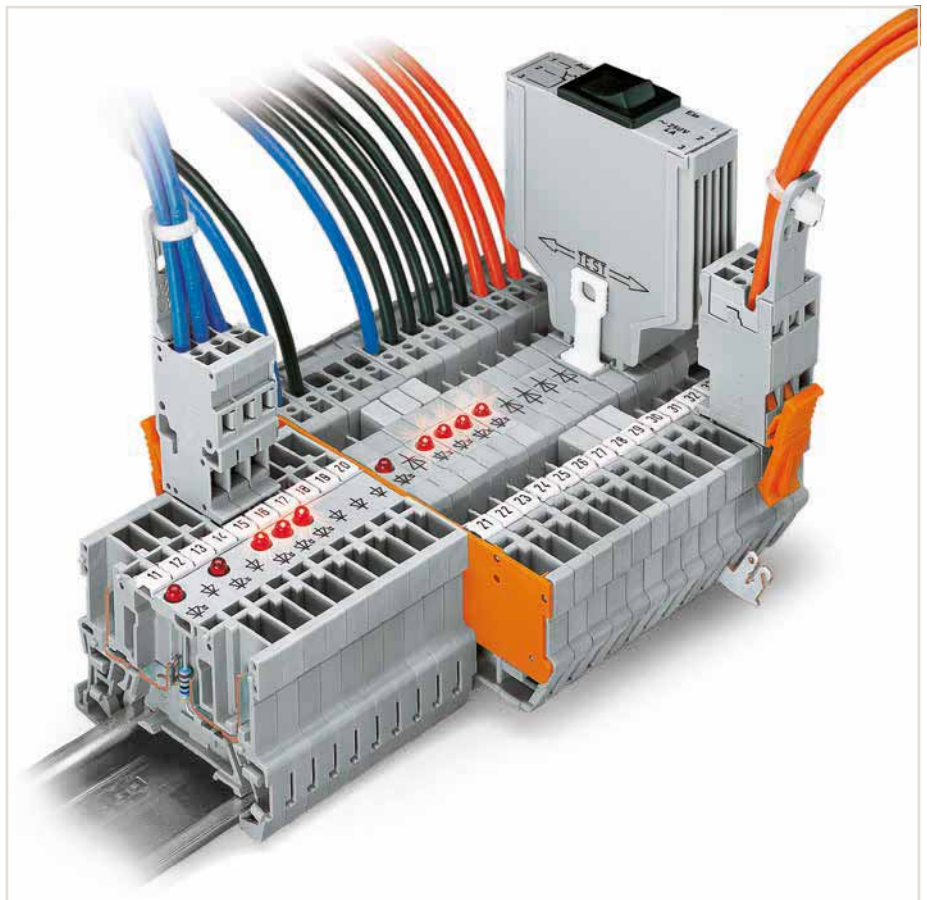

Commoning with adjacent or staggered jumpers – push jumpers down until fully inserted.

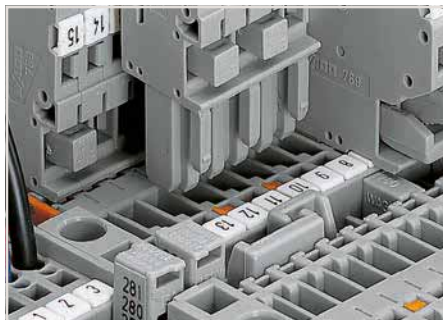

Commoning carrier terminal blocks via staggered jumpers.

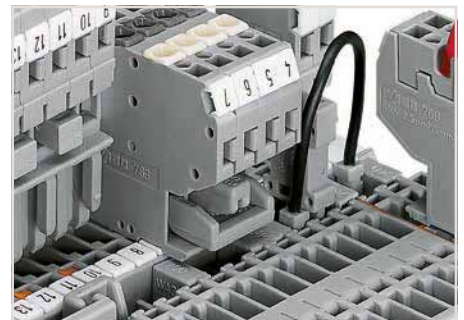

Commoning a 2-conductor female plug via staggered jumper and carrier terminal blocks via adjacent jumpers.

6



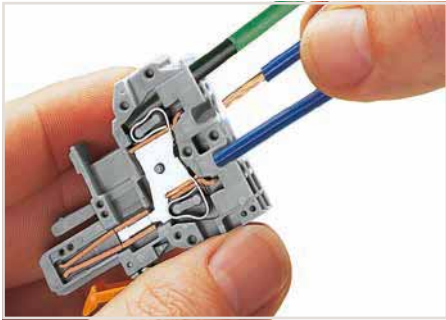

**CAGE CLAMP® connection**

Female plug: Inserting/removing a conductor via operating tool.  
 Operation 90° to conductor is also possible.  
 With ferruled conductors, it is necessary to use a terminal block one size smaller than the conductor's nominal cross section.



Testing via 2 or 2.3 mm Ø test plugs.

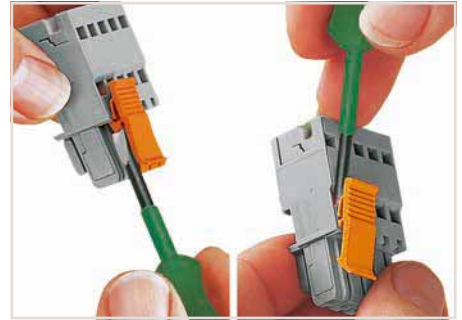

Locking/releasing a lever.

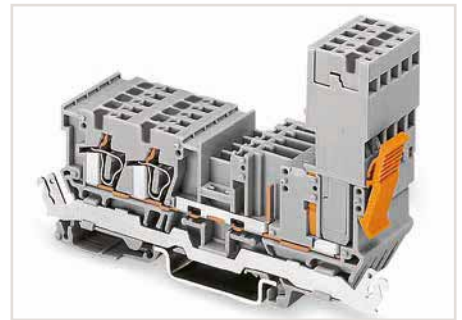
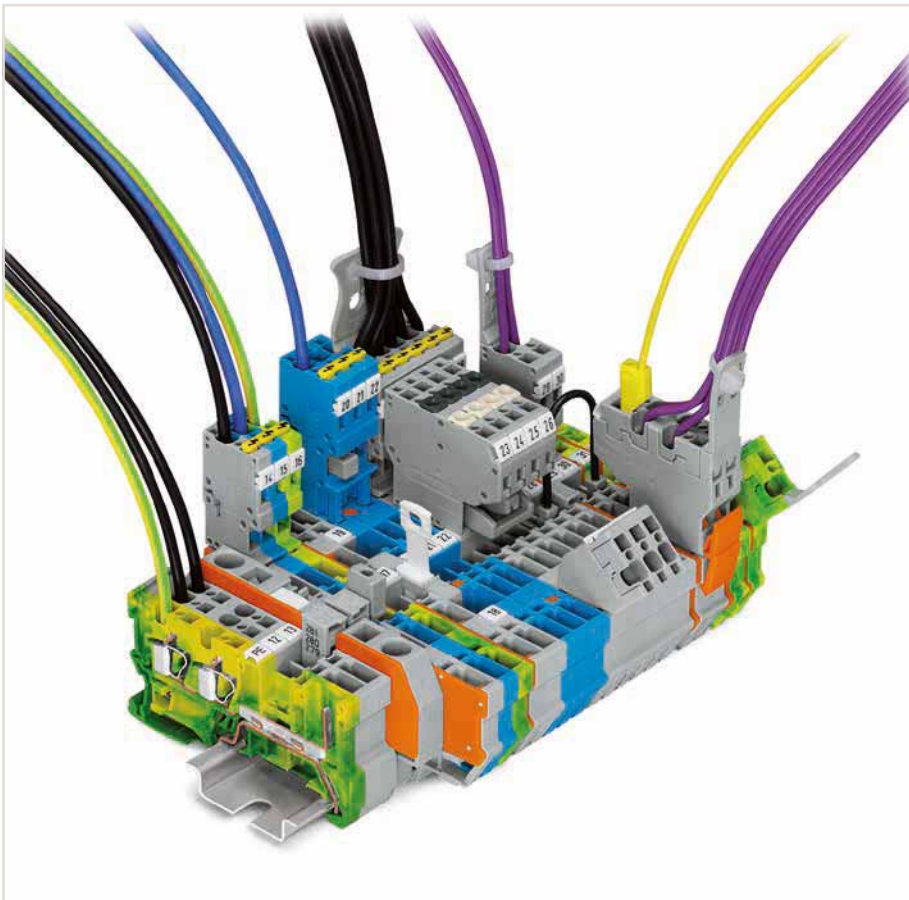

Female plug secured with locking lever on the terminal block side.



Removing a female plug via conductor bundle provided with strain relief plate.

Note: Female plugs used according to the regulations shall not be connected/disconnected when live or under load.

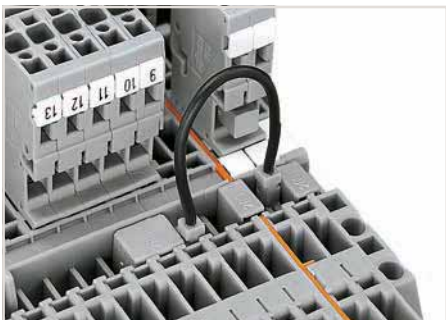

Commoning carrier terminal blocks via push-in type wire jumpers or adjacent jumpers – even over an intermediate plate.

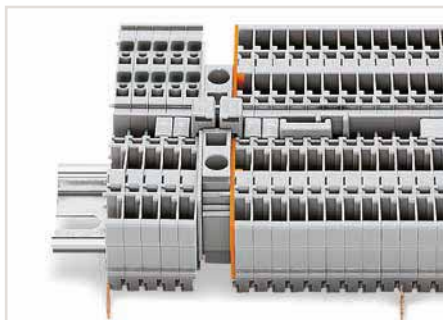

Commoning "supply terminal blocks" (up to 10 mm<sup>2</sup>/8 AWG) with carrier terminal blocks via step-down jumpers.

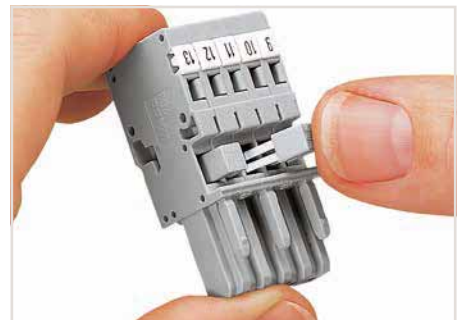

Commoning 1-conductor female plugs via miniature adjacent jumpers.

## X-COM®-SYSTEM

### 1-Conductor/1-Pin and 2-Pin Carrier Terminal Blocks

#### 4 mm<sup>2</sup>, 769 Series



1-conductor/1-pin carrier terminal block  
1-conductor female plug, straight\*  
\*1-conductor angled female plug is also possible!

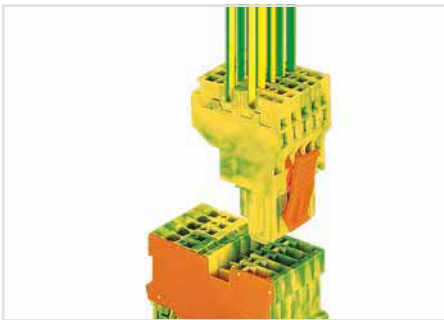

1-conductor/1-pin ground carrier terminal block  
2-conductor female plug, green-yellow

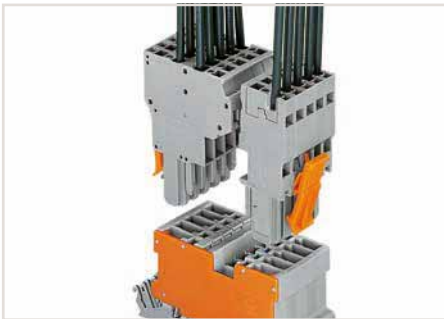

2-pin carrier terminal block with shield contact  
2-conductor female plug  
1-conductor female plug, straight\*  
\*1-conductor angled female plug is also possible!

250 V / 4 kV / 3 = Nominal voltage with shield contact  
Current-carrying capacity curve, visit [www.wago.com](http://www.wago.com)

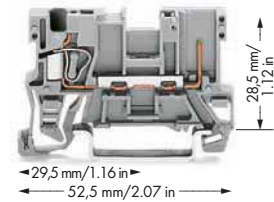

1-conductor/1-pin carrier terminal block, for DIN-35 rail, per EN 60715

Color	Item No.	Pack. Unit
gray	769-176	100
blue	769-176/000-006	100

1-conductor/1-pin carrier terminal block with shield contact, for DIN-35 rail, per EN 60715

Color	Item No.	Pack. Unit
gray	769-231	50

UL®

#### Technical Data

Ratings per	IEC/EN 60947-7-1
Rated voltage (III / 3)	500 V
Rated surge voltage (III / 3)	6 kV
Rated current	32 A
Approval	300 V, 20 A <b>UL</b> ; 300 V, 20 A <b>CE</b>
Nominal cross section	4 mm <sup>2</sup>
<b>Connection Data</b>	
Solid conductor	0.08 ... 4 mm <sup>2</sup> / 28 ... 12 AWG
Fine-stranded conductor	0.08 ... 4 mm <sup>2</sup> / 28 ... 12 AWG
Strip length	8 ... 9 mm / 0.31 ... 0.35 inch
Terminal block width	5 mm / 0.197 inch
Insulation material	Polyamide 66 (PA 66)

#### Accessories (Selection)

	Item No.	Page
Adjacent jumper, insulated, I <sub>N</sub> = I <sub>N</sub> terminal block	gray 280-402	526
End and intermediate plate, 1.1 mm thick	orange 769-308	526
Mini-WSB Quick marking system, white, 10 strips with 10 markers per card, 5 mm wide markers	plain 248-501	781
1-conductor female plug, straight	gray 769-101	519
1-conductor female plug, angled	gray 769-101/022-000	521
2-conductor female plug	gray 769-121	521
Test plug adapter, 5 mm wide, for 210-137 Test Plug (2.3 mm Ø), for 1.5 ... 4 mm <sup>2</sup> terminal blocks	gray 280-404	528

6

Accessories (jumpers, end plates, test plugs, etc.), see page 526

Carrier rails and tools, see Section 13

Appropriate marking system: Mini-WSB/Mini-WSB Inline, see Full Line Catalog, Volume 6

Approvals and corresponding ratings, visit [www.wago.com](http://www.wago.com)



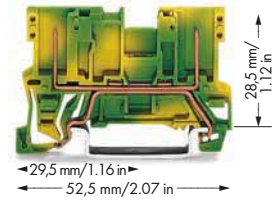
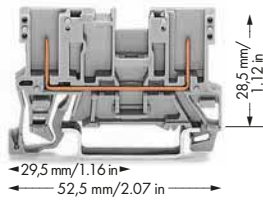
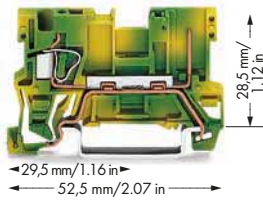

1-conductor/1-pin ground carrier terminal block, for DIN-35 rail, per EN 60715

Color	Item No.	Pack. Unit
● green-yellow	769-237	100

2-pin carrier terminal block, for DIN-35 rail, per EN 60715

Color	Item No.	Pack. Unit
● gray	769-156	100

2-pin ground carrier terminal block, for DIN-35 rail, per EN 60715

Color	Item No.	Pack. Unit
● green-yellow	769-227	100

2-pin carrier terminal block with shield contact, for DIN-35 rail, per EN 60715

Color	Item No.	Pack. Unit
● gray	769-221	50

**UL**

IEC/EN 60947-7-2
4 mm <sup>2</sup>
0.08 ... 4 mm <sup>2</sup> / 28 ... 12 AWG
0.08 ... 4 mm <sup>2</sup> / 28 ... 12 AWG
8 ... 9 mm / 0.31 ... 0.35 inch
5 mm / 0.197 inch
Polyamide 66 (PA 66)

**UL**

IEC/EN 60947-7-1
500 V
6 kV
32 A
300 V, 20 A <b>UL</b> ; 300 V, 20 A <b>UL</b>
5 mm / 0.197 inch
Polyamide 66 (PA 66)

**UL**

IEC/EN 60947-7-2
5 mm / 0.197 inch
Polyamide 66 (PA 66)

	Item No.	Page
gray	280-402	526
orange	769-308	526
plain	248-501	781
gray	769-101	519
gray	769-101/022-000	521
gray	769-121	521
gray	280-404	528

	Item No.	Page
gray	280-402	526
orange	769-306	526
plain	248-501	781
gray	769-101	519
gray	769-101/022-000	521
gray	769-121	521
gray	280-404	528

	Item No.	Page
gray	280-402	526
orange	769-306	526
plain	248-501	781
gray	769-101	519
gray	769-101/022-000	521
gray	769-121	521
gray	280-404	528

## X-COM®-SYSTEM

### 1-Conductor/1-Pin Carrier Terminal Blocks and 1-/2-Conductor Female Plugs Types of Assembly



1-conductor female plug  
Carrier terminal blocks can be commoned via 280 and 780 Series Jumpers and tested using a 280 Series Test Plug Adapter.

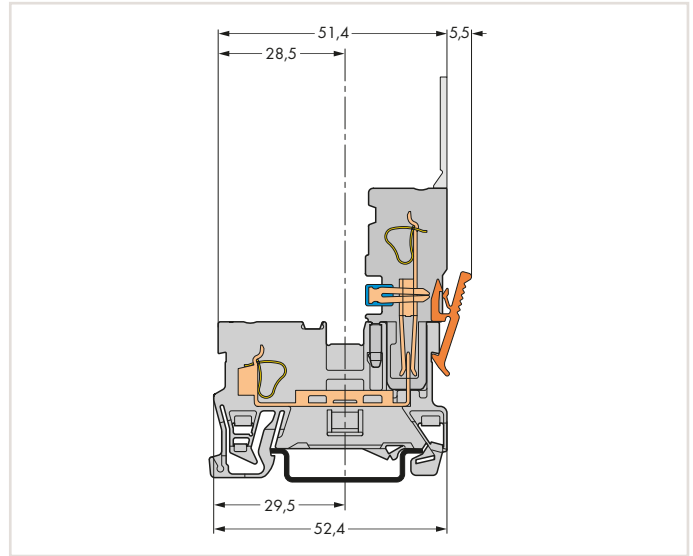

Carrier terminal block

6



2-conductor female plug  
Carrier terminal blocks can only be commoned via 280 Series Adjacent and Alternate Jumpers.

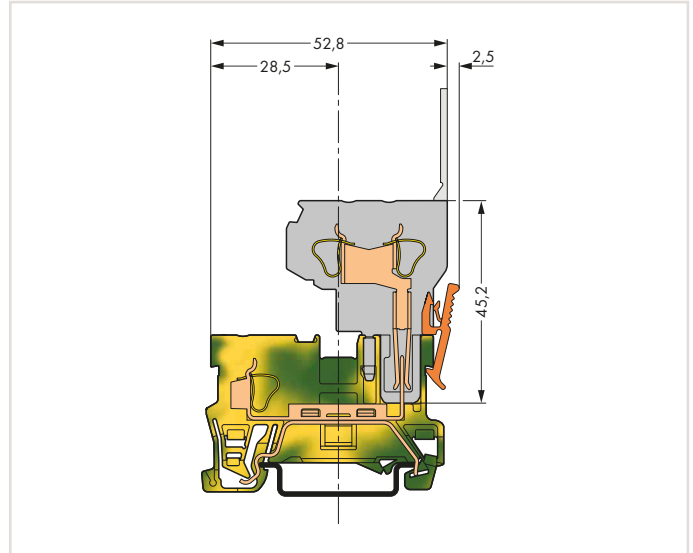

Ground carrier terminal block

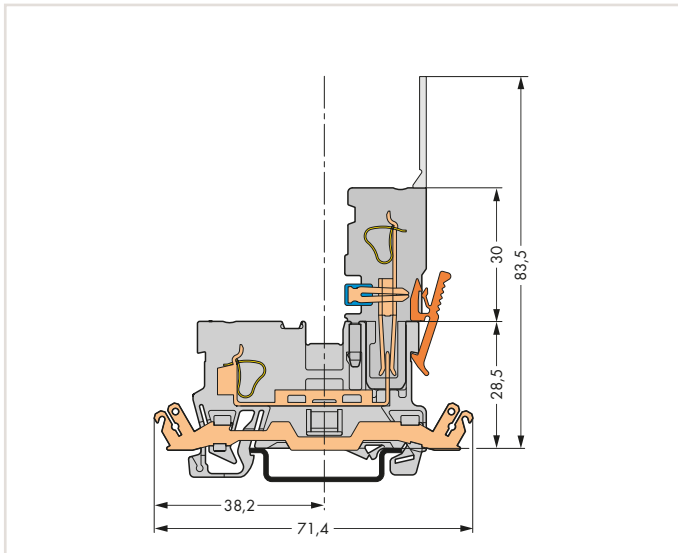

Carrier terminal block with shield contact

# X-COM®-SYSTEM

## 2-Pin Carrier Terminal Blocks and 1-/2-Conductor Female Plugs

### Types of Assembly



1-conductor female plugs  
Carrier terminal blocks can be commoned via 280 and 780 Series Jumpers and tested using a 280 Series Test Plug Adapter.

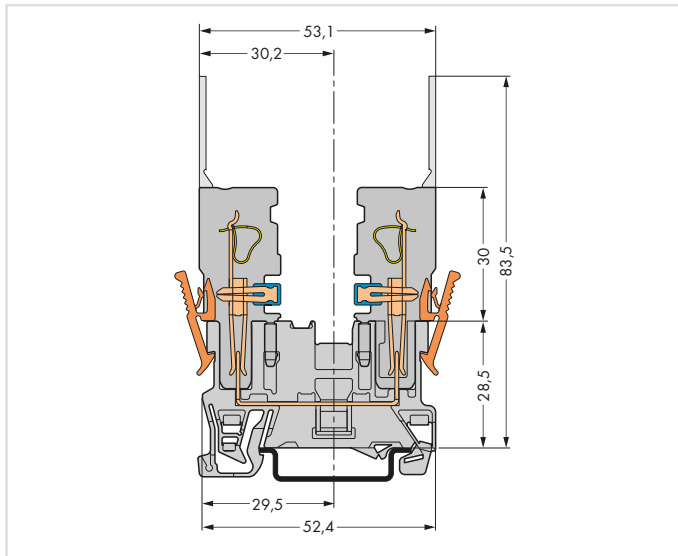

Carrier terminal block



1-conductor and 2-conductor female plugs  
Carrier terminal blocks can only be commoned via 280 Series Adjacent and Alternate Jumpers.

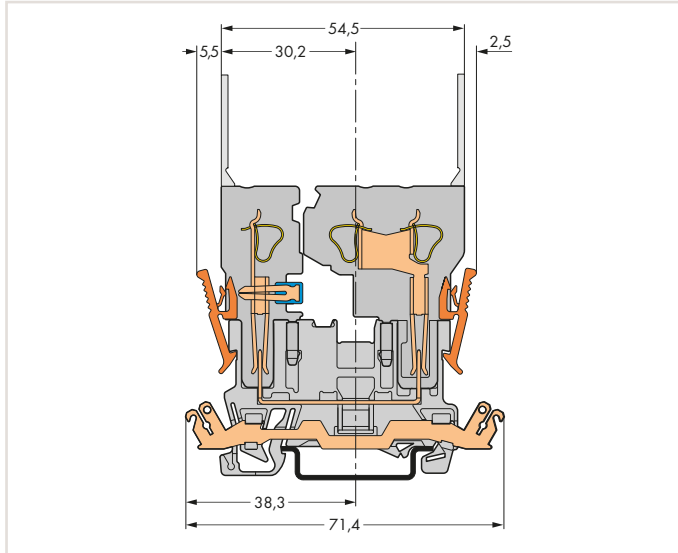

Carrier terminal block with shield contact



2-conductor and 1-conductor female plugs  
Carrier terminal blocks can be commoned via 280 and 780 Series Jumpers.

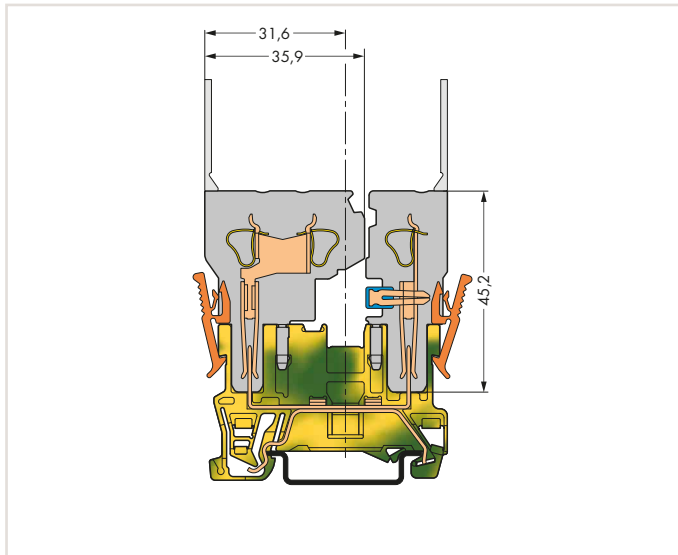

Ground carrier terminal block

## X-COM®-SYSTEM

### 2-Conductor/2-Pin and 4-Pin Carrier Terminal Blocks

#### 4 mm<sup>2</sup>, 769 Series

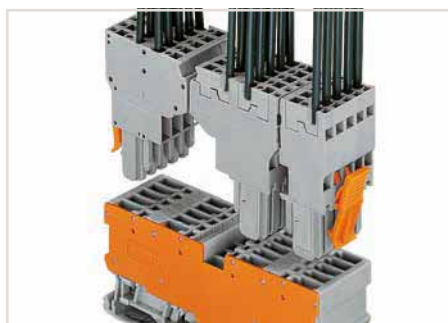

4-pin carrier terminal block  
2-conductor female plug  
1-conductor female plug, straight

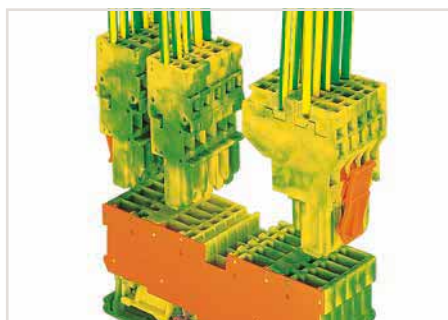

4-pin ground carrier terminal block  
1-conductor female plug, straight  
2-conductor female plug

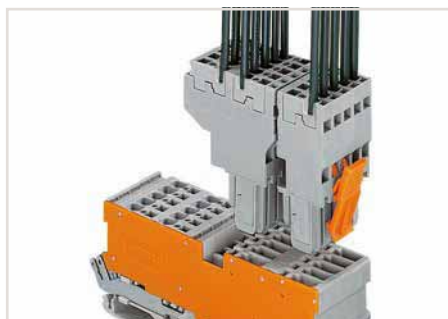

2-conductor/2-pin carrier terminal block with shield contact  
2-conductor female plug  
1-conductor female plug, straight

250 V / 4 kV / 3 = Nominal voltage with shield contact  
Current-carrying capacity curve, visit [www.wago.com](http://www.wago.com)

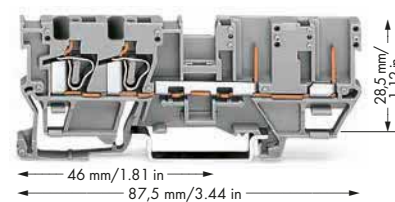

2-conductor/2-pin carrier terminal block, for DIN-35 rail, per EN 60715

Color	Item No.	Pack. Unit
gray	769-171	50
blue	769-171/000-006	50

2-conductor/2-pin carrier terminal block with shield contact, for DIN-35 rail, per EN 60715

Color	Item No.	Pack. Unit
gray	769-211	50

WAGO

#### Technical Data

Ratings per	IEC/EN 60947-7-1
Rated voltage (III / 3)	500 V
Rated surge voltage (III / 3)	6 kV
Rated current	32 A
Approval	300 V, 20 A <b>W</b> ; 300 V, 20 A <b>@</b>
Nominal cross section	4 mm <sup>2</sup>
<b>Connection Data</b>	
Solid conductor	0.08 ... 4 mm <sup>2</sup> / 28 ... 12 AWG
Fine-stranded conductor	0.08 ... 4 mm <sup>2</sup> / 28 ... 12 AWG
Strip length	8 ... 9 mm / 0.31 ... 0.35 inch
Terminal block width	5 mm / 0.197 inch
Insulation material	Polyamide 66 (PA 66)

#### Accessories (Selection)

	Item No.	Page
Adjacent jumper, insulated, I <sub>N</sub> = I <sub>N</sub> terminal block	gray 280-402	526
End and intermediate plate, 1.1 mm thick	orange 769-304	526
Mini-WSB Quick marking system, white, 10 strips with 10 markers per card, 5 mm wide markers	plain 248-501	781
1-conductor female plug, straight	gray 769-101	519
2-conductor female plug	gray 769-121	521
Test plug adapter, 5 mm wide, for 210-137 Test Plug (2.3 mm Ø), for 1.5 ... 4 mm <sup>2</sup> terminal blocks	gray 280-404	528

6

Accessories (jumpers, end plates, test plugs, etc.), see page 526

Carrier rails and tools, see Section 13

Appropriate marking system: Mini-WSB/Mini-WSB Inline, see Full Line Catalog, Volume 6

Approvals and corresponding ratings, visit [www.wago.com](http://www.wago.com)

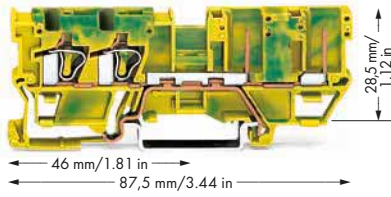

2-conductor/2-pin ground carrier terminal block, for DIN-35 rail, per EN 60715

Color	Item No.	Pack. Unit
● green-yellow	769-217	50

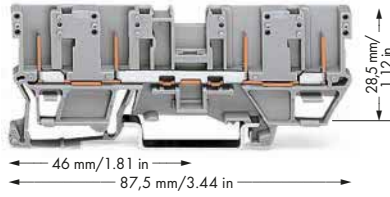

4-pin carrier terminal block, for DIN-35 rail, per EN 60715

Color	Item No.	Pack. Unit
● gray	769-151	50

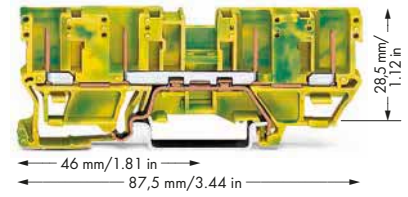

4-pin ground carrier terminal block, for DIN-35 rail, per EN 60715

Color	Item No.	Pack. Unit
● green-yellow	769-207	50

4-pin carrier terminal block with shield contact, for DIN-35 rail, per EN 60715

Color	Item No.	Pack. Unit
● gray	769-201	50



IEC/EN 60947-7-2
4 mm <sup>2</sup>
0.08 ... 4 mm <sup>2</sup> / 28 ... 12 AWG
0.08 ... 4 mm <sup>2</sup> / 28 ... 12 AWG
8 ... 9 mm / 0.31 ... 0.35 inch
5 mm / 0.197 inch
Polyamide 66 (PA 66)

	Item No.	Page
gray	280-402	526
orange	769-304	526
plain	248-501	781
gray	769-101	519
gray	769-121	521
gray	280-404	528



IEC/EN 60947-7-1
500 V
6 kV
32 A
300 V, 20 A ; 300 V, 20 A
5 mm / 0.197 inch
Polyamide 66 (PA 66)

	Item No.	Page
gray	280-402	526
orange	769-302	526
plain	248-501	781
gray	769-101	519
gray	769-121	521
gray	280-404	528



IEC/EN 60947-7-2
5 mm / 0.197 inch
Polyamide 66 (PA 66)

	Item No.	Page
gray	280-402	526
orange	769-302	526
plain	248-501	781
gray	769-101	519
gray	769-121	521
gray	280-404	528



## X-COM®-SYSTEM

### 2-Conductor/2-Pin Carrier Terminal Blocks and 1-/2-Conductor Female Plugs Types of Assembly

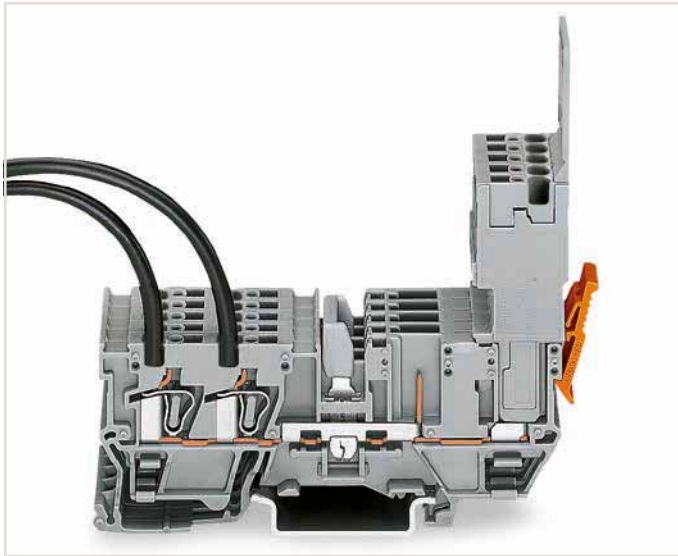

1-conductor female plug  
Carrier terminal blocks can be commoned via 280 and 780 Series Jumpers and tested using a 280 Series Test Plug Adapter.

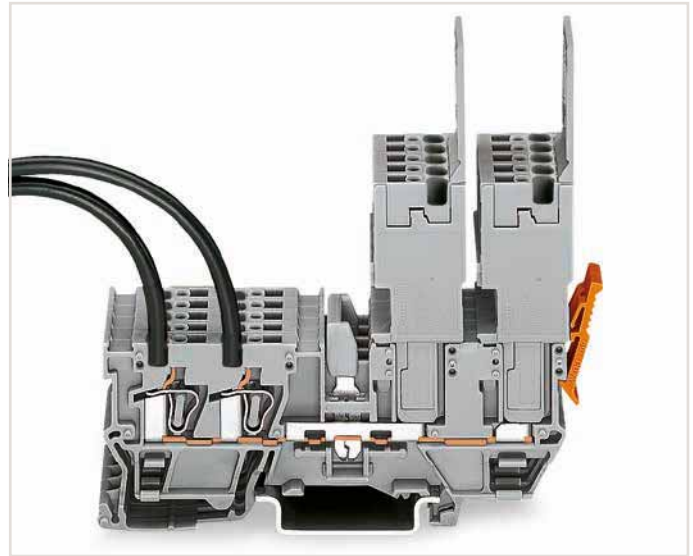

2 x 1-conductor female plugs  
Carrier terminal blocks can be commoned via 280 and 780 Series Jumpers and tested using a 280 Series Test Plug Adapter.

6

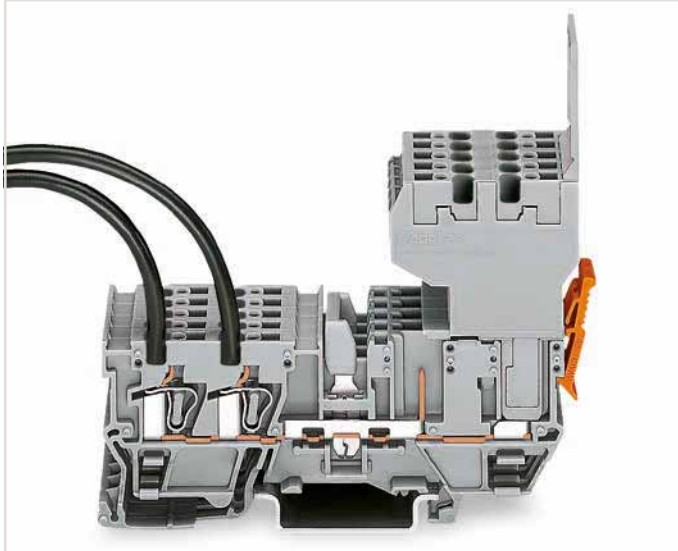

2-conductor female plug  
Carrier terminal blocks can be commoned via 280 and 780 Series Jumpers and tested using a 280 Series Test Plug Adapter.

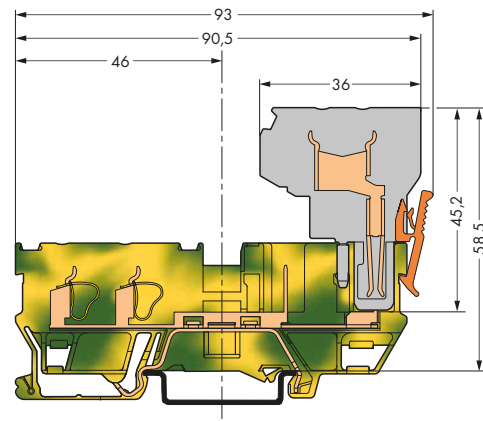

1-conductor and 2-conductor female plugs  
Carrier terminal blocks can only be commoned via 280 Series Adjacent and Alternate Jumpers.

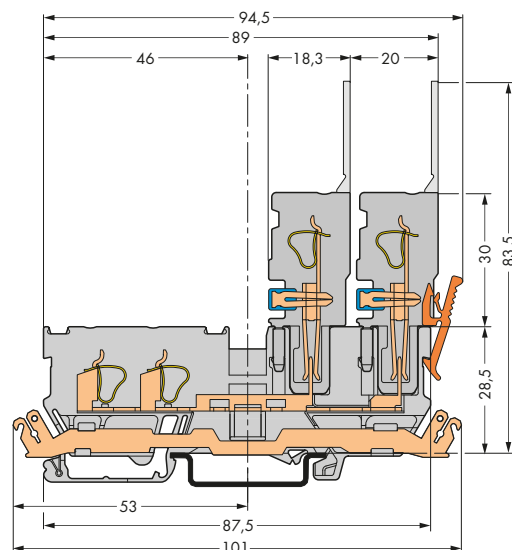

Ground carrier terminal block  
Carrier terminal block with shield contact



# X-COM®-SYSTEM

## 4-Pin Carrier Terminal Blocks and 1-/2-Conductor Female Plugs

### Types of Assembly



4 x 1-conductor female plugs  
Carrier terminal blocks can be commoned via 280 and 780 Series Jumpers and tested using a 280 Series Test Plug Adapter.



2 x 2-conductor female plugs  
Carrier terminal blocks can be commoned via 280 and 780 Series Jumpers and tested using a 280 Series Test Plug Adapter.



2 x 1-conductor female plug (left), 1 x 2-conductor female plug (right), may be reversed – carrier terminal blocks can be commoned via 280 and 780 Series Jumpers and tested using a 280 Series Test Plug Adapter.

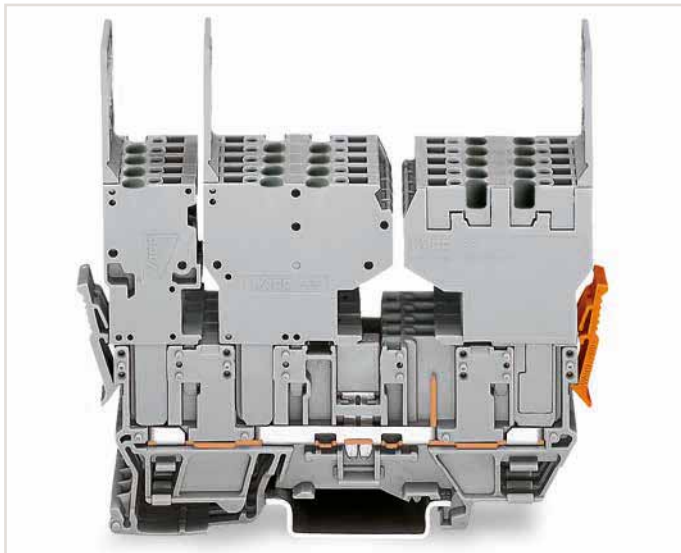
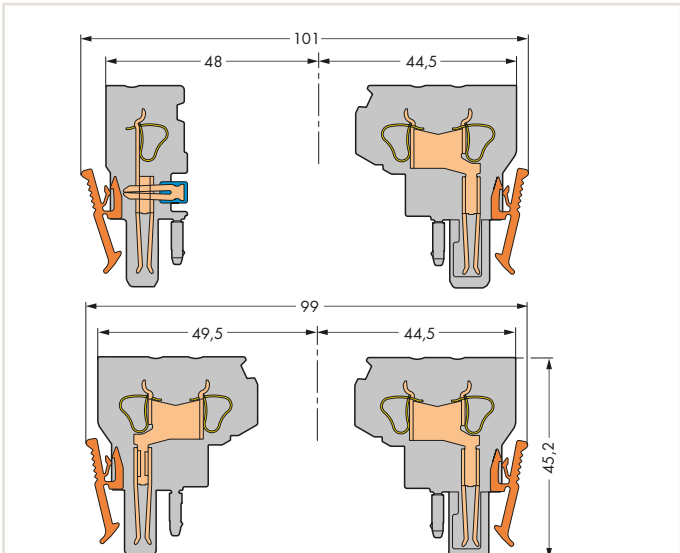

1-conductor and 2-conductor female plugs (left), 2-conductor female plug (right), may be reversed – carrier terminal blocks can only be commoned via 280 Series Adjacent and Alternate Jumpers.

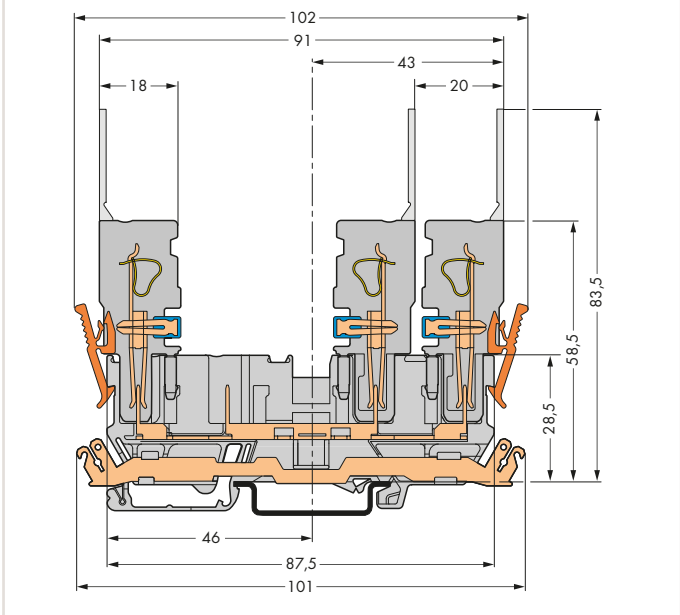

Carrier terminal block with shield contact

## X-COM®-SYSTEM – 2-Conductor/1-Pin and 1-Conductor/1-Pin Carrier Terminal Blocks with Three Jumper Positions

### 4 mm<sup>2</sup>, 769 Series

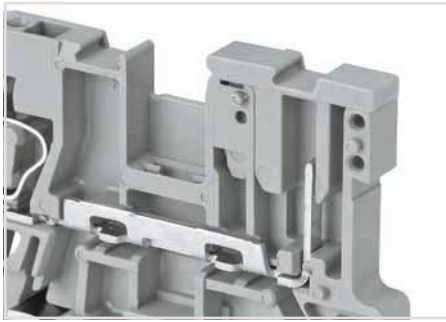

Pin cover with Mini-WSB marker slot

Current-carrying capacity curve, visit [www.wago.com](http://www.wago.com)

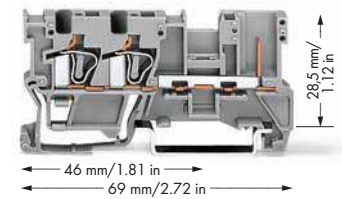

2-conductor/1-pin carrier terminal block, for DIN-35 rail, per EN 60715

Color	Item No.	Pack. Unit
● gray	769-251	50
● blue	769-251/000-006	50

**WAGO**

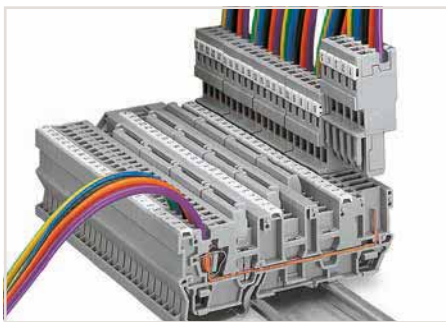

1-conductor/1-pin carrier terminal block with three jumper positions  
 1-connector female plug, straight\*  
 \*1-conductor angled female plug is also possible!

#### Technical Data

Ratings per	IEC/EN 60947-7-1
Rated voltage (III / 3)	500 V
Rated surge voltage (III / 3)	6 kV
Rated current	32 A
Approval	300 V, 20 A <b>W</b> ; 300 V, 20 A <b>CE</b>
Nominal cross section	4 mm <sup>2</sup>

#### Connection Data

Solid conductor	0.08 ... 4 mm <sup>2</sup> / 28 ... 12 AWG
Fine-stranded conductor	0.08 ... 4 mm <sup>2</sup> / 28 ... 12 AWG
Strip length	8 ... 9 mm / 0.31 ... 0.35 inch
Terminal block width	5 mm / 0.197 inch
Insulation material	Polyamide 66 (PA 66)

#### Accessories (Selection)

	Item No.	Page
Adjacent jumper, insulated, I <sub>N</sub> = I <sub>N</sub> terminal block	gray 280-402	526
End and intermediate plate, 1.1 mm thick	orange 769-321	527
Mini-WSB Quick marking system, white, 10 strips with 10 markers per card, 5 mm wide markers	plain 248-501	781
1-connector female plug, straight	gray 769-101	519
1-conductor female plug, angled	gray 769-101/022-000	521
2-conductor female plug	gray 769-121	521
Test plug adapter, 5 mm wide, for 210-137 Test Plug (2.3 mm Ø), for 1.5 ... 4 mm <sup>2</sup> terminal blocks	gray 280-404	528

Accessories (jumpers, end plates, test plugs, etc.), see page 526

Carrier rails and tools, see Section 13

Appropriate marking system: Mini-WSB/Mini-WSB Inline, see Full Line Catalog, Volume 6

Approvals and corresponding ratings, visit [www.wago.com](http://www.wago.com)

6

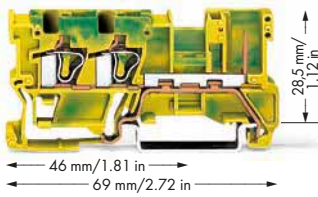

2-conductor/1-pin ground carrier terminal block, for DIN-35 rail, per EN 60715

Color	Item No.	Pack. Unit
● green-yellow	769-257	50

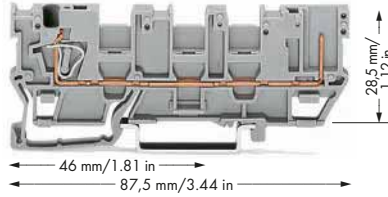

2-conductor/1-pin carrier terminal block with three jumper positions, for DIN-35 rail, per EN 60715

Color	Item No.	Pack. Unit
● gray	769-214	50



IEC/EN 60947-7-2

4 mm<sup>2</sup>

0.08 ... 4 mm<sup>2</sup> / 28 ... 12 AWG

0.08 ... 4 mm<sup>2</sup> / 28 ... 12 AWG

8 ... 9 mm / 0.31 ... 0.35 inch

5 mm / 0.197 inch

Polyamide 66 (PA 66)

	Item No.	Page
gray	280-402	526
orange	769-321	527
plain	248-501	781
gray	769-101	519
gray	769-101/022-000	521
gray	769-121	521
gray	280-404	528



IEC/EN 60947-7-1

500 V

6 kV

32 A

300 V, 20 A ; 300 V, 20 A

4 mm<sup>2</sup>

0.08 ... 4 mm<sup>2</sup> / 28 ... 12 AWG

0.08 ... 4 mm<sup>2</sup> / 28 ... 12 AWG

8 ... 9 mm / 0.31 ... 0.35 inch

5 mm / 0.197 inch

Polyamide 66 (PA 66)

	Item No.	Page
gray	280-402	526
orange	769-316	527
plain	248-501	781
gray	769-101	519
gray	769-101/022-000	521
gray	769-121	521
gray	280-404	528

## X-COM®-SYSTEM

### 2-Conductor/1-Pin Carrier Terminal Blocks and 1-/2-Conductor Female Plugs Types of Assembly



1-conductor female plug

Carrier terminal blocks can be commoned via 280 and 780 Series Jumpers and tested using a 280 Series Test Plug Adapter.

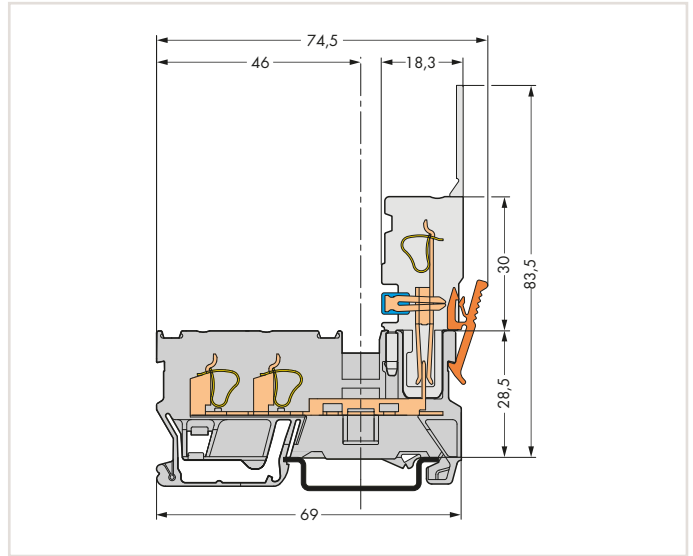

Carrier terminal block

6

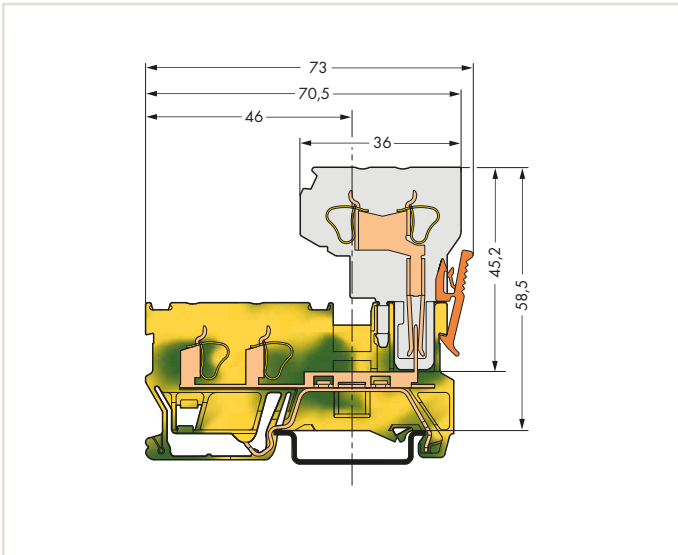

Ground carrier terminal block

# X-COM®-SYSTEM

## 2-Pin Carrier Terminal Blocks and 1-/2-Conductor Female Plugs

### Types of Assembly

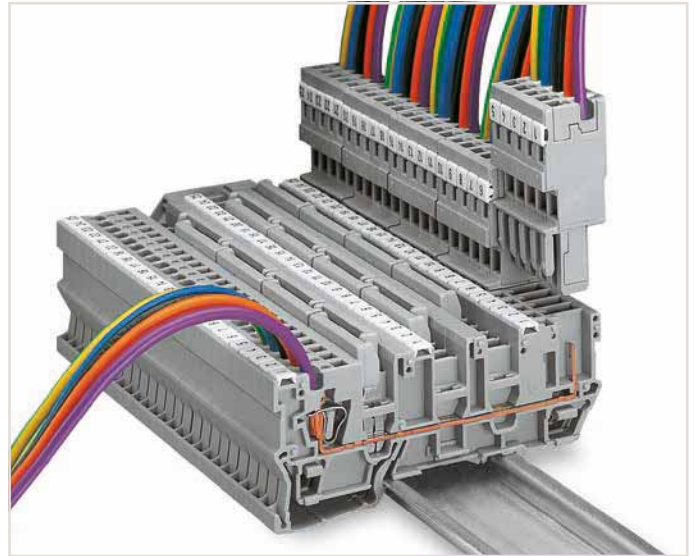
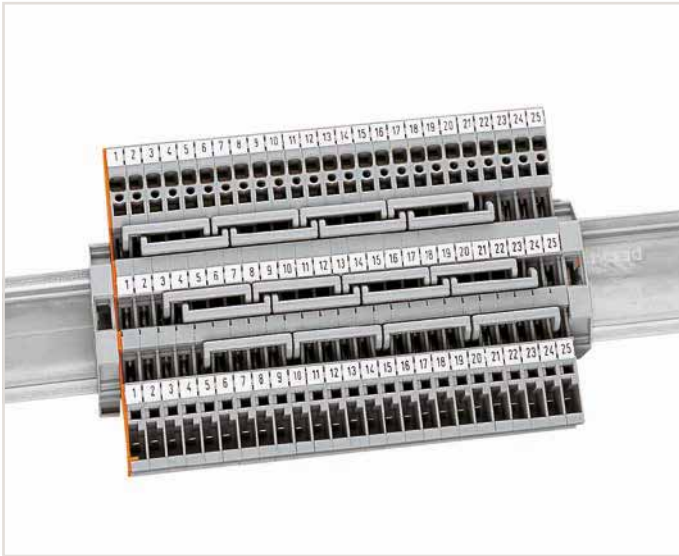

1-conductor/1-pin carrier terminal blocks with three jumper positions  
The three jumper positions allow up to six commoning options for staggered jumpers.

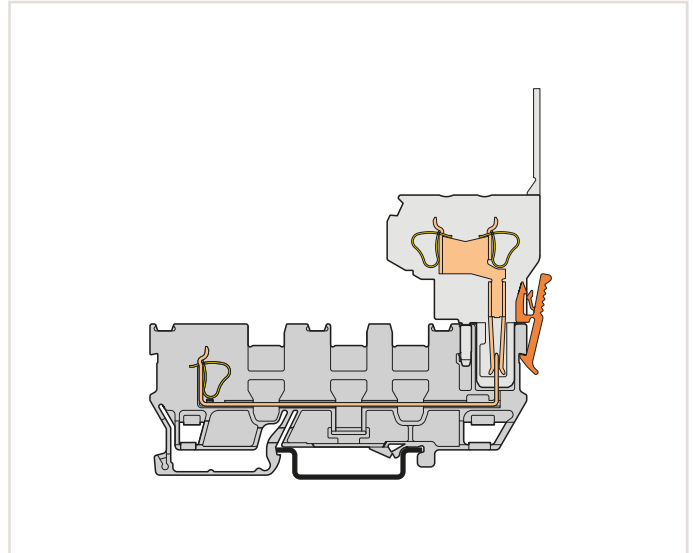
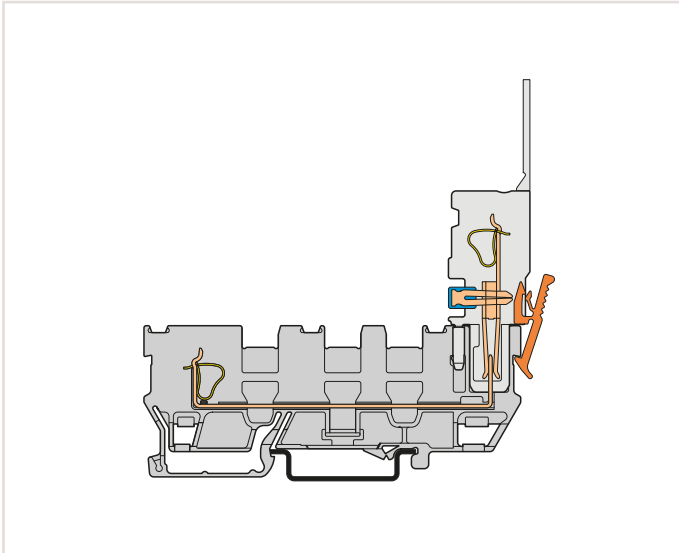

Carrier terminal block  
For dimensions, see 769-171 Carrier Terminal Block.

Carrier terminal block  
For dimensions, see 769-171 Carrier Terminal Block.

6

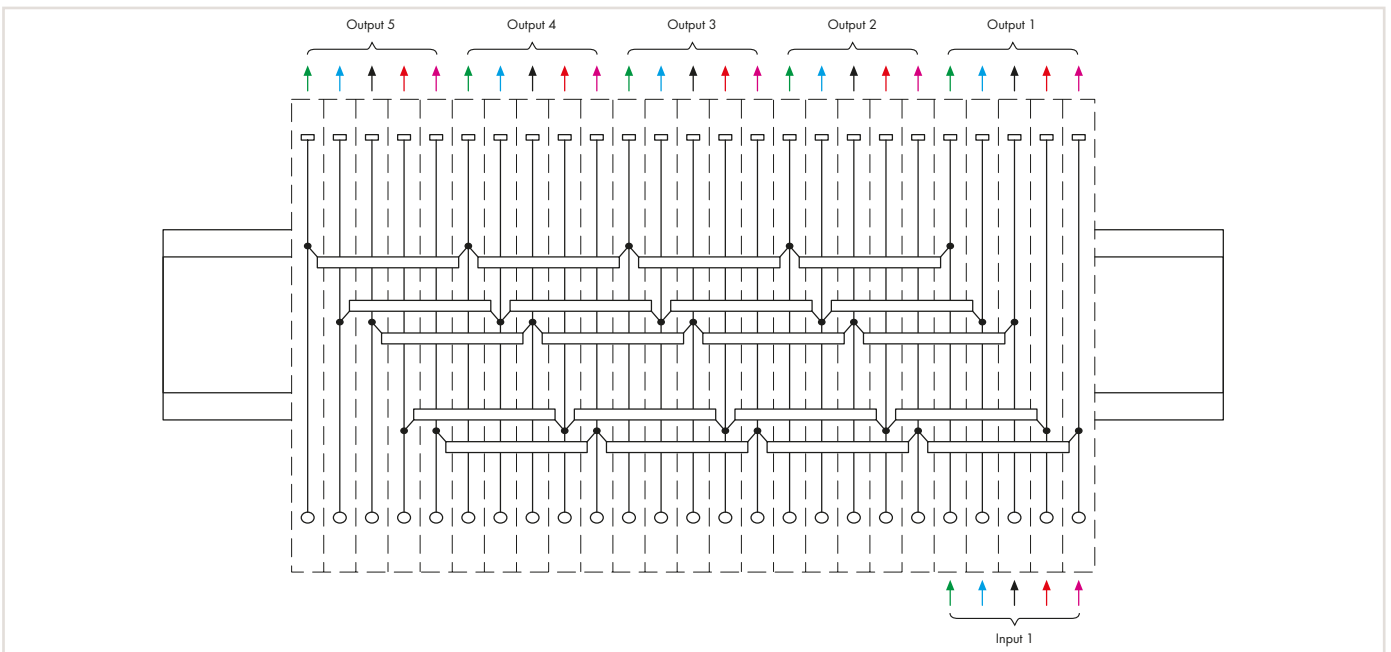



## X-COM®-SYSTEM

## 1-Conductor/1-Pin and 2-Pin Disconnect Carrier Terminal Blocks

4 mm<sup>2</sup>, 769 Series

1-conductor/1-pin disconnect carrier terminal block  
1-conductor female plug, straight\*  
\*1-conductor angled female plug is also possible!

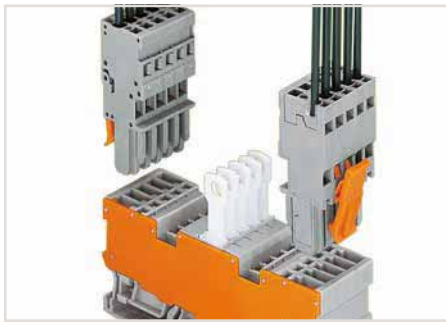

2-pin disconnect carrier terminal block with two  
jumper positions  
1-conductor female plug, straight\*  
\*1-conductor angled female plug is also possible!

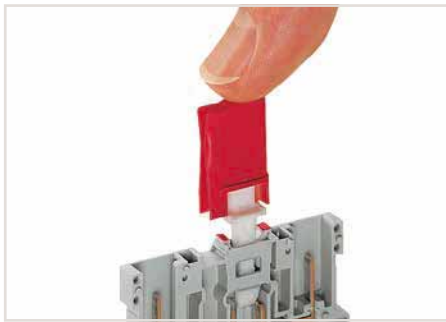

Installing a disconnect lock on the terminal block's  
disconnect tab.

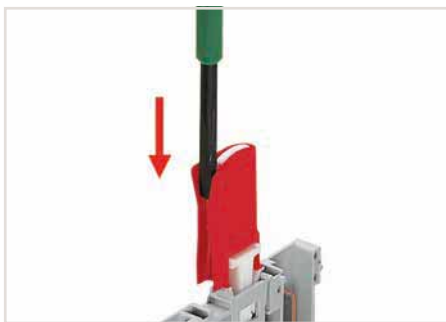

Unlocking and removing a disconnect lock.

250 V / 4 kV / 3 = Nominal voltage with  
shield contact

16 A, 85 °C upper-temperature limit (see  
current-carrying capacity curve at [www.wago.com](http://www.wago.com))

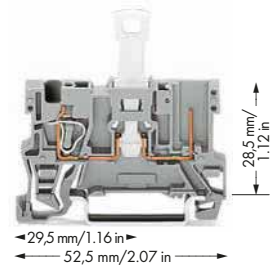

1-conductor/1-pin disconnect carrier terminal  
block, for DIN-35 rail, per EN 60715

Color	Item No.	Pack. Unit
○ gray	769-232	50

1-conductor/1-pin disconnect carrier terminal  
block with shield contact, for DIN-35 rail, per EN  
60715

Color	Item No.	Pack. Unit
○ gray	769-233	50

WAGO

#### Technical Data

Rated voltage (III / 3)	400 V
Rated surge voltage (III / 3)	6 kV
Rated current	16 A
Approval	300 V, 20 A ; 300 V, 20 A
Nominal cross section	4 mm <sup>2</sup>
<b>Connection Data</b>	
Solid conductor	0.08 ... 4 mm <sup>2</sup> / 28 ... 12 AWG
Fine-stranded conductor	0.08 ... 4 mm <sup>2</sup> / 28 ... 12 AWG
Strip length	8 ... 9 mm / 0.31 ... 0.35 inch
Terminal block width	5 mm / 0.197 inch
Insulation material	Polyamide 66 (PA 66)

#### Accessories (Selection)

Adjacent jumper, insulated, I <sub>N</sub> = I <sub>N</sub> terminal block
End and intermediate plate, 1.1 mm thick
Mini-WSB Quick marking system, white, 10 strips with 10 markers per card, 5 mm wide markers
1-conductor female plug, straight
1-conductor female plug, angled
2-conductor female plug
Test plug adapter, 5 mm wide, for 210-137 Test Plug (2.3 mm Ø), for 1.5 ... 4 mm <sup>2</sup> terminal blocks
Disconnect lock, for disconnect tab used on disconnect terminal blocks (280/281 and 769 Series)

	Item No.	Page
orange	769-308	526
plain	248-501	781
gray	769-101	519
gray	769-101/022-000	521
red	709-170	528

Accessories (jumpers, end plates, test plugs, etc.), see page 526

Carrier rails and tools, see Section 13

Appropriate marking system: Mini-WSB/Mini-WSB Inline, see Full Line Catalog, Volume 6

Approvals and corresponding ratings, visit [www.wago.com](http://www.wago.com)

6



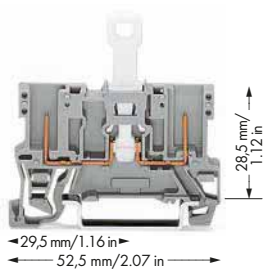

2-pin disconnect carrier terminal block, for DIN-35 rail, per EN 60715

Color	Item No.	Pack. Unit
○ gray	769-222	50

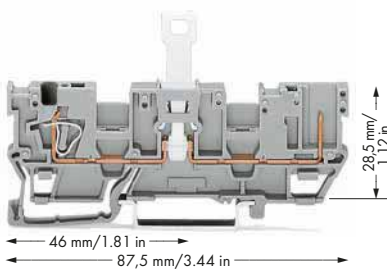

1-conductor/1-pin disconnect carrier terminal block with two jumper positions, for DIN-35 rail, per EN 60715

Color	Item No.	Pack. Unit
○ gray	769-212	50

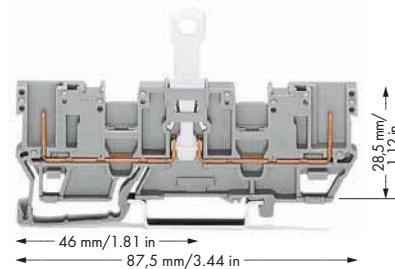

2-pin disconnect carrier terminal block with two jumper positions, for DIN-35 rail, per EN 60715

Color	Item No.	Pack. Unit
○ gray	769-202	50

2-pin disconnect carrier terminal block with shield contact, for DIN-35 rail, per EN 60715

Color	Item No.	Pack. Unit
○ gray	769-223	50

1-conductor/1-pin disconnect carrier terminal block with two jumper positions and shield contact, for DIN-35 rail, per EN 60715

Color	Item No.	Pack. Unit
○ gray	769-213	50

2-pin disconnect carrier terminal block with two jumper positions and shield contact, for DIN-35 rail, per EN 60715

Color	Item No.	Pack. Unit
○ gray	769-203	50



400 V  
6 kV  
16 A  
300 V, 20 A **UL**; 300 V, 20 A **CE**  
4 mm<sup>2</sup>



400 V  
6 kV  
16 A  
300 V, 20 A **UL**; 300 V, 20 A **CE**  
4 mm<sup>2</sup>



400 V  
6 kV  
16 A  
300 V, 20 A **UL**; 300 V, 20 A **CE**  
4 mm<sup>2</sup>

5 mm / 0.197 inch  
Polyamide 66 (PA 66)

5 mm / 0.197 inch  
Polyamide 66 (PA 66)

5 mm / 0.197 inch  
Polyamide 66 (PA 66)

	Item No.	Page
orange	769-306	526
plain	248-501	781
gray	769-101	519
gray	769-101/022-000	521
red	709-170	528

	Item No.	Page
gray	280-402	526
orange	769-312	527
plain	248-501	781
gray	769-101	519
gray	769-101/022-000	521
gray	769-121	521
gray	280-404	528
red	709-170	528

	Item No.	Page
gray	280-402	526
orange	769-310	527
plain	248-501	781
gray	769-101	519
gray	769-101/022-000	521
gray	769-121	521
gray	280-404	528
red	709-170	528

## X-COM®-SYSTEM

### 1-Conductor/1-Pin and 2-Pin Diode Carrier Terminal Blocks

#### 4 mm<sup>2</sup>, 769 Series



2-pin diode carrier block  
1-conductor female plug, straight\*

\*1-conductor angled female plug is also possible!

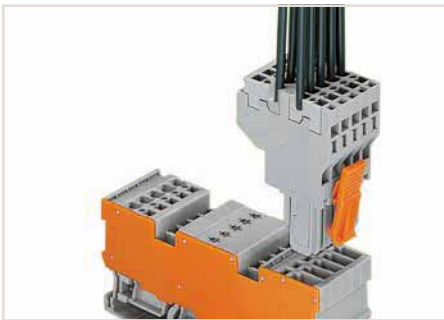

1-conductor/1-pin diode carrier terminal block with two jumper positions  
2-conductor female plug

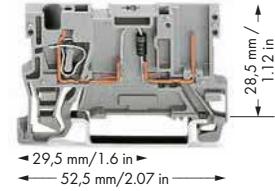

769-238/281-411

769-238/281-410

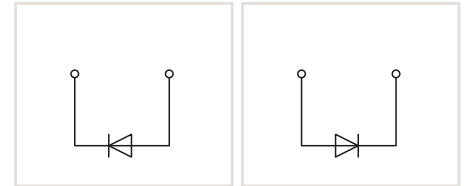

1-conductor/1-pin diode carrier terminal block, for DIN-35 rail, per EN 60715

	Item No.	Pack. Unit
○ Anode, right side	769-238/281-411	100
○ Anode, left side	769-238/281-410	100

#### Technical Data

Nominal voltage	250 V
Reverse voltage	1000 V
Rated current	0.5 A
Nominal cross section	4 mm <sup>2</sup>

#### Connection Data

Solid conductor	0.08 ... 4 mm <sup>2</sup> / 28 ... 12 AWG
Fine-stranded conductor	0.08 ... 4 mm <sup>2</sup> / 28 ... 12 AWG
Strip length	8 ... 9 mm / 0.31 ... 0.35 inch
Terminal block width	5 mm / 0.197 inch
Insulation material	Polyamide 66 (PA 66)

#### Accessories (Selection)

Adjacent jumper, insulated, I <sub>N</sub> = I <sub>N</sub> terminal block
End and intermediate plate, 1.1 mm thick
Mini-WSB Quick marking system, white, 10 strips with 10 markers per card, 5 mm wide markers
1-conductor female plug, straight
1-conductor female plug, angled
2-conductor female plug
Test plug adapter, 5 mm wide, for 210-137 Test Plug (2.3 mm Ø), for 1.5 ... 4 mm <sup>2</sup> terminal blocks

	Item No.	Page
orange	769-308	526
plain	248-501	781
gray	769-101	519
gray	769-101/022-000	521

Accessories (jumpers, end plates, test plugs, etc.), see page 526

Carrier rails and tools, see Section 13

Appropriate marking system: Mini-WSB/Mini-WSB Inline, see Full Line Catalog, Volume 6

Approvals and corresponding ratings, visit [www.wago.com](http://www.wago.com)

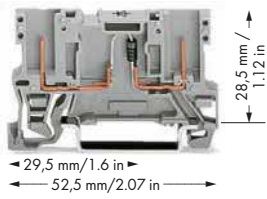

769-228/281-411      769-228/281-410

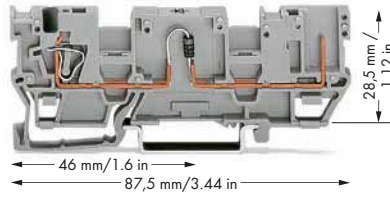

769-218/281-411      769-218/281-410

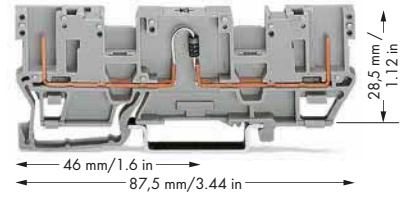

769-208/281-411      769-208/281-410

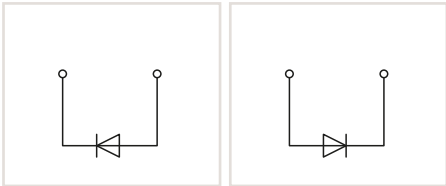

2-pin diode carrier terminal block, for DIN-35 rail, per EN 60715

	Item No.	Pack. Unit
○ Anode, right side	769-228/281-411	100
○ Anode, left side	769-228/281-410	100

250 V  
1000 V  
0.5 A  
4 mm<sup>2</sup>

5 mm / 0.197 inch  
Polyamide 66 (PA 66)

	Item No.	Page
orange	769-306	526
plain	248-501	781
gray	769-101	519
gray	769-101/022-000	521

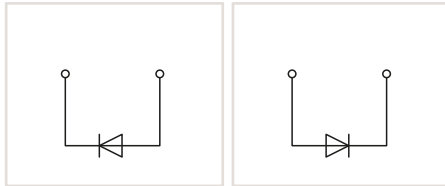

1-conductor/1-pin diode carrier terminal block with two jumper positions, for DIN-35 rail, per EN 60715

	Item No.	Pack. Unit
○ Anode, right side	769-218/281-411	50
○ Anode, left side	769-218/281-410	50

250 V  
1000 V  
0.5 A  
4 mm<sup>2</sup>

0.08 ... 4 mm<sup>2</sup> / 28 ... 12 AWG  
0.08 ... 4 mm<sup>2</sup> / 28 ... 12 AWG  
8 ... 9 mm / 0.31 ... 0.35 inch  
5 mm / 0.197 inch  
Polyamide 66 (PA 66)

	Item No.	Page
gray	280-402	526
orange	769-312	527
plain	248-501	781
gray	769-101	519
gray	769-101/022-000	521
gray	769-121	521
gray	280-404	528

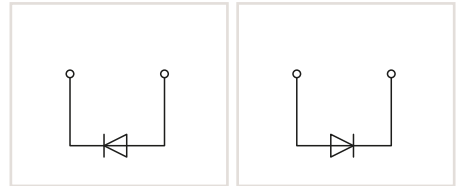

2-pin diode carrier terminal block with two jumper positions, for DIN-35 rail, per EN 60715

	Item No.	Pack. Unit
○ Anode, right side	769-208/281-411	50
○ Anode, left side	769-208/281-410	50

250 V  
1000 V  
0.5 A  
4 mm<sup>2</sup>

5 mm / 0.197 inch  
Polyamide 66 (PA 66)

	Item No.	Page
gray	280-402	526
orange	769-310	527
plain	248-501	781
gray	769-101	519
gray	769-101/022-000	521
gray	769-121	521
gray	280-404	528

## X-COM®-SYSTEM

### 1-Conductor/1-Pin and 2-Pin LED Carrier Terminal Blocks

#### 4 mm<sup>2</sup>, 769 Series

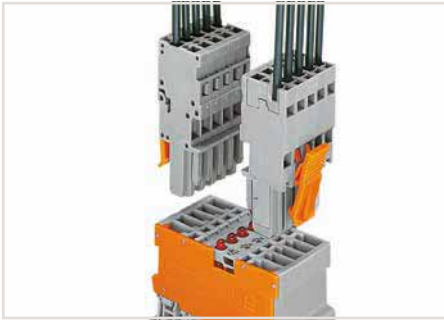

2-pin LED carrier block  
1-conductor female plug, straight\*

\*1-conductor angled female plug is also possible!

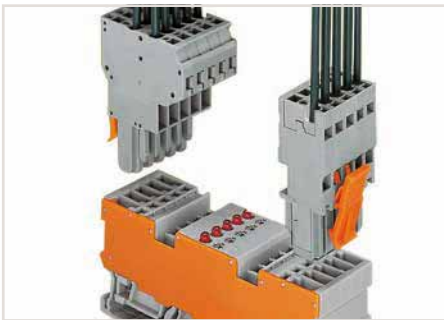

2-pin LED carrier terminal block with 2 jumper positions  
2-conductor female plug  
1-conductor female plug, straight

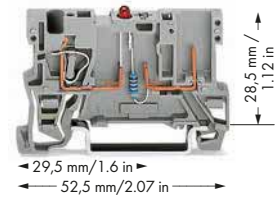

769-239/281-413

769-239/281-434

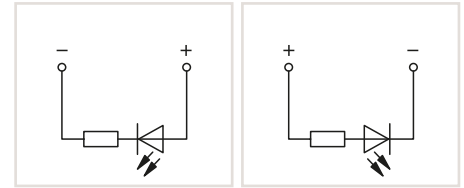

1-conductor/1-pin diode carrier terminal block, for DIN-35 rail, per EN 60715

	Item No.	Pack. Unit
○ Anode, right side	769-239/281-413	100
○ Anode, left side	769-239/281-434	100

#### Technical Data

Voltage type	DC
Nominal voltage	24 V
Rated current	0.025 A
Nominal cross section	4 mm <sup>2</sup>

#### Connection Data

Solid conductor	0.08 ... 4 mm <sup>2</sup> / 28 ... 12 AWG
Fine-stranded conductor	0.08 ... 4 mm <sup>2</sup> / 28 ... 12 AWG
Strip length	8 ... 9 mm / 0.31 ... 0.35 inch
Terminal block width	5 mm / 0.197 inch
Insulation material	Polyamide 66 (PA 66)

#### Accessories (Selection)

Adjacent jumper, insulated, I <sub>N</sub> = I <sub>N</sub> terminal block
End and intermediate plate, 1.1 mm thick
Mini-WSB Quick marking system, white, 10 strips with 10 markers per card, 5 mm wide markers
1-conductor female plug, straight
1-conductor female plug, angled
2-conductor female plug
Test plug adapter, 5 mm wide, for 210-137 Test Plug (2.3 mm Ø), for 1.5 ... 4 mm <sup>2</sup> terminal blocks

	Item No.	Page
orange	769-308	526
plain	248-501	781
gray	769-101	519
gray	769-101/022-000	519

Accessories (jumpers, end plates, test plugs, etc.), see page 526

Carrier rails and tools, see Section 13

Appropriate marking system: Mini-WSB/Mini-WSB Inline, see Full Line Catalog, Volume 6

Approvals and corresponding ratings, visit [www.wago.com](http://www.wago.com)

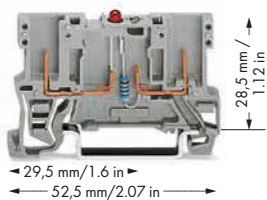

769-229/281-413

769-229/281-434

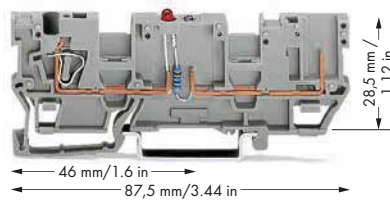

769-219/281-434

769-219/281-413

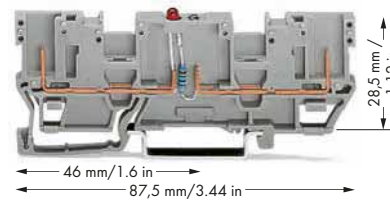

769-209/281-434

769-209/281-413

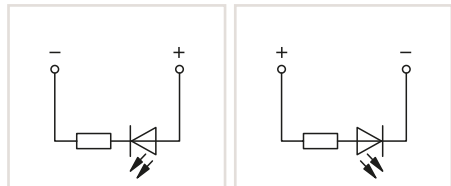

2-pin diode carrier terminal block, for DIN-35 rail, per EN 60715

	Item No.	Pack. Unit
<input type="radio"/> Anode, right side	769-229/281-413	100
<input type="radio"/> Anode, left side	769-229/281-434	100

DC
24 V
0.025 A
4 mm <sup>2</sup>
5 mm / 0.197 inch
Polyamide 66 (PA 66)

	Item No.	Page
orange	769-306	526
plain	248-501	781
gray	769-101	519
gray	769-101/022-000	519

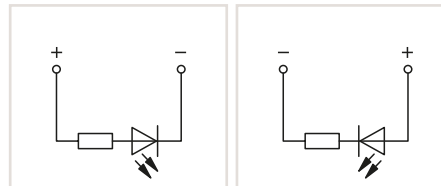

1-conductor/1-pin diode carrier terminal block with two jumper positions, for DIN-35 rail, per EN 60715

	Item No.	Pack. Unit
<input type="radio"/> Anode, right side	769-219/281-434	50
<input type="radio"/> Anode, left side	769-219/281-413	50

DC
24 V
0.025 A
4 mm <sup>2</sup>
0.08 ... 4 mm <sup>2</sup> / 28 ... 12 AWG
0.08 ... 4 mm <sup>2</sup> / 28 ... 12 AWG
8 ... 9 mm / 0.31 ... 0.35 inch
5 mm / 0.197 inch
Polyamide 66 (PA 66)

	Item No.	Page
gray	280-402	526
orange	769-312	527
plain	248-501	781
gray	769-101	519
gray	769-101/022-000	521
gray	769-121	521
gray	280-404	528

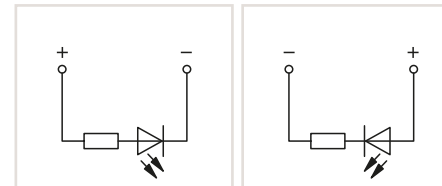

2-pin diode carrier terminal block with two jumper positions, for DIN-35 rail, per EN 60715

	Item No.	Pack. Unit
<input type="radio"/> Anode, right side	769-209/281-434	50
<input type="radio"/> Anode, left side	769-209/281-413	50

DC
24 V
0.025 A
4 mm <sup>2</sup>
5 mm / 0.197 inch
Polyamide 66 (PA 66)

	Item No.	Page
gray	280-402	526
orange	769-310	527
plain	248-501	781
gray	769-101	519
gray	769-101/022-000	521
gray	769-121	521
gray	280-404	528

## X-COM®-SYSTEM

### 1-Conductor/1-Pin and 2-Pin Carrier Terminal Blocks and 1-Conductor Female Plugs Types of Assembly



1-conductor female plug  
Disconnect carrier terminal blocks cannot be commoned.



1-conductor female plug  
Disconnect carrier terminal blocks cannot be commoned.

6



1-conductor female plug  
Diode carrier terminal blocks cannot be commoned.

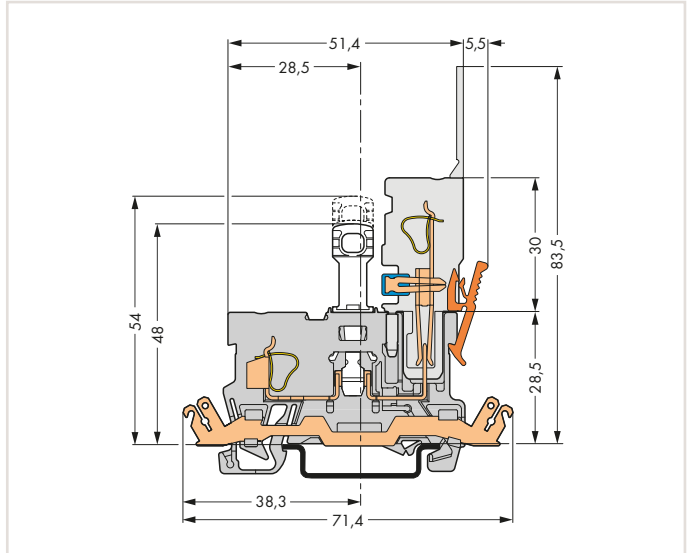

Disconnect carrier terminal block with shield contact



1-conductor female plug  
LED carrier terminal blocks cannot be commoned.

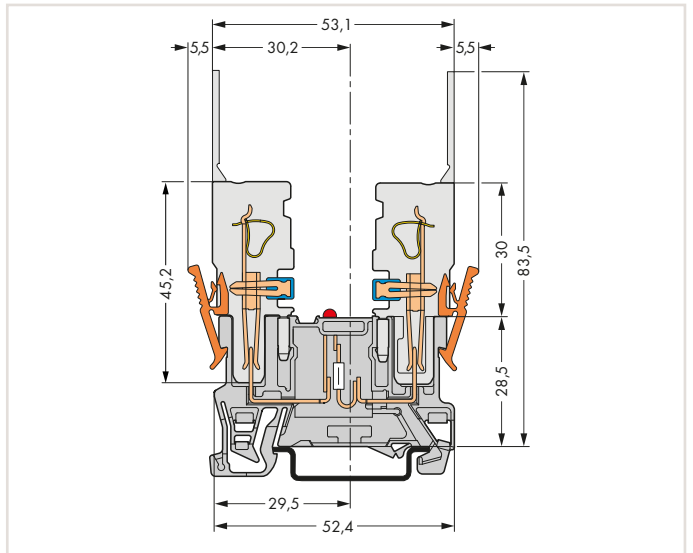

LED carrier terminal block



# X-COM®-SYSTEM – 1-Conductor/1-Pin and 2-Pin Carrier Terminal Blocks with Two Jumper Positions and 1-/2-Conductor Female Plugs Types of Assembly

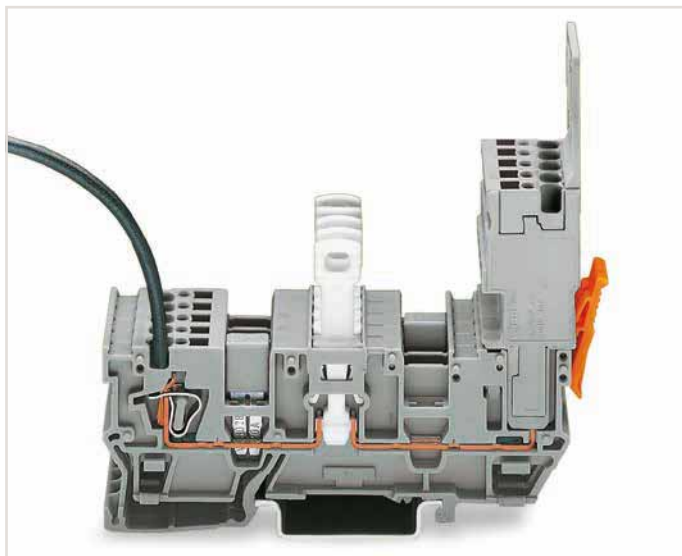

**1-conductor female plug**  
Disconnect carrier terminal blocks can be commoned via 280 and 780 Series Jumpers and tested using a 280 Series Test Plug Adapter.



**2-conductor female plug**  
Disconnect carrier terminal blocks can be commoned via 280 and 780 Series Jumpers.



**2-conductor female plug**  
Diode carrier terminal blocks can be commoned via 280 and 780 Series Jumpers and tested using a 280 Series Test Plug Adapter.

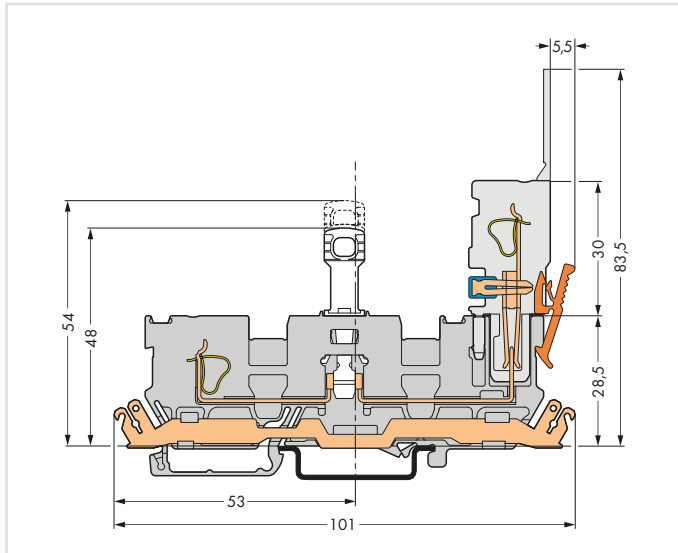

**Disconnect carrier terminal block with shield contact**  
For other dimensions, see 769-171 Carrier Terminal Block.



**2-conductor and 1-conductor female plugs (may be reversed)**  
LED carrier terminal blocks can be commoned via 280 and 780 Series Jumpers and tested using a 280 Series Test Plug Adapter.

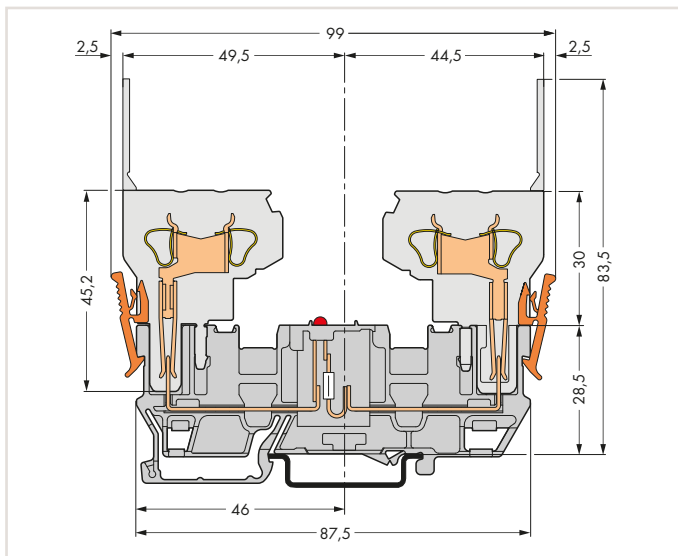

**LED carrier terminal block**  
For other dimensions, see 769-151 Carrier Terminal Block.

## X-COM®-SYSTEM –1-Conductor/1-Conductor Disconnect Carrier Terminal Blocks with Two Jumper Positions

### 4 mm<sup>2</sup>, 769 Series



Carrier terminal blocks can be commoned via 280 and 780 Series Jumpers and tested using a 280 Series Test Plug Adapter.

250 V / 4 kV / 3 = Nominal voltage with shield contact

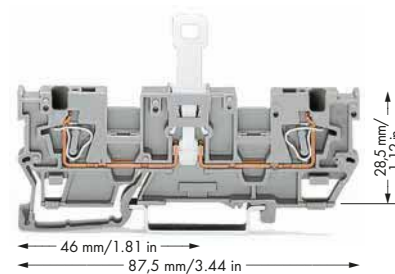

1-conductor/1-conductor disconnect carrier terminal block with two jumper positions, for DIN-35 rail, per EN 60715

Color	Item No.	Pack. Unit
○ gray	769-242	50

1-conductor/1-conductor disconnect carrier terminal block with two jumper positions and shield contact, for DIN-35 rail, per EN 60715

Color	Item No.	Pack. Unit
○ gray	769-243	50

#### Technical Data

Rated voltage (III / 3)	400 V
Rated surge voltage (III / 3)	6 kV
Rated current	16 A
Nominal cross section	4 mm <sup>2</sup>

#### Connection Data

Solid conductor	0.08 ... 4 mm <sup>2</sup> / 28 ... 12 AWG
Fine-stranded conductor	0.08 ... 4 mm <sup>2</sup> / 28 ... 12 AWG
Strip length	8 ... 9 mm / 0.31 ... 0.35 inch
Terminal block width	5 mm / 0.197 inch
Insulation material	Polyamide 66 (PA 66)

#### Accessories (Selection)

Adjacent jumper, insulated, I <sub>N</sub> = I <sub>N</sub> terminal block	gray	280-402	526
End and intermediate plate, 1.1 mm thick	orange	769-318	527
Mini-WSB Quick marking system, white, 10 strips with 10 markers per card, 5 mm wide markers	plain	248-501	781
Test plug adapter, 5 mm wide, for 210-137 Test Plug (2.3 mm Ø), for 1.5 ... 4 mm <sup>2</sup> terminal blocks	gray	280-404	528
Disconnect lock, for disconnect tab used on disconnect terminal blocks (280/281 and 769 Series)	red	709-170	528

6

Accessories (jumpers, end plates, test plugs, etc.), see page 526

Carrier rails and tools, see Section 13

Appropriate marking system: Mini-WSB/Mini-WSB Inline, see Full Line Catalog, Volume 6

Approvals and corresponding ratings, visit [www.wago.com](http://www.wago.com)

## X-COM®-SYSTEM – 1-Conductor/1-Conductor Disconnect Carrier Terminal Blocks with Two Jumper Positions

### Types of Assembly

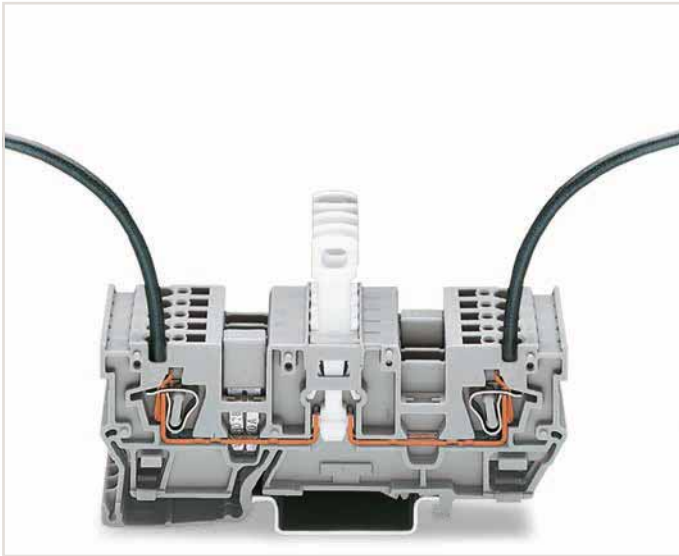

Carrier terminal blocks can be commoned via 280 and 780 Series Jumpers and tested using a 280 Series Test Plug Adapter.

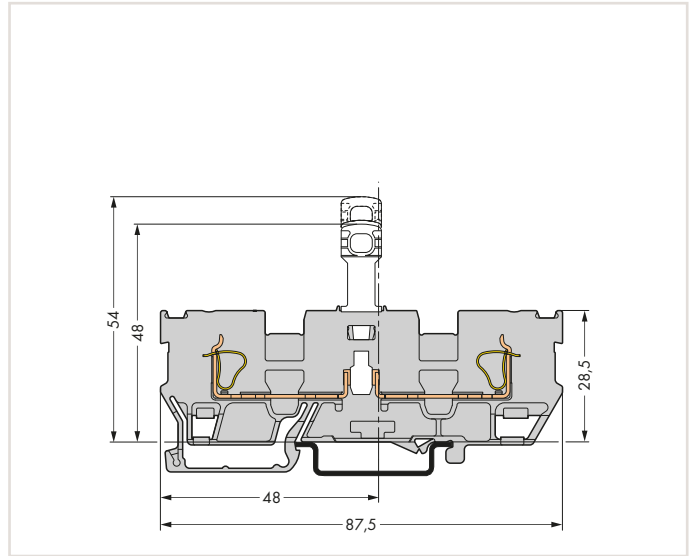

Disconnect carrier terminal block

## X-COM®-SYSTEM – 1-Conductor/1-Pin and 2-Pin Carrier Terminal Blocks and Carrier Terminal Blocks for Pluggable Modules (Fuses, Relays, Optocouplers, etc.) 4 mm<sup>2</sup>, 769 Series

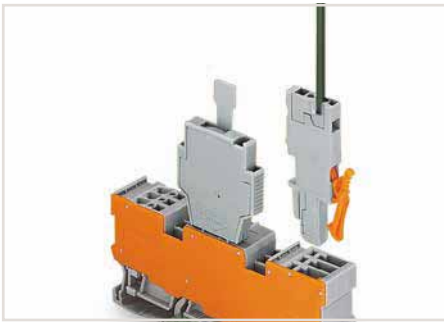

1-conductor/1-pin carrier terminal block with two jumper positions  
1-connector female plug, straight\*  
Fuse plug, 6 mm wide (every other terminal block)

\*1-conductor angled female plug is also possible!



2-pin terminal block for pluggable modules with two jumper positions and separator plate  
1-connector female plug, straight\*  
Relay plug, 25 mm wide

\*1-conductor angled female plug is also possible!

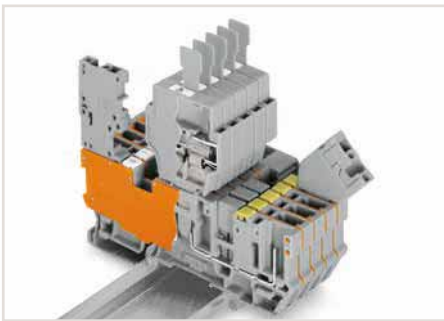

With 6 mm wide fuse plugs, only 1-pole female plugs can be used. Commoning is only possible using adjacent jumpers (280 Series) and push-in type wire jumpers.

16 A, 85 °C upper-temperature limit (see current-carrying capacity curve at [www.wago.com](http://www.wago.com))

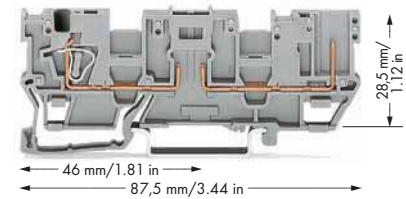

1-conductor/1-pin carrier terminal block with two jumper positions, for DIN-35 rail, per EN 60715

	Item No.	Pack. Unit
○ 2-pole	769-181	50



### Technical Data

Rated voltage (III / 3)	400 V
Rated surge voltage (III / 3)	6 kV
Rated current	16 A
Approval	300 V, 20 A ; 300 V, 20 A
Nominal cross section	4 mm <sup>2</sup>
<b>Connection Data</b>	
Solid conductor	0.08 ... 4 mm <sup>2</sup> / 28 ... 12 AWG
Fine-stranded conductor	0.08 ... 4 mm <sup>2</sup> / 28 ... 12 AWG
Strip length	8 ... 9 mm / 0.31 ... 0.35 inch
Terminal block width	5 mm / 0.197 inch
Insulation material	Polyamide 66 (PA 66)

### Accessories (Selection)

	Item No.	Page
Adjacent jumper, insulated, I <sub>N</sub> = I <sub>N</sub> , terminal block	gray 280-402	526
End and intermediate plate, 1.1 mm thick	orange 769-312	527
Mini-WSB Quick marking system, white, 10 strips with 10 markers per card, 5 mm wide markers	plain 248-501	781
1-connector female plug, straight	gray 769-101	519
1-conductor female plug, angled		
Fuse plug, with soldered miniature fuse, 5 mm wide, gray	gray 280-850	382
Fuse plug with pull-tab, 6 mm wide	gray 281-511	380
Diode module, with 1N4007 diode, 5 mm wide	gray 280-801/281-411	434
LED module, with red LED, 5 mm wide	gray 280-801/281-413	436
Test plug adapter, 5 mm wide, for 210-137 Test Plug (2.3 mm Ø), for 1.5 ... 4 mm <sup>2</sup> terminal blocks	gray 280-404	528

Accessories (jumpers, end plates, test plugs, etc.), see page 526

Carrier rails and tools, see Section 13

Appropriate marking system: Mini-WSB/Mini-WSB Inline, see Full Line Catalog, Volume 6

Approvals and corresponding ratings, visit [www.wago.com](http://www.wago.com)

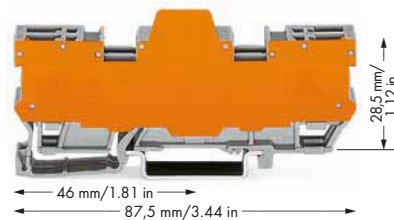
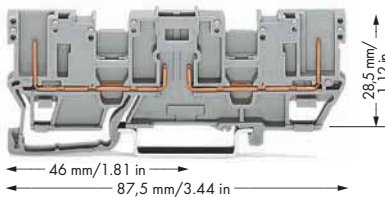
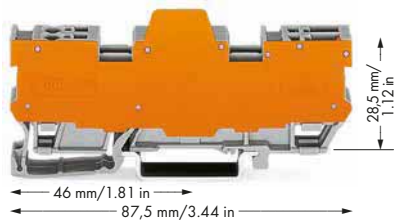

2-conductor/1-pin carrier terminal block for pluggable modules with two jumper positions, for DIN-35 rail, per EN 60715

	Item No.	Pack. Unit
○ 4-pole, 11.1 mm wide	769-182/769-314	10
○ 6-pole, 16.1 mm wide	769-183/769-314	5
○ 8-pole, 21.1 mm wide	769-184/769-314	5
○ 10-pole, 26.1 mm wide	769-185/769-314	5



400 V  
6 kV  
16 A  
300 V, 20 A **UL**; 300 V, 20 A **CE**  
4 mm<sup>2</sup>

0.08 ... 4 mm<sup>2</sup> / 28 ... 12 AWG  
0.08 ... 4 mm<sup>2</sup> / 28 ... 12 AWG  
8 ... 9 mm / 0.31 ... 0.35 inch  
5 mm / 0.197 inch  
Polyamide 66 (PA 66)

	Item No.	Page
gray	280-402	526
orange	769-312	527
plain	248-501	781
gray	769-101	519
gray	280-850	382
gray	281-511	380
gray	280-801/281-411	434
gray	280-801/281-413	436
gray	280-404	528

2-pin carrier terminal block with two jumper positions, for DIN-35 rail, per EN 60715

	Item No.	Pack. Unit
○ 2-pole	769-161	50



400 V  
6 kV  
16 A  
300 V, 20 A **UL**; 300 V, 20 A **CE**

5 mm / 0.197 inch  
Polyamide 66 (PA 66)

	Item No.	Page
gray	280-402	526
orange	769-310	527
plain	248-501	781
gray	769-101	519
gray	769-101/022-000	521
gray	280-850	382
gray	281-511	380
gray	280-801/281-411	434
gray	280-801/281-413	436

2-pin carrier terminal block for pluggable modules with two jumper positions, for DIN-35 rail, per EN 60715

	Item No.	Pack. Unit
○ 4-pole, 11.1 mm wide	769-162/769-313	10
○ 6-pole, 16.1 mm wide	769-163/769-313	5
○ 8-pole, 21.1 mm wide	769-164/769-313	5
○ 10-pole, 26.1 mm wide	769-165/769-313	5



400 V  
6 kV  
16 A  
300 V, 20 A **UL**; 300 V, 20 A **CE**

5 mm / 0.197 inch  
Polyamide 66 (PA 66)

	Item No.	Page
gray	280-402	526
orange	769-310	527
plain	248-501	781
gray	769-101	519
gray	769-101/022-000	521
gray	280-850	382
gray	281-511	380
gray	280-801/281-411	434
gray	280-801/281-413	436

## X-COM®-SYSTEM

### 1-Conductor Female Plugs and Selection of Pluggable Modules

#### Types of Assembly

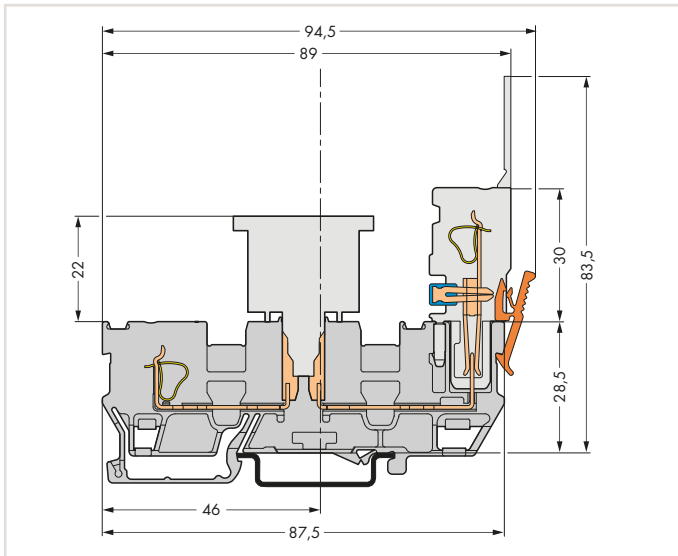

Carrier terminal block

6

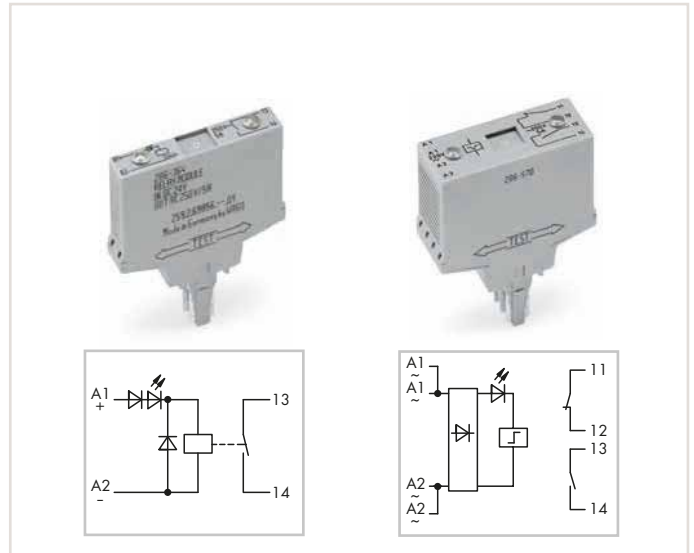
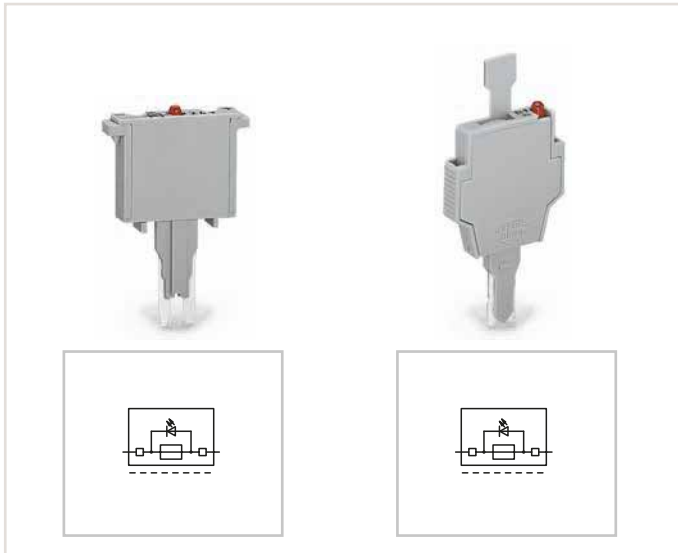



# X-COM®-SYSTEM

## 1-Conductor Female Plugs and Selection of Pluggable Modules

### Types of Assembly

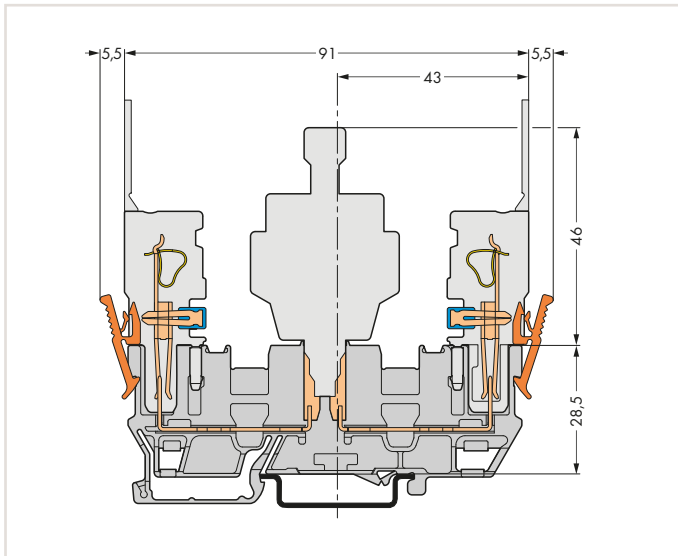

Carrier terminal block

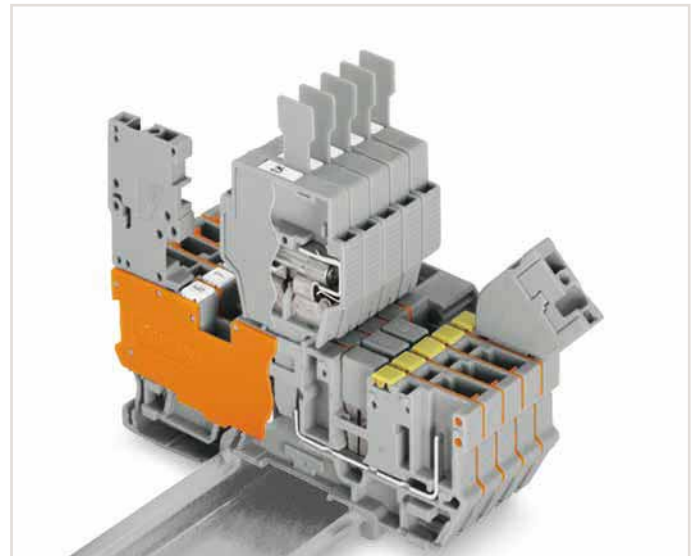

With 6 mm wide fuse plugs, only 1-pole female plugs can be used. Commoning is only possible using adjacent jumpers (280 Series) and push-in type wire jumpers.

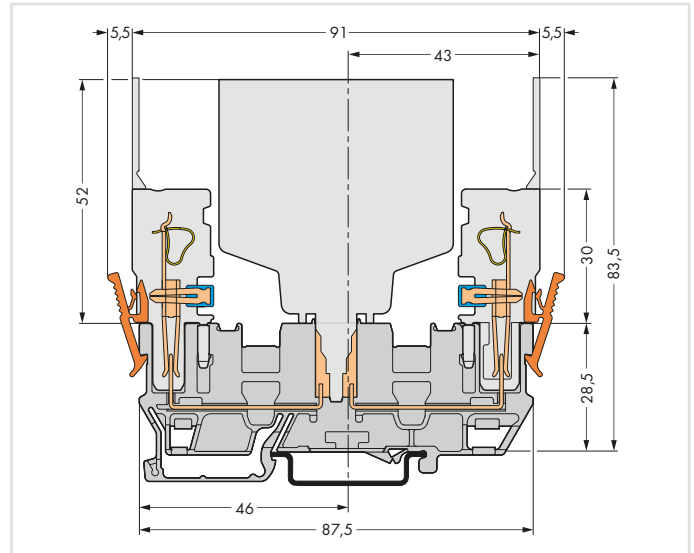

Carrier terminal block  
For other dimensions, see 769-151 Carrier Terminal Block.

6

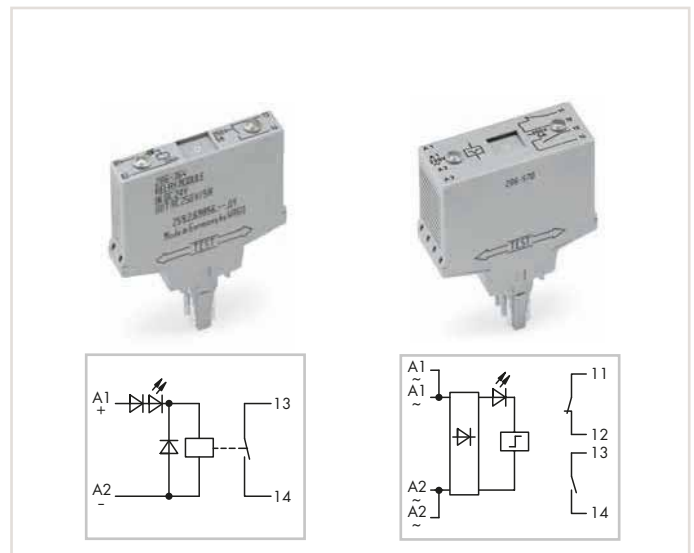
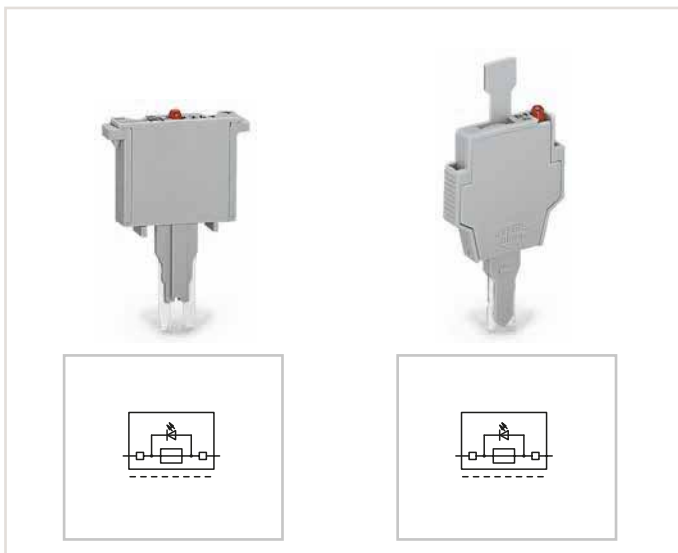

# X-COM®-SYSTEM – 1-Conductor/1-Conductor Carrier Terminal Blocks and Carrier Terminal Blocks for Pluggable Modules (Fuses, Relays, Optocouplers, etc.)

## 4 mm<sup>2</sup>, 769 Series

16 A, 85 °C upper-temperature limit (see current-carrying capacity curve at [www.wago.com](http://www.wago.com))

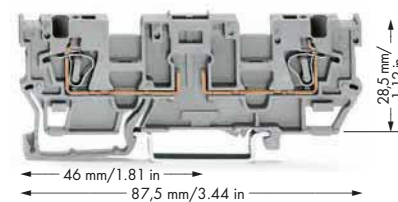

1-conductor/1-conductor carrier terminal block with two jumper positions, for DIN-35 rail, per EN 60715

	Item No.	Pack. Unit
○ 2-pole	769-191	50

1-conductor/1-conductor carrier terminal block for pluggable modules with two jumper positions, for DIN-35 rail, per EN 60715

	Item No.	Pack. Unit
○ 4-pole, 11.1 mm wide	769-192/769-319	10
○ 6-pole, 16.1 mm wide	769-193/769-319	5
○ 8-pole, 21.1 mm wide	769-194/769-319	5
○ 10-pole, 26.1 mm wide	769-195/769-319	5

### Technical Data

Rated voltage (III / 3)	400 V
Rated surge voltage (III / 3)	6 kV
Rated current	16 A
Nominal cross section	4 mm <sup>2</sup>
<b>Connection Data</b>	
Solid conductor	0.08 ... 4 mm <sup>2</sup> / 28 ... 12 AWG
Fine-stranded conductor	0.08 ... 4 mm <sup>2</sup> / 28 ... 12 AWG
Strip length	8 ... 9 mm / 0.31 ... 0.35 inch
Terminal block width	5 mm / 0.197 inch
Insulation material	Polyamide 66 (PA 66)

### Accessories (Selection)

Adjacent jumper, insulated, I <sub>N</sub> = I <sub>N</sub> terminal block	gray	280-402	526
End and intermediate plate, 1.1 mm thick	orange	769-318	527
Mini-WSB Quick marking system, white, 10 strips with 10 markers per card, 5 mm wide markers	plain	248-501	781
Fuse plug, with soldered miniature fuse, 5 mm wide, gray	gray	280-850	382
Fuse plug with pull-tab, 6 mm wide	gray	281-511	380
Diode module, with 1N4007 diode, 5 mm wide	gray	280-801/281-411	434
LED module, with red LED, 5 mm wide	gray	280-801/281-413	436
Test plug adapter, 5 mm wide, for 210-137 Test Plug (2.3 mm Ø), for 1.5 ... 4 mm <sup>2</sup> terminal blocks	gray	280-404	528

Accessories (jumpers, end plates, test plugs, etc.), see page 526

Carrier rails and tools, see Section 13

Appropriate marking system: Mini-WSB/Mini-WSB Inline, see Full Line Catalog, Volume 6

Approvals and corresponding ratings, visit [www.wago.com](http://www.wago.com)

# X-COM®-SYSTEM

## Selection of Pluggable Modules

### Types of Assembly

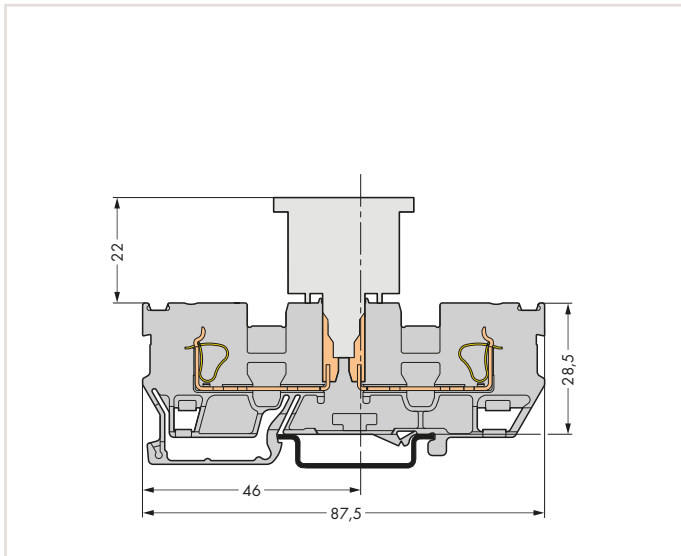

Carrier terminal block

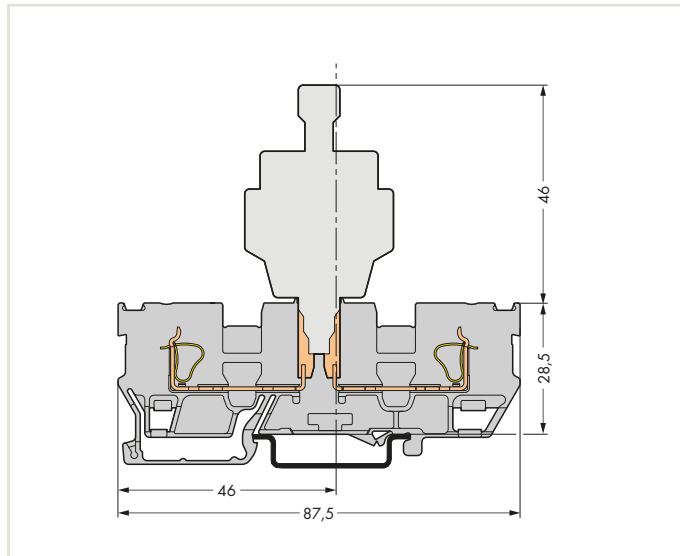

Carrier terminal block

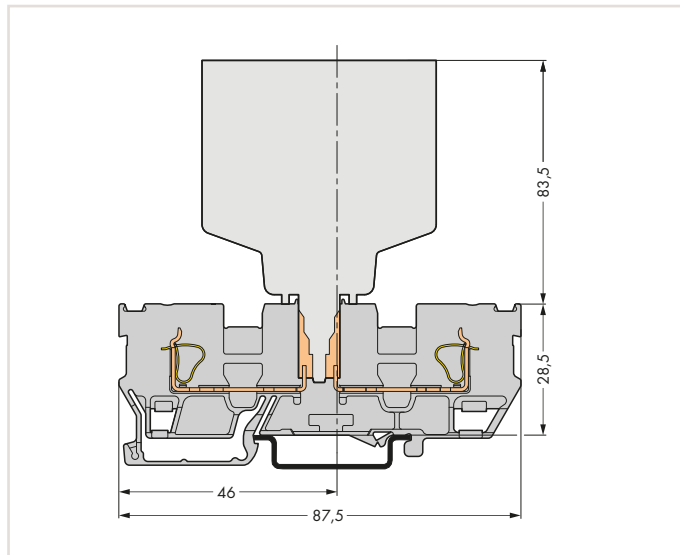
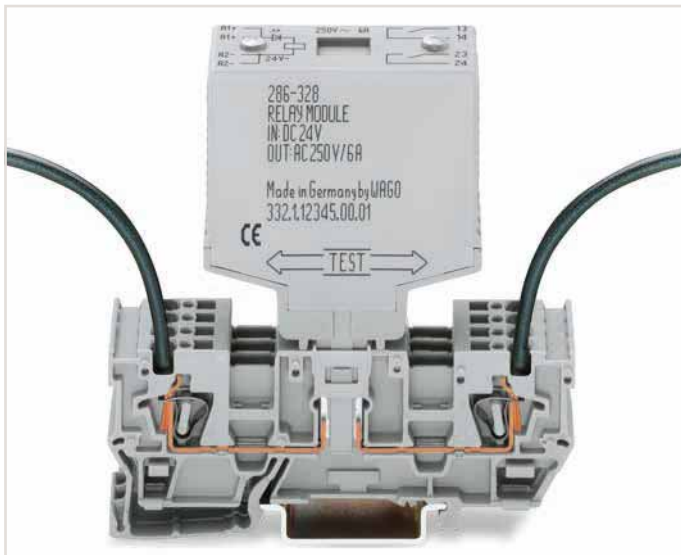

Carrier terminal block

6

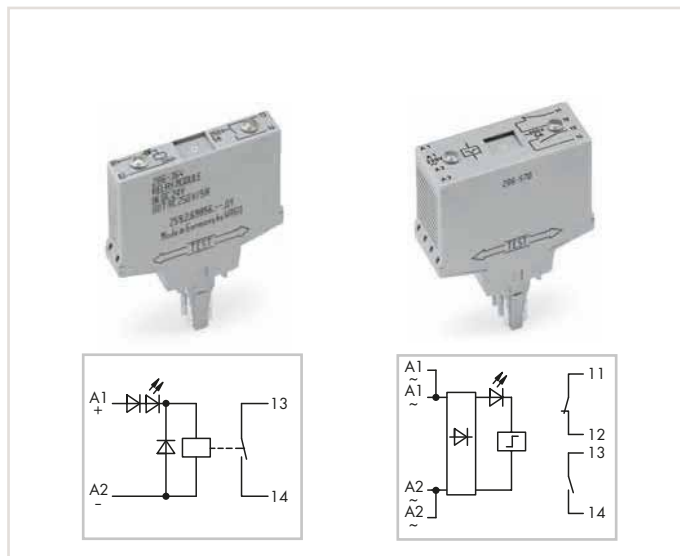
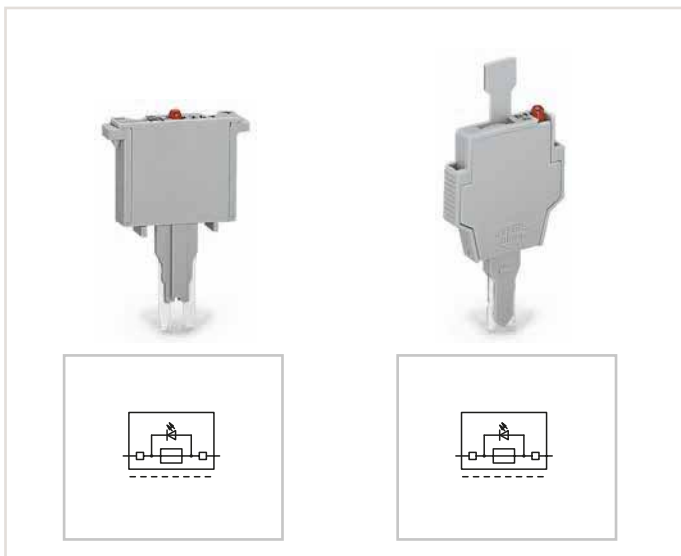

## X-COM®-SYSTEM

## 1-Conductor/1-Pin, Double-Deck Carrier Terminal Blocks

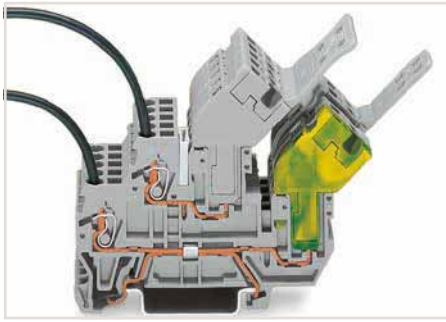
2.5 (4 "f-st") mm<sup>2</sup>, 870 Series

Angled female plugs provide reduced installation height.

2-conductor female plugs cannot be used.

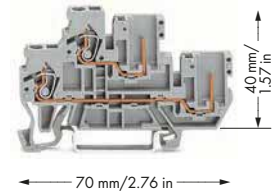

1-conductor/1-pin double-deck carrier terminal block, through/through terminal block

	Item No.	Pack. Unit
○ L/L	870-101	50
○ N/L	870-102	50
○ L/N	870-103	50
● N/N	870-104	50



#### Technical Data

Rated voltage (III / 3)

500 V

Rated surge voltage (III / 3)

6 kV

Rated current

16 A

Approval

300 V, 20 A; 600 V, 5 A. 

#### Connection Data

Solid conductor

0.08 ... 2.5 mm<sup>2</sup> / 28 ... 12 AWG

Fine-stranded conductor

0.08 ... 4 mm<sup>2</sup> / 28 ... 12 AWG

Strip length

6 ... 7 mm / 0.24 ... 0.28 inch

Terminal block width

5 mm / 0.197 inch

Insulation material

Polyamide 66 (PA 66)

#### Accessories (Selection)

Push-in type jumper bar, insulated, I<sub>n</sub> 18 A, light gray

2-way

870-402

529

End and intermediate plate, 1 mm thick

orange

870-119

529

Mini-WSB Quick marking system, white, 10 strips with 10 markers per card, 5 mm wide markers

plain

248-501

781

1-conductor female plug, straight

gray

769-101

519

1-conductor female plug, angled

gray

769-101/022-000

519

6

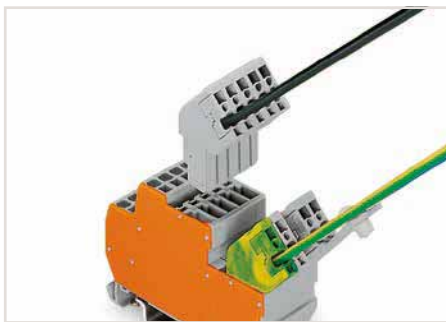



1-conductor/1-pin, double-deck carrier terminal block  
1-conductor female plug, angled\*

\*1-conductor straight female plug is also possible!



Commoning a double-deck through terminal block (870-501) with a 1-conductor/1-pin double-deck terminal block (870-101) via push-in type jumper bar.

 Accessories (jumpers, end plates, etc.), see page 529

 Carrier rails and tools, see Section 13

 Appropriate marking system: Mini-WSB/Mini-WSB Inline/WMB/WMB Inline, see Full Line Catalog, Volume 6

 Approvals and corresponding ratings, visit [www.wago.com](http://www.wago.com)

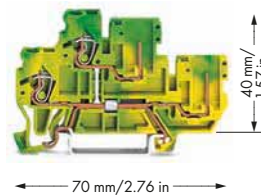
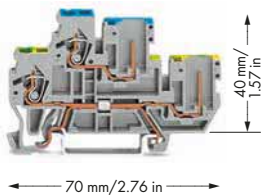
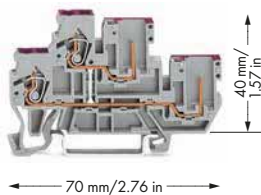

2-conductor/2-pin double-deck carrier terminal block, 2-conductor/2-pin through terminal block, internally commoned, violet conductor entry

	Item No.	Pack. Unit
○ L	870-108	50
○ N	870-109	50

1-conductor/1-pin double-deck carrier terminal block, ground conductor/through terminal block

	Item No.	Pack. Unit
○ PE/N	870-117	50
○ PE/L	870-127	50

2-conductor/2-pin double-deck carrier block, 2-conductor/2-pin ground conductor block, internally commoned

	Item No.	Pack. Unit
● PE	870-107	50



500 V  
6 kV  
16 A  
300 V, 20 A; 600 V, 5 A

0.08 ... 2.5 mm<sup>2</sup> / 28 ... 12 AWG  
0.08 ... 4 mm<sup>2</sup> / 28 ... 12 AWG  
6 ... 7 mm / 0.24 ... 0.28 inch  
5 mm / 0.197 inch  
Polyamide 66 (PA 66)

	Item No.	Page
2-way	870-402	529
orange	870-119	529
plain	248-501	781
gray	769-101	519
gray	769-101/022-000	519



500 V  
6 kV  
16 A  
300 V, 20 A; 600 V, 5 A

0.08 ... 2.5 mm<sup>2</sup> / 28 ... 12 AWG  
0.08 ... 4 mm<sup>2</sup> / 28 ... 12 AWG  
6 ... 7 mm / 0.24 ... 0.28 inch  
5 mm / 0.197 inch  
Polyamide 66 (PA 66)

	Item No.	Page
2-way	870-402	529
orange	870-119	529
plain	248-501	781
gray	769-101	519
gray	769-101/022-000	519



500 V  
6 kV  
16 A  
300 V, 20 A; 600 V, 5 A

0.08 ... 2.5 mm<sup>2</sup> / 28 ... 12 AWG  
0.08 ... 4 mm<sup>2</sup> / 28 ... 12 AWG  
6 ... 7 mm / 0.24 ... 0.28 inch  
5 mm / 0.197 inch  
Polyamide 66 (PA 66)

	Item No.	Page
2-way	870-402	529
orange	870-119	529
plain	248-501	781
gray	769-101	519
gray	769-101/022-000	519

## X-COM®-SYSTEM

### 2-Conductor/2-Pin Double-Deck Carrier Terminal Blocks

#### 870 Series

2-conductor female plugs cannot be used.

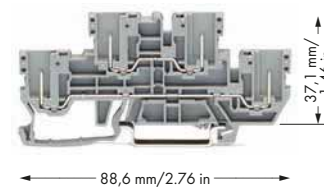

2-pin/2-pin double-deck carrier terminal block, through/through terminal block

	Item No.	Pack. Unit
○ L/L	870-151	50

#### Technical Data

Rated voltage (III / 3)	500 V
Rated surge voltage (III / 3)	6 kV
Rated current	16 A
Approval	300 V, 20 A; 600 V, 5 A:
Terminal block width	5 mm / 0.197 inch
Insulation material	Polyamide 66 (PA 66)

#### Accessories (Selection)

	Item No.	Page
Push-in type jumper bar, insulated, I <sub>N</sub> 18 A, light gray	870-402	529
End and intermediate plate, 1 mm thick	870-169	529
Mini-WSB Quick marking system, white, 10 strips with 10 markers per card, 5 mm wide markers	248-501	781
1-conductor female plug, straight	769-101	519
1-conductor female plug, angled	769-101/022-000	519

6

Accessories (jumpers, end plates, etc.), see page 529

Carrier rails and tools, see Section 13

Appropriate marking system: Mini-WSB/Mini-WSB Inline/WMB/WMB Inline, see Full Line Catalog, Volume 6

Approvals and corresponding ratings, visit [www.wago.com](http://www.wago.com)



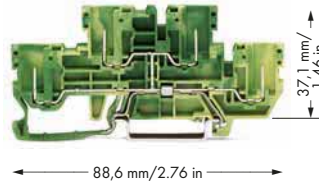
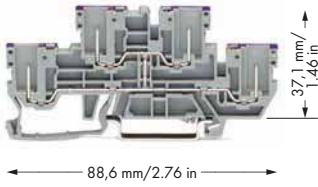

4-pin double-deck carrier terminal block, 4-pin ground conductor terminal block, internally commoned, violet female plug entry

	Item No.	Pack. Unit
○ L	870-158	50

4-pin double-deck carrier block, 4-pin ground conductor terminal block, internally commoned

	Item No.	Pack. Unit
● PE	870-157	50

500 V
6 kV
16 A
300 V, 20 A; 600 V, 5 A; 
5 mm / 0.197 inch
Polyamide 66 (PA 66)

5 mm / 0.197 inch
Polyamide 66 (PA 66)

	Item No.	Page
2-way	870-402	529
orange	870-169	529
plain	248-501	781
gray	769-101	519
gray	769-101/022-000	519

	Item No.	Page
2-way	870-402	529
orange	870-169	529
plain	248-501	781
gray	769-101	519
gray	769-101/022-000	519

## X-COM®-SYSTEM

### 2-Conductor/2-Pin Double-Deck Carrier Terminal Blocks

#### 2.5 (4 "f-st") mm<sup>2</sup>, 870 Series

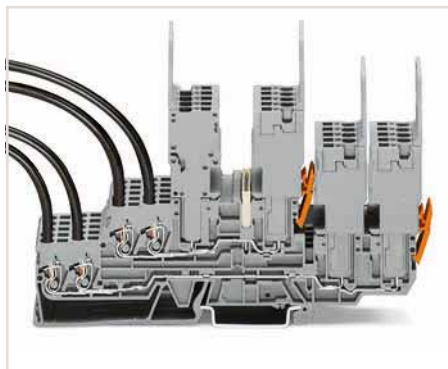

1-connector female plug, straight  
Double-deck carrier terminal blocks can be comoned via 870 Series Push-In Type Jumper Bars.

**Notice:**  
Female plugs must be opposing on the upper deck.  
2-conductor female plugs and angled 1-conductor female plugs cannot be used.

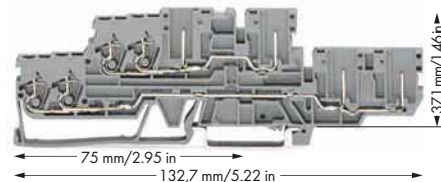

2-conductor/2-pin double-deck carrier terminal block, through/through terminal block

	Item No.	Pack. Unit
○ L/L	870-131	40

#### Technical Data

Rated voltage (III / 3)	500 V
Rated surge voltage (III / 3)	6 kV
Rated current	16 A
Approval	300 V, 20 A; 600 V, 5 A; 

#### Connection Data

Solid conductor	0.08 ... 2.5 mm <sup>2</sup> / 28 ... 12 AWG
Fine-stranded conductor	0.08 ... 4 mm <sup>2</sup> / 28 ... 12 AWG
Strip length	6 ... 7 mm / 0.24 ... 0.28 inch
Terminal block width	5 mm / 0.197 inch
Insulation material	Polyamide 66 (PA 66)

#### Accessories (Selection)

Push-in type jumper bar, insulated, I <sub>n</sub> 18 A, light gray
End and intermediate plate, 1 mm thick
Mini-WSB Quick marking system, white, 10 strips with 10 markers per card, 5 mm wide markers
1-connector female plug, straight

	Item No.	Page
2-way	870-402	529
orange	870-149	529
plain	248-501	781
gray	769-101	519

6

 Accessories (jumpers, end plates, etc.), see page 529

 Carrier rails and tools, see Section 13

 Appropriate marking system: Mini-WSB/Mini-WSB Inline/WMB/WMB Inline, see Full Line Catalog, Volume 6

 Approvals and corresponding ratings, visit [www.wago.com](http://www.wago.com)

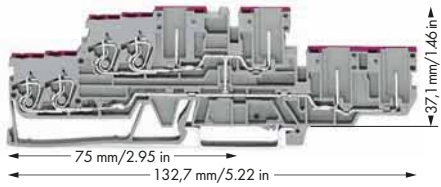

4-conductor/4-pin double-deck carrier terminal block, 4-conductor/4-pin through terminal block, internally commoned, violet conductor entry

	Item No.	Pack. Unit
○ L	870-138	40

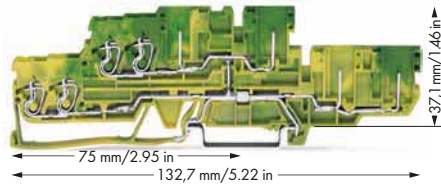

4-conductor/4-pin double-deck carrier block, 4-conductor/4-pin ground conductor block, internally commoned

	Item No.	Pack. Unit
● PE	870-137	40

500 V
6 kV
16 A
300 V, 20 A; 600 V, 5 A, $\overline{UL}$ 185

500 V
6 kV
16 A
300 V, 20 A; 600 V, 5 A, $\overline{UL}$ 185

0.08 ... 2.5 mm <sup>2</sup> / 28 ... 12 AWG
0.08 ... 4 mm <sup>2</sup> / 28 ... 12 AWG
6 ... 7 mm / 0.24 ... 0.28 inch
5 mm / 0.197 inch
Polyamide 66 (PA 66)

0.08 ... 2.5 mm <sup>2</sup> / 28 ... 12 AWG
0.08 ... 4 mm <sup>2</sup> / 28 ... 12 AWG
6 ... 7 mm / 0.24 ... 0.28 inch
5 mm / 0.197 inch
Polyamide 66 (PA 66)

	Item No.	Page
2-way	870-402	529
orange	870-149	529
plain	248-501	781
gray	769-101	519

	Item No.	Page
2-way	870-402	529
orange	870-149	529
plain	248-501	781
gray	769-101	519

## X-COM®-SYSTEM – 1-Conductor/1-Pin Double-Deck Carrier Terminal Blocks and 1-Conductor Female Plugs

### Types of Assembly



Commoning a double-deck through terminal block (870-501) with a 1-conductor/1-pin double-deck terminal block (870-101) via push-in type jumper bar.

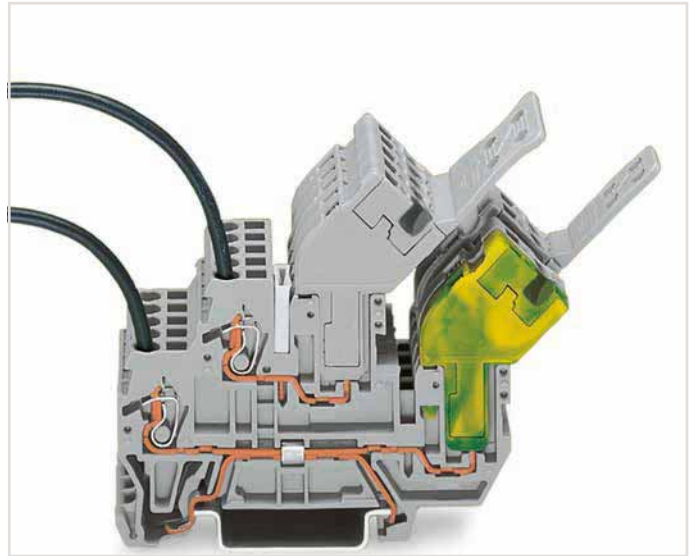

1-conductor female plug, angled  
Double-deck carrier terminal blocks can be commoned via 870 Series Push-In Type Jumper Bars.

6

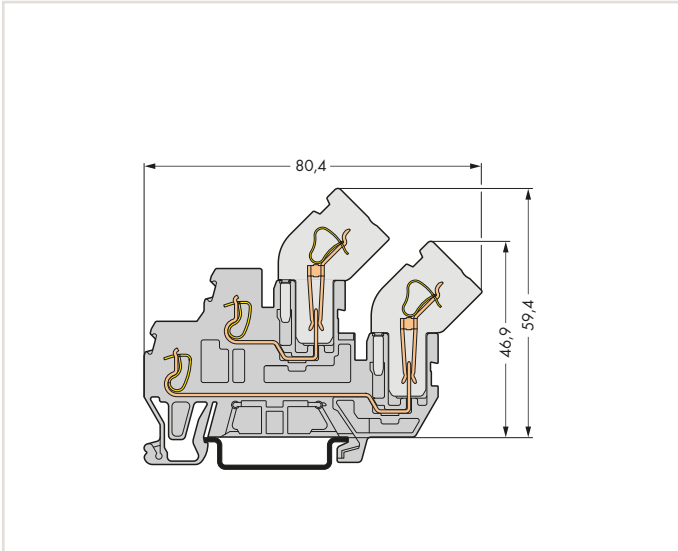

Carrier terminal block

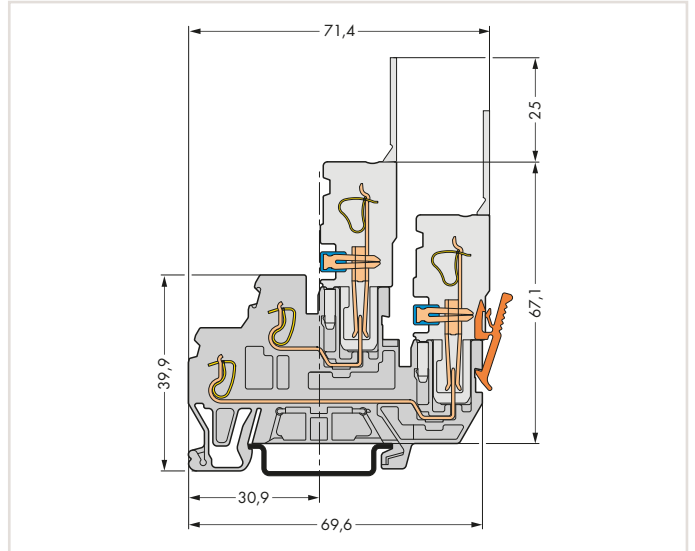

Carrier terminal block

# X-COM®-SYSTEM

## 2-Pin/2-Pin and 2-Conductor/2-Pin Double-Deck Carrier Terminal Blocks

### Types of Assembly



1-connector female plug, straight  
 Double-deck carrier terminal blocks can be commoned via 870 Series Push-In Type Jumper Bars. Notice: 2-conductor female plugs cannot be used.

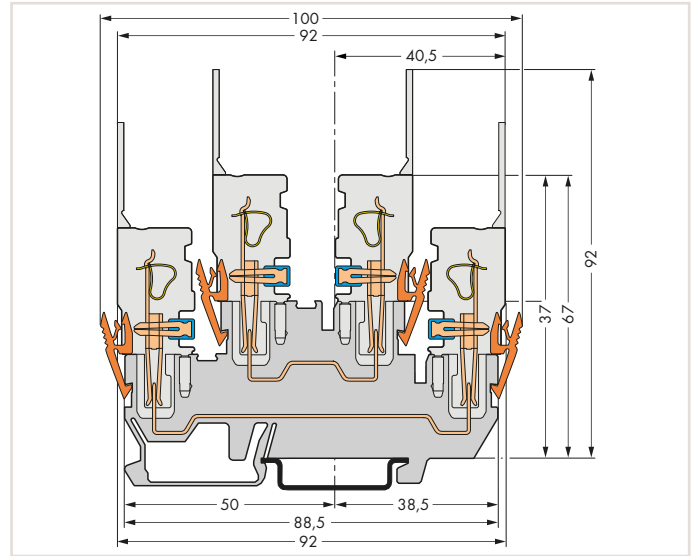

Carrier terminal block

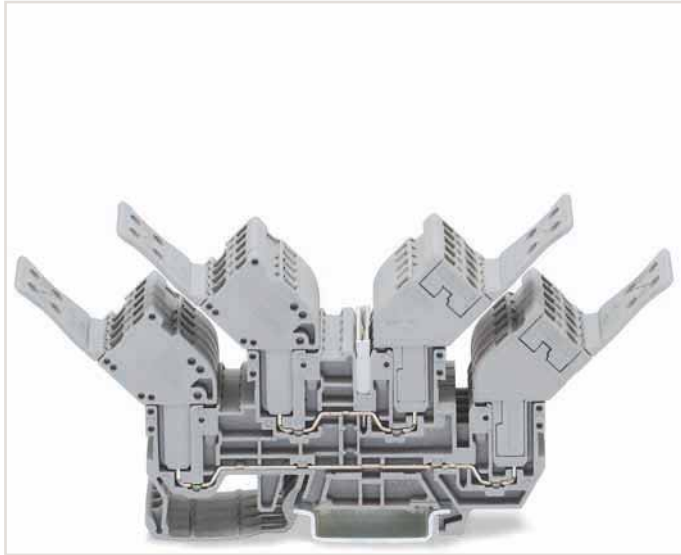

1-conductor female plug, angled  
 Double-deck carrier terminal blocks can be commoned via 870 Series Push-In Type Jumper Bars.

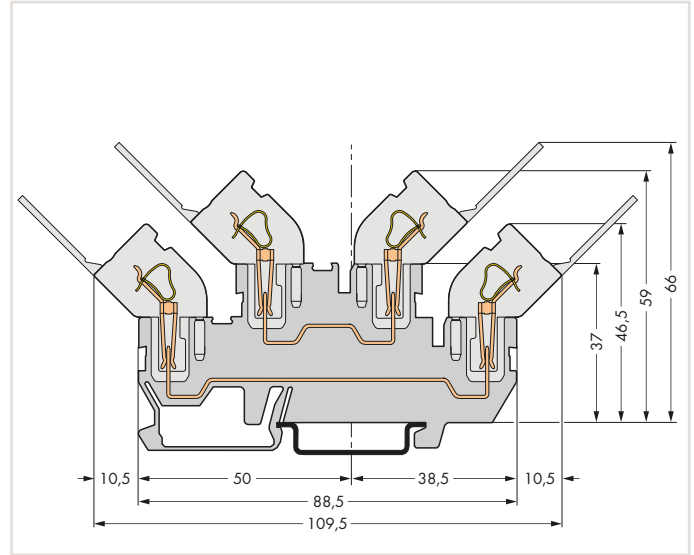

Carrier terminal block

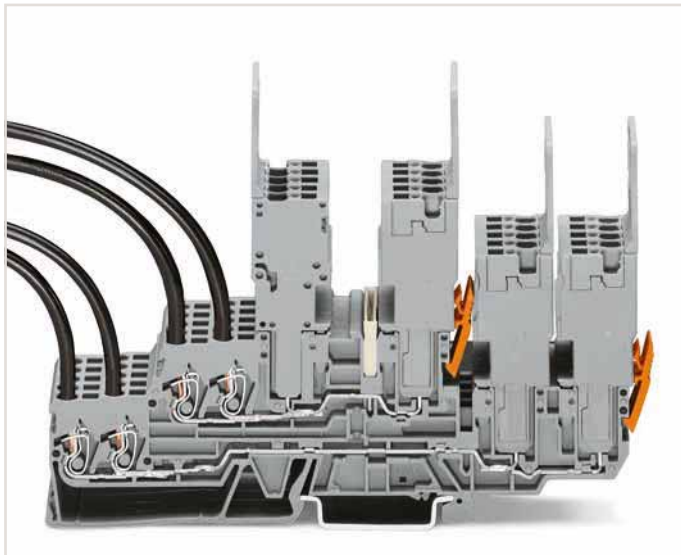

1-connector female plug, straight  
 Double-deck carrier terminal blocks can be commoned via 870 Series Push-In Type Jumper Bars.

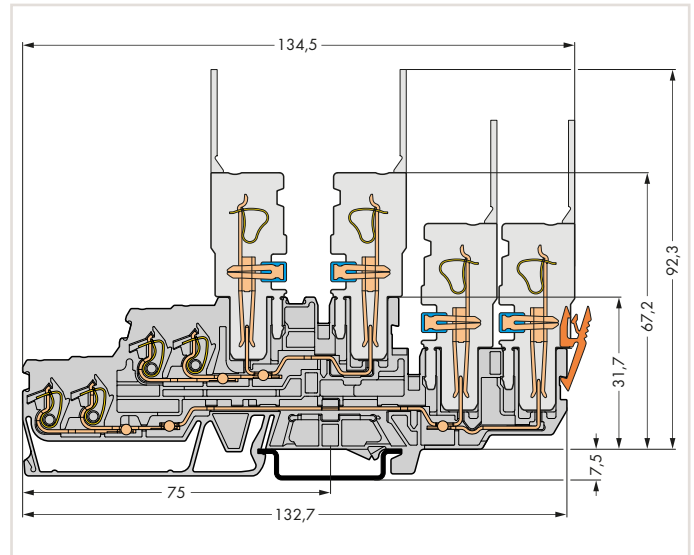

Carrier terminal block

6

# X-COM®-SYSTEM

## Male Connectors/Headers and Female Plugs, 769 Series

### Description and Installation



Male connector with CAGE CLAMP® connection  
1-connector female plug, straight

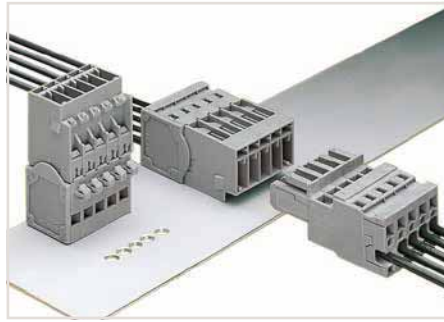

Male connector with CAGE CLAMP® connection and  
snap-in mounting feet  
1-connector female plug, straight

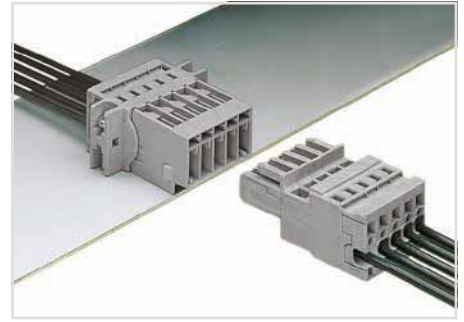

Male connector with CAGE CLAMP® and mounting  
flanges  
1-connector female plug, straight



Male connector with snap-in flanges  
Snap-in mounting without tools



6



Operating tool  
Inserting a conductor via operating tool – side-entry  
wiring (example shows a female plug).  
With ferruled conductors, it is necessary to use a  
terminal block one size smaller than the conductor's  
nominal cross section.



Operating tool  
Inserting a conductor via operating tool (example  
shows a male connector).

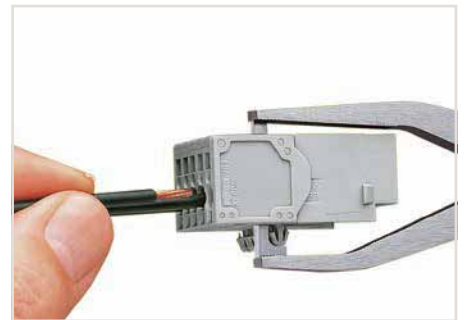

Operating tool  
Inserting a conductor via operating tool (example  
shows a male connector).

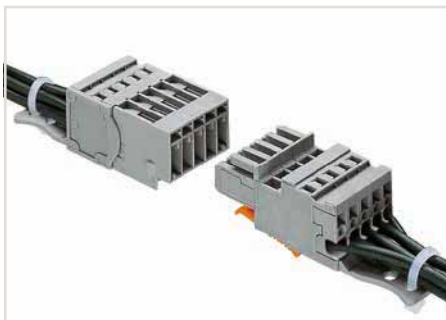

Strain relief plates can be snapped into both male  
connector and female plug.

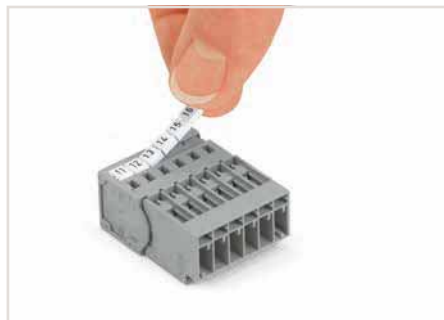

Labeling a male connector with CAGE CLAMP® con-  
nection via Mini-WSB quick markers.



Labeling a female plug with CAGE CLAMP® connec-  
tion via Mini-WSB quick markers.





Coding a female plug by removing coding finger(s) via cutting tool. Do not remove the first and last coding fingers or use an additional locking lever.

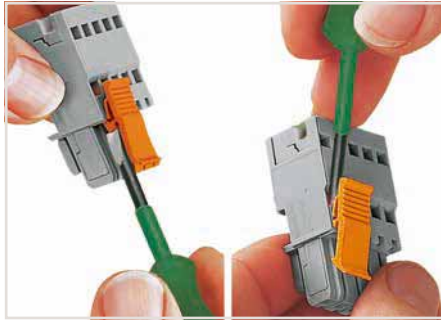

Locking/releasing a lever.



Commoning 1-conductor female plugs via miniature adjacent jumpers.

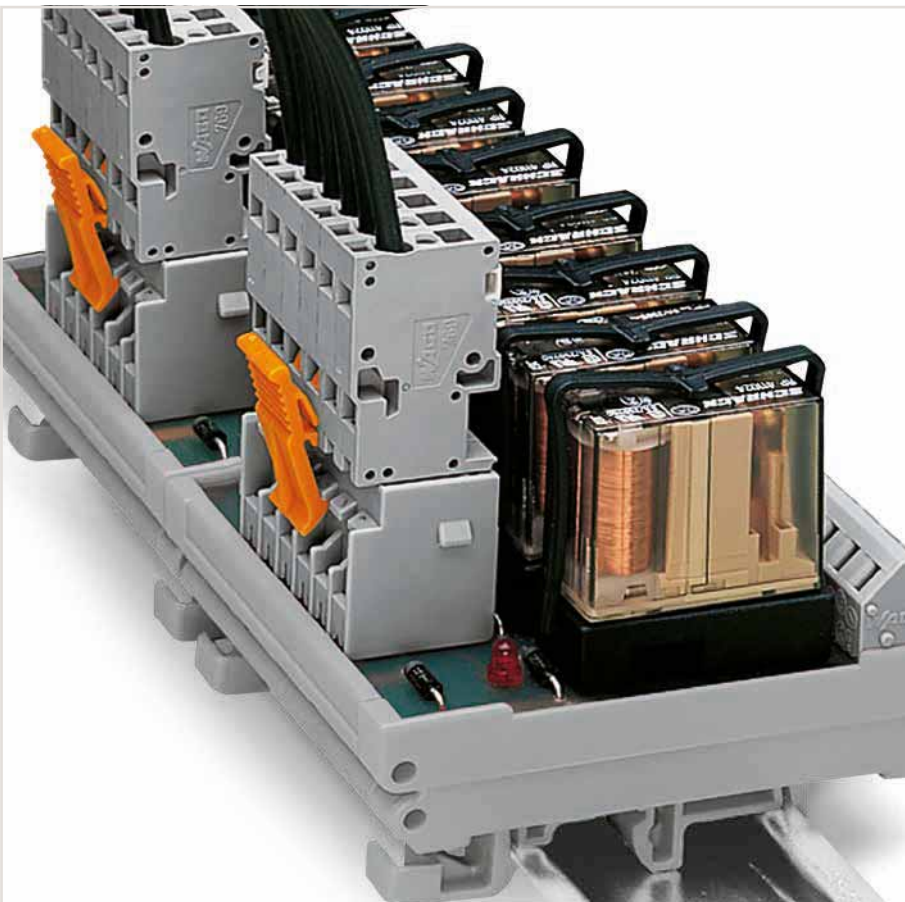

Note: Female plugs used according to the regulations shall not be connected/disconnected when live or under load.

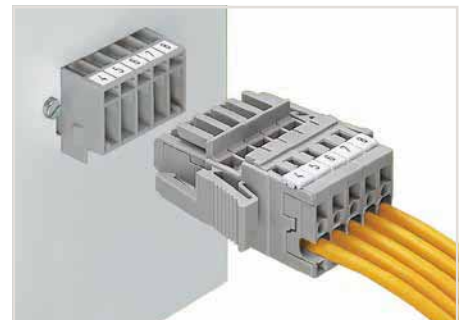

Male header and 1-conductor female plug with lateral locking levers

6

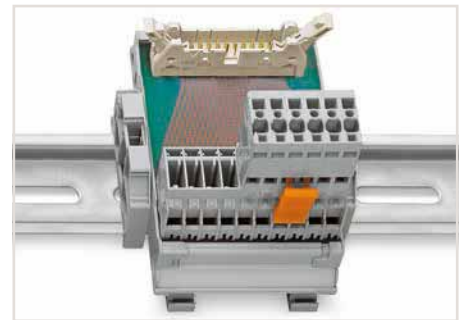

Male headers with solder pins for printed circuit boards

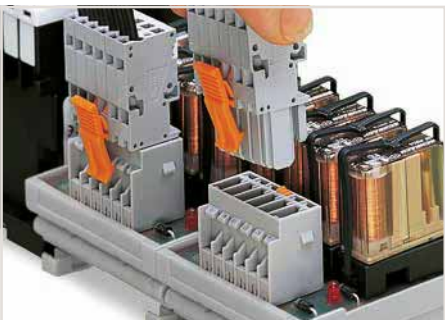

Pluggable PCB connection  
Connection to a relay module inside the switchgear cabinet

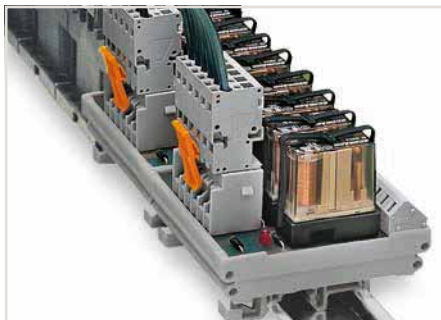

Male headers with straight solder pins and 1-conductor female plugs (picture shows a relay module)



Male headers with solder pins:  
Integrating PCB components into the system wiring.

## X-COM®-SYSTEM



### Male Connectors with CAGE CLAMP® Connection, 5 mm Pin Spacing

#### 4 mm<sup>2</sup>, 769 Series



Male connector with CAGE CLAMP® connection  
1-conductor female plug, straight

#### Technical Data

Rated voltage (III / 3)	500 V
Rated surge voltage (III / 3)	6 kV
Rated current	32 A
<b>Connection Data</b>	
Connection technology	CAGE CLAMP®
Solid conductor	0.08 ... 4 mm <sup>2</sup> / 28 ... 12 AWG
Fine-stranded conductor	0.08 ... 4 mm <sup>2</sup> / 28 ... 12 AWG
Nominal cross section	4 mm <sup>2</sup>
Strip length	8 ... 9 mm / 0.31 ... 0.35 inch
Approval	300 V, 20 A  300 V, 20 A 
Pin spacing	5 mm / 0.197 inch
Polyamide 66 (PA 66)	Polyamide 66 (PA 66)

Current-carrying capacity curves at visit [www.wago.com](http://www.wago.com)

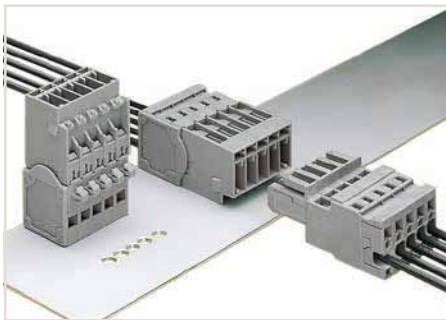

Male connector with CAGE CLAMP® connection and  
snap-in mounting feet  
1-conductor female plug, straight

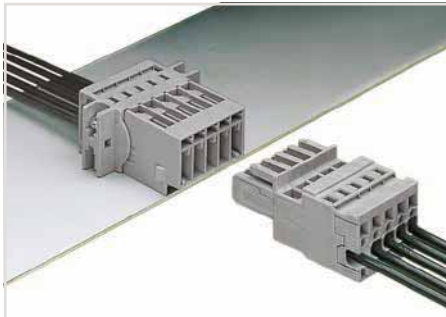



Male connector with CAGE CLAMP® and mounting  
flanges  
1-conductor female plug, straight

6

#### Accessories (Selection)

	Item No.	Page
1-conductor female plug, straight	769-102	519
1-conductor female plug, with lateral locking levers	769-102/021-000	519
2-conductor female plug	769-122	521
Coding pin, for coding female plugs	769-435	527
Operating tool, for female plugs and male connectors with CAGE CLAMP® connection	210-490	532
Operating lever, loose, for male and female connectors with CAGE CLAMP®	769-434	532
Mini-WSB Quick marking system, white, 10 strips with 10 markers per card, 5 mm wide markers	248-501	781

 Appropriate marking system:  
Mini-WSB/Mini-WSB Inline,  
see Full Line Catalog, Volume 6

 Approvals and corresponding ratings,  
visit [www.wago.com](http://www.wago.com)

# X-COM®-SYSTEM

## Male Connectors with CAGE CLAMP® Connection, 5 mm Pin Spacing

### 4 mm², 769 Series



Dimensions (in mm):

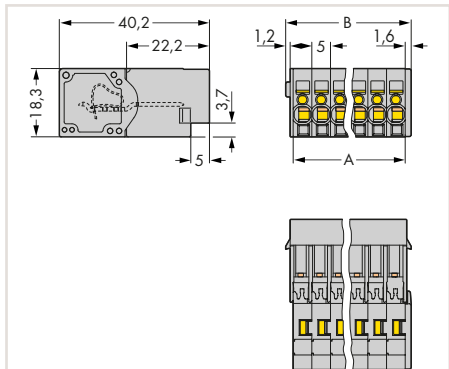

$B = A + 3.6 \text{ mm}$   
 $A = \text{pole no.} \times \text{pin spacing}$

Male connector, with CAGE CLAMP® connection, for flying leads, gray

Pole No.	Item No.	Pack. Unit
2	769-602	100
3	769-603	100
4	769-604	100
5	769-605	50
6	769-606	50
7	769-607	25
8	769-608	25
9	769-609	25
10	769-610	25
11	769-611	25
12	769-612	25
13	769-613	25
14	769-614	15
15	769-615	10

Dimensions (in mm):

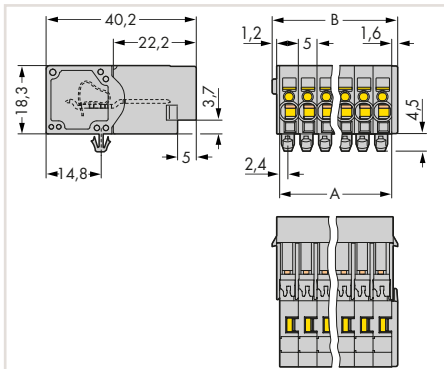

$B = A + 3.6 \text{ mm}$   
 $A = \text{pole no.} \times \text{pin spacing}$

Male connector, with CAGE CLAMP® connection and snap-in mounting feet, for 0.6 ... 1.2 mm plate thickness, 3.5 mm Ø mounting holes, with mounting adapter (209-137) for DIN-35 rail, gray

Pole No.	Item No.	Pack. Unit
2	769-602/001-000	100
3	769-603/001-000	100
4	769-604/001-000	50
5	769-605/001-000	50
6	769-606/001-000	50
7	769-607/001-000	25
8	769-608/001-000	25
9	769-609/001-000	25
10	769-610/001-000	25
11	769-611/001-000	25
12	769-612/001-000	25
13	769-613/001-000	15
14	769-614/001-000	15
15	769-615/001-000	20

Dimensions (in mm):

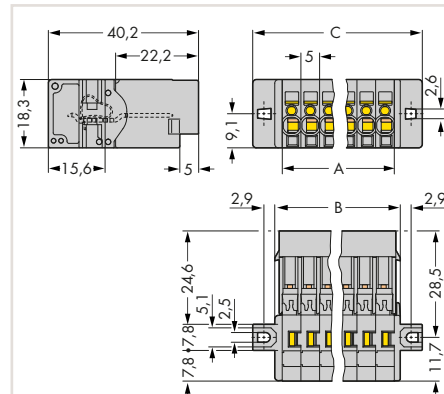

$C = A + 15.4 \text{ mm}$   
 $B = A + 3.6 \text{ mm}$   
 $A = \text{pole no.} \times \text{pin spacing}$

Male connector, with CAGE CLAMP® connection and mounting flanges, for screw or similar mounting types, for vertical or horizontal mounting, gray

Pole No.	Item No.	Pack. Unit
2	769-602/002-000	100
3	769-603/002-000	50
4	769-604/002-000	50
5	769-605/002-000	50
6	769-606/002-000	50
7	769-607/002-000	25
8	769-608/002-000	25
9	769-609/002-000	25
10	769-610/002-000	25
11	769-611/002-000	25
12	769-612/002-000	25
13	769-613/002-000	15
14	769-614/002-000	10
15	769-615/002-000	20



Strain relief plate, gray

	Item No.	Pack. Unit
2 ... 3 poles	769-411	100 (25)
4 ... 5 poles	769-412	100 (25)
6 ... 9 poles	769-413	100 (25)
10 ... 15 poles	769-414	100 (25)



Mounting adapter, for DIN-35 rail, can be used as end plate, 6.5 mm wide

Color	Item No.	Pack. Unit
gray	209-137	25



Mounting screw (M2.5 x 16) and hexagon nut (M2.5)

	Item No.	Pack. Unit
	769-499	100 (25)

# X-COM®-SYSTEM

## Male Connectors with CAGE CLAMP® Connection, 5 mm Pin Spacing

### 4 mm², 769 Series



Dimensions (in mm):

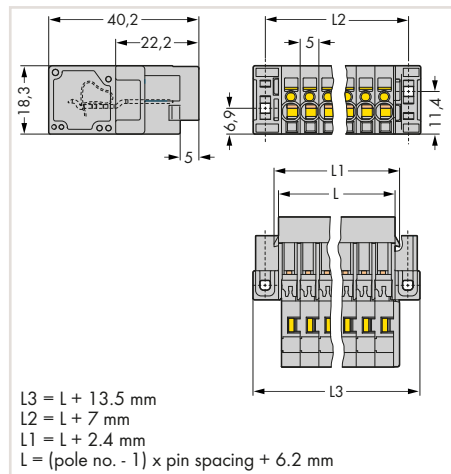

Male connector, with CAGE CLAMP® connection and feedthrough flanges, for screw or similar mounting types, for vertical or horizontal mounting, gray

Pole No.	Item No.	Pack. Unit
2	769-602/004-000	50
3	769-603/004-000	25
4	769-604/004-000	25
5	769-605/004-000	25
6	769-606/004-000	25
7	769-607/004-000	25
8	769-608/004-000	25
9	769-609/004-000	25
10	769-610/004-000	25
11	769-611/004-000	25
12	769-612/004-000	15
13	769-613/004-000	15
14	769-614/004-000	10
15	769-615/004-000	10



Dimensions (in mm):

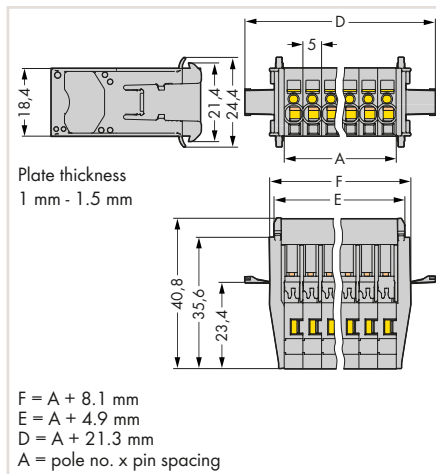

Male connector, with CAGE CLAMP® connection and snap-in flanges, for tool-free mounting, gray

Pole No.	Item No.	Pack. Unit
2	769-602/005-000	50
3	769-603/005-000	25
4	769-604/005-000	25
5	769-605/005-000	25
6	769-606/005-000	25
7	769-607/005-000	25
8	769-608/005-000	20
9	769-609/005-000	20
10	769-610/005-000	20
11	769-611/005-000	15
12	769-612/005-000	15
13	769-613/005-000	15
14	769-614/005-000	10
15	769-615/005-000	10



Dimensions (in mm):

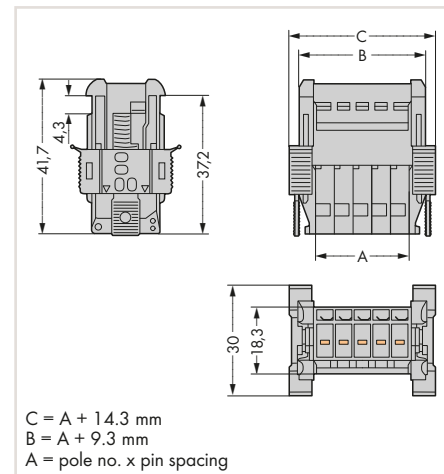

Male connector, with CAGE CLAMP® connection and snap-in flanges, for tool-free mounting, gray

Pole No.	Item No.	Pack. Unit
2	769-602/006-000	100
3	769-603/006-000	100
4	769-604/006-000	50
5	769-605/006-000	25
6	769-606/006-000	25
7	769-607/006-000	25
8	769-608/006-000	25
9	769-609/006-000	20
10	769-610/006-000	25
11	769-611/006-000	25
12	769-612/006-000	25
13	769-613/006-000	15
14	769-614/006-000	15
15	769-615/006-000	10



# X-COM®-SYSTEM

## Male Connectors with CAGE CLAMP® Connection and 1-/2-Conductor Female Plugs Installation

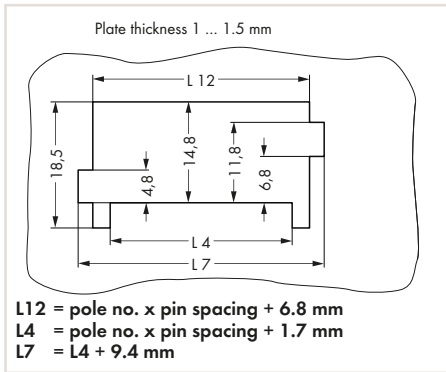

Sheet metal cutout  
 Male connectors with CAGE CLAMP® connection (769-6xx/005-000) and snap-in flanges

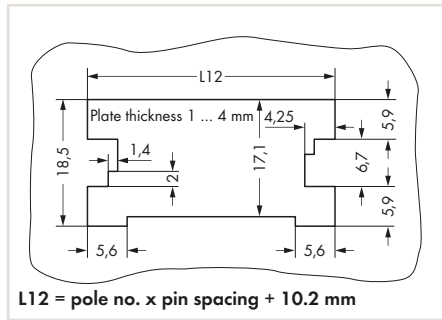

Sheet metal cutout (for female plugs without locking levers)  
 Male connectors with CAGE CLAMP® connection (769-6xx/006-000) and snap-in flanges



Insert male connector with snap-in flanges (769-604/005-000) into the cutout.



Insert male connector with snap-in flanges (769-605/006-000) into the cutout.



For removal, insert operating tool (2.5 mm blade) into release slot.

6



Snap-in mounting without tools

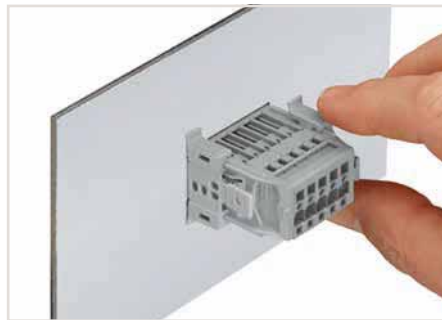

Secure the snap-in flange.

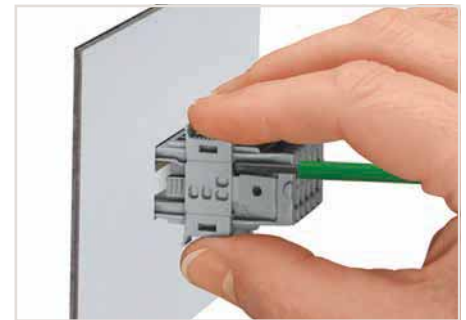

Press center part on both the top and bottom of the connector. Then remove snap-in flange.

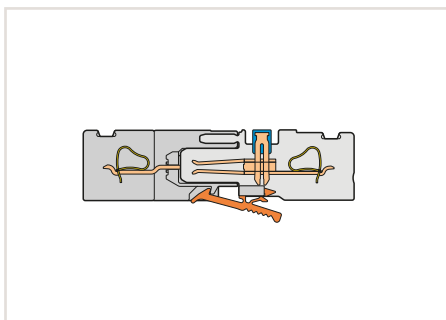

Male connector with CAGE CLAMP® connection

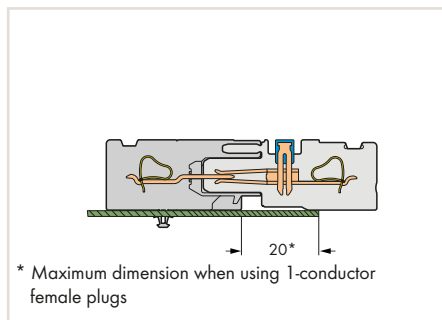

Male connector with CAGE CLAMP® connection and snap-in mounting feet

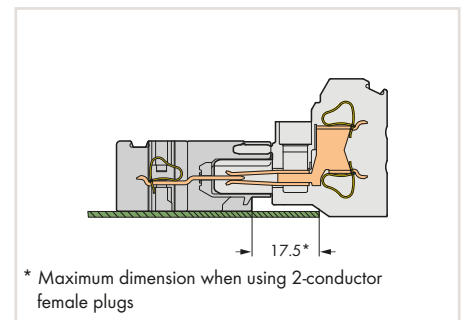

Male connector with CAGE CLAMP® and mounting flanges

# X-COM®-SYSTEM

## Male Headers with Solder Pins, 5 mm Pin Spacing

### 769 Series

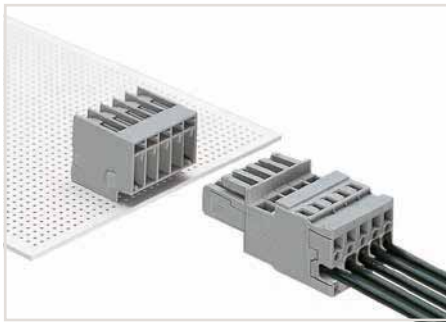

Male header with angled solder pins

#### Technical Data

Rated voltage (III / 3)	250 V
Rated surge voltage (III / 3)	4 kV
Rated voltage (III / 3) 2	500 V
Rated surge voltage (III / 3) 2	4 kV
Rated current	32 A
Approval	300 V, 20 A <b>VA</b> ; 300 V, 20 A <b>CE</b>
Pin spacing	5 mm / 0.197 inch
Insulation material	Polyamide 66 (PA 66)

Current-carrying capacity curves at visit [www.wago.com](http://www.wago.com)

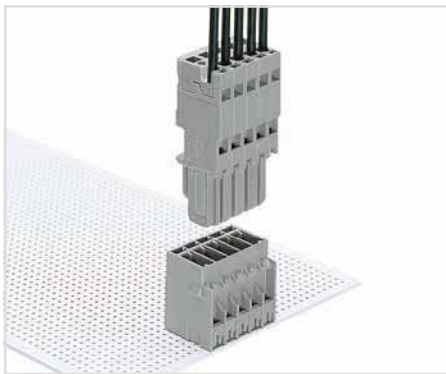

Male header with straight solder pins

6

#### Accessories (Selection)

	Item No.	Page
1-connector female plug, straight	769-102	519
1-conductor female plug, with lateral locking levers	769-102/021-000	519
2-conductor female plug	769-122	521
Coding pin, for coding female plugs	769-435	527
Mini-WSB Quick marking system, white, 10 strips with 10 markers per card, 5 mm wide markers	248-501	781

Appropriate marking system: Mini-WSB/Mini-WSB Inline, see Full Line Catalog, Volume 6

Approvals and corresponding ratings, visit [www.wago.com](http://www.wago.com)



# X-COM®-SYSTEM

## Male Headers with Solder Pins, 5 mm Pin Spacing

### 769 Series



Dimensions (in mm):

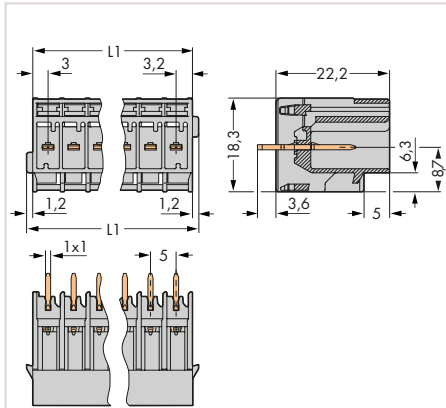

$L1 = L + 2.4 \text{ mm}$   
 $L = (\text{pole no.} - 1) \times \text{pin spacing} + 6.2 \text{ mm}$

Male header with straight solder pins, 1 x 1 mm, vertical mating direction to the PCB, gray

Pole No.	Item No.	Pack. Unit
○ 2	769-632	200
○ 3	769-633	100
○ 4	769-634	50
○ 5	769-635	50
○ 6	769-636	50
○ 7	769-637	50
○ 8	769-638	25
○ 9	769-639	25
○ 10	769-640	25
○ 11	769-641	25
○ 12	769-642	25
○ 13	769-643	25
○ 14	769-644	25
○ 15	769-645	25



Dimensions (in mm):

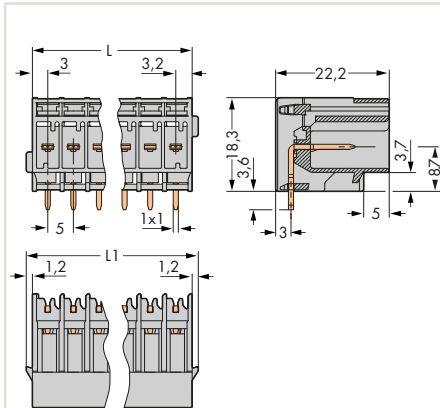

$L1 = L + 2.4 \text{ mm}$   
 $L = (\text{pole no.} - 1) \times \text{pin spacing} + 6.2 \text{ mm}$

Male header with angled solder pins, 1 x 1 mm, horizontal mating direction to the PCB, gray

Pole No.	Item No.	Pack. Unit
○ 2	769-662	200
○ 3	769-663	100
○ 4	769-664	50
○ 5	769-665	50
○ 6	769-666	50
○ 7	769-667	50
○ 8	769-668	25
○ 9	769-669	25
○ 10	769-670	25
○ 11	769-671	25
○ 12	769-672	25
○ 13	769-673	25
○ 14	769-674	25
○ 15	769-675	25



# X-COM®-SYSTEM

## Male Headers with Solder Pins and Mounting Flanges, 5 mm Pin Spacing

### 769 Series

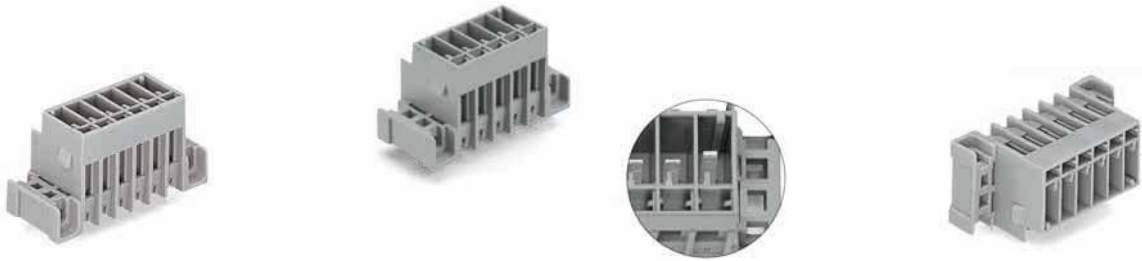

Dimensions (in mm):

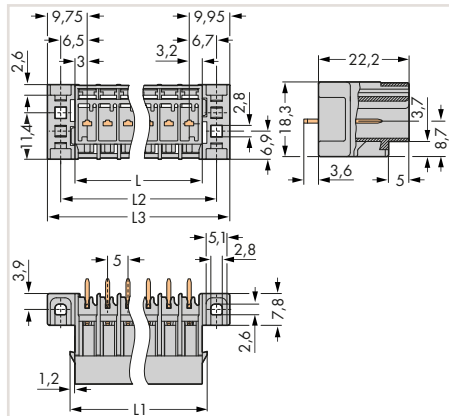

$L1 = L + 2.4 \text{ mm}$ ,  $L2 = L + 7 \text{ mm}$ ,  $L3 = L + 13.5 \text{ mm}$   
 $L = (\text{pole no.} - 1) \times \text{pin spacing} + 6.2 \text{ mm}$

Male header with straight solder pins and mounting flanges, 1 x 1 mm, vertical mating direction to the PCB, gray

Pole No.	Item No.	Pack. Unit
2	769-632/003-000	200
3	769-633/003-000	100
4	769-634/003-000	50
5	769-635/003-000	50
6	769-636/003-000	25
7	769-637/003-000	25
8	769-638/003-000	25
9	769-639/003-000	25
10	769-640/003-000	25
11	769-641/003-000	25
12	769-642/003-000	25
13	769-643/003-000	15
14	769-644/003-000	15
15	769-645/003-000	15



Dimensions (in mm):

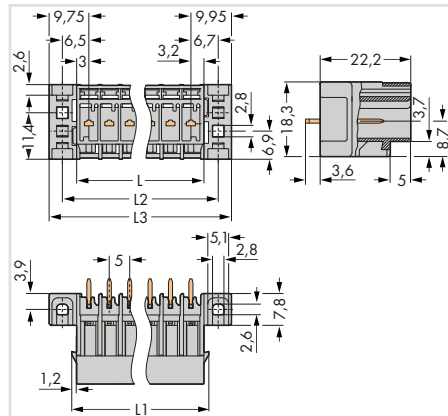

$L1 = L + 2.4 \text{ mm}$ ,  $L2 = L + 7 \text{ mm}$ ,  $L3 = L + 13.5 \text{ mm}$   
 $L = (\text{pole no.} - 1) \times \text{pin spacing} + 6.2 \text{ mm}$

Male header with preceding contact, straight solder pins and mounting flanges, 1 x 1 mm, vertical mating direction to the PCB, gray

Pole No.	Item No.	Pack. Unit
2	769-632/003-036	200
3	769-633/003-036	100
4	769-634/003-036	50
5	769-635/003-036	50
6	769-636/003-036	25



Dimensions (in mm):

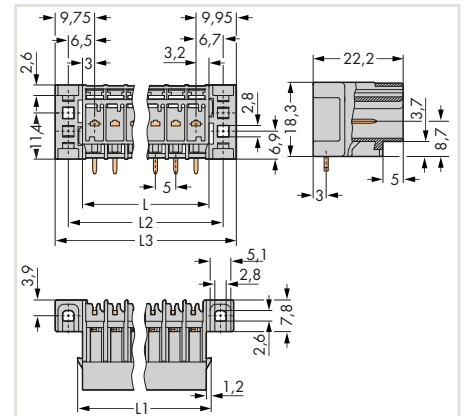

$L1 = L + 2.4 \text{ mm}$ ,  $L2 = L + 7 \text{ mm}$ ,  $L3 = L + 13.5 \text{ mm}$   
 $L = (\text{pole no.} - 1) \times \text{pin spacing} + 6.2 \text{ mm}$

Male header with angled solder pins and mounting flanges, 1 x 1 mm, horizontal mating direction to the PCB, gray

Pole No.	Item No.	Pack. Unit
2	769-662/003-000	100
3	769-663/003-000	100
4	769-664/003-000	50
5	769-665/003-000	50
6	769-666/003-000	50
7	769-667/003-000	25
8	769-668/003-000	25
9	769-669/003-000	25
10	769-670/003-000	25
11	769-671/003-000	25
12	769-672/003-000	25
13	769-673/003-000	15
14	769-674/003-000	15
15	769-675/003-000	15



# X-COM®-SYSTEM – Male Headers with Solder Pins and Feedthrough Flanges or Rivet Mounting Flanges, 5 mm Pin Spacing 769 Series



Dimensions (in mm):

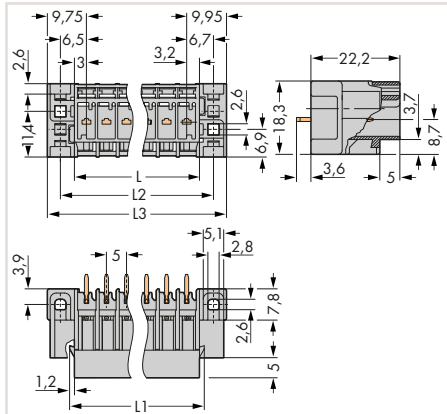

$L1 = L + 2.4 \text{ mm}$ ,  $L2 = L + 7 \text{ mm}$ ,  $L3 = L + 13.5 \text{ mm}$   
 $L = (\text{pole no.} - 1) \times \text{pin spacing} + 6.2 \text{ mm}$

Male header with straight solder pins and feedthrough flanges, 1 x 1 mm, vertical mating direction to the PCB, gray

Pole No.	Item No.	Pack. Unit
2	769-632/004-000	200
3	769-633/004-000	50
4	769-634/004-000	50
5	769-635/004-000	50
6	769-636/004-000	50
7	769-637/004-000	25
8	769-638/004-000	25
9	769-639/004-000	25
10	769-640/004-000	25
11	769-641/004-000	25
12	769-642/004-000	25
13	769-643/004-000	15
14	769-644/004-000	15
15	769-645/004-000	15



Dimensions (in mm):

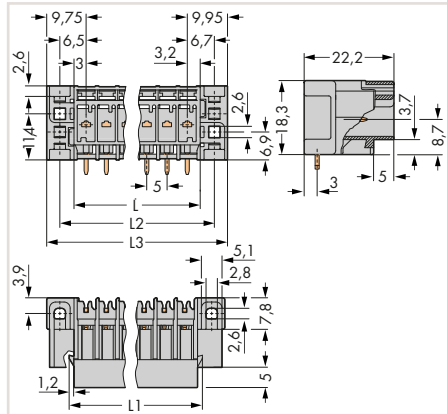

$L1 = L + 2.4 \text{ mm}$ ,  $L2 = L + 7 \text{ mm}$ ,  $L3 = L + 13.5 \text{ mm}$   
 $L = (\text{pole no.} - 1) \times \text{pin spacing} + 6.2 \text{ mm}$

Male header with angled solder pins and feedthrough flanges, 1 x 1 mm, horizontal mating direction to the PCB, gray

Pole No.	Item No.	Pack. Unit
2	769-662/004-000	200
3	769-663/004-000	100
4	769-664/004-000	50
5	769-665/004-000	50
6	769-666/004-000	50
7	769-667/004-000	50
8	769-668/004-000	25
9	769-669/004-000	25
10	769-670/004-000	25
11	769-671/004-000	25
12	769-672/004-000	25
13	769-673/004-000	25
14	769-674/004-000	15
15	769-675/004-000	15



Dimensions (in mm):

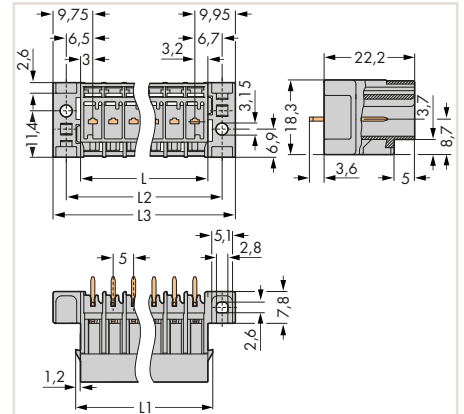

$L1 = L + 2.4 \text{ mm}$ ,  $L2 = L + 7 \text{ mm}$ ,  $L3 = L + 13.5 \text{ mm}$   
 $L = (\text{pole no.} - 1) \times \text{pin spacing} + 6.2 \text{ mm}$

Male header with straight solder pins and rivet mounting flanges, 1 x 1 mm, vertical mating direction to the PCB, gray

Pole No.	Item No.	Pack. Unit
2	769-632/007-000	200
3	769-633/007-000	50
4	769-634/007-000	50
5	769-635/007-000	50
6	769-636/007-000	50
7	769-637/007-000	25
8	769-638/007-000	25
9	769-639/007-000	25
10	769-640/007-000	25
11	769-641/007-000	25
12	769-642/007-000	25
13	769-643/007-000	15
14	769-644/007-000	15
15	769-645/007-000	15

## X-COM®-SYSTEM

### Male Headers with Solder Pins and 1-/2-Conductor Female Plugs

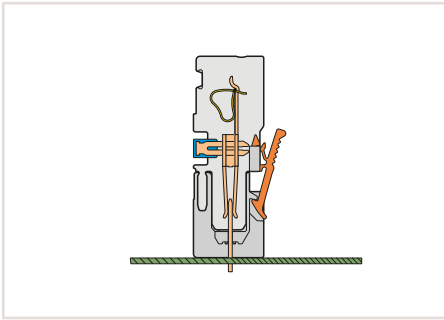

Male header with straight solder pins

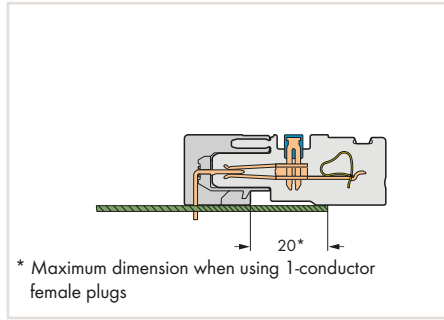

Male header with angled solder pins

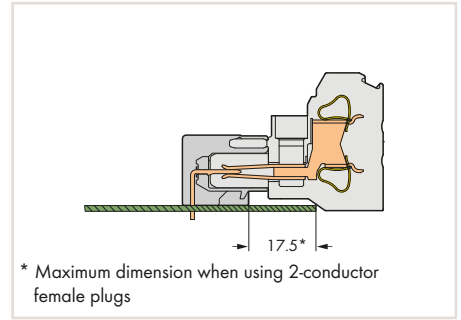

Male header with angled solder pins

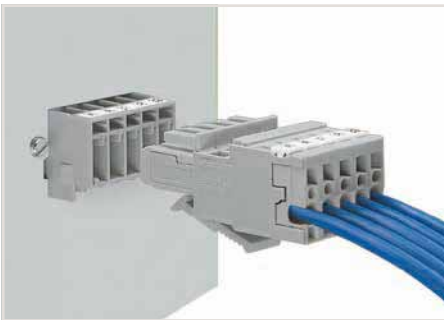

Male header with mounting flanges  
1-conductor female plug with bottom-mount locking levers

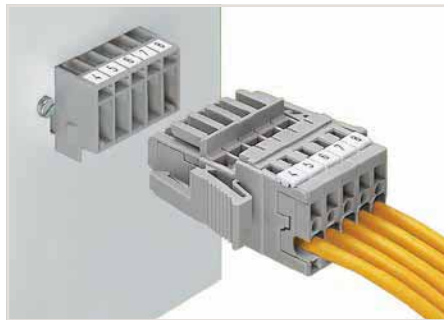

Male header with mounting flanges  
1-conductor female plug with lateral locking levers

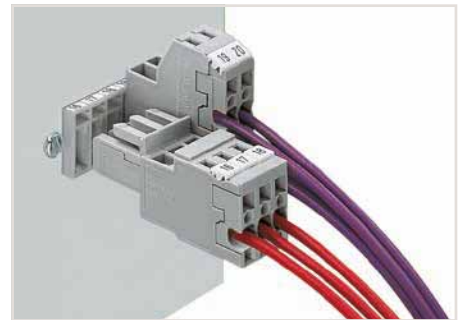

Male header with feedthrough flanges  
1-conductor female plug  
2-conductor female plug

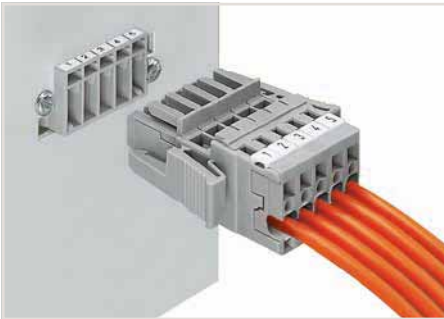

Male header and 1-conductor female plug with lateral locking levers



Mounting with 3 mm Ø blind rivets

6

# X-COM®-SYSTEM

## Cutouts for Male Headers with Solder Pins

### Cutouts for headers with fixing flanges for feedthrough applications and locking levers

Female plugs with **bottom-mounted** locking levers

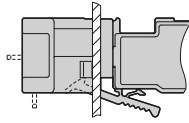

Female plug **without** locking levers

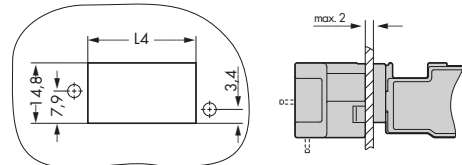

Cutouts for **2-pole** locking levers (2- to 15-pole female plugs)

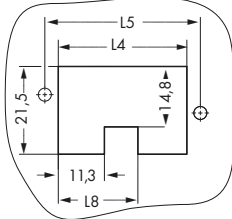

Cutouts for **single pole** locking levers

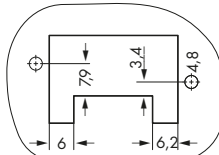

Layout for locking levers outer ...

Female plug with **lateral** locking levers

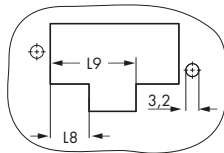
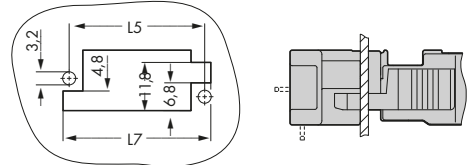

... inner

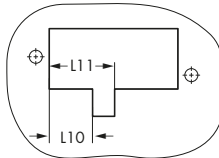

- L 4 = pole no. x pin spacing + 1.7 mm**
- L 5 = L 4 + 6.6 mm**
- L 7 = L 4 + 9.4 mm**
- L 8 = pole no. LL x pin spacing - 0.3 mm**
- L 9 = L 8 + 11.6 mm**
- L 10 = pole no. LL x pin spacing + 0.6 mm**
- L 11 = L 10 + 5.4 mm**
- Pole no. LL: Number of poles ahead of the poles attached to the locking lever**
- LL = locking lever**

## X-COM®-SYSTEM

### Female Plugs

#### 4 mm<sup>2</sup>, 769 Series



- Application examples for 1-pole female plug:**
- Phase selection in three-phase network
  - Test plug with rated current capability
  - Simplified circuit expansion – addition of base circuits requires only female plugs to be plugged in

#### Technical Data

Ratings per	IEC/EN 61984
Rated voltage (III / 3)	500 V
Rated surge voltage (III / 3)	6 kV
Rated current	32 A
<b>Connection Data</b>	
Connection technology	CAGE CLAMP®
Solid conductor	0.08 ... 4 mm <sup>2</sup> / 28 ... 12 AWG
Fine-stranded conductor	0.08 ... 4 mm <sup>2</sup> / 28 ... 12 AWG
Nominal cross section	4 mm <sup>2</sup>
Approval	300 V, 20 A ; 300 V, 20 A
Pin spacing	5 mm / 0.197 inch
Strip length	8 ... 9 mm / 0.31 ... 0.35 inch
Insulation material	Polyamide 66 (PA 66)

#### Application examples for 1-pole female plug:

- Phase selection in three-phase network
- Test plug with rated current capability
- Simplified circuit expansion – addition of base circuits requires only female plugs to be plugged in

Item no. suffixes for female plugs without lateral locking levers:

blue .../000-006  
green-yellow .../000-016

For current-carrying capacity curves, see page 534 and visit [www.wago.com](http://www.wago.com).

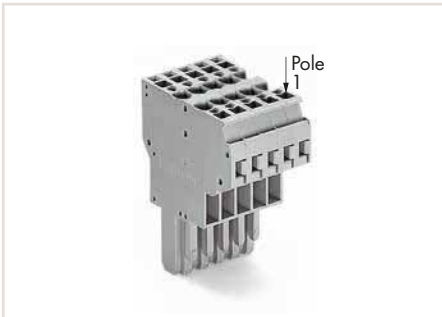

#### 2-conductor female plugs:

- Common signals from one subassembly to the other (bus structure)
- Can be used as a T-wire branch tap connection (e.g. for lighting wiring)
- Enable a higher number of connection possibilities

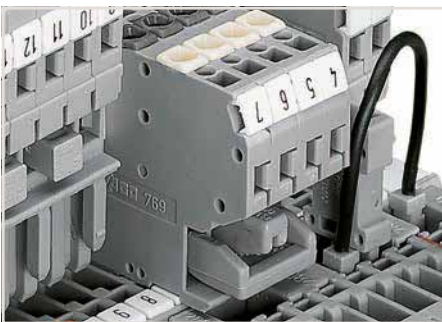

#### Commoning options of female plugs:

- After removal, commoned potentials still remain commoned
- Use of plug-in jumpers instead of additional wired jumpers
- Can be used as a "hardware" key for safety lockout
- Can also be used as a commoning jumper for sensor circuits or machine programming

Accessories for female plugs, see page 532

Appropriate marking system: Mini-WSB/Mini-WSB Inline, see Full Line Catalog, Volume 6

Approvals and corresponding ratings, visit [www.wago.com](http://www.wago.com)

#### Accessories (Selection)

	Item No.	Page
Locking lever, can be snapped on female plugs, for 1-pole female plugs	769-428	531
Operating tool, for female plugs and male connectors with CAGE CLAMP® connection	210-490	532
Operating lever, loose, for male and female connectors with CAGE CLAMP®	769-434	532
Mini-WSB Quick marking system, white, 10 strips with 10 markers per card, 5 mm wide markers	248-501	781



# X-COM®-SYSTEM

## Female Plugs with and without Lateral Locking Levers

### 4 mm², 769 Series



Dimensions (in mm):

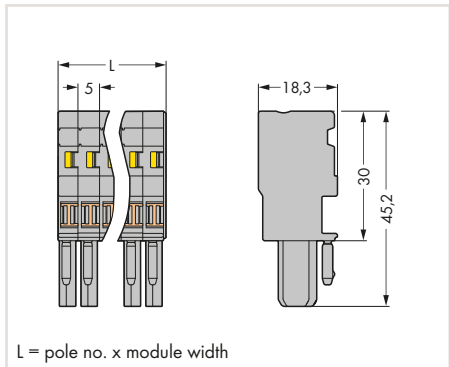

L = pole no. x module width

1-conductor female plug, straight, fits into carrier terminal blocks or male connectors, with coding fingers, can be commoned with miniature adjacent jumpers, gray

Pole No.	Item No.	Pack. Unit
1	769-101	200
2	769-102	100
3	769-103	50
4	769-104	50
5	769-105	50
6	769-106	25
7	769-107	25
8	769-108	25
9	769-109	25
10	769-110	25
11	769-111	20
12	769-112	20
13	769-113	10
14	769-114	10
15	769-115	10

Dimensions (in mm):

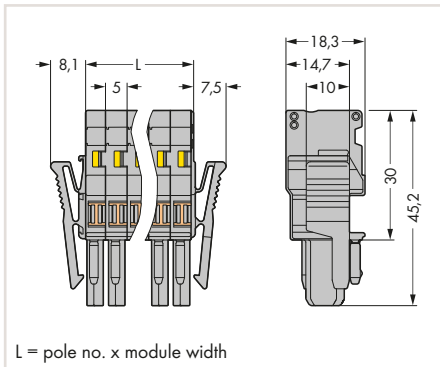

L = pole no. x module width

1-conductor female plug, with lateral locking levers, only compatible with male connectors, with coding fingers, can be commoned with miniature adjacent jumpers, gray

Pole No.	Item No.	Pack. Unit
2	769-102/021-000	50
3	769-103/021-000	25
4	769-104/021-000	25
5	769-105/021-000	25
6	769-106/021-000	25
7	769-107/021-000	25
8	769-108/021-000	20
9	769-109/021-000	20
10	769-110/021-000	10
11	769-111/021-000	10
12	769-112/021-000	10
13	769-113/021-000	10
14	769-114/021-000	10
15	769-115/021-000	10

1-conductor female plug with ground base module (green-yellow), fits into carrier terminal blocks or male connectors, with coding fingers, can be commoned with miniature adjacent jumpers

Pole No.	Item No.	Pack. Unit
3	769-103/000-036	25
4	769-104/000-036	25
5	769-105/000-036	20
6	769-106/000-036	10
7	769-107/000-036	10
8	769-108/000-036	10
9	769-109/000-036	10
10	769-110/000-036	10
11	769-111/000-036	5
12	769-112/000-036	5
13	769-113/000-036	5
14	769-114/000-036	5
15	769-115/000-036	5



Miniature adjacent jumper, insulated, I<sub>N</sub> 24 A

	Item No.	Pack. Unit
gray	769-402	100 (25)



Miniature adjacent jumper, insulated, I<sub>N</sub> 24 A

	Item No.	Pack. Unit
gray	769-402	100 (25)



Miniature adjacent jumper, insulated, I<sub>N</sub> 24 A

	Item No.	Pack. Unit
gray	769-402	100 (25)

# X-COM®-SYSTEM

## Female Plugs

### 4 mm<sup>2</sup>, 769 Series



1-conductor female plug, with ground end module (green-yellow), fits into carrier terminal blocks or male connectors, with coding fingers, can be commoned with miniature adjacent jumpers

Pole No.	Item No.	Pack. Unit
3	769-103/000-037	25
4	769-104/000-037	25
5	769-105/000-037	20
6	769-106/000-037	10
7	769-107/000-037	10
8	769-108/000-037	10
9	769-109/000-037	10
10	769-110/000-037	10
11	769-111/000-037	5
12	769-112/000-037	5
13	769-113/000-037	5
14	769-114/000-037	5
15	769-115/000-037	5

1-conductor female plug, with ground base module (green-yellow), fits into carrier terminal blocks or male connectors, with coding fingers, can be commoned with miniature adjacent jumpers, gray, blue, green-yellow

Pole No.	Item No.	Pack. Unit
3	769-103/000-038	25
4	769-104/000-038	25
5	769-105/000-038	20
6	769-106/000-038	10
7	769-107/000-038	10
8	769-108/000-038	10
9	769-109/000-038	10
10	769-110/000-038	10
11	769-111/000-038	5
12	769-112/000-038	5
13	769-113/000-038	5
14	769-114/000-038	5
15	769-115/000-038	5

1-conductor female plug, with ground end module (green-yellow), fits into carrier terminal blocks or male connectors, with coding fingers, can be commoned with miniature adjacent jumpers, green-yellow, blue, gray

Pole No.	Item No.	Pack. Unit
3	769-103/000-039	25
4	769-104/000-039	25
5	769-105/000-039	20
6	769-106/000-039	10
7	769-107/000-039	10
8	769-108/000-039	10
9	769-109/000-039	10
10	769-110/000-039	10
11	769-111/000-039	5
12	769-112/000-039	5
13	769-113/000-039	5
14	769-114/000-039	5
15	769-115/000-039	5

6



Miniature adjacent jumper, insulated, I <sub>N</sub> 24 A		
	Item No.	Pack. Unit
gray	769-402	100 (25)



Miniature adjacent jumper, insulated, I <sub>N</sub> 24 A		
	Item No.	Pack. Unit
gray	769-402	100 (25)



Miniature adjacent jumper, insulated, I <sub>N</sub> 24 A		
	Item No.	Pack. Unit
gray	769-402	100 (25)

# X-COM®-SYSTEM

## 2-Conductor and 1-Conductor Female Plugs, Angled

### 4 mm<sup>2</sup>, 769 Series

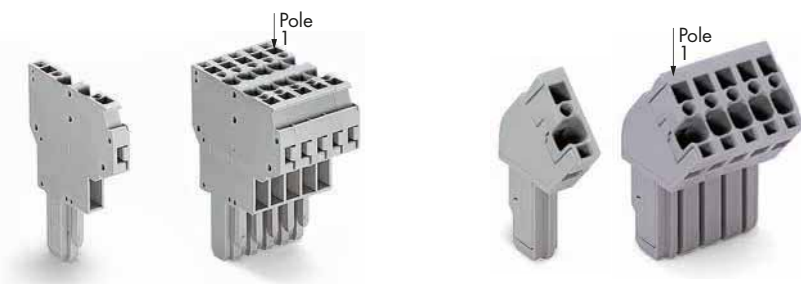

Dimensions (in mm):

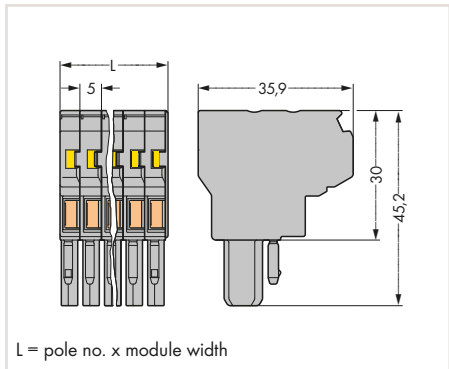

Dimensions (in mm):

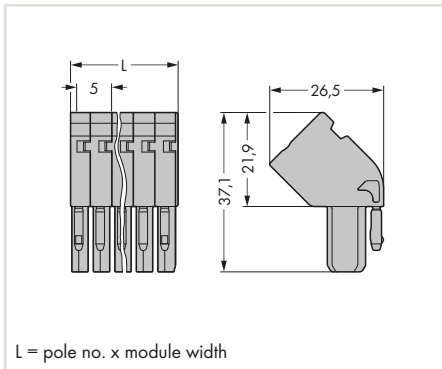

2-conductor female plug, fits into carrier terminal blocks or male connectors, with coding fingers, can be commoned with adjacent and staggered jumpers, gray

Pole No.	Item No.	Pack. Unit
1	769-121	100
2	769-122	50
3	769-123	25
4	769-124	25
5	769-125	20
6	769-126	10
7	769-127	10
8	769-128	10
9	769-129	10
10	769-130	10
11	769-131	5
12	769-132	5
13	769-133	5
14	769-134	5
15	769-135	5

1-conductor female plug, angled, fits into carrier terminal blocks or male connectors, with coding fingers, gray

Pole No.	Item No.	Pack. Unit
1	769-101/022-000	200
2	769-102/022-000	100
3	769-103/022-000	50
4	769-104/022-000	50
5	769-105/022-000	50
6	769-106/022-000	25
7	769-107/022-000	25
8	769-108/022-000	25
9	769-109/022-000	25
10	769-110/022-000	25
11	769-111/022-000	20
12	769-112/022-000	20
13	769-113/022-000	10
14	769-114/022-000	10
15	769-115/022-000	10



Adjacent jumper, insulated, I<sub>N</sub> = I<sub>N</sub> terminal block

	Item No.	Pack. Unit
gray	280-402	200 (25)

## X-COM®-SYSTEM

### Female Plugs for Self-Assembly

#### 4 mm<sup>2</sup>, 769 Series



1-conductor end module, with coding finger, can be commoned with miniature adjacent jumpers

Color	Item No.	Pack. Unit
○ gray	769-503	250
● blue	769-503/000-006	250
● green-yellow	769-503/000-016	250

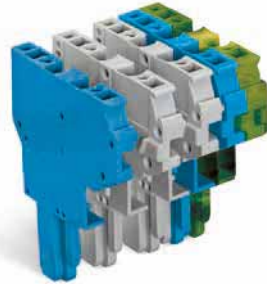

2-conductor end module, with coding finger, can be commoned with adjacent and staggered jumpers

Color	Item No.	Pack. Unit
○ gray	769-506	250
● blue	769-506/000-006	250
● green-yellow	769-506/000-016	250



1-conductor end module, angled, with coding finger

Color	Item No.	Pack. Unit
○ gray	769-515	250
● blue	769-515/000-006	250
● green-yellow	769-515/000-016	250

1-conductor center module, with coding finger, can be commoned with miniature adjacent jumpers

Color	Item No.	Pack. Unit
○ gray	769-502	250
● blue	769-502/000-006	250
● green-yellow	769-502/000-016	250

2-conductor center module, with coding finger, can be commoned with adjacent and staggered jumpers

Color	Item No.	Pack. Unit
○ gray	769-505	250
● blue	769-505/000-006	250
● green-yellow	769-505/000-016	250

1-conductor center module, angled, with coding finger

Color	Item No.	Pack. Unit
○ gray	769-513	250
● blue	769-513/000-006	250
● green-yellow	769-513/000-016	250

1-conductor base module, with integrated end plate, with coding finger, can be commoned with miniature adjacent jumpers

Color	Item No.	Pack. Unit
○ gray	769-501	250
● blue	769-501/000-006	250
● green-yellow	769-501/000-016	250

2-conductor base module, with integrated end plate, with coding finger, can be commoned with adjacent and staggered jumpers

Color	Item No.	Pack. Unit
○ gray	769-504	250
● blue	769-504/000-006	250
● green-yellow	769-504/000-016	250

1-conductor base module, angled, with integrated end plate, with coding finger

Color	Item No.	Pack. Unit
○ gray	769-512	250
● blue	769-512/000-006	250
● green-yellow	769-512/000-016	250



Miniature adjacent jumper, insulated, I <sub>N</sub> 24 A		
Color	Item No.	Pack. Unit
gray	769-402	100 (25)



Adjacent jumper, insulated, I <sub>N</sub> = I <sub>N</sub> terminal block		
Color	Item No.	Pack. Unit
gray	280-402	200 (25)

6

**Customizing Modular Female Plugs**

WAGO's modular X-COM®-SYSTEM female plugs can be customized for applications requiring varying numbers of poles (e.g., when designing prototypes).

**Modules and Pole Numbers**

A customized X-COM®-SYSTEM female plug consists of:

- One base module with an integrated end plate
- Up to 13 center modules (corresponding to a 15-pole female plug = maximum pole number)
- One end module

**Intended Use**

According to EN 61984, pluggable connectors without a current interrupting capacity shall not be mated or unmated when live or under load.

**Assembly**

The appropriate mounting tool shall be used in order to guarantee that the individual modules are properly attached to each other without damaging the locking latches.



End module



Center module



Base module

6

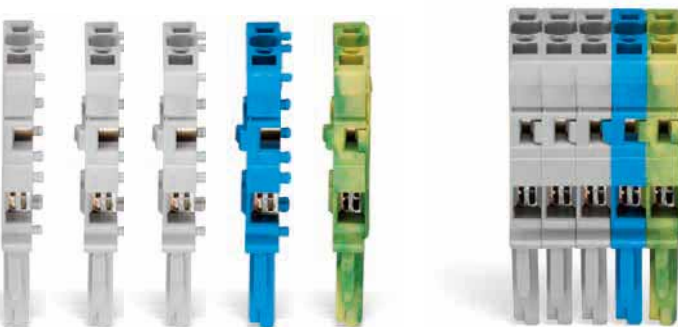
**Example: 5-Pole, 1-Conductor Female Plug**

Base module with integrated end plate  
769-501/000-016

Center module  
769-502/000-006

Center modules  
769-502

End module  
769-503

# X-COM®-SYSTEM – Snap-on Type Strain Relief Housings for Female Plugs and Male Connectors with CAGE CLAMP® Connection 769 Series

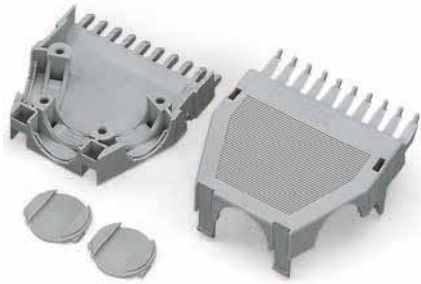
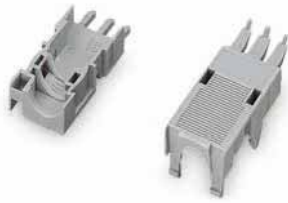

Snap-on type strain relief housing, consists of strain relief support and housing, gray

Pole No.	Item No.	Pack. Unit
○ 2	769-1602	25
○ 3	769-1603	25
○ 4	769-1604	25
○ 5	769-1605	25

Snap-on type strain relief housing, consists of strain relief support and housing, gray

Pole No.	Item No.	Pack. Unit
○ 6	769-1606	25
○ 7	769-1607	25
○ 8	769-1608	25
○ 9	769-1609	25
○ 10	769-1610	25
○ 11	769-1611	25
○ 12	769-1612	25
○ 13	769-1613	25
○ 14	769-1614	25
○ 15	769-1615	25

Cable clamp, for strain relief

	Item No.	Pack. Unit
7 or more poles	209-174	25

Mounting screw, for cable clamp

	Item No.	Pack. Unit
7 or more poles	209-173	50

6

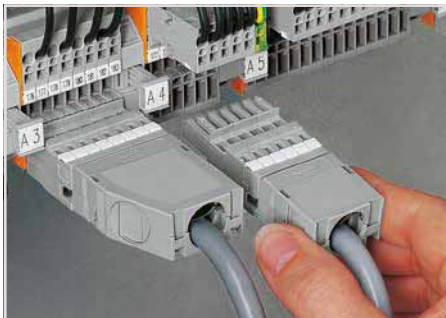

Application:  
Snap-on type strain relief housings for 769 Series

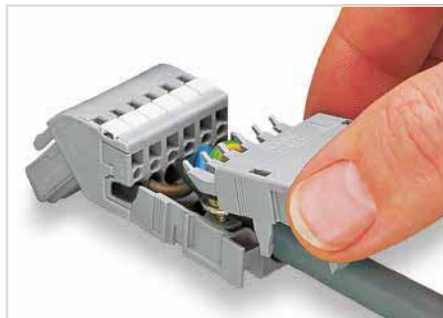

Snapping on a strain relief housing.

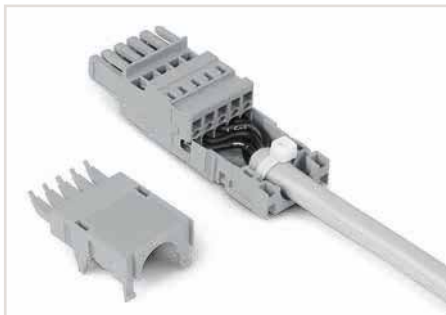

2- to 5-pole strain relief housings feature one cable outlet (rear side).  
6- to 9-pole strain relief housings feature two cable outlets and one cover.  
10- to 16-pole strain relief housings feature three cable outlets and two covers.

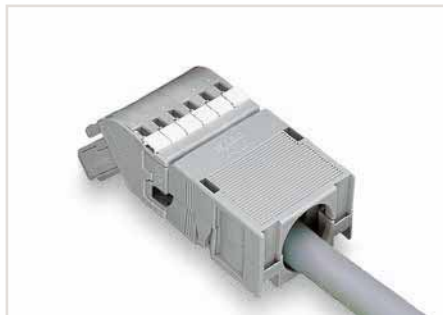



# X-COM®-SYSTEM – Snap-on Type Strain Relief Housings for Female Plugs and Male Connectors with CAGE CLAMP® Connection 769 Series

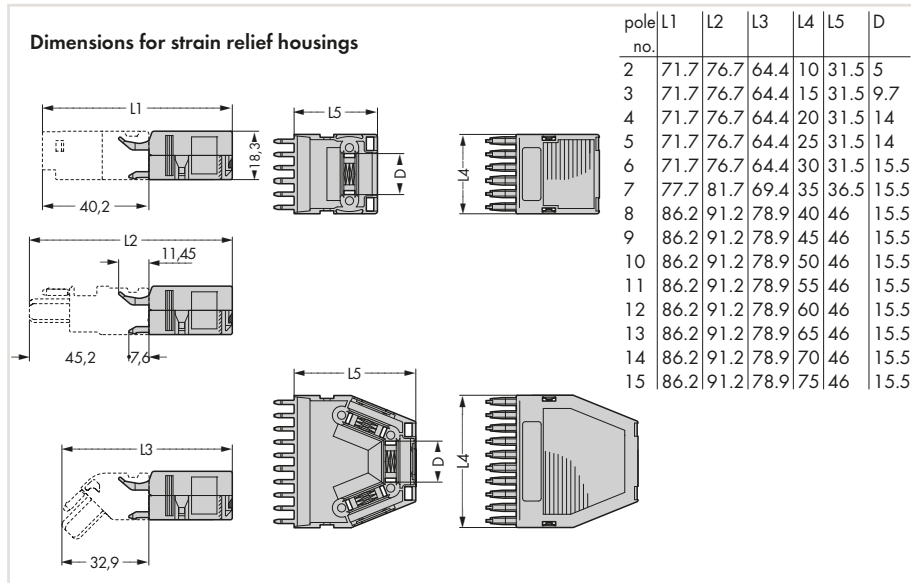

Dimensions (in mm):

## X-COM®-SYSTEM

### Accessories for 769 Series Carrier Terminal Blocks

#### Commoning, Mounting, Marking and Testing



Adjacent jumper, insulated, $I_N = I_N$ terminal block		
Color	Item No.	Pack. Unit
gray	280-402	200 (25)
yellow-green	280-422	200 (25)



Alternate jumper, insulated, $I_N = I_N$ terminal block		
Color	Item No.	Pack. Unit
gray	280-409	100 (25)



 Staggered jumpers, see page 468

Note: Push down the staggered jumper until fully inserted.  
Using staggered jumpers reduces the maximum rated voltage to 275 V.

Rated voltage (III / 3)	400 V
Rated surge voltage (III / 3)	6 kV

Staggered jumper, insulated, 5 mm wide, $I_N$ 24 A, gray		
	Item No.	Pack. Unit
1 to 2	780-452	100 (25)
1 to 3	780-453	100 (25)
1 to 4	780-454	100 (25)
1 to 5	780-455	50 (25)
1 to 6	780-456	50 (25)
1 to 7	780-457	50 (25)
1 to 8	780-458	50 (25)



 Push-in type wire jumpers, see page 469

Push-in type wire jumper, insulated, 0.75 mm <sup>2</sup> conductor cross section, $I_N$ 9 A		
	Item No.	Pack. Unit
L = 60 mm	249-125	10
L = 110 mm	249-126	10
L = 250 mm	249-127	10



End and intermediate plate, 1.1 mm thick			
Suitable for:	Color	Item No.	Pack. Unit
769-176	orange	769-308	100 (25)
769-232	gray	769-307	100 (25)
769-238/281-411			
769-239/281-413			



End and intermediate plate, 1.1 mm thick			
Suitable for:	Color	Item No.	Pack. Unit
769-156	orange	769-306	100 (25)
769-222	gray	769-305	100 (25)
769-228/281-411			
769-229/281-413			



End and intermediate plate, 1.1 mm thick			
Suitable for:	Color	Item No.	Pack. Unit
769-171	orange	769-304	100 (25)
	gray	769-303	100 (25)



End and intermediate plate, 1.1 mm thick			
Suitable for:	Color	Item No.	Pack. Unit
769-151	orange	769-302	100 (25)
	gray	769-301	100 (25)

6

## X-COM®-SYSTEM

## Accessories for 769 Series Carrier Terminal Blocks

## Commoning, Mounting, Marking and Testing



End and intermediate plate, 1.1 mm thick			
Suitable for:	Color	Item No.	Pack. Unit
769-251	orange	769-321	100 (25)
	gray	769-320	100 (25)



End and intermediate plate, 1.1 mm thick			
Suitable for:	Color	Item No.	Pack. Unit
769-214	orange	769-316	100 (25)
	gray	769-315	100 (25)



End and intermediate plate, 1.1 mm thick			
Suitable for:	Color	Item No.	Pack. Unit
769-212	orange	769-312	100 (25)
769-218/281-411	gray	769-311	100 (25)
769-219/281-413			



Separator, oversized, 1.1 mm thick			
Suitable for:	Color	Item No.	Pack. Unit
769-212	orange	769-314	100 (25)
769-218/281-411	gray		
769-219/281-413			



End and intermediate plate, 1.1 mm thick			
Suitable for:	Color	Item No.	Pack. Unit
769-202	orange	769-310	100 (25)
769-208/281-411	gray	769-309	100 (25)
769-209/281-413			



Separator, oversized, 1.1 mm thick			
Suitable for:	Color	Item No.	Pack. Unit
769-202	orange	769-313	100 (25)
769-208/281-411	gray		
769-209/281-413			



End and intermediate plate, 1.1 mm thick			
Suitable for:	Color	Item No.	Pack. Unit
769-242	orange	769-318	100 (25)
769-191	gray	769-317	100 (25)



Separator, oversized, 1.1 mm thick			
Suitable for:	Color	Item No.	Pack. Unit
769-242	orange	769-319	100 (25)
769-191			



Coding pin, for coding female plugs			
Color		Item No.	Pack. Unit
orange		769-435	100 (25)



Pin cover, with Mini-WSB marker slot			
Color		Item No.	Pack. Unit
gray		769-438	100 (25)
orange		769-439	100 (25)

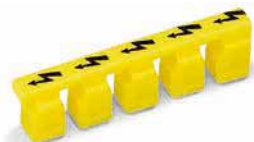

Protective warning marker, with black high-voltage symbol, for 5 terminal blocks			
Color		Item No.	Pack. Unit
yellow		280-415	100 (25)

## X-COM®-SYSTEM

## Accessories for 769 Series Carrier Terminal Blocks

## Commoning, Mounting, Marking and Testing



Insulation stop, 5 pcs/strip, 0.08 ... 0.2 mm <sup>2</sup> "s" (0.14 mm <sup>2</sup> "f-st")			
Suitable for:	Color	Item No.	Pack. Unit
Carrier terminal blocks with conductor connection	white	769-470	200 (25)



Insulation stop, 5 pcs/strip, 0.25 ... 0.5 mm <sup>2</sup>			
Suitable for:	Color	Item No.	Pack. Unit
Carrier terminal blocks with conductor connection	light gray	769-471	200 (25)



Insulation stop, 5 pcs/strip, 0.75 ... 1 mm <sup>2</sup>			
Suitable for:	Color	Item No.	Pack. Unit
Carrier terminal blocks with conductor connection	dark gray	769-472	200 (25)



Disconnect lock, for disconnect tab used on disconnect terminal blocks (280/281 and 769 Series)			
Suitable for:	Color	Item No.	Pack. Unit
Disconnect terminal blocks, 280 and 281 Series	red	709-170	200 (25)

6



Power must be switched off when installing the test plug adapter. The safety rules for working on live installations must be observed.

Test plug adapter, 8.3 mm wide, for 4 mm Ø test plug, for 1.5 ... 10 mm <sup>2</sup> terminal blocks			
Color	Item No.	Pack. Unit	
gray	209-170	50 (25)	



Power must be switched off when installing the test plug adapter. The safety rules for working on live installations must be observed.

Test plug adapter, 5 mm wide, for 210-137 Test Plug (2.3 mm Ø), for 1.5 ... 4 mm <sup>2</sup> terminal blocks			
Color	Item No.	Pack. Unit	
gray	280-404	100 (25)	



Test voltage	400 V
Test current	6 A

Test plug module, snaps together, for all WAGO 280 and 780 Series Rail-Mount Terminal Blocks with jumper slots in the current bar Module width 5 mm			
Color	Item No.	Pack. Unit	
gray	280-418	100 (25)	



Spacer module, snaps together, bridges terminal blocks Module width 5 mm			
Color	Item No.	Pack. Unit	
gray	280-419	100 (25)	



Power must be switched off when installing the test plug adapter. The safety rules for working on live installations must be observed.

Test voltage	630 V
Test current	6 A

B-type test plug module, snaps together Module width 5 mm			
Color	Item No.	Pack. Unit	
gray	249-106	100 (25)	



B-type spacer module, snaps together, bridges commoned terminal blocks Module width 5 mm			
Color	Item No.	Pack. Unit	
gray	249-107	100 (25)	

## X-COM®-SYSTEM

### Accessories for 870 Series Carrier Terminal Blocks

#### Commoning, Mounting, Marking and Testing



 Push-in type jumper bars, see page 498

#### Push-in type jumper bar, insulated, I<sub>N</sub> 18 A, light gray

	Item No.	Pack. Unit
2-way	870-402	200 (25)
3-way	870-403	200 (25)
4-way	870-404	100 (25)
5-way	870-405	100 (25)
6-way	870-406	100 (25)
7-way	870-407	100 (25)
8-way	870-408	100 (25)
9-way	870-409	100 (25)
10-way	870-410	50 (25)

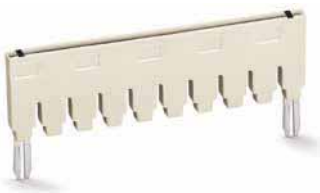

#### Push-in type jumper bar, insulated, I<sub>N</sub> 18 A, light gray

	Item No.	Pack. Unit
1 to 3	870-433	200 (25)
1 to 4	870-434	200 (25)
1 to 5	870-435	100 (25)
1 to 6	870-436	100 (25)
1 to 7	870-437	100 (25)
1 to 8	870-438	100 (25)
1 to 9	870-439	100 (25)
1 to 10	870-440	50 (25)



#### Ready-made push-in type jumper bar, insulated, I<sub>N</sub> 18 A, light gray

	Item No.	Pack. Unit
1-3-5	870-405/011-000	100 (25)
1-3-5-7	870-407/011-000	100 (25)
1-3-5-7-9	870-409/011-000	100 (25)



#### End and intermediate plate, 1 mm thick

Suitable for:	Color	Item No.	Pack. Unit
870-101	orange	870-119	100 (25)
	gray	870-118	100 (25)



#### End and intermediate plate, 1 mm thick

Suitable for:	Color	Item No.	Pack. Unit
870-151	orange	870-169	100 (25)
	gray	870-168	100 (25)



#### End and intermediate plate, 1 mm thick

Suitable for:	Color	Item No.	Pack. Unit
870-131	orange	870-149	100 (25)
	gray	870-148	100 (25)



#### Coding pin, for coding female plugs

Color	Item No.	Pack. Unit
orange	769-435	100 (25)



#### Pin cover, with Mini-WSB marker slot

Color	Item No.	Pack. Unit
gray	769-438	100 (25)
orange	769-439	100 (25)

## X-COM®-SYSTEM

### Accessories for 870 Series Carrier Terminal Blocks

#### Commoning, Mounting, Marking and Testing



Protective warning marker, with black high-voltage symbol, for 5 terminal blocks		
Color	Item No.	Pack. Unit
yellow	280-405	100 (25)



Insulation stop, 5 pcs/strip, 0.08 ... 0.2 mm <sup>2</sup> "s" (0.14 mm <sup>2</sup> "f-st")		
Color	Item No.	Pack. Unit
white	280-470	200 (25)



Insulation stop, 5 pcs/strip, 0.25 ... 0.5 mm <sup>2</sup>		
Color	Item No.	Pack. Unit
light gray	280-471	200 (25)



Insulation stop, 5 pcs/strip, 0.75 ... 1 mm <sup>2</sup>		
Color	Item No.	Pack. Unit
dark gray	280-472	200 (25)



## X-COM®-SYSTEM

### Accessories, 769 Series Female Plugs

#### Commoning, Mounting, Marking and Testing



Miniature adjacent jumper, insulated, I <sub>N</sub> 24 A			
Suitable for:	Color	Item No.	Pack. Unit
769-101	gray	769-402	100 (25)
769-102/021-000			



Jumper cover, for 1-conductor female plugs, for 5 poles			
Suitable for:	Color	Item No.	Pack. Unit
769-101	gray	769-436	100 (25)
769-102/021-000			



Adjacent jumper, insulated, I <sub>N</sub> = I <sub>N</sub> terminal block			
Suitable for:	Color	Item No.	Pack. Unit
769-121	gray	280-402	200 (25)



Alternate jumper, insulated, I <sub>N</sub> = I <sub>N</sub> terminal block			
Suitable for:	Color	Item No.	Pack. Unit
769-121	gray	280-409	100 (25)



 Staggered jumpers,  
see page 518

Note: Push down the staggered jumper until fully inserted.  
Using staggered jumpers reduces the maximum rated voltage to 275 V.

Rated voltage (III / 3)	400 V
Rated surge voltage (III / 3)	6 kV

Staggered jumper, insulated, 5 mm wide, I <sub>N</sub> 24 A, gray		
	Item No.	Pack. Unit
1 to 2	780-452	100 (25)
1 to 3	780-453	100 (25)
1 to 4	780-454	100 (25)
1 to 5	780-455	50 (25)
1 to 6	780-456	50 (25)
1 to 7	780-457	50 (25)
1 to 8	780-458	50 (25)

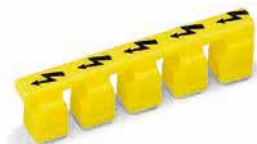

Protective warning marker, with black high-voltage symbol, for 5 terminal blocks		
Color	Item No.	Pack. Unit
yellow	280-415	100 (25)



Locking lever, can be snapped on female plugs, for female plugs with 2 poles and more		
Color	Item No.	Pack. Unit
orange	769-431	100 (25)
gray	769-430	100 (25)



Locking lever, can be snapped on female plugs, for 1-pole female plugs		
Color	Item No.	Pack. Unit
gray	769-428	100 (25)
orange	769-429	100 (25)

**X-COM®-SYSTEM****Accessories, 769 Series Female Plugs****Commoning, Mounting, Marking and Testing**

Strain relief plate, gray		
	Item No.	Pack. Unit
1-pole	769-410	100 (25)
2 ... 3 poles	769-411	100 (25)
4 ... 5 poles	769-412	100 (25)



Strain relief plate, gray		
	Item No.	Pack. Unit
6 ... 9 poles	769-413	100 (25)
10 ... 15 poles	769-414	100 (25)



Insulation stop, 5 pcs/strip, 0.08 ... 0.2 mm² "s" (0.14 mm² "f-st")		
Color	Item No.	Pack. Unit
white	769-470	200 (25)



Insulation stop, 5 pcs/strip, 0.25 ... 0.5 mm²		
Color	Item No.	Pack. Unit
light gray	769-471	200 (25)



Insulation stop, 5 pcs/strip, 0.75 ... 1 mm²		
Color	Item No.	Pack. Unit
dark gray	769-472	200 (25)



Operating lever, loose, for male and female connectors with CAGE CLAMP® connection		
	Item No.	Pack. Unit
	769-434	2000 (100)



Operating tool, for female plugs and male connectors with CAGE CLAMP® connection		
	Item No.	Pack. Unit
	210-490	1

6



## X-COM®-SYSTEM

### 1-Conductor/1-Pin and 2-Pin Carrier Terminal Blocks and 1-Conductor Female Plugs Current-Carrying Capacity Curves

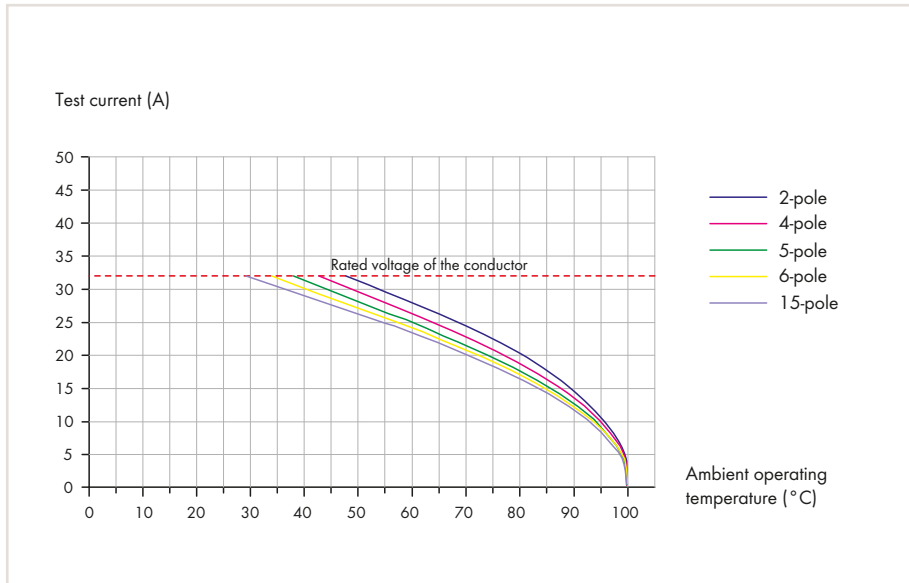

1-conductor/1-pin carrier terminal block (769-176)  
Conductor cross-section: 4 mm<sup>2</sup>

1-conductor female plugs (769-102 to 769-115)  
Conductor cross-section: 4 mm<sup>2</sup>  
Conductor loop length: 1 m

6

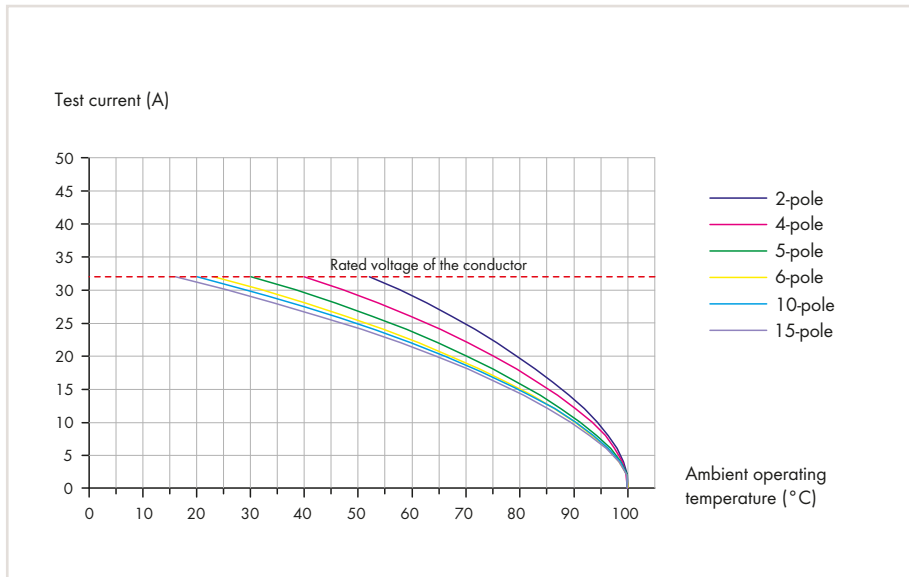

2-pin carrier terminal block (769-156)

1-conductor female plugs (769-102 to 769-115)  
Conductor cross-section: 4 mm<sup>2</sup>  
Conductor loop length: 1 m

# X-COM®-SYSTEM

## 2-Conductor/2-Pin and 4-Pin Carrier Terminal Blocks and 1-Conductor Female Plugs Current-Carrying Capacity Curves

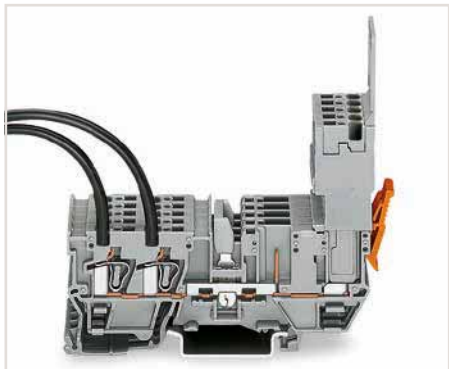
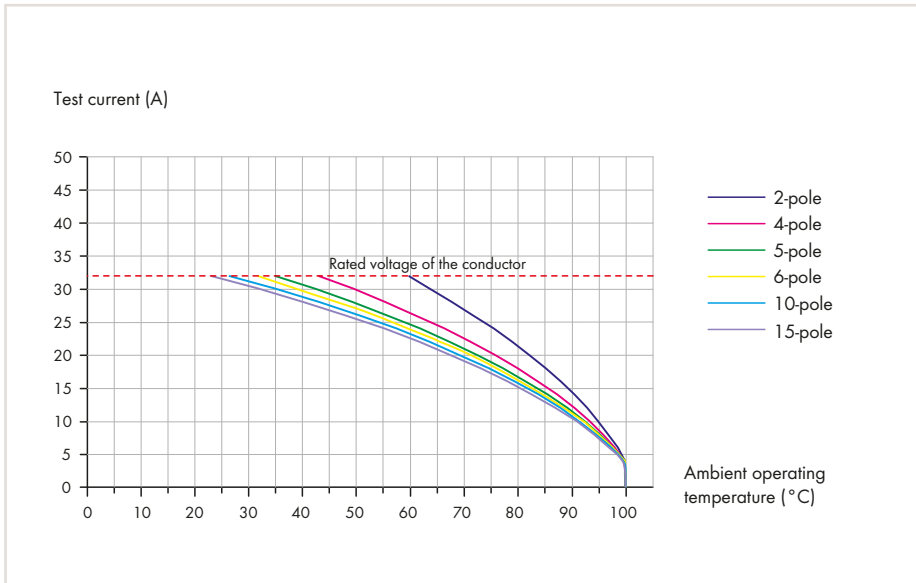

2-conductor/2-pin carrier terminal block (769-171)  
Conductor cross-section: 4 mm<sup>2</sup>

1-conductor female plugs (769-102 to 769-115)  
Conductor cross-section: 4 mm<sup>2</sup>  
Conductor loop length: 1 m

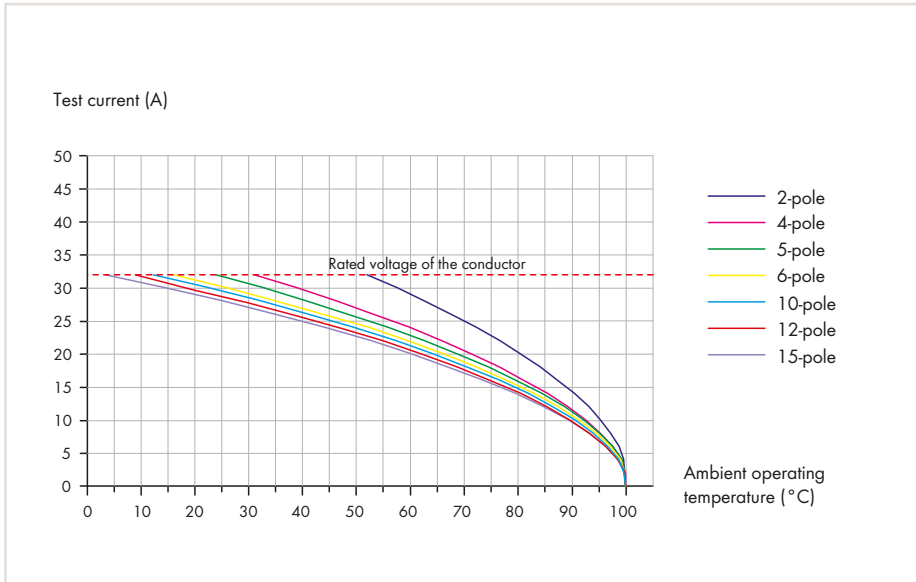

4-pin carrier terminal block (769-151)

1-conductor female plugs (769-102 to 769-115)  
Conductor cross-section: 4 mm<sup>2</sup>  
Conductor loop length: 1 m

6

## X-COM®-SYSTEM

### Male Headers with Straight and Angled Solder Pins and 1-Conductor Female Plugs Current-Carrying Capacity Curves

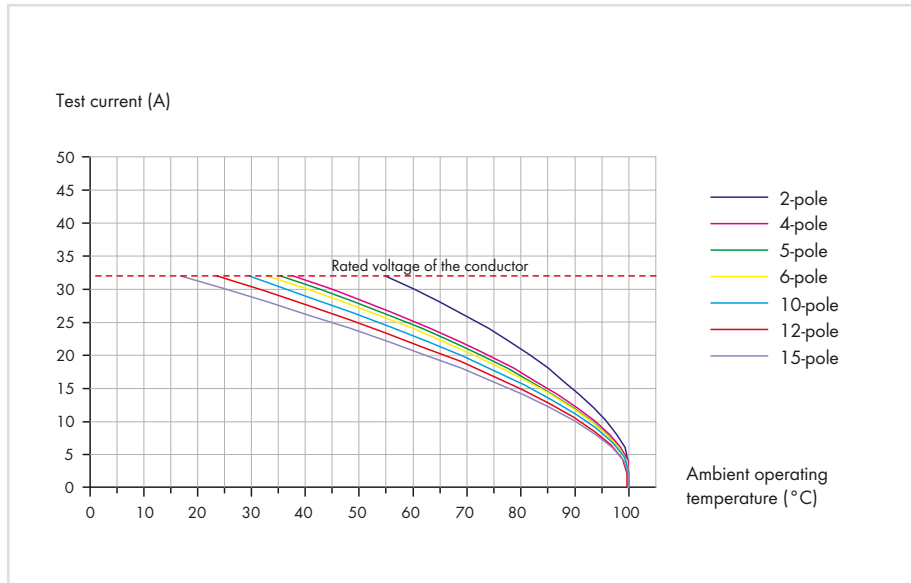

Male headers with straight solder pins (769-632 to 769-645)

1-conductor female plugs (769-102 to 769-115)  
Conductor cross-section: 4 mm<sup>2</sup>  
Conductor loop length: 1 m

6

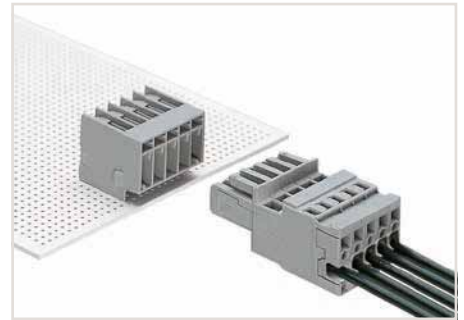
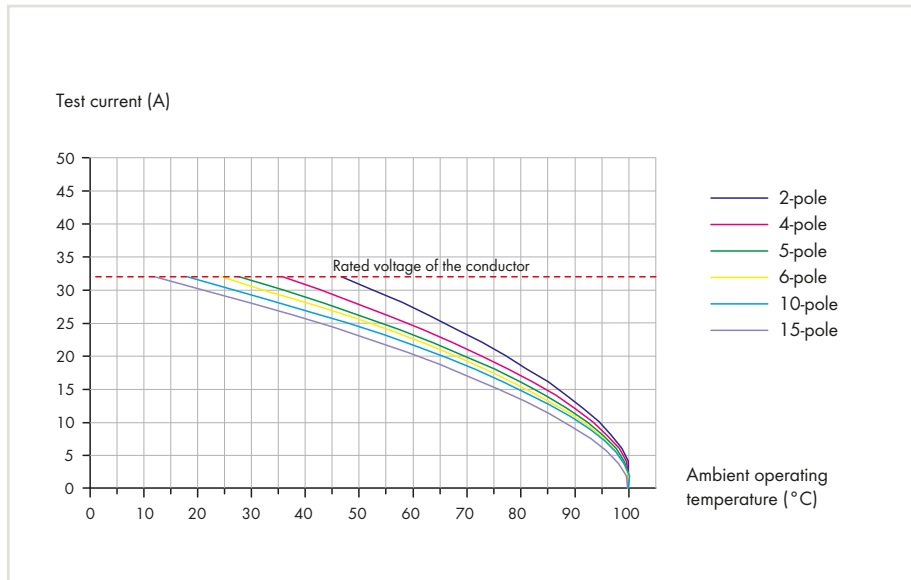

Male headers with angled solder pins (769-662 to 769-675)

1-conductor female plugs (769-102 to 769-115)  
Conductor cross-section: 4 mm<sup>2</sup>  
Conductor loop length: 1 m



# X-COM®-SYSTEM

## Male Connectors with CAGE CLAMP® Connection and 1-Conductor Female Plugs Current-Carrying Capacity Curves

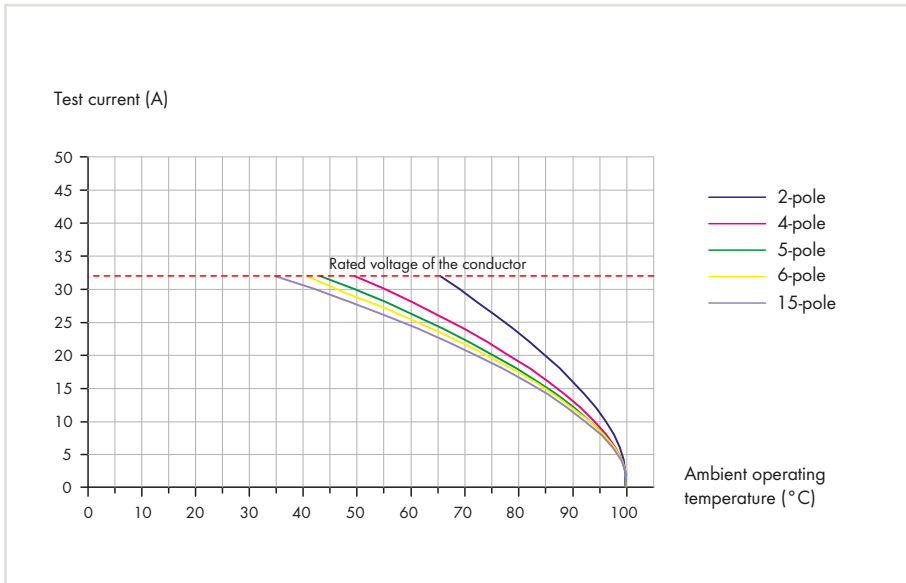





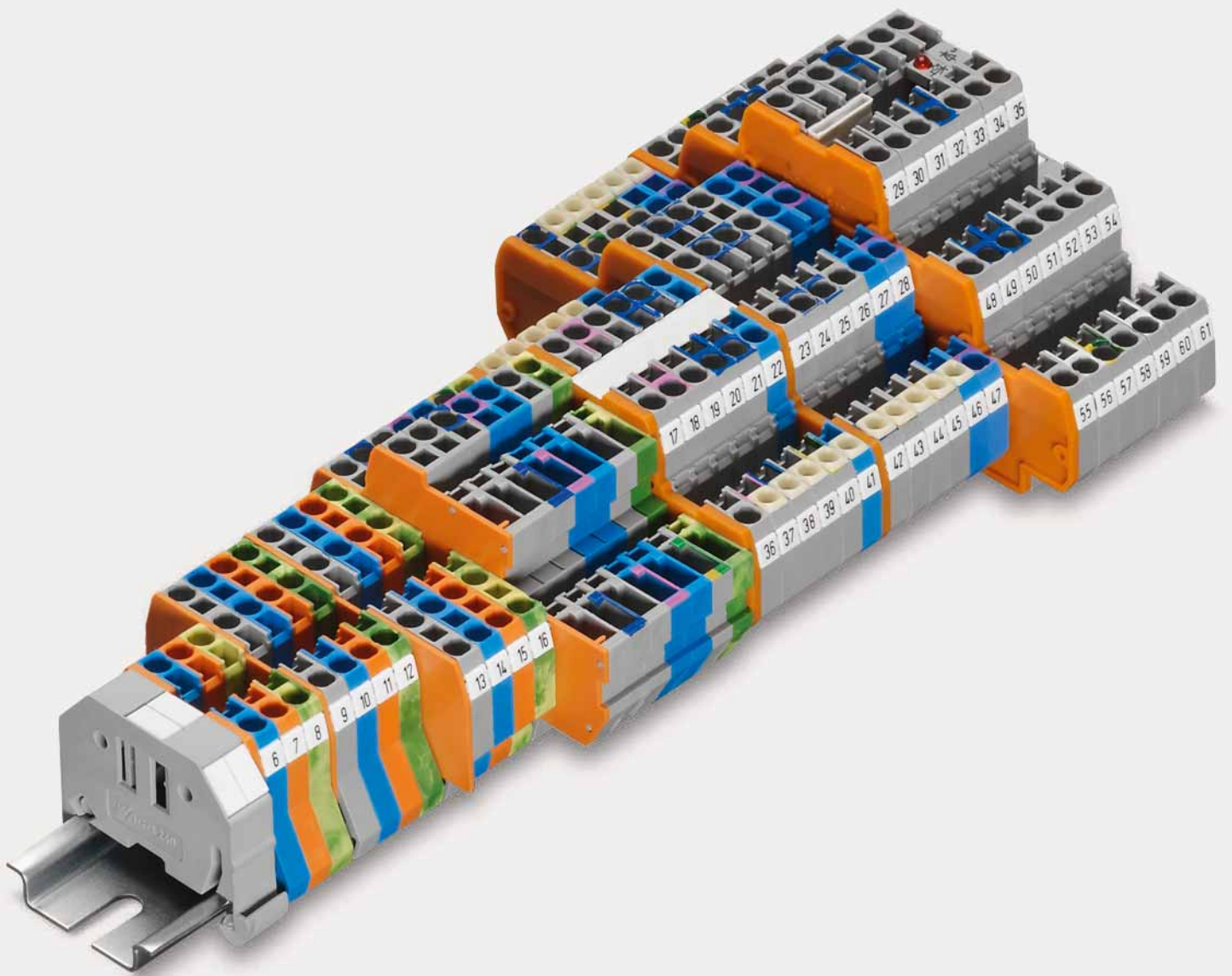

Male connectors with CAGE CLAMP® connection (769-602 to 769-615)  
Conductor cross-section: 4 mm<sup>2</sup>

1-conductor female plugs (769-102 to 769-115)  
Conductor cross-section: 4 mm<sup>2</sup>  
Conductor loop length: 1 m

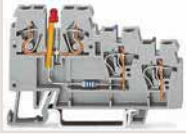

**Rail-Mount Terminal Blocks, Miniature  
Rail-Mount Terminal Blocks, Compact**

## Miniature and Compact Rail-Mount Terminal Blocks Front-Entry Wiring

			Page
	<b>Through, Ground Conductor and Ex Terminal Blocks for DIN-35 and DIN-15 Rails</b> 0.08 ... 2.5 mm <sup>2</sup> (28 ... 12 AWG)	264 Series	542
	<b>Through, Ground Conductor and Ex Terminal Blocks for DIN-35 and DIN-15 Rails</b> 0.08 ... 2.5 (4 "f-st") mm <sup>2</sup> (28 ... 12 AWG)	870 Series	550
	<b>Multilevel Rail-Mount Terminal Blocks</b> 0.08 ... 2.5 (4 "f-st") mm <sup>2</sup> (28 ... 12 AWG)	870 Series	554
	<b>Multilevel Diode and LED Terminal Blocks</b> 0.08 ... 2.5 (4 "f-st") mm <sup>2</sup> (28 ... 12 AWG)	870 Series	560
	<b>Sensor and Actuator Terminal Blocks</b> 0.08 ... 2.5 mm <sup>2</sup> (28 ... 12 AWG)	270 Series	572
	<b>Accessories for Rail-Mount Terminal Blocks</b>	870 Series	567

## Miniature Rail-Mount Terminal Blocks for DIN-15 and DIN-35 Rails, 264 Series Description and Installation

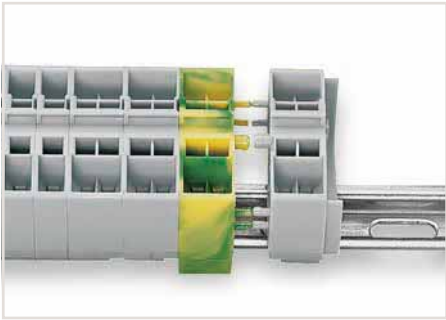

Quick assembly keys prevent reverse mounting.

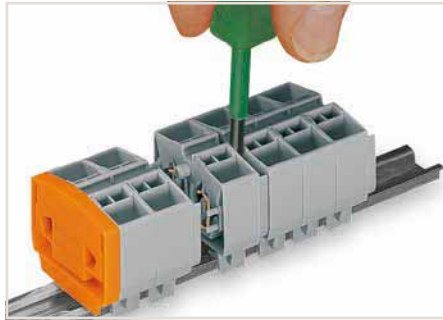

Separate terminal strip and slide individual terminal block laterally.



Remove terminal block from the carrier rail with a levering action.



Commoning with comb-style jumper bar.



Commoning with comb-style jumper bar.

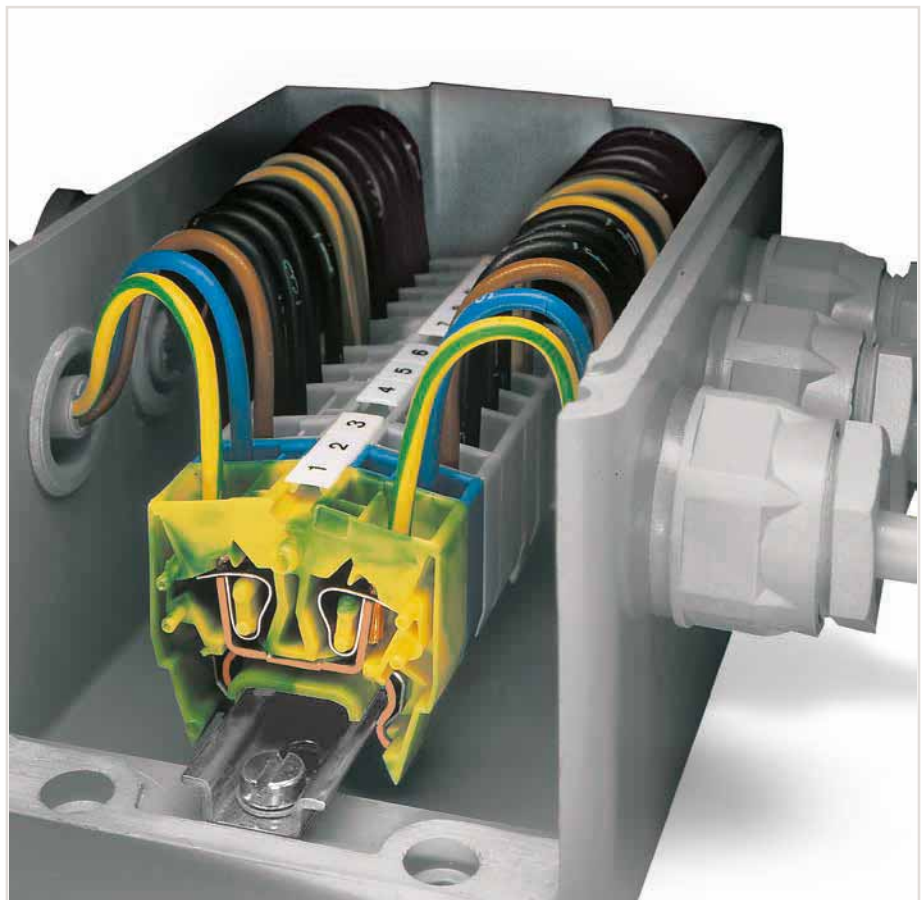

Easy-to-use miniature blocks that require minimal enclosure space.



Combining 2- and 4-conductor terminal blocks. Marking via Mini-WSB Quick markers.

7





**CAGE CLAMP® connection**  
 Inserting a conductor via screwdriver.  
 With ferruled conductors, it is necessary to use a terminal block one size smaller than the conductor's nominal cross section.

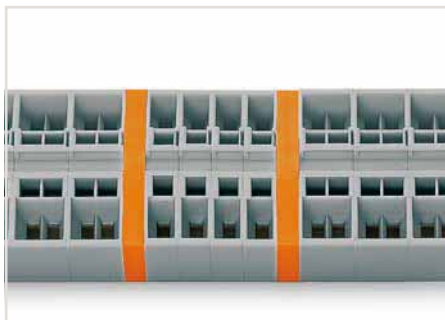

Separating groups via intermediate plates.

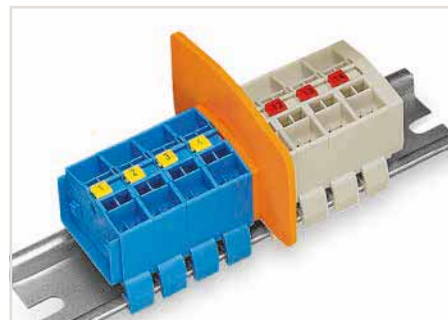

Ex e/Ex i separator plate for miniature rail-mount terminal blocks

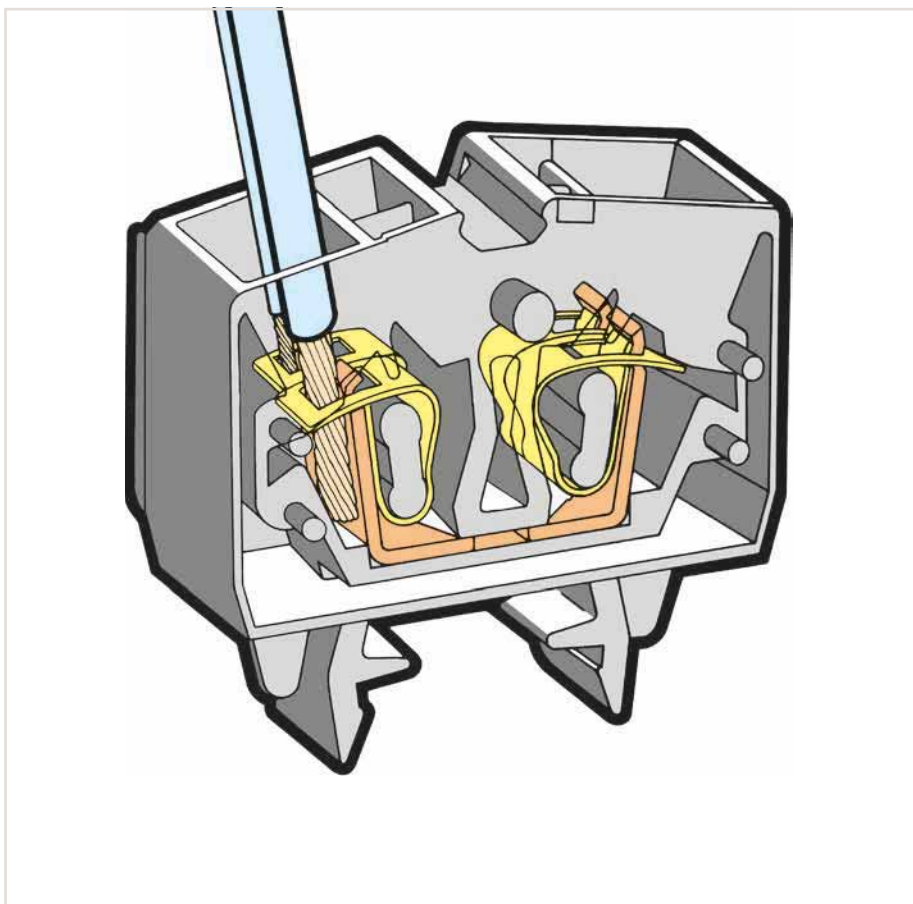

Testing by touch contact to the CAGE CLAMP® spring (limited to 0.5 A).



Testing via CAGE CLAMP® on the current bar (max. nominal current: 6 A).  
 CAGE CLAMP® clamps individual test contacts.



Marking with T-marker tag (209-290).

7

## Miniature Through/Ground Conductor and Ex Terminal Blocks for DIN-35 Rail 2.5 mm<sup>2</sup>, 264 Series

\*12 AWG: THHN, THWN  
 Rail-mount terminal blocks with an Ex mark are suitable for Ex e II applications.  
 0.5 ... 2.5 mm<sup>2</sup> / 20 ... 12 AWG\*  
 690 V, 23 A  
 Terminal blocks with a blue insulated housing are suitable for Ex i applications.



2-conductor miniature through terminal block, for DIN-35 rail

Color	Item No.	Pack. Unit
● gray	264-711	100
● blue	264-714	100
● orange	264-716	100
○ light gray <sup>Ⓢ</sup>	264-125	100

**UL**

### Technical Data

Rated voltage (III / 3)	800 V
Rated surge voltage (III / 3)	8 kV
Rated current	24 A
Approval	600 V, 20 A <b>UL</b> ; 300 V, 20 A <b>CE</b>

### Connection Data

Solid conductor	0.08 ... 2.5 mm <sup>2</sup> / 28 ... 12 AWG
Fine-stranded conductor	0.08 ... 2.5 mm <sup>2</sup> / 28 ... 12 AWG
Note (conductor cross section)	12 AWG: THHN, THWN
Strip length	8 ... 9 mm / 0.31 ... 0.35 inch
Terminal block width	6 mm / 0.236 inch
Insulation material	Polyamide 66 (PA 66)

### Accessories (Selection)

Comb-style jumper bar, insulated, reduces maximum conductor size to 1.5 mm <sup>2</sup> , I <sub>N</sub> 16 A, gray	
Alternate comb-style jumper bar, insulated, I <sub>N</sub> = I <sub>N</sub> terminal block, gray	
Alternate comb-style jumper bar, insulated, I <sub>N</sub> = I <sub>N</sub> terminal block, gray	
End and intermediate plate, 4 mm thick	
Mini-WSB Inline, plain, 1,700 Mini-WSB markers per reel, 5 mm wide markers	
Test plug module, snaps together, 6 mm wide	
Test plug module, snaps together, 10 mm wide	

	Item No.	Page
2-way	264-402	546
2-way	281-492	546
orange	264-369	546
white	2009-145	781
gray	249-136	546

Accessories (jumpers, end plates, test plugs, etc.), see page 546

Carrier rails and tools, see Section 13

Appropriate marking system: Mini-WSB/Mini-WSB Inline, see Full Line Catalog, Volume 6

Information on hazardous locations, see Section 14

Approvals and corresponding ratings, visit [www.wago.com](http://www.wago.com)



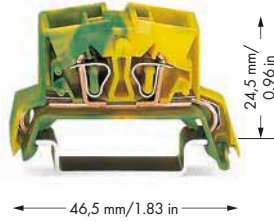
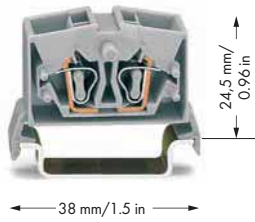

2-conductor miniature through terminal block, for DIN-35 rail

Color	Item No.	Pack. Unit
● gray	264-731	100
● blue	264-734	100
● orange	264-736	100
○ light gray ☺	264-225	100

UL®

800 V
8 kV
24 A
600 V, 20 A <b>UL</b> ; 300 V, 20 A <b>UL</b>
0.08 ... 2.5 mm <sup>2</sup> / 28 ... 12 AWG
0.08 ... 2.5 mm <sup>2</sup> / 28 ... 12 AWG
12 AWG: THHN, THWN
8 ... 9 mm / 0.31 ... 0.35 inch
10 mm / 0.394 inch
Polyamide 66 (PA 66)

	Item No.	Page
2-way	264-402	546
2-way	280-492	546
orange	264-369	546
white	2009-145	781
gray	249-139	547

4-conductor miniature ground terminal block, for DIN-35 rail

Color	Item No.	Pack. Unit
● green-yellow	264-737	100
● green-yellow ☺	264-737/999-950	100

UL®

800 V
8 kV
24 A
600 V, 20 A <b>UL</b> ; 300 V, 20 A <b>UL</b>
0.08 ... 2.5 mm <sup>2</sup> / 28 ... 12 AWG
0.08 ... 2.5 mm <sup>2</sup> / 28 ... 12 AWG
12 AWG: THHN, THWN
8 ... 9 mm / 0.31 ... 0.35 inch
10 mm / 0.394 inch
Polyamide 66 (PA 66)

	Item No.	Page
2-way	264-402	546
2-way	280-492	546
orange	264-369	546
white	2009-145	781
gray	249-139	547

## Miniature Through/Ground Conductor and Ex Terminal Blocks for DIN-15 Rail 2.5 mm<sup>2</sup>, 264 Series

\*12 AWG: THHN, THWN  
Rail-mount terminal blocks with an Ex mark are suitable for Ex e II applications.  
0.5 ... 2.5 mm<sup>2</sup> / 20 ... 12 AWG\*  
690 V, 23 A  
Terminal blocks with a blue insulated housing are suitable for Ex i applications.



2-conductor miniature through terminal block, for DIN-35 rail

Color	Item No.	Pack. Unit
gray	264-701	100
blue	264-704	100
orange	264-706	100
light gray	264-120	100

### Technical Data

Rated voltage (III / 3)

Rated surge voltage (III / 3)

Rated current

Approval

### Connection Data

Solid conductor

Fine-stranded conductor

Note (conductor cross section)

Strip length

Terminal block width

Insulation material

### Accessories (Selection)

Comb-style jumper bar, insulated, reduces maximum conductor size to 1.5 mm<sup>2</sup>, I<sub>N</sub> 16 A, gray

Alternate comb-style jumper bar, insulated, I<sub>N</sub> = I<sub>N</sub> terminal block, gray

Alternate comb-style jumper bar, insulated, I<sub>N</sub> = I<sub>N</sub> terminal block, gray

End and intermediate plate, 4 mm thick

Mini-WSB Inline, plain, 1,700 Mini-WSB markers per reel, 5 mm wide markers

Test plug module, snaps together, 6 mm wide

Test plug module, snaps together, 10 mm wide

800 V

8 kV

24 A

600 V, 20 A ; 300 V, 20 A

0.08 ... 2.5 mm<sup>2</sup> / 28 ... 12 AWG

0.08 ... 2.5 mm<sup>2</sup> / 28 ... 12 AWG

12 AWG: THHN, THWN

8 ... 9 mm / 0.31 ... 0.35 inch

6 mm / 0.236 inch

Polyamide 66 (PA 66)

	Item No.	Page
2-way	264-402	546
2-way	281-492	546
orange	264-369	546
white	2009-145	781
gray	249-136	546

Accessories (jumpers, end plates, test plugs, etc.), see page 546

Carrier rails and tools, see Section 13

Appropriate marking system: Mini-WSB/Mini-WSB Inline, see Full Line Catalog, Volume 6

Information on hazardous locations, see Section 14

Approvals and corresponding ratings, visit [www.wago.com](http://www.wago.com)

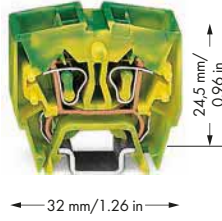
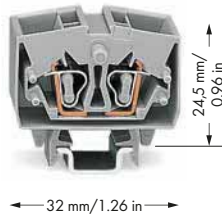

2-conductor miniature through terminal block, for DIN-35 rail

Color	Item No.	Pack. Unit
○ gray	264-721	100
● blue	264-724	100
● orange	264-726	100
○ light gray ☺	264-220	100

4-conductor miniature ground terminal block, for DIN-35 rail

Color	Item No.	Pack. Unit
● green-yellow	264-727	100
● green-yellow ☺	264-727/999-950	100

UL®

UL®

800 V
8 kV
24 A
600 V, 20 A <b>UL</b> ; 300 V, 20 A <b>UL</b>
0.08 ... 2.5 mm <sup>2</sup> / 28 ... 12 AWG
0.08 ... 2.5 mm <sup>2</sup> / 28 ... 12 AWG
12 AWG: THHN, THWN
8 ... 9 mm / 0.31 ... 0.35 inch
10 mm / 0.394 inch
Polyamide 66 (PA 66)

800 V
8 kV
24 A
600 V, 20 A <b>UL</b> ; 300 V, 20 A <b>UL</b>
0.08 ... 2.5 mm <sup>2</sup> / 28 ... 12 AWG
0.08 ... 2.5 mm <sup>2</sup> / 28 ... 12 AWG
12 AWG: THHN, THWN
8 ... 9 mm / 0.31 ... 0.35 inch
10 mm / 0.394 inch
Polyamide 66 (PA 66)

	Item No.	Page
2-way	264-402	546
2-way	280-492	546
orange	264-369	546
white	2009-145	781
gray	249-139	547

	Item No.	Page
2-way	264-402	546
2-way	280-492	546
orange	264-369	546
white	2009-145	781
gray	249-139	547

7

## Accessories, 264 Series Miniature Rail-Mount Terminal Blocks

### Commoning, Mounting, Marking and Testing



Comb-style jumper bar, insulated, reduces maximum conductor size to 1.5 mm <sup>2</sup> , I <sub>N</sub> 16 A, gray		
	Item No.	Pack. Unit
2-way	264-402	200 (25)



Alternate comb-style jumper bar, insulated, I <sub>N</sub> = I <sub>N</sub> terminal block, gray		
Suitable for:	Item No.	Pack. Unit
2-conductor terminal blocks	281-492	100 (25)



Alternate comb-style jumper bar, insulated, I <sub>N</sub> = I <sub>N</sub> terminal block, gray		
Suitable for:	Item No.	Pack. Unit
4-conductor terminal blocks	280-492	200 (25)



Operating tool, insulated		
	Item No.	Pack. Unit
2-way	280-432	1



End and intermediate plate, 4 mm thick		
Color	Item No.	Pack. Unit
orange	264-369	25
gray	264-368	25
light gray	264-370	25

7



 Application notes, see page 541

Separator for Ex e/Ex i applications, 4 mm thick, orange		
	Item No.	Pack. Unit
66 mm wide	264-367	25



 Test plugs, see page 541

Maximum test voltage: 400 V (only in test equipment acc. to relevant clearances and creepage distances)

Maximum test voltage (manual touch contacting): 48 V (test pins are not touch-proof)

Maximum test current (touch contacting): 0.5 A

Maximum test current: 6 A (if the test pins are securely connected in the clamping units)

Test voltage	48 V
Test current	0.5 A

Test plug module, snaps together Module width 6 mm			
Suitable for:	Color	Item No.	Pack. Unit
2-conductor terminal blocks	gray	249-136	100 (25)



 Test plugs, see page 541

Maximum test voltage: 800 V (only in test equipment acc. to relevant clearances and creepage distances)

Maximum test voltage (manual touch contacting): 48 V (test pins are not touch-proof)

Maximum test current (touch contacting): 0.5 A

Maximum test current: 6 A (if the test pins are securely connected in the clamping units)

Test voltage	48 V
Test current	0.5 A

Test plug module, snaps together			
Module width 10 mm			
Suitable for:	Color	Item No.	Pack. Unit
4-conductor terminal blocks	gray	249-139	100 (25)

## Compact Rail-Mount Terminal Blocks for DIN-15 and DIN-35 Rails, 870 Series Description and Installation

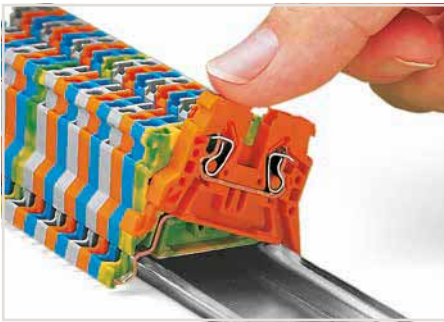

Snapping a rail-mount terminal block onto DIN-35 rail.

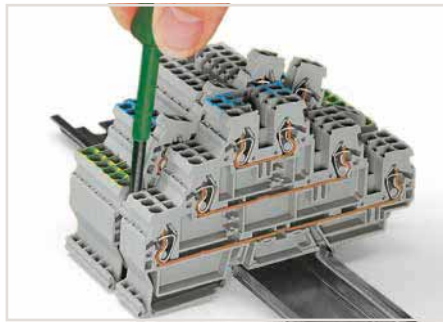

Removing a terminal block from the assembly.



Inserting an insulation strip into conductor entry holes of terminal strip.



7 Push jumper bars down firmly until fully inserted. When using multipole bars, push alternately on the right and then left side, until installed. Push-in type jumper bars 1-3-5-7 or 1--4--7 upon request



Commoning with push-in type jumper bars: Two parallel jumper slots are accommodated in one terminal block.

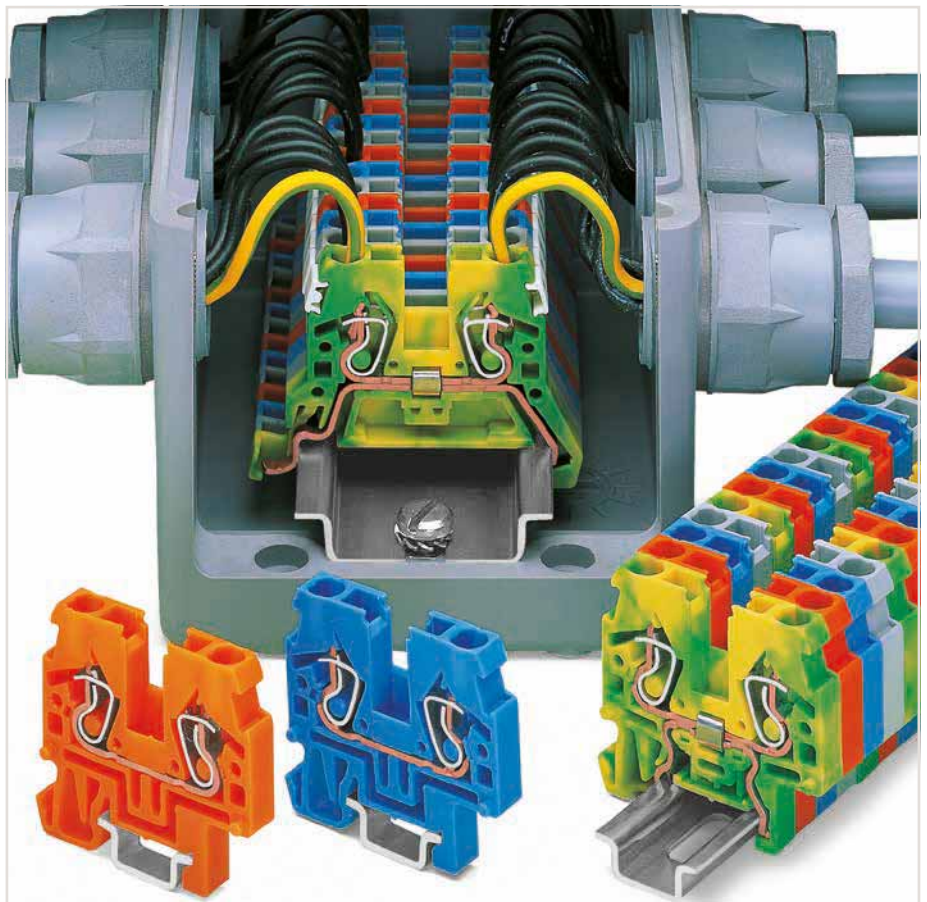

Commoning terminal blocks of different sizes via step-down jumpers.

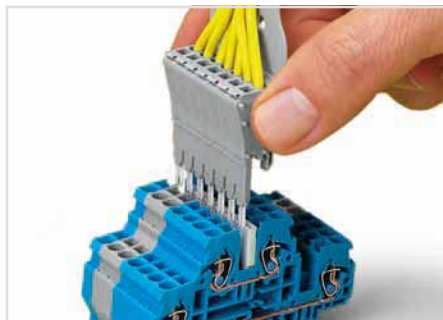

Testing: Using a pre-wired module assembly, similar to test plugs.

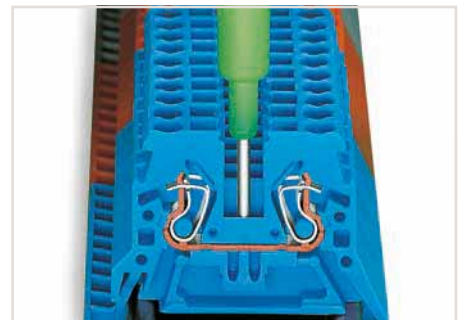

Testing with phase testing device, also possible with single-pole voltage tester.





**CAGE CLAMP® connection**  
 Inserting a conductor via operating tool (0.08 ... 4 mm<sup>2</sup> "f-st").  
 With ferruled conductors, it is necessary to use a terminal block one size smaller than the conductor's nominal cross section.

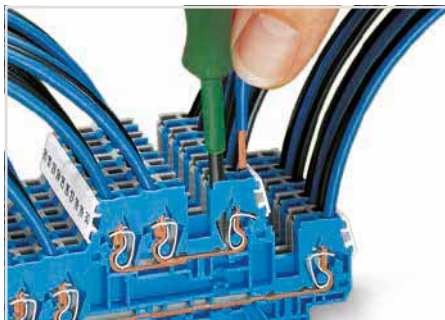

**CAGE CLAMP® connection**  
 Inserting a conductor via operating tool (0.08 ... 4 mm<sup>2</sup> "f-st").

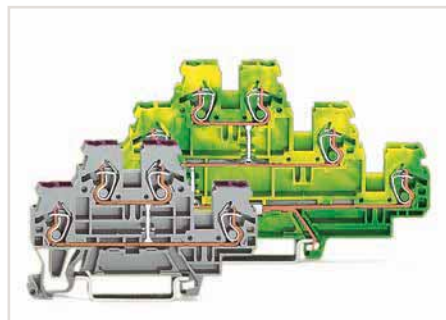

**Multilevel terminal blocks**  
 Double- and triple-deck terminal blocks with internal commoning acting as 4- and 6-conductor terminal blocks

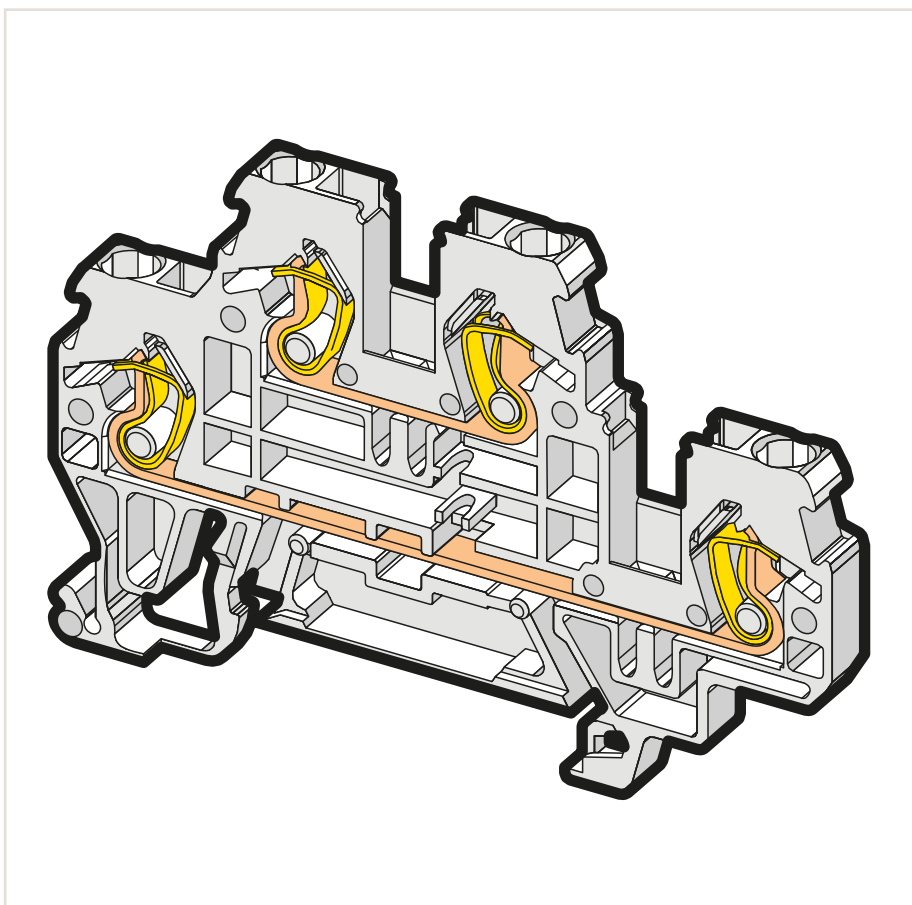

Protective warning markers (280-405), with a black high-voltage symbol



WMB markers in Mini-WSB marker slots  
 Marking strip, translucent  
 Mini-WSB markers

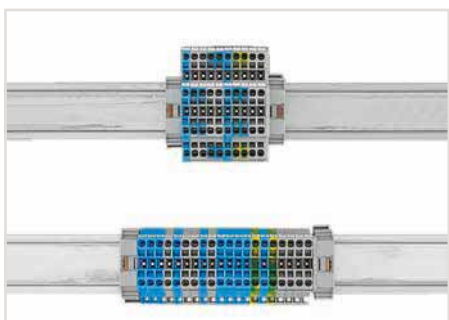

Use 50 % less rail space with double-deck terminal blocks.

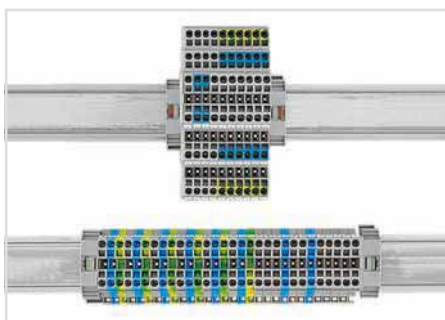

Use 67 % less rail space with triple-deck terminal blocks.



Translucent marking strip (709-196) – jumpers below may be visible.

7

## Through and Ex Terminal Blocks for DIN-35 and DIN-15 Rails 2.5 mm<sup>2</sup> (4 mm<sup>2</sup> "f-st"), 870 Series

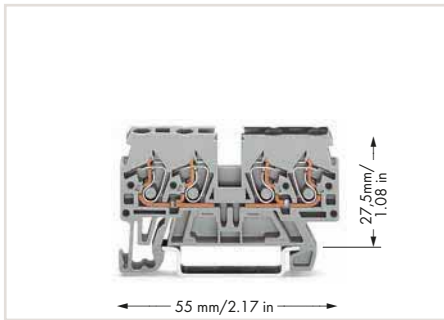

Notice: These double-potential terminal blocks cannot be commoned with push-in type jumper bars! WAGO front-entry double-potential terminal blocks are space savers.

Two independent feedthrough circuits are placed in one insulated housing on one level in just 5 mm. This achieves a width of just 2.1 mm versus standard through terminal blocks for a total height of just 27.5 mm from the upper-edge of carrier rail.

Input and output of a circuit are placed on the same side of the terminal block. Both circuits can be individually marked according to input and output.

Rail-mount terminal blocks with an Ex mark are suitable for Ex e II applications.  
0.2 ... 2.5 (4 mm<sup>2</sup> "f-st") mm<sup>2</sup> /  
24 ... 12 AWG  
440 V, 22 A

Using 1 or more push-in type jumper bars, the maximum rated voltage is reduced to 275 V and the rated current to 13.5 A.

Terminal blocks with a blue insulated housing are suitable for Ex i applications.

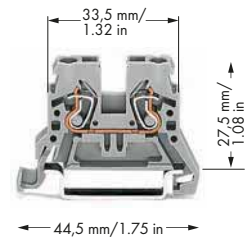

2-conductor through terminal block, for DIN-35 rail

Color	Item No.	Pack. Unit
○ gray	870-901	100
● blue	870-904	100
○ light gray ☺	870-909	100

7



### Mounting on DIN-15 rail:

Snap individual terminal blocks onto the DIN-15 rail and slide together.

### Removal from DIN-15 rail:

Open assembly by laterally sliding terminal blocks with an operating tool and remove them from the rail.

### Technical Data

Ratings per

Rated voltage (III / 3)

Rated surge voltage (III / 3)

Rated current

Approval

### Connection Data

Solid conductor

Fine-stranded conductor

Strip length

Terminal block width

Insulation material

### Note

### Accessories (Selection)

Push-in type jumper bar, insulated, I<sub>N</sub> 18 A, light gray

End and intermediate plate, 2 mm thick

End and intermediate plate, 1 mm thick

Mini-WSB Inline, plain, 1,700 Mini-WSB markers per reel, 5 mm wide markers

Tap-off module, with anti-reverse mating protection, snaps together, for 870 Series rail-mount terminal blocks with jumper slots in the current bar

Module width 5 mm



IEC/EN 60947-7-1

500 V

6 kV

24 A

300 V, 20 A, US

0.08 ... 2.5 mm<sup>2</sup> / 28 ... 12 AWG

0.08 ... 4 mm<sup>2</sup> / 28 ... 12 AWG

6 ... 7 mm / 0.24 ... 0.28 inch

5 mm / 0.197 inch

Polyamide 66 (PA 66)

Max. insulation diameter: 4.4 mm

	Item No.	Page
2-way	870-402	568
orange	870-924	568
white	2009-145	781
gray	870-425	567

Additional colors, visit [www.wago.com](http://www.wago.com)

Accessories (jumpers, end plates, test plugs, etc.), see page 568

Carrier rails and tools, see Section 13

Appropriate marking system: Mini-WSB/Mini-WSB Inline/WMB/WMB Inline, see Full Line Catalog, Volume 6

Information on hazardous locations, see Section 14

Approvals and corresponding ratings, visit [www.wago.com](http://www.wago.com)

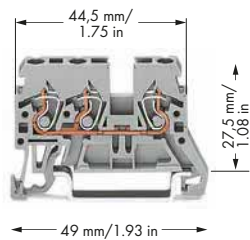

3-conductor through terminal block, for DIN-35 rail

Color	Item No.	Pack. Unit
○ gray	870-681	100
● blue	870-684	100

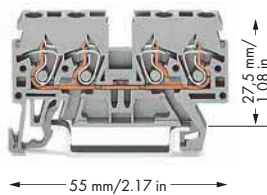

4-conductor through terminal block, for DIN-35 rail

Color	Item No.	Pack. Unit
○ gray	870-831	100
● blue	870-834	100

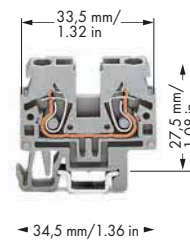

2-conductor through terminal block, for DIN-15 rail

Color	Item No.	Pack. Unit
○ gray	870-911	100
● blue	870-914	100
○ light gray ☺	870-919	100

Double-potential terminal block, with integrated marking level, for DIN-15 rail  
 Notice: This double-potential terminal block cannot be commoned with push-in type jumper bars!

Color	Item No.	Pack. Unit
○ gray	870-826	100



IEC/EN 60947-7-1
500 V
6 kV
24 A
300 V, 20 A,

IEC/EN 60947-7-1
500 V
6 kV
24 A
300 V, 20 A,

IEC/EN 60947-7-1
500 V
6 kV
24 A
300 V, 20 A,

0.08 ... 2.5 mm <sup>2</sup> / 28 ... 12 AWG
0.08 ... 4 mm <sup>2</sup> / 28 ... 12 AWG
6 ... 7 mm / 0.24 ... 0.28 inch
5 mm / 0.197 inch
Polyamide 66 (PA 66)
Max. insulation diameter: 4.4 mm

0.08 ... 2.5 mm <sup>2</sup> / 28 ... 12 AWG
0.08 ... 4 mm <sup>2</sup> / 28 ... 12 AWG
6 ... 7 mm / 0.24 ... 0.28 inch
5 mm / 0.197 inch
Polyamide 66 (PA 66)
Max. insulation diameter: 4.4 mm

0.08 ... 2.5 mm <sup>2</sup> / 28 ... 12 AWG
0.08 ... 4 mm <sup>2</sup> / 28 ... 12 AWG
6 ... 7 mm / 0.24 ... 0.28 inch
5 mm / 0.197 inch
Polyamide 66 (PA 66)
Max. insulation diameter: 4.4 mm

	Item No.	Page
2-way	870-402	568
orange	870-934	568
white	2009-145	781
gray	870-425	567

	Item No.	Page
2-way	870-402	568
orange	870-944	569
white	2009-145	781
gray	870-425	567

	Item No.	Page
2-way	870-402	568
orange	870-924	568
white	2009-145	781
gray	870-425	567

## Ground Conductor and Ex Terminal Blocks for DIN-35 and DIN-15 Rails

### 2.5 mm<sup>2</sup> (4 mm<sup>2</sup> "f-st"), 870 Series



In order to meet creepage and clearance requirements for Ex e applications, it is necessary to insert an end or intermediate plate between a through and a ground conductor terminal block.

End plates 870-923 (gray), 870-924 (orange) and 870-925 (light gray), as well as separator plates 870-928 (gray) and 870-929 (orange) cannot be assembled to 2-conductor ground Ex terminal blocks (870-907/999-950).

Rail-mount terminal blocks with an Ex mark are suitable for Ex e II applications.  
0.2 ... 2.5 (4 mm<sup>2</sup> "f-st") mm<sup>2</sup> /  
24 ... 12 AWG

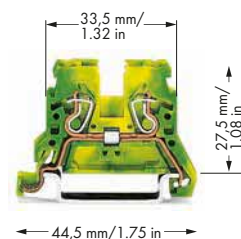

2-conductor ground terminal block, for DIN-35 rail

Color	Item No.	Pack. Unit
● green-yellow	870-907	100
● green-yellow Ⓢ	870-907/999-950	100

UL

#### Technical Data

Ratings per	IEC/EN 60947-7-2
<b>Connection Data</b>	
Solid conductor	0.08 ... 2.5 mm <sup>2</sup> / 28 ... 12 AWG
Fine-stranded conductor	0.08 ... 4 mm <sup>2</sup> / 28 ... 12 AWG
Strip length	6 ... 7 mm / 0.24 ... 0.28 inch
Terminal block width	5 mm / 0.197 inch
Insulation material	Polyamide 66 (PA 66)
<b>Note</b>	Max. insulation diameter: 4.4 mm Notice: This ground conductor terminal block cannot be commoned with push-in type jumper bars!

#### Accessories (Selection)

End and intermediate plate, 2 mm thick	orange	870-924	Page 568
End and intermediate plate, 1 mm thick			
Mini-WSB Inline, plain, 1,700 Mini-WSB markers per reel, 5 mm wide markers	white	2009-145	Page 781

Additional colors, visit [www.wago.com](http://www.wago.com)

Accessories (jumpers, end plates, test plugs, etc.), see page 568

Carrier rails and tools, see Section 13

Appropriate marking system: Mini-WSB/Mini-WSB Inline/WMB/WMB Inline, see Full Line Catalog, Volume 6

Information on hazardous locations, see Section 14

Approvals and corresponding ratings, visit [www.wago.com](http://www.wago.com)

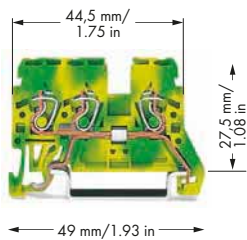

3-conductor ground terminal block, for DIN-35 rail

Color	Item No.	Pack. Unit
● green-yellow	870-687	100



IEC/EN 60947-7-2

0.08 ... 2.5 mm<sup>2</sup> / 28 ... 12 AWG  
 0.08 ... 4 mm<sup>2</sup> / 28 ... 12 AWG  
 6 ... 7 mm / 0.24 ... 0.28 inch  
 5 mm / 0.197 inch  
 Polyamide 66 (PA 66)

Max. insulation diameter: 4.4 mm  
 Notice: This ground conductor terminal block cannot be commoned with push-in type jumper bars!

	Item No.	Page
orange	870-934	568
white	2009-145	781

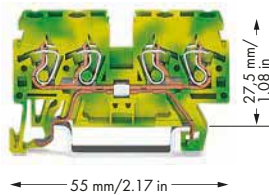

4-conductor ground terminal block, for DIN-35 rail

Color	Item No.	Pack. Unit
● green-yellow	870-837	100



IEC/EN 60947-7-2

0.08 ... 2.5 mm<sup>2</sup> / 28 ... 12 AWG  
 0.08 ... 4 mm<sup>2</sup> / 28 ... 12 AWG  
 6 ... 7 mm / 0.24 ... 0.28 inch  
 5 mm / 0.197 inch  
 Polyamide 66 (PA 66)

Max. insulation diameter: 4.4 mm  
 Notice: This ground conductor terminal block cannot be commoned with push-in type jumper bars!

	Item No.	Page
orange	870-944	569
white	2009-145	781

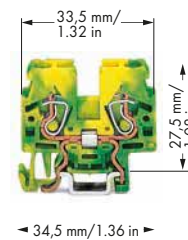

2-conductor ground terminal block, for DIN-15 rail

Color	Item No.	Pack. Unit
● green-yellow	870-917	100



IEC/EN 60947-7-2

0.08 ... 2.5 mm<sup>2</sup> / 28 ... 12 AWG  
 0.08 ... 4 mm<sup>2</sup> / 28 ... 12 AWG  
 6 ... 7 mm / 0.24 ... 0.28 inch  
 5 mm / 0.197 inch  
 Polyamide 66 (PA 66)

Max. insulation diameter: 4.4 mm  
 Notice: This ground conductor terminal block cannot be commoned with push-in type jumper bars!

	Item No.	Page
orange	870-924	568
white	2009-145	781



## Double-Deck Terminal Blocks 2.5 mm<sup>2</sup> (4 mm<sup>2</sup> "f-st"), 870 Series

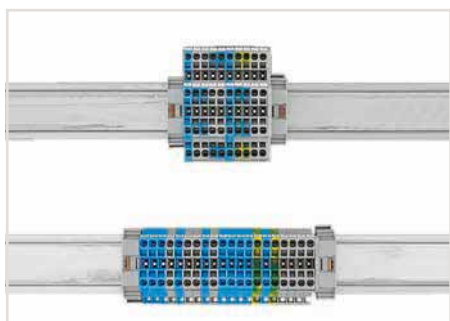

Use 50 % less rail space with double-deck terminal blocks.

Rail-mount terminal blocks with an Ex mark are suitable for Ex e II applications.  
0.2 ... 2.5 (4 mm<sup>2</sup> "f-st") mm<sup>2</sup> /  
24 ... 12 AWG

440 V, 18 A

Using 1 or more push-in type jumper bars, the maximum rated voltage is reduced to 275 V and the rated current to 13.5 A.

Terminal blocks with a blue insulated housing are suitable for Ex i applications.

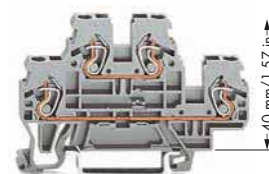

70 mm / 2.76 in

40 mm / 1.57 in

Double-deck terminal block, through/through terminal block, gray housing

	Item No.	Pack. Unit
○ L/L	870-501	50
○ N/L	870-502	50
○ L/N	870-503	50

Double-deck terminal block, through/through terminal block, blue housing

	Item No.	Pack. Unit
● N/N	870-504	50

Double-deck terminal block, through/through terminal block, light gray housing

	Item No.	Pack. Unit
○ L/L <sup>⊕</sup>	870-961	50



### Technical Data

Ratings per	IEC/EN 60947-7-1
Rated voltage (III / 3)	500 V
Rated surge voltage (III / 3)	6 kV
Rated current	24 A
Approval	300 V, 20 A,
<b>Connection Data</b>	
Solid conductor	0.08 ... 2.5 mm <sup>2</sup> / 28 ... 12 AWG
Fine-stranded conductor	0.08 ... 4 mm <sup>2</sup> / 28 ... 12 AWG
Strip length	6 ... 7 mm / 0.24 ... 0.28 inch
Terminal block width	5 mm / 0.197 inch
Insulation material	Polyamide 66 (PA 66)

### Accessories (Selection)

	Item No.	Page
Push-in type jumper bar, insulated, I <sub>N</sub> 18 A, light gray	870-402	568
End and intermediate plate, 2 mm thick	orange 870-519	569
Mini-WSB Inline, plain, 1,700 Mini-WSB markers per reel, 5 mm wide markers	white 2009-145	781
Tap-off module, with anti-reverse mating protection, snaps together, for 870 Series rail-mount terminal blocks with jumper slots in the current bar	gray 870-425	567
Module width 5 mm		

Accessories (jumpers, end plates, test plugs, etc.), see page 568

Carrier rails and tools, see Section 13

Appropriate marking system: Mini-WSB/Mini-WSB Inline/WMB/WMB Inline, see Full Line Catalog, Volume 6

Information on hazardous locations, see Section 14

Approvals and corresponding ratings, visit [www.wago.com](http://www.wago.com)



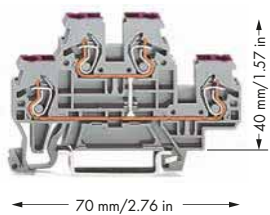

Double-deck terminal block, 4-conductor through terminal block, internally commoned, violet conductor entry, gray housing

	Item No.	Pack. Unit
○ L	870-508	50

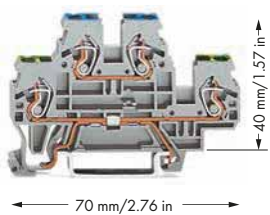

Double-deck terminal block, ground conductor/through terminal block, gray housing

	Item No.	Pack. Unit
○ PE/N	870-517	50
○ PE/L	870-527	50

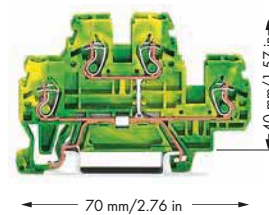

Double-deck terminal block, 4-conductor ground terminal block, internally commoned, green-yellow housing

	Item No.	Pack. Unit
● PE	870-507	50

Double-deck terminal block, 4-conductor through terminal block, internally commoned, violet conductor entry, blue housing

	Item No.	Pack. Unit
● N	870-509	50

Double-deck terminal block, ground conductor/through terminal block, light gray housing

	Item No.	Pack. Unit
○ PE/L	870-967/999-950	50



IEC/EN 60947-7-1  
500 V  
6 kV  
24 A  
300 V, 20 A

0.08 ... 2.5 mm<sup>2</sup> / 28 ... 12 AWG  
0.08 ... 4 mm<sup>2</sup> / 28 ... 12 AWG  
6 ... 7 mm / 0.24 ... 0.28 inch  
5 mm / 0.197 inch  
Polyamide 66 (PA 66)

	Item No.	Page
2-way	870-402	568
orange	870-519	569
white	2009-145	781
gray	870-425	567



IEC/EN 60947-7-1  
500 V  
6 kV  
24 A  
300 V, 20 A

0.08 ... 2.5 mm<sup>2</sup> / 28 ... 12 AWG  
0.08 ... 4 mm<sup>2</sup> / 28 ... 12 AWG  
6 ... 7 mm / 0.24 ... 0.28 inch  
5 mm / 0.197 inch  
Polyamide 66 (PA 66)

	Item No.	Page
2-way	870-402	568
orange	870-519	569
white	2009-145	781
gray	870-425	567



IEC/EN 60947-7-2

0.08 ... 2.5 mm<sup>2</sup> / 28 ... 12 AWG  
0.08 ... 4 mm<sup>2</sup> / 28 ... 12 AWG  
6 ... 7 mm / 0.24 ... 0.28 inch  
5 mm / 0.197 inch  
Polyamide 66 (PA 66)

	Item No.	Page
2-way	870-402	568
orange	870-519	569
white	2009-145	781
gray	870-425	567

## 3-Conductor, Double-Deck Terminal Blocks 2.5 mm<sup>2</sup> (4 mm<sup>2</sup> "f-st"), 870 Series

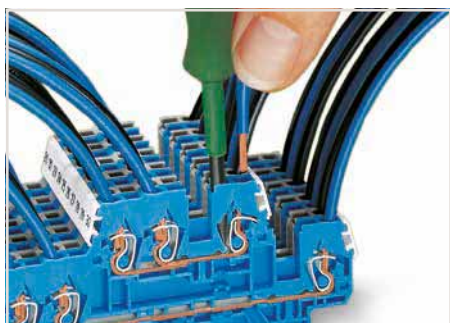

**CAGE CLAMP® connection**  
Inserting a conductor via operating tool (0.08 ... 4 mm<sup>2</sup> "f-st").

Terminal blocks with a blue insulated housing are suitable for Ex i applications.

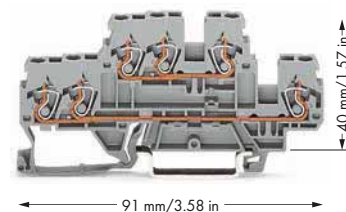

Double-deck terminal block, through/through terminal block, gray housing

	Item No.	Pack. Unit
○ L/L	870-531	50
○ N/L	870-532	50
○ L/N	870-533	50

Double-deck terminal block, through/through terminal block, blue housing

	Item No.	Pack. Unit
● N/N	870-534	50



### Technical Data

Ratings per	IEC/EN 60947-7-1
Rated voltage (III / 3)	500 V
Rated surge voltage (III / 3)	6 kV
Rated current	24 A
Approval	300 V, 20 A,
<b>Connection Data</b>	
Solid conductor	0.08 ... 2.5 mm <sup>2</sup> / 28 ... 12 AWG
Fine-stranded conductor	0.08 ... 4 mm <sup>2</sup> / 28 ... 12 AWG
Strip length	6 ... 7 mm / 0.24 ... 0.28 inch
Terminal block width	5 mm / 0.197 inch
Insulation material	Polyamide 66 (PA 66)

### Accessories (Selection)

Push-in type jumper bar, insulated, I <sub>n</sub> 18 A, light gray	2-way	870-402	568
End and intermediate plate, 2 mm thick	orange	870-574	569
Mini-WSB Inline, plain, 1,700 Mini-WSB markers per reel, 5 mm wide markers	white	2009-145	781
Tap-off module, with anti-reverse mating protection, snaps together, for 870 Series rail-mount terminal blocks with jumper slots in the current bar	gray	870-425	567
Module width 5 mm			

Accessories (jumpers, end plates, test plugs, etc.), see page 568

Carrier rails and tools, see Section 13

Appropriate marking system: Mini-WSB/Mini-WSB Inline/WMB/WMB Inline, see Full Line Catalog, Volume 6

Approvals and corresponding ratings, visit [www.wago.com](http://www.wago.com)

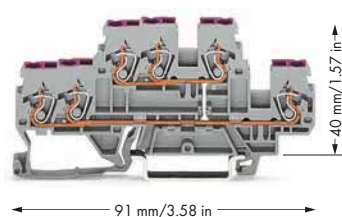

Double-deck terminal block, 4-conductor through terminal block, internally commoned, violet conductor entry, gray housing

	Item No.	Pack. Unit
○ L	870-538	50

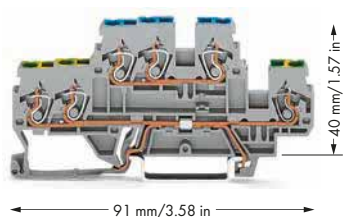

Double-deck terminal block, ground conductor/through terminal block, gray housing

	Item No.	Pack. Unit
○ PE/N	870-535	50
○ PE/L	870-536	50

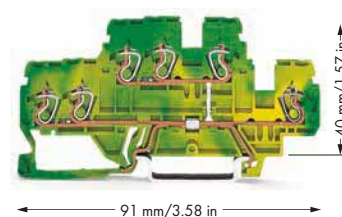

Double-deck terminal block, 4-conductor ground terminal block, internally commoned, green-yellow housing

	Item No.	Pack. Unit
● PE	870-537	50

Double-deck terminal block, 4-conductor through terminal block, internally commoned, violet conductor entry, blue housing

	Item No.	Pack. Unit
● N	870-539	50



IEC/EN 60947-7-1

500 V

6 kV

24 A

300 V, 20 A,

0.08 ... 2.5 mm<sup>2</sup> / 28 ... 12 AWG

0.08 ... 4 mm<sup>2</sup> / 28 ... 12 AWG

6 ... 7 mm / 0.24 ... 0.28 inch

5 mm / 0.197 inch

Polyamide 66 (PA 66)

	Item No.	Page
2-way	870-402	568
orange	870-574	569
white	2009-145	781
gray	870-425	567



IEC/EN 60947-7-1

500 V

6 kV

24 A

300 V, 20 A,

0.08 ... 2.5 mm<sup>2</sup> / 28 ... 12 AWG

0.08 ... 4 mm<sup>2</sup> / 28 ... 12 AWG

6 ... 7 mm / 0.24 ... 0.28 inch

5 mm / 0.197 inch

Polyamide 66 (PA 66)

	Item No.	Page
2-way	870-402	568
orange	870-574	569
white	2009-145	781
gray	870-425	567



IEC/EN 60947-7-2

0.08 ... 2.5 mm<sup>2</sup> / 28 ... 12 AWG

0.08 ... 4 mm<sup>2</sup> / 28 ... 12 AWG

6 ... 7 mm / 0.24 ... 0.28 inch

5 mm / 0.197 inch

Polyamide 66 (PA 66)

	Item No.	Page
2-way	870-402	568
orange	870-574	569
white	2009-145	781
gray	870-425	567

## Triple-Deck Terminal Blocks

### 2.5 mm<sup>2</sup> (4 mm<sup>2</sup> "f-st"), 870 Series

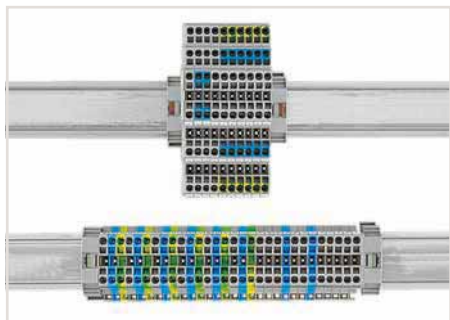

Use 67 % less rail space with triple-deck terminal blocks.

Rail-mount terminal blocks with an Ex mark are suitable for Ex e II applications.  
0.2 ... 2.5 (4 mm<sup>2</sup> "f-st") mm<sup>2</sup> /  
24 ... 12 AWG  
440 V, 18 A  
Using or more push-in type jumper bars, the maximum rated voltage is reduced to 275 V and the rated current to 13.5 A.

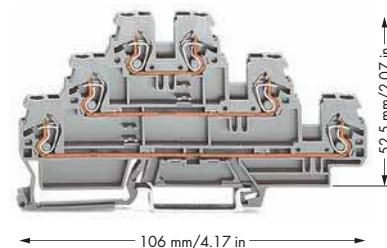

Triple-deck terminal block, through/through/through terminal block, gray housing

	Item No.	Pack. Unit
○ L/L/L	870-551	50
○ L/L/N	870-553	50

Triple-deck terminal block, through/through/through terminal block, light gray housing

	Item No.	Pack. Unit
○ L/L/L ☺	870-951	50

7

#### Technical Data

Ratings per	IEC/EN 60947-7-1
Rated voltage (III / 3)	500 V
Rated surge voltage (III / 3)	6 kV
Rated current	24 A
Approval	300 V, 20 A, 
<b>Connection Data</b>	
Solid conductor	0.08 ... 2.5 mm <sup>2</sup> / 28 ... 12 AWG
Fine-stranded conductor	0.08 ... 4 mm <sup>2</sup> / 28 ... 12 AWG
Strip length	6 ... 7 mm / 0.24 ... 0.28 inch
Terminal block width	5 mm / 0.197 inch
Insulation material	Polyamide 66 (PA 66)

#### Accessories (Selection)

Push-in type jumper bar, insulated, I <sub>n</sub> 18 A, light gray	2-way	870-402	568
End and intermediate plate, 2 mm thick	orange	870-569	569
Mini-WSB Inline, plain, 1,700 Mini-WSB markers per reel, 5 mm wide markers	white	2009-145	781
Tap-off module, with anti-reverse mating protection, snaps together, for 870 Series rail-mount terminal blocks with jumper slots in the current bar	gray	870-425	567
Module width 5 mm			

 Accessories (jumpers, end plates, test plugs, etc.), see page 568

 Carrier rails and tools, see Section 13

 Appropriate marking system: Mini-WSB/Mini-WSB Inline/WMB/WMB Inline, see Full Line Catalog, Volume 6

 Information on hazardous locations, see Section 14

 Approvals and corresponding ratings, visit [www.wago.com](http://www.wago.com)

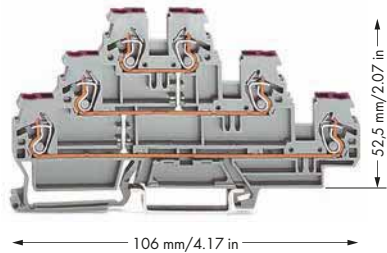

Triple-deck terminal block, 6-conductor through terminal block, internally commoned, violet conductor entry, gray housing

	Item No.	Pack. Unit
○ L	870-556	50

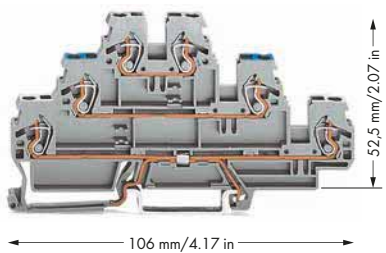

Triple-deck terminal block, shield conductor/through/through terminal block, gray housing

	Item No.	Pack. Unit
○ Shield/N/L	870-558	50
○ Shield/L/L	870-559	50

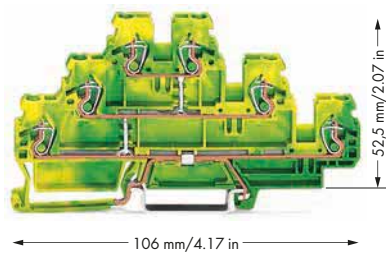

Triple-deck terminal block, 6-conductor ground terminal block, internally commoned, green-yellow housing

	Item No.	Pack. Unit
● PE	870-557	50

Triple-deck terminal block, ground conductor/through/through terminal block, gray housing

	Item No.	Pack. Unit
○ PE/N/L	870-567	50
○ PE/L/L	870-577	50

Triple-deck terminal block, ground conductor/through/through terminal block, light gray housing

	Item No.	Pack. Unit
○ PE/L/L ☺	870-957/999-950	50



IEC/EN 60947-7-1  
500 V  
6 kV  
24 A  
300 V, 20 A,

IEC/EN 60947-7-1  
500 V  
6 kV  
24 A  
300 V, 20 A,

IEC/EN 60947-7-2

0.08 ... 2.5 mm<sup>2</sup> / 28 ... 12 AWG  
0.08 ... 4 mm<sup>2</sup> / 28 ... 12 AWG  
6 ... 7 mm / 0.24 ... 0.28 inch  
5 mm / 0.197 inch  
Polyamide 66 (PA 66)

0.08 ... 2.5 mm<sup>2</sup> / 28 ... 12 AWG  
0.08 ... 4 mm<sup>2</sup> / 28 ... 12 AWG  
6 ... 7 mm / 0.24 ... 0.28 inch  
5 mm / 0.197 inch  
Polyamide 66 (PA 66)

0.08 ... 2.5 mm<sup>2</sup> / 28 ... 12 AWG  
0.08 ... 4 mm<sup>2</sup> / 28 ... 12 AWG  
6 ... 7 mm / 0.24 ... 0.28 inch  
5 mm / 0.197 inch  
Polyamide 66 (PA 66)

	Item No.	Page
2-way	870-402	568
orange	870-569	569
white	2009-145	781
gray	870-425	567

	Item No.	Page
2-way	870-402	568
orange	870-569	569
white	2009-145	781
gray	870-425	567

	Item No.	Page
2-way	870-402	568
orange	870-569	569
white	2009-145	781
gray	870-425	567

## Double-Deck Diode Terminal Blocks 2.5 mm<sup>2</sup> (4 mm<sup>2</sup> "f-st"), 870 Series

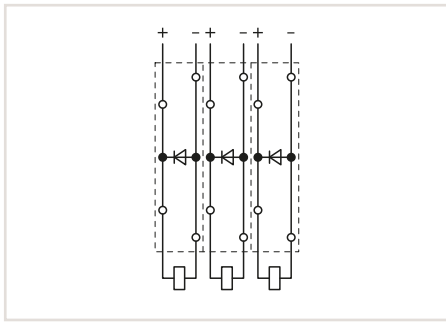

Recovery diodes can be created using the following terminal blocks:  
870-540/281-410 or 870-540/281411

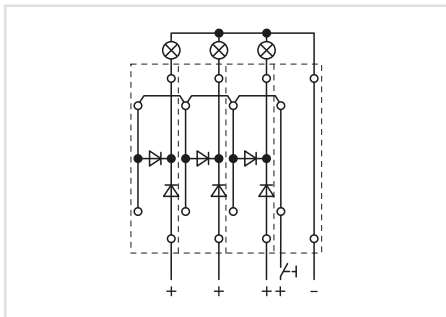

Lamp test circuits can be created using the following terminal blocks:  
870-541/281-492 or 870-541/281-491

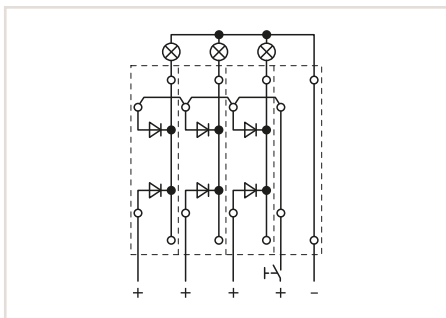

Lamp test circuits can be created using the following terminal blocks:  
870-542/281-487 or 870-542/281-488

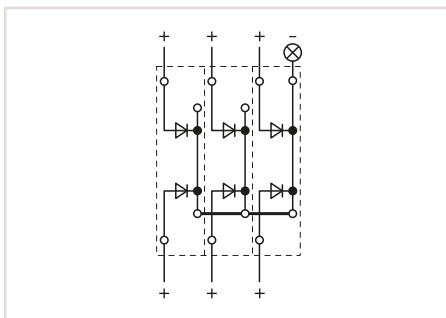

Collective fault signals can be created using the following terminal blocks:  
870-541/281-489 or 870-541/281-490

Double-deck diode terminal blocks were specifically developed for custom diode circuits, such as lamp test and collective fault signal circuits.

These terminal blocks provide high-density wiring in a width of just 5 mm. Push-in type jumper bars provide additional options for custom circuit design.

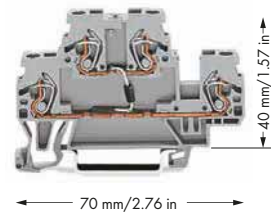

870-540/281-410

870-540/281-411

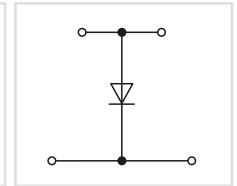
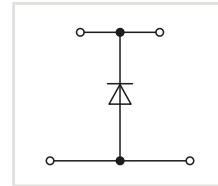

Double-deck diode terminal block, with 1N4007 diode

Color	Item No.	Pack. Unit
○ gray	870-540/281-410	50
○ gray	870-540/281-411	50

### Technical Data

Ratings per	IEC/EN 60947-7-1
Nominal voltage	250 V
Reverse voltage	1000 V
Rated current	0.5 A
<b>Connection Data</b>	
Solid conductor	0.08 ... 2.5 mm <sup>2</sup> / 28 ... 12 AWG
Fine-stranded conductor	0.08 ... 4 mm <sup>2</sup> / 28 ... 12 AWG
Strip length	6 ... 7 mm / 0.24 ... 0.28 inch
Terminal block width	5 mm / 0.197 inch
Insulation material	Polyamide 66 (PA 66)

### Accessories (Selection)

Push-in type jumper bar, insulated, I <sub>n</sub> 18 A, light gray	870-402	568
End and intermediate plate, 2 mm thick	870-519	569
Mini-WSB Inline, plain, 1,700 Mini-WSB markers per reel, 5 mm wide markers	2009-145	781

	Item No.	Page
2-way	870-402	568
orange	870-519	569
white	2009-145	781

Accessories (jumpers, end plates, etc.), see page 568

Carrier rails and tools, see Section 13

Appropriate marking system: Mini-WSB/Mini-WSB Inline/WMB/WMB Inline, see Full Line Catalog, Volume 6

Approvals and corresponding ratings, visit [www.wago.com](http://www.wago.com)



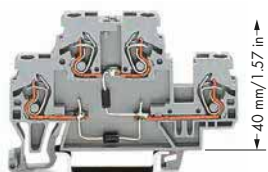

70 mm/2.76 in

870-541/281-492

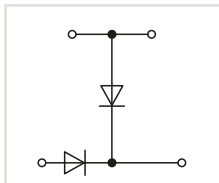

870-541/281-491

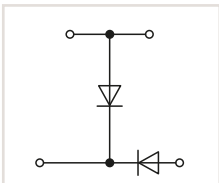

Double-deck diode terminal block, with two 1N4007 diodes

Color	Item No.	Pack. Unit
gray	870-541/281-492	50
gray	870-541/281-491	50

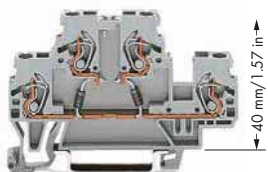

70 mm/2.76 in

870-542/281-487

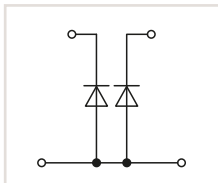

870-542/281-488

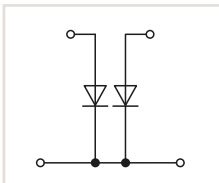

Double-deck diode terminal block, with two 1N4007 diodes

Color	Item No.	Pack. Unit
gray	870-542/281-487	50
gray	870-542/281-488	50

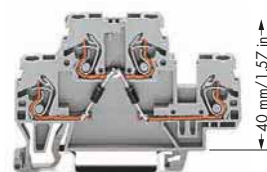

70 mm/2.76 in

870-541/281-489

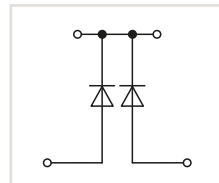

870-541/281-490

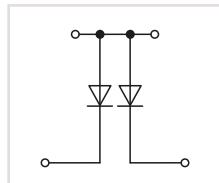

Double-deck diode terminal block, with two 1N4007 diodes

Color	Item No.	Pack. Unit
gray	870-541/281-489	50
gray	870-541/281-490	50

IEC/EN 60947-7-1

250 V

1000 V

0.5 A

0.08 ... 2.5 mm<sup>2</sup> / 28 ... 12 AWG

0.08 ... 4 mm<sup>2</sup> / 28 ... 12 AWG

6 ... 7 mm / 0.24 ... 0.28 inch

5 mm / 0.197 inch

Polyamide 66 (PA 66)

	Item No.	Page
2-way	870-402	568
orange	870-519	569
white	2009-145	781

IEC/EN 60947-7-1

250 V

1000 V

0.5 A

0.08 ... 2.5 mm<sup>2</sup> / 28 ... 12 AWG

0.08 ... 4 mm<sup>2</sup> / 28 ... 12 AWG

6 ... 7 mm / 0.24 ... 0.28 inch

5 mm / 0.197 inch

Polyamide 66 (PA 66)

	Item No.	Page
2-way	870-402	568
orange	870-519	569
white	2009-145	781

IEC/EN 60947-7-1

250 V

1000 V

0.5 A

0.08 ... 2.5 mm<sup>2</sup> / 28 ... 12 AWG

0.08 ... 4 mm<sup>2</sup> / 28 ... 12 AWG

6 ... 7 mm / 0.24 ... 0.28 inch

5 mm / 0.197 inch

Polyamide 66 (PA 66)

	Item No.	Page
2-way	870-402	568
orange	870-519	569
white	2009-145	781

## Triple-Deck Diode Terminal Blocks 2.5 mm<sup>2</sup> (4 mm<sup>2</sup> "f-st"), 870 Series

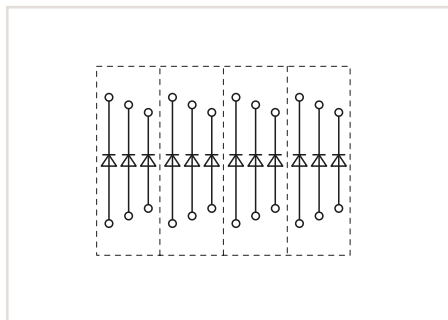

Circuit-related voltage indications can be created using the following terminal blocks:  
870-596/281-673 or 870-596/281-674

Triple-deck diode terminal blocks were specifically developed for custom diode circuits, such as lamp test and collective fault signal circuits.

These terminal blocks provide high-density wiring in a width of just 5 mm.

Push-in type jumper bars provide additional options for custom circuit design.

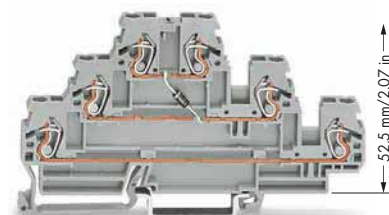

106 mm / 4.17 in

870-590/281-410

870-590/281-411

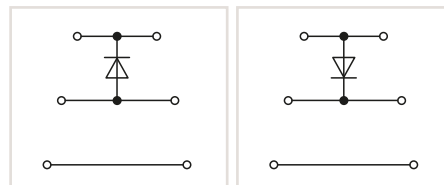

Triple-deck diode terminal block, with 1N4007 diode

Color	Item No.	Pack. Unit
● gray	870-590/281-410	50
● gray	870-590/281-411	50

### Technical Data

Ratings per	IEC/EN 60947-7-1
Nominal voltage	250 V
Reverse voltage	1000 V
Rated current	0.5 A

### Connection Data

Solid conductor	0.08 ... 2.5 mm <sup>2</sup> / 28 ... 12 AWG
Fine-stranded conductor	0.08 ... 4 mm <sup>2</sup> / 28 ... 12 AWG
Strip length	6 ... 7 mm / 0.24 ... 0.28 inch
Terminal block width	5 mm / 0.197 inch
Insulation material	Polyamide 66 (PA 66)

### Accessories (Selection)

Push-in type jumper bar, insulated, I <sub>N</sub> 18 A, light gray	
End and intermediate plate, 2 mm thick	
Mini-WSB Inline, plain, 1,700 Mini-WSB markers per reel, 5 mm wide markers	

	Item No.	Page
2-way	870-402	568
orange	870-569	569
white	2009-145	781

Accessories (jumpers, end plates, etc.), see page 568

Carrier rails and tools, see Section 13

Appropriate marking system: Mini-WSB/Mini-WSB Inline/WMB/WMB Inline, see Full Line Catalog, Volume 6

Approvals and corresponding ratings, visit [www.wago.com](http://www.wago.com)

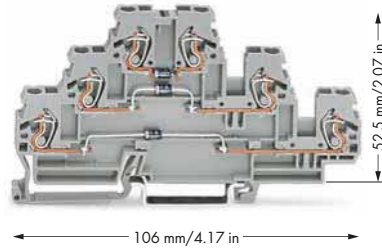
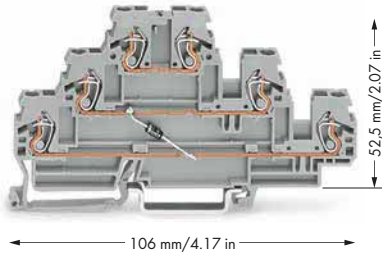

870-590/281-675      870-590/281-676

870-596/281-673      870-596/281-674

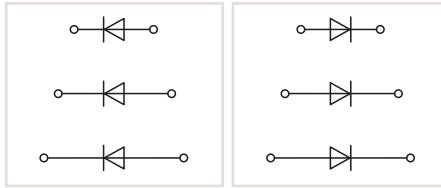
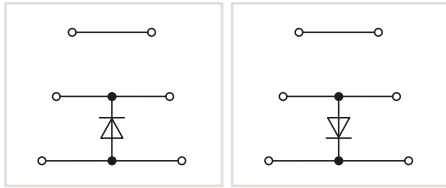

Triple-deck diode terminal block, with 1N4007 diode

Color	Item No.	Pack. Unit
● gray	870-590/281-675	50
● gray	870-590/281-676	50

Triple-deck diode terminal block, with three 1N4007 diodes

Color	Item No.	Pack. Unit
● gray	870-596/281-673	50
● gray	870-596/281-674	50

IEC/EN 60947-7-1

250 V

1000 V

0.5 A

0.08 ... 2.5 mm<sup>2</sup> / 28 ... 12 AWG

0.08 ... 4 mm<sup>2</sup> / 28 ... 12 AWG

6 ... 7 mm / 0.24 ... 0.28 inch

5 mm / 0.197 inch

Polyamide 66 (PA 66)

IEC/EN 60947-7-1

250 V

1000 V

0.5 A

0.08 ... 2.5 mm<sup>2</sup> / 28 ... 12 AWG

0.08 ... 4 mm<sup>2</sup> / 28 ... 12 AWG

6 ... 7 mm / 0.24 ... 0.28 inch

5 mm / 0.197 inch

Polyamide 66 (PA 66)

	Item No.	Page
2-way	870-402	568
orange	870-569	569
white	2009-145	781

	Item No.	Page
2-way	870-402	568
orange	870-569	569
white	2009-145	781

## Double- and Triple-Deck LED Terminal Blocks 2.5 mm<sup>2</sup> (4 mm<sup>2</sup> "f-st"), 870 Series

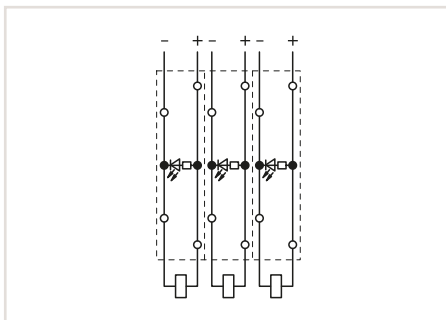

Circuit-related voltage indications can be created using the following terminal blocks:  
870-543/281-434 or 870-543/281-413

Triple-deck diode terminal blocks were specifically developed for custom diode circuits, such as lamp test and collective fault signal circuits.

These terminal blocks provide high-density wiring in a width of just 5 mm.

Push-in type jumper bars provide additional options for custom circuit design.

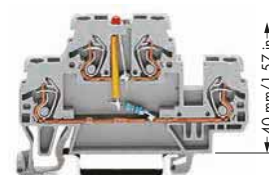

70 mm / 2.76 in

870-543/281-434

870-543/281-413

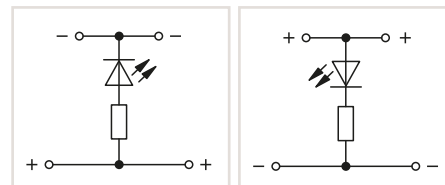

Double-deck LED terminal block, with red LED

Color	Item No.	Pack. Unit
○ gray	870-543/281-434	50
○ gray	870-543/281-413	50

### Technical Data

Ratings per	IEC/EN 60947-7-1
Voltage type	DC
Nominal voltage	24 V
Rated current	0.025 A
<b>Connection Data</b>	
Solid conductor	0.08 ... 2.5 mm <sup>2</sup> / 28 ... 12 AWG
Fine-stranded conductor	0.08 ... 4 mm <sup>2</sup> / 28 ... 12 AWG
Strip length	6 ... 7 mm / 0.24 ... 0.28 inch
Terminal block width	5 mm / 0.197 inch
Insulation material	Polyamide 66 (PA 66)

### Accessories (Selection)

Push-in type jumper bar, insulated, I <sub>N</sub> 18 A, light gray	
End and intermediate plate, 2 mm thick	
Mini-WSB Inline, plain, 1,700 Mini-WSB markers per reel, 5 mm wide markers	

	Item No.	Page
2-way	870-402	568
orange	870-519	569
white	2009-145	781

7

Accessories (jumpers, end plates, etc.), see page 568

Carrier rails and tools, see Section 13

Appropriate marking system: Mini-WSB/Mini-WSB Inline/WMB/WMB Inline, see Full Line Catalog, Volume 6

Approvals and corresponding ratings, visit [www.wago.com](http://www.wago.com)

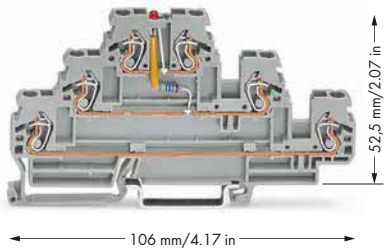

870-593/281-434

870-593/281-413

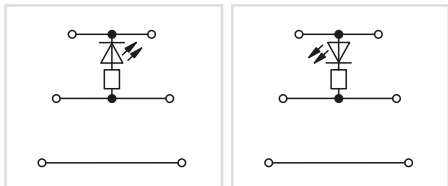

Double-deck LED terminal block, with red LED

Color	Item No.	Pack. Unit
○ gray	870-593/281-434	50
○ gray	870-593/281-413	50

IEC/EN 60947-7-1

DC

24 V

0.025 A

0.08 ... 2.5 mm<sup>2</sup> / 28 ... 12 AWG

0.08 ... 4 mm<sup>2</sup> / 28 ... 12 AWG

6 ... 7 mm / 0.24 ... 0.28 inch

5 mm / 0.197 inch

Polyamide 66 (PA 66)

	Item No.	Page
2-way	870-402	568
orange	870-569	569
white	2009-145	781

## Pluggable Tap-Off Modules, 870 Series Description and Installation

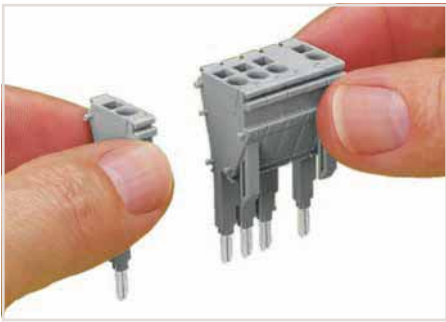

Snapping tap-off and spacer modules together to assemble a multipole tap-off module (max. 10 poles).



Module assembly with CAGE CLAMP® connections (0.25 ... 2.5 mm²/24 ... 14 AWG), including strain relief plate and marker slots for Mini-WSB or WMB markers.

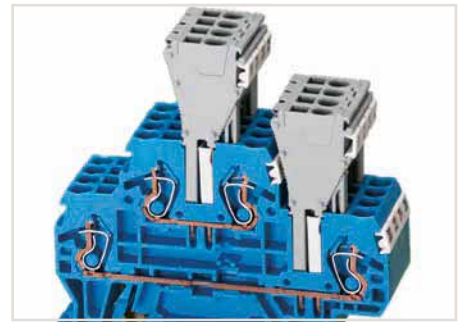

The module assembly can be directly plugged into the jumper contact slot of the current bar. The terminal blocks can also be commoned via push-in type jumper bars parallel to the jumper slots being used by the modules.

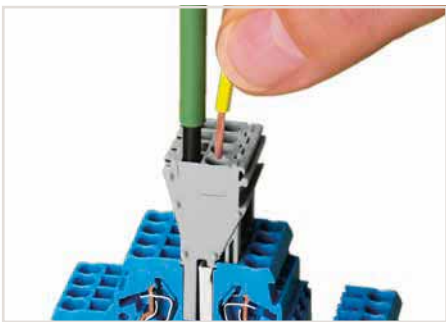

**7** CAGE CLAMP® connection  
Tap-off modules are used when additional or removable connections are required (can be used as a permanent connection or a test plug). Wiring is possible whether the modules are plugged into the assembly or not.

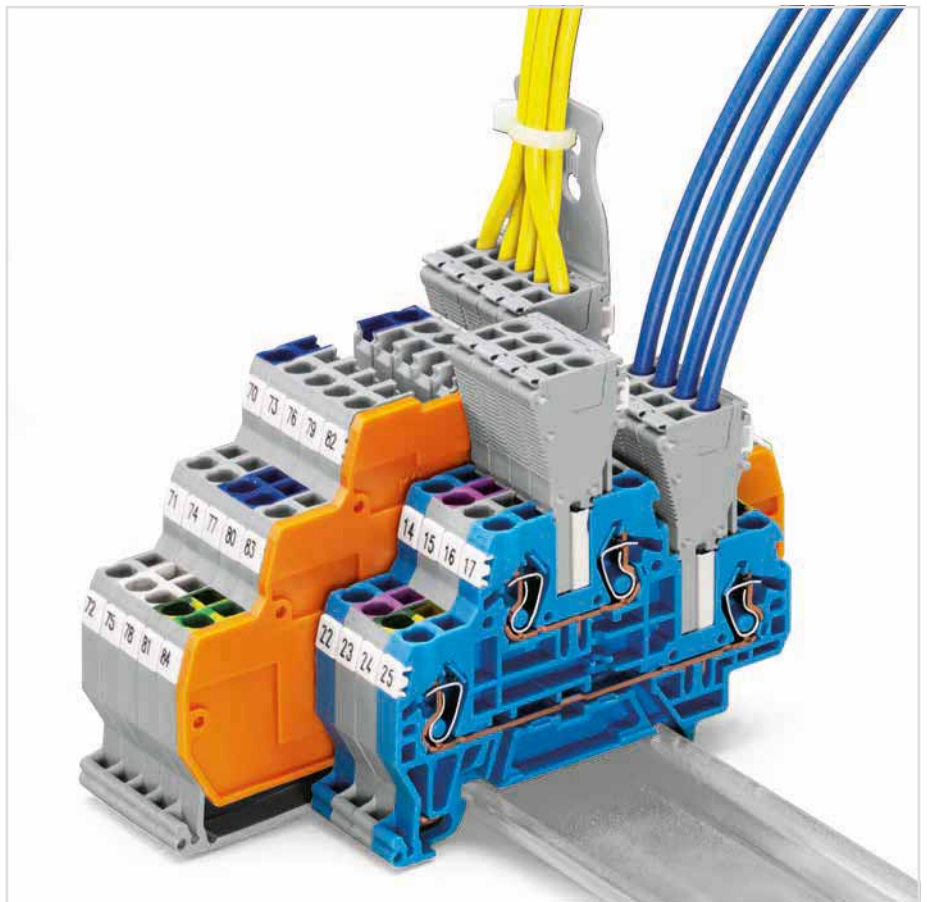

Using anti-reverse mating modules at both ends of a module assembly prevents reverse mating.



Three anti-reverse mating modules are necessary when snapping more than seven modules together.

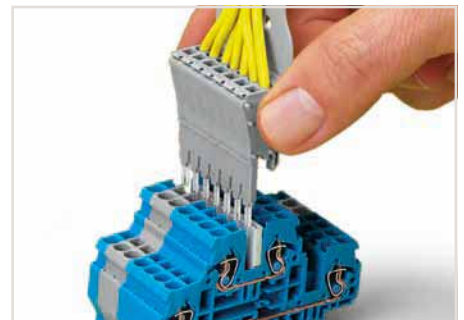

Using a pre-wired module assembly, similar to test plugs.



## Pluggable Tap-Off Modules 2.5 mm<sup>2</sup>, 870 Series

WAGO has developed modular, pluggable tap-off modules for additional wire connections, as well as serial testing on terminal block assemblies. Multipole tap-off modules readily adapt to terminal block assemblies using spacer modules, if necessary (see left page). The modules make direct contact to the jumper contact slots of the terminal blocks to be tested/tapped, even though a push-in type jumper bar is already being used.



Tap-off module, with anti-reverse mating protection, snaps together, for 870 Series rail-mount terminal blocks with jumper slots in the current bar, I<sub>n</sub>18 A

Color	Item No.	Pack. Unit
○ gray	870-425	100 (25)

Tap-off module, snaps together, for 870 Series rail-mount terminal blocks with jumper slots in the current bar, I<sub>n</sub>10 A

Color	Item No.	Pack. Unit
○ gray	870-426	100 (25)

Spacer module, snaps together, bridges terminal blocks

Color	Item No.	Pack. Unit
○ gray	870-427	100 (25)

### Technical Data

Rated voltage (III / 3)	500 V
Rated surge voltage (III / 3)	6 kV

### Connection Data

Solid conductor	0.08 ... 2.5 mm <sup>2</sup> / 28 ... 14 AWG
Fine-stranded conductor	0.08 ... 2.5 mm <sup>2</sup> / 28 ... 14 AWG
Strip length	10 mm / 0.39 inch
Module width	5 mm / 0.197 inch

### Accessories (Selection)

Mini-WSB Inline, plain, 1,700 Mini-WSB markers per reel, 5 mm wide markers	white	2009-145	781
Mini-WSB Quick marking system, white, 10 strips with 10 markers per card, 5 mm wide markers	plain	248-501	781
WMB Multi marking system, white, 10 strips with 10 markers per card, 5 ... 5.2 mm stretchable	plain	793-5501	780
WMB Multi marking system, white, 10 strips with 10 markers per card, 5 mm wide markers	plain	793-501	780
Strain relief plate, gray	35 mm wide	734-326	569

	Item No.	Page
white	2009-145	781
plain	248-501	781
plain	793-5501	780
plain	793-501	780
35 mm wide	734-326	569

 Strain relief plates, see page 569

 Appropriate marking system: Mini-WSB/Mini-WSB Inline/WMB/WMB Inline, see Full Line Catalog, Volume 6

 Approvals and corresponding ratings, visit [www.wago.com](http://www.wago.com)

## Accessories, 870 Series Compact Rail-Mount Terminal Blocks

### Commoning, Mounting, Marking and Testing



 Push-in type jumper bars, see page 548

Push-in type jumper bar, insulated, I <sub>N</sub> 18 A, light gray		
	Item No.	Pack. Unit
2-way	870-402	200 (25)
3-way	870-403	200 (25)
4-way	870-404	100 (25)
5-way	870-405	100 (25)
6-way	870-406	100 (25)
7-way	870-407	100 (25)
8-way	870-408	100 (25)
9-way	870-409	100 (25)
10-way	870-410	50 (25)



Push-in type jumper bar, insulated, I <sub>N</sub> 18 A, light gray		
	Item No.	Pack. Unit
1 to 3	870-433	200 (25)
1 to 4	870-434	200 (25)
1 to 5	870-435	100 (25)
1 to 6	870-436	100 (25)
1 to 7	870-437	100 (25)
1 to 8	870-438	100 (25)
1 to 9	870-439	100 (25)
1 to 10	870-440	50 (25)

7



Ready-made push-in type jumper bar, insulated, I <sub>N</sub> 18 A, light gray		
	Item No.	Pack. Unit
1-3-5	870-405/011-000	100 (25)
1-3-5-7	870-407/011-000	100 (25)
1-3-5-7-9	870-409/011-000	100 (25)



End and intermediate plate, 2 mm thick			
Suitable for:	Color	Item No.	Pack. Unit
870-901	orange	870-924	100 (25)
870-911	gray	870-923	100 (25)
	light gray	870-925	100 (25)



Separator, oversized, 2 mm thick			
Suitable for:	Color	Item No.	Pack. Unit
870-901	orange	870-929	100 (25)
870-911	gray	870-928	100 (25)



Separator, oversized, 2 mm thick			
Suitable for:	Color	Item No.	Pack. Unit
870-901	green-yellow	870-926	100 (25)



End and intermediate plate, 1 mm thick			
Suitable for:	Color	Item No.	Pack. Unit
870-681	orange	870-934	100 (25)
	gray	870-933	100 (25)



Separator, oversized, 1 mm thick			
Suitable for:	Color	Item No.	Pack. Unit
870-681	orange	870-947	100 (25)
	gray	870-946	100 (25)

## Accessories, 870 Series Compact Rail-Mount Terminal Blocks

### Commoning, Mounting, Marking and Testing



End and intermediate plate, 1 mm thick			
Suitable for:	Color	Item No.	Pack. Unit
870-831	orange	870-944	100 (25)
870-826	gray	870-943	100 (25)



Separator, oversized, 1 mm thick			
Suitable for:	Color	Item No.	Pack. Unit
870-831	orange	870-949	100 (25)
870-826	gray	870-948	100 (25)



End and intermediate plate, 2 mm thick			
Suitable for:	Color	Item No.	Pack. Unit
870-501	orange	870-519	100 (25)
870-540/281-410	gray	870-518	100 (25)



End and intermediate plate, 2 mm thick			
Suitable for:	Color	Item No.	Pack. Unit
870-531	orange	870-574	100 (25)
	gray	870-573	100 (25)



End and intermediate plate, 2 mm thick			
Suitable for:	Color	Item No.	Pack. Unit
870-551	orange	870-569	50 (25)
	gray	870-568	50 (25)

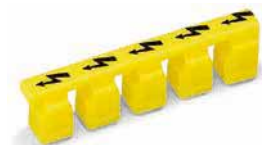

Protective warning marker, with black high-voltage symbol, for 5 terminal blocks			
Color		Item No.	Pack. Unit
yellow		280-405	100 (25)



Insulation stop, 5 pcs/strip, 0.08 ... 0.2 mm <sup>2</sup> "s" (0.14 mm <sup>2</sup> "f-st")			
Color		Item No.	Pack. Unit
white		280-470	200 (25)



Insulation stop, 5 pcs/strip, 0.25 ... 0.5 mm <sup>2</sup>			
Color		Item No.	Pack. Unit
light gray		280-471	200 (25)



Insulation stop, 5 pcs/strip, 0.75 ... 1 mm <sup>2</sup>			
Color		Item No.	Pack. Unit
dark gray		280-472	200 (25)



Strain relief plate, gray			
		Item No.	Pack. Unit
35 mm wide		734-326	100 (25)
6 mm wide		734-327	100 (25)
12.5 mm wide		734-328	100 (25)
25 mm wide		734-329	100 (25)

## Sensor and Actuator Terminal Blocks, 270 Series Description and Installation

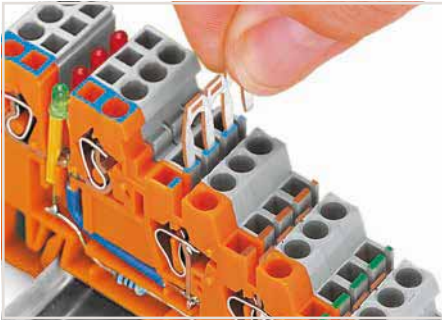

Inserting a jumper.

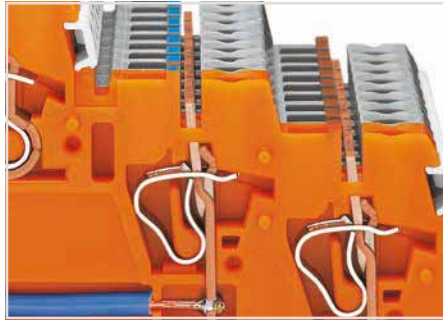

Commoning a supply voltage using uninsulated push-in type jumper bars, 2- to 9-way or 17-way (2 x 8 bits), depending on application.



Commoning signal level voltage via insulated push-in type jumper bars (870 Series) – 2- to 9-way, depending on application.  
**Sensor LED terminal blocks cannot be commoned!**



Terminal block assembly:  
Sensor terminal blocks



Terminal block assembly:  
Sensor LED terminal blocks

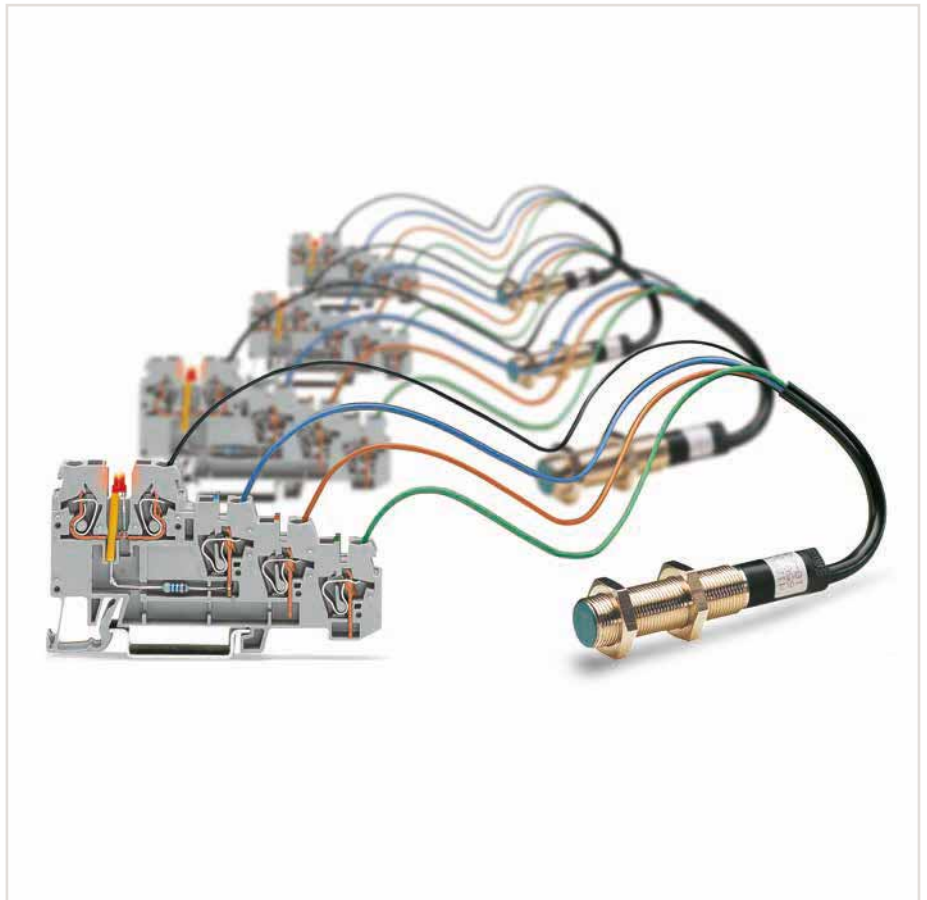

Marking strip (Item No. 709-196)  
**Not suitable for LED terminal blocks!**

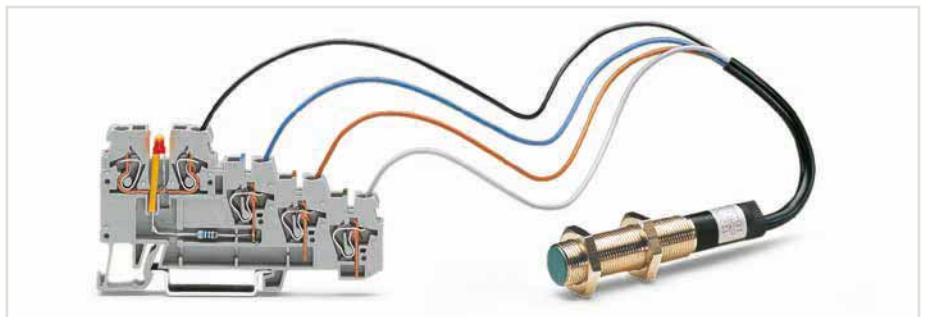

Sensor LED block

7

## Accessories, 2000 Series Sensor and Actuator Terminal Blocks Commoning, Mounting, Marking and Testing



Push-in type jumper bar, insulated, I <sub>N</sub> 18 A, light gray		
	Item No.	Pack. Unit
2-way	870-402	200 (25)
3-way	870-403	200 (25)
4-way	870-404	100 (25)
5-way	870-405	100 (25)
6-way	870-406	100 (25)
7-way	870-407	100 (25)
8-way	870-408	100 (25)
9-way	870-409	100 (25)
10-way	870-410	50 (25)



Jumpers can be shortened using an electronic side cutter. I<sub>N</sub> 18 A

Push-in type jumper bar, uninsulated, I <sub>N</sub> 18 A		
	Item No.	Pack. Unit
9-way	270-409	100 (25)
17-way	270-417	100 (25)
80-way	270-480	10



End and intermediate plate, 1 mm thick, for triple-deck terminal blocks			
Suitable for:	Color	Item No.	Pack. Unit
270-560	orange	270-321	100 (25)
270-572	gray	270-319	100 (25)

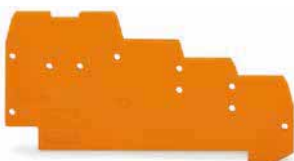

End and intermediate plate, 1 mm thick, for quadruple-deck terminal blocks			
Suitable for:	Color	Item No.	Pack. Unit
270-570	orange	270-322	100 (25)
	gray	270-320	100 (25)



Insulation stop, 5 pcs/strip, 0.08 ... 0.2 mm <sup>2</sup> "s" (0.14 mm <sup>2</sup> "f-st")		
Color	Item No.	Pack. Unit
white	280-470	200 (25)



Insulation stop, 5 pcs/strip, 0.25 ... 0.5 mm <sup>2</sup>		
Color	Item No.	Pack. Unit
light gray	280-471	200 (25)



Insulation stop, 5 pcs/strip, 0.75 ... 1 mm <sup>2</sup>		
Color	Item No.	Pack. Unit
dark gray	280-472	200 (25)

## 3-Conductor Sensor Terminal Blocks and 3-Conductor Sensor LED Terminal Blocks 2.5 mm<sup>2</sup>, 270 Series

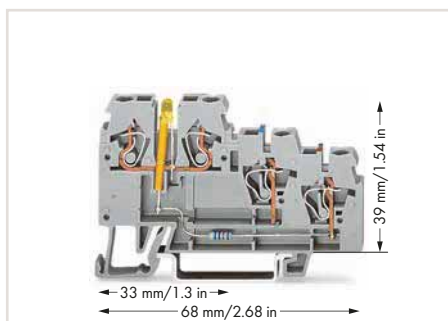

270-560/281-507  
3-conductor sensor LED terminal block, for NPN (low-side) switching sensors, for DIN-35 rail

Pluggable tap-off modules (870-425, 870-426, 870-427) can be used on the signal level.

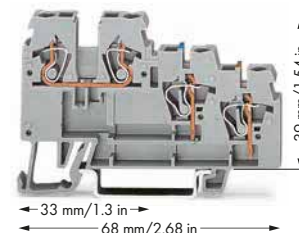

270-560

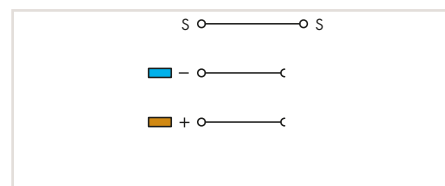

3-conductor sensor terminal block, for DIN-35 rail

Color	Item No.	Pack. Unit
gray	270-560	50

7

### Technical Data

Voltage type	
Nominal voltage	
Rated voltage (III / 3)	250 V
Rated surge voltage (III / 3)	4 kV
Rated current	18 A
Approval	300 V
<b>Connection Data</b>	300 V, 20 A <b>VA</b> ; 300 V, 10 A <b>A</b>
Solid conductor	0.08 ... 2.5 mm <sup>2</sup> / 28 ... 12 AWG
Fine-stranded conductor	0.08 ... 2.5 mm <sup>2</sup> / 28 ... 12 AWG
Note (conductor cross section)	12 AWG: THHN, THWN
Strip length	6 ... 7 mm / 0.24 ... 0.28 inch
Terminal block width	5 mm / 0.197 inch
Insulation material	Polyamide 66 (PA 66)

### Accessories (Selection)

	Item No.	Page
Push-in type jumper bar, uninsulated, I <sub>N</sub> 18 A	270-409	571
Push-in type jumper bar, insulated, I <sub>N</sub> 18 A, light gray	870-402	571
End and intermediate plate, 1 mm thick, for triple-deck terminal blocks	270-321	571
Mini-WSB Inline, plain, 1,700 Mini-WSB markers per reel, 5 mm wide markers	2009-145	781

Accessories (jumpers, end plates, etc.), see page 571

Carrier rails and tools, see Section 13

Appropriate marking system: Mini-WSB/Mini-WSB Inline/WMB/WMB Inline, see Full Line Catalog, Volume 6

Approvals and corresponding ratings, visit [www.wago.com](http://www.wago.com)





## 4-Conductor Sensor Terminal Blocks and 4-Conductor Sensor LED Terminal Blocks 2.5 mm<sup>2</sup>, 270 Series

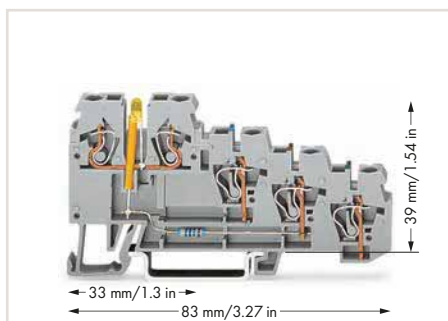

270-570/281-507  
4-conductor sensor LED terminal block, for NPN (low-side) switching sensors, for DIN-35 rail

Pluggable tap-off modules (870-425, 870-426, 870-427) can be used on the signal level.

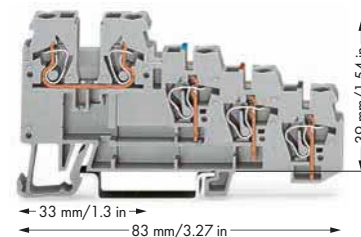

270-570

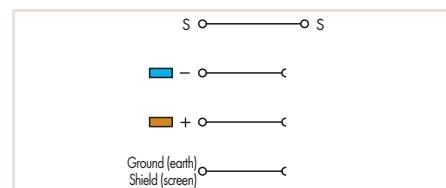

3-conductor sensor terminal block, for DIN-35 rail

Color	Item No.	Pack. Unit
gray	270-570	50

7

### Technical Data

Voltage type	
Nominal voltage	
Rated voltage (III / 3)	250 V
Rated surge voltage (III / 3)	4 kV
Rated current	18 A
Approval	300 V
<b>Connection Data</b>	300 V, 20 A <b>VA</b> ; 300 V, 10 A <b>A</b>
Solid conductor	0.08 ... 2.5 mm <sup>2</sup> / 28 ... 12 AWG
Fine-stranded conductor	0.08 ... 2.5 mm <sup>2</sup> / 28 ... 12 AWG
Note (conductor cross section)	12 AWG: THHN, THWN
Strip length	6 ... 7 mm / 0.24 ... 0.28 inch
Terminal block width	5 mm / 0.197 inch
Insulation material	Polyamide 66 (PA 66)

### Accessories (Selection)

Push-in type jumper bar, uninsulated, I <sub>N</sub> 18 A	9-way	270-409	571
Push-in type jumper bar, insulated, I <sub>N</sub> 18 A, light gray	2-way	870-402	571
End and intermediate plate, 1 mm thick, for triple-deck terminal blocks	orange	270-322	571
Mini-WSB Inline, plain, 1,700 Mini-WSB markers per reel, 5 mm wide markers	white	2009-145	781

Accessories (jumpers, end plates, etc.), see page 571

Carrier rails and tools, see Section 13

Appropriate marking system: Mini-WSB/Mini-WSB Inline/WMB/WMB Inline, see Full Line Catalog, Volume 6

Approvals and corresponding ratings, visit [www.wago.com](http://www.wago.com)



# 3-Conductor Actuator Terminal Blocks and 3-Conductor Actuator LED Terminal Blocks

## 2.5 mm<sup>2</sup>, 270 Series

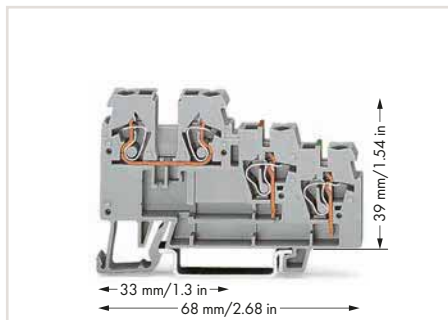

270-585  
3-conductor actuator terminal block, for DIN-35 rail

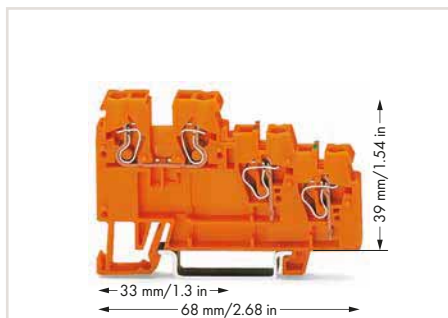

270-586  
3-conductor actuator terminal block, for DIN-35 rail

Pluggable tap-off modules (870-425, 870-426, 870-427) can be used on the signal level.

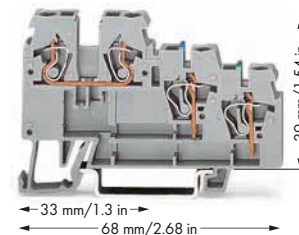

270-572

270-585

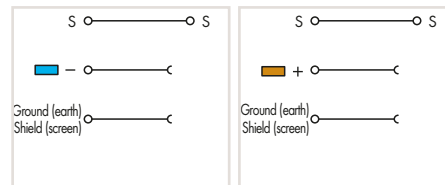

3-conductor actuator terminal block, for DIN-35 rail

Color	Item No.	Pack. Unit
gray	270-572	50

3-conductor actuator terminal block, for DIN-35 rail

Color	Item No.	Item No.
gray	270-585	50



### Technical Data

Voltage type	
Nominal voltage	
Rated voltage (III / 3)	250 V
Rated surge voltage (III / 3)	4 kV
Rated current	18 A
Approval	300 V
<b>Connection Data</b>	300 V, 20 A ; 300 V, 10 A
Solid conductor	0.08 ... 2.5 mm <sup>2</sup> / 28 ... 12 AWG
Fine-stranded conductor	0.08 ... 2.5 mm <sup>2</sup> / 28 ... 12 AWG
Note (conductor cross section)	12 AWG: THHN, THWN
Strip length	6 ... 7 mm / 0.24 ... 0.28 inch
Terminal block width	5 mm / 0.197 inch
Insulation material	Polyamide 66 (PA 66)

### Accessories (Selection)

Push-in type jumper bar, uninsulated, I <sub>N</sub> 18 A	9-way	270-409	571
Push-in type jumper bar, insulated, I <sub>N</sub> 18 A, light gray	2-way	870-402	571
End and intermediate plate, 1 mm thick, for triple-deck terminal blocks	orange	270-321	571
Mini-WSB Inline, plain, 1,700 Mini-WSB markers per reel, 5 mm wide markers	white	2009-145	781

Accessories (jumpers, end plates, etc.), see page 571

Carrier rails and tools, see Section 13

Appropriate marking system: Mini-WSB/Mini-WSB Inline/WMB/WMB Inline, see Full Line Catalog, Volume 6

Approvals and corresponding ratings, visit [www.wago.com](http://www.wago.com)











# Modular Terminal Blocks and Terminal Strips



## Modular Terminal Blocks and Terminal Strips Side-/Front-Entry Wiring

			Page
	<b>Modular Terminal Blocks and Terminal Strips with Mounting Flanges or Snap-In Mounting Feet, Front-Entry Wiring</b> 2.5 (4 "f-st") mm <sup>2</sup> (12 AWG)	869 Series	582
	<b>Modular Terminal Blocks and Terminal Strips with Mounting Flanges or Snap-In Mounting Feet, Front-Entry Wiring</b> 2.5 mm <sup>2</sup> (12 AWG)	264 Series	590
	<b>Modular Terminal Blocks and Terminal Strips with Mounting Flanges or Snap-In Mounting Feet, Side-Entry Wiring</b> 0.08 ... 1.5 mm <sup>2</sup> (28 ... 16 AWG) / 2.5 mm <sup>2</sup> / 4 mm <sup>2</sup> (14 AWG / 12 AWG)	260/261/262 Series	602
	<b>Modular Terminal Blocks and Terminal Strips with Push-Buttons on One or Both Sides</b> 0.08 ... 1.5 mm <sup>2</sup> (28 ... 16 AWG)	261 Series	608
	<b>Modular Terminal Blocks and Terminal Strips with Mini-WSB Marker Slot and Push-Buttons on One or Both Sides</b> 1.5 mm <sup>2</sup> (16 AWG)	261 Series	616
	<b>Accessories for Modular Terminal Blocks and Terminal Strips</b>	260/261/262 Series	622

## Modular Terminal Blocks and Terminal Strips, 869 Series Description and Installation

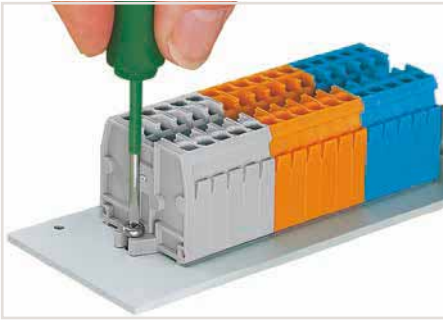

Mounting and securing a terminal strip directly to the plate via screw-type flanges.

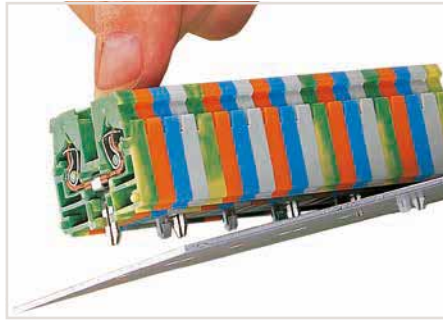

Mounting a terminal strip with snap-in feet into holes.

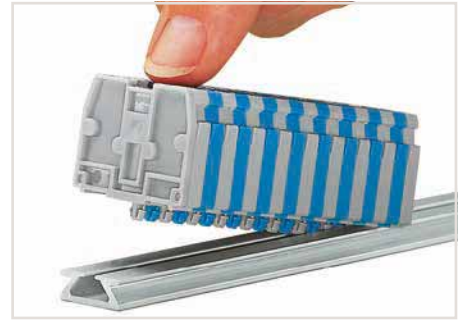

Mounting a terminal strip with snap-in feet onto aluminum rail.

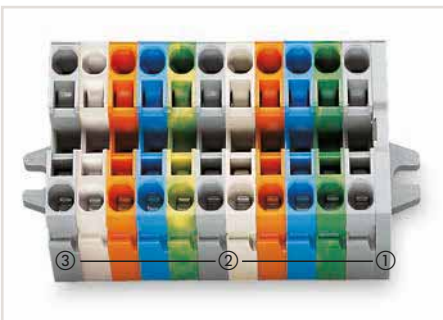

Terminal strip with mounting flanges:

- End plate with mounting flange ①
- Center terminal blocks ②
- End terminal block with mounting flange ③



8

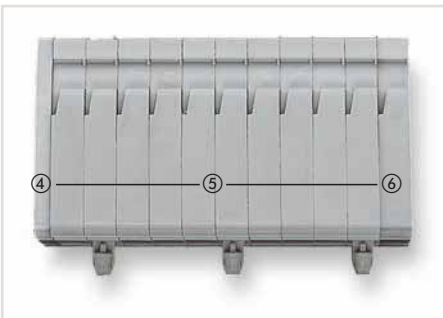

Terminal strip with snap-in mounting feet:

- End plate ④
- Center terminal blocks with/without snap-in mounting feet ⑤
- End terminal block with/without snap-in mounting foot ⑥

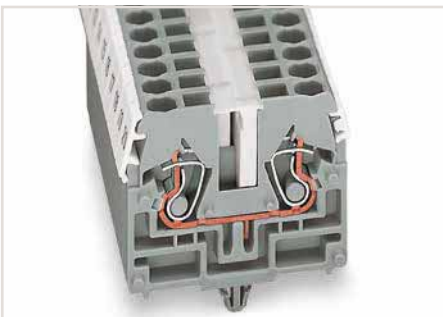

WMB markers in Mini-WSB marker slots  
Marking strip, translucent  
Mini-WSB markers



Push jumper bars down firmly until fully inserted. When using multipole bars, push alternately on the right and then left side until installed. Push-in type jumper bars 1-3-5-7 or 1-4-7 are available upon request.



Protective warning markers (280-405), with a black high-voltage symbol

## Dimensional Drawing, 869 Series

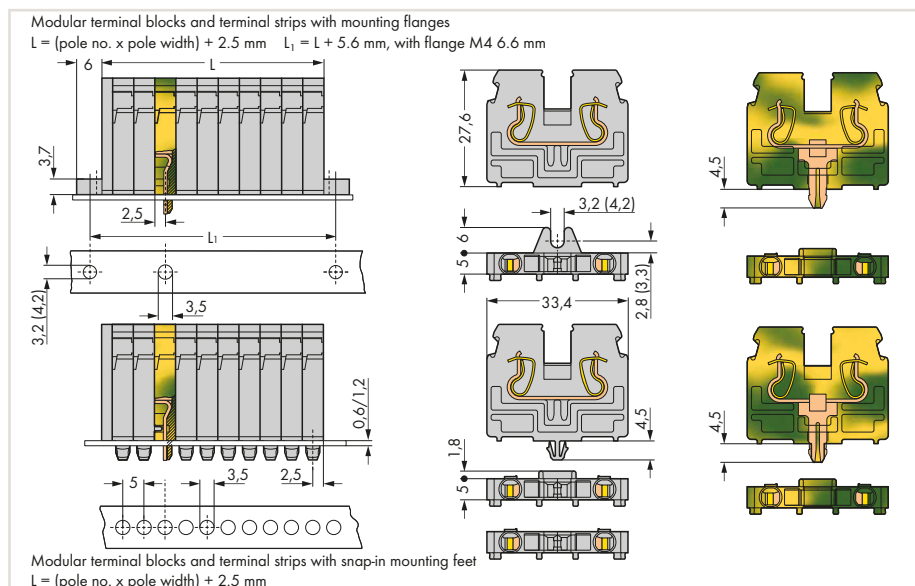

Dimensions in mm  
 Modular terminal blocks and terminal strips with mounting flanges or snap-in mounting feet

## Modular Terminal Blocks with Mounting Flanges or Snap-in Mounting Feet 2.5 mm<sup>2</sup> (4 mm<sup>2</sup> "f-st"), 869 Series



Terminal strips with M3 or M4 mounting flanges, for screw or similar mounting types, mounting holes:  
3.2 mm Ø, M3 flange  
4.2 mm Ø, M4 flange



Terminal strips with snap-in mounting feet, for 0.6 ... 1.2 mm plate thickness, mounting holes: 3.5<sup>+0.1</sup> mm Ø

Terminal blocks with a blue insulated housing are suitable for Ex i applications.

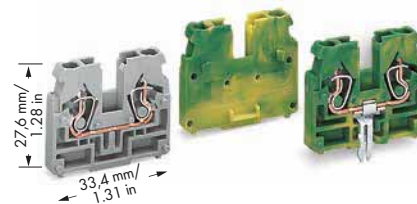

Center terminal block, without snap-in mounting foot, for 0.6 ... 1.2 mm plate thickness, required between end plate and end terminal block for terminal strips with mounting flanges

Color	Item No.	Pack. Unit
gray	869-321	100
blue	869-324	100
orange	869-326	100
green-yellow	869-327	100
light gray	869-329	100

Center terminal block, with direct ground contact, 0.5 + 0.1 mm drilled hole diameter, required between end plate and end terminal block for terminal strips with mounting flanges  
Notice: Terminal block cannot be commoned!

Color	Item No.	Pack. Unit
green-yellow	869-328	100

8

### Technical Data

Rated voltage (III / 3)	500 V
Rated surge voltage (III / 3)	6 kV
Rated current	24 A
Approval	300 V, 20 A,
<b>Connection Data</b>	
Solid conductor	0.08 ... 2.5 mm <sup>2</sup> / 28 ... 12 AWG
Fine-stranded conductor	0.08 ... 4 mm / 28 ... 12 AWG
Strip length	6 ... 7 mm / 0.24 ... 0.28 inch
Terminal block width	5 mm / 0.197 inch
Insulation material	Polyamide 66 (PA 66)
<b>Note</b>	Max. insulation diameter: 4.4 mm

### Accessories (Selection)

	Item No.	Page
Push-in type jumper bar, insulated, I <sub>N</sub> 18 A, light gray	2-pole 870-402	586
End plate, with M3 mounting flange, 2.5 mm thick	gray 869-385	586
End plate, with M4 mounting flange, 2.5 mm thick	gray 869-395	586
End plate, for terminal blocks with snap-in mounting foot, 2.5 mm thick		
Aluminum carrier rail, 1000 mm long, 18 mm wide, 7 mm high		
Plastic end stop, with WSB marker slot, for aluminum carrier rail (210-154) Width 6 mm		
Mini-WSB Inline, plain, 1,700 Mini-WSB markers per reel, 5 mm wide markers	white 2009-145	781

Dimensional drawing, see page 581

Accessories (jumpers, end plates, etc.), see page 586

Tools, see Section 13

Appropriate marking system: Mini-WSB/Mini-WSB Inline/WMB/WMB Inline, see Full Line Catalog, Volume 6

Approvals and corresponding ratings, visit [www.wago.com](http://www.wago.com)



End terminal block, with M4 mounting flange, for screw or similar mounting types, 3.2 mm mounting hole diameter

Color	Item No.	Pack. Unit
○ gray	869-301	100
● blue	869-304	100
● green-yellow	869-307	100
○ light gray	869-309	100

End terminal block, with snap-in mounting foot, for 0.6 ... 1.2 mm plate thickness, 3.5 + 0.1 mm mounting hole diameter

Color	Item No.	Pack. Unit
○ gray	869-331	100
● blue	869-334	100
● green-yellow	869-337	100
○ light gray	869-339	100

Center terminal block, with snap-in mounting foot, for 0.6 ... 1.2 mm plate thickness, 3.5 + 0.1 mm mounting hole diameter

Color	Item No.	Pack. Unit
○ gray	869-311	100
● blue	869-314	100
● orange	869-316	100
● green-yellow	869-317	100
○ light gray	869-319	100

End terminal block, with M4 mounting flange, for screw or similar mounting types, 4.2 mm mounting hole diameter

Color	Item No.	Pack. Unit
○ gray	869-351	100
● blue	869-354	100
● green-yellow	869-357	100
○ light gray	869-359	100

End terminal block, without snap-in mounting foot, for 0.6 ... 1.2 mm plate thickness

Color	Item No.	Pack. Unit
○ gray	869-341	100
● blue	869-344	100
● green-yellow	869-347	100
○ light gray	869-349	100



500 V  
6 kV  
24 A  
300 V, 20 A

0.08 ... 2.5 mm<sup>2</sup> / 28 ... 12 AWG  
0.08 ... 4 mm / 28 ... 12 AWG  
6 ... 7 mm / 0.24 ... 0.28 inch  
5 mm / 0.197 inch  
Polyamide 66 (PA 66)  
Max. insulation diameter: 4.4 mm

	Item No.	Page
2-pole	870-402	586
white	2009-145	781



500 V  
6 kV  
24 A  
300 V, 20 A

0.08 ... 2.5 mm<sup>2</sup> / 28 ... 12 AWG  
0.08 ... 4 mm / 28 ... 12 AWG  
6 ... 7 mm / 0.24 ... 0.28 inch  
5 mm / 0.197 inch  
Polyamide 66 (PA 66)  
Max. insulation diameter: 4.4 mm

	Item No.	Page
2-pole	870-402	586
gray	869-375	586
silver	210-154	586
gray	209-122	587
white	2009-145	781



500 V  
6 kV  
24 A  
300 V, 20 A

0.08 ... 2.5 mm<sup>2</sup> / 28 ... 12 AWG  
0.08 ... 4 mm / 28 ... 12 AWG  
6 ... 7 mm / 0.24 ... 0.28 inch  
5 mm / 0.197 inch  
Polyamide 66 (PA 66)  
Max. insulation diameter: 4.4 mm

	Item No.	Page
2-pole	870-402	586
gray	869-375	586
silver	210-154	586
gray	209-122	586
white	2009-145	781



## Compact Terminal Strips with Mounting Flanges or Snap-in Mounting Feet 2.5 mm<sup>2</sup> (4 mm<sup>2</sup> "f-st"), 869 Series



Terminal strips with M3 or M4 mounting flanges, for screw or similar mounting types, mounting holes:  
3.2 mm Ø, M3 flange  
4.2 mm Ø, M4 flange



Terminal strips with snap-in mounting feet, for 0.6 ... 1.2 mm plate thickness, mounting holes: 3.5<sup>+0.1</sup> mm Ø



Inserting an insulation stop into conductor entry holes of terminal strip.

### Technical Data

Rated voltage (III / 3)	500 V
Rated surge voltage (III / 3)	6 kV
Rated current	24 A
<b>Connection Data</b>	
Connection technology	CAGE CLAMP COMPACT
Solid conductor	0.08 ... 2.5 mm <sup>2</sup> / 28 ... 12 AWG
Fine-stranded conductor	0.08 ... 4 mm / 28 ... 12 AWG
Strip length	6 ... 7 mm / 0.24 ... 0.28 inch
Approval	300 V, 20 A, 
Module width	5 mm / 0.197 inch
Insulation material	Polyamide 66 (PA 66)

Longer strips and/or mixed-color assemblies are available upon request.

Item no. suffixes for gray terminal strips in:

blue .../000-006  
green-yellow .../000-016  
869-102 to 869-112  
869-202 to 869-212

Terminal strips with a blue insulated housing are suitable for Ex i applications.

8

 Dimensional drawing,  
see page 581

 Tools,  
see Section 13

 Appropriate marking system:  
Mini-WSB/Mini-WSB Inline/WMB/WMB Inline,  
see Full Line Catalog, Volume 6

 Approvals and corresponding ratings,  
visit [www.wago.com](http://www.wago.com)

### Accessories (Selection)

	Item No.	Page
Push-in type jumper bar, insulated, I <sub>n</sub> 18 A, light gray	870-402	586
Mini-WSB Inline, plain, 1,700 Mini-WSB markers (5 mm wide) per reel	2009-145	781



## Compact Terminal Strips with Mounting Flanges or Snap-in Mounting Feet 2.5 mm<sup>2</sup> (4 mm<sup>2</sup> "f-st"), 869 Series



Compact terminal strip, with M3 mounting flanges, for screw or similar mounting types, 3.2 mm mounting hole diameter, gray

Pole No.	Item No.	Pack. Unit
○ 2	869-102	100
○ 3	869-103	100
○ 4	869-104	100
○ 5	869-105	100
○ 6	869-106	50
○ 7	869-107	50
○ 8	869-108	50
○ 9	869-109	50
○ 10	869-110	25
○ 11	869-111	25
○ 12	869-112	25

Compact terminal strip, with M4 mounting flanges, for screw or similar mounting types, 4.2 mm mounting hole diameter, gray

Pole No.	Item No.	Pack. Unit
○ 2	869-202	100
○ 3	869-203	100
○ 4	869-204	100
○ 5	869-205	100
○ 6	869-206	50
○ 7	869-207	50
○ 8	869-208	50
○ 9	869-209	50
○ 10	869-210	25
○ 11	869-211	25
○ 12	869-212	25

Compact terminal strip, with snap-in mounting feet, for 0.6 ... 1.2 mm plate thickness, 3.5 + 0.1 mm mounting hole diameter, gray

Pole No.	Item No.	Pack. Unit
○ 2	869-152	100
○ 3	869-153	100
○ 4	869-154	100
○ 5	869-155	100
○ 6	869-156	50
○ 7	869-157	50
○ 8	869-158	50
○ 9	869-159	50
○ 10	869-160	25
○ 11	869-161	25
○ 12	869-162	25

Compact terminal strip, with M3 mounting flanges, for screw or similar mounting types, 3.2 mm mounting hole diameter, light gray

Pole No.	Item No.	Pack. Unit
○ 2	869-132	100
○ 3	869-133	100
○ 4	869-134	100
○ 5	869-135	100
○ 6	869-136	50
○ 7	869-137	50
○ 8	869-138	50
○ 9	869-139	50
○ 10	869-140	25
○ 11	869-141	25
○ 12	869-142	25

Compact terminal strip, with M4 mounting flanges, for screw or similar mounting types, 4.2 mm mounting hole diameter, light gray

Pole No.	Item No.	Pack. Unit
○ 2	869-232	100
○ 3	869-233	100
○ 4	869-234	100
○ 5	869-235	100
○ 6	869-236	50
○ 7	869-237	50
○ 8	869-238	50
○ 9	869-239	50
○ 10	869-240	25
○ 11	869-241	25
○ 12	869-242	25

Compact terminal strip, with snap-in mounting feet, for 0.6 ... 1.2 mm plate thickness, 3.5 + 0.1 mm mounting hole diameter, light gray

Pole No.	Item No.	Pack. Unit
○ 2	869-182	100
○ 3	869-183	100
○ 4	869-184	100
○ 5	869-185	100
○ 6	869-186	50
○ 7	869-187	50
○ 8	869-188	50
○ 9	869-189	50
○ 10	869-190	25
○ 11	869-191	25
○ 12	869-192	25



## Accessories for 869 Series Modular Terminal Blocks and Terminal Strips

### Commoning, Mounting, Marking and Testing



 Push-in type jumper bars, see page 580

#### Push-in type jumper bar, insulated, I<sub>n</sub> 18 A, light gray

	Item No.	Pack. Unit
2-pole	870-402	200 (25)
3-way	870-403	200 (25)
4-way	870-404	100 (25)
5-way	870-405	100 (25)
6-way	870-406	100 (25)
7-way	870-407	100 (25)
8-way	870-408	100 (25)
9-way	870-409	100 (25)
10-way	870-410	50 (25)

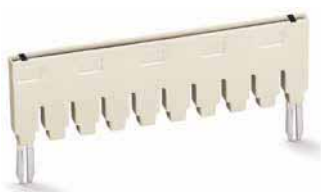

#### Push-in type jumper bar, insulated, I<sub>n</sub> 18 A, light gray

	Item No.	Pack. Unit
1 to 3	870-433	200 (25)
1 to 4	870-434	200 (25)
1 to 5	870-435	100 (25)
1 to 6	870-436	100 (25)
1 to 7	870-437	100 (25)
1 to 8	870-438	100 (25)
1 to 9	870-439	100 (25)
1 to 10	870-440	50 (25)



#### Ready-made push-in type jumper bar, insulated, I<sub>n</sub> 18 A, light gray

	Item No.	Pack. Unit
1-3-5	870-405/011-000	100 (25)
1-3-5-7	870-407/011-000	100 (25)
1-3-5-7-9	870-409/011-000	100 (25)

8



#### End plate, with M3 mounting flange, 2.5 mm thick

Suitable for:	Color	Item No.	Pack. Unit
869-321	gray	869-385	100 (25)
	blue	869-388	100 (25)
	green-yellow	869-389	100 (25)
	light gray	869-387	100 (25)



#### End plate, with M4 mounting flange, 2.5 mm thick

Suitable for:	Color	Item No.	Pack. Unit
869-321	gray	869-395	100 (25)
	blue	869-398	100 (25)
	green-yellow	869-399	100 (25)
	light gray	869-397	100 (25)



#### End plate, for terminal blocks with snap-in mounting foot, 2.5 mm thick

Suitable for:	Color	Item No.	Pack. Unit
869-321	gray	869-375	100 (25)
	blue	869-378	100 (25)
	green-yellow	869-379	100 (25)
	light gray	869-377	100 (25)



#### Aluminum carrier rail, 1000 mm long, 18 mm wide, 7 mm high

Suitable for:	Color	Item No.	Pack. Unit
869-331	silver	210-154	1
869-341			
869-311			

## Accessories for 869 Series Modular Terminal Blocks and Terminal Strips

### Commoning, Mounting, Marking and Testing



Plastic end stop, with WSB marker slot, for aluminum carrier rail (210-154) Width 6 mm			
Suitable for:	Color	Item No.	Pack. Unit
869-331	gray	209-122	25
869-341			
869-311			



Protective warning marker, with black high-voltage symbol, for 5 terminal blocks		
Color	Item No.	Pack. Unit
yellow	280-405	100 (25)



Insulation stop, 5 pcs/strip, 0.08 ... 0.2 mm <sup>2</sup> "s" (0.14 mm <sup>2</sup> "f-st")		
Color	Item No.	Pack. Unit
white	280-470	200 (25)



Insulation stop, 5 pcs/strip, 0.25 ... 0.5 mm <sup>2</sup>		
Color	Item No.	Pack. Unit
light gray	280-471	200 (25)



Insulation stop, 5 pcs/strip, 0.75 ... 1 mm <sup>2</sup>		
Color	Item No.	Pack. Unit
dark gray	280-472	200 (25)

## Modular Terminal Blocks and Terminal Strips, 264 Series Description and Installation

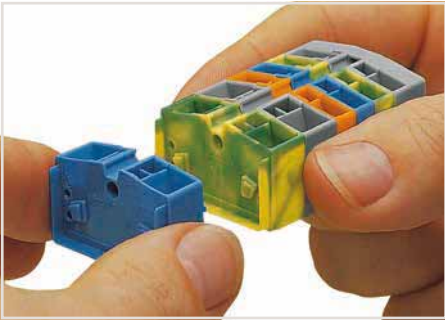

Assembling modular terminal blocks into terminal strips.

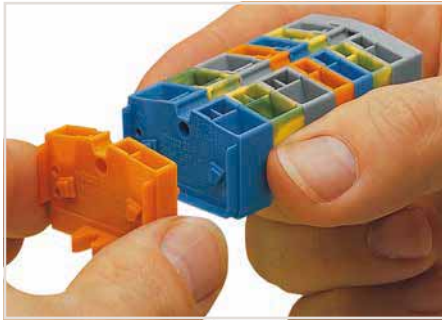

Mounting an "end terminal block" with mounting flange.

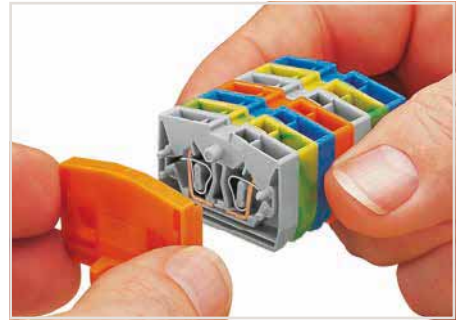

Mounting an end plate.



**CAGE CLAMP® connection**  
Inserting a conductor via screwdriver.  
With ferruled conductors, it is necessary to use a terminal block one size smaller than the conductor's nominal cross section.

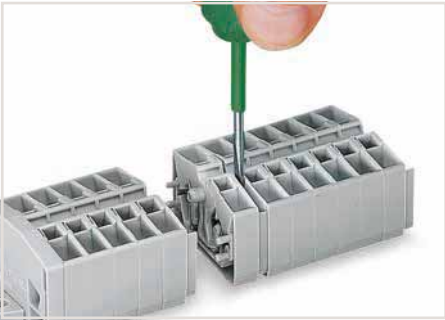

Removing a terminal block.

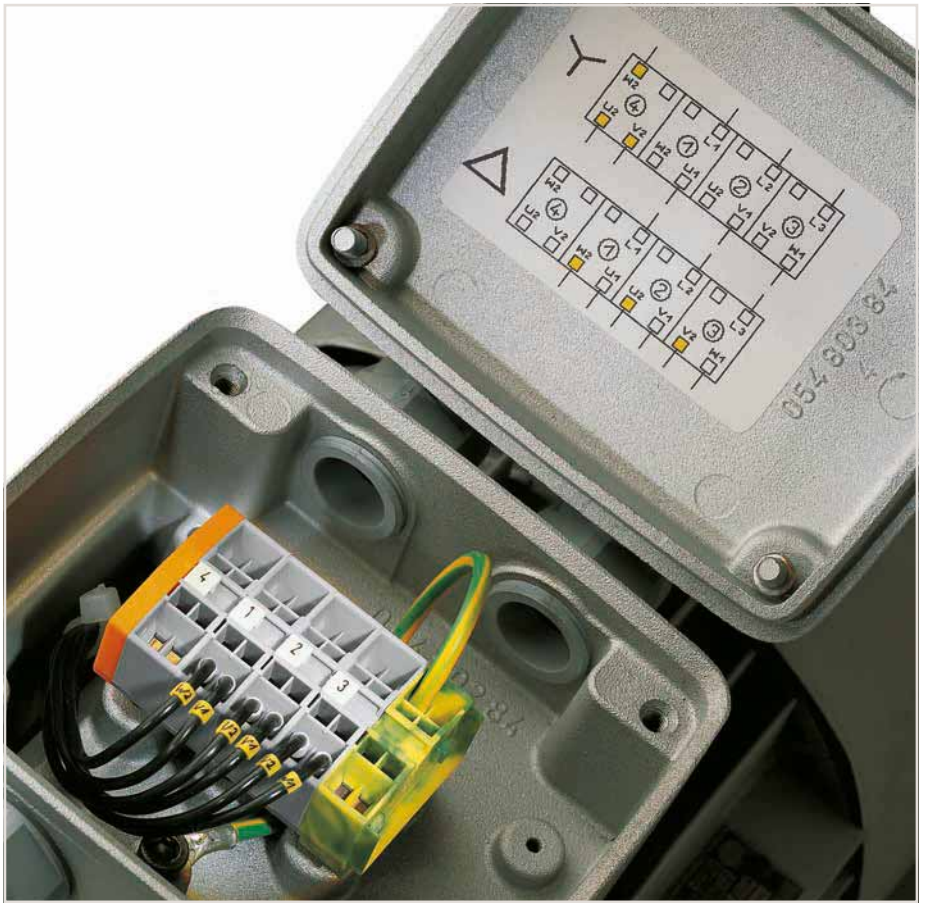

8

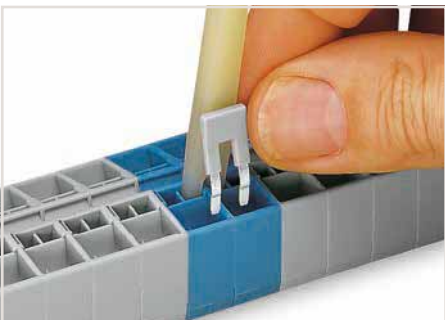

Commoning with comb-style jumper bar.



Marking with T-marker tag (209-290).



Combining 2- and 4-conductor terminal blocks.  
Marking via Mini-WSB Quick markers.





Mounting and securing a terminal strip directly to the plate via screw-type flanges.

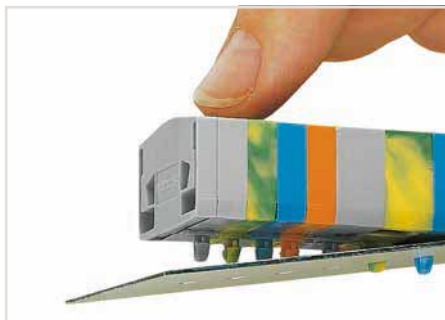

Mounting a terminal strip with snap-in feet into holes.

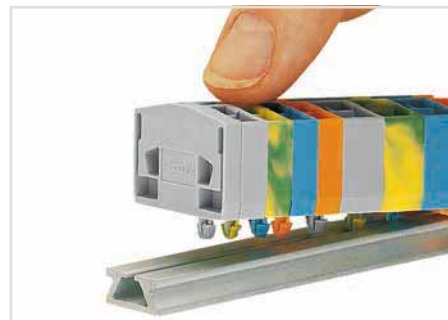

Mounting a terminal strip with snap-in feet onto aluminum rail.

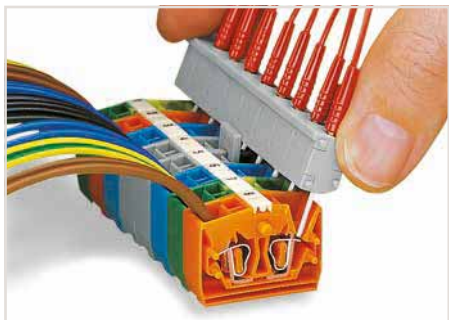
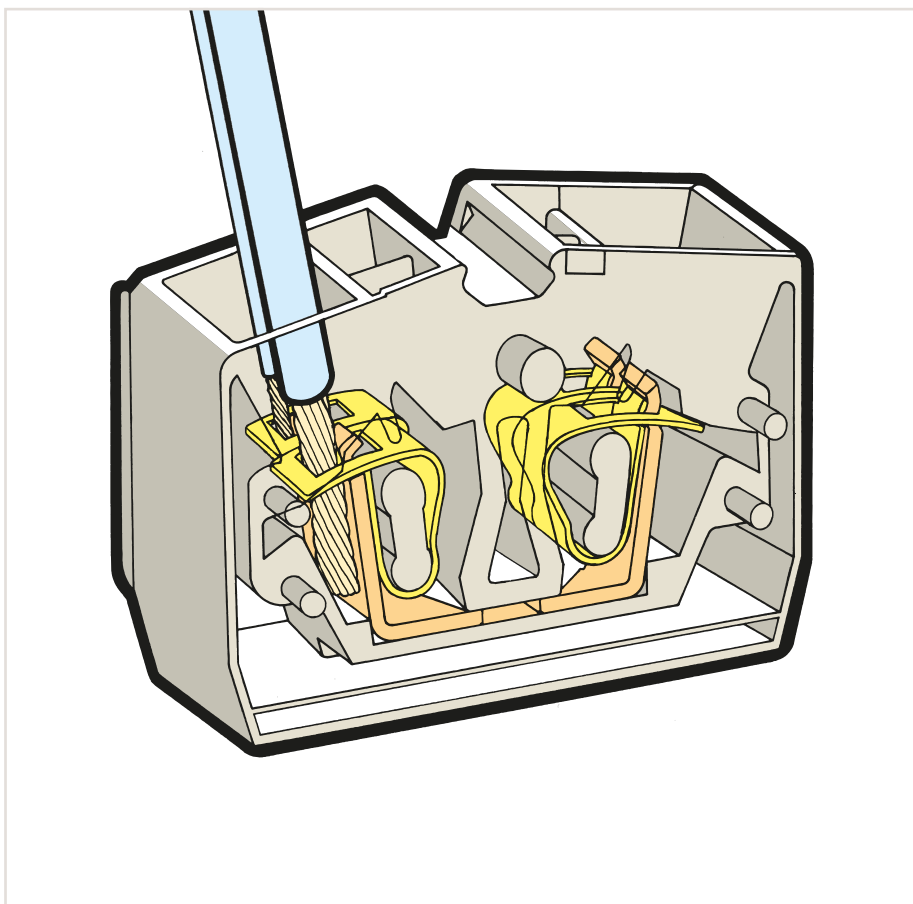

Testing by touch contact to the CAGE CLAMP® spring (limited to 0.5 A and 48 V test voltage) – test pins are not protected against accidental contact.

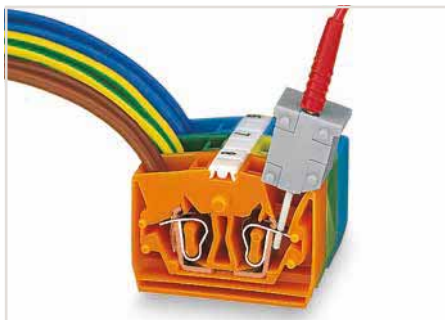

Testing via CAGE CLAMP® on the current bar (max. nominal current: 6 A). CAGE CLAMP® clamps individual test contacts. The maximum test voltage is 400 V.

## Modular Terminal Blocks with Mounting Flanges or Snap-in Mounting Feet 2.5 mm<sup>2</sup>, 264 Series

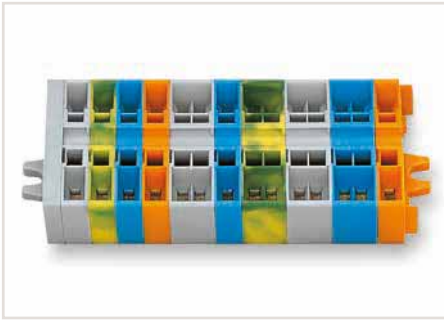

Terminal strips with M3 or M4 mounting flanges, for screw or similar mounting types, mounting holes:  
3.2 mm Ø, M3 flange  
4.2 mm Ø, M4 flange



Terminal strips with snap-in mounting feet, for 0.6 ... 1.2 mm plate thickness, mounting holes: 3.5<sup>+0.1</sup> mm Ø

\*12 AWG: THHN, THWN  
Rail-mount terminal blocks with an Ex mark are suitable for Ex e II applications.  
0.5 ... 2.5 mm<sup>2</sup> / 20 ... 12 AWG\*  
690 V, 23 A  
Terminal blocks with a blue insulated housing are suitable for Ex i applications.



2-conductor center terminal block, required between end plate and end terminal block for terminal strips with mounting flanges

Color	Item No.	Pack. Unit
gray	264-321	100
blue	264-324	100
orange	264-326	100
green-yellow	264-327	100
light gray	264-131	100

2-conductor end terminal block, with mounting flange, for screw or similar mounting types, 3.2 mm mounting hole diameter

Color	Item No.	Pack. Unit
gray	264-301	100
blue	264-304	100
orange	264-306	100
green-yellow	264-307	100
light gray	264-130	100



800 V
8 kV
24 A
600 V, 20 A ; 300 V, 20 A

0.08 ... 2.5 mm <sup>2</sup> / 28 ... 12 AWG
0.08 ... 2.5 mm <sup>2</sup> / 28 ... 12 AWG
12 AWG: THHN, THWN
8 ... 9 mm / 0.31 ... 0.35 inch
6 mm / 0.236 inch
Polyamide 66 (PA 66)

	Item No.	Page
2-pole	264-402	596
2-pole	281-492	596
gray	264-361	596
white	2009-145	781
gray	249-136	597

### Technical Data

Rated voltage (III / 3)	800 V
Rated surge voltage (III / 3)	8 kV
Rated current	24 A
Approval	600 V, 20 A ; 300 V, 20 A

### Connection Data

Solid conductor	0.08 ... 2.5 mm <sup>2</sup> / 28 ... 12 AWG
Fine-stranded conductor	0.08 ... 2.5 mm <sup>2</sup> / 28 ... 12 AWG
Note (conductor cross section)	12 AWG: THHN, THWN
Strip length	8 ... 9 mm / 0.31 ... 0.35 inch
Terminal block width	6 mm / 0.236 inch
Insulation material	Polyamide 66 (PA 66)

### Accessories (Selection)

Comb-style jumper bar, insulated, reduces maximum conductor size to 1.5 mm <sup>2</sup> , I <sub>N</sub> 16 A, gray
Alternate comb-style jumper bar, insulated, I <sub>N</sub> = I <sub>N</sub> terminal block, gray
Alternate comb-style jumper bar, insulated, I <sub>N</sub> = I <sub>N</sub> terminal block, gray
End plate, with mounting flange, 4 mm thick
End plate, for terminal blocks with snap-in mounting foot, 4 mm thick
Aluminum carrier rail, 1000 mm long, 18 mm wide, 7 mm high
Plastic end stop, with WSB marker slot, for aluminum carrier rail (210-154) Width 6 mm
Mini-WSB Inline, plain, 1,700 Mini-WSB markers (5 mm wide) per reel
Test plug module, snaps together Module width 6 mm
Test plug module, snaps together Module width 10 mm

Dimensional drawing, see page 594

Accessories (jumpers, end plates, etc.), see page 596

Tools, see Section 13

Appropriate marking system: Mini-WSB/Mini-WSB Inline, see Full Line Catalog, Volume 6

Information on hazardous locations, see Section 14

Approvals and corresponding ratings, visit [www.wago.com](http://www.wago.com)





4-conductor center terminal block, required between end plate and end terminal block for terminal strips with mounting flanges

Color	Item No.	Pack. Unit
gray	264-351	100
blue	264-354	100
orange	264-356	100
green-yellow	264-357	100
light gray ☺	264-231	

2-conductor terminal block, with snap-in mounting foot, for 0.6 ... 1.2 mm plate thickness, 3.5 mm mounting hole diameter

Color	Item No.	Pack. Unit
gray	264-311	100
blue	264-314	100
orange	264-316	100
green-yellow	264-317	100
light gray ☺	264-180	100

4-conductor terminal block, with snap-in mounting foot, for 0.6 ... 1.2 mm plate thickness, 3.5 mm mounting hole diameter

Color	Item No.	Pack. Unit
gray	264-341	100
blue	264-344	100
orange	264-346	100
green-yellow	264-347	100
light gray ☺	264-280	100

4-conductor end terminal block, with mounting flange, for screw or similar mounting types, 3.2 mm mounting hole diameter

Color	Item No.	Pack. Unit
gray	264-331	100
blue	264-334	100
orange	264-336	100
green-yellow	264-337	100
light gray ☺	264-230	100



800 V
8 kV
24 A
600 V, 20 A ; 300 V, 20 A

800 V
8 kV
24 A
600 V, 20 A ; 300 V, 20 A

800 V
8 kV
24 A
600 V, 20 A ; 300 V, 20 A

0.08 ... 2.5 mm <sup>2</sup> / 28 ... 12 AWG
0.08 ... 2.5 mm <sup>2</sup> / 28 ... 12 AWG
12 AWG: THHN, THWN
8 ... 9 mm / 0.31 ... 0.35 inch
10 mm / 0.394 inch
Polyamide 66 (PA 66)

0.08 ... 2.5 mm <sup>2</sup> / 28 ... 12 AWG
0.08 ... 2.5 mm <sup>2</sup> / 28 ... 12 AWG
12 AWG: THHN, THWN
8 ... 9 mm / 0.31 ... 0.35 inch
6 mm / 0.236 inch
Polyamide 66 (PA 66)

0.08 ... 2.5 mm <sup>2</sup> / 28 ... 12 AWG
0.08 ... 2.5 mm <sup>2</sup> / 28 ... 12 AWG
12 AWG: THHN, THWN
8 ... 9 mm / 0.31 ... 0.35 inch
10 mm / 0.394 inch
Polyamide 66 (PA 66)

	Item No.	Page
2-pole	264-402	596
2-pole	280-492	596
gray	264-361	596
white	2009-145	781
gray	249-139	597

	Item No.	Page
2-pole	264-402	596
2-pole	281-492	596
gray	264-371	596
silver	210-154	596
gray	209-122	596
white	2009-145	781
gray	249-136	597

	Item No.	Page
2-pole	264-402	596
2-pole	280-492	596
gray	264-371	596
silver	210-154	596
gray	209-122	596
white	2009-145	781
gray	249-139	597

## Terminal Strips with Mounting Flanges or Snap-in Mounting Feet 2.5 mm<sup>2</sup>, 264 Series



Item no. suffixes for gray terminal strips with mounting flanges:  
264-102 to 264-112  
264-202 to 264-212

blue .../000-006

Terminal strips with a blue insulated housing are suitable for Ex i applications.



Item no. suffixes for gray terminal strips with snap-in mounting feet:  
264-152 to 264-162  
264-252 to 264-262

blue .../000-006

Terminal strips with a blue insulated housing are suitable for Ex i applications.

\*12 AWG: THHN, THWN

Terminal strips with an Ex mark are suitable for Ex e II applications.

0.5 ... 2.5 mm<sup>2</sup> / 20 ... 12 AWG\*

690 V, 23 A

Terminal strips with a blue insulated housing are suitable for Ex i applications.

Longer strips and/or mixed-color assemblies are available upon request.



2-conductor terminal strip, with mounting flanges, for screw or similar mounting types, 3.2 mm mounting hole diameter, gray

Pole No.	Item No.	Pack. Unit
2	264-102	100
3	264-103	100
4	264-104	100
5	264-105	100
6	264-106	100
7	264-107	100
8	264-108	100
9	264-109	50
10	264-110	50
11	264-111	50
12	264-112	25

2-conductor terminal strip, with snap-in mounting feet, for 0.6 ... 1.2 mm plate thickness, 3.5 mm mounting hole diameter, gray

Pole No.	Item No.	Pack. Unit
2	264-152	100
3	264-153	100
4	264-154	100
5	264-155	100
6	264-156	50
7	264-157	50
8	264-158	50
9	264-159	50
10	264-160	25
11	264-161	25
12	264-162	25

WAGO

### Technical Data

Rated voltage (III / 3)

800 V

Rated surge voltage (III / 3)

8 kV

Rated current

24 A

Rated voltage EN (Ex e II)

Nominal current (Ex e II)

Approval

600 V, 20 A<sup>W</sup>; 300 V, 20 A<sup>®</sup>

### Connection Data

Solid conductor

0.08 ... 2.5 mm<sup>2</sup> / 28 ... 12 AWG

Fine-stranded conductor

0.08 ... 2.5 mm<sup>2</sup> / 28 ... 12 AWG

Note (conductor cross section)

Strip length

12 AWG: THHN, THWN

Module width

8 ... 9 mm / 0.31 ... 0.35 inch

Insulation material

6 mm / 0.236 inch

Polyamide 66 (PA 66)

### Accessories (Selection)

Comb-style jumper bar, insulated, reduces maximum conductor size to 1.5 mm<sup>2</sup>, I<sub>N</sub> 16 A, gray

Alternate comb-style jumper bar, insulated, I<sub>N</sub> = I<sub>N</sub> terminal block, gray

Alternate comb-style jumper bar, insulated, I<sub>N</sub> = I<sub>N</sub> terminal block, gray

	Item No.	Page
2-pole	264-402	596
2-pole	281-492	596

Dimensional drawing, see page 594

Tools, see Section 13

Appropriate marking system: Mini-WSB/Mini-WSB Inline, see Full Line Catalog, Volume 6

Information on hazardous locations, see Section 14

Approvals and corresponding ratings, visit [www.wago.com](http://www.wago.com)



4-conductor terminal strip, with mounting flanges, for screw or similar mounting types, 3.2 mm mounting hole diameter, gray

Pole No.	Item No.	Pack. Unit
2	264-202	100
3	264-203	100
4	264-204	100
5	264-205	100
6	264-206	100
7	264-207	100
8	264-208	100
9	264-209	50
10	264-210	50
11	264-211	25
12	264-212	25

2-conductor Ex e II terminal strip, with mounting flanges, for screw or similar mounting types, 3.2 mm mounting hole diameter, light gray

Pole No.	Item No.	Pack. Unit
2	264-132	100
3	264-133	100
4	264-134	100
5	264-135	100
6	264-136	100
7	264-137	100
8	264-138	100
9	264-139	50
10	264-140	50
11	264-141	25
12	264-142	25

4-conductor Ex e II terminal strip, with mounting flanges, for screw or similar mounting types, 3.2 mm mounting hole diameter, light gray

Pole No.	Item No.	Pack. Unit
2	264-232	100
3	264-233	100
4	264-234	100
5	264-235	100
6	264-236	100
7	264-237	100
8	264-238	100
9	264-239	50
10	264-240	50
11	264-241	100
12	264-242	50

4-conductor terminal strip, with snap-in mounting feet, for 0.6 ... 1.2 mm plate thickness, 3.5 mm mounting hole diameter, gray

Pole No.	Item No.	Pack. Unit
2	264-252	100
3	264-253	100
4	264-254	100
5	264-255	100
6	264-256	50
7	264-257	50
8	264-258	50
9	264-259	50
10	264-260	25
11	264-261	25
12	264-262	25

2-conductor Ex e II terminal strip, with snap-in mounting feet, for 0.6 ... 1.2 mm plate thickness, 3.5 mm mounting hole diameter, light gray

Pole No.	Item No.	Pack. Unit
2	264-182	100
3	264-183	100
4	264-184	100
5	264-185	100
6	264-186	50
7	264-187	50
8	264-188	50
9	264-189	50
10	264-190	25
11	264-191	25
12	264-192	25

2-conductor Ex e II terminal strip, with snap-in mounting feet, for 0.6 ... 1.2 mm plate thickness, 3.5 mm mounting hole diameter, light gray

Pole No.	Item No.	Pack. Unit
2	264-282	100
3	264-283	100
4	264-284	100
5	264-285	100
6	264-286	100
7	264-287	50
8	264-288	50
9	264-289	50
10	264-290	25
11	264-291	25
12	264-292	25

UL

800 V  
8 kV  
24 A

600 V, 20 A<sup>UL</sup>; 300 V, 20 A<sup>CE</sup>

0.08 ... 2.5 mm<sup>2</sup> / 28 ... 12 AWG  
0.08 ... 2.5 mm<sup>2</sup> / 28 ... 12 AWG  
12 AWG: THHN, THWN  
8 ... 9 mm / 0.31 ... 0.35 inch  
10 mm / 0.394 inch  
Polyamide 66 (PA 66)

	Item No.	Page
2-pole	264-402	596
2-pole	280-492	596

UL

690 V  
23 A

600 V, 20 A<sup>UL</sup>; 300 V, 20 A<sup>CE</sup>

0.08 ... 2.5 mm<sup>2</sup> / 28 ... 12 AWG  
0.08 ... 2.5 mm<sup>2</sup> / 28 ... 12 AWG  
12 AWG: THHN, THWN  
8 ... 9 mm / 0.31 ... 0.35 inch  
6 mm / 0.236 inch  
Polyamide 66 (PA 66)

	Item No.	Page
2-pole	264-402	596
2-pole	281-492	596

UL

690 V  
23 A

600 V, 20 A<sup>UL</sup>; 300 V, 20 A<sup>CE</sup>

0.08 ... 2.5 mm<sup>2</sup> / 28 ... 12 AWG  
0.08 ... 2.5 mm<sup>2</sup> / 28 ... 12 AWG  
12 AWG: THHN, THWN  
8 ... 9 mm / 0.31 ... 0.35 inch  
10 mm / 0.394 inch  
Polyamide 66 (PA 66)

	Item No.	Page
2-pole	264-402	596
2-pole	280-492	596

## Dimensional Drawings, 264 Series

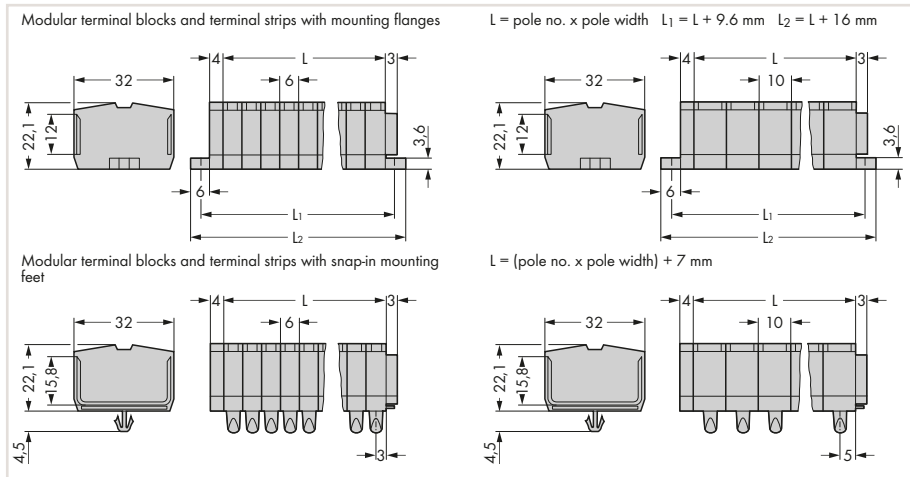

Dimensions in mm  
Modular terminal blocks and terminal strips with mounting flanges or snap-in mounting feet

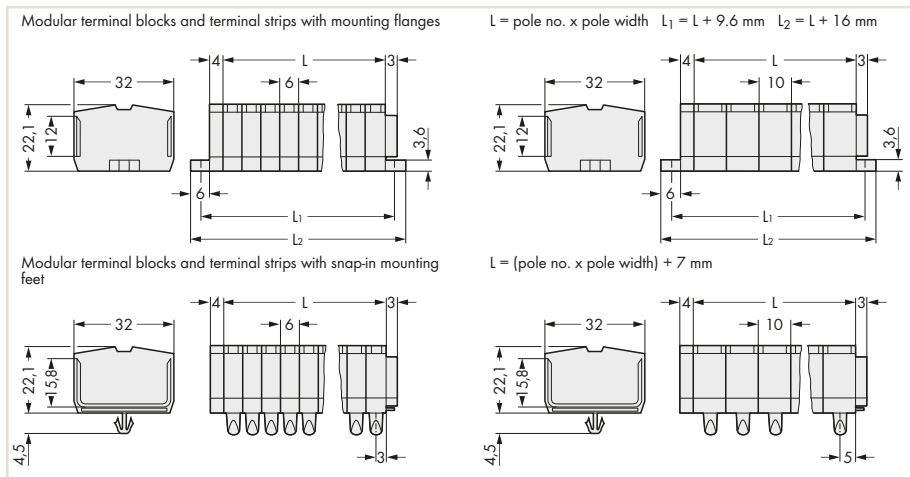

Dimensions in mm  
Modular Ex e II terminal blocks and Ex e II terminal strips with mounting flanges or snap-in mounting feet

## Accessories for 264 Series Modular Terminal Blocks and Terminal Strips

### Commoning, Mounting, Marking and Testing



Comb-style jumper bar, insulated, reduces maximum conductor size to 1.5 mm <sup>2</sup> , I <sub>N</sub> 16 A, gray			
		Item No.	Pack. Unit
2-pole		264-402	200 (25)



Alternate comb-style jumper bar, insulated, I <sub>N</sub> = I <sub>N</sub> terminal block, gray			
Suitable for:		Item No.	Pack. Unit
2-conductor terminal blocks	2-pole	281-492	100 (25)



Alternate comb-style jumper bar, insulated, I <sub>N</sub> = I <sub>N</sub> terminal block, gray			
Suitable for:		Item No.	Pack. Unit
4-conductor terminal blocks	2-pole	280-492	200 (25)



Operating tool, insulated			
		Item No.	Pack. Unit
2-pole		280-432	1



End plate, with mounting flange, 4 mm thick				
Suitable for:		Color	Item No.	Pack. Unit
264-321		gray	264-361	25
264-351		orange	264-364	25
		light gray	264-363	25



End plate, for terminal blocks with snap-in mounting foot, 4 mm thick				
Suitable for:		Color	Item No.	Pack. Unit
264-311		gray	264-371	25
264-341		orange	264-374	25
		light gray	264-373	25



Aluminum carrier rail, 1000 mm long, 18 mm wide, 7 mm high				
Suitable for:		Color	Item No.	Pack. Unit
264-311		silver	210-154	1
264-341				



Plastic end stop, with WSB marker slot, for aluminum carrier rail (210-154) Width 6 mm				
Suitable for:		Color	Item No.	Pack. Unit
264-311		gray	209-122	25
264-341				



 Test plugs, see page 589

Test plug module, snaps together, Module width 6 mm				
Suitable for:		Color	Item No.	Pack. Unit
2-conductor terminal blocks		gray	249-136	100 (25)



Test plug module, snaps together, Module width 10 mm				
Suitable for:		Color	Item No.	Pack. Unit
4-conductor terminal blocks		gray	249-139	100 (25)



## Modular Terminal Blocks and Terminal Strips, 260 to 262 Series Description and Installation

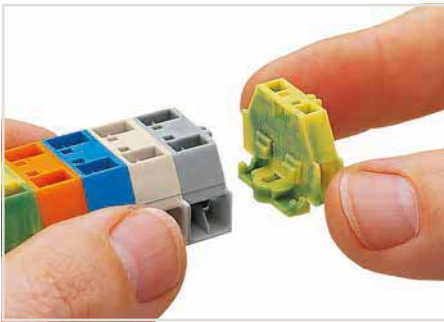

Assembling modular terminal blocks into terminal strips.

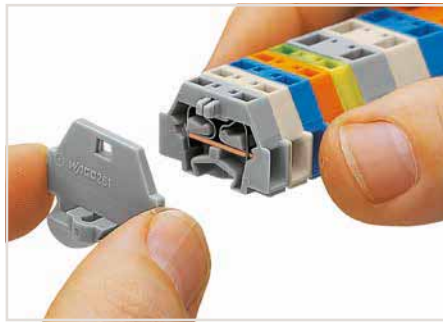

Mounting an end plate.

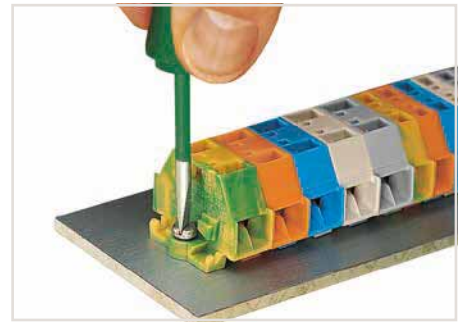

Mounting and securing a terminal strip directly to the plate via screw-type flanges.



**CAGE CLAMP® connection**  
Inserting a conductor via screwdriver. With ferruled conductors, it is necessary to use a terminal block one size larger than the conductor's nominal cross-section.

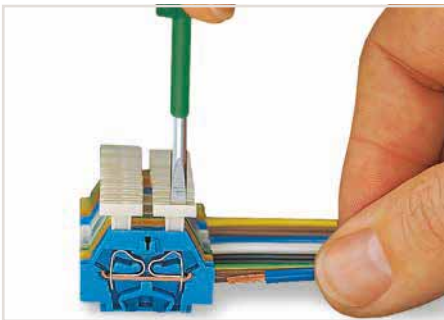

**CAGE CLAMP® connection**  
Inserting a conductor via push-button.

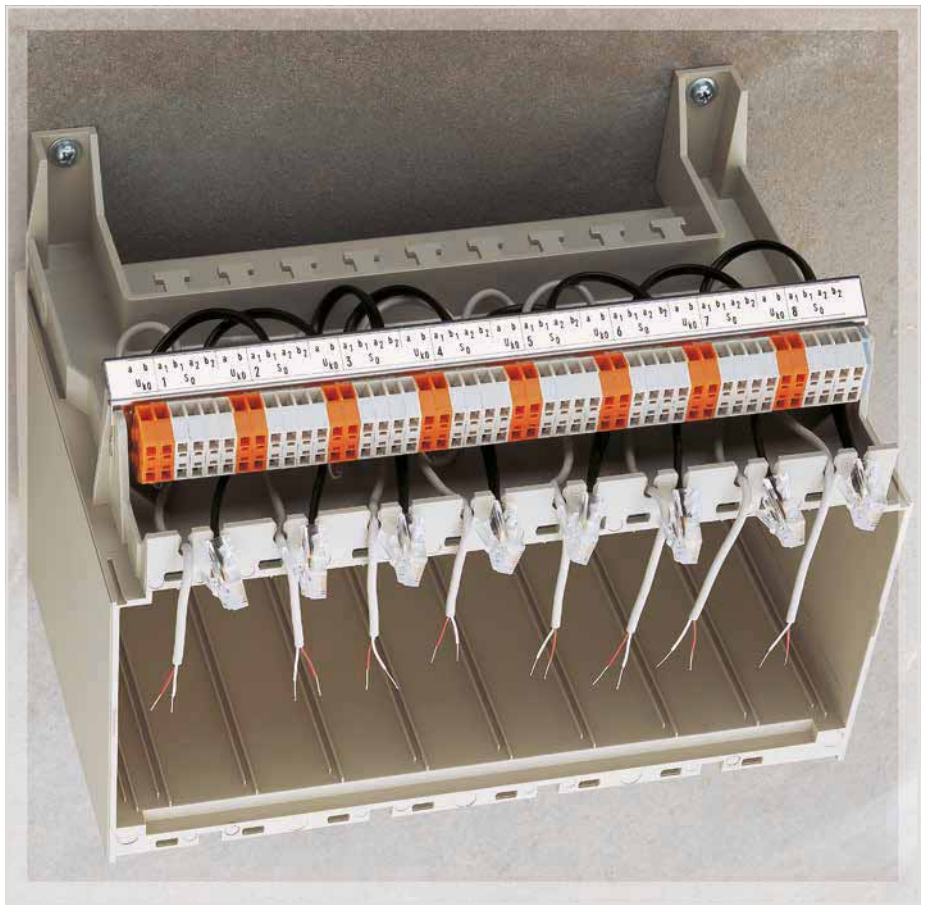

8

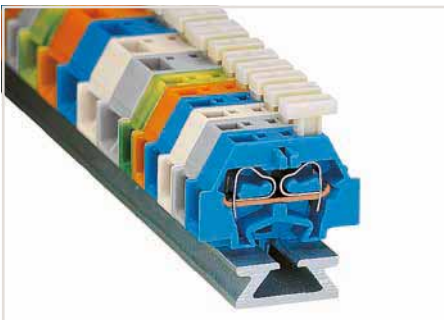

Terminal strip with push-buttons on one side

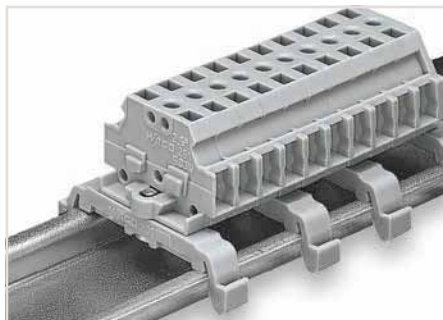

Terminal strip with marker slot for Mini-WSB Quick Marking System

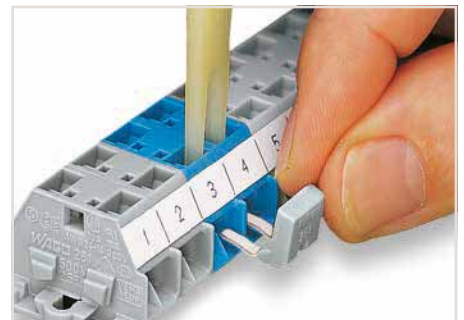

Commoning with comb-style jumper bar.





Mounting a terminal strip with snap-in feet into holes.



Mounting a terminal strip with snap-in feet onto aluminum rail.



Terminal strip with mounting flanges – screwing a 209-123 Mounting Foot (distance between mounting feet: approx. 25 ... 30 mm)

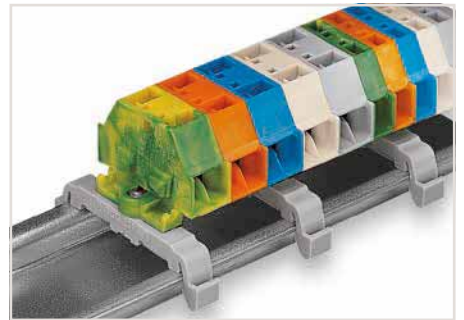
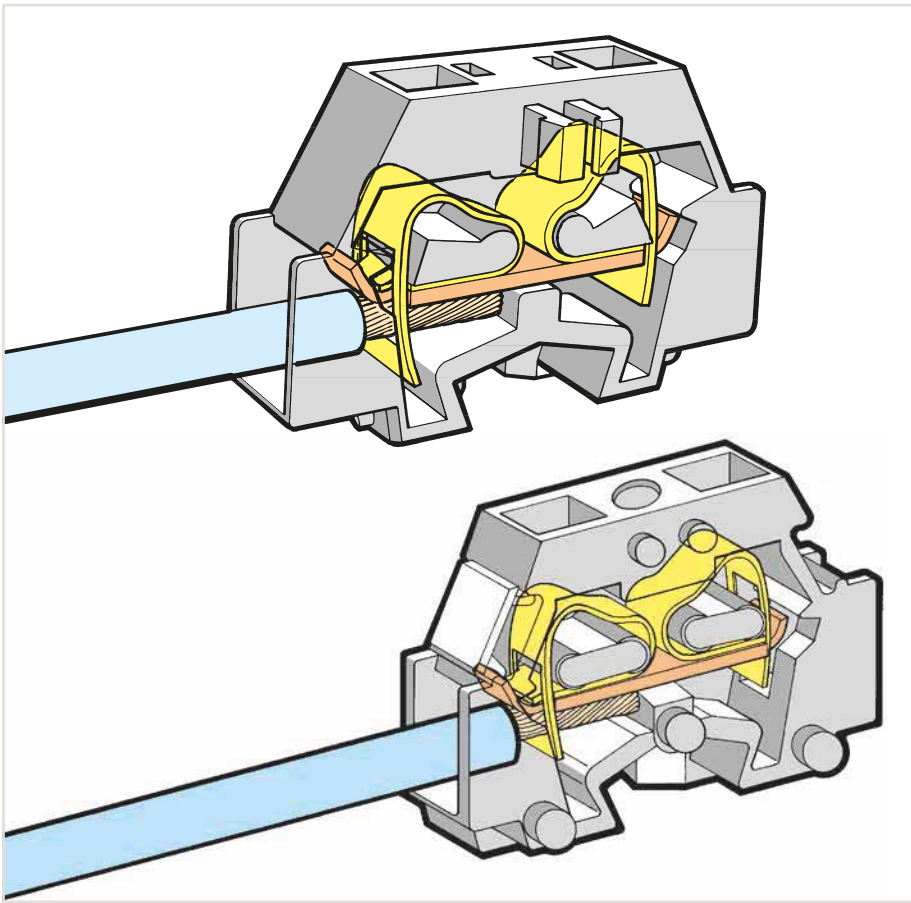

Terminal strip with mounting flanges on DIN-35 rail

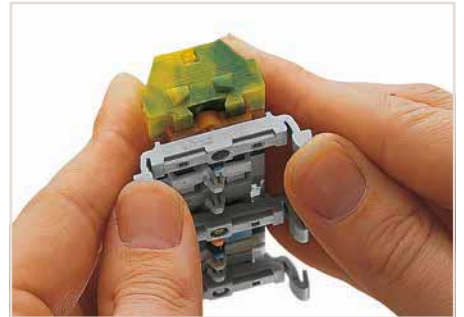

Terminal strip with snap-in mounting feet – snapping a 209-123 Mounting Foot (distance between mounting feet: approx. 25 ... 30 mm)



Marking with self-adhesive marking strips, see Full Line Catalog Volume 6.



Marking by direct printing (upon request).

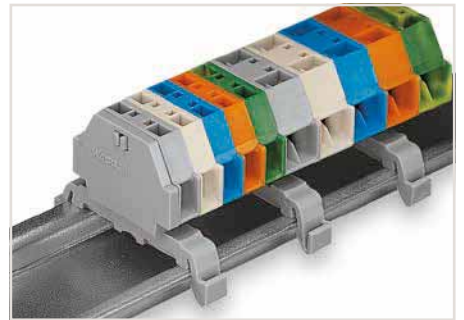

Terminal strip with snap-in mounting feet on DIN-35 rail

## Dimensional Drawings, 260, 261 and 262 Series

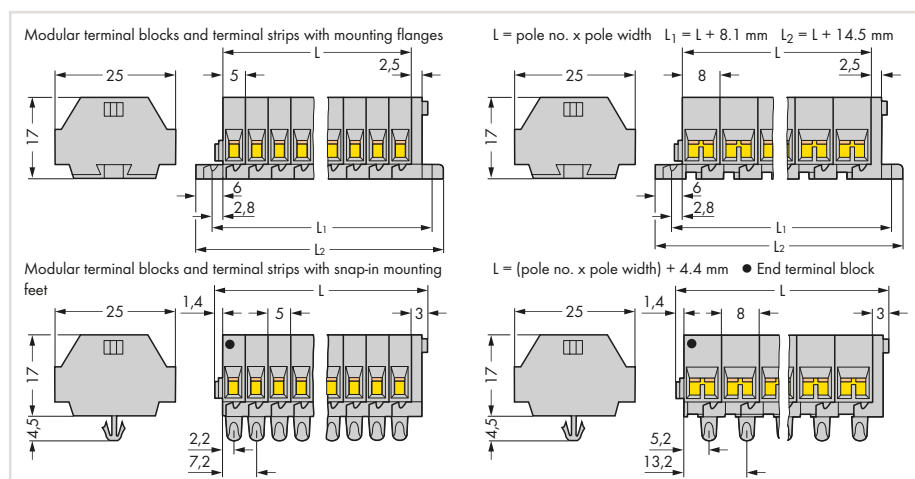

Dimensions in mm

Modular Terminal Blocks and Terminal Strips with Mounting Flanges or Snap-In Mounting Feet, 260 Series

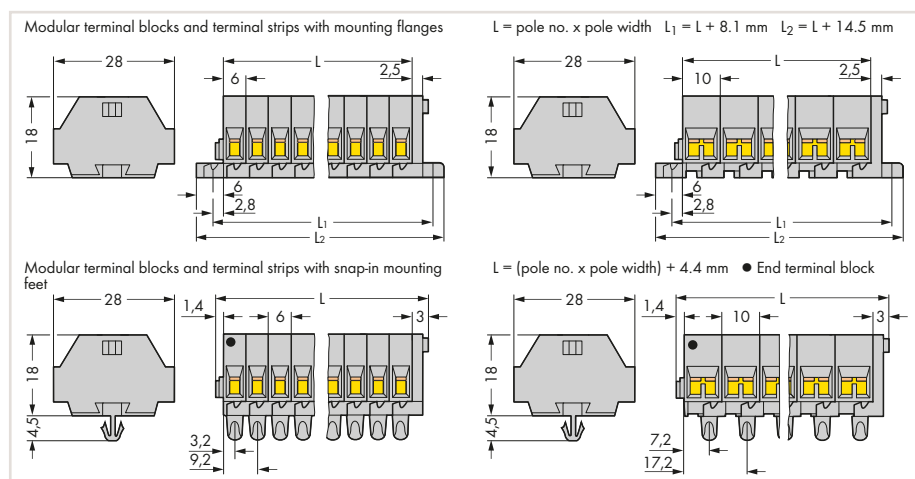

Dimensions in mm

Modular terminal blocks and terminal strips with mounting flanges or snap-in mounting feet, 261 Series

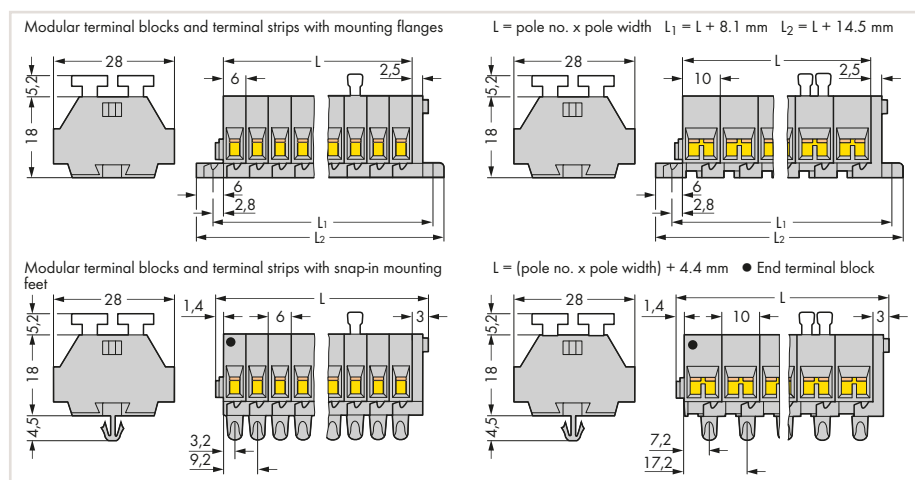

Dimensions in mm

Modular terminal blocks and terminal strips with push-buttons on one or both sides and mounting flanges or snap-in mounting feet, 261 Series

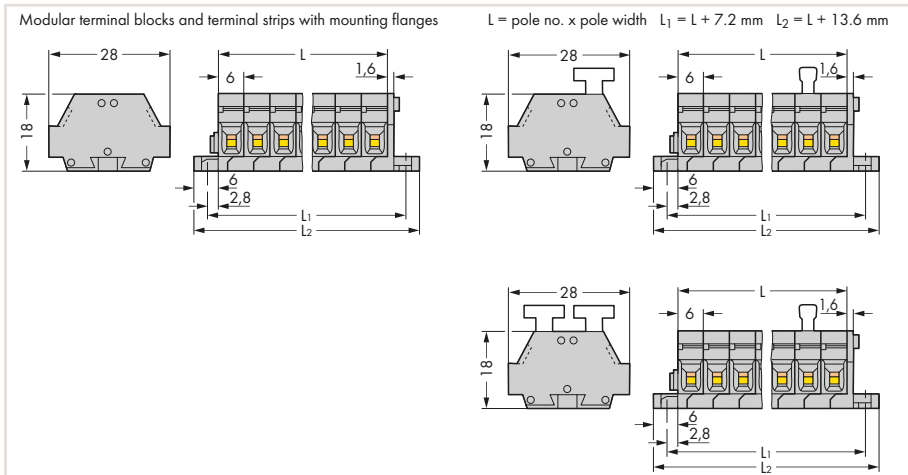

Dimensions in mm  
 Modular terminal blocks and terminal strips with mounting flanges and marker slot for Mini-WSB Quick Marking System, 261 Series

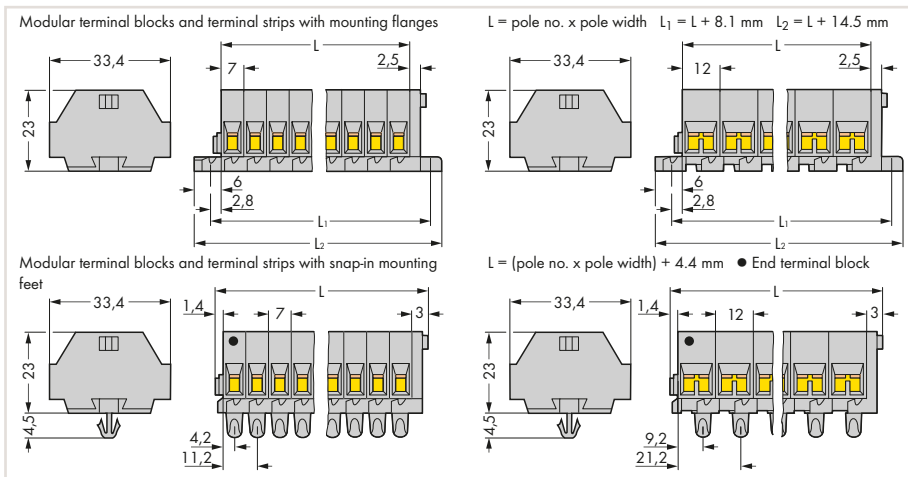

Dimensions in mm  
 Modular terminal blocks and terminal strips with mounting flanges or snap-in mounting feet, 262 Series

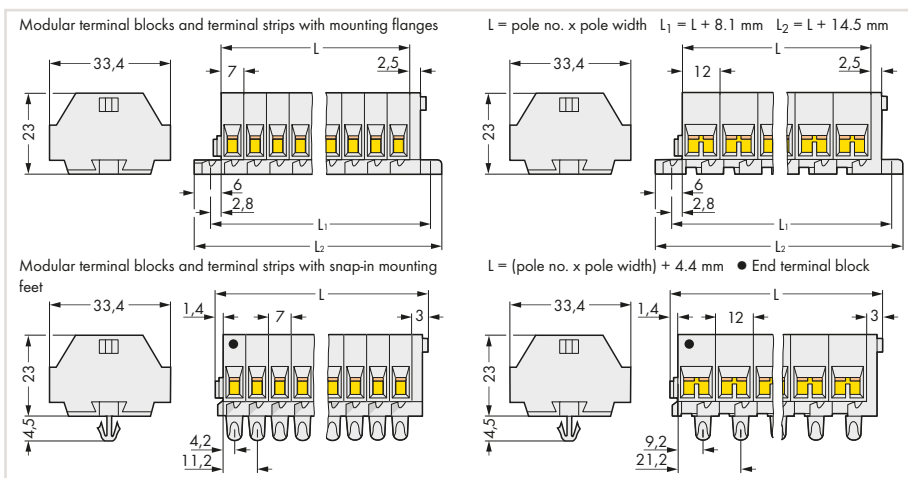

Dimensions in mm  
 Modular Ex e II terminal blocks and Ex e II terminal strips with mounting flanges or snap-in mounting feet, 262 Series

## Modular Terminal Blocks with Mounting Flange or Snap-In Mounting Foot

### 1.5 mm<sup>2</sup>, 260 Series



Terminal strip, with mounting flanges, for screw or similar mounting types, 3.2 mm mounting hole diameter (with 209-123 Mounting Foot for DIN-35 rail)



Terminal strip with snap-in mounting feet, for 0.6 ... 1.2 mm plate thickness, 3.5 mm mounting hole diameter (also for 210-154 Aluminum Rail or with 209-120 Mounting Foot for DIN-35 rail)



2-conductor terminal block, with mounting flange, for screw or similar mounting types, 3.2 mm mounting hole diameter, with mounting foot (209-123) also for DIN-35 rail

Color	Item No.	Pack. Unit
○ gray	260-301	300 (50)
○ light gray	260-303	300 (50)
● blue	260-304	300 (50)
● orange	260-306	300 (50)
● green-yellow	260-307	300 (50)

2-conductor terminal block, with snap-in mounting foot, for 0.6 ... 1.2 mm plate thickness, 3.5 mm mounting hole diameter, also for aluminum rail (210-154) or with mounting foot (209-120) for DIN-35 rail

Color	Item No.	Pack. Unit
○ gray	260-311	300 (50)
○ light gray	260-313	300 (50)
● blue	260-314	300 (50)
● orange	260-316	300 (50)
● green-yellow	260-317	300 (50)

Space-saving, 2-conductor end terminal block, without protruding snap-in mounting foot, for terminal strips with snap-in mounting feet

Color	Item No.	Pack. Unit
○ gray	260-321	300 (50)
○ light gray	260-323	300 (50)
● blue	260-324	300 (50)
● orange	260-326	300 (50)
● green-yellow	260-327	300 (50)

**WAGO**

#### Technical Data

Rated voltage (III / 3)	400 V
Rated surge voltage (III / 3)	6 kV
Rated current	18 A
Approval	300 V, 10 A <b>W</b> ; 300 V, 15 A <b>E</b>

#### Connection Data

Solid conductor	0.08 ... 1.5 mm / 28 ... 16 AWG
Fine-stranded conductor	0.08 ... 1.5 mm / 28 ... 16 AWG
Strip length	8 ... 9 mm / 0.31 ... 0.35 inch
Terminal block width	5 mm / 0.197 inch
Insulation material	Polyamide 66 (PA 66)

#### Accessories (Selection)

Comb-style jumper bar, insulated, reduces maximum conductor size to 1 mm <sup>2</sup> , I <sub>N</sub> 10 A, gray
End plate, with mounting flange
End plate, with snap-in mounting foot
Test plug module, snaps together Module width 5 mm
Test plug module, snaps together Module width 8 mm

	Item No.	Page
2-pole	260-402	622
gray	260-361	622
gray	260-371	622
gray	249-135	622

Dimensional drawing, see page 600

Accessories (jumpers, end plates, test plugs, etc.), see page 622

Tools, see Section 13

Marking accessories, see Section 13 and Volume 6

Approvals and corresponding ratings, visit [www.wago.com](http://www.wago.com)



4-conductor terminal block, with mounting flange, for screw or similar mounting types, 3.2 mm mounting hole diameter, with mounting foot (209-123) also for DIN-35 rail

Color	Item No.	Pack. Unit
○ gray	260-331	300 (50)
○ light gray	260-333	300 (50)
● blue	260-334	300 (50)
● orange	260-336	300 (50)
● green-yellow	260-337	300 (50)

4-conductor terminal block, with snap-in mounting foot, for 0.6 ... 1.2 mm plate thickness, 3.5 mm mounting hole diameter, also for aluminum rail (210-154) or with mounting foot (209-120) for DIN-35 rail

Color	Item No.	Pack. Unit
○ gray	260-341	300 (50)
○ light gray	260-343	300 (50)
● blue	260-344	300 (50)
● orange	260-346	300 (50)
● green-yellow	260-347	300 (50)

Space-saving, 2-conductor end terminal block, without protruding snap-in mounting foot, for terminal strips with snap-in mounting feet

Color	Item No.	Pack. Unit
○ gray	260-351	300 (50)
○ light gray	260-353	300 (50)
● blue	260-354	300 (50)
● orange	260-356	300 (50)
● green-yellow	260-357	300 (50)

RAE

400 V

6 kV

18 A

300 V, 10 A **RAE**; 300 V, 15 A **AE**

0.08 ... 1.5 mm / 28 ... 16 AWG

0.08 ... 1.5 mm / 28 ... 16 AWG

8 ... 9 mm / 0.31 ... 0.35 inch

8 mm / 0.315 inch

Polyamide 66 (PA 66)

	Item No.	Page
2-pole	260-402	622
gray	260-361	622
gray	260-371	622
gray	249-138	622



## Terminal Strips with Mounting Flanges or Snap-in Mounting Feet 1.5 mm<sup>2</sup>, 260 Series

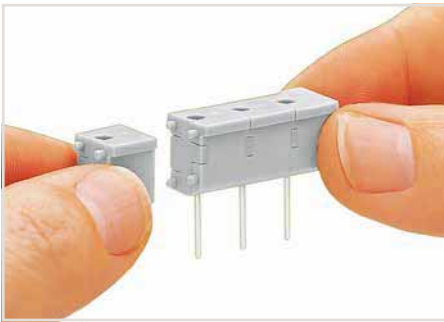

Snapping individual modules together to assemble a multi-pole test plug module.

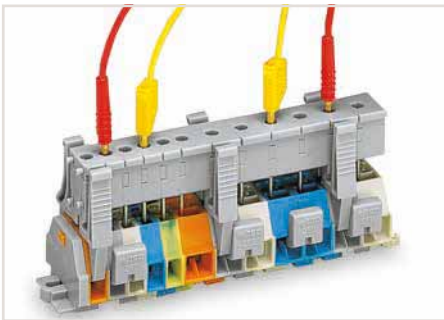

Testing via test plug modules snapped onto a terminal strip – wired or unwired. As touch contact is made with the CAGE CLAMP® (spring steel) unit, this testing type is limited to maximum 0.5 A.

Distance between locking devices must be approximately 35 ... 40 mm.

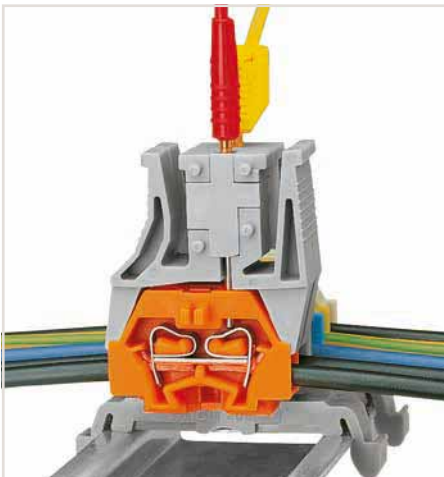

Testing after the conductors have been terminated.

Longer strips and/or mixed-color assemblies are available upon request.

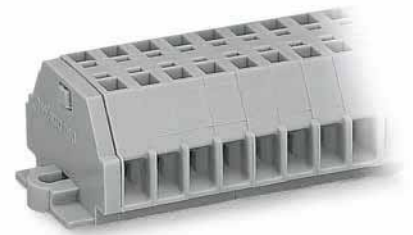

2-conductor terminal strip, with mounting flanges, for screw or similar mounting types, 3.2 mm mounting hole diameter, gray

Pole No.	Item No.	Pack. Unit
○ 2	260-102	100
○ 3	260-103	100
○ 4	260-104	100
○ 5	260-105	100
○ 6	260-106	100
○ 7	260-107	100
○ 8	260-108	100
○ 9	260-109	50
○ 10	260-110	50
○ 11	260-111	50
○ 12	260-112	25

2-conductor terminal strip, with snap-in mounting feet, for 0.6 ... 1.2 mm plate thickness, 3.5 mm mounting hole diameter, gray

Pole No.	Item No.	Pack. Unit
○ 2	260-152	100
○ 3	260-153	100
○ 4	260-154	100
○ 5	260-155	100
○ 6	260-156	50
○ 7	260-157	50
○ 8	260-158	50
○ 9	260-159	50
○ 10	260-160	25
○ 11	260-161	25
○ 12	260-162	25

WAGO

### Technical Data

Rated voltage (III / 3)	400 V
Rated surge voltage (III / 3)	6 kV
Rated current	18 A
Approval	300 V, 10 A ; 300 V, 15 A

### Connection Data

Solid conductor	0.08 ... 1.5 mm / 28 ... 16 AWG
Fine-stranded conductor	0.08 ... 1.5 mm / 28 ... 16 AWG
Strip length	8 ... 9 mm / 0.31 ... 0.35 inch
Module width	5 mm / 0.197 inch
Insulation material	Polyamide 66 (PA 66)

### Accessories (Selection)

Comb-style jumper bar, insulated, reduces maximum conductor size to 1 mm <sup>2</sup> , I <sub>N</sub> 10 A, gray
Test plug module, snaps together Module width 5 mm
Test plug module, snaps together Module width 8 mm

	Item No.	Page
2-pole	260-402	622
gray	249-135	622

Dimensional drawing, see page 600

Tools, see Section 13

Marking accessories, see Section 13 and Volume 6

Approvals and corresponding ratings, visit [www.wago.com](http://www.wago.com)



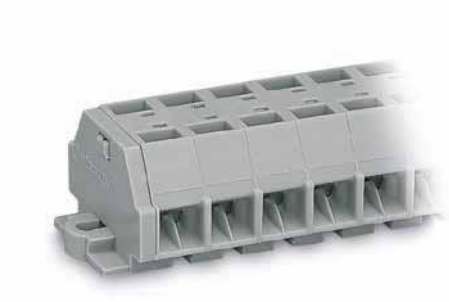

4-conductor terminal strip, with mounting flanges, for screw or similar mounting types, 3.2 mm mounting hole diameter, gray

Pole No.	Item No.	Pack. Unit
2	260-202	100
3	260-203	100
4	260-204	100
5	260-205	100
6	260-206	100
7	260-207	100
8	260-208	100
9	260-209	50
10	260-210	50
11	260-211	25
12	260-212	25

4-conductor terminal strip, with snap-in mounting feet, for 0.6 ... 1.2 mm plate thickness, 3.5 mm mounting hole diameter, gray

Pole No.	Item No.	Pack. Unit
2	260-252	100
3	260-253	100
4	260-254	100
5	260-255	100
6	260-256	50
7	260-257	50
8	260-258	50
9	260-259	50
10	260-260	25
11	260-261	25
12	260-262	25

UL®

400 V

6 kV

18 A

300 V, 10 A **UL**; 300 V, 15 A **UL**

0.08 ... 1.5 mm / 28 ... 16 AWG

0.08 ... 1.5 mm / 28 ... 16 AWG

8 ... 9 mm / 0.31 ... 0.35 inch

8 mm / 0.315 inch

Polyamide 66 (PA 66)

	Item No.	Page
2-pole	260-402	622
gray	249-138	622

## Modular Terminal Blocks with Mounting Flange or Snap-In Mounting Foot

### 2.5 mm<sup>2</sup>, 261 Series



Terminal strip, with mounting flanges, for screw or similar mounting types, 3.2 mm mounting hole diameter (with 209-123 Mounting Foot for DIN-35 rail)

Terminal blocks with a blue insulated housing are suitable for Ex i applications.

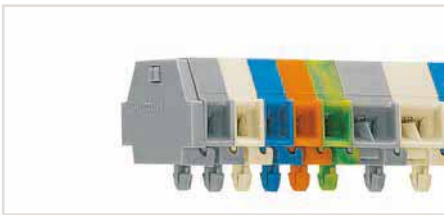

Terminal strip with snap-in mounting feet, for 0.6 ... 1.2 mm plate thickness, 3.5 mm mounting hole diameter (also for 210-154 Aluminum Rail or with 209-120 Mounting Foot for DIN-35 rail)

2-conductor terminal block, with mounting flange, for screw or similar mounting types, 3.2 mm mounting hole diameter, with mounting foot (209-123) also for DIN-35 rail

Color	Item No.	Pack. Unit
○ gray	261-301	200 (50)
○ light gray	261-303	200 (50)
● blue	261-304	200 (50)
● orange	261-306	200 (50)
● green-yellow	261-307	200 (50)

2-conductor terminal block, with snap-in mounting foot, for 0.6 ... 1.2 mm plate thickness, 3.5 mm mounting hole diameter, also for aluminum rail (210-154) or with mounting foot (209-120) for DIN-35 rail

Color	Item No.	Pack. Unit
○ gray	261-311	200 (50)
○ light gray	261-313	200 (50)
● blue	261-314	200 (50)
● orange	261-316	200 (50)
● green-yellow	261-317	200 (50)

Space-saving, 2-conductor end terminal block, without protruding snap-in mounting foot, for terminal strips with snap-in mounting feet

Color	Item No.	Pack. Unit
○ gray	261-321	200 (50)
○ light gray	261-323	200 (50)
● blue	261-324	200 (50)
● orange	261-326	200 (50)
● green-yellow	261-327	200 (50)

**WAGO**

#### Technical Data

Rated voltage (III / 3)	500 V
Rated surge voltage (III / 3)	6 kV
Rated current	24 A
Approval	300 V, 15 A <b>W</b> ; 300 V, 20 A <b>E</b>

#### Connection Data

Solid conductor	0.08 ... 2.5 mm / 28 ... 14 AWG
Fine-stranded conductor	0.08 ... 2.5 mm / 28 ... 14 AWG
Strip length	8 ... 9 mm / 0.31 ... 0.35 inch
Terminal block width	6 mm / 0.236 inch
Insulation material	Polyamide 66 (PA 66)

#### Accessories (Selection)

Comb-style jumper bar, insulated, reduces maximum conductor size to 1.5 mm <sup>2</sup> , I <sub>N</sub> 16 A, gray
End plate, with mounting flange
End plate, with snap-in mounting foot
Test plug module, snaps together Module width 6 mm
Test plug module, snaps together Module width 10 mm

	Item No.	Page
2-pole	261-402	623
gray	261-361	623
gray	261-371	623
gray	249-136	623

Dimensional drawing, see page 600

Accessories (jumpers, end plates, test plugs, etc.), see page 623

Tools, see Section 13

Marking accessories, see Section 13 and Volume 6

Approvals and corresponding ratings, visit [www.wago.com](http://www.wago.com)



4-conductor terminal block, with mounting flange, for screw or similar mounting types, 3.2 mm mounting hole diameter, with mounting foot (209-123) also for DIN-35 rail

Color	Item No.	Pack. Unit
○ gray	261-331	200 (50)
○ light gray	261-333	200 (50)
● blue	261-334	200 (50)
● orange	261-336	200 (50)
● green-yellow	261-337	200 (50)

4-conductor terminal block, with snap-in mounting foot, for 0.6 ... 1.2 mm plate thickness, 3.5 mm mounting hole diameter, also for aluminum rail (210-154) or with mounting foot (209-120) for DIN-35 rail

Color	Item No.	Pack. Unit
○ gray	261-341	200 (50)
○ light gray	261-343	200 (50)
● blue	261-344	200 (50)
● orange	261-346	200 (50)
● green-yellow	261-347	200 (50)

Space-saving, 2-conductor end terminal block, without protruding snap-in mounting foot, for terminal strips with snap-in mounting feet

Color	Item No.	Pack. Unit
○ gray	261-351	200 (50)
○ light gray	261-353	200 (50)
● blue	261-354	200 (50)
● orange	261-356	200 (50)
● green-yellow	261-357	200 (50)

RAE

500 V

6 kV

24 A

300 V, 15 A **RAE**; 300 V, 20 A **AE**

0.08 ... 2.5 mm / 28 ... 14 AWG

0.08 ... 2.5 mm / 28 ... 14 AWG

8 ... 9 mm / 0.31 ... 0.35 inch

10 mm / 0.394 inch

Polyamide 66 (PA 66)

	Item No.	Page
2-pole	261-402	623
gray	261-361	623
gray	261-371	623
gray	249-139	623

## Terminal Strips with Mounting Flanges or Snap-in Mounting Feet 2.5 mm<sup>2</sup>, 261 Series

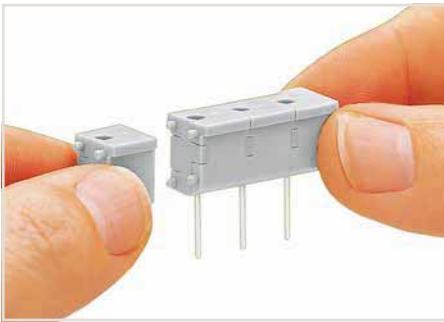

Snapping individual modules together to assemble a multi-pole test plug module.

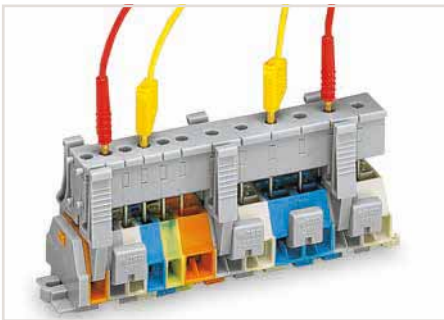

Testing via test plug modules snapped onto a terminal strip – wired or unwired. As touch contact is made with the CAGE CLAMP® (spring steel) unit, this testing type is limited to maximum 0.5 A.

Distance between locking devices must be approximately 35 ... 40 mm.

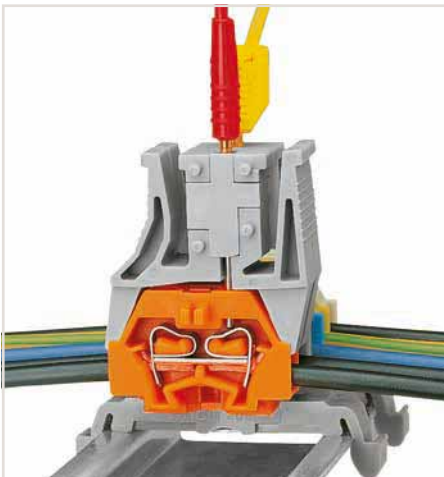

Testing after the conductors have been terminated.

Terminal blocks and terminal strips with a blue insulated housing are suitable for Ex i applications.

Item no. suffixes for gray terminal strips in:  
blue .../000-006

Longer strips and/or mixed-color assemblies are available upon request.



2-conductor terminal strip, with mounting flanges, for screw or similar mounting types, 3.2 mm mounting hole diameter, gray

Pole No.	Item No.	Pack. Unit
○ 2	261-102	100
○ 3	261-103	100
○ 4	261-104	100
○ 5	261-105	200
○ 6	261-106	50
○ 7	261-107	50
○ 8	261-108	50
○ 9	261-109	50
○ 10	261-110	25
○ 11	261-111	25
○ 12	261-112	25

2-conductor terminal strip, with snap-in mounting feet, for 0.6 ... 1.2 mm plate thickness, 3.5 mm mounting hole diameter, gray

Pole No.	Item No.	Pack. Unit
○ 2	261-152	100
○ 3	261-153	100
○ 4	261-154	100
○ 5	261-155	100
○ 6	261-156	50
○ 7	261-157	50
○ 8	261-158	50
○ 9	261-159	50
○ 10	261-160	25
○ 11	261-161	25
○ 12	261-162	25

WAGO

### Technical Data

Rated voltage (III / 3)	500 V
Rated surge voltage (III / 3)	6 kV
Rated current	24 A
Approval	300 V, 15 A ; 300 V, 20 A

### Connection Data

Solid conductor	0.08 ... 2.5 mm / 28 ... 14 AWG
Fine-stranded conductor	0.08 ... 2.5 mm / 28 ... 14 AWG
Strip length	8 ... 9 mm / 0.31 ... 0.35 inch
Module width	6 mm / 0.236 inch
Insulation material	Polyamide 66 (PA 66)

### Accessories (Selection)

Comb-style jumper bar, insulated, reduces maximum conductor size to 1.5 mm <sup>2</sup> , I <sub>N</sub> 16 A, gray
Test plug module, snaps together Module width 6 mm
Test plug module, snaps together Module width 10 mm

	Item No.	Page
2-pole	261-402	623
gray	249-136	623

Dimensional drawing, see page 600

Tools, see Section 13

Marking accessories, see Section 13 and Volume 6

Approvals and corresponding ratings, visit [www.wago.com](http://www.wago.com)



4-conductor terminal strip, with mounting flanges, for screw or similar mounting types, 3.2 mm mounting hole diameter, gray

Pole No.	Item No.	Pack. Unit
2	261-202	100
3	261-203	100
4	261-204	100
5	261-205	100
6	261-206	50
7	261-207	50
8	261-208	50
9	261-209	50
10	261-210	25
11	261-211	25
12	261-212	25

4-conductor terminal strip, with snap-in mounting feet, for 0.6 ... 1.2 mm plate thickness, 3.5 mm mounting hole diameter, gray

Pole No.	Item No.	Pack. Unit
2	261-252	100
3	261-253	100
4	261-254	100
5	261-255	100
6	261-256	50
7	261-257	50
8	261-258	50
9	261-259	50
10	261-260	25
11	261-261	25
12	261-262	25

**RAE**

500 V

6 kV

24 A

300 V, 15 A **RAE**; 300 V, 20 A **RAE**

0.08 ... 2.5 mm / 28 ... 14 AWG

0.08 ... 2.5 mm / 28 ... 14 AWG

8 ... 9 mm / 0.31 ... 0.35 inch

10 mm / 0.394 inch

Polyamide 66 (PA 66)

	Item No.	Page
2-pole	261-402	623
gray	249-139	623

# Modular Terminal Blocks with Push-Buttons on One Side, Mounting Flange or Snap-In Mounting Foot

## 2.5 mm<sup>2</sup>, 261 Series

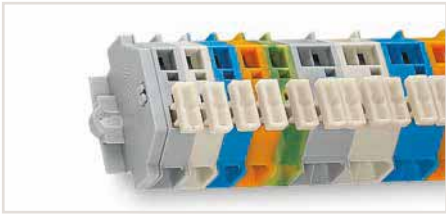

Terminal strip, with mounting flanges, for screw or similar mounting types, 3.2 mm mounting hole diameter (with 209-123 Mounting Foot for DIN-35 rail)

Terminal blocks and terminal strips with a blue insulated housing are suitable for Ex i applications.

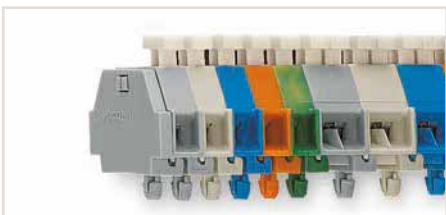

Terminal strip with snap-in mounting feet, for 0.6 ... 1.2 mm plate thickness, 3.5 mm mounting hole diameter (also for 210-154 Aluminum Rail or with 209-120 Mounting Foot for DIN-35 rail)

2-conductor terminal block, with push-button on one side, with mounting flange, for screw or similar mounting types, 3.2 mm mounting hole diameter, with mounting foot (209-123) also for DIN-35 rail

Color	Item No.	Pack. Unit
○ gray	261-301/331-000	200 (50)
○ light gray	261-303/331-000	200 (50)
● blue	261-304/331-000	200 (50)
● orange	261-306/331-000	200 (50)
● green-yellow	261-307/331-000	200 (50)

2-conductor terminal block, with push-button on one side, with snap-in mounting foot, for 0.6 ... 1.2 mm plate thickness, 3.5 mm mounting hole diameter, also for aluminum rail (210-154) or with mounting foot (209-120) for DIN-35 rail

Color	Item No.	Pack. Unit
○ gray	261-311/331-000	200 (50)
○ light gray	261-313/331-000	200 (50)
● blue	261-314/331-000	200 (50)
● orange	261-316/331-000	200 (50)
● green-yellow	261-317/331-000	200 (50)

Space-saving, 2-conductor end terminal block, with push-button on one side, without protruding snap-in mounting foot, for terminal strips with snap-in mounting feet

Color	Item No.	Pack. Unit
○ gray	261-321/331-000	200 (50)
○ light gray	261-323/331-000	200 (50)
● blue	261-324/331-000	200 (50)
● orange	261-326/331-000	200 (50)
● green-yellow	261-327/331-000	200 (50)

**WAGO**

### Technical Data

Rated voltage (III / 3)	500 V
Rated surge voltage (III / 3)	6 kV
Rated current	24 A
Approval	300 V, 15 A <b>W</b> , 300 V, 20 A <b>®</b>
<b>Connection Data</b>	
Solid conductor	0.08 ... 2.5 mm / 28 ... 14 AWG
Fine-stranded conductor	0.08 ... 2.5 mm / 28 ... 14 AWG
Strip length	8 ... 9 mm / 0.31 ... 0.35 inch
Terminal block width	6 mm / 0.236 inch
Insulation material	Polyamide 66 (PA 66)

Rated voltage (III / 3)	500 V
Rated surge voltage (III / 3)	6 kV
Rated current	24 A
Approval	300 V, 15 A <b>W</b> , 300 V, 20 A <b>®</b>
<b>Connection Data</b>	
Solid conductor	0.08 ... 2.5 mm / 28 ... 14 AWG
Fine-stranded conductor	0.08 ... 2.5 mm / 28 ... 14 AWG
Strip length	8 ... 9 mm / 0.31 ... 0.35 inch
Terminal block width	6 mm / 0.236 inch
Insulation material	Polyamide 66 (PA 66)

### Accessories (Selection)

Comb-style jumper bar, insulated, reduces maximum conductor size to 1.5 mm <sup>2</sup> , I <sub>N</sub> 16 A, gray	
End plate, with mounting flange	
End plate, with snap-in mounting foot	
Test plug module, snaps together Module width 6 mm	
Test plug module, snaps together Module width 10 mm	

	Item No.	Page
2-pole	261-402	623
gray	261-361	623
gray	261-371	623
gray	249-136	623

Dimensional drawing, see page 600

Accessories (jumpers, end plates, test plugs, etc.), see page 623

Tools, see Section 13

Marking accessories, see Section 13 and Volume 6

Approvals and corresponding ratings, visit [www.wago.com](http://www.wago.com)





4-conductor terminal block, with push-buttons on one side, with mounting flange, for screw or similar mounting types, 3.2 mm mounting hole diameter, with mounting foot (209-123) also for DIN-35 rail

Color	Item No.	Pack. Unit
○ gray	261-331/332-000	200 (50)
○ light gray	261-333/332-000	200 (50)
● blue	261-334/332-000	200 (50)
● orange	261-336/332-000	200 (50)
● green-yellow	261-337/332-000	200 (50)

4-conductor terminal block, with push-buttons on one side, with snap-in mounting foot, for 0.6 ... 1.2 mm plate thickness, 3.5 mm mounting hole diameter, also for aluminum rail (210-154) or with mounting foot (209-120) for DIN-35 rail

Color	Item No.	Pack. Unit
○ gray	261-341/332-000	200 (50)
○ light gray	261-343/332-000	200 (50)
● blue	261-344/332-000	200 (50)
● orange	261-346/332-000	200 (50)
● green-yellow	261-347/332-000	200 (50)

Space-saving, 4-conductor end terminal block, with push-buttons on one side, without protruding snap-in mounting foot, for terminal strips with snap-in mounting feet

Color	Item No.	Pack. Unit
○ gray	261-351/332-000	200 (50)
○ light gray	261-353/332-000	200 (50)
● blue	261-354/332-000	200 (50)
● orange	261-356/332-000	200 (50)
● green-yellow	261-357/332-000	200 (50)

WAGO

500 V

6 kV

24 A

300 V, 15 A **W**, 300 V, 20 A **W**

0.08 ... 2.5 mm / 28 ... 14 AWG

0.08 ... 2.5 mm / 28 ... 14 AWG

8 ... 9 mm / 0.31 ... 0.35 inch

10 mm / 0.394 inch

Polyamide 66 (PA 66)

	Item No.	Page
2-pole	261-402	623
gray	261-361	623
gray	261-371	623
gray	249-139	623

## Terminal Strips with Push-Buttons on One Side, Mounting Flanges or Snap-In Mounting Feet

### 2.5 mm<sup>2</sup>, 261 Series

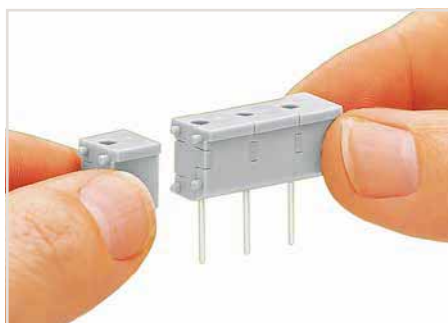

Snapping individual modules together to assemble a multi-pole test plug module.

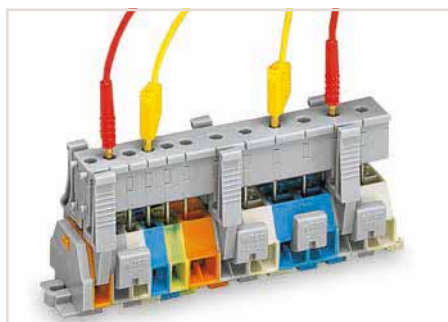

Testing via test plug modules snapped onto a terminal strip – wired or unwired. As touch contact is made with the CAGE CLAMP® (spring steel) unit, this testing type is limited to maximum 0.5 A.

Distance between locking devices must be approximately 35 ... 40 mm.



Testing after the conductors have been terminated.

Terminal blocks and terminal strips with a blue insulated housing are suitable for Ex i applications.

Item no. suffixes for gray terminal strips in:  
blue .../000-006

Longer strips and/or mixed-color assemblies are available upon request.



2-conductor terminal strip, with push-buttons on one side, with mounting flanges, for screw or similar mounting types, 3.2 mm mounting hole diameter, gray

Pole No.	Item No.	Pack. Unit
○ 2	261-102/331-000	100
○ 3	261-103/331-000	100
○ 4	261-104/331-000	100
○ 5	261-105/331-000	200
○ 6	261-106/331-000	50
○ 7	261-107/331-000	50
○ 8	261-108/331-000	50
○ 9	261-109/331-000	50
○ 10	261-110/331-000	25
○ 11	261-111/331-000	25
○ 12	261-112/331-000	25

2-conductor terminal strip, with push-buttons on one side, with snap-in mounting feet, for 0.6 ... 1.2 mm plate thickness, 3.5 mm mounting hole diameter, gray

Pole No.	Item No.	Pack. Unit
○ 2	261-152/331-000	100
○ 3	261-153/331-000	100
○ 4	261-154/331-000	100
○ 5	261-155/331-000	100
○ 6	261-156/331-000	50
○ 7	261-157/331-000	50
○ 8	261-158/331-000	50
○ 9	261-159/331-000	50
○ 10	261-160/331-000	25
○ 11	261-161/331-000	25
○ 12	261-162/331-000	25

WAGO

#### Technical Data

Rated voltage (III / 3)

500 V

Rated surge voltage (III / 3)

6 kV

Rated current

24 A

Approval

300 V, 15 A ; 300 V, 20 A

#### Connection Data

Solid conductor

0.08 ... 2.5 mm / 28 ... 14 AWG

Fine-stranded conductor

0.08 ... 2.5 mm / 28 ... 14 AWG

Strip length

8 ... 9 mm / 0.31 ... 0.35 inch

Module width

6 mm / 0.236 inch

Insulation material

Polyamide 66 (PA 66)

#### Accessories (Selection)

Comb-style jumper bar, insulated, reduces maximum conductor size to 1.5 mm<sup>2</sup>, I<sub>N</sub> 16 A, gray

Test plug module, snaps together  
Module width 6 mm

Test plug module, snaps together  
Module width 10 mm

	Item No.	Page
2-pole	261-402	623
gray	249-136	623

Dimensional drawing, see page 600

Tools, see Section 13

Marking accessories, see Section 13 and Volume 6

Approvals and corresponding ratings, visit [www.wago.com](http://www.wago.com)



4-conductor terminal strip, with push-buttons on one side, with mounting flanges, for screw or similar mounting types, 3.2 mm mounting hole diameter, gray

Pole No.	Item No.	Pack. Unit
○ 2	261-202/332-000	100
○ 3	261-203/332-000	100
○ 4	261-204/332-000	100
○ 5	261-205/332-000	100
○ 6	261-206/332-000	50
○ 7	261-207/332-000	50
○ 8	261-208/332-000	50
○ 9	261-209/332-000	50
○ 10	261-210/332-000	25
○ 11	261-211/332-000	25
○ 12	261-212/332-000	25

4-conductor terminal strip, with push-buttons on one side, with snap-in mounting feet, for 0.6 ... 1.2 mm plate thickness, 3.5 mm mounting hole diameter, gray

Pole No.	Item No.	Pack. Unit
○ 2	261-252/332-000	100
○ 3	261-253/332-000	100
○ 4	261-254/332-000	100
○ 5	261-255/332-000	100
○ 6	261-256/332-000	50
○ 7	261-257/332-000	50
○ 8	261-258/332-000	50
○ 9	261-259/332-000	50
○ 10	261-260/332-000	25
○ 11	261-261/332-000	100
○ 12	261-262/332-000	25

UL®

500 V

6 kV

24 A

300 V, 15 A **UL**; 300 V, 20 A **UL**

0.08 ... 2.5 mm / 28 ... 14 AWG

0.08 ... 2.5 mm / 28 ... 14 AWG

8 ... 9 mm / 0.31 ... 0.35 inch

10 mm / 0.394 inch

Polyamide 66 (PA 66)

	Item No.	Page
2-pole	261-402	623
gray	249-139	623

## Modular Terminal Blocks with Push-Buttons on Both Sides, Mounting Flange or Snap-In Mounting Foot

### 2.5 mm<sup>2</sup>, 261 Series



Terminal strip, with mounting flanges, for screw or similar mounting types, 3.2 mm mounting hole diameter (with 209-123 Mounting Foot for DIN-35 rail)

Terminal blocks and terminal strips with a blue insulated housing are suitable for Ex i applications.



Terminal strip with snap-in mounting feet, for 0.6 ... 1.2 mm plate thickness, 3.5 mm mounting hole diameter (also for 210-154 Aluminum Rail or with 209-120 Mounting Foot for DIN-35 rail)

2-conductor terminal block, with push-buttons on both sides, with mounting flange, for screw or similar mounting types, 3.2 mm mounting hole diameter, with mounting foot (209-123) also for DIN-35 rail

Color	Item No.	Pack. Unit
gray	261-301/341-000	200 (50)
light gray	261-303/341-000	200 (50)
blue	261-304/341-000	200 (50)
orange	261-306/341-000	200 (50)
green-yellow	261-307/341-000	200 (50)

2-conductor terminal block, with push-buttons on both sides, with snap-in mounting foot, for 0.6 ... 1.2 mm plate thickness, 3.5 mm mounting hole diameter, also for aluminum rail (210-154) or with mounting foot (209-120) for DIN-35 rail

Color	Item No.	Pack. Unit
gray	261-311/341-000	200 (50)
light gray	261-313/341-000	200 (50)
blue	261-314/341-000	200 (50)
orange	261-316/341-000	200 (50)
green-yellow	261-317/341-000	200 (50)

Space-saving, 2-conductor end terminal block, with push-buttons on both sides, without protruding snap-in mounting foot, for terminal strips with snap-in mounting feet

Color	Item No.	Pack. Unit
gray	261-321/341-000	200 (50)
light gray	261-323/341-000	200 (50)
blue	261-324/341-000	200 (50)
orange	261-326/341-000	200 (50)
green-yellow	261-327/341-000	200 (50)

**WAGO**

#### Technical Data

Rated voltage (III / 3)	500 V
Rated surge voltage (III / 3)	6 kV
Rated current	24 A
Approval	300 V, 15 A <b>W</b> ; 300 V, 20 A <b>C</b>

#### Connection Data

Solid conductor	0.08 ... 2.5 mm / 28 ... 14 AWG
Fine-stranded conductor	0.08 ... 2.5 mm / 28 ... 14 AWG
Strip length	8 ... 9 mm / 0.31 ... 0.35 inch
Terminal block width	6 mm / 0.236 inch
Insulation material	Polyamide 66 (PA 66)

#### Accessories (Selection)

Comb-style jumper bar, insulated, reduces maximum conductor size to 1.5 mm <sup>2</sup> , I <sub>N</sub> 16 A, gray
End plate, with mounting flange
End plate, with snap-in mounting foot
Test plug module, snaps together Module width 6 mm
Test plug module, snaps together Module width 10 mm

Dimensional drawing, see page 600

Accessories (jumpers, end plates, test plugs, etc.), see page 623

Tools, see Section 13

Marking accessories, see Section 13 and Volume 6

Approvals and corresponding ratings, visit [www.wago.com](http://www.wago.com)

	Item No.	Page
2-pole	261-402	623
gray	261-361	623
gray	261-371	623
gray	249-136	623



4-conductor terminal block, with push-buttons on both sides, with mounting flange, for screw or similar mounting types, 3.2 mm mounting hole diameter, with mounting foot (209-123) also for DIN-35 rail

Color	Item No.	Pack. Unit
gray	261-331/342-000	200 (50)
light gray	261-333/342-000	200 (50)
blue	261-334/342-000	200 (50)
orange	261-336/342-000	200 (50)
green-yellow	261-337/342-000	200 (50)

4-conductor terminal block, with push-buttons on both sides, with snap-in mounting foot, for 0.6 ... 1.2 mm plate thickness, 3.5 mm mounting hole diameter, also for aluminum rail (210-154) or with mounting foot (209-120) for DIN-35 rail

Color	Item No.	Pack. Unit
gray	261-341/342-000	200 (50)
light gray	261-343/342-000	200 (50)
blue	261-344/342-000	200 (50)
orange	261-346/342-000	200 (50)
green-yellow	261-347/342-000	200 (50)

Space-saving, 4-conductor end terminal block, with push-buttons on both sides, without protruding snap-in mounting foot, for terminal strips with snap-in mounting feet

Color	Item No.	Pack. Unit
gray	261-351/342-000	200 (50)
light gray	261-353/342-000	200 (50)
blue	261-354/342-000	200 (50)
orange	261-356/342-000	200 (50)
green-yellow	261-357/342-000	200 (50)

UL®

500 V

6 kV

24 A

300 V, 15 A , 300 V, 20 A 

0.08 ... 2.5 mm / 28 ... 14 AWG

0.08 ... 2.5 mm / 28 ... 14 AWG

8 ... 9 mm / 0.31 ... 0.35 inch

10 mm / 0.394 inch

Polyamide 66 (PA 66)

	Item No.	Page
2-pole	261-402	623
gray	261-361	623
gray	261-371	623
gray	249-139	623

## Terminal Strips with Push-Buttons on Both Sides, Mounting Flanges or Snap-In Mounting Feet

### 2.5 mm<sup>2</sup>, 261 Series

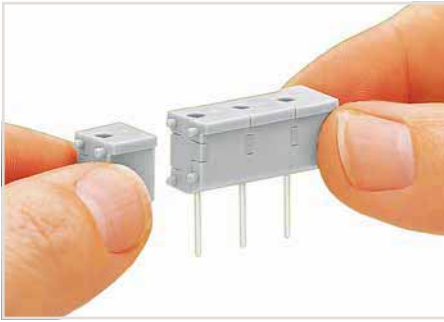

Snapping individual modules together to assemble a multi-pole test plug module.

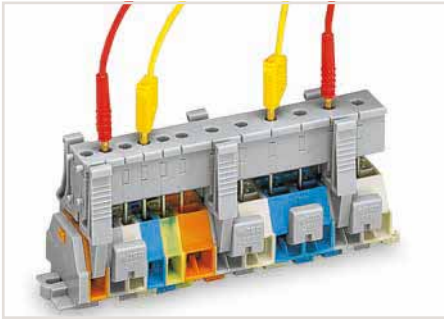

Testing via test plug modules snapped onto a terminal strip – wired or unwired. As touch contact is made with the CAGE CLAMP® (spring steel) unit, this testing type is limited to maximum 0.5 A.

Distance between locking devices must be approximately 35 ... 40 mm.



Testing after the conductors have been terminated.

Terminal blocks and terminal strips with a blue insulated housing are suitable for Ex i applications.

Item no. suffixes for gray terminal strips in:  
blue .../000-006

Longer strips and/or mixed-color assemblies are available upon request.

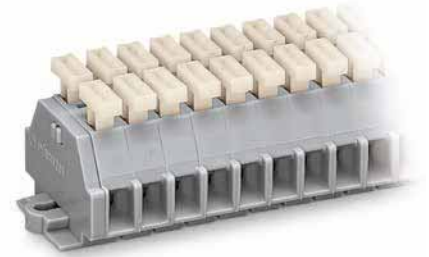

2-conductor terminal strip, with push-buttons on both sides, with mounting flanges, for screw or similar mounting types, 3.2 mm mounting hole diameter, gray

Pole No.	Item No.	Pack. Unit
○ 2	261-102/341-000	100
○ 3	261-103/341-000	100
○ 4	261-104/341-000	100
○ 5	261-105/341-000	200
○ 6	261-106/341-000	50
○ 7	261-107/341-000	50
○ 8	261-108/341-000	50
○ 9	261-109/341-000	50
○ 10	261-110/341-000	25
○ 11	261-111/341-000	25
○ 12	261-112/341-000	25

2-conductor terminal strip, with push-buttons on both sides, with snap-in mounting feet, for 0.6 ... 1.2 mm plate thickness, 3.5 mm mounting hole diameter, gray

Pole No.	Item No.	Pack. Unit
○ 2	261-152/341-000	100
○ 3	261-153/341-000	100
○ 4	261-154/341-000	100
○ 5	261-155/341-000	100
○ 6	261-156/341-000	50
○ 7	261-157/341-000	50
○ 8	261-158/341-000	50
○ 9	261-159/341-000	50
○ 10	261-160/341-000	25
○ 11	261-161/341-000	25
○ 12	261-162/341-000	25

**WAGO**

#### Technical Data

Rated voltage (III / 3)

500 V

Rated surge voltage (III / 3)

6 kV

Rated current

24 A

Approval

300 V, 15 A **W**; 300 V, 20 A **®**

#### Connection Data

Solid conductor

0.08 ... 2.5 mm / 28 ... 14 AWG

Fine-stranded conductor

0.08 ... 2.5 mm / 28 ... 14 AWG

Strip length

8 ... 9 mm / 0.31 ... 0.35 inch

Module width

6 mm / 0.236 inch

Insulation material

Polyamide 66 (PA 66)

#### Accessories (Selection)

Comb-style jumper bar, insulated, reduces maximum conductor size to 1.5 mm<sup>2</sup>, I<sub>N</sub> 16 A, gray

Test plug module, snaps together  
Module width 6 mm

Test plug module, snaps together  
Module width 10 mm

	Item No.	Page
2-pole	261-402	623
gray	249-136	623

 Dimensional drawing, see page 600

 Tools, see Section 13

 Marking accessories, see Section 13 and Volume 6

 Approvals and corresponding ratings, visit [www.wago.com](http://www.wago.com)



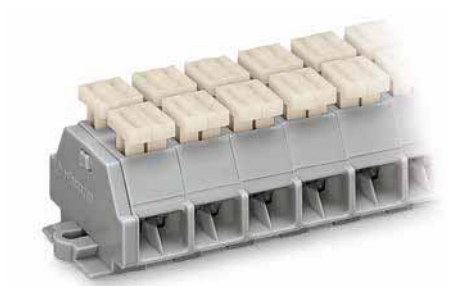

4-conductor terminal strip, with push-buttons on both sides, with mounting flanges, for screw or similar mounting types, 3.2 mm mounting hole diameter, gray

Pole No.	Item No.	Pack. Unit
○ 2	261-202/332-000	100
○ 3	261-203/332-000	100
○ 4	261-204/332-000	100
○ 5	261-205/332-000	100
○ 6	261-206/332-000	50
○ 7	261-207/332-000	50
○ 8	261-208/332-000	50
○ 9	261-209/332-000	50
○ 10	261-210/332-000	25
○ 11	261-211/332-000	25
○ 12	261-212/332-000	25

4-conductor terminal strip, with push-buttons on both sides, with snap-in mounting feet, for 0.6 ... 1.2 mm plate thickness, 3.5 mm mounting hole diameter, gray

Pole No.	Item No.	Pack. Unit
○ 2	261-252/332-000	100
○ 3	261-253/332-000	100
○ 4	261-254/332-000	100
○ 5	261-255/332-000	100
○ 6	261-256/332-000	50
○ 7	261-257/332-000	50
○ 8	261-258/332-000	50
○ 9	261-259/332-000	50
○ 10	261-260/332-000	25
○ 11	261-261/332-000	100
○ 12	261-262/332-000	25

UL®

500 V

6 kV

24 A

300 V, 15 A **UL**; 300 V, 20 A **UL**

0.08 ... 2.5 mm / 28 ... 14 AWG

0.08 ... 2.5 mm / 28 ... 14 AWG

8 ... 9 mm / 0.31 ... 0.35 inch

10 mm / 0.394 inch

Polyamide 66 (PA 66)

	Item No.	Page
2-pole	261-402	623
gray	249-139	623

# Modular Terminal Blocks and Terminal Strips with Mounting Flanges and Marker Slot for Mini-WSB Quick Marking System

## 2.5 mm<sup>2</sup>, 261 Series

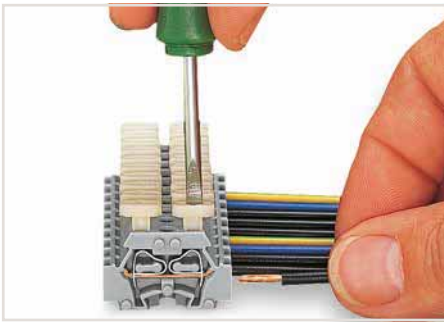

**CAGE CLAMP® connection**  
Inserting a conductor via push-button.

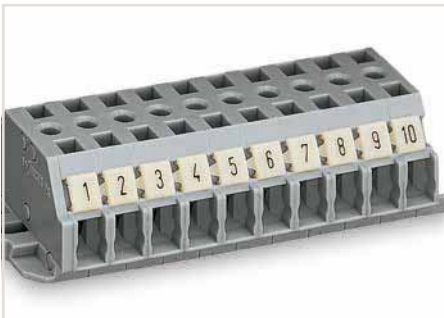

Terminal strip with marker slot for Mini-WSB Quick Marking System

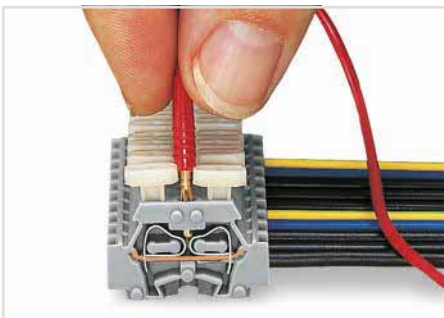

Testing with a 2 mm Ø test plug – touch contact.



Terminal strip, with mounting flanges, for screw or similar mounting types, 3.2 mm mounting hole diameter (with 209-123 Mounting Foot for DIN-35 rail)

Longer strips and/or mixed-color assemblies are available upon request.

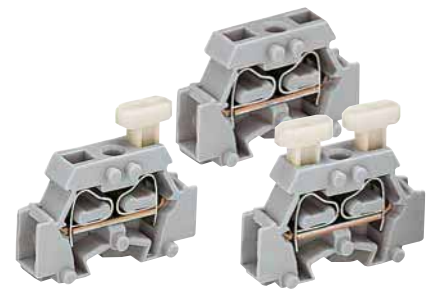

2-conductor terminal block, with mounting flange, for screw or similar mounting types, 3.2 mm mounting hole diameter, with mounting foot (209-123) also for DIN-35 rail

Color	Item No.	Pack. Unit
○ gray	261-411	200 (50)

2-conductor terminal block, with push-button on one side, with mounting flange, for screw or similar mounting types, 3.2 mm mounting hole diameter, with mounting foot (209-123) also for DIN-35 rail

Color	Item No.	Pack. Unit
○ gray	261-411/331-000	200 (50)

2-conductor terminal block, with push-buttons on both sides, with mounting flange, for screw or similar mounting types, 3.2 mm mounting hole diameter, with mounting foot (209-123) also for DIN-35 rail

Color	Item No.	Pack. Unit
○ gray	261-411/341-000	200 (50)

**UL®**

**Technical Data**





Rated voltage (III / 3)	500 V
Rated surge voltage (III / 3)	6 kV
Rated current	24 A
Approval	300 V, 15 A <b>UL</b> , 300 V, 20 A <b>CE</b>
<b>Connection Data</b>	
Solid conductor	0.08 ... 2.5 mm / 28 ... 14 AWG
Fine-stranded conductor	0.08 ... 2.5 mm / 28 ... 14 AWG
Strip length	8 ... 9 mm / 0.31 ... 0.35 inch
Terminal block width	6 mm / 0.236 inch
Module width	
Insulation material	Polyamide 66 (PA 66)

**Accessories (Selection)**

Comb-style jumper bar, insulated, reduces maximum conductor size to 1.5 mm <sup>2</sup> , I <sub>N</sub> 16 A, gray	
End plate, with mounting flange	
Mini-WSB Inline, plain, 1,700 Mini-WSB markers (5 mm wide) per reel	
Mounting foot with screw, can be screwed on terminal blocks with mounting flange, 6.4 mm wide	
Mounting adapter, for DIN-35 rail, can be used as end plate, 6.5 mm wide	

500 V	
6 kV	
24 A	
300 V, 15 A <b>UL</b> , 300 V, 20 A <b>CE</b>	
0.08 ... 2.5 mm / 28 ... 14 AWG	
0.08 ... 2.5 mm / 28 ... 14 AWG	
8 ... 9 mm / 0.31 ... 0.35 inch	
6 mm / 0.236 inch	
Polyamide 66 (PA 66)	

	Item No.	Page
2-pole	261-402	623
gray	261-410	623
white	209-145	781
gray	209-123	625
gray	209-137	625

-  Dimensional drawing, see page 601
-  Accessories (jumpers, end plates, etc.), see page 623
-  Tools, see Section 13
-  Appropriate marking system: Mini-WSB/Mini-WSB Inline, see Full Line Catalog, Volume 6
-  Approvals and corresponding ratings, visit [www.wago.com](http://www.wago.com)

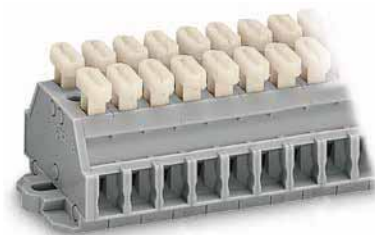
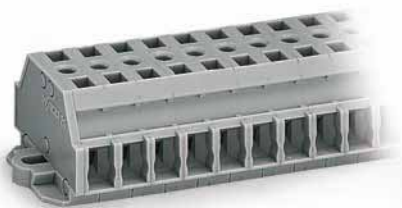

2-conductor terminal strip, with mounting flanges, for screw or similar mounting types, 3.2 mm mounting hole diameter, gray

Pole No.	Item No.	Pack. Unit
2	261-422	100
3	261-423	100
4	261-424	100
5	261-425	100
6	261-426	50
7	261-427	50
8	261-428	50
9	261-429	50
10	261-430	25
11	261-431	25
12	261-432	25

2-conductor terminal strip, with push-buttons on one side, with mounting flanges, for screw or similar mounting types, 3.2 mm mounting hole diameter, gray

Pole No.	Item No.	Pack. Unit
2	261-422/331-000	100
3	261-423/331-000	100
4	261-424/331-000	100
5	261-425/331-000	100
6	261-426/331-000	50
7	261-427/331-000	50
8	261-428/331-000	50
9	261-429/331-000	50
10	261-430/331-000	25
11	261-431/331-000	25
12	261-432/331-000	25

2-conductor terminal strip, with push-buttons on both sides, with mounting flanges, for screw or similar mounting types, 3.2 mm mounting hole diameter, gray

Pole No.	Item No.	Pack. Unit
2	261-422/341-000	100
3	261-423/341-000	100
4	261-424/341-000	100
5	261-425/341-000	100
6	261-426/341-000	50
7	261-427/341-000	50
8	261-428/341-000	50
9	261-429/341-000	50
10	261-430/341-000	25
11	261-431/341-000	25
12	261-432/341-000	25



500 V
6 kV
24 A
300 V, 15 A ; 300 V, 20 A
0.08 ... 2.5 mm / 28 ... 14 AWG
0.08 ... 2.5 mm / 28 ... 14 AWG
8 ... 9 mm / 0.31 ... 0.35 inch
6 mm / 0.236 inch
Polyamide 66 (PA 66)

	Item No.	Page
2-pole	261-402	623
white	2009-145	781
gray	209-123	625
gray	209-137	625



500 V
6 kV
24 A
300 V, 15 A ; 300 V, 20 A
0.08 ... 2.5 mm / 28 ... 14 AWG
0.08 ... 2.5 mm / 28 ... 14 AWG
8 ... 9 mm / 0.31 ... 0.35 inch
6 mm / 0.236 inch
Polyamide 66 (PA 66)

	Item No.	Page
2-pole	261-402	623
white	2009-145	781
gray	209-123	625
gray	209-137	625



500 V
6 kV
24 A
300 V, 15 A ; 300 V, 20 A
0.08 ... 2.5 mm / 28 ... 14 AWG
0.08 ... 2.5 mm / 28 ... 14 AWG
8 ... 9 mm / 0.31 ... 0.35 inch
6 mm / 0.236 inch
Polyamide 66 (PA 66)

	Item No.	Page
2-pole	261-402	623
white	2009-145	781
gray	209-123	625
gray	209-137	625

## Modular Terminal Blocks with Mounting Flange or Snap-In Mounting Foot

### 4 mm<sup>2</sup>, 262 Series



Terminal strip, with mounting flanges, for screw or similar mounting types, 3.2 mm mounting hole diameter (with 209-123 Mounting Foot for DIN-35 rail)



Terminal strip with snap-in mounting feet, for 0.6 ... 1.2 mm plate thickness, 3.5 mm mounting hole diameter (also for 210-154 Aluminum Rail or with 209-120 Mounting Foot for DIN-35 rail)

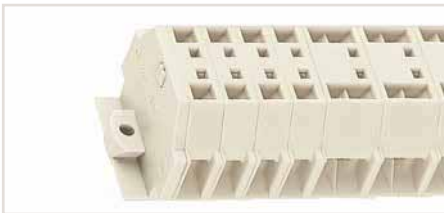

Terminal strip, with mounting flanges, for screw or similar mounting types, 3.2 mm mounting hole diameter (with 209-123 Mounting Foot for DIN-35 rail)



Terminal strip with snap-in mounting feet, for 0.6 ... 1.2 mm plate thickness, 3.5 mm mounting hole diameter (also for 210-154 Aluminum Rail or with 209-120 Mounting Foot for DIN-35 rail)

Terminal blocks with a blue insulated housing are suitable for Ex i applications.

Using crimped ferrules for corrosion protection, the rated cross-section is reduced by one size.

For conductor types and conductor preparation, see Section 14 "Electrical Equipment for Hazardous Environments."



2-conductor terminal block, with mounting flange, for screw or similar mounting types, 3.2 mm mounting hole diameter, with mounting foot (209-123) also for DIN-35 rail

Color	Item No.	Pack. Unit
gray	262-301	100 (50)
blue	262-304	100 (50)
orange	262-306	100 (50)
green-yellow	262-307	100 (50)

2-conductor terminal block, with snap-in mounting foot, for 0.6 ... 1.2 mm plate thickness, 3.5 mm mounting hole diameter, also for aluminum rail (210-154) or with mounting foot (209-120) for DIN-35 rail

Color	Item No.	Pack. Unit
gray	262-311	100 (50)
blue	262-314	100 (50)
orange	262-316	100 (50)
green-yellow	262-317	100 (50)

Space-saving, 2-conductor end terminal block, without protruding snap-in mounting foot, for terminal strips with snap-in mounting feet

Color	Item No.	Pack. Unit
gray	262-321	100 (50)
blue	262-324	100 (50)
orange	262-326	100 (50)
green-yellow	262-327	100 (50)

**UL**

630 V

8 kV

24 A

300 V, 20 A **UL**; 300 V, 20 A **CE**

0.08 ... 4 mm / 28 ... 12 AWG

0.08 ... 4 mm / 28 ... 12 AWG

9 ... 10 mm / 0.35 ... 0.39 inch

7 mm / 0.276 inch

Polyamide 66 (PA 66)

#### Technical Data

Rated voltage (III / 3)

Rated surge voltage (III / 3)

Rated current

Rated voltage EN (Ex e II)

Approval

#### Connection Data

Solid conductor

Fine-stranded conductor

Strip length

Terminal block width

Insulation material

#### Accessories (Selection)

Comb-style jumper bar, insulated, reduces maximum conductor size to 2.5 mm<sup>2</sup>, I<sub>N</sub> 16 A, gray

End plate, with mounting flange

End plate, with snap-in mounting foot

Test plug module, snaps together  
Module width 7 mm

Test plug module, snaps together  
Module width 12 mm

Dimensional drawing, see page 601

Accessories (jumpers, end plates, test plugs, etc.), see page 624

Tools, see Section 13

Marking accessories, see Section 13 and Volume 6

Information on hazardous locations, see Section 14

Approvals and corresponding ratings, visit [www.wago.com](http://www.wago.com)

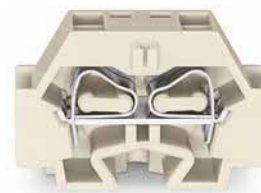

4-conductor terminal block, with mounting flange, for screw or similar mounting types, 3.2 mm mounting hole diameter, with mounting foot (209-123) also for DIN-35 rail

Color	Item No.	Pack. Unit
○ gray	262-331	100 (50)
● blue	262-334	100 (50)
● orange	262-336	100 (50)
● green-yellow	262-337	100 (50)

2-conductor Ex e II terminal block, with mounting flange, for screw or similar mounting types, 3.2 mm mounting hole diameter, with mounting foot (209-123) also for DIN-35 rail

Color	Item No.	Pack. Unit
○ light gray ☺	262-130	100 (50)

4-conductor Ex e II terminal block, with mounting flange, for screw or similar mounting types, 3.2 mm mounting hole diameter, with mounting foot (209-123) also for DIN-35 rail

Color	Item No.	Pack. Unit
○ light gray ☺	262-230	100 (50)

4-conductor terminal block, with snap-in mounting foot, for 0.6 ... 1.2 mm plate thickness, 3.5 mm mounting hole diameter, also for aluminum rail (210-154) or with mounting foot (209-120) for DIN-35 rail

Color	Item No.	Pack. Unit
○ gray	262-341	100 (50)
● blue	262-344	100 (50)
● orange	262-346	100 (50)
● green-yellow	262-347	100 (50)

2-conductor Ex e II terminal block, with snap-in mounting foot, for 0.6 ... 1.2 mm plate thickness, 3.5 mm mounting hole diameter, also for aluminum rail (210-154) or with mounting foot (209-120) for DIN-35 rail

Color	Item No.	Pack. Unit
○ light gray ☺	262-180	100 (50)

4-conductor Ex e II terminal block, with snap-in mounting foot, for 0.6 ... 1.2 mm plate thickness, 3.5 mm mounting hole diameter, also for aluminum rail (210-154) or with mounting foot (209-120) for DIN-35 rail

Color	Item No.	Pack. Unit
○ light gray ☺	262-280	100 (50)

Space-saving, 2-conductor end terminal block, without protruding snap-in mounting foot, for terminal strips with snap-in mounting feet

Color	Item No.	Pack. Unit
○ gray	262-351	100 (50)
● blue	262-354	100 (50)
● orange	262-356	100 (50)
● green-yellow	262-357	100 (50)

Space-saving, 2-conductor Ex e II end terminal block, without protruding snap-in mounting foot, for terminal strips with snap-in mounting feet

Color	Item No.	Pack. Unit
○ light gray ☺	262-181	100 (50)

Space-saving, 4-conductor Ex e II end terminal block, without protruding snap-in mounting foot, for terminal strips with snap-in mounting feet

Color	Item No.	Pack. Unit
○ light gray ☺	262-281	100 (50)

UL®

630 V

8 kV

32 A

300 V, 20 A **UL**; 300 V, 20 A ☺

0.08 ... 4 mm / 28 ... 12 AWG

0.08 ... 4 mm / 28 ... 12 AWG

9 ... 10 mm / 0.35 ... 0.39 inch

12 mm / 0.472 inch

Polyamide 66 (PA 66)

UL®

23 A

550 V

300 V, 20 A **UL**; 300 V, 20 A ☺

0.5 ... 4 mm / 20 ... 12 AWG

0.5 ... 4 mm / 20 ... 12 AWG

9 ... 10 mm / 0.35 ... 0.39 inch

7 mm / 0.276 inch

Polyamide 66 (PA 66)

UL®

30 A

550 V

300 V, 20 A **UL**; 300 V, 20 A ☺

0.5 ... 4 mm / 20 ... 12 AWG

0.5 ... 4 mm / 20 ... 12 AWG

9 ... 10 mm / 0.35 ... 0.39 inch

12 mm / 0.472 inch

Polyamide 66 (PA 66)

	Item No.	Page
2-pole	262-402	624
gray	262-361	624
gray	262-371	624
gray	249-140	624

	Item No.	Page
2-pole	262-402	624
light gray	262-363	624
light gray	262-373	624

	Item No.	Page
2-pole	262-402	624
light gray	262-363	624
light gray	262-373	624



## Terminal Strips with Mounting Flanges or Snap-in Mounting Feet 4 mm<sup>2</sup>, 262 Series

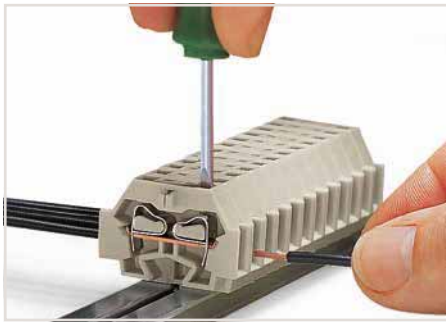

**CAGE CLAMP® connection**  
Inserting a conductor via screwdriver.

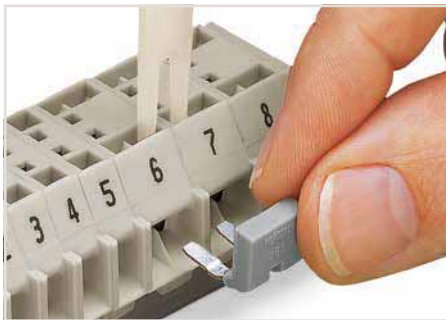

Commoning with comb-style jumper bar.

Terminal strips with a blue insulated housing are suitable for Ex i applications.

Item no. suffixes for gray terminal strips in:  
blue .../000-006

Longer strips and/or mixed-color assemblies are available upon request.

Using crimped ferrules for corrosion protection, the rated cross-section is reduced by one size.

For conductor types and conductor preparation, see Section 14 "Electrical Equipment for Hazardous Environments."

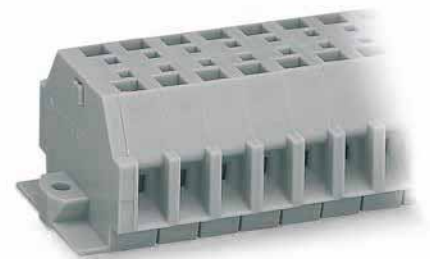

2-conductor terminal strip, with mounting flanges, for screw or similar mounting types, 3.2 mm mounting hole diameter, gray

Pole No.	Item No.	Pack. Unit
○ 2	262-102	100
○ 3	262-103	100
○ 4	262-104	100
○ 5	262-105	100
○ 6	262-106	100
○ 7	262-107	100
○ 8	262-108	100
○ 9	262-109	50
○ 10	262-110	25
○ 11	262-111	25
○ 12	262-112	25

2-conductor terminal strip, with snap-in mounting feet, for 0.6 ... 1.2 mm plate thickness, 3.5 mm mounting hole diameter, gray

Pole No.	Item No.	Pack. Unit
○ 2	262-152	100
○ 3	262-153	100
○ 4	262-154	100
○ 5	262-155	100
○ 6	262-156	50
○ 7	262-157	50
○ 8	262-158	50
○ 9	262-159	50
○ 10	262-160	25
○ 11	262-161	25
○ 12	262-162	25



### Technical Data

Rated voltage (III / 3)	630 V
Rated surge voltage (III / 3)	8 kV
Rated current	24 A
Rated voltage EN (Ex e II)	
Approval	300 V, 20 A ; 300 V, 20 A

### Connection Data

Solid conductor	0.08 ... 4 mm / 28 ... 12 AWG
Fine-stranded conductor	0.08 ... 4 mm / 28 ... 12 AWG
Strip length	9 ... 10 mm / 0.35 ... 0.39 inch
Module width	7 mm / 0.276 inch
Insulation material	Polyamide 66 (PA 66)

### Accessories (Selection)

Comb-style jumper bar, insulated, reduces maximum conductor size to 2.5 mm <sup>2</sup> , I <sub>N</sub> 16 A, gray		
Test plug module, snaps together Module width 7 mm		
Test plug module, snaps together Module width 12 mm		

	Item No.	Page
2-pole	262-402	624
gray	249-137	624

Dimensional drawing, see page 601

Tools, see Section 13

Marking accessories, see Section 13 and Volume 6

Information on hazardous locations, see Section 14

Approvals and corresponding ratings, visit [www.wago.com](http://www.wago.com)



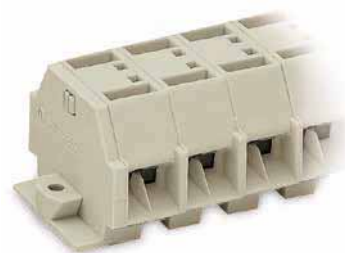
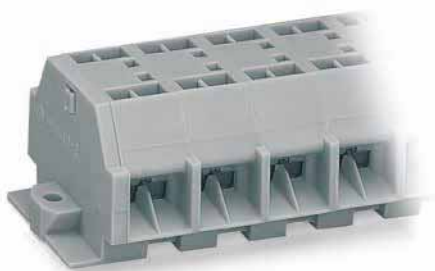

4-conductor terminal strip, with mounting flanges, for screw or similar mounting types, 3.2 mm mounting hole diameter, gray

Pole No.	Item No.	Pack. Unit
2	262-202	100
3	262-203	100
4	262-204	100
5	262-205	100
6	262-206	50
7	262-207	50
8	262-208	50
9	262-209	50
10	262-210	25
11	262-211	25
12	262-212	25

2-conductor Ex e II terminal strip, with mounting flanges, for screw or similar mounting types, 3.2 mm mounting hole diameter, light gray

Pole No.	Item No.	Pack. Unit
2	262-132	100
3	262-133	100
4	262-134	100
5	262-135	100
6	262-136	100
7	262-137	50
8	262-138	50
9	262-139	50
10	262-140	25
11	262-141	25
12	262-142	25

4-conductor Ex e II terminal strip, with mounting flanges, for screw or similar mounting types, 3.2 mm mounting hole diameter, light gray

Pole No.	Item No.	Pack. Unit
2	262-232	100
3	262-233	100
4	262-234	100
5	262-235	100
6	262-236	50
7	262-237	50
8	262-238	50
9	262-239	50
10	262-240	25
11	262-241	25
12	262-242	25

4-conductor terminal strip, with snap-in mounting feet, for 0.6 ... 1.2 mm plate thickness, 3.5 mm mounting hole diameter, gray

Pole No.	Item No.	Pack. Unit
2	262-252	100
3	262-253	100
4	262-254	100
5	262-255	100
6	262-256	50
7	262-257	50
8	262-258	50
9	262-259	50
10	262-260	25
11	262-261	25
12	262-262	25

2-conductor Ex e II terminal strip, with snap-in mounting feet, for 0.6 ... 1.2 mm plate thickness, 3.5 mm mounting hole diameter, light gray

Pole No.	Item No.	Pack. Unit
2	262-182	100
3	262-183	100
4	262-184	100
5	262-185	100
6	262-186	50
7	262-187	50
8	262-188	50
9	262-189	50
10	262-190	25
11	262-191	25
12	262-192	25

4-conductor Ex e II terminal strip, with snap-in mounting feet, for 0.6 ... 1.2 mm plate thickness, 3.5 mm mounting hole diameter, light gray

Pole No.	Item No.	Pack. Unit
2	262-282	100
3	262-283	100
4	262-284	100
5	262-285	100
6	262-286	50
7	262-287	50
8	262-288	50
9	262-289	50
10	262-290	25
11	262-291	25
12	262-292	25

UL®

630 V  
8 kV  
32 A

300 V, 20 A **UL**; 300 V, 20 A **CE**

0.08 ... 4 mm / 28 ... 12 AWG  
0.08 ... 4 mm / 28 ... 12 AWG  
9 ... 10 mm / 0.35 ... 0.39 inch  
12 mm / 0.472 inch  
Polyamide 66 (PA 66)

	Item No.	Page
2-pole	262-402	624
gray	249-140	624

UL®

23 A  
550 V

300 V, 20 A **UL**; 300 V, 20 A **CE**

0.08 ... 4 mm / 28 ... 12 AWG  
0.08 ... 4 mm / 28 ... 12 AWG  
9 ... 10 mm / 0.35 ... 0.39 inch  
7 mm / 0.276 inch  
Polyamide 66 (PA 66)

	Item No.	Page
2-pole	262-402	624

UL®

30 A  
550 V

300 V, 20 A **UL**; 300 V, 20 A **CE**

0.08 ... 4 mm / 28 ... 12 AWG  
0.08 ... 4 mm / 28 ... 12 AWG  
9 ... 10 mm / 0.35 ... 0.39 inch  
12 mm / 0.472 inch  
Polyamide 66 (PA 66)

	Item No.	Page
2-pole	262-402	624

## Accessories for 260 Series Modular Terminal Blocks and Terminal Strips

### Commoning, Mounting, Marking and Testing



Comb-style jumper bar, insulated, reduces maximum conductor size to 1 mm <sup>2</sup> , I <sub>n</sub> 10 A, gray		
	Item No.	Pack. Unit
2-pole	260-402	25



Operating tool, insulated, for comb-style jumper bar		
	Item No.	Pack. Unit
2-pole	209-132	1



End plate, with mounting flange		
Color	Item No.	Pack. Unit
gray	260-361	300 (50)



End plate, with snap-in mounting foot		
Color	Item No.	Pack. Unit
gray	260-371	300 (50)



 Test plugs,  
see page 604

Maximum test voltage: 250 V (only in test equipment acc. to relevant clearances and creepage distances)

Maximum test voltage (touch contact): 48 V (test pins are not touch-proof)

Maximum test current (touch contact): 0.5 A

Maximum test current: 6 A (if the test pins are securely connected in the clamping units)

Test voltage	48 V
Test current	0.5 A

8

Test plug module, snaps together Module width 5 mm			
Suitable for:	Color	Item No.	Pack. Unit
2-conductor terminal blocks	gray	249-135	100 (25)

Maximum test voltage: 250 V (only in test equipment acc. to relevant clearances and creepage distances)



Test plug module, with locking latches, snaps together Module width 5 mm			
Suitable for:	Color	Item No.	Pack. Unit
2-conductor terminal blocks	gray	260-404	100 (25)

Maximum test voltage: 500 V (only in test equipment acc. to relevant clearances and creepage distances)



Test plug module, snaps together Module width 8 mm			
Suitable for:	Color	Item No.	Pack. Unit
4-conductor terminal blocks	gray	249-138	100 (25)

Maximum test voltage: 500 V (only in test equipment acc. to relevant clearances and creepage distances)



Test plug module, with locking latches, snaps together Module width 8 mm			
Suitable for:	Color	Item No.	Pack. Unit
4-conductor terminal blocks	gray	260-405	100 (25)

## Accessories for 261 Series Modular Terminal Blocks and Terminal Strips

### Commoning, Mounting, Marking and Testing



Comb-style jumper bar, insulated, reduces maximum conductor size to 1.5 mm <sup>2</sup> , I <sub>n</sub> 16 A, gray			
		Item No.	Pack. Unit
2-pole		261-402	25



Operating tool, insulated, for comb-style jumper bar			
		Item No.	Pack. Unit
2-pole		209-132	1



End plate, with mounting flange			
Color		Item No.	Pack. Unit
gray		261-361	300 (50)



End plate, with snap-in mounting foot			
Color		Item No.	Pack. Unit
gray		261-371	300 (50)



End plate, with mounting flange			
Suitable for:	Color	Item No.	Pack. Unit
261-411	gray	261-410	300 (50)



 Test plugs,  
see page 608

Maximum test voltage: 400 V (only in test equipment acc. to relevant clearances and creepage distances)

Maximum test voltage (touch contact): 48 V (test pins are not touch-proof)

Maximum test current (touch contact): 0.5 A

Maximum test current: 6 A (if the test pins are securely connected in the clamping units)

Test voltage	48 V
Test current	0.5 A

Test plug module, snaps together Module width 6 mm			
Suitable for:	Color	Item No.	Pack. Unit
2-conductor terminal blocks	gray	249-136	100 (25)

Maximum test voltage: 400 V (only in test equipment acc. to relevant clearances and creepage distances)



Test plug module, with locking latches, snaps together Module width 6 mm			
Suitable for:	Color	Item No.	Pack. Unit
2-conductor terminal blocks	gray	261-404	100 (25)

Maximum test voltage: 800 V (only in test equipment acc. to relevant clearances and creepage distances)



Test plug module, snaps together Module width 10 mm			
Suitable for:	Color	Item No.	Pack. Unit
4-conductor terminal blocks	gray	249-139	100 (25)

Maximum test voltage: 800 V (only in test equipment acc. to relevant clearances and creepage distances)



Test plug module, with locking latches, snaps together Module width 10 mm			
Suitable for:	Color	Item No.	Pack. Unit
4-conductor terminal blocks	gray	261-405	100 (25)

## Accessories for 262 Series Modular Terminal Blocks and Terminal Strips Commoning, Mounting, Marking and Testing



Comb-style jumper bar, insulated, reduces maximum conductor size to 2.5 mm <sup>2</sup> , I <sub>N</sub> 16 A, gray			
		Item No.	Pack. Unit
2-pole		262-402	25



Operating tool, insulated, for comb-style jumper bar			
		Item No.	Pack. Unit
2-pole		209-132	1



End plate, with mounting flange			
Color		Item No.	Pack. Unit
gray		262-361	50



End plate, with snap-in mounting foot			
Color		Item No.	Pack. Unit
gray		262-371	500 (50)



End plate, with mounting flange			
Suitable for:	Color	Item No.	Pack. Unit
262-130	gray	262-363	50



End plate, with snap-in mounting foot			
Suitable for:	Color	Item No.	Pack. Unit
262-230	gray	262-373	50



 Test plugs, see page 604

Maximum test voltage: 500 V (only in test equipment acc. to relevant clearances and creepage distances)  
 Maximum test voltage (touch contact): 48 V (test pins are not touch-proof)  
 Maximum test current (touch contact): 0.5 A  
 Maximum test current: 6 A (if the test pins are securely connected in the clamping units)

Test voltage	48 V
Test current	0.5 A

Test plug module, snaps together Module width 7 mm			
Suitable for:	Color	Item No.	Pack. Unit
2-conductor terminal blocks	gray	249-137	100 (25)

Maximum test voltage: 800 V (only in test equipment acc. to relevant clearances and creepage distances)

Test plug module, snaps together Module width 12 mm			
Suitable for:	Color	Item No.	Pack. Unit
4-conductor terminal blocks	gray	249-140	100 (25)



## General Accessories



Aluminum carrier rail, 1000 mm long, 18 mm wide, 7 mm high			
Suitable for:	Color	Item No.	Pack. Unit
Terminal strips with snap-in mounting feet	silver	210-154	1



Plastic end stop, with WSB marker slot, for aluminum carrier rail (210-154) Width 6 mm		
Color	Item No.	Pack. Unit
gray	209-122	25



Mounting foot, snaps onto terminal blocks with snap-in mounting foot, 6.4 mm wide		
Color	Item No.	Pack. Unit
gray	209-120	25



Mounting foot with screw, can be screwed on terminal blocks with mounting flange, 6.4 mm wide		
Color	Item No.	Pack. Unit
gray	209-123	25



Mounting adapter, for DIN-35 rail, can be used as end plate, 6.5 mm wide		
Color	Item No.	Pack. Unit
gray	209-137	25





## Chassis-Mount Terminal Strips Field-Wiring Terminal Blocks



## Chassis-Mount Terminal Strips and Field-Wiring Terminal Blocks

### Side-Entry Wiring

			Page
	<b>4-Conductor Chassis-Mount Terminal Strips</b> 0.5 ... 4 mm <sup>2</sup> (20 ... 12 AWG)	862 Series	631
	<b>Field-Wiring Terminal Blocks</b> 0.5 ... 2.5 mm <sup>2</sup> (18 ... 12 AWG)	294 Series	639
	<b>Field-Wiring Terminal Blocks</b> 0.5 ... 2.5 mm <sup>2</sup> (18 ... 12 AWG)	293 Series	648

## 4-Conductor Chassis-Mount Terminal Strips, 862 Series Description and Installation

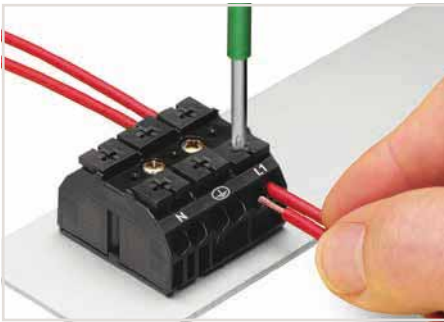

Terminating four conductors per pole – solid and fine-stranded.



Inserting a conductor via push-button.

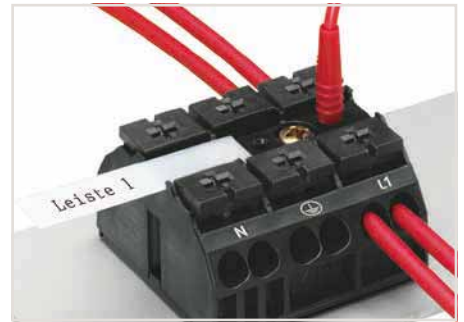

Testing with a 2 mm Ø test plug.



Makes an automatic contact to the mounting plate. The plate's varnish is instantly penetrated.



Commoning using a comb-style jumper bar (862-482).

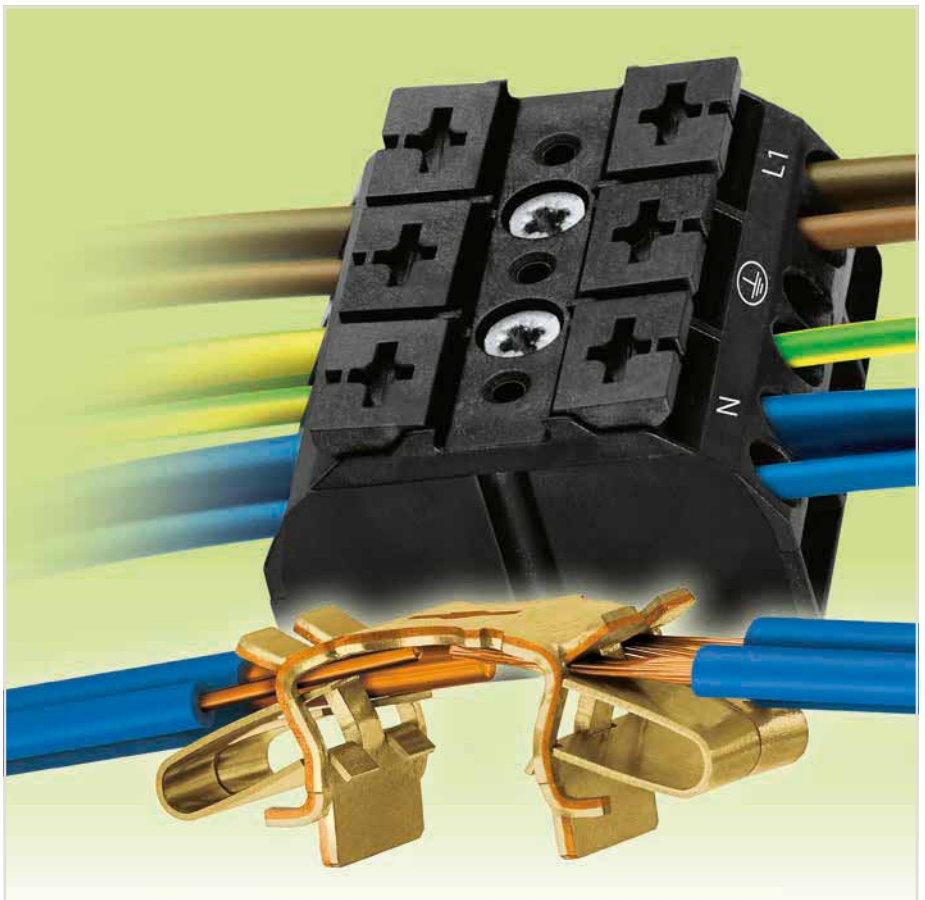

9

### Cost-effective features:

WAGO's 862 Series Chassis-Mount Terminal Strips were developed specifically to minimize wiring costs, while accommodating requirements for flexible mounting, multiple connection points and easy handling:

- Equipped with Push-in CAGE CLAMP®, the 862 Series connects up to four conductors sized 0.5 ... 4 mm<sup>2</sup> (20 ... 12 AWG). Due to multiple connection points per pole, different conductor sizes can be used within the same terminal block position.
- For factory wiring, Push-in CAGE CLAMP® Connection Technology allows solid conductors, fine-stranded conductors with ferrules or ultrasonically bonded conductors from 0.5 ... 4 mm<sup>2</sup> (20 ... 12 AWG) to be terminated by simply pushing them into unit (length of bonded conductor end: min. 10 mm).
- Convenient automatic grounding contact optional
- Snap-in mounting feet for fast assembly
- Push-buttons for easy installation with an operating tool or by hand
- Built-in test points simplify testing with 2 mm Ø test plug.
- Flexible marking options with standard marking (pre-marked), marking strip or custom marked for large orders

# Mounting Types

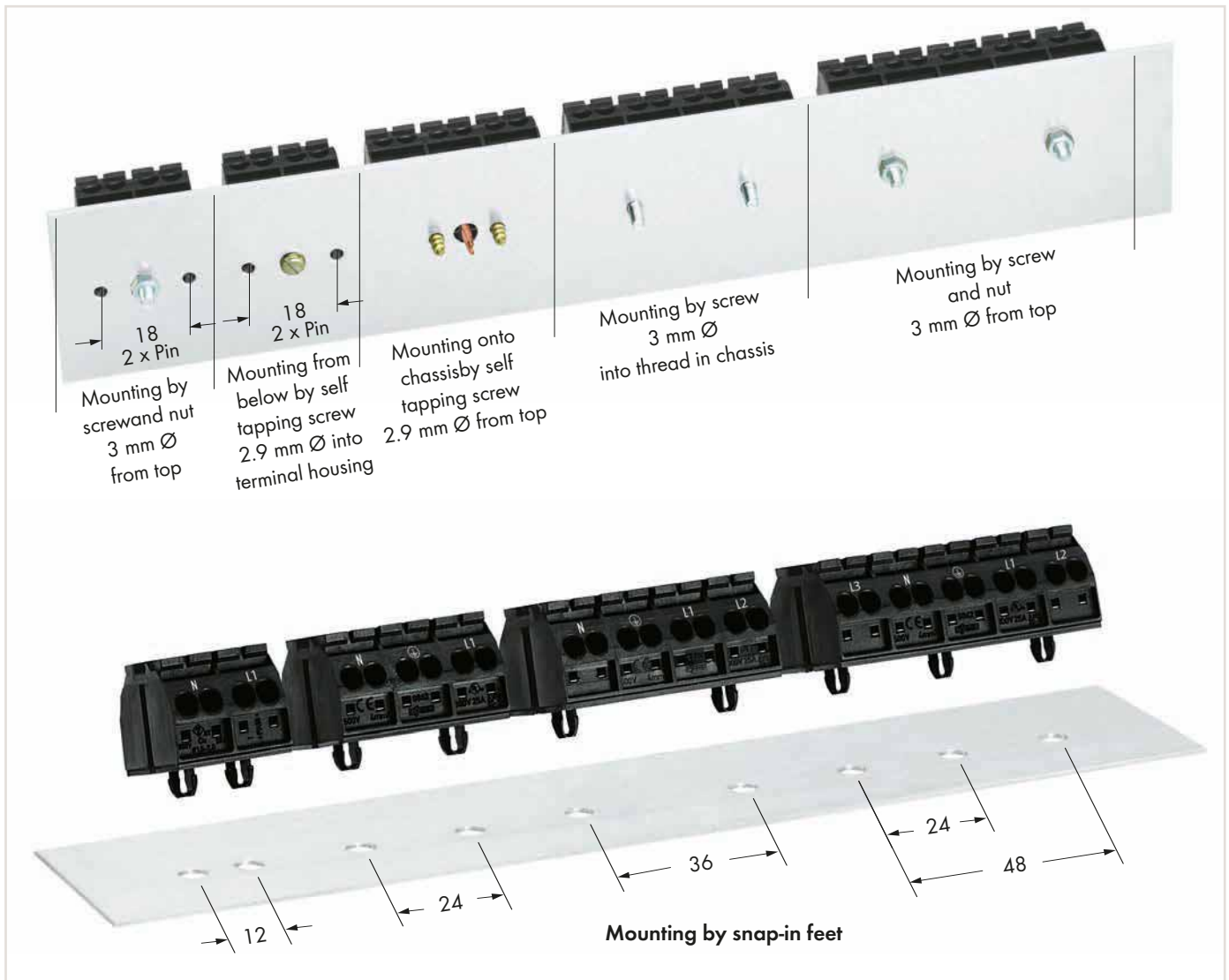

Dimensions in mm

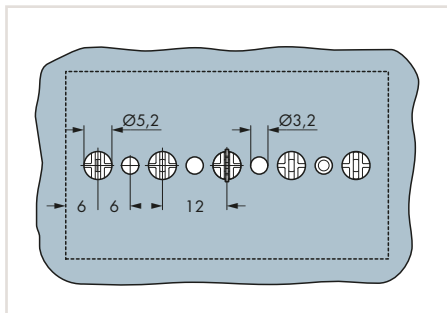

Dimensions (in mm) for ground contact and snap-in mounting foot (5.2 mm Ø)

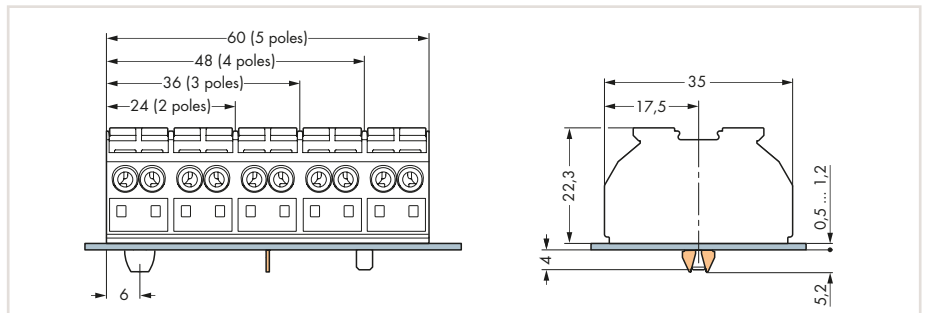

Dimensions (in mm) for chassis-mount terminal strips

## 4-Conductor Chassis-Mount Terminal Strips

### 4 mm<sup>2</sup>, 862 Series

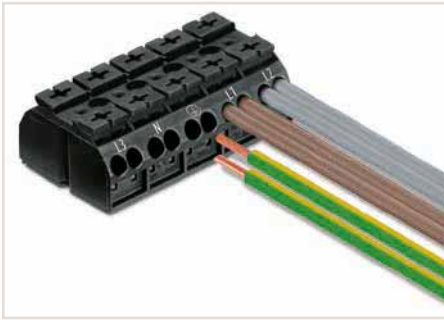

Terminating four conductors per pole – solid and fine-stranded.



Commoning using a comb-style jumper bar (862-482).

#### Technical Data

Rated voltage (III / 3)	500 V
Rated surge voltage (III / 3)	6 kV
Rated current	32 A
<b>Connection Data</b>	
Connection technology	
Solid conductor	0.5 ... 4 mm / 20 ... 12 AWG
Stranded conductor	0.5 ... 4 mm / 20 ... 12 AWG
Fine-stranded conductor	0.5 ... 4 mm / 20 ... 12 AWG
Solid conductor, push-in termination	0.5 ... 4 mm / 20 ... 12 AWG
Fine-stranded conductors with ferrule, push-in termination, min.	0.5 mm <sup>2</sup> / 20 AWG
Fine-stranded conductor with insulated ferrule	0.5 ... 4 mm / 20 ... 12 AWG
Nominal cross-section	4 mm <sup>2</sup> (12 AWG)
Strip length	10 ... 11 mm / 0.39 ... 0.43 inch
Approval	300 V, 20 A  300 V, 20 A
Pin spacing	5 mm / 0.197 inch

Rail-mount terminal blocks with an Ex mark are suitable for Ex e II applications. 440 V, 28 A

#### Cost-effective features:

WAGO's 862 Series Chassis-Mount Terminal Strips were developed specifically to minimize wiring costs, while accommodating requirements for flexible mounting, multiple connection points and easy handling:

- Equipped with Push-in CAGE CLAMP®, the 862 Series connects up to four conductors sized 0.5 ... 4 mm<sup>2</sup> (20 ... 12 AWG). Due to multiple connection points per pole, different conductor sizes can be used within the same terminal block position.
- For factory wiring, Push-in CAGE CLAMP® Connection Technology allows solid conductors, fine-stranded conductors with ferrules or ultrasonically bonded conductors from 0.5 ... 4 mm<sup>2</sup> (20 ... 12 AWG) to be terminated by simply pushing them into unit (length of bonded conductor end: min. 10 mm).
- Convenient automatic grounding contact optional
- Snap-in mounting feet for fast assembly
- Push-buttons for easy installation with an operating tool or by hand
- Built-in test points simplify testing with 2 mm Ø test plug.
- Flexible marking options with standard marking (pre-marked), marking strip or custom marked for large orders

Accessories (jumpers, etc.), see page 634

Tools, see Section 13

Marking accessories, see Full Line Catalog, Volume 6

Information on hazardous locations, see Section 14

Approvals and corresponding ratings, visit [www.wago.com](http://www.wago.com)

#### Accessories (Selection)

	Item No.	Page
Comb-style jumper bar, simply push into the conductor entry, unit with 5 pcs per strip, I <sub>n</sub> 32 A	862-482	634
Ferrule, uninsulated, electro-tin-plated, electrolytic copper, gastight crimped, per DIN 46288, Part 1/08.92	216-141	635
Ferrule, insulated, electro-tin-plated, electrolytic copper, gastight crimped, per DIN 46288, Part 4/09.09	216-241	635

## 4-Conductor Chassis-Mount Terminal Strips

### 4 mm<sup>2</sup>, 862 Series



4-conductor chassis-mount terminal strip, for mounting via screw and nut (3 mm Ø) or for self-tapping screw (2.9 mm Ø) from top, with 2 x pin, 2-pole, black

	Item No.	Pack. Unit
● N-L1	862-2552	500
● L1-N	862-1552	500
● L1-N ⊕	862-1552/999-950	500
● without marking	862-552	500

4-conductor chassis-mount terminal strip, for mounting via screw and nut (3 mm Ø) or for self-tapping screw (2.9 mm Ø) from top, with 2 x pin, 2-pole, white

	Item No.	Pack. Unit
○ N-L1	862-2652	500
○ L1-N	862-1652	500
○ L1-N ⊕	862-1652/999-950	500
○ without marking	862-652	500

4-conductor chassis-mount terminal strip, for self-tapping screw (2.9 mm Ø) from below, with 2 x pin, 2-pole, black

	Item No.	Pack. Unit
● N-L1	862-2562	500
● L1-N	862-1562	500
● L1-N ⊕	862-1562/999-950	500
● without marking	862-562	500

4-conductor chassis-mount terminal strip, for self-tapping screw (2.9 mm Ø) from below, with 2 x pin, 2-pole, white

	Item No.	Pack. Unit
○ N-L1	862-2662	500
○ L1-N	862-1662	500
○ L1-N ⊕	862-1662/999-950	500
○ without marking	862-662	500

4-conductor chassis-mount terminal strip, one snap-in foot per pole, 2-pole, black

	Item No.	Pack. Unit
● N-L1	862-2532	500
● L1-N	862-1532	500
● L1-N ⊕	862-1532/999-950	500
● without marking	862-532	500

4-conductor chassis-mount terminal strip, one snap-in foot per pole, 2-pole, white

	Item No.	Pack. Unit
○ N-L1	862-2632	500
○ L1-N	862-1632	500
○ L1-N ⊕	862-1632/999-950	500
○ without marking	862-632	500



## 4-Conductor Chassis-Mount Terminal Strips

### 4 mm<sup>2</sup>, 862 Series



4-conductor chassis-mount terminal strip, for mounting via screw and nut (3 mm Ø) or for self-tapping screw (2.9 mm Ø) from top, with 2 x pin, 3-pole, black

	Item No.	Pack. Unit
● N-PE-L1, without ground contact	862-2503	250
● PE-N-L1, without ground contact	862-1503	250
● PE-N-L1, without ground contact ☺	862-1503/999-950	250
● plain, without ground contact	862-503	250
● N-PE-L1, without ground contact	862-8503	250
● PE-N-L1, without ground contact	862-9503	250

4-conductor chassis-mount terminal strip, for mounting via screw and nut (3 mm Ø) or for self-tapping screw (2.9 mm Ø) from top, with 2 x pin, 3-pole, white

	Item No.	Pack. Unit
○ N-PE-L1, without ground contact	862-2603	250
○ PE-N-L1, without ground contact	862-1603	250
○ PE-N-L1, without ground contact ☺	862-1603/999-950	250
○ plain, without ground contact	862-603	250
○ N-PE-L1, without ground contact	862-8603	250
○ PE-N-L1, without ground contact	862-9603	250

4-conductor chassis-mount terminal strip, for mounting via screw and nut (3 mm Ø) or for self-tapping screw (2.9 mm Ø) from top, with 2 x pin, 4-pole, black

	Item No.	Pack. Unit
● N-PE-L1-L2, without ground contact	862-2504	200
● PE-N-L1-L2, without ground contact	862-1504	200
● PE-N-L1-L2, without ground contact ☺	862-1504/999-950	200
● plain, without ground contact	862-504	200
● N-PE-L1-L2, without ground contact	862-8504	200
● PE-N-L1-L2, without ground contact	862-9504	200

4-conductor chassis-mount terminal strip, one snap-in foot per pole, 3-pole, black

	Item No.	Pack. Unit
● N-PE-L1, without ground contact	862-2533	250
● PE-N-L1, without ground contact	862-1533	250
● PE-N-L1, without ground contact ☺	862-1533/999-950	250
● plain, without ground contact	862-533	250
● N-PE-L1, without ground contact	862-8533	250
● PE-N-L1, without ground contact	862-9533	250

4-conductor chassis-mount terminal strip, one snap-in foot per pole, 3-pole, white

	Item No.	Pack. Unit
○ N-PE-L1, without ground contact	862-2633	250
○ PE-N-L1, without ground contact	862-1633	250
○ PE-N-L1, without ground contact ☺	862-1633/999-950	250
○ plain, without ground contact	862-633	250
○ N-PE-L1, without ground contact	862-8633	250
○ PE-N-L1, without ground contact	862-9633	250

4-conductor chassis-mount terminal strip, one snap-in foot per pole, 4-pole, black

	Item No.	Pack. Unit
● N-PE-L1-L2, without ground contact	862-2534	200
● PE-N-L1-L2, without ground contact	862-1534	200
● PE-N-L1-L2, without ground contact ☺	862-1534/999-950	200
● plain, without ground contact	862-534	200
● N-PE-L1-L2, without ground contact	862-8534	200
● PE-N-L1-L2, without ground contact	862-9534	200

4-conductor chassis-mount terminal strip, one snap-in foot per pole at pos. 1+3, 3-pole, black

	Item No.	Pack. Unit
● N-PE-L1, without ground contact	862-2593	250
● PE-N-L1, without ground contact	862-1593	250
● PE-N-L1, without ground contact ☺	862-1593/999-950	250
● plain, without ground contact	862-593	250
● N-PE-L1, without ground contact	862-8593	250
● PE-N-L1, without ground contact	862-9593	250

4-conductor chassis-mount terminal strip, one snap-in foot per pole at pos. 1+3, 3-pole, white

	Item No.	Pack. Unit
○ N-PE-L1, without ground contact	862-2693	250
○ PE-N-L1, without ground contact	862-1693	250
○ PE-N-L1, without ground contact ☺	862-1693/999-950	250
○ plain, without ground contact	862-693	250
○ N-PE-L1, without ground contact	862-8693	250
○ PE-N-L1, without ground contact	862-9693	250

4-conductor chassis-mount terminal strip, one snap-in foot per pole at pos. 1+4, 4-pole, black

	Item No.	Pack. Unit
● N-PE-L1-L2, without ground contact	862-2594	200
● PE-N-L1-L2, without ground contact	862-1594	200
● PE-N-L1-L2, without ground contact ☺	862-1594/999-950	200
● plain, without ground contact	862-594	200
● N-PE-L1-L2, without ground contact	862-8594	200
● PE-N-L1-L2, without ground contact	862-9594	200



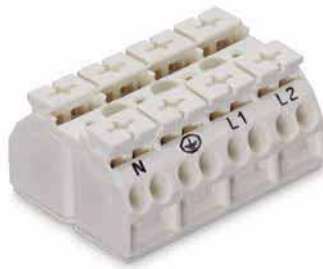

4-conductor chassis-mount terminal strip, for mounting via screw and nut (3 mm Ø) or for self-tapping screw (2.9 mm Ø) from top, with 2 x pin, 4-pole, white

	Item No.	Pack. Unit
<input type="radio"/> N-PE-L1-L2, without ground contact	862-2604	200
<input type="radio"/> PE-N-L1-L2, without ground contact	862-1604	200
<input type="radio"/> PE-N-L1-L2, without ground contact ☺	862-1604/999-950	200
<input type="radio"/> plain, without ground contact	862-604	200
<input type="radio"/> N-PE-L1-L2, without ground contact	862-8604	200
<input type="radio"/> PE-N-L1-L2, without ground contact	862-9604	200

4-conductor chassis-mount terminal strip, for mounting via screw and nut (3 mm Ø) or for self-tapping screw (2.9 mm Ø) from top, with 2 x pin, 5-pole, black

	Item No.	Pack. Unit
<input checked="" type="radio"/> L3-N-PE-L1-L2, without ground contact	862-2505	200
<input checked="" type="radio"/> PE-N-L1-L2-L3, without ground contact	862-1505	200
<input checked="" type="radio"/> PE-N-L1-L2-L3, without ground contact ☺	862-1505/999-950	200
<input checked="" type="radio"/> plain, without ground contact	862-505	200
<input checked="" type="radio"/> L3-N-PE-L1-L2, without ground contact	862-8505	200
<input checked="" type="radio"/> PE-N-L1-L2-L3, without ground contact	862-9505	200

4-conductor chassis-mount terminal strip, for mounting via screw and nut (3 mm Ø) or for self-tapping screw (2.9 mm Ø) from top, with 2 x pin, 5-pole, white

	Item No.	Pack. Unit
<input type="radio"/> L3-N-PE-L1-L2, without ground contact	862-2605	200
<input type="radio"/> PE-N-L1-L2-L3, without ground contact	862-1605	200
<input type="radio"/> PE-N-L1-L2-L3, without ground contact ☺	862-1605/999-950	200
<input type="radio"/> plain, without ground contact	862-605	200
<input type="radio"/> L3-N-PE-L1-L2, without ground contact	862-8605	200
<input type="radio"/> PE-N-L1-L2-L3, without ground contact	862-9605	200

4-conductor chassis-mount terminal strip, one snap-in foot per pole, 4-pole, white

	Item No.	Pack. Unit
<input type="radio"/> N-PE-L1-L2, without ground contact	862-2634	200
<input type="radio"/> PE-N-L1-L2, without ground contact	862-1634	200
<input type="radio"/> PE-N-L1-L2, without ground contact ☺	862-1634/999-950	200
<input type="radio"/> plain, without ground contact	862-634	200
<input type="radio"/> N-PE-L1-L2, without ground contact	862-8634	200
<input type="radio"/> PE-N-L1-L2, without ground contact	862-9634	200

4-conductor chassis-mount terminal strip, one snap-in foot per pole at pos. 2+4, 5-pole, black

	Item No.	Pack. Unit
<input checked="" type="radio"/> L3-N-PE-L1-L2, without ground contact	862-2525	200
<input checked="" type="radio"/> PE-N-L1-L2-L3, without ground contact	862-1525	200
<input checked="" type="radio"/> PE-N-L1-L2-L3, without ground contact ☺	862-1525/999-950	200
<input checked="" type="radio"/> plain, without ground contact	862-525	200
<input checked="" type="radio"/> L3-N-PE-L1-L2, without ground contact	862-8525	200
<input checked="" type="radio"/> PE-N-L1-L2-L3, without ground contact	862-9525	200

4-conductor chassis-mount terminal strip, one snap-in foot per pole at pos. 2+4, 5-pole, white

	Item No.	Pack. Unit
<input type="radio"/> L3-N-PE-L1-L2, without ground contact	862-2625	200
<input type="radio"/> PE-N-L1-L2-L3, without ground contact	862-1625	200
<input type="radio"/> PE-N-L1-L2-L3, without ground contact ☺	862-1625/999-950	200
<input type="radio"/> plain, without ground contact	862-625	200
<input type="radio"/> L3-N-PE-L1-L2, without ground contact	862-8625	200
<input type="radio"/> PE-N-L1-L2-L3, without ground contact	862-9625	200

4-conductor chassis-mount terminal strip, one snap-in foot per pole at pos. 1+4, 4-pole, white

	Item No.	Pack. Unit
<input type="radio"/> N-PE-L1-L2, without ground contact	862-2694	200
<input type="radio"/> PE-N-L1-L2, without ground contact	862-1694	200
<input type="radio"/> PE-N-L1-L2, without ground contact ☺	862-1694/999-950	200
<input type="radio"/> plain, without ground contact	862-694	200
<input type="radio"/> N-PE-L1-L2, without ground contact	862-8694	200
<input type="radio"/> PE-N-L1-L2, without ground contact	862-9694	200

4-conductor chassis-mount terminal strip, one snap-in foot per pole at pos. 1+3+5, 5-pole, black

	Item No.	Pack. Unit
<input checked="" type="radio"/> L3-N-PE-L1-L2, without ground contact	862-2515	200
<input checked="" type="radio"/> PE-N-L1-L2-L3, without ground contact	862-1515	200
<input checked="" type="radio"/> PE-N-L1-L2-L3, without ground contact ☺	862-1515/999-950	200
<input checked="" type="radio"/> plain, without ground contact	862-515	200
<input checked="" type="radio"/> L3-N-PE-L1-L2, without ground contact	862-8515	200
<input checked="" type="radio"/> PE-N-L1-L2-L3, without ground contact	862-9515	200

4-conductor chassis-mount terminal strip, one snap-in foot per pole at pos. 1+3+5, 5-pole, white

	Item No.	Pack. Unit
<input type="radio"/> L3-N-PE-L1-L2, without ground contact	862-2615	200
<input type="radio"/> PE-N-L1-L2-L3, without ground contact	862-1615	200
<input type="radio"/> PE-N-L1-L2-L3, without ground contact ☺	862-1615/999-950	200
<input type="radio"/> plain, without ground contact	862-615	200
<input type="radio"/> L3-N-PE-L1-L2, without ground contact	862-8615	200
<input type="radio"/> PE-N-L1-L2-L3, without ground contact	862-9615	200

## Accessories for 4-Conductor Chassis-Mount Terminal Strips



Comb-style jumper bar, simply push into the conductor entry, unit with 5 pcs per strip, I<sub>n</sub> 32 A

Color	Item No.	Pack. Unit
black	862-482	5

## Insulated and Uninsulated Ferrules per DIN 46228, Part 4/09.90



Ferrule, insulated, electro-tin-plated, electrolytic copper, gastight crimped, per DIN 46288, Part 4/09.09						
Conductor Size	Strip length	L	D	D 2	Item No.	Pack. Unit
0.5 mm <sup>2</sup> / 22 AWG	10 mm / 0.39 inch	10	2,1	1	216-141	5000 (1000)
0.75 mm <sup>2</sup> / 20 AWG	10 mm / 0.39 inch	10	2,3	1,2	216-142	5000 (1000)
1 mm <sup>2</sup> / 18 AWG	10 mm / 0.39 inch	10	2,5	1,4	216-143	5000 (1000)
1.5 mm <sup>2</sup> / 16 AWG	10 mm / 0.39 inch	10	2,8	1,7	216-144	5000 (1000)

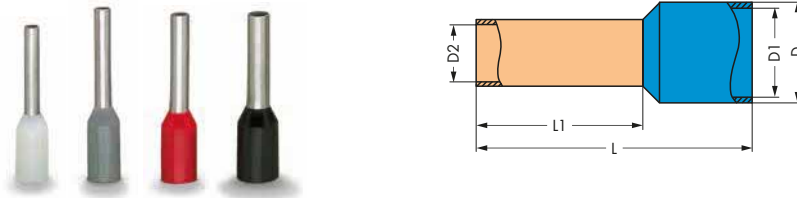

Ferrule, insulated, electro-tin-plated, electrolytic copper, gastight crimped, per DIN 46288, Part 4/09.09									
Conductor Size	Color	Strip length	L	L 1	D	D 1	D 2	Item No.	Pack. Unit
0.5 mm <sup>2</sup> / 22 AWG	○ white	12 mm / 0.47 inch	16	10	3,1	2,6	1	216-241	1000
0.75 mm <sup>2</sup> / 20 AWG	○ gray	12 mm / 0.47 inch	16	10	3,3	2,8	1,2	216-242	1000
1 mm <sup>2</sup> / 18 AWG	● red	12 mm / 0.47 inch	16	10	3,5	3	1,4	216-243	1000
1.5 mm <sup>2</sup> / 16 AWG	● black	12 mm / 0.47 inch	16	10	4	3,5	1,7	216-244	1000

## For Connecting Lighting and Equipment Worldwide

### Contact Technology

#### 294 Series

### Contact Technology

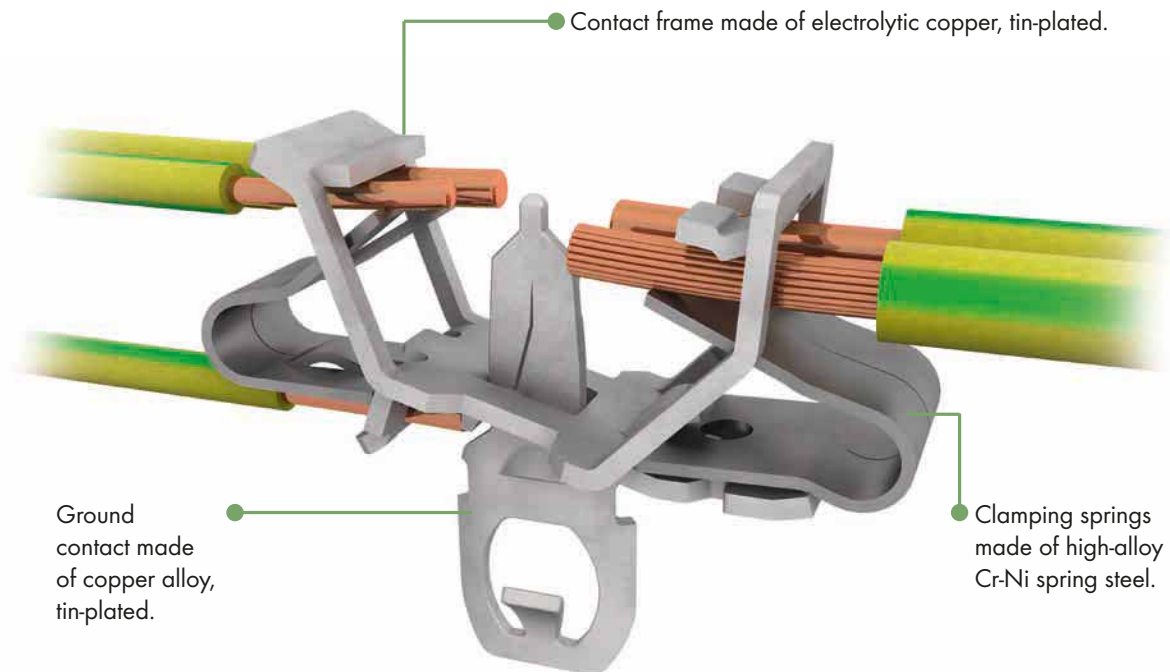

9

EUROPE
1 x 0.5 ... 2.5 mm <sup>2</sup> "s"
1 x 0.5 ... 1.5 mm <sup>2</sup> "s"
1 x 0.5 ... 0.75 mm <sup>2</sup> "s"
AMERICA
1 x AWG 18 ... 14 "s"
1 x AWG 18 ... 16 "s"
1 x AWG 18 "s"
JAPAN
1 x 0.8 ... 1.6 mm diam. "s"
1 x 0.8 ... 1 mm diam. "s"
1 x 0.8 mm diam. "s"

**Internal connection:**  
PUSH WIRE® for internal wiring with solid conductors

EUROPE
2 x 0.5 ... 2.5 mm <sup>2</sup> "s, str, f-str"
AMERICA
2 x AWG 18 ... 12 "s"
2 x AWG 18 ... 14 "s, f-str"
JAPAN
2 x 0.8 ... 2 mm diam. "s"
2 x 0.5 ... 2 mm <sup>2</sup> "str, f-str"

**External connection:**  
Push-in CAGE CLAMP® for field-wiring with all conductor types

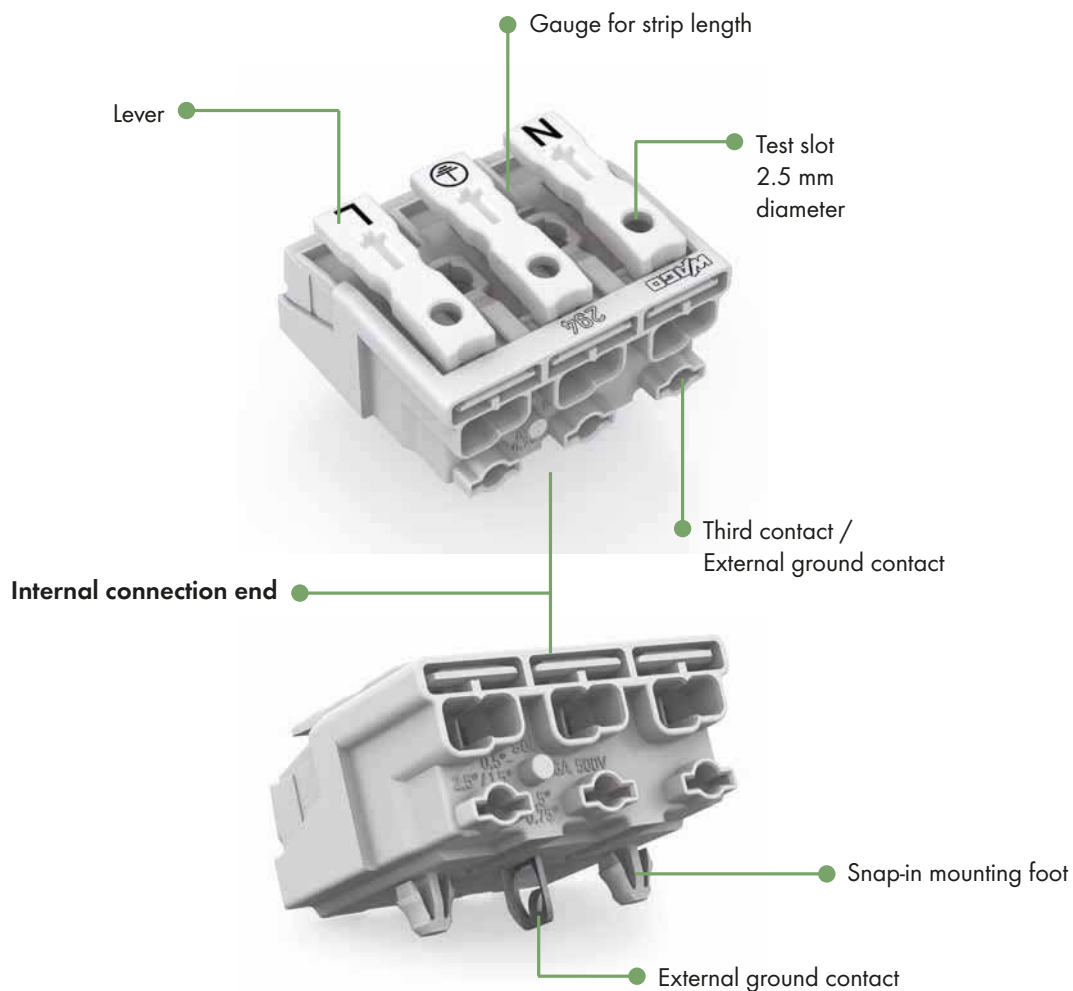

## Field-Wiring Terminal Blocks

### 2.5 mm<sup>2</sup>, 294 Series

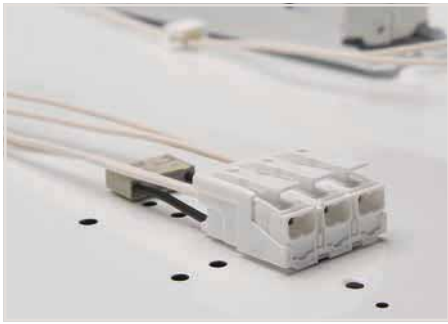

Terminating five conductors per pole – solid and fine-stranded.

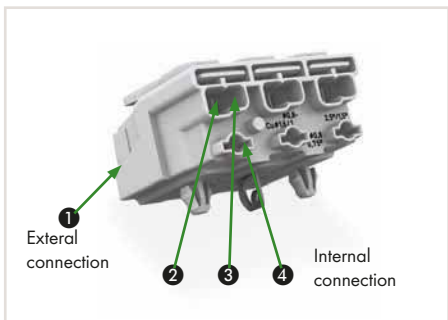

#### Technical Data

Ratings per	IEC/EN 60998-1
Ratings, note	Connection points
Rated voltage (II / 2)	500 V
Rated surge voltage (II / 2)	4 kV
Ratings per 2	IEC/EN 60998-2-2
Rated voltage (II / 2) (2)	500 V
Rated surge voltage (II / 2) (2)	4 kV
Rated current	24 A
Rated current (2)	24 A

#### Connection Data

Connection technology	Push-in CAGE CLAMP®
Solid conductor	0.5 ... 2.5 mm / 18 ... 12 AWG
Stranded conductor	0.5 ... 2.5 mm / 18 ... 14 AWG
Fine-stranded conductor	0.5 ... 2.5 mm / 18 ... 14 AWG
Solid conductor, push-in termination	0.5 ... 2.5 mm / 18 ... 12 AWG
Fine-stranded conductors with ferrule, push-in termination, min.	0.5 mm <sup>2</sup> / 18 AWG
Fine-stranded conductor with insulated ferrule	0.5 ... 1.5 mm / 18 ... 16 AWG
Fine-stranded conductor with uninsulated ferrule	0.5 ... 1.5 mm / 18 ... 16 AWG

#### Connection Data (2)

Connection technology (2)	PUSH WIRE®
Solid conductor (2)	0.5 ... 2.5 mm / 18 ... 14 AWG
Fine-stranded conductor with insulated ferrule (2)	0.5 ... 1 mm / 18 ... 16 AWG
Fine-stranded conductor with uninsulated ferrule (3)	0.5 ... 1.5 mm / 18 ... 14 AWG

#### Connection Data (3)

Solid conductor (3)	0.5 ... 1.5 mm / 18 ... 16 AWG
Fine-stranded conductor with insulated ferrule (3)	0.5 ... 0.75 mm <sup>2</sup> / 18 AWG
Fine-stranded conductor with uninsulated ferrule (3)	0.5 ... 1 mm / 18 AWG

#### Connection Data (4)

Solid conductor (4)	0.5 ... 0.75 mm <sup>2</sup> / 18 AWG
Strip length	8 ... 9 mm / 0.31 ... 0.35 inch
Material group	IIIa
Insulation material	Polycarbonate (PC)
Temperature stability	Relative Temperature Index (RTI): 120 °C
Flammability class per UL 94	V0
Clamping spring material	Chrome-nickel spring steel (CrNi)
Contact material	Electrolytic copper (Ecu)
Contact plating	Tin-plated

- External connection of solid, stranded and fine-stranded conductors
- Universal conductor termination (AWG, metric)
- Third contact located at the bottom of internal connector end
- Strain relief plate can be retrofitted

Accessories,  
see page 645

Tools,  
see Section 13

Approvals and corresponding ratings,  
visit [www.wago.com](http://www.wago.com)

#### Accessories (Selection)

	Item No.	Page
Assembly tool, presses snap-in mounting feet into the mounting plate and fits ground contacts safely and easily	294-199	645
Disconnection tool, removes conductors from PUSH WIRE® connections	206-294	645
Strain relief plate, with locking clip, 3- to 5-pole, for multicore cable: 1 x 5.2 ... 12 mm outer diameter	294-364	645





Dimensions in mm

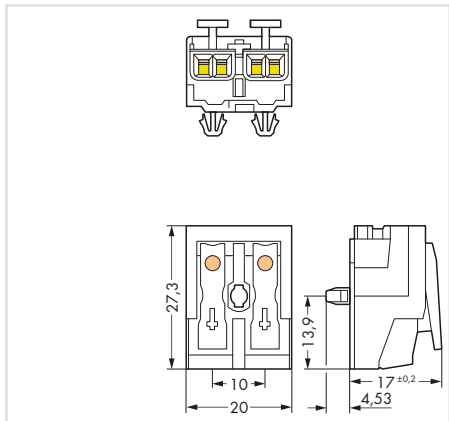

Field-wiring terminal block, without ground contact, with snap-in mounting feet, 2-pole, white

Marking	Item No.	Pack. Unit
○ N-L	294-5012	1000
○ N'-L'	294-5022	1000
○ DA- DA+	294-5032	1000
○ - +	294-5072	1000
○ 2-1	294-5042	1000
○ 1-N	294-5052	1000
○ without marking	294-5002	1000

Dimensions in mm

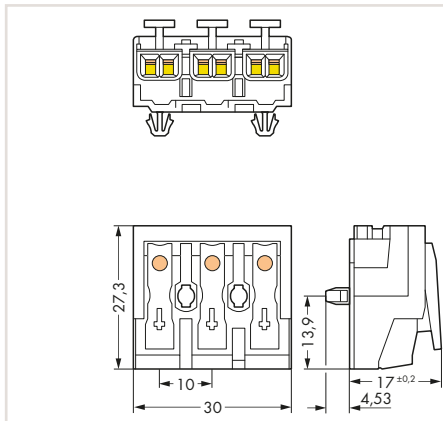

Field-wiring terminal block, without ground contact, with snap-in mounting feet, 3-pole, white

Marking	Item No.	Pack. Unit
○ N-PE-L	294-5013	500
○ N'-PE-L'	294-5023	500
○ 1-PE-N	294-5053	500
○ 3-2-1	294-5043	500
○ without marking	294-5003	500

Dimensions in mm

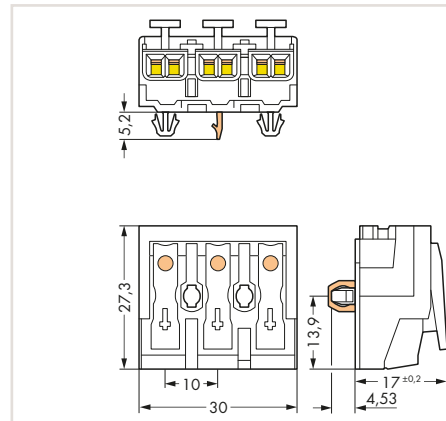

Field-wiring terminal block, with direct ground contact, with snap-in mounting feet, 3-pole, white

Marking	Item No.	Pack. Unit
○ N-PE-L	294-5113	500
○ N'-PE-L'	294-5123	500
○ 1-PE-N	294-5153	500

Field-wiring terminal block, without ground contact, without snap-in mounting feet, 2-pole, white

Marking	Item No.	Pack. Unit
○ N-L	294-4012	1000
○ N'-L'	294-4022	1000
○ DA- DA+	294-4032	1000
○ - +	294-4072	1000
○ 2-1	294-4042	1000
○ 1-N	294-4052	1000
○ without marking	294-4002	1000

Field-wiring terminal block, without ground contact, without snap-in mounting feet, 3-pole, white

Marking	Item No.	Pack. Unit
○ N-PE-L	294-4013	500
○ N'-PE-L'	294-4023	500
○ 1-PE-N	294-4053	500
○ 3-2-1	294-4043	500
○ without marking	294-4003	500

# Field-Wiring Terminal Blocks

## 2.5 mm<sup>2</sup>, 294 Series



Dimensions in mm

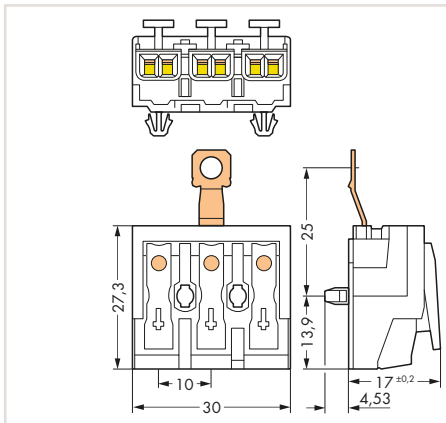

Field-wiring terminal block, with screw-type ground contact, with snap-in mounting feet, 3-pole, white

Marking	Item No.	Pack. Unit
○ N-PE-L	294-5413	500
○ N'-PE-L'	294-5423	500
○ 1-PE-N	294-5453	500

Dimensions in mm

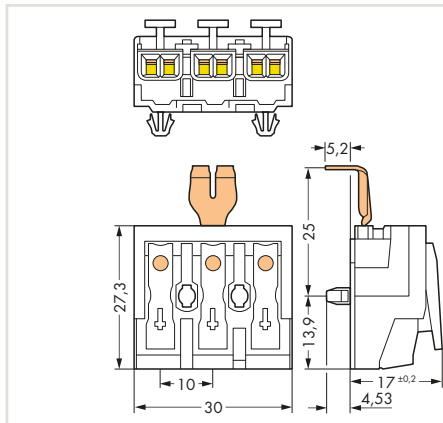

Field-wiring terminal block, with ground contact, with snap-in mounting feet, 3-pole, white

Marking	Item No.	Pack. Unit
○ N-PE-L	294-5213	500
○ N'-PE-L'	294-5223	500
○ 1-PE-N	294-5253	500

Dimensions in mm

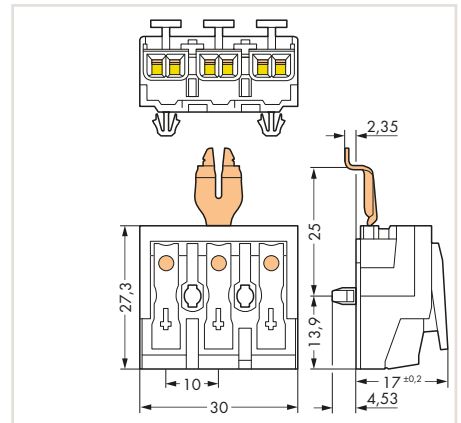

Field-wiring terminal block, with angled snap-in ground contact, with snap-in mounting feet, 3-pole, white

Marking	Item No.	Pack. Unit
○ N-PE-L	294-5313	500
○ N'-PE-L'	294-5323	500
○ 1-PE-N	294-5353	500

### 9

Field-wiring terminal block, with screw-type ground contact, without snap-in mounting feet, 3-pole, white

Marking	Item No.	Pack. Unit
○ N-PE-L	294-4413	500
○ N'-PE-L'	294-4423	500
○ 1-PE-N	294-4453	500

Field-wiring terminal block, with snap-in ground contact, without snap-in mounting feet, 3-pole, white

Marking	Item No.	Pack. Unit
○ N-PE-L	294-4213	500
○ N'-PE-L'	294-4223	500
○ 1-PE-N	294-4253	500

Field-wiring terminal block, with angled snap-in ground contact, without snap-in mounting feet, 3-pole, white

Marking	Item No.	Pack. Unit
○ N-PE-L	294-4313	500
○ N'-PE-L'	294-4323	500
○ 1-PE-N	294-4353	500

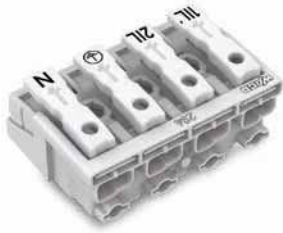

Dimensions in mm

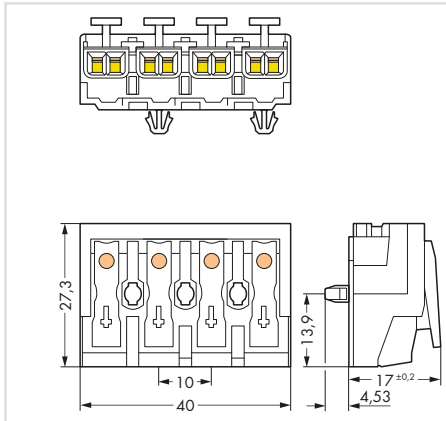

Field-wiring terminal block, without ground contact, with snap-in mounting feet, 4-pole, white

Marking	Item No.	Pack. Unit
○ 1/L'-2/L-PE-N	294-5024	500
○ 1-2-PE-N	294-5014	500
○ 4-3-2-1	294-5044	500
○ without marking	294-5004	500

Dimensions in mm

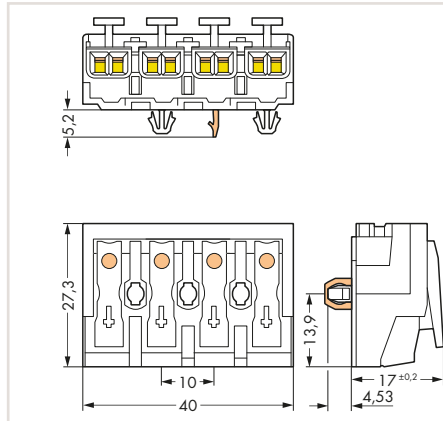

Field-wiring terminal block, with direct ground contact, with snap-in mounting feet, 4-pole, white

Marking	Item No.	Pack. Unit
○ 1/L'-2/L-PE-N	294-5124	500
○ 1-2-PE-N	294-5114	500

Dimensions in mm

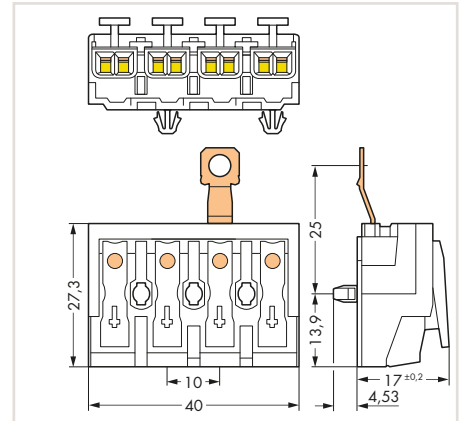

Field-wiring terminal block, with screw-type ground contact, with snap-in mounting feet, 4-pole, white

Marking	Item No.	Pack. Unit
○ 1/L'-2/L-PE-N	294-5424	500
○ 1-2-PE-N	294-5414	500

Field-wiring terminal block, without ground contact, without snap-in mounting feet, 4-pole, white

Marking	Item No.	Pack. Unit
○ 1/L'-2/L-PE-N	294-4024	500
○ 1-2-PE-N	294-4014	500
○ 4-3-2-1	294-4044	500
○ without marking	294-4004	500

Field-wiring terminal block, with screw-type ground contact, without snap-in mounting feet, 4-pole, white

Marking	Item No.	Pack. Unit
○ 1/L'-2/L-PE-N	294-4424	500
○ 1-2-PE-N	294-4414	500

# Field-Wiring Terminal Blocks

## 2.5 mm<sup>2</sup>, 294 Series

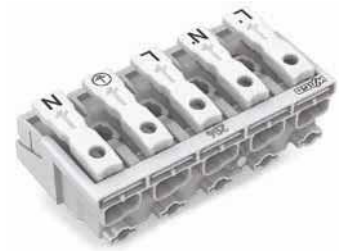

Dimensions in mm

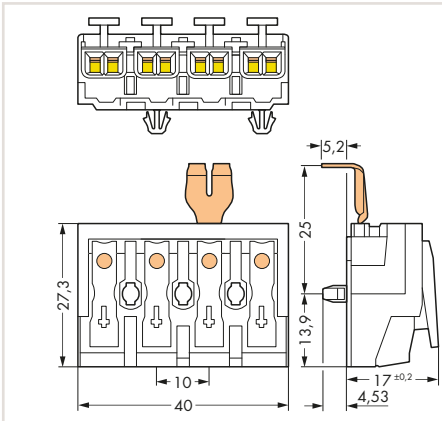

Field-wiring terminal block, with ground contact, with snap-in mounting feet, 4-pole, white

Marking	Item No.	Pack. Unit
○ 1/L'-2/L-PE-N	294-5224	500
○ 1-2-PE-N	294-5214	500

Dimensions in mm

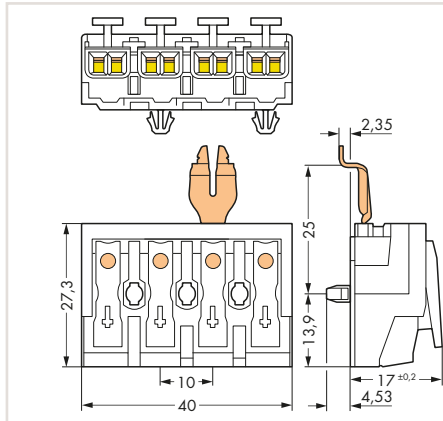

Field-wiring terminal block, with angled snap-in ground contact, with snap-in mounting feet, 4-pole, white

Marking	Item No.	Pack. Unit
○ 1/L'-2/L-PE-N	294-5324	500
○ 1-2-PE-N	294-5314	500

Dimensions in mm

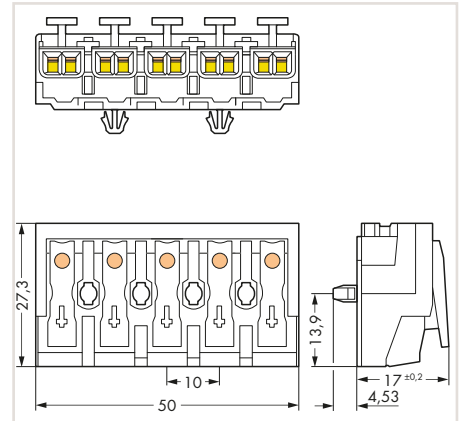

Field-wiring terminal block, without ground contact, with snap-in mounting feet, 5-pole, white

Marking	Item No.	Pack. Unit
○ L'-N'-L-PE-N	294-5025	250
○ L3-L2-L1-PE-N	294-5015	250
○ DA+ DA- L PE N	294-5035	250
○ DA- N PE L DA+	294-5075	250
○ 3-N-PE-1-2	294-5055	250
○ 5-4-3-2-1	294-5045	250
○ without marking	294-5005	250

9

Field-wiring terminal block, with snap-in ground contact, without snap-in mounting feet, 4-pole, white

Marking	Item No.	Pack. Unit
○ 1/L'-2/L-PE-N	294-4224	500
○ 1-2-PE-N	294-4214	500

Field-wiring terminal block, with angled snap-in ground contact, without snap-in mounting feet, 4-pole, white

Marking	Item No.	Pack. Unit
○ 1/L'-2/L-PE-N	294-4324	500
○ 1-2-PE-N	294-4314	500

Field-wiring terminal block, without ground contact, without snap-in mounting feet, 5-pole, white

Marking	Item No.	Pack. Unit
○ L'-N'-L-PE-N	294-4025	250
○ L3-L2-L1-PE-N	294-4015	250
○ DA+ DA- L PE N	294-4035	250
○ DA- N PE L DA+	294-4075	250
○ 3-N-PE-1-2	294-4055	250
○ 5-4-3-2-1	294-4045	250
○ without marking	294-4005	250



Dimensions in mm

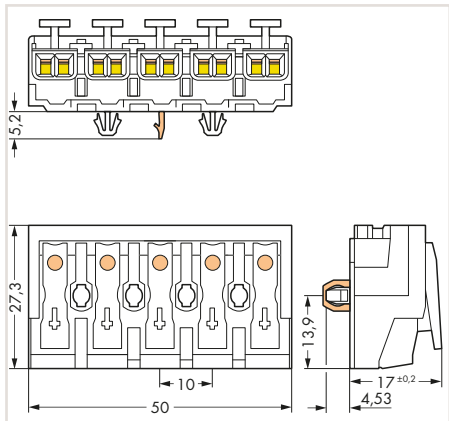

Field-wiring terminal block, with direct ground contact, with snap-in mounting feet, 5-pole, white

Marking	Item No.	Pack. Unit
○ DA- N PE L DA+	294-5175	250
○ 3-N-PE-1-2	294-5155	250

Dimensions in mm

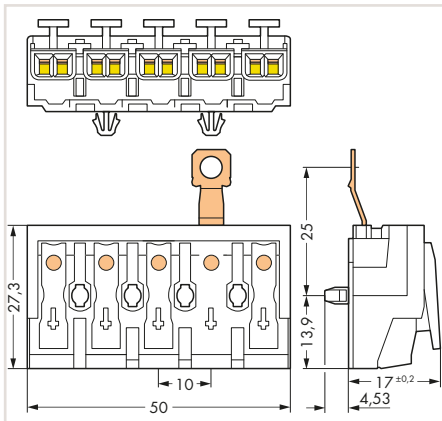

Field-wiring terminal block, with screw-type ground contact, with snap-in mounting feet, 5-pole, white

Marking	Item No.	Pack. Unit
○ L'-N'-L-PE-N	294-5425	250
○ L3-L2-L1-PE-N	294-5415	250
○ DA+ DA- L PE N	294-5435	250
○ DA- N PE L DA+	294-5475	250
○ 3-N-PE-1-2	294-5455	250

Dimensions in mm

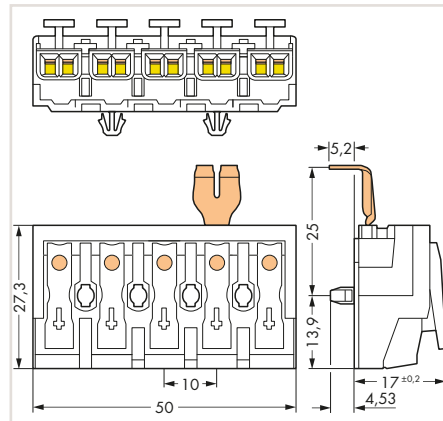

Field-wiring terminal block, with ground contact, with snap-in mounting feet, 5-pole, white

Marking	Item No.	Pack. Unit
○ L'-N'-L-PE-N	294-5225	250
○ L3-L2-L1-PE-N	294-5215	250
○ DA+ DA- L PE N	294-5235	250
○ DA- N PE L DA+	294-5275	250
○ 3-N-PE-1-2	294-5255	250

Field-wiring terminal block, with screw-type ground contact, without snap-in mounting feet, 5-pole, white

Marking	Item No.	Pack. Unit
○ L'-N'-L-PE-N	294-4425	250
○ L3-L2-L1-PE-N	294-4415	250
○ DA+ DA- L PE N	294-4435	250
○ DA- N PE L DA+	294-4475	250
○ 3-N-PE-1-2	294-4455	250

Field-wiring terminal block, with snap-in ground contact, without snap-in mounting feet, 5-pole, white

Marking	Item No.	Pack. Unit
○ L'-N'-L-PE-N	294-4225	250
○ L3-L2-L1-PE-N	294-4215	250
○ DA+ DA- L PE N	294-4235	250
○ DA- N PE L DA+	294-4275	250
○ 3-N-PE-1-2	294-4255	250

# Field-Wiring Terminal Blocks

## 2.5 mm<sup>2</sup>, 294 Series



Dimensions in mm

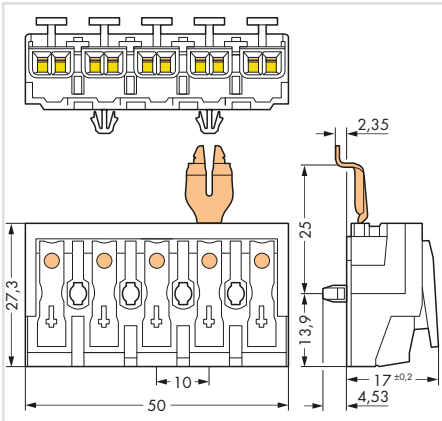

Field-wiring terminal block, with angled snap-in ground contact, with snap-in mounting feet, 5-pole, white

Marking	Item No.	Pack. Unit
○ L'-N'-L-PE-N	294-5325	250
○ L3-L2-L1-PE-N	294-5315	250
○ DA+ DA- L PE N	294-5335	250
○ DA- N PE L DA+	294-5375	250
○ 3-N-PE-1-2	294-5355	250

Dimensions in mm

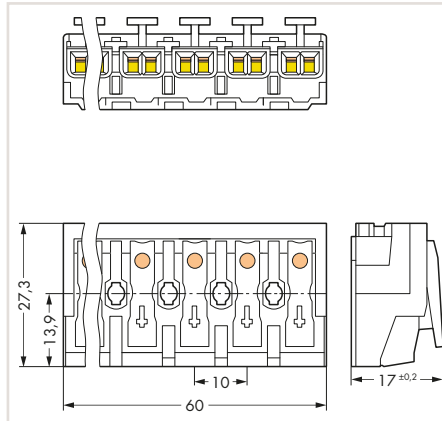

Field-wiring terminal block, without ground contact, without snap-in mounting feet, 6-pole, white

Marking	Item No.	Pack. Unit
○ without marking	294-4006	250

Dimensions in mm

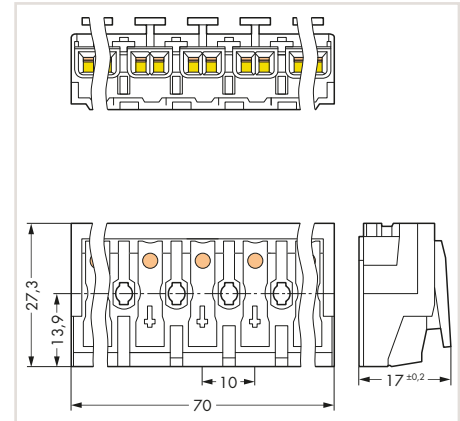

Field-wiring terminal block, without ground contact, without snap-in mounting feet, 7-pole, white

Marking	Item No.	Pack. Unit
○ without marking	294-4007	200

9

Field-wiring terminal block, with angled snap-in ground contact, without snap-in mounting feet, 5-pole, white

Marking	Item No.	Pack. Unit
○ L'-N'-L-PE-N	294-4325	250
○ L3-L2-L1-PE-N	294-4315	250
○ DA+ DA- L PE N	294-4335	250
○ DA- N PE L DA+	294-4375	250
○ 3-N-PE-1-2	294-4355	250



## Accessories for 294 Series Field-Wiring Terminal Blocks



Dimensions in mm

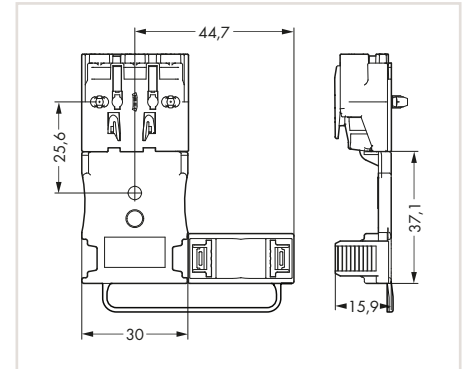

Assembly tool, presses snap-in mounting feet into the mounting plate and fits ground contacts safely and easily

	Item No.	Pack. Unit
	294-199	1

Disconnection tool, removes conductors from PUSH WIRE® connections

	Item No.	Pack. Unit
	206-294	1

Strain relief plate, with locking clip, 3- to 5-pole, for multicore cable: 1 x 5.2 ... 12 mm outer diameter

Color	Item No.	Pack. Unit
○ white	294-364	50

Strain relief plate, with locking clip, 3- to 5-pole, for single strands: min. 3 x 0.5 mm<sup>2</sup>, max. 5 x 2.5 mm<sup>2</sup> or 7 x 1.5 mm<sup>2</sup>

Color	Item No.	Pack. Unit
○ white	294-384	50



Conductor removal:  
Slide disconnection tool beneath the conductor and pull both conductor and tool out.

## Drilled-Hole Patterns for Snap-In Mounting Feet

### 294 Series

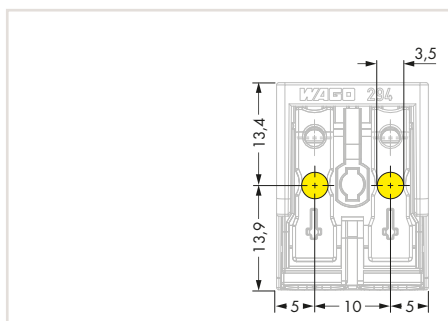

2-pole – without ground contact

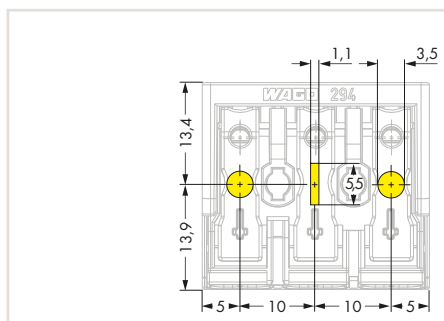

3-pole – with direct ground contact

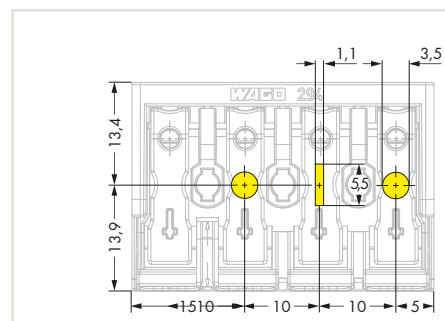

4-pole – with direct ground contact

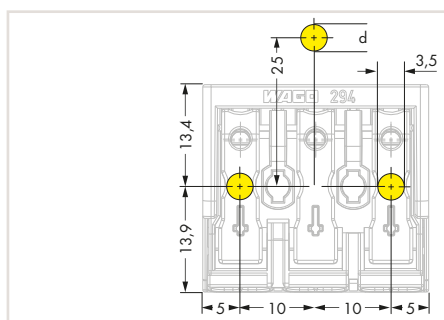

3-pole –  
with snap-in ground contact,  $d = 4.9 \text{ mm}$   
with screw-type ground contact,  $d \leq 4.1 \text{ mm}$

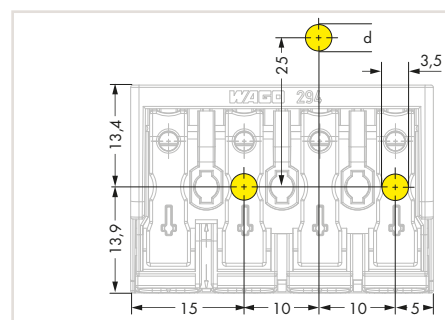

4-pole –  
with snap-in ground contact,  $d = 4.9 \text{ mm}$   
with screw-type ground contact,  $d \leq 4.1 \text{ mm}$

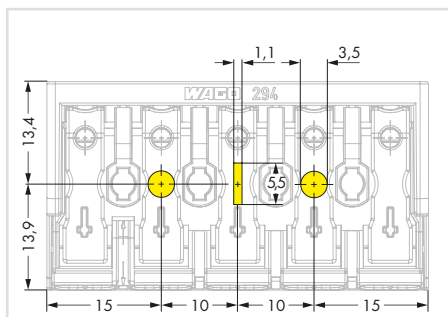

5-pole – with direct ground contact

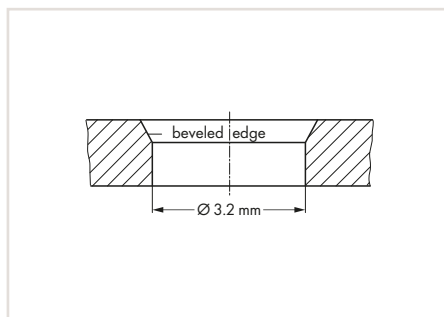

Drilled hole for snap-in mounting foot

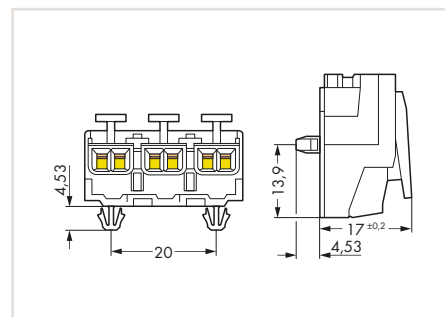

Snap-in mounting foot

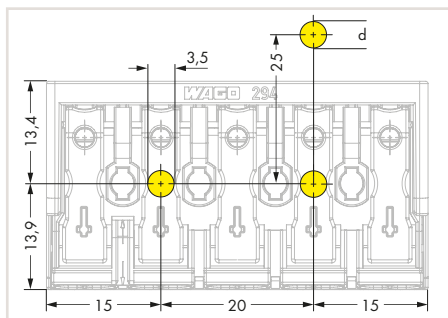

5-pole –  
with snap-in ground contact,  $d = 4.9 \text{ mm}$   
with screw-type ground contact,  $d \leq 4.1 \text{ mm}$

## Drilled-Hole Patterns for Screw Mounting 294 Series

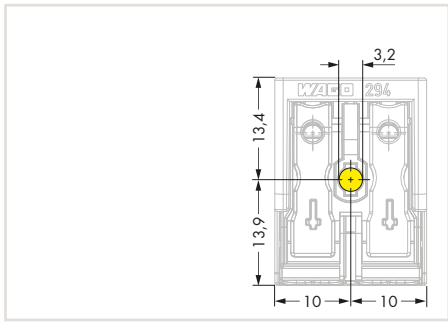

2-pole – without ground contact

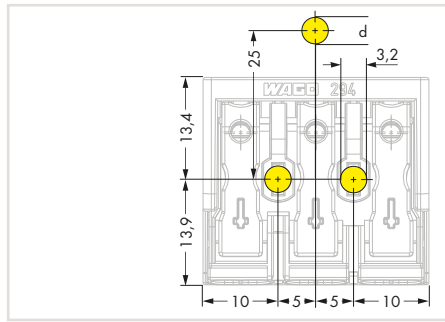

3-pole –  
with snap-in ground contact,  $d = 4.9 \text{ mm}$   
with screw-type ground contact,  $d \leq 4.1 \text{ mm}$

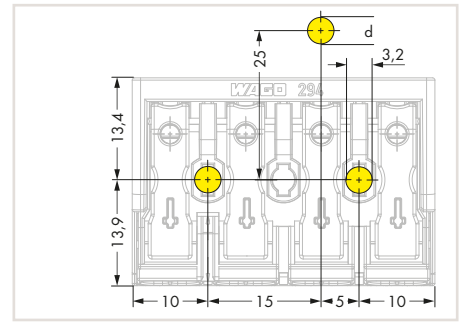

4-pole –  
with snap-in ground contact,  $d = 4.9 \text{ mm}$   
with screw-type ground contact,  $d \leq 4.1 \text{ mm}$

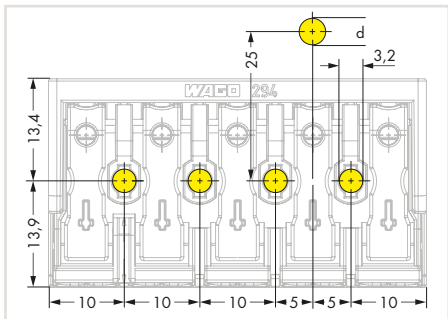

5-pole –  
with snap-in ground contact,  $d = 4.9 \text{ mm}$   
with screw-type ground contact,  $d \leq 4.1 \text{ mm}$

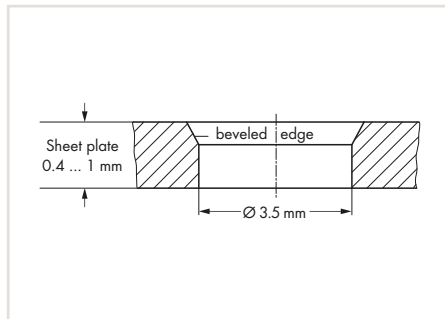

Hole for screw mount  
Notice:  
The maximum thread diameter for self-tapping screws is 3.0 mm.

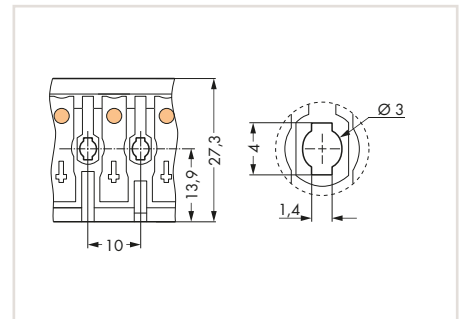

Mounting hole for screw  
Notice:  
The maximum thread diameter for self-tapping screws is 3.0 mm.

# Pluggable Connection System with Phase Selection for Fluorescent Lighting Fixtures

## Field-Wiring Terminal Blocks

### 2.5 mm<sup>2</sup>, 293 Series

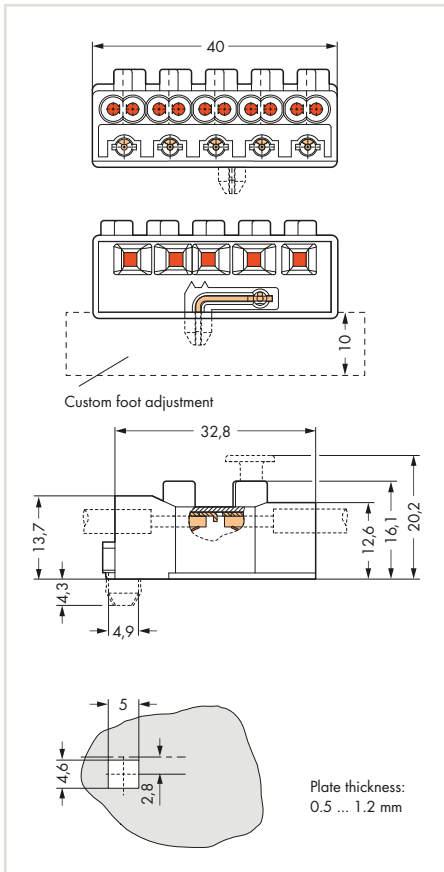

Dimensions in mm

Field-wiring terminal block with custom foot, with and without direct ground contact, white, with and without push-buttons on the field-wiring side

Metal plate cutout for direct ground contact must be free of varnish and oxide films. Equipped with varnished metal plates upon request.

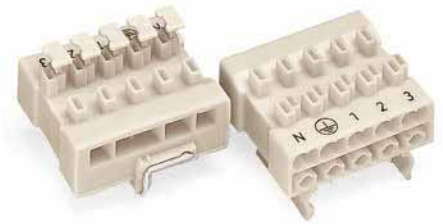

Dimensions in mm

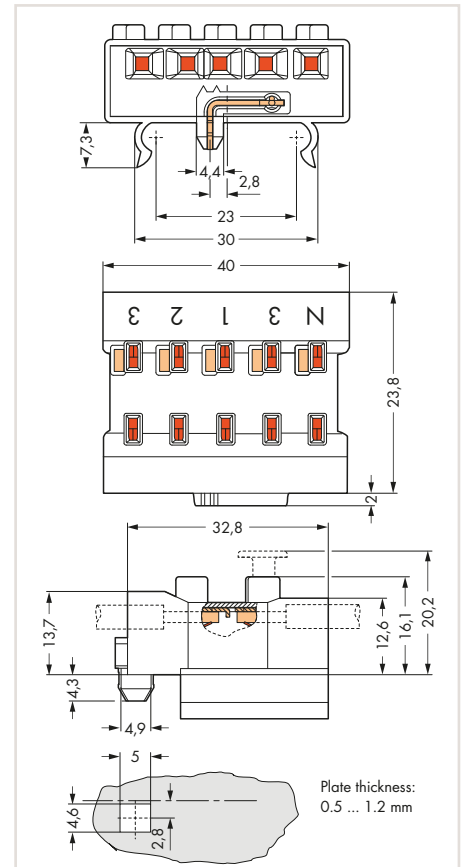

Field-wiring terminal block, with snap-in foot and direct ground contact, with push-buttons on the field-wiring side, white

Pole No.	Item No.	Pack. Unit
○ 5	293-325	250

Field-wiring terminal block, with snap-in foot and direct ground contact, without push-buttons, white

Pole No.	Item No.	Pack. Unit
○ 5	293-225	250

#### Technical Data

Rated voltage (II / 2)	500 V
Rated surge voltage (II / 2)	4 kV
Rated current	20 A

#### Connection Data

Connection technology	PUSH WIRE®
Solid conductor	0.5 ... 2.5 mm / 20 ... 14 AWG

#### Connection Data (2)

Solid conductor (2)	0.5 ... 0.75 mm / 20 ... 18 AWG
Solid conductor (3)	2.5 mm <sup>2</sup> / 12 AWG

Strip length	8 ... 9 mm / 0.31 ... 0.35 inch
--------------	---------------------------------

Approvals and corresponding ratings, visit [www.wago.com](http://www.wago.com)

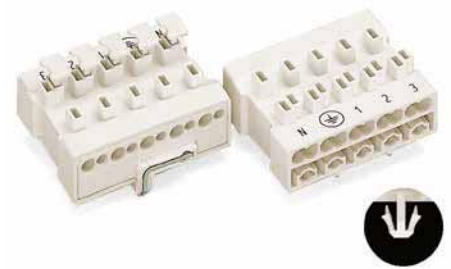
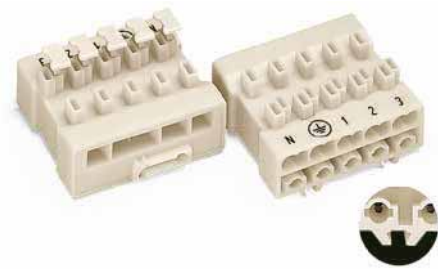

Dimensions in mm

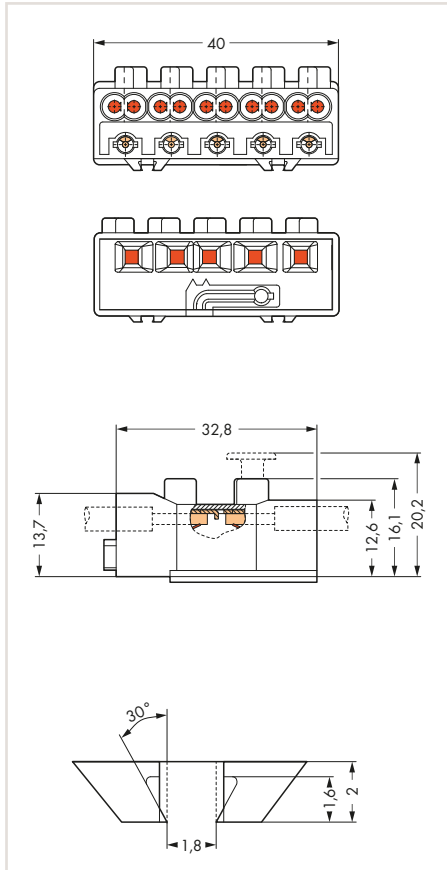

Field-wiring terminal block, with dovetail and without direct ground contact, with push-buttons on the field-wiring side, white

Pole No.	Item No.	Pack. Unit
○ 5	293-220	250

Field-wiring terminal block with dovetail and without direct ground contact, without push-buttons, white

Pole No.	Item No.	Pack. Unit
○ 5	293-219	250

Dimensions in mm

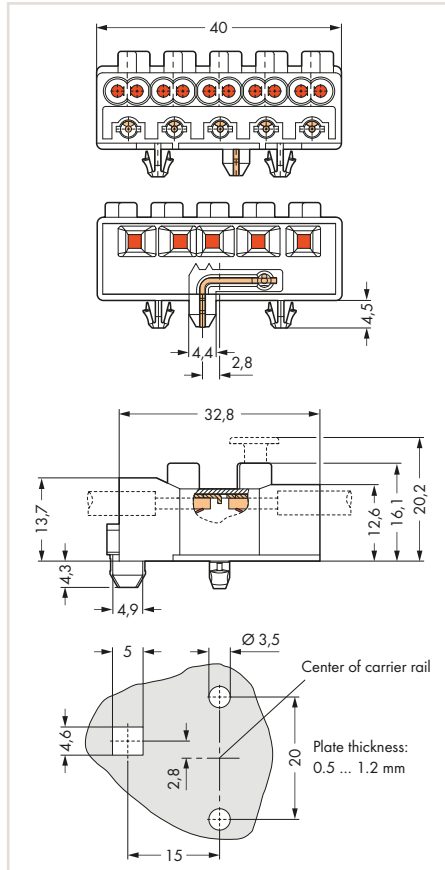

Field-wiring terminal block, with snap-in mounting feet and direct ground contact, with push-buttons on the field-wiring side, white

Pole No.	Item No.	Pack. Unit
○ 5	293-220	250

Field-wiring terminal block, with snap-in mounting feet and direct ground contact, without push-buttons, white

Pole No.	Item No.	Pack. Unit
○ 5	293-221	250

Dimensions in mm

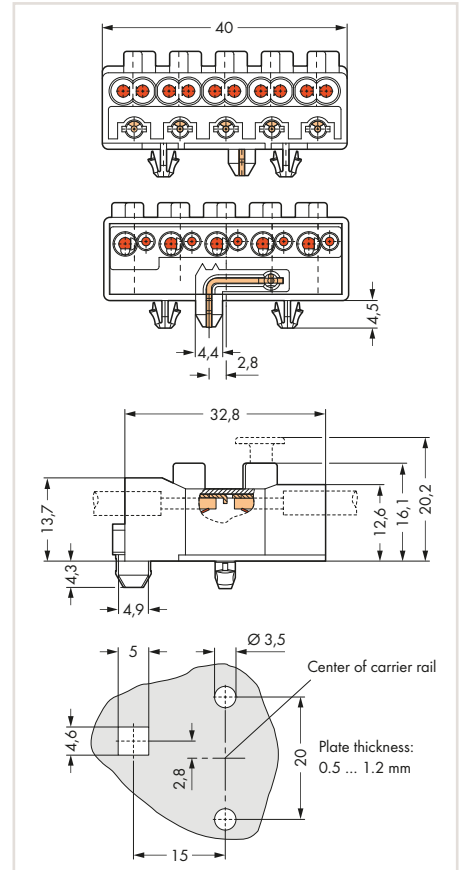

Field-wiring terminal block, with snap-in mounting feet and direct ground contact, with push-buttons on the field-wiring side, white

Pole No.	Item No.	Pack. Unit
○ 5	293-230	250

Field-wiring terminal block, with snap-in mounting feet and direct ground contact, without push-buttons, white

Pole No.	Item No.	Pack. Unit
○ 5	293-228	250

500 V

4 kV

20 A

PUSH WIRE®

0.5 ... 2.5 mm / 20 ... 14 AWG

0.5 ... 0.75 mm / 20 ... 18 AWG

2.5 mm<sup>2</sup> / 12 AWG

8 ... 9 mm / 0.31 ... 0.35 inch

500 V

4 kV

20 A

PUSH WIRE®

0.5 ... 2.5 mm / 20 ... 14 AWG

0.5 ... 0.75 mm / 20 ... 18 AWG

2.5 mm<sup>2</sup> / 12 AWG

8 ... 9 mm / 0.31 ... 0.35 inch

500 V

4 kV

20 A

PUSH WIRE®

0.5 ... 2.5 mm / 20 ... 14 AWG

0.5 ... 0.75 mm / 20 ... 18 AWG

2.5 mm<sup>2</sup> / 12 AWG

8 ... 9 mm / 0.31 ... 0.35 inch

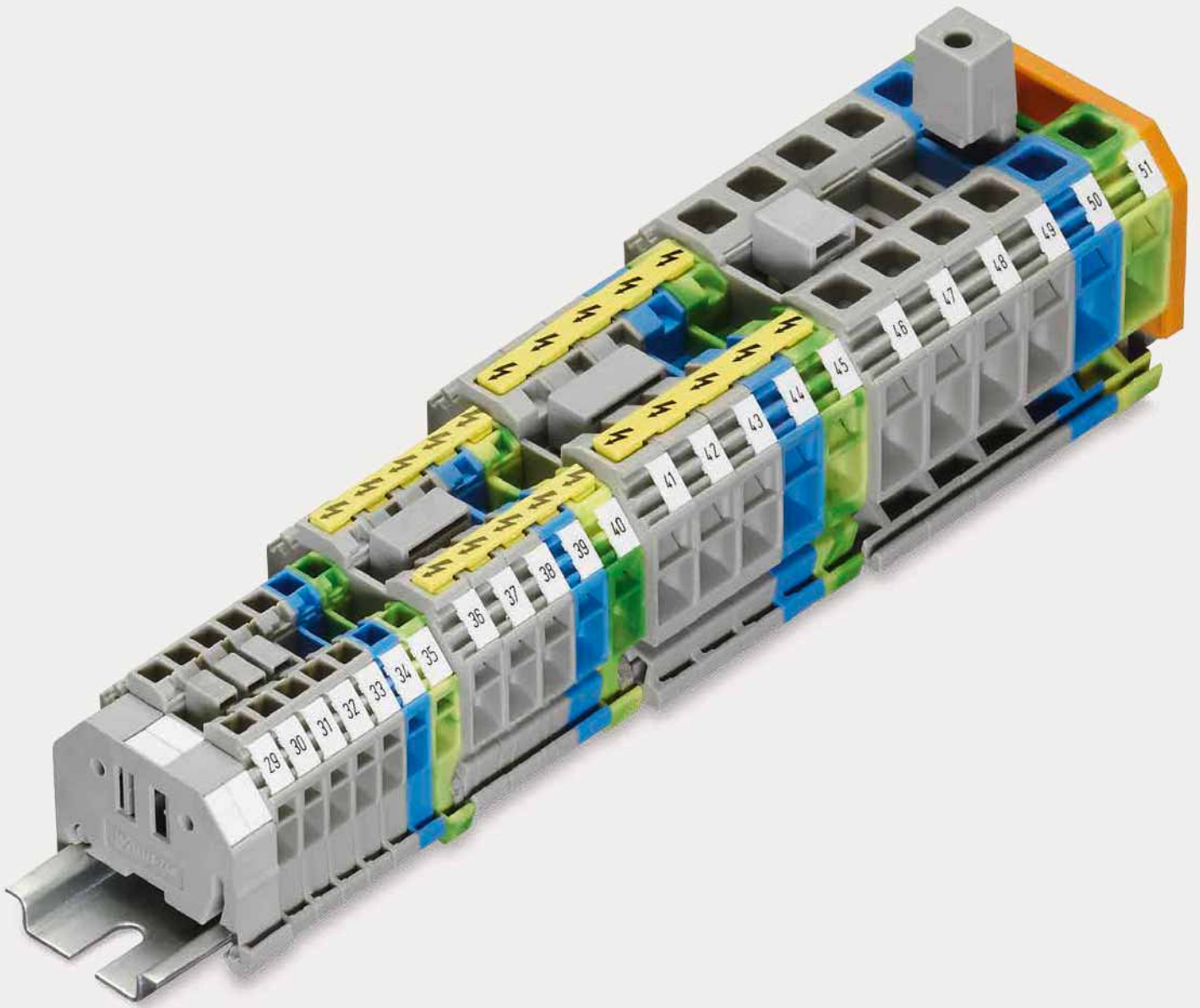





**Rail-Mount Terminal Blocks, Classic**



## Rail-Mount Terminal Blocks, Classic

### Side-Entry Wiring

			Page
	<b>Through and Ground Conductor Terminal Blocks</b> 0.08 ... 16 mm <sup>2</sup> (28 ... 6 AWG)	279 ... 283 Series	654
	<b>Disconnect/Test Terminal Blocks, Ground Conductor Disconnect Terminal Blocks</b> 0.2 ... 6 mm <sup>2</sup> (24 ... 10 AWG)	282 Series	662
	<b>Fuse Terminal Blocks</b> 0.2 ... 6 mm <sup>2</sup> (24 ... 10 AWG)	282 Series	666
	<b>Accessories for Rail-Mount Terminal Blocks</b>		670

## Side-Entry Rail-Mount Terminal Blocks, 279 ... 284 Series Description and Installation

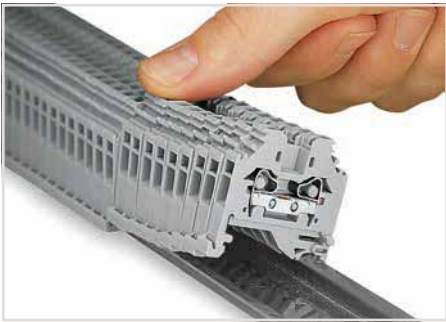

Snapping side-entry rail-mount terminal blocks onto the carrier rail.

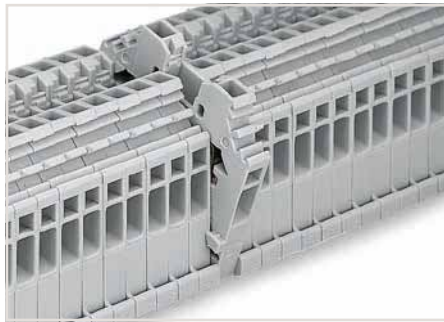

Quick assembly keys prevent reverse mounting.

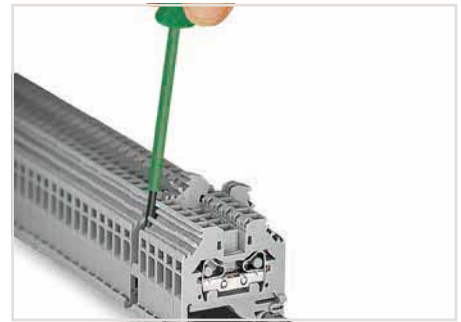

Removing a terminal block from the assembly.



**CAGE CLAMP® connection**  
Inserting a conductor via screwdriver.  
With ferruled conductors, it is necessary to use a terminal block one size larger than the conductor's nominal cross-section.



Testing with test plug adapter.

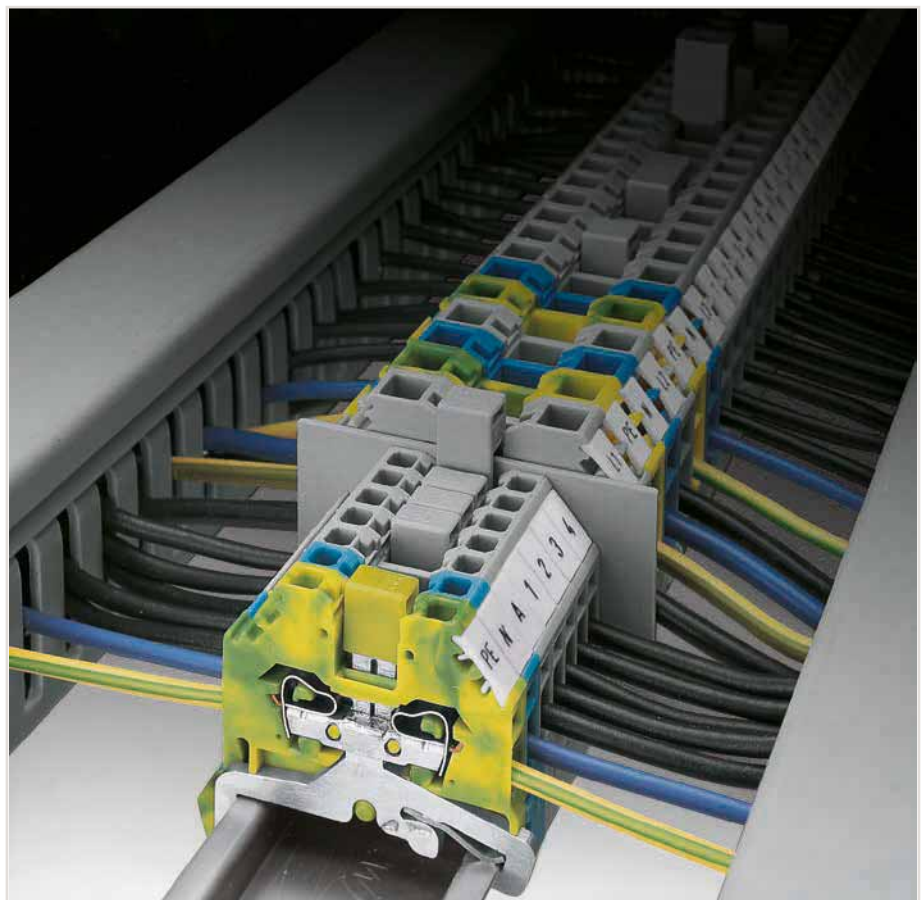

10



Commoning using an adjacent jumper (280-402). Push jumper down until fully inserted.



Commoning side-entry rail-mount terminal blocks via step-down jumpers.



Suitable for all DIN-35 rails

Carrier rail	Item No.	Curre[A]	Acc. to mm <sup>2</sup> /AWG Cu
DIN 35 x 7.5 (steel) slotted	210-112	76	16/6
DIN 35 x 7.5 (steel) unslotted	210-113	76	16/6
DIN 35 x 15 (steel) 1.5 mm thick	210-114	125	35/2
DIN 35 x 15 (steel) 2.3 mm thick	210-118	125	35/2
DIN 35 x 7.5 (Al) unslotted	210-196	76	16/6
DIN 35 x 15 (Cu) 2.3 mm thick	210-198	309	150/6/0

Current applies to rails of 1 m/3'3" length

When using standard carrier rails as ground conductor busbars, please refer to the maximum current capacities listed above. Steel carrier rails are not suited for PEN (ground and N-conductor) applications per EN 60947-7-2 (VDE 0611, Part 3).

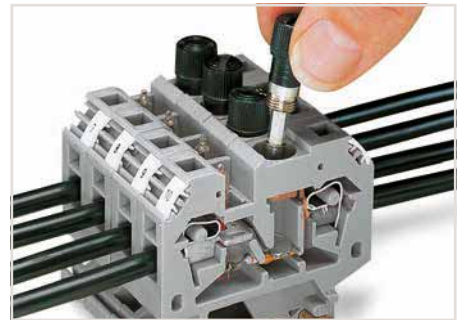

Replacing a fuse.

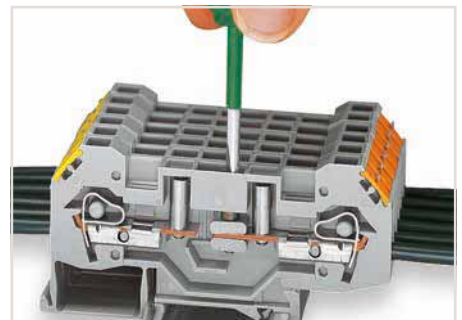
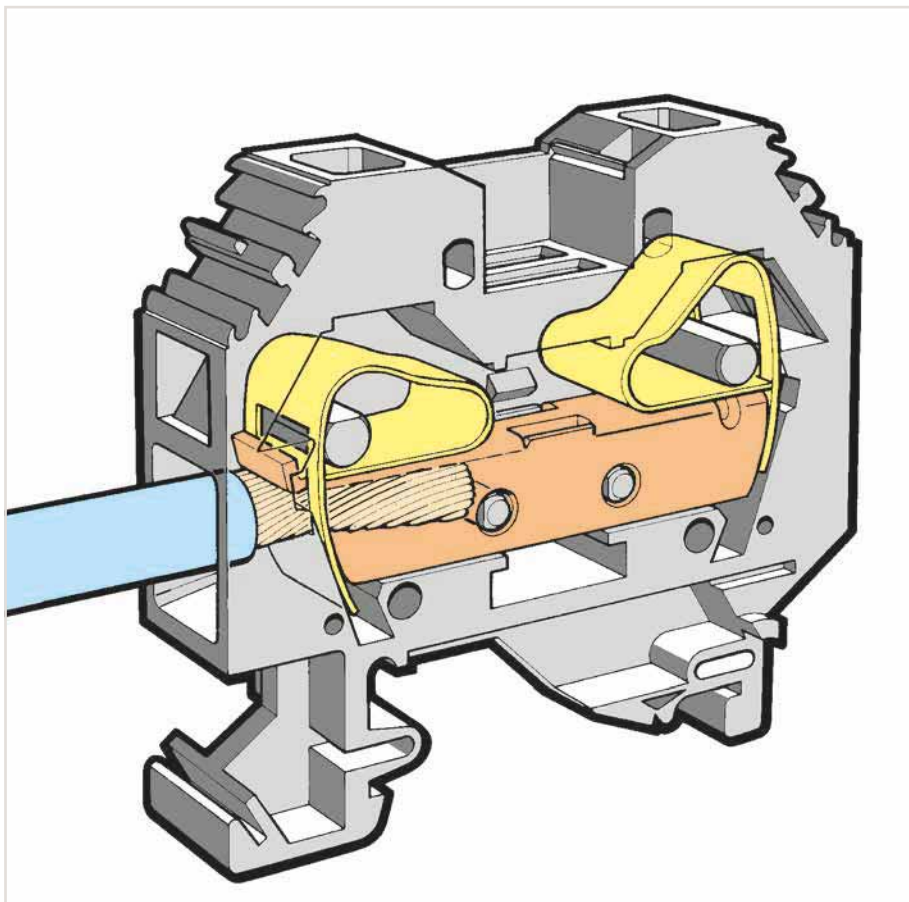

Shifting the disconnect slide link of a disconnect/test terminal block.



Labeling via WMB Multi Marking System.

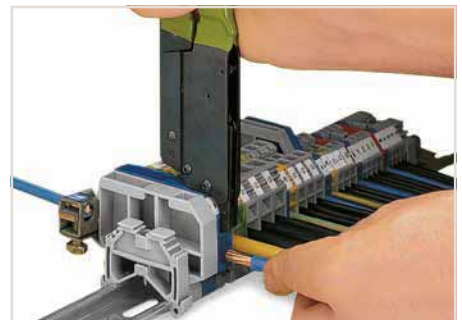

When operating the handles beyond the locked position, the ratchet allows the tool to open and be removed from the terminal block.

## Through and Ground Conductor Terminal Blocks

### 1.5 mm<sup>2</sup>, 279 Series and 2.5 mm<sup>2</sup>, 280 Series

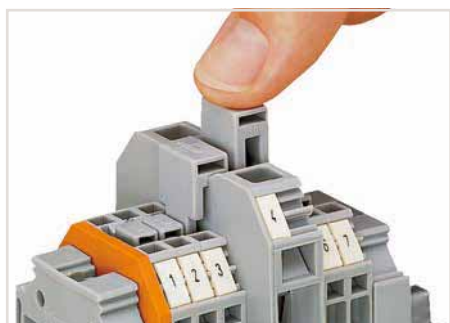

Commoning side-entry rail-mount terminal blocks via step-down jumpers.

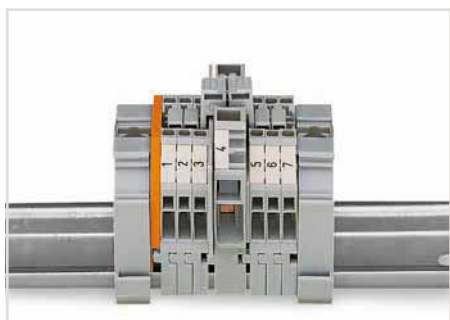

Commoning from 6 mm<sup>2</sup>/10 AWG (282 Series) to 1.5 mm<sup>2</sup>/16 AWG (279 Series) front-entry rail-mount terminal blocks.

Terminal blocks with a blue insulated housing are suitable for Ex i applications.





← 42,5 mm/1.67 in →

2-conductor through terminal block		
Color	Item No.	Pack. Unit
○ gray	279-101	100
● blue	279-104	100



#### Technical Data

Ratings per	IEC/EN 60947-7-1
Rated voltage (III / 3)	800 V
Rated surge voltage (III / 3)	8 kV
Rated current	18 A
Approval	600 V, 10 A  , 600 V, 15 A 
<b>Connection Data</b>	
Solid conductor	0.08 ... 1.5 mm / 28 ... 16 AWG
Fine-stranded conductor	0.08 ... 1.5 mm / 28 ... 16 AWG
Note (conductor cross section)	
Strip length	8 ... 9 mm / 0.31 ... 0.35 inch
Terminal block width	4 mm / 0.157 inch
Insulation material	Polyamide 66 (PA 66)

#### Accessories (Selection)

Adjacent jumper, insulated, I <sub>N</sub> 15 A
Adjacent jumper, insulated, I <sub>N</sub> = I <sub>N</sub> terminal block
End and intermediate plate, 2.5 mm thick
WMB Inline, plain, 2,000 WMB markers (4 mm) per reel, 4 ... 4.2 mm stretchable
WMB Inline, plain, 1,500 WMB markers (5 mm) per reel, 5 ... 5.2 mm stretchable
Test plug adapter, 5 mm wide, for 210-137 Test Plug (2.3 mm Ø), for 1.5 ... 4 mm <sup>2</sup> terminal blocks

	Item No.	Page
gray	279-402	670
orange	280-302	670
white	2009-114	780
gray	280-404	678

 Accessories for 279 Series, see page 670

 Accessories for 280 Series, see page 671

 Carrier rails and tools, see Section 13

 Appropriate marking system: WMB/WMB Inline, see Full Line Catalog, Volume 6

 Approvals and corresponding ratings, visit [www.wago.com](http://www.wago.com)



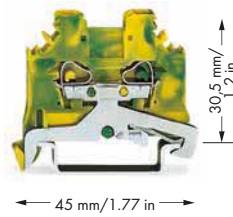
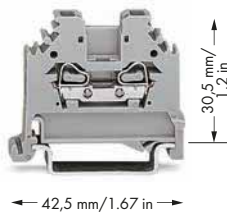

**2-conductor through terminal block**

Color	Item No.	Pack. Unit
○ gray	280-101	100
● blue	280-104	100



IEC/EN 60947-7-1  
 800 V  
 8 kV  
 24 A  
 600 V, 20 A ; 600 V, 20 A

0.08 ... 2.5 mm / 28 ... 12 AWG  
 0.08 ... 2.5 mm / 28 ... 12 AWG  
 12 AWG: THHN, THWN  
 8 ... 9 mm / 0.31 ... 0.35 inch  
 5 mm / 0.197 inch  
 Polyamide 66 (PA 66)

	Item No.	Page
gray	280-402	671
orange	280-302	671
white	2009-115	780
gray	280-404	678

**2-conductor ground terminal block**

Color	Item No.	Pack. Unit
● green-yellow	280-107	100



IEC/EN 60947-7-2

0.08 ... 2.5 mm / 28 ... 12 AWG  
 0.08 ... 2.5 mm / 28 ... 12 AWG  
 12 AWG: THHN, THWN  
 8 ... 9 mm / 0.31 ... 0.35 inch  
 5 mm / 0.197 inch  
 Polyamide 66 (PA 66)

	Item No.	Page
gray	280-402	671
orange	280-302	671
white	2009-115	780
gray	280-404	678

## Through and Ground Conductor Terminal Blocks

### 4 mm<sup>2</sup>, 281 Series and 6 mm<sup>2</sup>, 282 Series

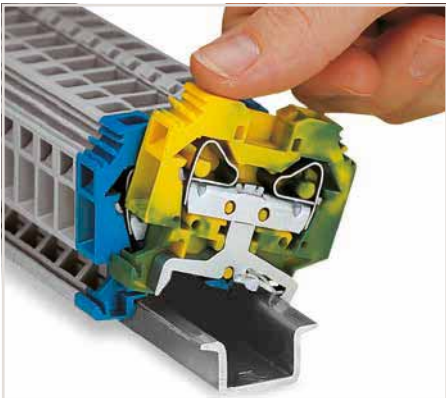

Snapping a terminal block onto the carrier rail. Ground conductor terminal blocks snap onto the rail in the same way as through terminal blocks, but automatically make a direct electrical connection to the rail. After mounting, sliding the blocks on the rail is not possible.

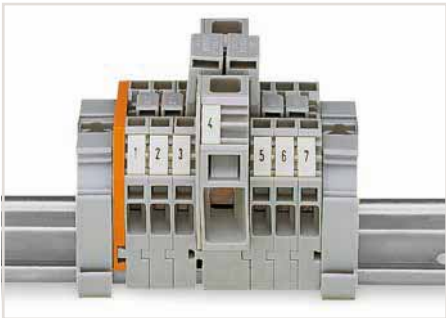

Commoning from 16 mm<sup>2</sup>/6 AWG (283 Series) to 4 mm<sup>2</sup>/12 AWG (281 Series) rail-mount terminal blocks via step-down jumpers.

Terminal blocks with a blue insulated housing are suitable for Ex i applications.

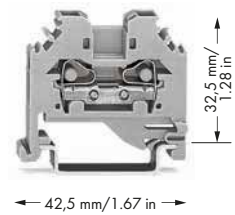

2-conductor through terminal block		
Color	Item No.	Pack. Unit
○ gray	281-101	100
● blue	281-104	100



#### Technical Data

Ratings per	IEC/EN 60947-7-1
Rated voltage (III / 3)	800 V
Rated surge voltage (III / 3)	8 kV
Rated current	32 A
Approval	600 V, 20 A  600 V, 25 A

#### Connection Data

Solid conductor	0.08 ... 4 mm / 28 ... 12 AWG
Fine-stranded conductor	0.08 ... 4 mm / 28 ... 12 AWG
Strip length	9 ... 10 mm / 0.35 ... 0.39 inch
Terminal block width	6 mm / 0.236 inch
Insulation material	Polyamide 66 (PA 66)

#### Accessories (Selection)

Adjacent jumper, insulated, I <sub>N</sub> = I <sub>N</sub> terminal block	
Adjacent jumper, insulated, I <sub>N</sub> 41 A	
End and intermediate plate, 3 mm thick	
End and intermediate plate, 4 mm thick	
WMB Inline, plain, 1,500 WMB markers (5 mm) per reel, 5 ... 5.2 mm stretchable	
WMB Multi marking system, white, 10 strips with 10 markers per card, 5 ... 5.2 mm stretchable	
Test plug adapter, 5 mm wide, for 210-137 Test Plug (2.3 mm Ø), for 1.5 ... 4 mm <sup>2</sup> terminal blocks	
B-type test plug module with CAGE CLAMP®, snaps together	
Module width 8 mm	

	Item No.	Page
gray	281-402	672
orange	281-302	672
white	2009-115	780
gray	280-404	678

Accessories for 281 Series, see page 672

Accessories for 282 Series, see page 673

Carrier rails and tools, see Section 13

Appropriate marking system: WMB/WMB Inline, see Full Line Catalog, Volume 6

Approvals and corresponding ratings, visit [www.wago.com](http://www.wago.com)



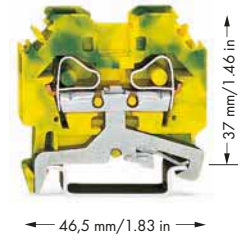
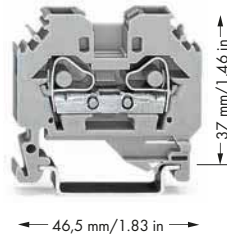
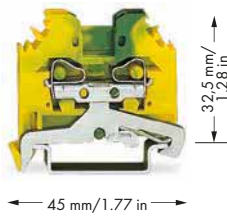

2-conductor ground terminal block		
Color	Item No.	Pack. Unit
● green-yellow	281-107	100

2-conductor through terminal block		
Color	Item No.	Pack. Unit
● gray	282-101	50
● blue	282-104	50

2-conductor ground terminal block		
Color	Item No.	Pack. Unit
● green-yellow	282-107	50



IEC/EN 60947-7-2

IEC/EN 60947-7-1

IEC/EN 60947-7-2

0.08 ... 4 mm / 28 ... 12 AWG  
 0.08 ... 4 mm / 28 ... 12 AWG  
 9 ... 10 mm / 0.35 ... 0.39 inch  
 6 mm / 0.236 inch  
 Polyamide 66 (PA 66)

0.2 ... 6 mm / 24 ... 10 AWG  
 0.2 ... 6 mm / 24 ... 10 AWG  
 12 ... 13 mm / 0.47 ... 0.51 inch  
 8 mm / 0.315 inch  
 Polyamide 66 (PA 66)

0.2 ... 6 mm / 24 ... 10 AWG  
 0.2 ... 6 mm / 24 ... 10 AWG  
 12 ... 13 mm / 0.47 ... 0.51 inch  
 8 mm / 0.315 inch  
 Polyamide 66 (PA 66)

	Item No.	Page
gray	281-402	672
orange	281-302	672
white	2009-115	780
gray	280-404	678

	Item No.	Page
gray	282-402	673
orange	282-302	673
plain	793-5501	780
gray	709-310	673

	Item No.	Page
gray	282-402	673
orange	282-302	673
plain	793-5501	780
gray	709-310	673

## Through and Ground Conductor Terminal Blocks

### 10 mm<sup>2</sup>, 284 Series and 16 mm<sup>2</sup>, 283 Series

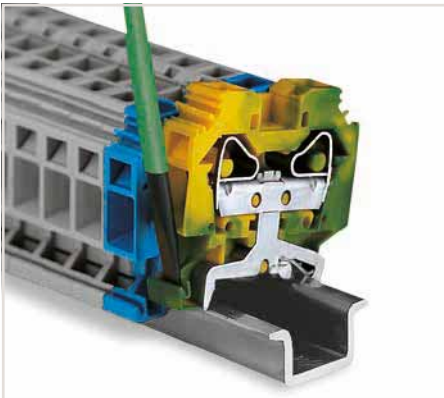

Removing a terminal block from the carrier rail. When mounting on the rail, ensure that open sides of terminal blocks face in the same direction. Both mounting feet and removal slots are on the same side for all terminal blocks, making it possible to visually ensure blocks are facing in same direction.

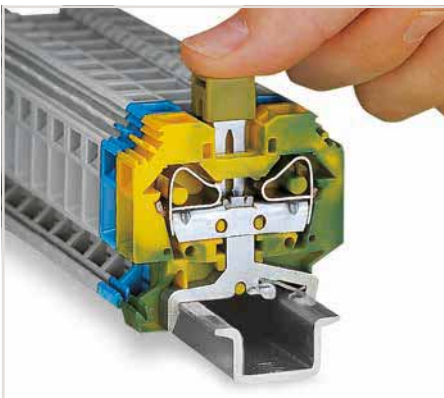

Push jumper down until fully inserted. Commoning ground conductor terminal blocks with through terminal blocks is possible in one direction only (via rear side of terminal block) using adjacent jumpers. WAGO recommends using yellow-green adjacent jumpers in addition to the required marking of these blocks.

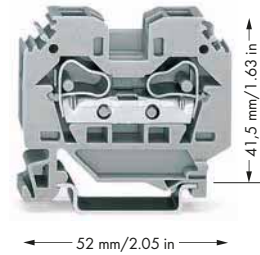

2-conductor through terminal block		
Color	Item No.	Pack. Unit
○ gray	284-101	50
● blue	284-104	50



#### Technical Data

Ratings per	IEC/EN 60947-7-1
Rated voltage (III / 3)	800 V
Rated surge voltage (III / 3)	8 kV
Rated current	57 A
Approval	600 V, 50 A  600 V, 65 A

#### Connection Data

Solid conductor	0.2 ... 10 mm / 24 ... 8 AWG
Fine-stranded conductor	0.2 ... 10 mm / 24 ... 8 AWG
Strip length	12 ... 13 mm / 0.47 ... 0.51 inch
Terminal block width	10 mm / 0.394 inch
Insulation material	Polyamide 66 (PA 66)

#### Accessories (Selection)

Adjacent jumper, insulated, I <sub>N</sub> 57 A	
Adjacent jumper, insulated, I <sub>N</sub> 41 A	
End and intermediate plate, 2.5 mm thick	
End and intermediate plate, 4 mm thick	
WMB Multi marking system, white, 10 strips with 10 markers per card, 5 ... 5.2 mm stretchable	
B-type test plug module with CAGE CLAMP®, snaps together Module width 8 mm	
B-type spacer plate, snaps together, snaps on B-type test plug modules (709-310) and B-type spacer modules (709-311) Module width 2 mm	
Test plug adapter, 11.6 mm wide, for 4 mm Ø test plug, for 1.5 ... 16 mm <sup>2</sup> terminal blocks	

	Item No.	Page
gray	284-402	675
orange	284-302	675
plain	793-5501	780
gray	709-310	675
gray	709-312	675

Accessories for 284 Series, see page 675

Accessories for 283 Series, see page 677

Carrier rails and tools, see Section 13

Appropriate marking system: WMB/WMB Inline, see Full Line Catalog, Volume 6

Approvals and corresponding ratings, visit [www.wago.com](http://www.wago.com)

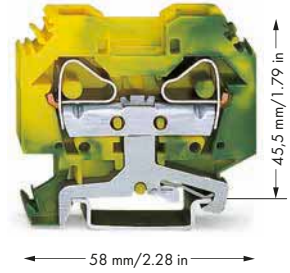
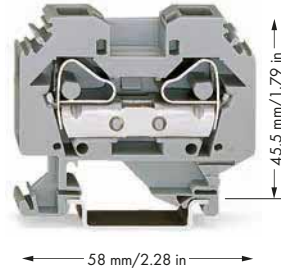
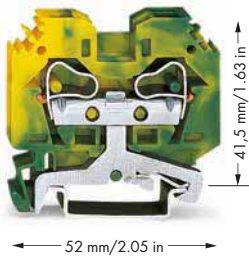

2-conductor ground terminal block		
Color	Item No.	Pack. Unit
● green-yellow	284-107	50

2-conductor through terminal block		
Color	Item No.	Pack. Unit
● gray	283-101	50
● blue	283-104	50

2-conductor ground terminal block		
Color	Item No.	Pack. Unit
● green-yellow	283-107	50



IEC/EN 60947-7-2

IEC/EN 60947-7-1

IEC/EN 60947-7-2

0.2 ... 10 mm / 24 ... 8 AWG  
 0.2 ... 10 mm / 24 ... 8 AWG  
 12 ... 13 mm / 0.47 ... 0.51 inch  
 10 mm / 0.394 inch  
 Polyamide 66 (PA 66)

0.2 ... 6 mm / 24 ... 10 AWG  
 0.2 ... 6 mm / 24 ... 10 AWG  
 12 ... 13 mm / 0.47 ... 0.51 inch  
 8 mm / 0.315 inch  
 Polyamide 66 (PA 66)

0.2 ... 6 mm / 24 ... 10 AWG  
 0.2 ... 6 mm / 24 ... 10 AWG  
 12 ... 13 mm / 0.47 ... 0.51 inch  
 8 mm / 0.315 inch  
 Polyamide 66 (PA 66)

	Item No.	Page
gray	284-402	675
orange	284-302	675
plain	793-5501	780
gray	709-310	675
gray	709-312	675

	Item No.	Page
gray	283-402	677
orange	283-302	677
plain	793-5501	780
gray	283-404	677

	Item No.	Page
gray	283-402	677
orange	283-302	677
plain	793-5501	780
gray	283-404	677

## Step-Down Jumpers for Side-Entry Through Terminal Blocks Installation



Step-down jumper from 10/6 mm<sup>2</sup> (8/10 AWG) to 4/2.5/1.5 mm<sup>2</sup> (12/14/16 AWG); I<sub>N</sub> 15 A, Item No. 284-414



Step-down jumper from 10/6 mm<sup>2</sup> (8/10 AWG) to 6/4 mm<sup>2</sup> (10/12 AWG); I<sub>N</sub> 30 A, Item No. 284-413



Step-down jumper from 16 mm<sup>2</sup> (6 AWG) to 4 mm<sup>2</sup> (12 AWG); I<sub>N</sub> 32 A, Item No. 283-414

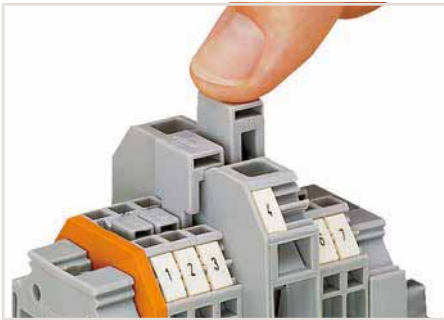

Step-down jumpers common terminal blocks of different sizes, without losing a conductor clamping point. This can be beneficial on long conductor runs where voltage drop can be a problem. A large conductor can be easily connected to smaller conductors at the distribution point.



Commoning from 6 mm<sup>2</sup>/10 AWG (282 Series) to 1.5 mm<sup>2</sup>/16 AWG (279 Series) front-entry rail-mount terminal blocks.

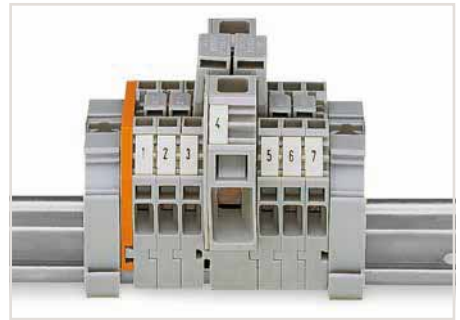

Commoning from 16 mm<sup>2</sup>/6 AWG (283 Series) to 4 mm<sup>2</sup>/12 AWG (281 Series) rail-mount terminal blocks via step-down jumpers.

Step-down jumpers are simply pushed down for full insertion, similar to adjacent jumpers. Commoning may be made in either direction using the special thin end plate to cover the open side. Additional through terminal blocks having a smaller cross-section may be commoned using adjacent jumpers.

In this case, pay attention that:

- The total current of the outgoing circuits does not exceed the nominal current of the step-down jumper.
- The standard or special thin cover plate is installed on the open side of the larger block.

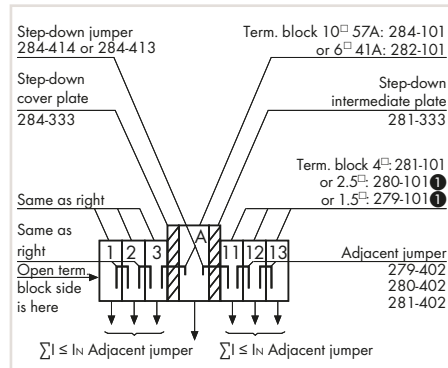

Assembly example: Commoning from 10/6 mm<sup>2</sup> (8/10 AWG) to 4/2.5/1.5 mm<sup>2</sup> (12/14/16 AWG) rail-mount terminal blocks via step-down jumper (284-414).

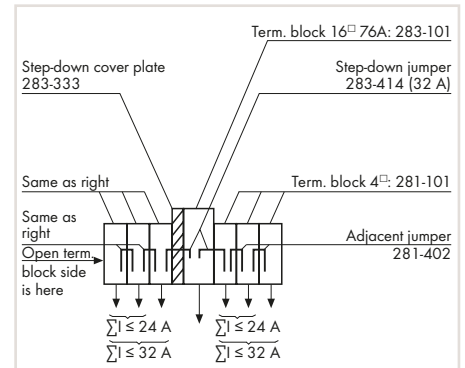

Assembly example: Commoning from 16 mm<sup>2</sup>/6 AWG to 4 mm<sup>2</sup>/12 AWG rail-mount terminal blocks via step-down jumper (283-414).

10



## Disconnect/Test Terminal Blocks

### 6 mm<sup>2</sup>, 282 Series

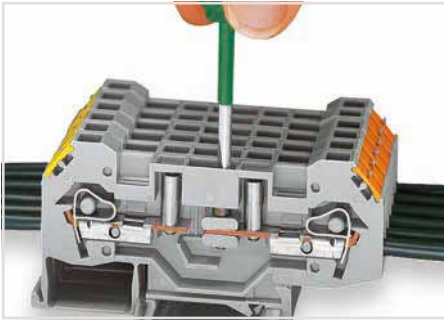

Shifting the disconnect slide link of a disconnect/test terminal block.

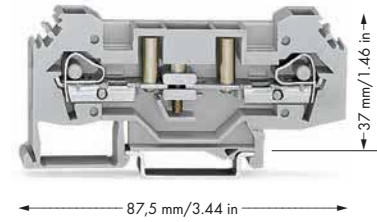

Disconnect/test terminal block, with 4 mm Ø test sockets

Color	Item No.	Pack. Unit
gray	282-131	25



#### Technical Data

Ratings per	
Rated voltage (III / 3)	400 V
Rated surge voltage (III / 3)	6 kV
Rated current	41 A
Approval	300 V, 30 A ; 300 V, 40 A

#### Connection Data

Solid conductor	0.2 ... 6 mm / 24 ... 10 AWG
Fine-stranded conductor	0.2 ... 6 mm / 24 ... 10 AWG
Strip length	12 ... 13 mm / 0.47 ... 0.51 inch
Terminal block width	8 mm / 0.315 inch
Insulation material	Polyamide 66 (PA 66)

#### Accessories (Selection)

	Item No.	Page
Adjacent jumper, insulated, I <sub>N</sub> 41 A	gray 282-402	673
End and intermediate plate, 4 mm thick	orange 282-315	673
Lock-out, prevents reclosing of slide link, snap-on type	orange 282-137	674
WMB Multi marking system, white, 10 strips with 10 markers per card, 5 ... 5.2 mm stretchable	plain 793-5501	780
B-type test plug module with CAGE CLAMP®, snaps together Module width 8 mm	gray 709-310	673

10

Accessories (jumpers, end plates, test plugs, etc.), see page 673

Carrier rails and tools, see Section 13

Appropriate marking system: WMB/WMB Inline, see Full Line Catalog, Volume 6

Approvals and corresponding ratings, visit [www.wago.com](http://www.wago.com)



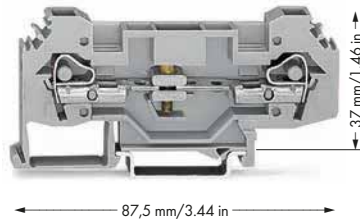
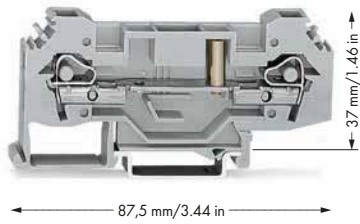

Through terminal block

Color	Item No.	Pack. Unit
● gray	282-133	50



IEC/EN 60947-7-1
400 V
6 kV
41 A
300 V, 30 A ; 300 V, 40 A

0.2 ... 6 mm / 24 ... 10 AWG
0.2 ... 6 mm / 24 ... 10 AWG
12 ... 13 mm / 0.47 ... 0.51 inch
8 mm / 0.315 inch
Polyamide 66 (PA 66)

	Item No.	Page
gray	282-402	673
orange	282-315	673
plain	793-5501	780
gray	709-310	673

Disconnect/test terminal block, without test sockets

Color	Item No.	Pack. Unit
● gray	282-135	25



400 V
6 kV
41 A
300 V, 30 A ; 300 V, 40 A

0.2 ... 10 mm / 24 ... 8 AWG
0.2 ... 6 mm / 24 ... 10 AWG
12 ... 13 mm / 0.47 ... 0.51 inch
8 mm / 0.315 inch
Polyamide 66 (PA 66)

	Item No.	Page
gray	282-402	673
orange	282-315	673
orange	282-137	674
plain	793-5501	780
gray	709-310	673

## Ground Conductor Disconnect Terminal Blocks Installation

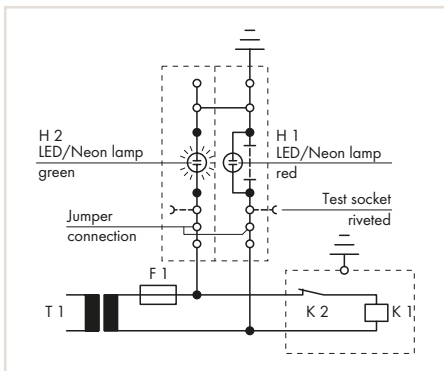

**Operating condition**  
Slide link closed, auxiliary circuit grounded, green LED/neon lamp illuminates.

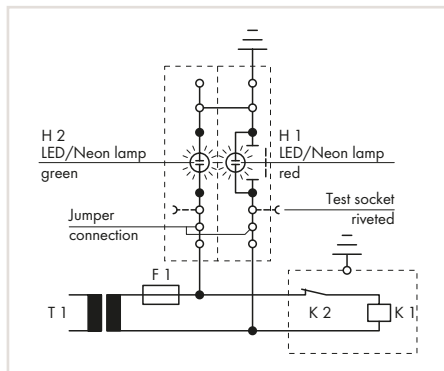

**Test condition – no grounding**  
Slide link open, auxiliary circuit not grounded.

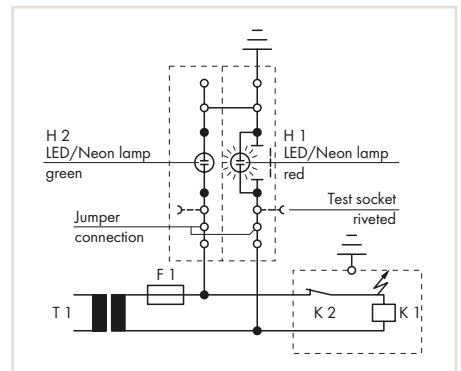

**Test condition – grounding**  
Slide link open, auxiliary circuit not grounded, red LED/neon lamp illuminates.

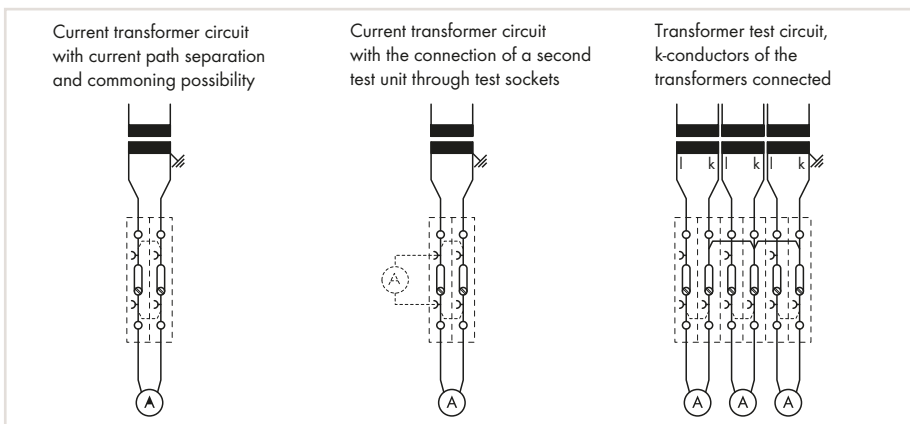

IEC 60204/DIN VDE 0113 "Safety of machinery – Electrical equipment of machines – Part 1: General requirements," Section 9.4.3.1:

Ground faults on control circuits must not cause unintentional starting, hazardous movements, or prevent stopping of the machine.

In order to fulfill this requirement, a connection to the protective bonding circuit must be provided in accordance with Section 8.2 and the devices must be connected as described in Section 9.1.4. Control circuits fed from a transformer and not connected to the protective bonding circuit must be provided with an insulation monitoring device (e.g., residual current device), which either indicates a ground fault or interrupts the circuit automatically after a ground fault.

In the case of electronic circuits, the connection of one side of the control circuit to the protective bonding circuit in accordance with Section 9.1.4 can prevent unintentional operation. When this does not help, or if due to other reasons that electronic circuits cannot be connected to the protective bonding circuit, other measures must be taken to achieve the same level of safety.

Multipole control switches that interrupt all live conductors must be used where the control circuit is directly connected between the phase conductors of the supply or between a phase conductor and a neutral conductor, which is either not grounded or grounded through a high impedance. This is required for starting or stopping those machine functions, which can cause a hazardous situation including: damaging the machine or halting work in progress in the event of unintentional starting or failure to stop.

10

## Ground Conductor Disconnect Terminal Blocks

### 6 mm<sup>2</sup>, 282 Series

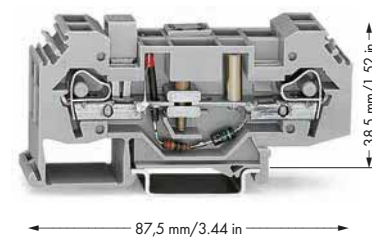

Ground conductor disconnect terminal block, gray

	Item No.	Pack. Unit
○ 24 V	282-140	12
○ 48 V	282-141	12
○ 120 V	282-138	12
○ 230 V	282-139	12



#### Technical Data

##### Connection Data

Solid conductor

0.2 ... 6 mm / 24 ... 10 AWG

Fine-stranded conductor

0.2 ... 6 mm / 24 ... 10 AWG

Strip length

12 ... 13 mm / 0.47 ... 0.51 inch

Terminal block width

8 mm / 0.315 inch

Insulation material

Polyamide 66 (PA 66)

##### Accessories (Selection)

End and intermediate plate, 4 mm thick

	Item No.	Page
orange	282-315	673
orange	282-137	673
plain	793-5501	780

Lock-out, prevents reclosing of slide link, snap-on type

WMB Multi marking system, white, 10 strips with 10 markers per card, 5 ... 5.2 mm stretchable

Accessories (end plates, etc.), see page 673

Carrier rails and tools, see Section 13

Appropriate marking system: WMB/WMB Inline, see Full Line Catalog, Volume 6

Approvals and corresponding ratings, visit [www.wago.com](http://www.wago.com)

## Fuse Terminal Blocks

### 6 mm<sup>2</sup>, 282 Series

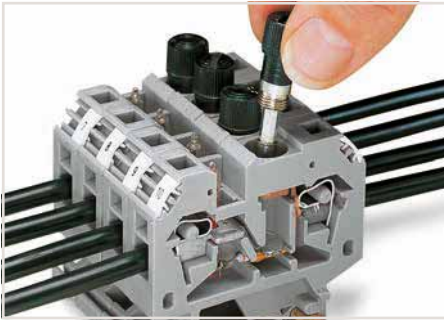

Replacing a fuse.

Electrical ratings are given by the miniature metric fuse.

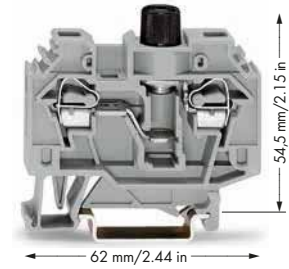

2-conductor fuse terminal block, for 5 x 20 mm miniature metric fuses, without indicator

Color	Item No.	Pack. Unit
○ gray	282-122	40

**UL**

#### Technical Data

Voltage type	
Rated voltage (III / 3)	500 V
Rated surge voltage (III / 3)	6 kV
Voltage type (2)	
Rated voltage (III / 3) 2	
Rated current	10 A
Approval	600 V, 10 A <b>UL</b> ; 250 V, 10 A <b>CE</b>

#### Connection Data

Solid conductor	0.2 ... 6 mm / 24 ... 10 AWG
Fine-stranded conductor	0.2 ... 6 mm / 24 ... 10 AWG
Strip length	12 ... 13 mm / 0.47 ... 0.51 inch
Terminal block width	13 mm / 0.512 inch
Insulation material	Polyamide 66 (PA 66)

#### Accessories (Selection)

	Item No.	Page
Adjacent jumper, insulated, I <sub>N</sub> 41 A	gray 282-402	673
End and intermediate plate, 4 mm thick	orange 282-312	673
WMB Multi marking system, white, 10 strips with 10 markers per card, 5 ... 5.2 mm stretchable	plain 793-5501	780
Glass cartridge fuse, without indicator, 5 x 20 mm, 6.3 A / 250 V, medium-acting	282-451	674
Glass cartridge fuse, with indicator, 5 x 25 mm, 6.3 A / 250 V, medium-acting		
Glass cartridge fuse, with indicator, 5 x 25 mm, 10 A / 450 V, fast-acting		
Glass cartridge fuse, without indicator, ¼" x 1", 10 A / 240 V, per BS 1362		
Test plug adapter, 8.3 mm wide, for 4 mm Ø test plug, for 1.5 ... 10 mm <sup>2</sup> terminal blocks	gray 209-170	678

Accessories (jumpers, end plates, test plugs, etc.), see page 673

Carrier rails and tools, see Section 13

Appropriate marking system: WMB/WMB Inline, see Full Line Catalog, Volume 6

Approvals and corresponding ratings, visit [www.wago.com](http://www.wago.com)

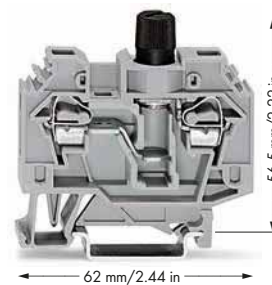
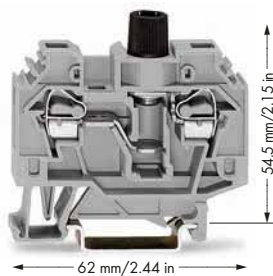
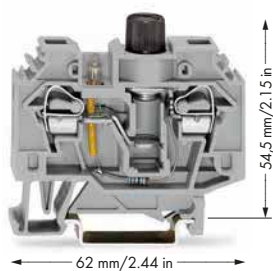

2-conductor fuse terminal block, for 5 x 20 mm miniature metric fuses, with 250 VAC/220 VDC neon lamp

Color	Item No.	Pack. Unit
○ gray	282-124	40

2-conductor fuse terminal block, for 5 x 25 mm miniature metric fuses, with indicator

Color	Item No.	Pack. Unit
○ gray	282-126	40

2-conductor fuse terminal block, for 1/4" x 1" miniature metric fuses, without indicator

Color	Item No.	Pack. Unit
○ gray	282-120	40

AC
250 V
DC
220 V
10 A
600 V, 10 A ; 220 V, 10 A

10 A
600 V, 10 A ; 250 V, 10 A

10 A
250 V, 10 A

0.2 ... 6 mm / 24 ... 10 AWG
0.2 ... 6 mm / 24 ... 10 AWG
12 ... 13 mm / 0.47 ... 0.51 inch
13 mm / 0.512 inch
Polyamide 66 (PA 66)

0.2 ... 6 mm / 24 ... 10 AWG
0.2 ... 6 mm / 24 ... 10 AWG
12 ... 13 mm / 0.47 ... 0.51 inch
13 mm / 0.512 inch
Polyamide 66 (PA 66)

0.2 ... 6 mm / 24 ... 10 AWG
0.2 ... 6 mm / 24 ... 10 AWG
12 ... 13 mm / 0.47 ... 0.51 inch
13 mm / 0.512 inch
Polyamide 66 (PA 66)

	Item No.	Page
gray	282-402	673
orange	282-312	673
plain	793-5501	780
	282-451	674
gray	209-170	678

	Item No.	Page
gray	282-402	673
orange	282-312	673
plain	793-5501	780
	282-452	674
	282-453	674
gray	209-170	678

	Item No.	Page
gray	282-402	673
orange	282-312	673
plain	793-5501	780
	282-458	674
gray	209-170	678

## Fuse Terminal Blocks

### 6 mm<sup>2</sup>, 282 Series

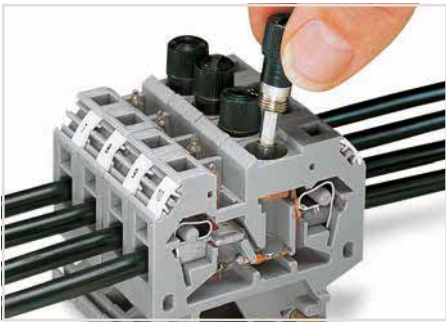

Replacing a fuse.

Electrical ratings are given by the miniature metric fuse.



2-conductor fuse terminal block, for 1/4" x 1 1/4" miniature metric fuses, without indicator

Color	Item No.	Pack. Unit
○ gray	282-128	40

**UL**

#### Technical Data

Voltage type

Rated voltage (III / 3)

Rated surge voltage (III / 3)

Voltage type (2)

Rated voltage (III / 3) 2

Rated current

Approval

#### Connection Data

Solid conductor

Fine-stranded conductor

Strip length

Terminal block width

Insulation material

#### Accessories (Selection)

Adjacent jumper, insulated, I<sub>N</sub> 41 A

End and intermediate plate, 4 mm thick

WMB Multi marking system, white, 10 strips with 10 markers per card, 5 ... 5.2 mm stretchable

Glass cartridge fuse, without indicator, 1/4" x 1 1/4", medium-acting

Glass cartridge fuse, without indicator, 1/4" x 1 1/4", very fast-acting

Test plug adapter, 8.3 mm wide, for 4 mm Ø test plug, for 1.5 ... 10 mm<sup>2</sup> terminal blocks

500 V

6 kV

10 A

600 V, 10 A **UL**, 250 V, 10 A **CE**

0.2 ... 6 mm / 24 ... 10 AWG

0.2 ... 6 mm / 24 ... 10 AWG

12 ... 13 mm / 0.47 ... 0.51 inch

13 mm / 0.512 inch

Polyamide 66 (PA 66)

	Item No.	Page
gray	282-402	673
orange	282-312	673
plain	793-5501	780
	282-457	674
	282-454	674
gray	209-170	678

Accessories (jumpers, end plates, test plugs, etc.), see page 673

Carrier rails and tools, see Section 13

Appropriate marking system: WMB/WMB Inline, see Full Line Catalog, Volume 6

Approvals and corresponding ratings, visit [www.wago.com](http://www.wago.com)



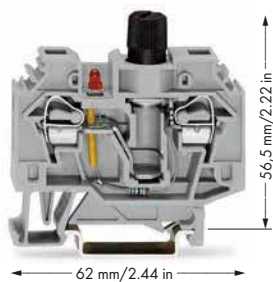

2-conductor fuse terminal block, for 1/4" x 1/4" miniature metric fuses, with 24 VDC red LED

Color	Item No.	Pack. Unit
○ gray	282-128/281-413	40

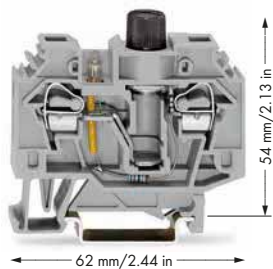

2-conductor fuse terminal block, for 1/4" x 1/4" miniature metric fuses, with 250 VAC/220 VDC neon lamp

Color	Item No.	Pack. Unit
○ gray	282-128/281-417	40

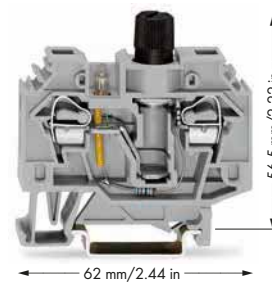

2-conductor fuse terminal block, for 1/4" x 1/4" miniature metric fuses, with 120 VAC/DC neon lamp

Color	Item No.	Pack. Unit
○ gray	282-128/281-418	40

DC
24 V
10 A
24 V, 10 A <sup>Ⓜ</sup> ; 24 V, 10 A <sup>Ⓢ</sup>
0.2 ... 6 mm / 24 ... 10 AWG
0.2 ... 6 mm / 24 ... 10 AWG
12 ... 13 mm / 0.47 ... 0.51 inch
13 mm / 0.512 inch
Polyamide 66 (PA 66)

AC
250 V
DC
220 V
10 A
250 V, 10 A <sup>Ⓜ</sup> ; 220 V, 10 A <sup>Ⓢ</sup>
0.2 ... 6 mm / 24 ... 10 AWG
0.2 ... 6 mm / 24 ... 10 AWG
12 ... 13 mm / 0.47 ... 0.51 inch
13 mm / 0.512 inch
Polyamide 66 (PA 66)

AC/DC
120 V
10 A
24 V, 10 A <sup>Ⓜ</sup> ; 110 V, 10 A <sup>Ⓢ</sup>
0.2 ... 6 mm / 24 ... 10 AWG
0.2 ... 6 mm / 24 ... 10 AWG
12 ... 13 mm / 0.47 ... 0.51 inch
13 mm / 0.512 inch
Polyamide 66 (PA 66)

	Item No.	Page
gray	282-402	673
orange	282-312	673
plain	793-5501	780
	282-457	674
	282-454	674
gray	209-170	

	Item No.	Page
gray	282-402	673
orange	282-312	673
plain	793-5501	780
	282-457	674
	282-454	674
gray	209-170	678

	Item No.	Page
gray	282-402	673
orange	282-312	673
plain	793-5501	780
	282-457	674
	282-454	674
gray	209-170	678

## Accessories, 279 Series or a 4 mm Terminal Block Width Commoning, Mounting, Marking and Testing



Adjacent jumper, insulated, I <sub>N</sub> 15 A		
Color	Item No.	Pack. Unit
gray	279-402	200 (25)
yellow-green	279-422	200 (25)



Alternate jumper, insulated, I <sub>N</sub> 15 A		
Color	Item No.	Pack. Unit
gray	279-409	100 (25)



Push-in type wire jumper, insulated, 0.75 mm <sup>2</sup> conductor cross-section, I <sub>N</sub> 9 A		
	Item No.	Pack. Unit
L = 60 mm	249-125	10
L = 110 mm	249-126	10
L = 250 mm	249-127	10



 Step-down jumpers,  
see page 660

Step-down jumper, insulated, commons 10/6 mm <sup>2</sup> (8/10 AWG) down to 4/2.5/1.5 mm <sup>2</sup> (12/14/16 AWG), I <sub>N</sub> 15 A		
Color	Item No.	Pack. Unit
gray	284-414	50 (25)



Step-down intermediate plate, 1 mm thick		
Color	Item No.	Pack. Unit
gray	281-333	100 (25)
orange	281-336	100 (25)



End and intermediate plate, 2.5 mm thick			
Suitable for:	Color	Item No.	Pack. Unit
279-101	orange	280-302	100 (25)
	gray	280-301	100 (25)



Separator, oversized, 2 mm thick			
Suitable for:	Color	Item No.	Pack. Unit
279-101	orange	280-322	100 (25)
	gray	280-332	100 (25)



Protective warning marker, with black high-voltage symbol, for 5 terminal blocks		
Color	Item No.	Pack. Unit
yellow	279-405	100 (25)

10

## Accessories, 280 Series or a 5 mm Terminal Block Width Commoning, Mounting, Marking and Testing



Adjacent jumper, insulated, $I_N = I_N$ terminal block		
Color	Item No.	Pack. Unit
gray	280-402	200 (25)
yellow-green	280-422	200 (25)



Alternate jumper, insulated, $I_N = I_N$ terminal block		
Color	Item No.	Pack. Unit
gray	280-409	100 (25)



Staggered jumper, insulated, 5 mm wide, $I_N$ 24 A, gray		
	Item No.	Pack. Unit
1 to 2	780-452	100 (25)
1 to 3	780-453	100 (25)
1 to 4	780-454	100 (25)
1 to 5	780-455	50 (25)
1 to 6	780-456	50 (25)
1 to 7	780-457	50 (25)
1 to 8	780-458	50 (25)



Push-in type wire jumper, insulated, 0.75 mm <sup>2</sup> conductor cross-section, $I_N$ 9 A		
	Item No.	Pack. Unit
L = 60 mm	249-125	10
L = 110 mm	249-126	10
L = 250 mm	249-127	10



 Step-down jumpers,  
see page 660

Step-down jumper, insulated, commons 10/6 mm <sup>2</sup> (8/10 AWG) down to 4/2.5/1.5 mm <sup>2</sup> (12/14/16 AWG), $I_N$ 15 A		
Color	Item No.	Pack. Unit
gray	284-414	50 (25)



Step-down intermediate plate, 1 mm thick		
Color	Item No.	Pack. Unit
gray	281-333	100 (25)
orange	281-336	100 (25)



End and intermediate plate, 2.5 mm thick			
Suitable for:	Color	Item No.	Pack. Unit
280-101	orange	280-302	100 (25)
	gray	280-301	100 (25)



Separator, oversized, 2 mm thick			
Suitable for:	Color	Item No.	Pack. Unit
280-101	orange	280-322	100 (25)
	gray	280-332	100 (25)



Protective warning marker, with black high-voltage symbol, for 5 terminal blocks		
Color	Item No.	Pack. Unit
yellow	280-405	100 (25)

## Accessories, 281 Series or a 6 mm Terminal Block Width Commoning, Mounting, Marking and Testing



Adjacent jumper, insulated, $I_N = I_N$ terminal block		
Color	Item No.	Pack. Unit
gray	281-402	200 (25)
yellow-green	281-422	200 (25)



Alternate jumper, insulated, $I_N = I_N$ terminal block		
Color	Item No.	Pack. Unit
gray	281-409	100 (25)



Staggered jumper, insulated, 6 mm wide, $I_N$ 32 A, gray		
	Item No.	Pack. Unit
1 to 2	781-452	100 (25)
1 to 3	781-453	100 (25)
1 to 4	781-454	100 (25)
1 to 5	781-455	50 (25)
1 to 6	781-456	50 (25)



Push-in type wire jumper, insulated, 0.75 mm <sup>2</sup> conductor cross-section, $I_N$ 9 A		
	Item No.	Pack. Unit
L = 60 mm	249-125	10
L = 110 mm	249-126	10
L = 250 mm	249-127	10



 Step-down jumpers,  
see page 660

Step-down jumper, insulated, commons 10/6 mm <sup>2</sup> (8/10 AWG) down to 4/2.5/1.5 mm <sup>2</sup> (12/14/16 AWG), $I_N$ 15 A		
Color	Item No.	Pack. Unit
gray	284-414	50 (25)



Step-down intermediate plate, 1 mm thick		
Color	Item No.	Pack. Unit
gray	281-333	100 (25)
orange	281-336	100 (25)



End and intermediate plate, 3 mm thick			
Suitable for:	Color	Item No.	Pack. Unit
281-101	orange	281-302	100 (25)
	gray	281-301	100 (25)



Separator, oversized, 2 mm thick			
Suitable for:	Color	Item No.	Pack. Unit
281-101	orange	281-322	100 (25)
	gray	281-332	100 (25)

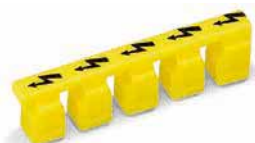

Protective warning marker, with black high-voltage symbol, for 5 terminal blocks		
Color	Item No.	Pack. Unit
yellow	281-405	100 (25)

10

## Accessories, 282 Series or a 8 mm Terminal Block Width Commoning, Mounting, Marking and Testing



Adjacent jumper, insulated, I <sub>N</sub> 41 A		
Color	Item No.	Pack. Unit
gray	282-402	100 (25)
yellow-green	282-422	100 (25)
orange	282-424	100 (25)



Alternate jumper, insulated, I <sub>N</sub> 41 A		
Color	Item No.	Pack. Unit
gray	282-409	100 (25)



Step-down jumpers,  
see page 660

Step-down jumper, insulated, commons 10/6 mm <sup>2</sup> (8/10 AWG) down to 4/2.5/1.5 mm <sup>2</sup> (12/14/16 AWG), I <sub>N</sub> 15 A		
Color	Item No.	Pack. Unit
gray	284-414	50 (25)



Step-down jumpers,  
see page 660

Step-down jumper, insulated, commons 10/6 mm <sup>2</sup> (8/10 AWG) down to 6/4 mm <sup>2</sup> (10/12 AWG), I <sub>N</sub> 30 A		
Color	Item No.	Pack. Unit
gray	284-413	50 (25)



Step-down cover plate, 1 mm thick		
Color	Item No.	Pack. Unit
gray	284-333	100 (25)
orange	284-343	100 (25)



End and intermediate plate, 4 mm thick			
Suitable for:	Color	Item No.	Pack. Unit
282-101	orange	282-302	100 (25)
	gray	282-301	100 (25)



Separator, oversized, 2 mm thick			
Suitable for:	Color	Item No.	Pack. Unit
282-101	orange	282-322	100 (25)
	gray	282-332	100 (25)



End and intermediate plate, 4 mm thick			
Suitable for:	Color	Item No.	Pack. Unit
282-131	orange	282-315	50 (25)
	gray	282-314	50 (25)



End and intermediate plate, 4 mm thick			
Suitable for:	Color	Item No.	Pack. Unit
282-122	orange	282-312	50 (25)
	gray	282-311	50 (25)



Power must be switched off when installing the test plug adapter. The safety rules for working on live installations must be observed.

Test voltage	800 V
Test current applied	32 A

B-type test plug module, snaps together Module width 8 mm		
Color	Item No.	Pack. Unit
gray	709-310	100 (25)

## Accessories, 282 Series or a 8 mm Terminal Block Width

### Commoning, Mounting, Marking and Testing



B-type spacer module, snaps together, bridges commoned terminal blocks Module width 8 mm			
Color		Item No.	Pack. Unit
gray		709-311	100 (25)



Strain relief plate, gray, for 8 mm wide terminal blocks			
Suitable for:		Item No.	Pack. Unit
709-310	2-pole	709-322	100 (25)
	4-pole	709-324	100 (25)
	6-pole	709-326	100 (25)



Protective warning marker, with black high-voltage symbol, for 5 terminal blocks			
Color		Item No.	Pack. Unit
yellow		282-405	100 (25)



Glass cartridge fuse, without indicator, 5 x 20 mm, 6.3 A / 250 V, medium-acting			
Suitable for:		Item No.	Pack. Unit
282-122		282-451	100
282-124			



Glass cartridge fuse, with indicator, 5 x 25 mm, 6.3 A / 250 V, medium-acting			
Suitable for:		Item No.	Pack. Unit
282-126		282-452	200 (10)



Glass cartridge fuse, with indicator, 5 x 25 mm, 10 A / 450 V, fast-acting			
Suitable for:		Item No.	Pack. Unit
282-126		282-453	200 (10)



Glass cartridge fuse, without indicator, 1/4" x 1", 10 A / 240 V, per BS 1362			
Suitable for:		Item No.	Pack. Unit
282-120		282-458	200 (10)



Glass cartridge fuse, without indicator, 1/4" x 1 1/4", medium-acting			
Suitable for:		Item No.	Pack. Unit
282-128		282-457	200 (100)
282-128/281-413			
282-128/281-417			
282-128/281-418			



Glass cartridge fuse, without indicator, 1/4" x 1 1/4", very fast-acting			
Suitable for:		Item No.	Pack. Unit
282-128		282-454	200 (10)
282-128/281-413			
282-128/281-417			
282-128/281-418			



Lock-out, prevents reclosing of slide link, snap-on type			
Suitable for:	Color	Item No.	Pack. Unit
282-131	orange	282-137	100 (25)

10



## Accessories, 284 and 784 Series or a 10 mm Terminal Block Width Commoning, Mounting, Marking and Testing



Adjacent jumper, insulated, I <sub>N</sub> 57 A		
Color	Item No.	Pack. Unit
gray	284-402	100 (25)
yellow-green	284-422	100 (25)



Alternate jumper, insulated, I <sub>N</sub> 57 A		
Color	Item No.	Pack. Unit
gray	284-409	50 (25)



Step-down jumpers,  
see page 660

Step-down jumper, insulated, commons 10/6 mm <sup>2</sup> (8/10 AWG) down to 4/2.5/1.5 mm <sup>2</sup> (12/14/16 AWG), I <sub>N</sub> 15 A		
Color	Item No.	Pack. Unit
gray	284-414	50 (25)



Step-down jumpers,  
see page 660

Step-down jumper, insulated, commons 10/6 mm <sup>2</sup> (8/10 AWG) down to 6/4 mm <sup>2</sup> (10/12 AWG), I <sub>N</sub> 30 A		
Color	Item No.	Pack. Unit
gray	284-413	50 (25)



Step-down cover plate, 1 mm thick		
Color	Item No.	Pack. Unit
gray	284-333	100 (25)
orange	284-343	100 (25)



End and intermediate plate, 2.5 mm thick			
Suitable for:	Color	Item No.	Pack. Unit
284-101	orange	284-302	100 (25)
	gray	284-301	100 (25)



Separator, oversized, 2 mm thick			
Suitable for:	Color	Item No.	Pack. Unit
284-101	orange	284-322	100 (25)
	gray	284-332	100 (25)



Power must be switched off when installing the test plug adapter. The safety rules for working on live installations must be observed.

Test voltage	800 V
Test current applied	32 A

B-type test plug module, snaps together Module width 8 mm		
Color	Item No.	Pack. Unit
gray	709-310	100 (25)



B-type spacer module, snaps together, bridges commoned terminal blocks Module width 8 mm		
Color	Item No.	Pack. Unit
gray	709-311	100 (25)



B-type spacer plate, snaps together, snaps on B-type test plug modules (709-310) and B-type spacer modules (709-311) Module width 2 mm		
Color	Item No.	Pack. Unit
gray	709-312	100 (25)

## Accessories, 284 and 784 Series or a 10 mm Terminal Block Width

### Commoning, Mounting, Marking and Testing



Strain relief plate, gray, for 10 mm wide terminal blocks			
Suitable for:		Item No.	Pack. Unit
709-310 + 709-312	2-pole	709-332	100 (25)
	4-pole	709-334	100 (25)
	6-pole	709-336	100 (25)



Protective warning marker, with black high-voltage symbol, for 5 terminal blocks		
Color	Item No.	Pack. Unit
yellow	284-405	50 (25)

## Accessories, 283 Series or a 12 mm Terminal Block Width Commoning, Mounting, Marking and Testing



Adjacent jumper, insulated, I <sub>N</sub> 70 A		
Color	Item No.	Pack. Unit
gray	283-402	50 (25)
yellow-green	283-422	50 (25)



Alternate jumper, insulated, I <sub>N</sub> 76 A		
Color	Item No.	Pack. Unit
gray	283-409	50 (25)



 Step-down jumpers,  
see page 660

Step-down jumper, insulated, commons 16 mm <sup>2</sup> (6 AWG) down to 4 mm <sup>2</sup> (12 AWG), I <sub>N</sub> 32 A		
Color	Item No.	Pack. Unit
gray	283-414	50 (25)



Step-down cover plate, 1 mm thick		
Color	Item No.	Pack. Unit
gray	283-333	100 (25)
orange	283-335	100 (25)



End and intermediate plate, 4 mm thick			
Suitable for:	Color	Item No.	Pack. Unit
283-101	orange	283-302	50 (25)
	gray	283-301	50 (25)



Separator, oversized, 2 mm thick			
Suitable for:	Color	Item No.	Pack. Unit
283-101	orange	283-322	50 (25)
	gray	283-332	50 (25)



Power must be switched off when installing the test plug adapter. The safety rules for working on live installations must be observed.

Test plug adapter, 11.6 mm wide, for 4 mm Ø test plug, for 1.5 ... 16 mm <sup>2</sup> terminal blocks		
Color	Item No.	Pack. Unit
gray	283-404	25



Power tap, with 500 mm cable, for 16 mm <sup>2</sup> /6 AWG (283/783 Series) and 35 mm <sup>2</sup> /2 AWG (285/785 Series) rail-mount terminal blocks		
Color	Item No.	Pack. Unit
gray	283-407	25

## Rail-Mount Terminal Blocks, Classic

### General Accessories



 Test plug adapters,  
see page 652

Power must be switched off when installing the test plug adapter. The safety rules for working on live installations must be observed.

Test plug adapter, 8.3 mm wide, for 4 mm Ø test plug, for 1.5 ... 10 mm <sup>2</sup> terminal blocks			
Suitable for:	Color	Item No.	Pack. Unit
279 Series	gray	209-170	50 (25)
280 Series			
281 Series			
282 Series			
284 Series			



Power must be switched off when installing the test plug adapter. The safety rules for working on live installations must be observed.

Test plug adapter, 5 mm wide, for 210-137 Test Plug (2.3 mm Ø), for 1.5 ... 4 mm <sup>2</sup> terminal blocks			
Suitable for:	Color	Item No.	Pack. Unit
279 Series	gray	280-404	100 (25)
280 Series			
281 Series			



Power must be switched off when installing the test plug adapter. The safety rules for working on live installations must be observed.

Test plug adapter, 6 mm wide, with CAGE CLAMP®, for 0.08 ... 2.5 mm <sup>2</sup> , I <sub>N</sub> 24 A			
Suitable for:	Color	Item No.	Pack. Unit
280 Series	gray	281-407	100 (25)
281 Series			



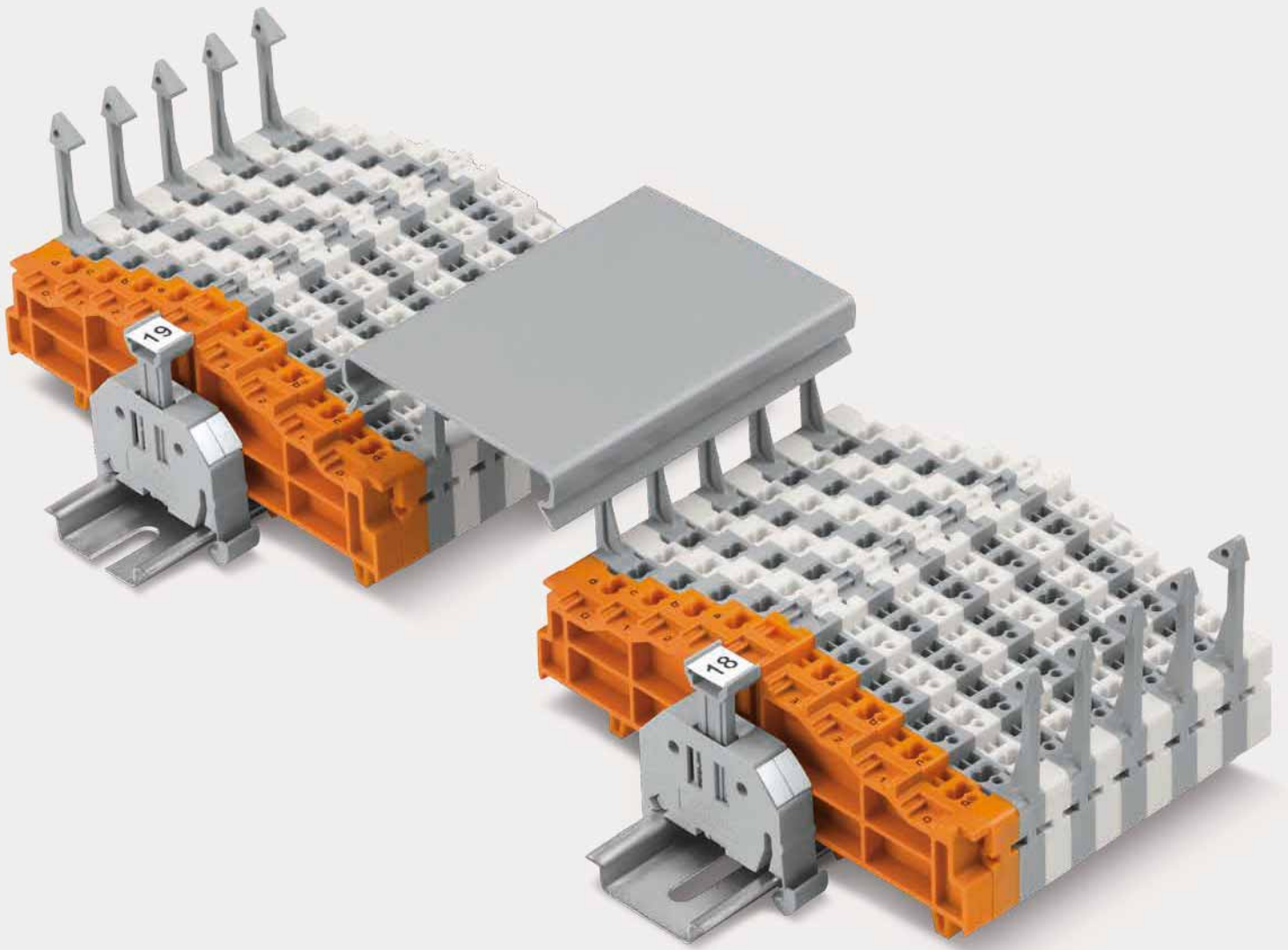







## Terminal Blocks for Matrix Patching and Potential Distribution



## Terminal Blocks for Matrix Patching and Potential Distribution, Busbar Terminal Blocks

			Page
	Matrix Patchboards	726 Series	684
	Common Potential Matrix Patchboards Marking on the Patchboard Side Marking on the Supply Side	726 Series	688
	Matrix Patchboard Accessories		696
	Terminal Blocks for Matrix Patching and Common Potential Terminal Blocks 1.5 mm <sup>2</sup> (16 AWG)	727 Series	700
	3-Conductor, Double-Potential Terminal Blocks 2.5 mm <sup>2</sup> (12 AWG)	280 Series	707
	Busbar Terminal Blocks	812 Series	712

## Matrix Patchboards, 726 Series Description and Installation

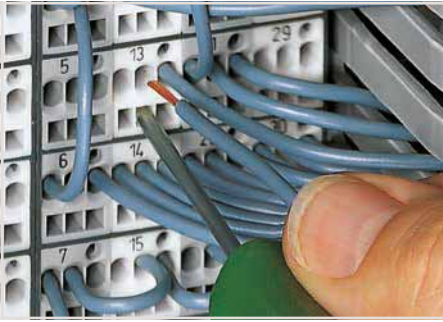

**CAGE CLAMP® connection**  
Inserting a conductor via 210-719 Operating Tool (2.5 x 0.4 mm blade).



Factory-marked modules  
Side 1: 1, 2, 3, 4 ...

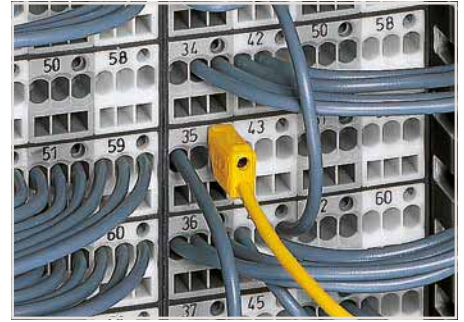

Testing with a 2.3 mm Ø test plug (210-137).

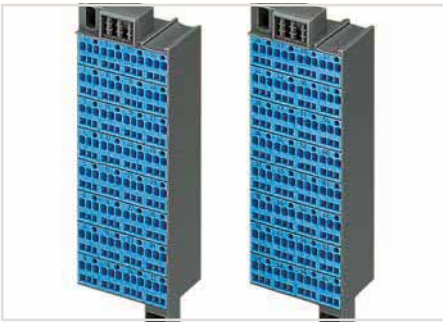

Blue matrix patchboards are suitable for Ex i applications.



WFB continuous marking strip – fits into the matrix patchboards' marker slot and group marker carrier.

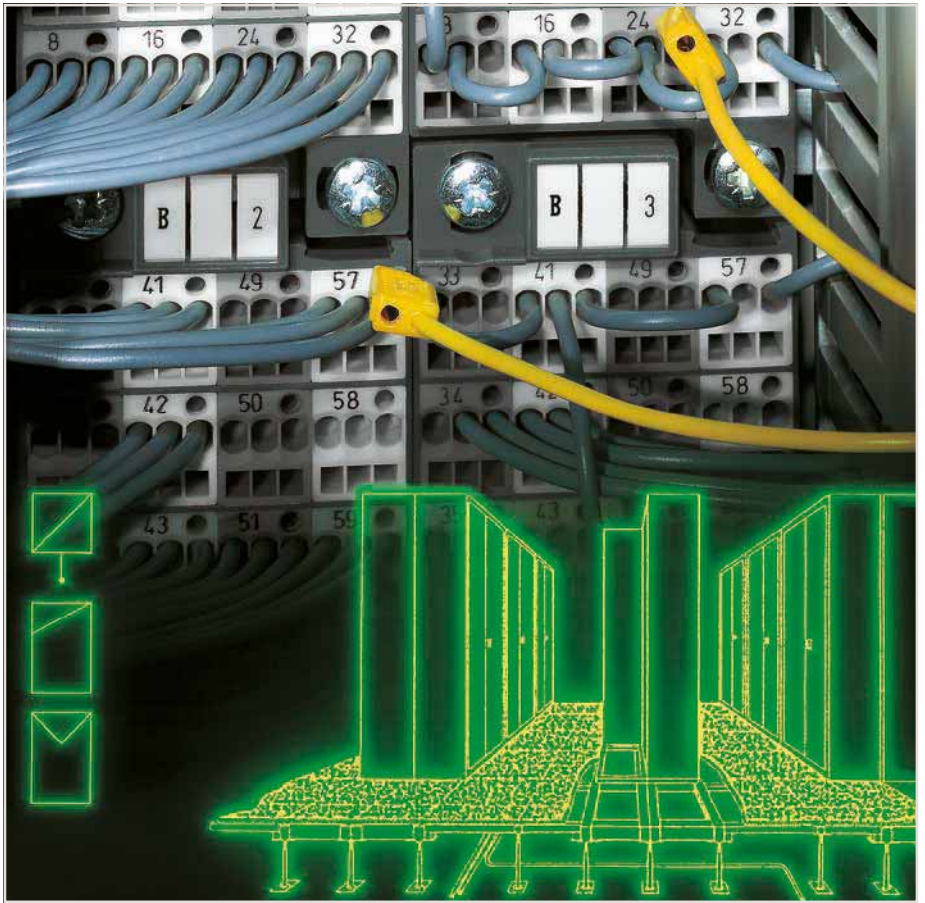

11



Individual group marking via WSB Quick Marking System.



Installation example:  
Matrix patchboards in a frame

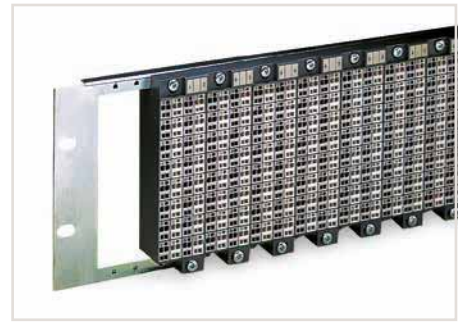

Installation example:  
Matrix patchboards in a 19" rack



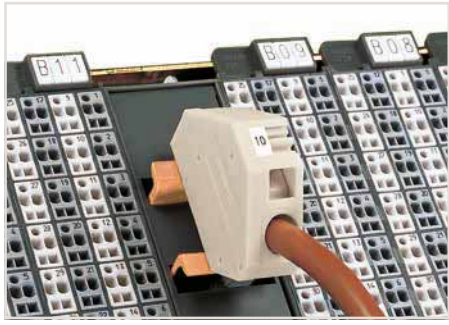

Common potential matrix patchboard (white) with supply terminal block



Saving space via slimline matrix patchboard (lower right), mounted upside down.

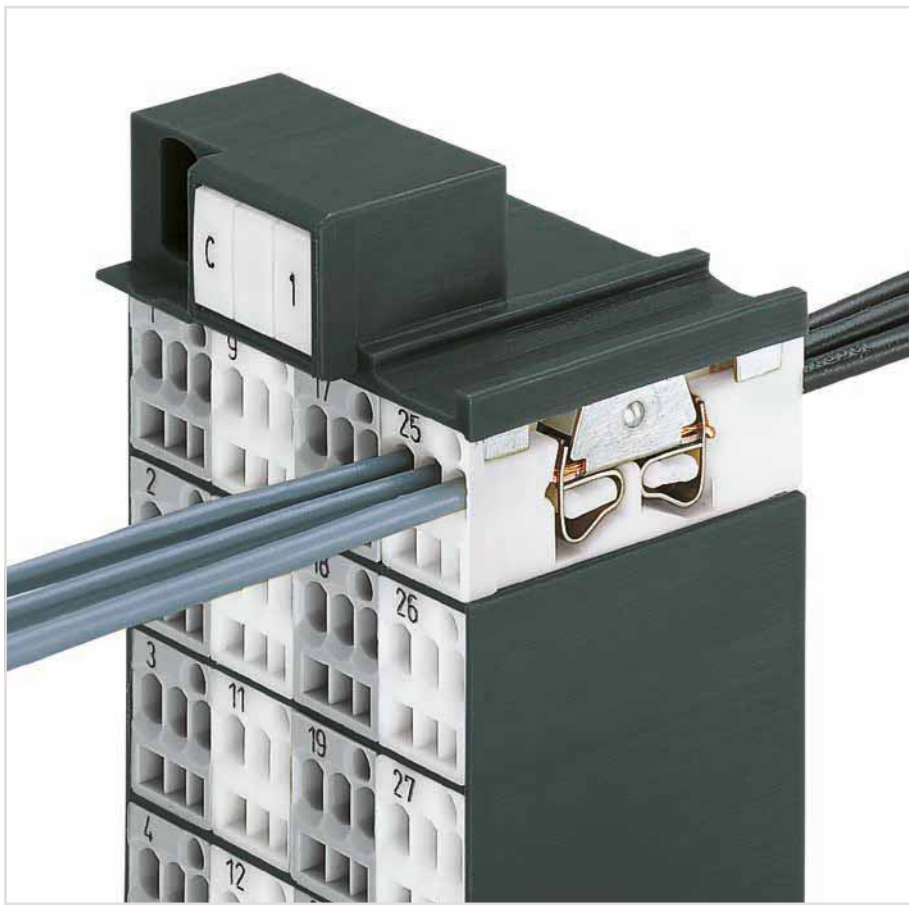

Snapping on an additional module with contact to mounting frame.



Assembling a matrix patchboard with additional module – direct connection to the mounting frame.

	Max. conductor cross section (mm <sup>2</sup> /AWG) without ferrule	Max. conductor cross section (mm <sup>2</sup> /AWG) with ferrule	
		insulated	uninsulated
Side 2	1.5	0.75 Item No./Color <b>216-202/gray</b>	1 Item No. <b>216-123</b>
Side 1	1.5	0.75 <b>216-202/gray</b>	1 <b>216-123</b>
Side 2	2.5	1.5 <b>216-204/black</b>	1.5 <b>216-104</b>
Side 1	1.5	0.75 <b>216-202/gray</b>	1 <b>216-123</b>



Terminating ferruled conductors via operating tool.

## Matrix Patchboards 726 Series

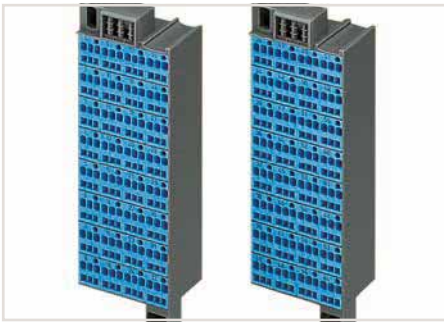

Blue matrix patchboards are suitable for Ex i applications.

Blue matrix patchboards are suitable for Ex i applications.



Matrix patchboard, dark gray frame, gray/white modules, vertical module marking on sides 1 and 2, 32-pole

	Item No.	Pack. Unit
Marking 1 ... 32	726-121	20
Marking 33 ... 64	726-122	20

Matrix patchboard, dark gray frame, blue modules, vertical module marking on sides 1 and 2, 32-pole

	Item No.	Pack. Unit
Marking 1 ... 32	726-141	20
Marking 33 ... 64	726-142	20



### Technical Data

Rated voltage (III / 3)	500 V
Rated surge voltage (III / 3)	6 kV
Rated current	10 A
Approval	300 V, 10 A  300 V, 10 A

### Connection Data

Connector (1)	Page 1
Solid conductor	0.08 ... 1.5 mm <sup>2</sup> / 28 ... 16 AWG
Fine-stranded conductor	0.08 ... 1.5 mm <sup>2</sup> / 28 ... 16 AWG
Connector (2)	Page 2
Solid conductor (2)	0.08 ... 1.5 mm <sup>2</sup> / 28 ... 16 AWG
Fine-stranded conductor (2)	0.08 ... 1.5 mm <sup>2</sup> / 28 ... 16 AWG
Strip length	8 ... 10 mm / 0.31 ... 0.39 inch

### Accessories (Selection)

	Item No.	Page
Wire commoning chain, insulated, 31 connections, I <sub>N</sub> 6 A, 50 V, 0.5 mm <sup>2</sup>	709-107	697
Group marking carrier for side 2	726-902	697
WSB Quick marking system, white, 10 strips with 10 markers per card, 5 mm markers	209-501	782
Decade marker carrier, for matrix patchboards	726-905	696

Dimensional drawing, see page 692

Accessories, see page 696

Tools, see Section 13

Appropriate marking system for matrix patchboards:  
WSB Quick Marking System, see Full Line Catalog, Volume 6

Approvals and corresponding ratings, visit [www.wago.com](http://www.wago.com)



Matrix patchboard, dark gray frame, gray/white modules, vertical module marking on sides 1 and 2, 32-pole

	Item No.	Pack. Unit
Marking 1 ... 32	726-221	20
Marking 33 ... 64	726-222	20

Matrix patchboard, dark gray frame, gray/white modules, vertical module marking on sides 1 and 2, 48-pole

	Item No.	Pack. Unit
Marking 1 ... 48	726-421	10

Matrix patchboard, dark gray frame, gray/white modules, vertical module marking on sides 1 and 2, 48-pole

	Item No.	Pack. Unit
Marking 1 ... 48	726-521	10

Matrix patchboard, dark gray frame, blue modules, vertical module marking on sides 1 and 2, 32-pole

	Item No.	Pack. Unit
Marking 1 ... 32	726-241	20
Marking 33 ... 64	726-242	20

Matrix patchboard, dark gray frame, blue modules, vertical module marking on sides 1 and 2, 48-pole

	Item No.	Pack. Unit
Marking 1 ... 48	726-441	10

Matrix patchboard, dark gray frame, blue modules, vertical module marking on sides 1 and 2, 48-pole

	Item No.	Pack. Unit
Marking 1 ... 48	726-541	10



500 V  
6 kV  
10 A  
300 V, 10 A ; 300 V, 10 A

Page 1  
0.08 ... 1.5 mm<sup>2</sup> / 28 ... 16 AWG  
0.08 ... 1.5 mm<sup>2</sup> / 28 ... 16 AWG  
Page 2  
0.08 ... 2.5 mm<sup>2</sup> / 28 ... 14 AWG  
0.08 ... 2.5 mm<sup>2</sup> / 28 ... 14 AWG  
8 ... 10 mm / 0.31 ... 0.39 inch

	Item No.	Page
gray	709-107	697
dark gray	726-902	697
plain	209-501	782
dark gray	726-905	696



500 V  
6 kV  
10 A  
300 V, 10 A ; 300 V, 10 A

Page 1  
0.08 ... 1.5 mm<sup>2</sup> / 28 ... 16 AWG  
0.08 ... 1.5 mm<sup>2</sup> / 28 ... 16 AWG  
Page 2  
0.08 ... 1.5 mm<sup>2</sup> / 28 ... 16 AWG  
0.08 ... 1.5 mm<sup>2</sup> / 28 ... 16 AWG  
8 ... 10 mm / 0.31 ... 0.39 inch

	Item No.	Page
gray	709-107	697
dark gray	726-902	697
plain	209-501	782
dark gray	726-905	696



500 V  
6 kV  
10 A  
300 V, 10 A ; 300 V, 10 A

Page 1  
0.08 ... 1.5 mm<sup>2</sup> / 28 ... 16 AWG  
0.08 ... 1.5 mm<sup>2</sup> / 28 ... 16 AWG  
Page 2  
0.08 ... 1.5 mm<sup>2</sup> / 28 ... 16 AWG  
0.08 ... 2.5 mm<sup>2</sup> / 28 ... 14 AWG  
8 ... 10 mm / 0.31 ... 0.39 inch

	Item No.	Page
gray	709-107	697
dark gray	726-902	697
plain	209-501	782
dark gray	726-905	696

## Matrix Patchboards 726 Series

Blue matrix patchboards are suitable for Ex i applications.



Matrix patchboard, dark gray frame, gray/white modules, vertical module marking on sides 1 and 2, 80-pole

	Item No.	Pack. Unit
Marking 1 ... 80	726-721	8

Matrix patchboard, dark gray frame, blue modules, vertical module marking on sides 1 and 2, 80-pole

	Item No.	Pack. Unit
Marking 1 ... 80	726-741	8

### Technical Data

Rated voltage (III / 3)	500 V
Rated surge voltage (III / 3)	6 kV
Rated current	10 A
Approval	300 V, 10 A ; 300 V, 10 A

### Connection Data

Connector (1)	Page 1
Solid conductor	0.08 ... 1.5 mm <sup>2</sup> / 28 ... 16 AWG
Fine-stranded conductor	0.08 ... 1.5 mm <sup>2</sup> / 28 ... 16 AWG
Connector (2)	Page 2
Solid conductor (2)	0.08 ... 1.5 mm <sup>2</sup> / 28 ... 16 AWG
Fine-stranded conductor (2)	0.08 ... 1.5 mm <sup>2</sup> / 28 ... 16 AWG
Strip length	8 ... 10 mm / 0.31 ... 0.39 inch

### Accessories (Selection)

Wire commoning chain, insulated, 31 connections, I <sub>N</sub> 6 A, 50 V, 0.5 mm <sup>2</sup>	gray	709-107	697
Group marking carrier for side 2	dark gray	726-902	697
WSB Quick marking system, white, 10 strips with 10 markers per card, 5 mm markers	plain	209-501	782
Decade marker carrier, for matrix patchboards	dark gray	726-905	696

500 V
6 kV
10 A
300 V, 10 A ; 300 V, 10 A

Page 1
0.08 ... 1.5 mm <sup>2</sup> / 28 ... 16 AWG
0.08 ... 1.5 mm <sup>2</sup> / 28 ... 16 AWG
Page 2
0.08 ... 1.5 mm <sup>2</sup> / 28 ... 16 AWG
0.08 ... 1.5 mm <sup>2</sup> / 28 ... 16 AWG
8 ... 10 mm / 0.31 ... 0.39 inch

	Item No.	Page
gray	709-107	697
dark gray	726-902	697
plain	209-501	782
dark gray	726-905	696

Dimensional drawing, see page 692

Accessories, see page 696

Tools, see Section 13

Appropriate marking system for matrix patchboards:  
WSB Quick Marking System, see Full Line Catalog, Volume 6

Approvals and corresponding ratings, visit [www.wago.com](http://www.wago.com)



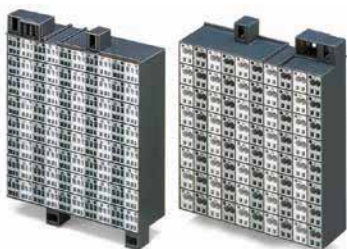

Matrix patchboard, dark gray frame, gray/white modules, vertical module marking on sides 1 and 2, 80-pole

	Item No.	Pack. Unit
Marking 1 ... 80	726-821	8



Matrix patchboard, dark gray frame, gray/white modules, vertical module marking on sides 1 and 2, for 19" racks, slimline version, 32-pole

	Item No.	Pack. Unit
Marking 1 ... 32	726-321	24
Marking 33 ... 64	726-322	24



Matrix patchboard, dark gray frame, gray/white modules, vertical module marking on sides 1 and 2, for 19" racks, mounted upside down, slimline version, 32-pole

	Item No.	Pack. Unit
Marking 1 ... 32	726-325	24
Marking 33 ... 64	726-326	24

Matrix patchboard, dark gray frame, blue modules, vertical module marking on sides 1 and 2, 80-pole

	Item No.	Pack. Unit
Marking 1 ... 80	726-841	8

Matrix patchboard, dark gray frame, blue modules, vertical module marking on sides 1 and 2, for 19" racks, slimline version, 32-pole

	Item No.	Pack. Unit
Marking 1 ... 32	726-341	24
Marking 33 ... 64	726-342	24

Matrix patchboard, dark gray frame, blue modules, vertical module marking on sides 1 and 2, for 19" racks, mounted upside down, slimline version, 32-pole

	Item No.	Pack. Unit
Marking 1 ... 32	726-345	24
Marking 33 ... 64	726-346	24



500 V
6 kV
10 A
300 V, 10 A ; 300 V, 10 A

Page 1
0.08 ... 1.5 mm <sup>2</sup> / 28 ... 16 AWG
0.08 ... 1.5 mm <sup>2</sup> / 28 ... 16 AWG
Page 2
0.08 ... 2.5 mm <sup>2</sup> / 28 ... 14 AWG
0.08 ... 2.5 mm <sup>2</sup> / 28 ... 14 AWG
8 ... 10 mm / 0.31 ... 0.39 inch

	Item No.	Page
gray	709-107	697
dark gray	726-902	697
plain	209-501	782
dark gray	726-905	696



500 V
6 kV
10 A
300 V, 10 A ; 300 V, 10 A

Page 1
0.08 ... 1.5 mm <sup>2</sup> / 28 ... 16 AWG
0.08 ... 1.5 mm <sup>2</sup> / 28 ... 16 AWG
Page 2
0.08 ... 1.5 mm <sup>2</sup> / 28 ... 16 AWG
0.08 ... 1.5 mm <sup>2</sup> / 28 ... 16 AWG
8 ... 10 mm / 0.31 ... 0.39 inch

	Item No.	Page
gray	709-107	697
dark gray	726-902	697
plain	209-501	782
dark gray	726-905	696



500 V
6 kV
10 A
300 V, 10 A ; 300 V, 10 A

Page 1
0.08 ... 1.5 mm <sup>2</sup> / 28 ... 16 AWG
0.08 ... 1.5 mm <sup>2</sup> / 28 ... 16 AWG
Page 2
0.08 ... 1.5 mm <sup>2</sup> / 28 ... 16 AWG
0.08 ... 1.5 mm <sup>2</sup> / 28 ... 16 AWG
8 ... 10 mm / 0.31 ... 0.39 inch

	Item No.	Page
gray	709-107	697
dark gray	726-902	697
plain	209-501	782
dark gray	726-905	697

## Common Potential Matrix Patchboards – Slimline Version, for 19" Racks

### 726 Series

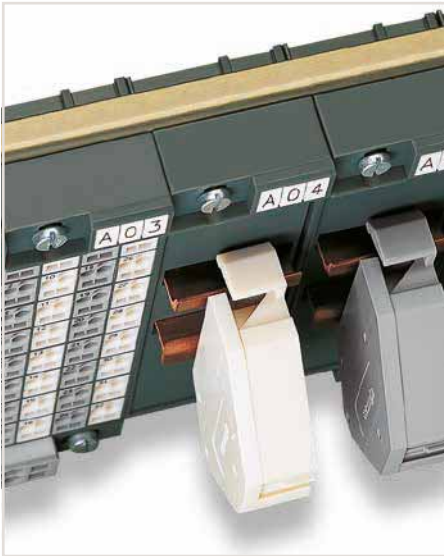

Common Potential Matrix Patchboards



Common potential matrix patchboard (white) with a supply terminal block



Common potential matrix patchboard, marking 1 ... 24, dark gray frame, gray modules, vertical module marking, with one supply terminal block incl. end plate, for 19" racks, slimline version

Item No.	Pack. Unit
726-601	10

Common potential matrix patchboard, marking 1 ... 24, dark gray frame, gray modules, vertical module marking, with two supply terminal blocks incl. end plate, for 19" racks, slimline version

Item No.	Pack. Unit
726-602	10

**UL**

#### Technical Data

Rated current	24 A
Rated current (1)	76 A
Approval	300 V, 10 A <b>UL</b>

#### Connection Data

Connector (1)	Page 1
Solid conductor	0.08 ... 2.5 mm <sup>2</sup> / 28 ... 14 AWG
Fine-stranded conductor	0.08 ... 2.5 mm <sup>2</sup> / 28 ... 14 AWG
Strip length	8 ... 10 mm / 0.31 ... 0.39 inch
Connector (2)	Page 2
Solid conductor (2)	0.2 ... 16 mm / 24 ... 6 AWG
Fine-stranded conductor (2)	0.2 ... 16 mm / 24 ... 6 AWG
Strip length (2)	16 ... 17 mm / 0.63 ... 0.67 inch

#### Accessories (Selection)

Wire commoning chain, insulated, 31 connections, I <sub>N</sub> 6 A, 50 V, 0.5 mm <sup>2</sup>	
Spare supply terminal block, 0.2 ... 16 mm <sup>2</sup> / 24 ... 6 AWG, 12 mm (0.472 inch) wide	
Group marking carrier for side 2	
WSB Quick marking system, white, 10 strips with 10 markers per card, 5 mm markers	
Decade marker carrier, for matrix patchboards	

	Item No.	Page
gray	709-107	697
gray	283-611	697
dark gray	726-902	697
plain	209-501	782
dark gray	726-905	696

Dimensional drawing, see page 693

Accessories, see page 696

Tools, see Section 13

Appropriate marking system for matrix patchboards:  
WSB Quick Marking System, see Full Line Catalog, Volume 6

Approvals and corresponding ratings, visit [www.wago.com](http://www.wago.com)



Common potential matrix patchboard, marking 1 ... 24, dark gray frame, white modules, vertical module marking, with one supply terminal block incl. end plate, for 19" racks, slimline version

Ground conductor common potential matrix patchboard, marking 1 ... 24, dark gray frame, green-yellow modules, vertical module marking, with one supply terminal block incl. end plate, for 19" racks, slimline version

Item No.	Pack. Unit
726-611	10

Item No.	Pack. Unit
726-621	10

Common potential matrix patchboard, marking 1 ... 24, dark gray frame, white modules, vertical module marking, with two supply terminal blocks incl. end plate, for 19" racks, slimline version

Ground conductor common potential matrix patchboard, marking 1 ... 24, dark gray frame, green-yellow modules, vertical module marking, with two supply terminal blocks incl. end plate, for 19" racks, slimline version

Item No.	Pack. Unit
726-612	10

Item No.	Pack. Unit
726-622	10



24 A  
76 A  
300 V, 10 A

Page 1  
0.08 ... 2.5 mm<sup>2</sup> / 28 ... 14 AWG  
0.08 ... 2.5 mm<sup>2</sup> / 28 ... 14 AWG  
8 ... 10 mm / 0.31 ... 0.39 inch  
Page 2  
0.2 ... 16 mm / 24 ... 6 AWG  
0.2 ... 16 mm / 24 ... 6 AWG  
16 ... 17 mm / 0.63 ... 0.67 inch

Page 1  
0.08 ... 2.5 mm<sup>2</sup> / 28 ... 14 AWG  
0.08 ... 2.5 mm<sup>2</sup> / 28 ... 14 AWG  
8 ... 10 mm / 0.31 ... 0.39 inch  
Page 2  
0.2 ... 16 mm / 24 ... 6 AWG  
0.2 ... 16 mm / 24 ... 6 AWG  
16 ... 17 mm / 0.63 ... 0.67 inch

	Item No.	Page
gray	709-107	697
white	283-610	697
dark gray	726-902	697
plain	209-501	782
dark gray	726-905	696

	Item No.	Page
gray	709-107	697
green-yellow	283-609	697
dark gray	726-902	697
plain	209-501	782
dark gray	726-905	696

## Common Potential Matrix Patchboards – Slimline Version, for 19" Racks, Supply Side/ Patchboard Side

### 726 Series

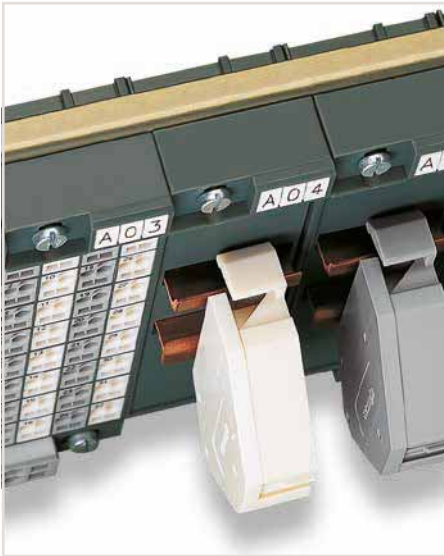

Common Potential Matrix Patchboards



Common potential matrix patchboard (white) with a supply terminal block



Common potential matrix patchboard, dark gray frame, with one supply terminal block incl. end plate, gray modules, vertical module marking, marking 1 ... 24, for 19" racks, slimline version

Item No.	Pack. Unit
726-651	10

Common potential matrix patchboard, dark gray frame, with two supply terminal blocks incl. end plate, gray modules, vertical module marking, marking 1 ... 24, for 19" racks, slimline version

Item No.	Pack. Unit
726-652	10

**UL**

#### Technical Data

Rated current	76 A
Rated current (2)	24 A
Approval	300 V, 10 A <b>UL</b>

#### Connection Data

Connector (1)	Page 1
Solid conductor	0.2 ... 16 mm / 24 ... 6 AWG
Fine-stranded conductor	0.2 ... 16 mm / 24 ... 6 AWG
Strip length	16 ... 17 mm / 0.63 ... 0.67 inch
Connector (2)	Page 2
Solid conductor (2)	0.08 ... 2.5 mm <sup>2</sup> / 28 ... 14 AWG
Fine-stranded conductor (2)	0.08 ... 2.5 mm <sup>2</sup> / 28 ... 14 AWG
Strip length (2)	8 ... 10 mm / 0.31 ... 0.39 inch

#### Accessories (Selection)

Wire commoning chain, insulated, 31 connections, I <sub>N</sub> 6 A, 50 V, 0.5 mm <sup>2</sup>	
Spare supply terminal block, 0.2 ... 16 mm <sup>2</sup> / 24 ... 6 AWG, 12 mm (0.472 inch) wide	
Group marking carrier for side 2	
WSB Quick marking system, white, 10 strips with 10 markers per card, 5 mm markers	
Decade marker carrier, for matrix patchboards	

	Item No.	Page
gray	709-107	697
gray	283-611	697
dark gray	726-902	697
plain	209-501	782
dark gray	726-905	696

 Dimensional drawing, see page 693

 Accessories, see page 696

 Tools, see Section 13

 Appropriate marking system for matrix patchboards:  
WSB Quick Marking System, see Full Line Catalog, Volume 6

 Approvals and corresponding ratings, visit [www.wago.com](http://www.wago.com)



Common potential matrix patchboard, dark gray frame, with one supply terminal block incl. end plate, white modules, vertical module marking, marking 1 ... 24, for 19" racks, slimline version

Item No.	Pack. Unit
726-661	10

Ground conductor common potential matrix patchboard, dark gray frame, with one supply terminal block incl. end plate, green-yellow modules, vertical module marking, marking 1 ... 24, for 19" racks, slimline version

Item No.	Pack. Unit
726-671	10

Common potential matrix patchboard, dark gray frame, with two supply terminal blocks incl. end plate, white modules, vertical module marking, marking 1 ... 24, for 19" racks, slimline version

Item No.	Pack. Unit
726-662	10

Ground conductor common potential matrix patchboard, dark gray frame, with two supply terminal blocks incl. end plate, green-yellow modules, vertical module marking, marking 1 ... 24, for 19" racks, slimline version

Item No.	Pack. Unit
726-672	10



76 A  
24 A  
300 V, 10 A

Page 1  
0.2 ... 16 mm / 24 ... 6 AWG  
0.2 ... 16 mm / 24 ... 6 AWG  
16 ... 17 mm / 0.63 ... 0.67 inch  
Page 2  
0.2 ... 16 mm / 24 ... 6 AWG  
0.2 ... 16 mm / 24 ... 6 AWG  
8 ... 10 mm / 0.31 ... 0.39 inch

Page 1  
0.2 ... 16 mm / 24 ... 6 AWG  
0.2 ... 16 mm / 24 ... 6 AWG  
16 ... 17 mm / 0.63 ... 0.67 inch  
Page 2  
0.2 ... 16 mm / 24 ... 6 AWG  
0.2 ... 16 mm / 24 ... 6 AWG  
8 ... 10 mm / 0.31 ... 0.39 inch

	Item No.	Page
gray	709-107	697
white	283-610	697
dark gray	726-902	697
plain	209-501	782
dark gray	726-905	696

	Item No.	Page
gray	709-107	697
green-yellow	283-609	697
dark gray	726-902	697
plain	209-501	782
dark gray	726-905	696

## Dimensional Drawings, 726 Series

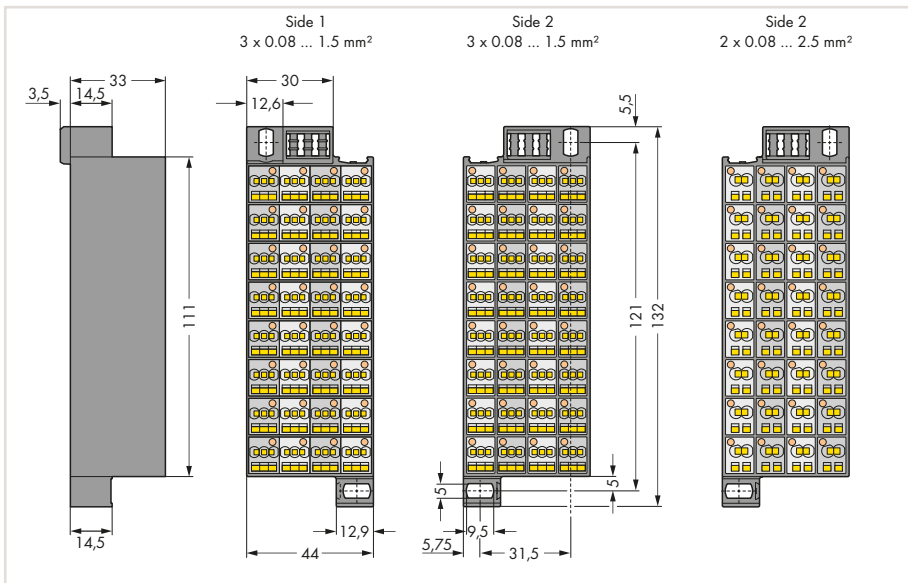

Dimensions in mm  
Matrix patchboard, 32-pole



Dimensions in mm  
Matrix patchboard, 48-pole

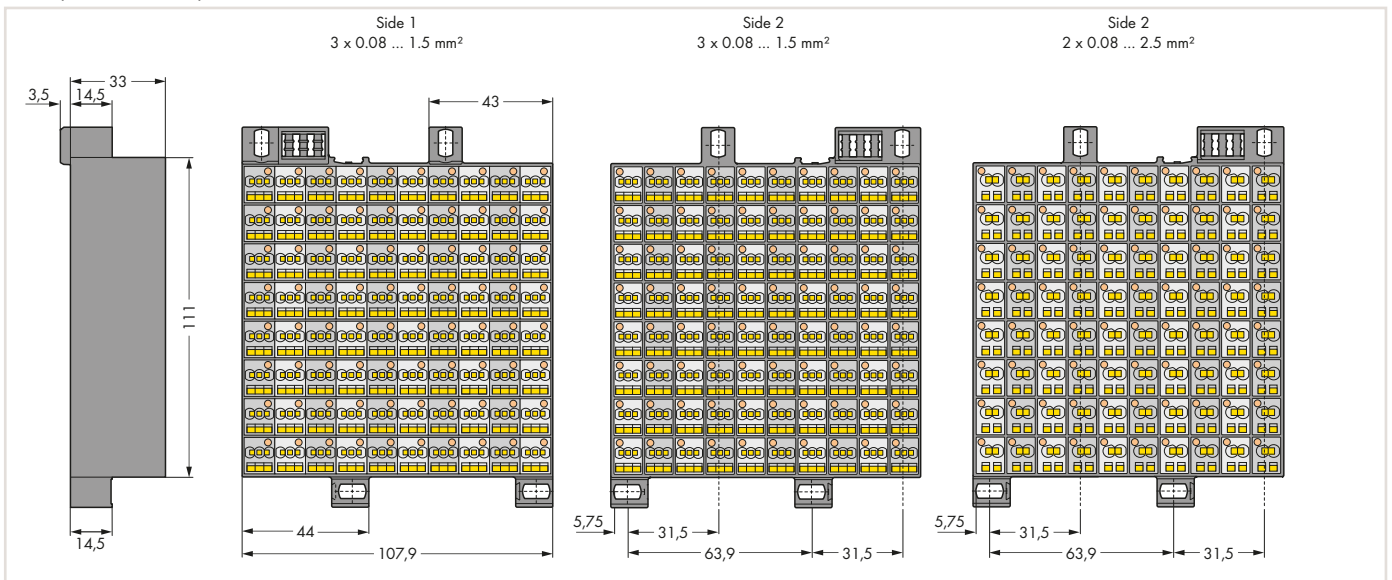

Dimensions in mm  
Matrix patchboard, 80-pole

11



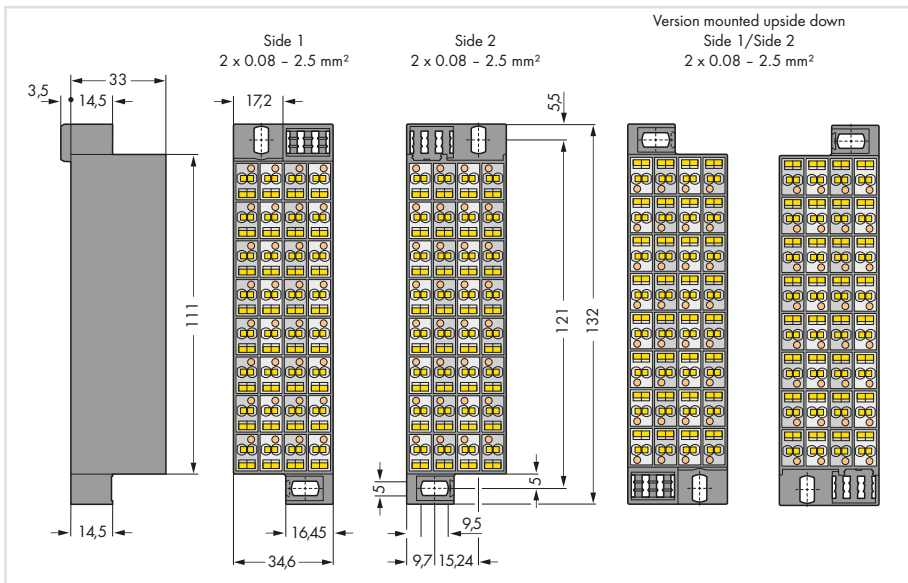

Dimensions in mm  
Matrix patchboard, 32-pole – slimline version

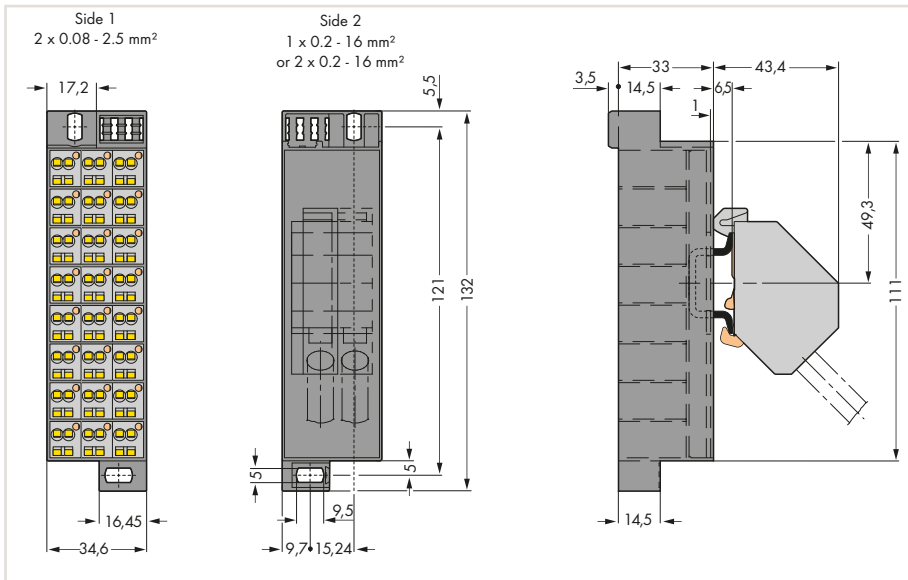

Dimensions in mm  
Common Potential Matrix Patchboards – Slimline Version, for 19" Racks

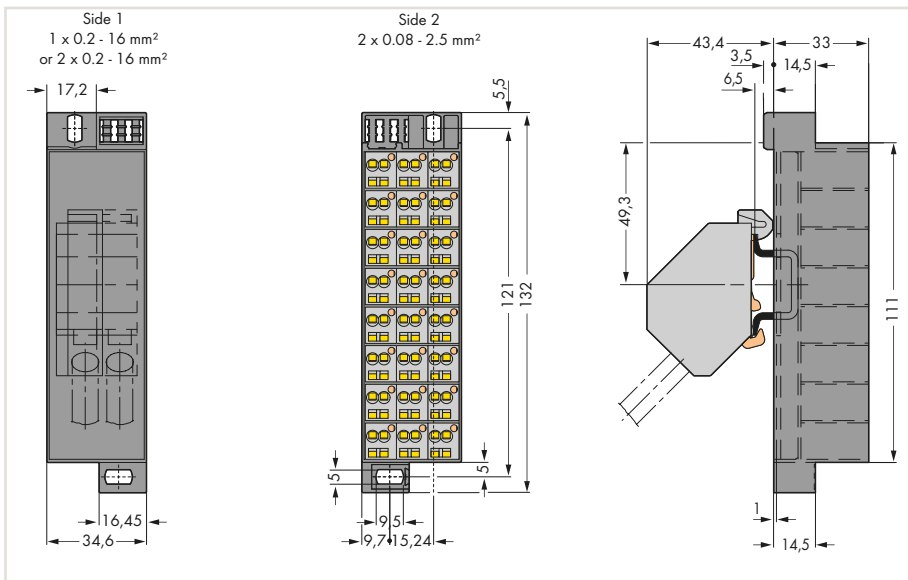

Dimensions in mm  
Common Potential Matrix Patchboards – Slimline Version, for 19" Racks, Supply Side/Patchboard Side

## Matrix Patchboard with Push-Buttons, 32-Pole – Slimline Version, for 19" Racks 726 Series



Matrix patchboard, dark gray frame, gray/white modules, vertical module marking on sides 1 and 2, for 19" racks

	Item No.	Pack. Unit
without marking	726-770	20



### Technical Data

Rated voltage (III / 3)	500 V
Rated surge voltage (III / 3)	6 kV
Rated current	10 A
Approval	300 V, 10 A

### Connection Data

Connector (1)	Page 1
Solid conductor	0.08 ... 2.5 mm <sup>2</sup> / 28 ... 14 AWG
Fine-stranded conductor	0.08 ... 2.5 mm <sup>2</sup> / 28 ... 14 AWG
Connector (2)	Page 2
Solid conductor (2)	0.08 ... 2.5 mm <sup>2</sup> / 28 ... 14 AWG
Fine-stranded conductor (2)	0.08 ... 2.5 mm <sup>2</sup> / 28 ... 14 AWG
Strip length	10 mm / 0.39 inch

### Accessories (Selection)

	Item No.	Page
Wire commoning chain, insulated, 31 connections, I <sub>N</sub> 6 A, 50 V, 0.5 mm <sup>2</sup>	709-107	697
WSB Quick marking system, white, 10 strips with 10 markers per card, 5 mm markers	209-501	782
Decade marker carrier, for matrix patchboards	726-905	696
Test probe, 2 mm Ø, min. 12 mm long, uninsulated tip, not offered by WAGO (e.g., MultiContact XPP-80/2-16)		

Dimensional drawing, see page 695

Accessories, see page 696

Tools, see Section 13

Appropriate marking system for matrix patchboards:  
WSB Quick Marking System, see Full Line Catalog, Volume 6

Approvals and corresponding ratings, visit [www.wago.com](http://www.wago.com)

## Dimensional Drawing, 726 Series

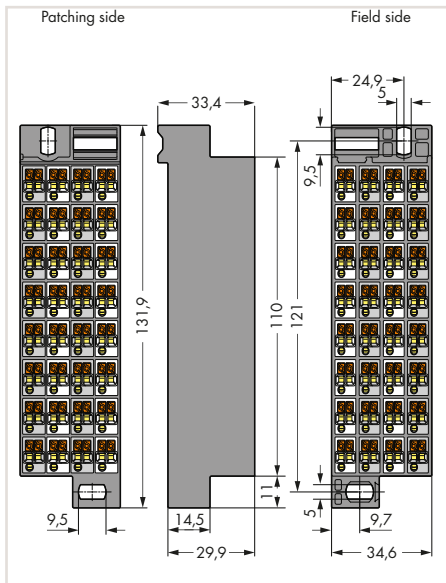

Dimensions in mm  
Matrix Patchboard with Push-Buttons, 32-Pole –  
Slimline Version, for 19" Racks

## Additional Modules, Decade Marker Carriers and Insulation Stops

### 726 Series



Additional module for matrix patchboard, for snap-on mounting to the lower mounting adapter, with CAGE CLAMP®, with contact to the mounting frame

Color	Item No.	Pack. Unit
○ white	726-903	25

Decade marker carrier, for matrix patchboards

Color	Item No.	Pack. Unit
● dark gray	726-905	10

Insulation stop, 0.08 ... 0.2 mm² "s" (0.14 mm² "f-st"), 4 x 3 pcs/strip  
Suitable for patchboard side (side 1) of 1.5 mm² matrix patchboards (front side differs from back side)

Color	Item No.	Pack. Unit
○ white	726-901	200 (25)

Additional module for matrix patchboard, for snap-on mounting to the lower mounting adapter, with CAGE CLAMP®, insulated

Color	Item No.	Pack. Unit
○ gray	726-904	25

Insulation stop, 0.25 mm² "s", 0.14 ... 0.25 mm² "f-st"), 4 x 3 pcs/strip  
Suitable for patchboard side (side 1) of 1.5 mm² matrix patchboards (front side differs from back side)

Color	Item No.	Pack. Unit
○ light gray	726-906	200 (25)

Insulation stop, 0.25 ... 0.5 mm² "s+f-st", 4 x 3 pcs/strip  
Suitable for patchboard side (side 1) of 1.5 mm² matrix patchboards (front side differs from back side)

Color	Item No.	Pack. Unit
● dark gray	726-907	200 (25)



Snapping on an additional module with contact to mounting frame.



Assembling a matrix patchboard with additional module – direct connection to the mounting frame.



Inserting an insulation stop into conductor entry holes of matrix patchboards.

11

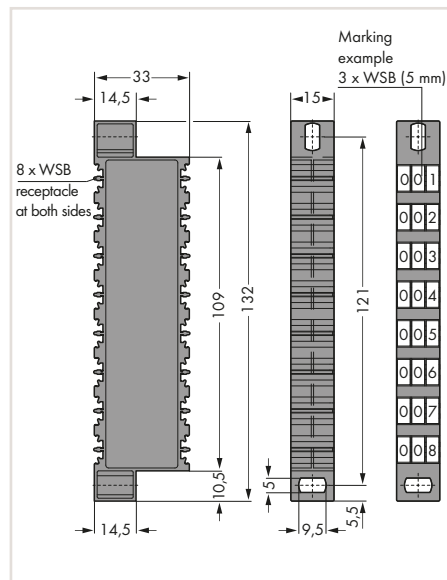
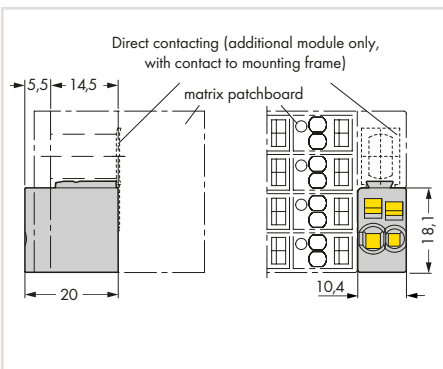

## Accessories for Matrix Patchboards, 726 Series



Wire commoning chain, insulated, 31 connections, I <sub>N</sub> 6 A, 50 V, 0.5 mm <sup>2</sup>			
Color		Item No.	Pack. Unit
gray		709-107	1



Spare supply terminal block, 0.2 ... 16 mm <sup>2</sup> / 24 ... 6 AWG, 12 mm (0.472 inch) wide			
Suitable for:	Color	Item No.	Pack. Unit
726-601	gray	283-611	25
726-651			



Spare supply terminal block, 0.2 ... 16 mm <sup>2</sup> / 24 ... 6 AWG, 12 mm (0.472 inch) wide			
Suitable for:	Color	Item No.	Pack. Unit
726-611	white	283-610	25
726-661			



Spare supply terminal block, 0.2 ... 16 mm <sup>2</sup> / 24 ... 6 AWG, 12 mm (0.472 inch) wide			
Suitable for:	Color	Item No.	Pack. Unit
726-621	green-yellow	283-609	25
726-671			



Group marking carrier for side 2			
Color		Item No.	Pack. Unit
dark gray		726-902	50



# Terminal Blocks for Matrix Patching and Common Potential Terminal Blocks, 727 Series

## Description and Installation

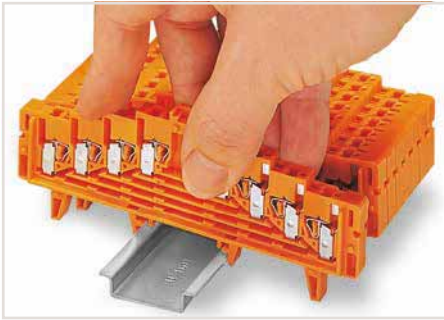

Snap individual 4- or 8-level terminal blocks onto the carrier rail.

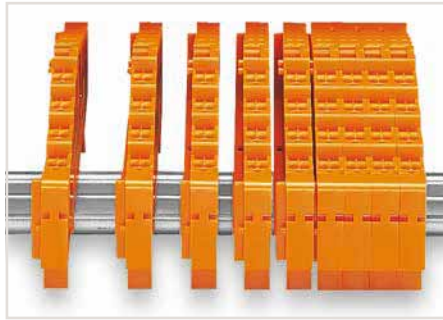

Slide terminal blocks together.

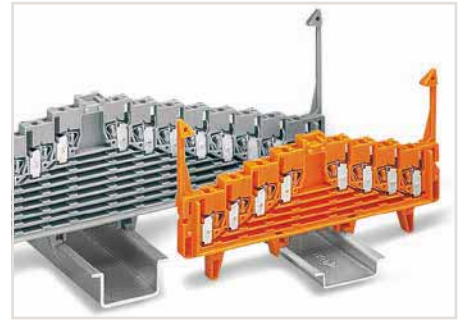

Terminal blocks for DIN 35 x 7.5 mm or DIN 35 x 15 mm rails are available.



Grip end plate at both sides and:

- push down (assembly)
- pull up (removal)

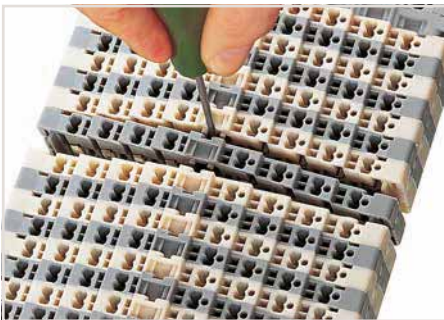

Open the assembly by laterally sliding a block via operating tool (2.5 x 0.4 mm blade).

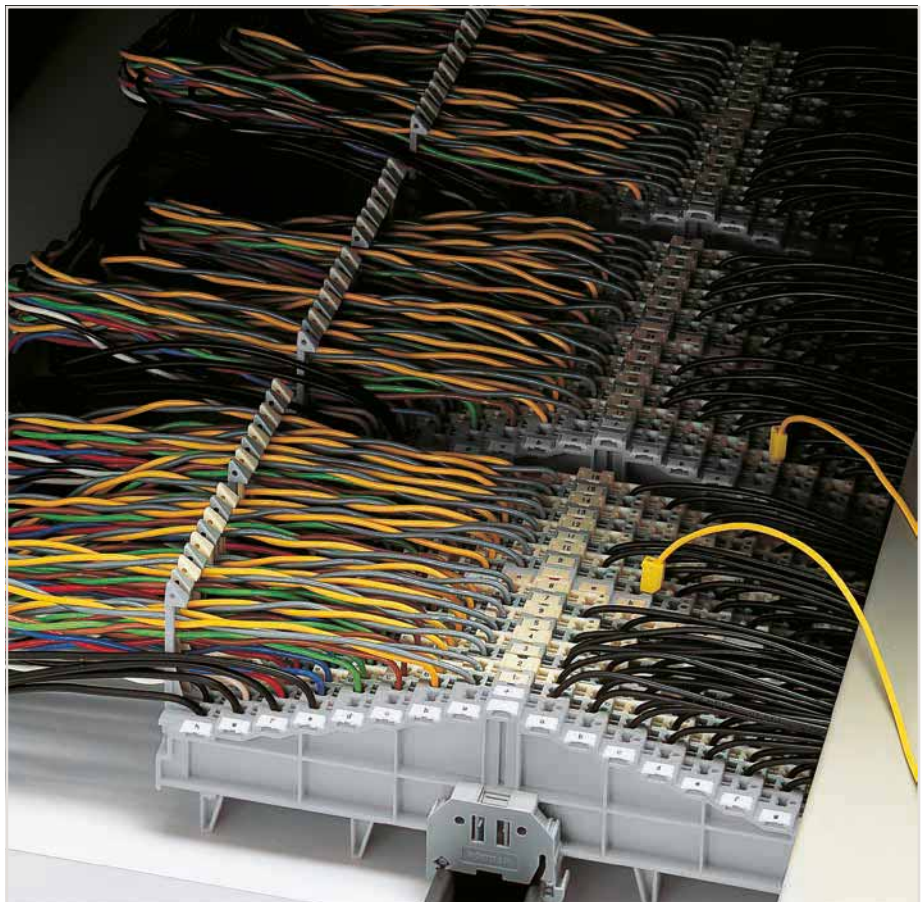

11



Slide terminal block and remove from the rail with a levering action.

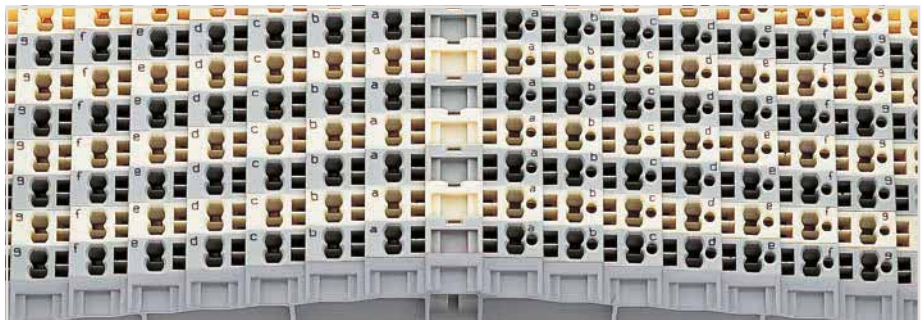

Connection points identified via factory-direct printing



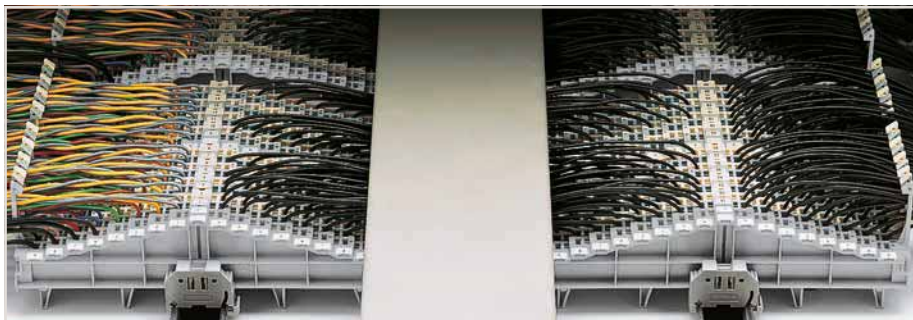

Example:  
Left: Main cables fed through locking clips on the field side  
Right: Control cables fed between locking clips  
Center: Wiring of both patching sides



Using terminal blocks with locking clips, the wiring space between the terminal strips can be covered with a wiring duct cover.

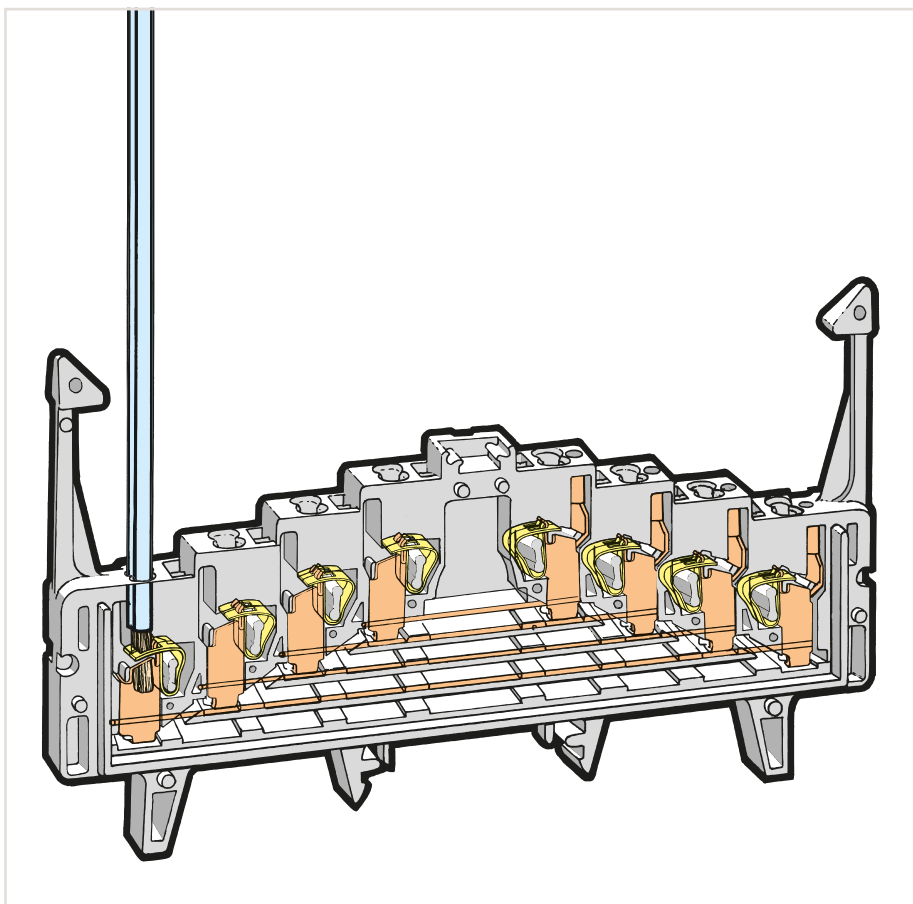

CAGE CLAMP® connection  
Inserting a conductor via 210-719 Operating Tool (2.5 x 0.4 mm blade).



Special test contact for 2.3 mm Ø test plug.



Marking coordinates via WMB Multi Marking System.

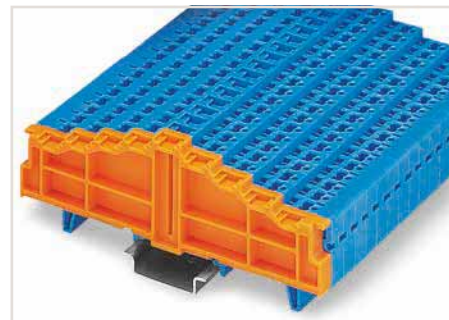

Blue terminal blocks for matrix patching are suitable for Ex i applications.

## 4-Level Terminal Blocks for Matrix Patching and Common Potential Terminal Blocks 1.5 mm<sup>2</sup>, 727 Series

Terminal blocks with a blue insulated housing are suitable for Ex i applications.  
60 V = peak value ^ (table 4, EN 50020) if approved by the works expert

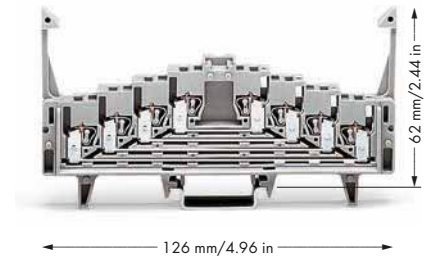

4-level terminal block for matrix patching, with locking clips, 4 x pairs of clamping units on the same level, for DIN 35 x 7.5 rail per EN 60715

Color	Item No.	Pack. Unit
○ gray	727-219	50
○ white	727-221	50
● blue	727-223	50

4-level terminal block for matrix patching, with locking clips, 4 x pairs of clamping units on the same level, for DIN 35 x 15 rail per EN 60715

Color	Item No.	Pack. Unit
○ gray	727-229	50
○ white	727-231	50
● blue	727-233	50

**UL**

### Technical Data

Rated voltage (III / 3)	250 V
Rated surge voltage (III / 3)	4 kV
Rated current	12 A
Approval	300 V, 10 A <b>UL</b> ; 300 V, 10 A <b>CE</b>

### Connection Data

Solid conductor	0.08 ... 1.5 mm <sup>2</sup> / 28 ... 16 AWG
Fine-stranded conductor	0.08 ... 1.5 mm <sup>2</sup> / 28 ... 16 AWG
Strip length	8 ... 10 mm / 0.31 ... 0.39 inch
Terminal block width	7.62 mm / 0.3 inch
Insulation material	Polyamide 66 (PA 66)

### Accessories (Selection)

Wire commoning chain, insulated, 31 connections, I <sub>N</sub> 6 A, 50 V, 0.5 mm <sup>2</sup>
4-level end plate, 7.62 mm thick, without marking
WMB Multi marking system, white, 10 strips with 10 markers per card, 5 ... 5.2 mm stretchable
Step-down test plug, from 4 mm socket to 2 mm plug
Wire harness support

	Item No.	Page
gray	709-107	704
orange	727-217	704
plain	793-5501	780
red	210-297	705
gray	249-109	705

Item no. suffixes for terminal blocks with marking:

0-1-2-3--3-2-1-0	.../021-000
a-b-c-d--d-c-b-a	.../022-000
3-2-1-0--0-1-2-3	.../023-000
d-c-b-a--a-b-c-d	.../024-000

Accessories, see page 704

Carrier rails and tools, see Section 13

Appropriate marking system: WMB see Full Line Catalog, Volume 6

Approvals and corresponding ratings, visit [www.wago.com](http://www.wago.com)

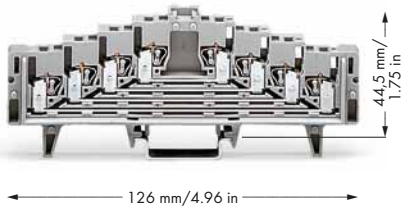

4-level terminal block for matrix patching, without locking clips, 4 x pairs of clamping units on the same level, for DIN 35 x 7.5 rail per EN 60715

Color	Item No.	Pack. Unit
○ gray	727-220	50
○ white	727-222	50
● blue	727-224	50

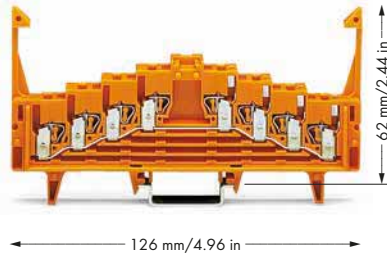

4-level common potential terminal block, with locking clips, all clamping units connected to the same current bar, for DIN 35 x 7.5 rail per EN 60715

Color	Item No.	Pack. Unit
● orange	727-225	50
○ light gray	727-227	50



4-level common potential terminal block, without locking clips, all clamping units connected to the same current bar, for DIN 35 x 7.5 rail per EN 60715

Color	Item No.	Pack. Unit
● orange	727-226	50
○ light gray	727-228	50

4-level terminal block for matrix patching, without locking clips, 4 x pairs of clamping units on the same level, for DIN 35 x 15 rail per EN 60715

Color	Item No.	Pack. Unit
○ gray	727-230	50
○ white	727-232	50
● blue	727-234	50

4-level common potential terminal block, with locking clips, all clamping units connected to the same current bar, for DIN 35 x 15 rail per EN 60715

Color	Item No.	Pack. Unit
● orange	727-235	50
○ light gray	727-237	50

4-level common potential terminal block, without locking clips, all clamping units connected to the same current bar, for DIN 35 x 15 rail per EN 60715

Color	Item No.	Pack. Unit
● orange	727-236	50
○ light gray	727-238	50



250 V  
4 kV  
12 A  
300 V, 10 A **UL**; 300 V, 10 A **CE**



250 V  
4 kV  
18 A  
300 V, 10 A **UL**; 300 V, 10 A **CE**



250 V  
4 kV  
18 A  
300 V, 10 A **UL**; 300 V, 10 A **CE**

0.08 ... 1.5 mm<sup>2</sup> / 28 ... 16 AWG  
0.08 ... 1.5 mm<sup>2</sup> / 28 ... 16 AWG  
8 ... 10 mm / 0.31 ... 0.39 inch  
7.62 mm / 0.3 inch  
Polyamide 66 (PA 66)

0.08 ... 1.5 mm<sup>2</sup> / 28 ... 16 AWG  
0.08 ... 1.5 mm<sup>2</sup> / 28 ... 16 AWG  
8 ... 10 mm / 0.31 ... 0.39 inch  
7.62 mm / 0.3 inch  
Polyamide 66 (PA 66)

0.08 ... 1.5 mm<sup>2</sup> / 28 ... 16 AWG  
0.08 ... 1.5 mm<sup>2</sup> / 28 ... 16 AWG  
8 ... 10 mm / 0.31 ... 0.39 inch  
7.62 mm / 0.3 inch  
Polyamide 66 (PA 66)

	Item No.	Page
gray	709-107	704
orange	727-217	704
plain	793-5501	780
red	210-297	705
gray	249-109	705

	Item No.	Page
gray	709-107	704
orange	727-217	704
plain	793-5501	780
red	210-297	705
gray	249-109	705

	Item No.	Page
gray	709-107	704
orange	727-217	704
plain	793-5501	780
red	210-297	705
gray	249-109	705

# 8-Level Terminal Blocks for Matrix Patching and Common Potential Terminal Blocks 1.5 mm<sup>2</sup>, 727 Series

Terminal blocks with a blue insulated housing are suitable for Ex i applications. 60 V = peak value ^ (table 4, EN 50020) if approved by the works expert

Note: Only combine terminal blocks and end plates that are colored **gray/white/light gray** or **orange/blue**!

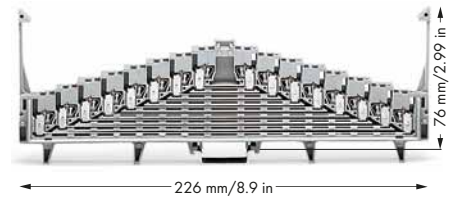

8-level terminal block for matrix patching, with locking clips, 8 x pairs of clamping units on the same level, for DIN 35 x 7.5 rail per EN 60715

Color	Item No.	Pack. Unit
○ gray	727-119	50
○ white	727-121	50
● blue	727-123	50

8-level terminal block for matrix patching, with locking clips, 8 x pairs of clamping units on the same level, for DIN 35 x 15 rail per EN 60715

Color	Item No.	Pack. Unit
○ gray	727-129	50
○ white	727-131	50
● blue	727-133	50



### Technical Data

Rated voltage (III / 3)	250 V
Rated surge voltage (III / 3)	4 kV
Rated current	12 A
Approval	300 V, 10 A ; 300 V, 10 A
<b>Connection Data</b>	
Solid conductor	0.08 ... 1.5 mm <sup>2</sup> / 28 ... 16 AWG
Fine-stranded conductor	0.08 ... 1.5 mm <sup>2</sup> / 28 ... 16 AWG
Strip length	8 ... 10 mm / 0.31 ... 0.39 inch
Terminal block width	7.62 mm / 0.3 inch
Insulation material	Polyamide 66 (PA 66)

### Accessories (Selection)

Wire commoning chain, insulated, 31 connections, I <sub>N</sub> 6 A, 50 V, 0.5 mm <sup>2</sup>
8-level end plate, 7.62 mm thick, without marking
WMB Multi marking system, white, 10 strips with 10 markers per card, 5 ... 5.2 mm stretchable
Step-down test plug, from 4 mm socket to 2 mm plug
Wire harness support

	Item No.	Page
gray	709-107	704
orange	727-117	704
plain	793-5501	780
red	210-297	705
gray	249-109	705

Item no. suffixes for terminal blocks with marking:  
 0-1-2-3-4-5-6-7--7-6-5-4-3-2-1-0 .../001-000  
 a-b-c-d-e-f-g-h--h-g-f-e-d-c-b-a .../002-000  
 7-6-5-4-3-2-1-0--0-1-2-3-4-5-6-7 .../003-000  
 h-g-f-e-d-c-b-a--a-b-c-d-e-f-g-h .../004-000

Accessories, see page 704

Carrier rails and tools, see Section 13

Appropriate marking system: WMB see Full Line Catalog, Volume 6

Approvals and corresponding ratings, visit [www.wago.com](http://www.wago.com)



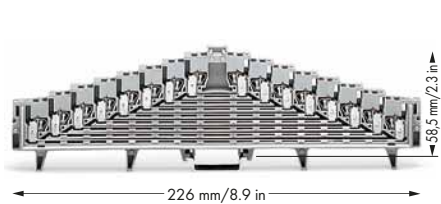

8-level terminal block for matrix patching, without locking clips, 8 x pairs of clamping units on the same level, for DIN 35 x 7.5 rail per EN 60715

Color	Item No.	Pack. Unit
○ gray	727-120	50
○ white	727-122	50
● blue	727-124	50

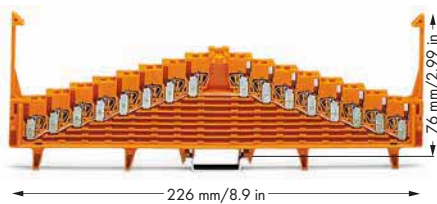

8-level common potential terminal block, with locking clips, all clamping units connected to the same current bar, for DIN 35 x 7.5 rail per EN 60715

Color	Item No.	Pack. Unit
● orange	727-125	50
○ light gray	727-127	50

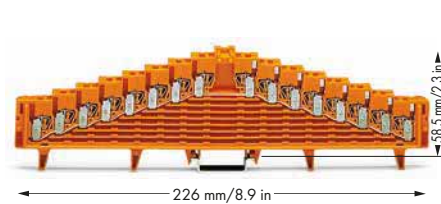

8-level common potential terminal block, without locking clips, all clamping units connected to the same current bar, for DIN 35 x 7.5 rail per EN 60715

Color	Item No.	Pack. Unit
● orange	727-126	50
○ light gray	727-128	50

8-level terminal block for matrix patching, without locking clips, 8 x pairs of clamping units on the same level, for DIN 35 x 15 rail per EN 60715

Color	Item No.	Pack. Unit
○ gray	727-130	50
○ white	727-132	50
● blue	727-134	50

8-level common potential terminal block, with locking clips, all clamping units connected to the same current bar, for DIN 35 x 15 rail per EN 60715

Color	Item No.	Pack. Unit
● orange	727-135	50
○ light gray	727-137	50

8-level common potential terminal block, without locking clips, all clamping units connected to the same current bar, for DIN 35 x 15 rail per EN 60715

Color	Item No.	Pack. Unit
● orange	727-136	50
○ light gray	727-138	50



250 V
4 kV
12 A
300 V, 10 A ; 300 V, 10 A

250 V
4 kV
18 A
300 V, 10 A ; 300 V, 10 A

250 V
4 kV
18 A
300 V, 10 A ; 300 V, 10 A

0.08 ... 1.5 mm <sup>2</sup> / 28 ... 16 AWG
0.08 ... 1.5 mm <sup>2</sup> / 28 ... 16 AWG
8 ... 10 mm / 0.31 ... 0.39 inch
7.62 mm / 0.3 inch
Polyamide 66 (PA 66)

0.08 ... 1.5 mm <sup>2</sup> / 28 ... 16 AWG
0.08 ... 1.5 mm <sup>2</sup> / 28 ... 16 AWG
8 ... 10 mm / 0.31 ... 0.39 inch
7.62 mm / 0.3 inch
Polyamide 66 (PA 66)

0.08 ... 1.5 mm <sup>2</sup> / 28 ... 16 AWG
0.08 ... 1.5 mm <sup>2</sup> / 28 ... 16 AWG
8 ... 10 mm / 0.31 ... 0.39 inch
7.62 mm / 0.3 inch
Polyamide 66 (PA 66)

	Item No.	Page
gray	709-107	704
orange	727-117	704
plain	793-5501	780
red	210-297	705
gray	249-109	705

	Item No.	Page
gray	709-107	704
orange	727-117	704
plain	793-5501	780
red	210-297	705
gray	249-109	705

	Item No.	Page
gray	709-107	704
orange	727-117	704
plain	793-5501	780
red	210-297	705
gray	249-109	705

## Accessories for 727 Series Terminal Blocks for Matrix Patching and Common Potential Terminal Blocks



Wire commoning chain, insulated, 31 connections, I <sub>N</sub> 6 A, 50 V, 0.5 mm <sup>2</sup>			
Color		Item No.	Pack. Unit
gray		709-107	1



4-level end plate, 7.62 mm thick, without marking			
Suitable for:	Color	Item No.	Pack. Unit
727-219	orange	727-217	25
727-225			



4-level end plate, 7.62 mm thick, marking: 0-1-2-3--3-2-1-0			
Suitable for:	Color	Item No.	Pack. Unit
727-219	orange	727-205	25
727-225			



4-level end plate, 7.62 mm thick, marking: a-b-c-d--d-c-b-a			
Suitable for:	Color	Item No.	Pack. Unit
727-219	orange	727-206	25
727-225			



4-level end plate, 7.62 mm thick, marking: 3-2-1-0--0-1-2-3			
Suitable for:	Color	Item No.	Pack. Unit
727-219	orange	727-207	25
727-225			



4-level end plate, 7.62 mm thick, marking: d-c-b-a--a-b-c-d			
Suitable for:	Color	Item No.	Pack. Unit
727-219	orange	727-208	25
727-225			



8-level end plate, 7.62 mm thick, without marking			
Suitable for:	Color	Item No.	Pack. Unit
727-119	orange	727-117	25
727-125	gray	727-113	25
	blue	727-114	25
	white	727-115	25
	light gray	727-116	25



8-level end plate, 7.62 mm thick, marking: 0-1-2-3-4-5-6-7--7-6-5-4-3-2-1-0			
Suitable for:	Color	Item No.	Pack. Unit
727-119	orange	727-105	25
727-125	gray	727-155	25
	blue	727-159	25
	white	727-163	25
	light gray	727-167	25



8-level end plate, 7.62 mm thick, marking: a-b-c-d-e-f-g-h--h-g-f-e-d-c-b-a			
Suitable for:	Color	Item No.	Pack. Unit
727-119	orange	727-106	25
727-125	gray	727-156	25
	blue	727-160	25
	white	727-164	25
	light gray	727-168	25



8-level end plate, 7.62 mm thick, marking: 7-6-5-4-3-2-1-0--0-1-2-3-4-5-6-7			
Suitable for:	Color	Item No.	Pack. Unit
727-119	orange	727-107	25
727-125	gray	727-157	25
	blue	727-161	25
	white	727-165	25
	light gray	727-169	25



## Accessories for 727 Series Terminal Blocks for Matrix Patching and Common Potential Terminal Blocks



8-level end plate, 7.62 mm thick, marking: h-g-f-e-d-c-b-a--a-b-c-d-e-f-g-h			
Suitable for:	Color	Item No.	Pack. Unit
727-119	orange	727-108	25
727-125	gray	727-158	25
	blue	727-162	25
	white	727-166	25
	light gray	727-170	25



Wire harness support		
Color	Item No.	Pack. Unit
gray	249-109	50



Measurement range category	CAT I
Test voltage (AC)	30 V
Test voltage (DC)	60 V
Test current	10 A



Step-down test plug, from 4 mm socket to 2 mm plug		
Color	Item No.	Pack. Unit
red	210-297	100 (25)



Insulation stop, 0.08 ... 0.2 mm <sup>2</sup> "s" (0.14 mm <sup>2</sup> "f-st"), 8 pcs/strip		
Color	Item No.	Pack. Unit
white	727-197	200 (25)



Insulation stop, 0.25 mm <sup>2</sup> "s", 0.14 ... 0.25 mm <sup>2</sup> "f-st"), 8 pcs/strip		
Color	Item No.	Pack. Unit
white	727-198	200 (25)

Insulation stop, 0.25 ... 0.5 mm <sup>2</sup> "s+f-st", 8 pcs/strip		
Color	Item No.	Pack. Unit
white	727-199	200 (25)

## Terminal Blocks for Matrix Patching, 280 Series Description and Installation

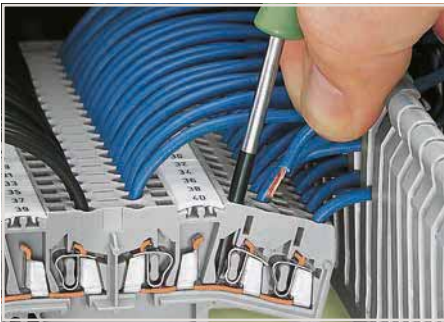

Terminal blocks for matrix patching:  
Inserting/removing a conductor on the terminal block's side-entry.  
With ferruled conductors, it is necessary to use a terminal block one size smaller than the conductor's nominal cross section.

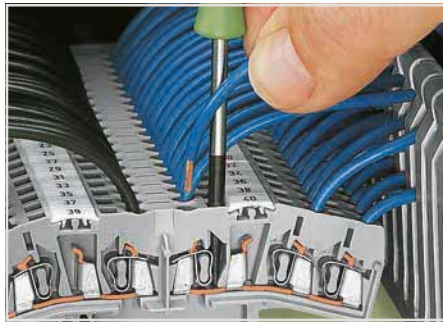

Terminal blocks for matrix patching:  
Inserting/removing a conductor in the terminal block's center.



Using terminal blocks for matrix patching as disconnect terminal blocks via disconnect jumpers.

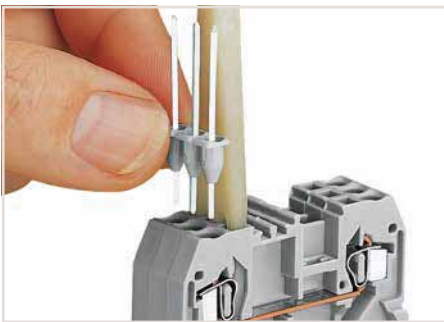

Inserting a pin module into 280 Series blocks.

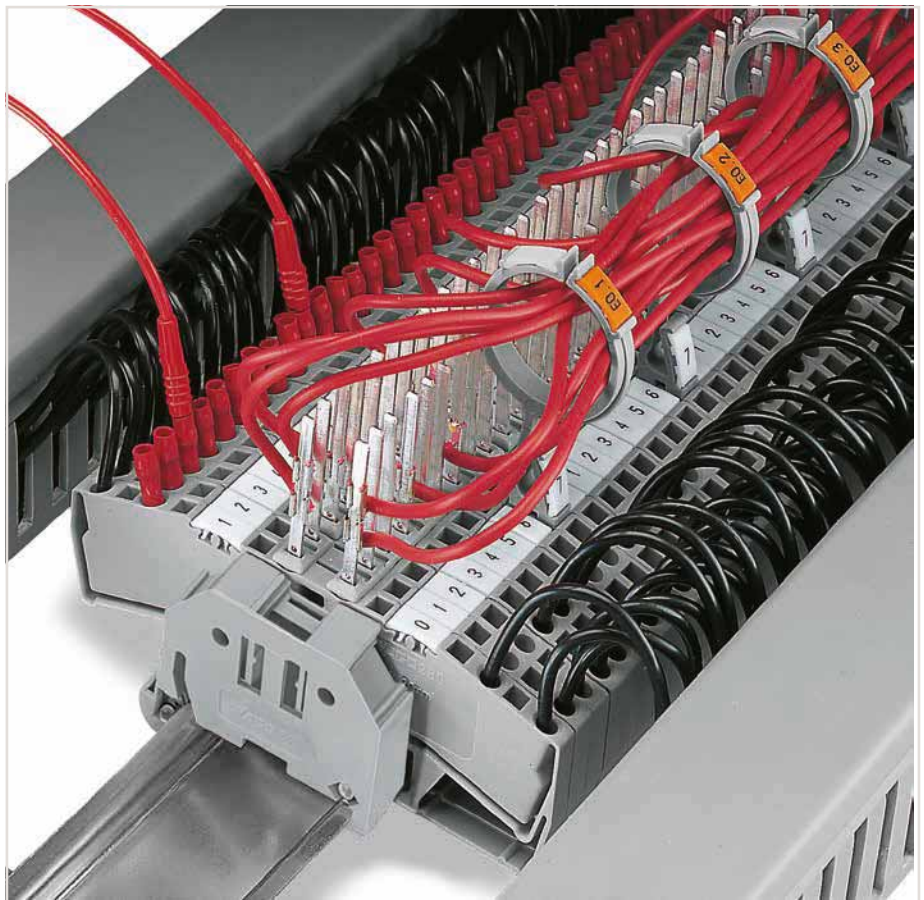

Multiplying potentials via 10-way comb-style jumper bar.  
(only possible in the terminal block's center)

11



Clipping a wire harness support into the marker slot.



Inserting a cable into the wire harness support.

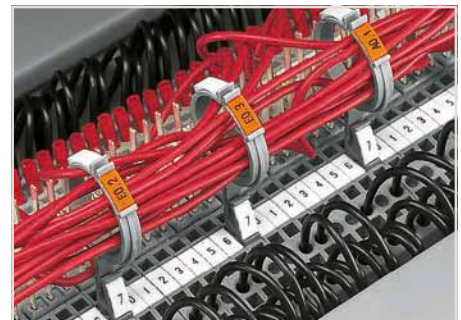

2 x group marking on top  
1 x terminal block marking at the bottom

## Terminal Blocks for Matrix Patching

### 2.5 mm<sup>2</sup>, 280 Series

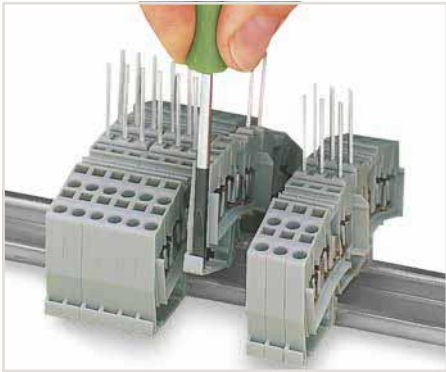

Please note that due to the protruding rods, the terminal blocks can only be inserted or removed from the assembly after sliding adjacent terminal blocks on the rail.

Removal: Separate terminal strip, slide terminal block to disconnect and then remove from the carrier rail.

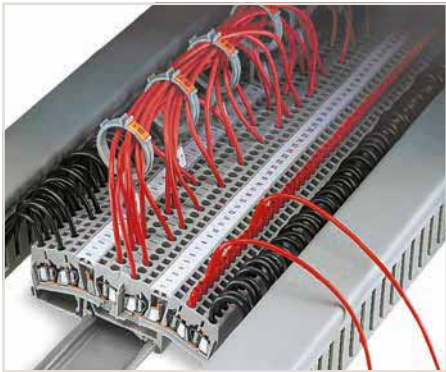

#### Terminal blocks for matrix patching with wire harness supports:

For 5 mm wide double-potential terminal blocks, two 3-conductor through terminal blocks are offered in one insulating housing on one level. This achieves a width of just 2.5 mm versus standard through terminal blocks. On each side of the terminal block are marker slots for WAGO WMB Inline markers. Via the available accessories, these terminal blocks can also be used as 4-conductor disconnect terminal blocks or potential multipliers.

The WAGO wire harness supports are pushed into the terminal blocks (approx. every 8th unit) to form an additional "cable-duct" above the wiring level of the terminal blocks. The two marker slots on the top may be used for group marking, while the lower slot is used for marking the terminal block.

In measurement and control technology, matrix patchboards are essential for process automation systems. Particularly beneficial to these applications is the use of the WAGO wire harness support, which simplifies wiring.

WAGO's 280 Series 3-Conductor Double-Potential Terminal Blocks (with or without the addition of Wire-Wrap® or TERMI-POINT® pins) are also ideal for this type of application. They can be used for connecting peripheral field devices (e.g. measuring and control equipment) to process control systems (e.g., panels, cabinets) via matrix connections.

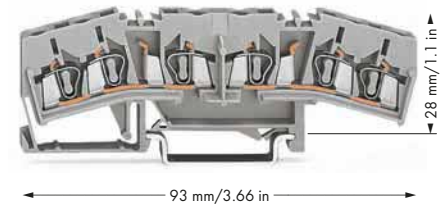

3-conductor double-potential terminal block or terminal block for matrix patching

Color	Item No.	Pack. Unit
gray	280-675	50



#### Technical Data

Rated voltage (III / 3)	800 V
Rated surge voltage (III / 3)	8 kV
Rated current	18 A
Approval	600 V, 10 A

#### Connection Data

Solid conductor	0.08 ... 2.5 mm / 28 ... 12 AWG
Fine-stranded conductor	0.08 ... 2.5 mm / 28 ... 12 AWG
Note (conductor cross section)	12 AWG: THHN, THWN
Strip length	8 ... 9 mm / 0.31 ... 0.35 in.
Terminal block width	5 mm / 0.197 inch
Insulation material	Polyamide 66 (PA 66)

#### Note

500 V/6 kV/3 between current bars (if used as disconnect terminal block or potential multiplier)  
Notice: This 3-conductor double-potential terminal block cannot be commoned via adjacent jumpers.

#### Accessories (Selection)

Comb-style jumper bar, insulated, I <sub>N</sub> = I <sub>N</sub> of terminal block, gray
Disconnect jumper, with pull-tab, I <sub>N</sub> = I <sub>N</sub> of terminal block, orange
End and intermediate plate, 5 mm thick
WMB Inline, plain, 1,500 WMB markers (5 mm) per reel, 5 ... 5.2 mm stretchable
Pin module, 2-pole, for self-assembly on all 280 Series front-entry rail-mount terminal blocks, 1 x 1 mm

	Item No.	Page
2-pole	280-482	708
2-pole	280-494	708
orange	280-333	708
white	2009-115	780
	280-477	708

Accessories (comb-style jumper bars, end plates, etc.), see page 708

Carrier rails and tools, see Section 13

Appropriate marking system: WMB/WMB Inline, see Full Line Catalog, Volume 6

Approvals and corresponding ratings, visit [www.wago.com](http://www.wago.com)



## Accessories, 280 Series

### Commoning, Mounting, Marking and Testing



 Comb-style jumper bars, see page 706

Comb-style jumper bar, insulated,  $I_N = I_N$  of terminal block, gray

	Item No.	Pack. Unit
2-pole	280-482	200 (25)
3-way	280-483	200 (25)
4-way	280-484	200 (25)
5-way	280-485	100 (25)
10-way	280-490	50 (25)



Alternate comb-style jumper bar, insulated,  $I_N = I_N$  of terminal block, gray

	Item No.	Pack. Unit
2-pole	280-492	200 (25)



Disconnect jumper, with pull-tab,  $I_N = I_N$  of terminal block, orange

	Item No.	Pack. Unit
2-pole	280-494	200 (25)



Operating tool, insulated

	Item No.	Pack. Unit
2-pole	280-432	1
3-way	280-433	1
10-way	280-440	1



End and intermediate plate, 5 mm thick

Color	Item No.	Pack. Unit
orange	280-333	25
gray	280-325	25

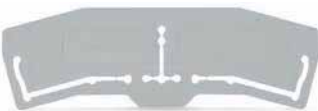

Separator, 3 mm oversized, 1 mm thick

Color	Item No.	Pack. Unit
gray	280-394	100 (25)
orange	280-395	100 (25)



Pin module, 2-pole, for self-assembly on all 280 Series front-entry rail-mount terminal blocks, 1 x 1 mm

	Item No.	Pack. Unit
	280-477	100



Pin module, 2-pole, for self-assembly on all 280 Series front-entry rail-mount terminal blocks, 0.8 x 1.6 mm

	Item No.	Pack. Unit
	280-475	100



Pin module, 2-pole, for self-assembly on all 280 Series front-entry rail-mount terminal blocks, 0.8 x 2.4 mm

	Item No.	Pack. Unit
	280-473	100



Pin module, 3-pole, for self-assembly on all 280 Series front-entry rail-mount terminal blocks, 1 x 1 mm

	Item No.	Pack. Unit
	280-478	100



Pin module, 3-pole, for self-assembly on all 280 Series front-entry rail-mount terminal blocks, 0.8 x 1.6 mm

	Item No.	Pack. Unit
	280-476	100

## Accessories, 280 Series

### Commoning, Mounting, Marking and Testing



Pin module, 3-pole, for self-assembly on all 280 Series front-entry rail-mount terminal blocks, 0.8 x 2.4 mm		
	Item No.	Pack. Unit
	280-474	100



Wire harness support		
Color	Item No.	Pack. Unit
gray	249-109	50

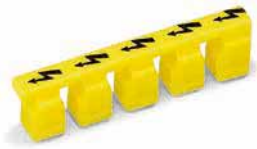

Protective warning marker, with black high-voltage symbol, for 5 terminal blocks		
Color	Item No.	Pack. Unit
yellow	280-415	100 (25)



Insulation stop, 5 pcs/strip, 0.08 ... 0.2 mm <sup>2</sup> "s" (0.14 mm <sup>2</sup> "f-st")		
Color	Item No.	Pack. Unit
white	280-470	200 (25)



Insulation stop, 5 pcs/strip, 0.25 ... 0.5 mm <sup>2</sup>		
Color	Item No.	Pack. Unit
light gray	280-471	200 (25)



Insulation stop, 5 pcs/strip, 0.75 ... 1 mm <sup>2</sup>		
Color	Item No.	Pack. Unit
dark gray	280-472	200 (25)

## Busbar Terminal Blocks, 812 Series Description and Installation



Snapping a ground busbar terminal block onto the N-busbar.



Unlock right and left positions to remove the ground busbar terminal block. Then pull up the block from the busbar.

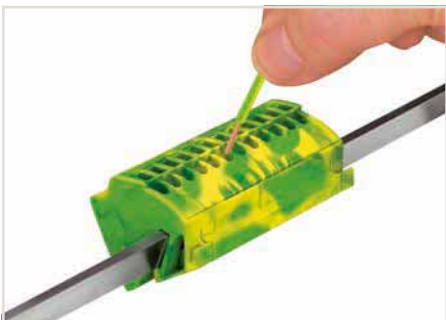

Conductor termination (4 mm<sup>2</sup>/12 AWG):  
With Push-in CAGE CLAMP®, solid conductors can be terminated by simply pushing them into the 12 x 4 mm<sup>2</sup> busbar terminal block, significantly reducing wiring time.

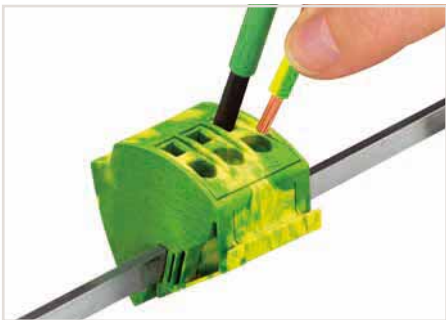

Conductor termination (16 mm<sup>2</sup>/6 AWG):  
Open the clamping unit with an operating tool when terminating solid, stranded and fine-stranded conductors.

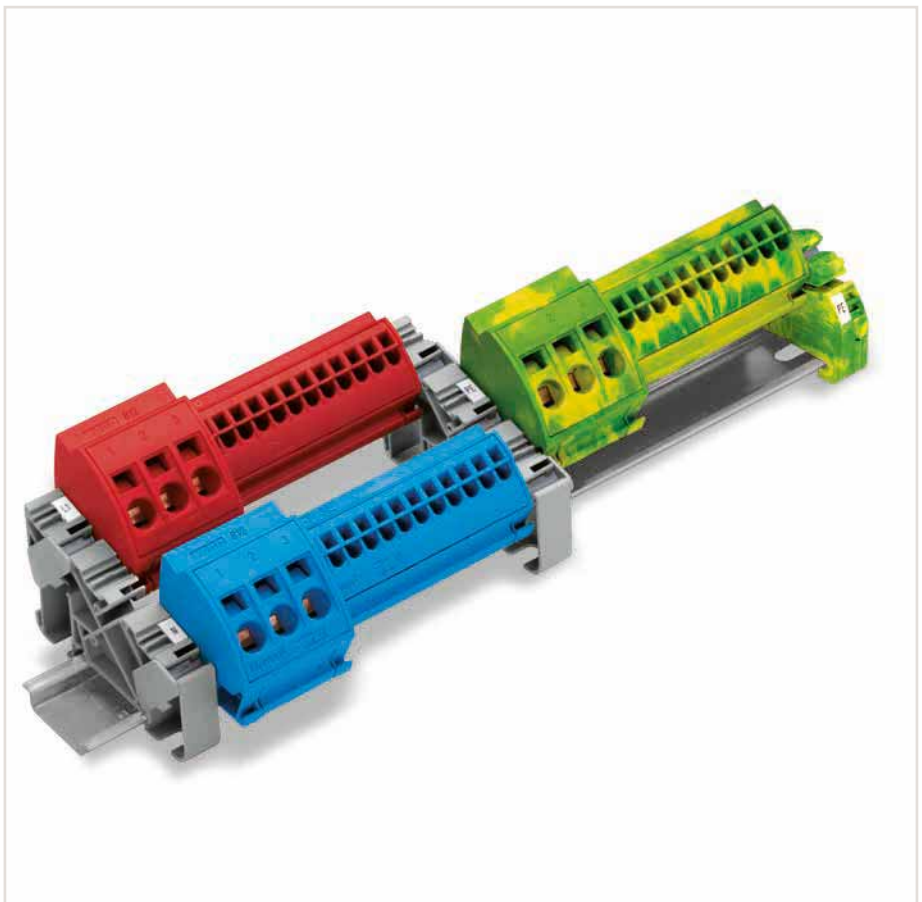

Mixed 4 mm<sup>2</sup> (AWG 12) and 16 mm<sup>2</sup> (AWG 6) busbar terminal blocks

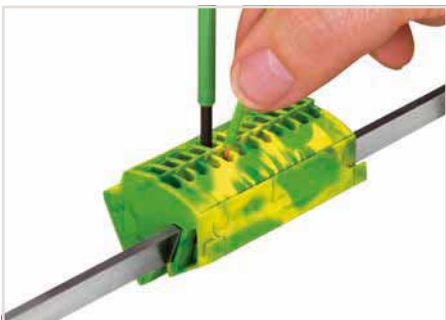

Conductor removal (4 mm<sup>2</sup>/12 AWG and 16 mm<sup>2</sup>/6 AWG):  
Open the clamping unit using an operating tool.

11



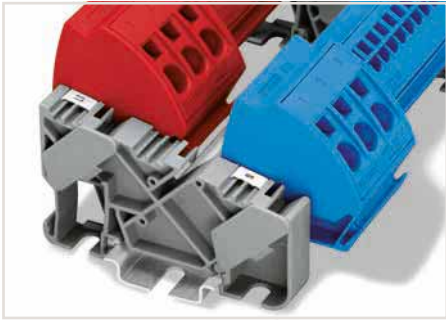

**Busbar carrier (812-140):**  
Offers three receptacles for (10 x 3) mm busbars with locking device for easy mounting of the busbars. The carrier can be snapped onto the DIN-35 rail or screwed on a panel.



**Ground busbar carrier (812-141):**  
Offers a receptacle with locking device for (10 x 3) mm busbar. Contact between the busbar and rail is made automatically by simply snapping the carrier onto the DIN-35 rail. One end of the busbar is mounted onto the ground busbar carrier, the other end is inserted into the middle position of the insulated busbar carrier.

## Busbar Terminal Blocks

### 4 mm<sup>2</sup> and 16 mm<sup>2</sup>, 812 Series



Busbar terminal block (4 mm<sup>2</sup>/12 AWG), with Push-in CAGE CLAMP®

Color	Item No.	Pack. Unit
● blue	812-104	10
○ light gray	812-101	10
● dark gray	812-102	10
● red	812-103	10



#### Technical Data

Rated voltage (III / 3)	1000 V
Rated surge voltage (III / 3)	6 kV
Rated current	96 A
Approval	600 V, 20 A ; 600 V, 95 A

#### Connection Data

Solid conductor	0.5 ... 4 mm / 20 ... 12 AWG
Stranded conductor	0.5 ... 4 mm / 20 ... 12 AWG
Fine-stranded conductor	0.5 ... 4 mm / 20 ... 12 AWG
Solid conductor, push-in termination	0.5 ... 4 mm / 20 ... 12 AWG
Strip length	11 mm / 0.43 inch
Terminal block width	75 mm / 2.953 inch
Insulation material	Polyamide 66 (PA 66)

#### Note

Current carrying capacity: With a maximum total current of 96 A, the clamping units of the busbar terminal block can be loaded with the rated current of the conductor cross-sections approved. This only applies when (10 x 3) mm busbars are used.

#### Accessories (Selection)

Straight busbar, tin-plated, 1000 mm long, copper (10 x 3) mm, I <sub>N</sub> 140 A	
Finger guard, touch-proof cover protects unused conductor entries	
Insulated busbar carrier	
Ground busbar carrier, with DIN-35 rail contact	

	Item No.	Page
	210-133	715
gray	812-140	714

Using the 812 Series Busbar Terminal Blocks in switchgear cabinets and distribution boards permits simple and safe potential distribution on standard (10 x 3) mm busbars. Tool-free snapping of self-locking busbar terminal blocks onto the busbar enables quick and easy assembly, as well as subsequent extension. The busbar terminal blocks are available in two different versions for conductors ranging from 1.5–16 mm<sup>2</sup> (16–6 AWG).

Accessories, see page 714

Approvals and corresponding ratings, visit [www.wago.com](http://www.wago.com)

**PUSH-IN CAGE CLAMP® / CAGE CLAMP®**

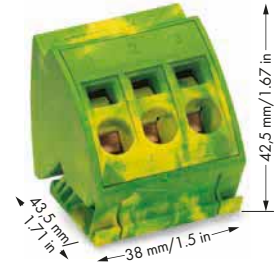
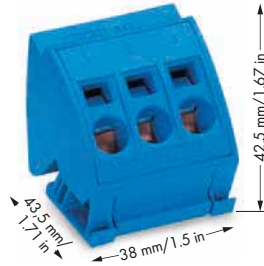
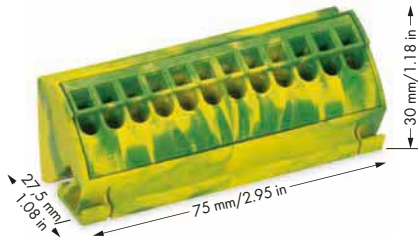

Ground busbar terminal block (4 mm <sup>2</sup> /12 AWG), with Push-in CAGE CLAMP®		
Color	Item No.	Pack. Unit
● green-yellow	812-100	10

Busbar terminal block (16 mm <sup>2</sup> /6 AWG), with CAGE CLAMP®		
Color	Item No.	Pack. Unit
● blue	812-114	12
○ light gray	812-111	12
● dark gray	812-112	12
● red	812-113	12

Ground busbar terminal block (16 mm <sup>2</sup> /6 AWG), with CAGE CLAMP®		
Color	Item No.	Pack. Unit
● green-yellow	812-110	12



1000 V
6 kV
96 A
600 V, 20 A ; 600 V, 95 A
1.5 ... 16 mm / 14 ... 6 AWG
1.5 ... 16 mm / 14 ... 6 AWG
1.5 ... 16 mm / 14 ... 6 AWG
1.5 ... 16 mm / 14 ... 6 AWG
11 mm / 0.43 inch
75 mm / 2.953 inch
Polyamide 66 (PA 66)

1000 V
6 kV
96 A
600 V, 20 A ; 600 V, 95 A
1.5 ... 16 mm / 14 ... 6 AWG
1.5 ... 16 mm / 14 ... 6 AWG
12 mm / 0.47 inch
38 mm / 1.496 inch
Polyamide 66 (PA 66)

1000 V
6 kV
96 A
600 V, 20 A ; 600 V, 95 A
1.5 ... 16 mm / 14 ... 6 AWG
1.5 ... 16 mm / 14 ... 6 AWG
12 mm / 0.47 inch
38 mm / 1.496 inch
Polyamide 66 (PA 66)

Current carrying capacity: With a maximum total current of 96 A, the clamping units of the busbar terminal block can be loaded with the rated current of the conductor cross-sections approved. This only applies when (10 x 3) mm busbars are used.

	Item No.	Page
	210-133	715
gray	812-140	714

	Item No.	Page
	210-133	715
yellow	284-400	715
green-yellow	812-141	714

	Item No.	Page
	210-133	715
yellow	284-400	715
green-yellow	812-141	714

## Insulated Busbar Carrier 812 Series

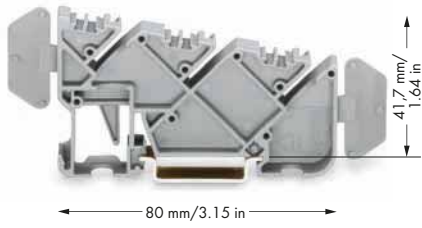

Insulated busbar carrier Width 12 mm		
Color	Item No.	Pack. Unit
● gray	812-140	25

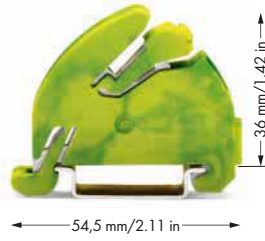

Ground busbar carrier, with DIN-35 rail contact Width 11 mm		
Color	Item No.	Pack. Unit
● green-yellow	812-141	25

## Accessories for 812 Series Busbar Terminal Blocks



Straight busbar, tin-plated, 1000 mm long, copper (10 x 3) mm, I <sub>N</sub> 140 A		
	Item No.	Pack. Unit
	210-133	1



Finger guard, touch-proof cover protects unused conductor entries		
Color	Item No.	Pack. Unit
yellow	284-400	100 (25)



## Lighting Connectors, Junction Box and Splicing Connectors



## Lighting Connectors, PUSH WIRE® Connectors for Junction Boxes, Lever-Actuated Splicing Connectors for All Conductor Types

			Page
	<b>COMPACT PUSH WIRE® Connectors for Junction Boxes</b> 2.5 mm <sup>2</sup> (14 AWG)	2273 Series	720
	<b>CLASSIC PUSH WIRE® Connectors for Junction Boxes</b> 1.5 mm <sup>2</sup> (16 AWG) and 2.5 mm <sup>2</sup> (12 AWG)	273 Series	726
	<b>PUSH WIRE® Connectors for Junction Boxes</b> 4 mm <sup>2</sup> and 6 mm <sup>2</sup> (10 AWG)	773 Series	732
	<b>Ex PUSH WIRE® Connectors for Junction Boxes</b> 2.5 mm <sup>2</sup> (12 AWG) and 6 mm <sup>2</sup> (10 AWG)	773 Series	736
	<b>MICRO PUSH WIRE® Connectors for Junction Boxes</b> 0.8 mm Ø (20 AWG)	243 Series	742
	<b>COMPACT Splicing Connectors for All Conductor Types</b> 4 mm <sup>2</sup> (12 AWG)	221 Series	749
	<b>CLASSIC Splicing Connectors for All Conductor Types</b> 2.5 mm <sup>2</sup> (14 AWG)	222 Series	753
	Vario-T-Boxx	887 Series	755
	<b>Lighting and "Service" Connectors</b> 2.5 mm <sup>2</sup> (14 AWG)	224 Series	758
	<b>Luminaire Disconnect Connectors</b> 12 AWG	873 Series	760

# COMPACT PUSH WIRE® Connectors for Junction Boxes and Solid Conductors, 2273 Series

## Description and Installation

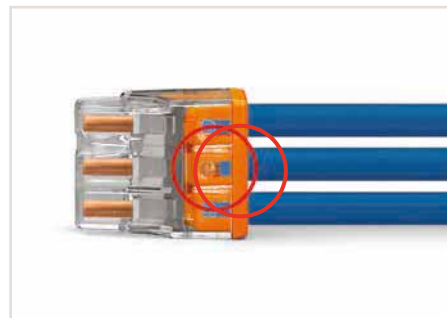
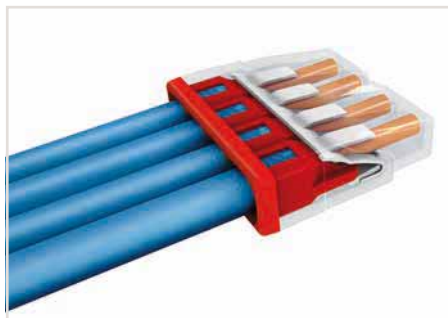

Strip solid conductor to 11 mm / 0.43 inch (see marking).

The transparent housing shows if conductors are fully inserted; within the colored base, a clear port shows if the conductor's strip length is correct. Conductors are correctly stripped if the clear port shows no bare conductor on the unprinted connector side. Picture shows center conductor with exceeded strip length.



Termination: Insert stripped solid conductor until it hits backstop.



Removal: Hold conductor to be removed and twist alternately left and right while pulling the connector.



Testing via test port opposite to conductor entry.

## Mounting Carrier for COMPACT PUSH WIRE® Junction Box Connectors, for DIN-35 Rail or Screw Mount, 2273 Series



The mounting carrier is suitable for both connector heights.



To adjust the mounting carrier, unlock the latch via operating tool (5.5 mm blade) and move the clamping slide to the required width by rotating the tool.



The mounting carrier is suitable for both connector widths.

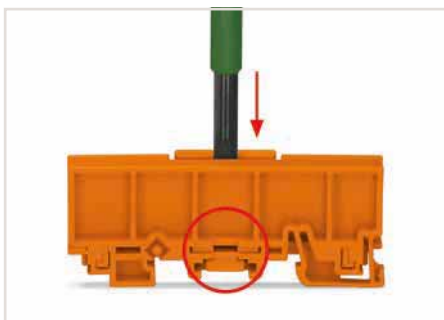

## COMPACT PUSH WIRE® Connectors for Junction Boxes and Solid Conductors 2.5 mm<sup>2</sup>, 2273 Series



### Advantages:

- Convenient wiring via extremely compact design
- Connect conductors ranging from 0.5 to 2.5 mm<sup>2</sup>
- Any combination of conductor sizes is possible
- PUSH WIRE® connection terminates solid ("s") copper conductors
- Terminate up to 8 solid conductors by simply pushing them in



Dimensions in mm

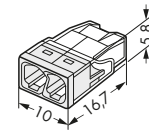

COMPACT PUSH WIRE® connector for junction boxes, 2-cond. connector, transparent housing, white cover

Item No.	Pack. Unit
2273-202	1000 (100)

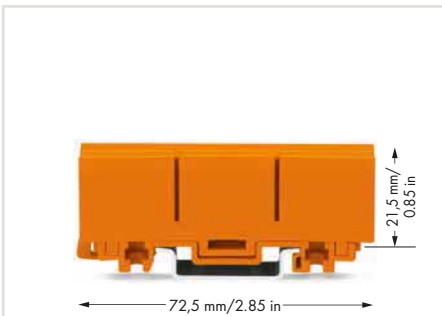

Mounting carrier (2273-500), for single- (14 mm) and double-row (18.5 mm) connectors

### PUSH WIRE® connectors in distribution boxes

During distribution box retrofits or expansions, conductors often require extensions or additional clamping points. Individual PUSH WIRE® connectors (e.g., 2273 Series) are approved as interconnect components for building wiring applications per EN 60998. Application standards for building installation (e.g., Parts 510 and 520 from DIN VDE 0100) also place the following requirements on junction box connectors:

- They must be arranged so that operation, inspection, maintenance and access to the removable connectors is simplified.
- It must be possible to test them.
- Conductors connected from outside must be clearly and permanently assigned to their associated circuits.

These requirements cannot be met with PUSH WIRE® connectors alone. In combination with WAGO mounting carriers, the PUSH WIRE® connectors clearly meet these requirements, making them comparable to rail-mount terminal blocks. Using PUSH WIRE® connectors with mounting carriers in distribution boxes is accepted by testing authorities.

### Technical data

Nominal voltage (II / 2)	450 V
Nominal surge voltage (II / 2)	4 kV
Rated current	24 A

### Connection Data

Solid conductor	0.5 ... 2.5 mm / 18 ... 14 AWG
Strip length	11 mm / 0.43 inch
Continuous service temperature (max.)	105 °C
Ambient operating temperature (max.)	60 °C (T60)

### Note

In grounded power lines

### Accessories (Selection)

Mounting carrier, for single- (14 mm) and double-row (18.5 mm) connectors	2273-500	723
Syringe, contains 20 ml "Alu-Plus" contact paste	249-130	723

	Item No.	Page
orange	2273-500	723
	249-130	723

Mounting carrier installation, see page 719

Aluminum conductors, see notes in Section 14

Accessories, see page 723

Approvals and corresponding ratings, visit [www.wago.com](http://www.wago.com)



Dimensions in mm

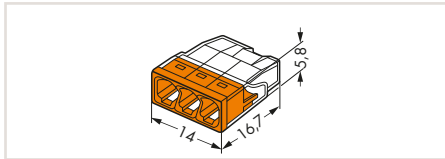

COMPACT PUSH WIRE® connector for junction boxes, 3-cond. connector, transparent housing, orange cover

Item No.	Pack. Unit
2273-203	1000 (100)

450 V  
4 kV  
24 A

0.5 ... 2.5 mm / 18 ... 14 AWG  
11 mm / 0.43 inch  
105 °C  
60 °C (T60)  
In grounded power lines

	Item No.	Page
orange	2273-500	723
	249-130	723

Dimensions in mm

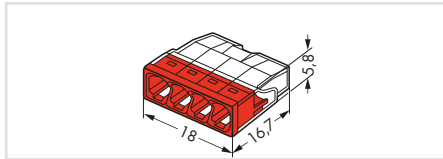

COMPACT PUSH WIRE® connector for junction boxes, 4-cond. connector, transparent housing, red cover

Item No.	Pack. Unit
2273-204	1000 (100)

450 V  
4 kV  
24 A

0.5 ... 2.5 mm / 18 ... 14 AWG  
11 mm / 0.43 inch  
105 °C  
60 °C (T60)  
In grounded power lines

	Item No.	Page
orange	2273-500	723
	249-130	723

Dimensions in mm

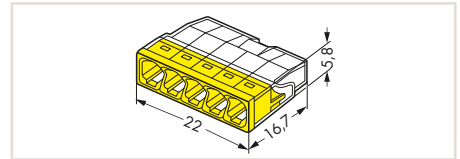

COMPACT PUSH WIRE® connector for junction boxes, 5-cond. connector, transparent housing, yellow cover

Item No.	Pack. Unit
2273-205	1000 (100)

450 V  
4 kV  
24 A

0.5 ... 2.5 mm / 18 ... 14 AWG  
11 mm / 0.43 inch  
105 °C  
60 °C (T60)  
In grounded power lines

	Item No.	Page
orange	2273-500	723
	249-130	723

## COMPACT PUSH WIRE® Connectors for Junction Boxes and Solid Conductors 2.5 mm<sup>2</sup>, 2273 Series

### PUSH WIRE® connectors in distribution boxes

During distribution box retrofits or expansions, conductors often require extensions or additional clamping points. Individual PUSH WIRE® connectors (e.g., 2273 Series) are approved as interconnect components for building wiring applications per EN 60998. Application standards for building installation (e.g., Parts 510 and 520 from DIN VDE 0100) also place the following requirements on junction box connectors:

- They must be arranged so that operation, inspection, maintenance and access to the removable connectors is simplified.
- It must be possible to test them.
- Conductors connected from outside must be clearly and permanently assigned to their associated circuits.

These requirements cannot be met with PUSH WIRE® connectors alone. In combination with WAGO mounting carriers, the PUSH WIRE® connectors clearly meet these requirements, making them comparable to rail-mount terminal blocks. Using PUSH WIRE® connectors with mounting carriers in distribution boxes is accepted by testing authorities.

### Advantages:

- Convenient wiring via extremely compact design
- Connect conductors ranging from 0.5 to 2.5 mm<sup>2</sup>
- Any combination of conductor sizes is possible
- PUSH WIRE® connection terminates solid ("s") copper conductors
- Terminate up to eight solid conductors by simply pushing them in



Dimensions in mm

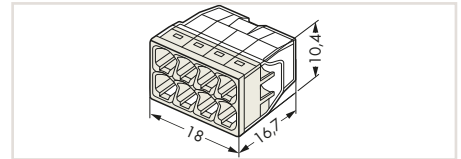

COMPACT PUSH WIRE® connector for junction boxes, 8-cond. connector, transparent housing, light gray cover

Item No.	Pack. Unit
2273-208	500 (50)

### Technical data

Nominal voltage (II / 2)	450 V
Nominal surge voltage (II / 2)	4 kV
Rated current	24 A

### Connection Data

Solid conductor	0.5 ... 2.5 mm / 18 ... 14 AWG
Strip length	11 mm / 0.43 inch
Continuous service temperature (max.)	105 °C
Ambient operating temperature (max.)	60 °C (T60)

### Note

In grounded power lines

### Accessories (Selection)

Mounting carrier, for single- (14 mm) and double-row (18.5 mm) connectors	
Syringe, contains 20 ml "Alu-Plus" contact paste	

Item No.	Page
orange 2273-500	723
249-130	723

 Mounting carrier installation, see page 719

 Aluminum conductors, see notes in Section 14

 Accessories, see page 723

 Approvals and corresponding ratings, visit [www.wago.com](http://www.wago.com)



## Accessories for 2273 Series COMPACT PUSH WIRE® Junction Box Connectors



Mounting carrier, for single- (14 mm) and double-row (18.5 mm) connectors			
Color	Item No.	Pack. Unit	
orange	2273-500	50 (10)	



Syringe, contains 20 ml "Alu-Plus" contact paste			
	Item No.	Pack. Unit	
	249-130	20 (5)	



Self-adhesive marking strips, 5 mm high, 48 self-adhesive strips per card, plain			
Suitable for:	Color	Item No.	Pack. Unit
Mounting carrier	white	210-334	1

# CLASSIC PUSH WIRE® Connectors for Junction Boxes and Solid Conductors, 273 Series

## Description and Installation

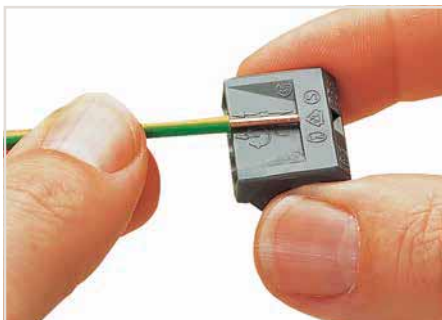
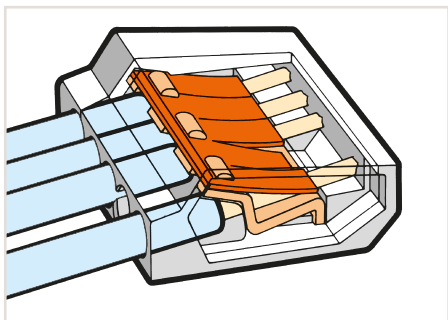

Strip solid conductor to 10 ... 13 mm (0.39 ... 0.51 inch).



Termination: Insert stripped solid conductor until it hits backstop.



Removal: Hold conductor to be removed and twist alternately left and right while pulling the connector.

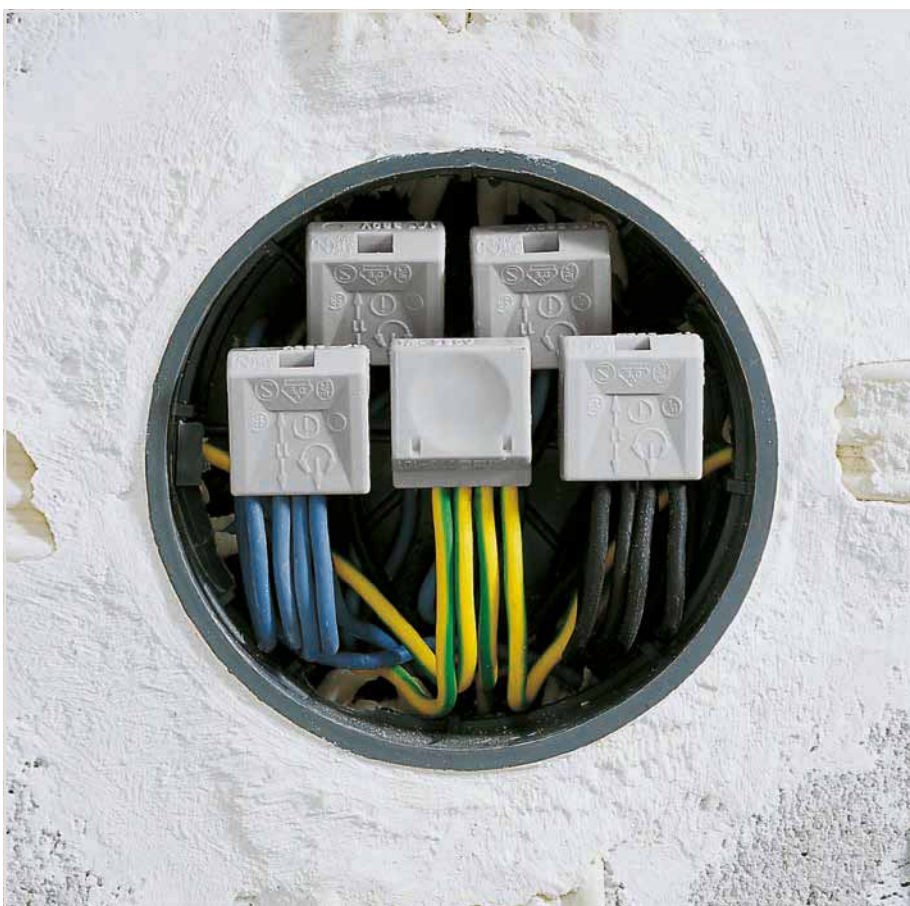

Testing via test ports opposite to conductor entry.

12



PUSH WIRE® junction box connectors used in a cable duct with double power outlet



## Mounting Carrier for CLASSIC PUSH WIRE® Junction Box Connectors, for DIN-35 Rail or Screw Mount, 273 Series

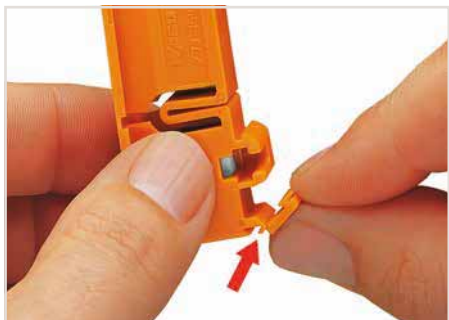

Snap off the cover before using the mounting carrier.



Use the cover as an end plate.



Snap the mounting carrier onto the DIN-rail.

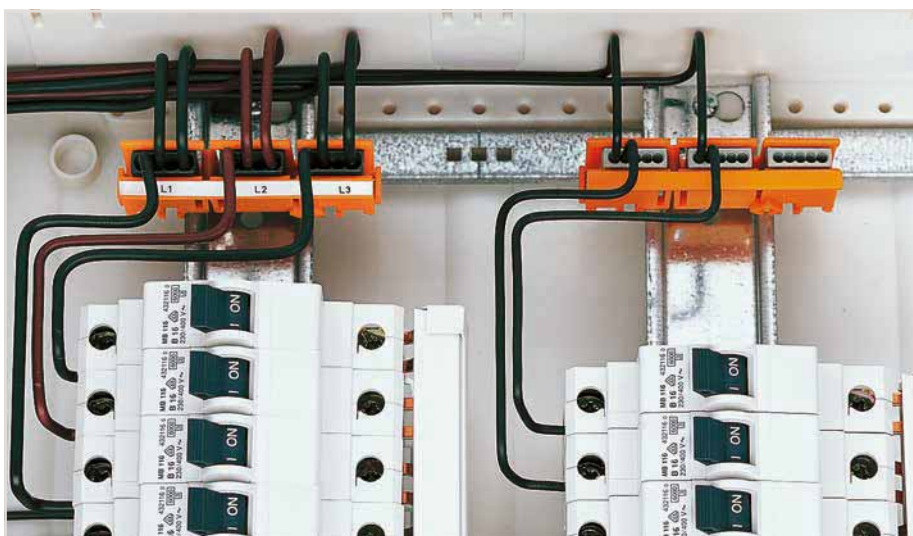

Remove the mounting carrier from the DIN-rail.

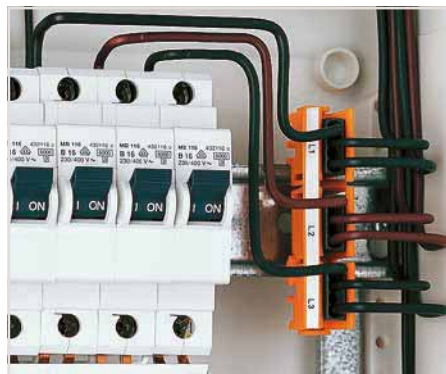

Secured in position – on a DIN-35 rail



Secured in position – screw mounting

One single carrier can hold up to 15 clamping units in a very narrow space. Previously, this was only possible using rail-mount terminal blocks.

### Advantages:

- Mount carrier onto DIN-35 rail or via screws – easily and quickly
- Accommodate up to three 1.5 mm<sup>2</sup> (16 AWG) or 2.5 mm<sup>2</sup> (12 AWG) 273 Series connectors (excluding the 8 x 2.5 mm<sup>2</sup> version) in a single carrier
- Easily exchange connectors
- Large marking area for self-adhesive marking strips or for direct marking with permanent felt-tip pen



## CLASSIC PUSH WIRE® Connectors for Junction Boxes and Solid Conductors 1.5 mm<sup>2</sup>, 273 Series

### PUSH WIRE® connectors in distribution boxes

During distribution box retrofits or expansions, conductors often require extensions or additional clamping points. Individual PUSH WIRE® connectors (e.g., 273 Series) are approved as interconnect components for building wiring applications per EN 60998. Application standards for building installation (e.g., Parts 510 and 520 from DIN VDE 0100) also place the following requirements on junction box connectors:

- They must be arranged so that operation, inspection, maintenance and access to the removable connectors is simplified.
- It must be possible to test them.
- Conductors connected from outside must be clearly and permanently assigned to their associated circuits.

These requirements cannot be met with PUSH WIRE® connectors alone. In combination with WAGO mounting carriers, the PUSH WIRE® connectors clearly meet these requirements, making them comparable to rail-mount terminal blocks. Using PUSH WIRE® connectors with mounting carriers in distribution boxes is accepted by testing authorities.



Dimensions in mm

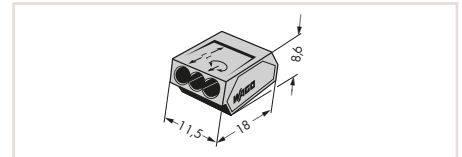

PUSH WIRE® connector for junction boxes,  
3-cond. connector

Color	Item No.	Pack. Unit
gray	273-100	1000(100)
transparent	273-153	1000(100)



### Technical data

Nominal voltage (II / 2)	400 V
Nominal surge voltage (II / 2)	4 kV
Rated current	18 A
Approval	600 V, 20 A <sup>UL</sup> ; 600 V, 10 A <sup>CE</sup>

### Connection Data

Solid conductor	0.75 ... 1.5 mm / 18 ... 16 AWG
Strip length	10 ... 13 mm / 0.39 ... 0.51 inch
Continuous service temperature (max.)	105 °C
Ambient operating temperature (max.)	60 °C

### Note

In grounded power lines  
When using conductors of exclusively the same diameter, 0.5 mm<sup>2</sup> (20 AWG) cross-section is also possible.

### Accessories (Selection)

	Item No.	Page
Syringe, contains 20 ml "Alu-Plus" contact paste	249-130	723
Self-adhesive marking strips, 5 mm high, 48 self-adhesive strips per card, plain		

Mounting carrier installation,  
see page 725

Aluminum conductors,  
see notes in Section 14

Approvals and corresponding ratings,  
visit [www.wago.com](http://www.wago.com)

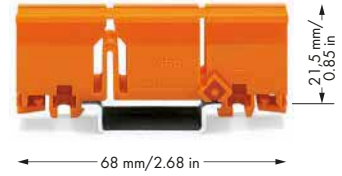

Dimensions in mm

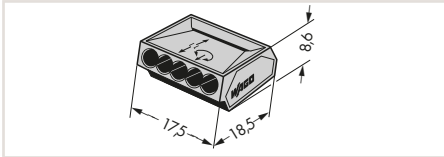

PUSH WIRE® connector for junction boxes, 5-cond. connector

Color	Item No.	Pack. Unit
gray	273-101	1000 (100)
transparent	273-155	1000 (100)



400 V  
4 kV  
18 A  
600 V, 20 A<sup>Ⓢ</sup>; 600 V, 10 A<sup>Ⓢ</sup>

0.75 ... 1.5 mm / 18 ... 16 AWG  
10 ... 13 mm / 0.39 ... 0.51 inch  
105 °C  
60 °C

In grounded power lines  
When using conductors of the same diameter, 0.5 mm<sup>2</sup> (20 AWG) cross-section is also possible.

Item No.	Page
249-130	723

Dimensions in mm

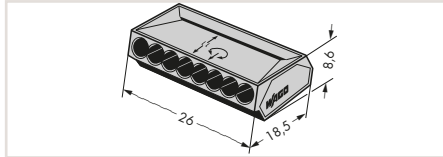

PUSH WIRE® connector for junction boxes, 8-cond. connector

Color	Item No.	Pack. Unit
gray	273-108	500 (50)
transparent	273-158	500 (50)



400 V  
4 kV  
18 A  
600 V, 20 A<sup>Ⓢ</sup>; 600 V, 10 A<sup>Ⓢ</sup>

0.75 ... 1.5 mm / 18 ... 16 AWG  
10 ... 13 mm / 0.39 ... 0.51 inch  
105 °C  
60 °C

In grounded power lines  
When using conductors of the same diameter, 0.5 mm<sup>2</sup> (20 AWG) cross-section is also possible.

Item No.	Page
249-130	723

Mounting carrier

Color	Item No.	Pack. Unit
orange	273-150	50 (10)

Item No.	Page
white	210-334
	723

## CLASSIC PUSH WIRE® Connectors for Junction Boxes and Solid Conductors 2.5 mm<sup>2</sup>, 273 Series

### PUSH WIRE® connectors in distribution boxes

During distribution box retrofits or expansions, conductors often require extensions or additional clamping points. Individual PUSH WIRE® connectors (e.g., 273 Series) are approved as interconnect components for building wiring applications per EN 60998. Application standards for building installation (e.g., Parts 510 and 520 from DIN VDE 0100) also place the following requirements on junction box connectors:

- They must be arranged so that operation, inspection, maintenance and access to the removable connectors is simplified.
- It must be possible to test them.
- Conductors connected from outside must be clearly and permanently assigned to their associated circuits.

These requirements cannot be met with PUSH WIRE® connectors alone. In combination with WAGO mounting carriers, the PUSH WIRE® connectors clearly meet these requirements, making them comparable to rail-mount terminal blocks. Using PUSH WIRE® connectors with mounting carriers in distribution boxes is accepted by testing authorities.



Dimensions in mm

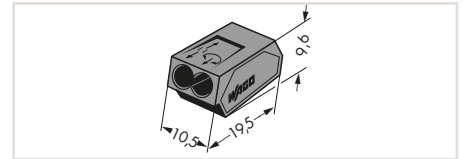

PUSH WIRE® connector for junction boxes,  
2-cond. connector

Color	Item No.	Pack. Unit
● dark gray	273-112	1000(100)
● transparent	273-252	1000(100)



### Technical data

Nominal voltage (II / 2)	400 V
Nominal surge voltage (II / 2)	4 kV
Rated current	24 A
Approval	600 V, 20 A <sup>Ⓢ</sup> ; 600 V, 20 A <sup>Ⓢ</sup>

### Connection Data

Solid conductor	1 ... 2.5 mm / 14 ... 12 AWG
Strip length	10 ... 13 mm / 0.39 ... 0.51 inch
Continuous service temperature (max.)	105 °C
Ambient operating temperature (max.)	60 °C

### Note

In grounded power lines  
When using conductors of the same diameter, 0.75 mm<sup>2</sup> (18 AWG) cross-section is also possible.

### Accessories (Selection)

	Item No.	Page
Mounting carrier	273-150	727
Syringe, contains 20 ml "Alu-Plus" contact paste	249-130	723

Mounting carrier installation,  
see page 725

Aluminum conductors,  
see notes in Section 14

Approvals and corresponding ratings,  
visit [www.wago.com](http://www.wago.com)





Dimensions in mm

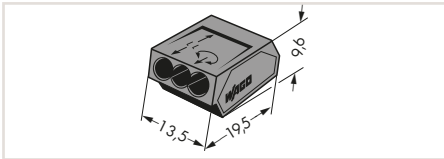

Dimensions in mm

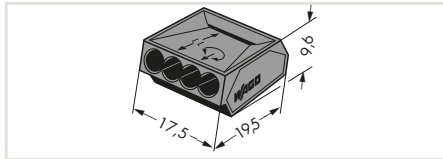

Dimensions in mm

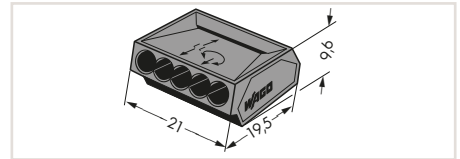

PUSH WIRE® connector for junction boxes, 3-cond. connector

Color	Item No.	Pack. Unit
● dark gray	273-104	1000 (100)
● transparent	273-253	1000 (100)



400 V  
4 kV  
24 A  
600 V, 20 A<sup>Ⓢ</sup>; 600 V, 20 A<sup>Ⓢ</sup>

1 ... 2.5 mm / 14 ... 12 AWG  
10 ... 13 mm / 0.39 ... 0.51 inch  
105 °C  
60 °C

In grounded power lines  
When using conductors of the same diameter, 0.75 mm<sup>2</sup> (18 AWG) cross-section is also possible.

	Item No.	Page
orange	273-150	727
	249-130	723

PUSH WIRE® connector for junction boxes, 4-cond. connector

Color	Item No.	Pack. Unit
● dark gray	273-102	1000 (100)
● transparent	273-254	1000 (100)



400 V  
4 kV  
24 A  
600 V, 20 A<sup>Ⓢ</sup>; 600 V, 20 A<sup>Ⓢ</sup>

1 ... 2.5 mm / 14 ... 12 AWG  
10 ... 13 mm / 0.39 ... 0.51 inch  
105 °C  
60 °C

In grounded power lines  
When using conductors of the same diameter, 0.75 mm<sup>2</sup> (18 AWG) cross-section is also possible.

	Item No.	Page
orange	273-150	727
	249-130	723

PUSH WIRE® connector for junction boxes, 4-cond. connector

Color	Item No.	Pack. Unit
● dark gray	273-105	500 (50)
● transparent	273-255	500 (50)



400 V  
4 kV  
24 A  
600 V, 20 A<sup>Ⓢ</sup>; 600 V, 20 A<sup>Ⓢ</sup>

1 ... 2.5 mm / 14 ... 12 AWG  
10 ... 13 mm / 0.39 ... 0.51 inch  
105 °C  
60 °C

In grounded power lines  
When using conductors of the same diameter, 0.75 mm<sup>2</sup> (18 AWG) cross-section is also possible.

	Item No.	Page
orange	273-150	727
	249-130	723

## PUSH WIRE® Connectors for Junction Boxes, 773 Series Description and Installation

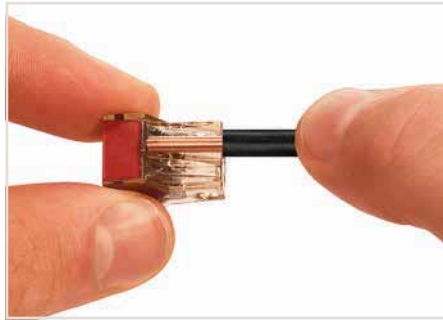
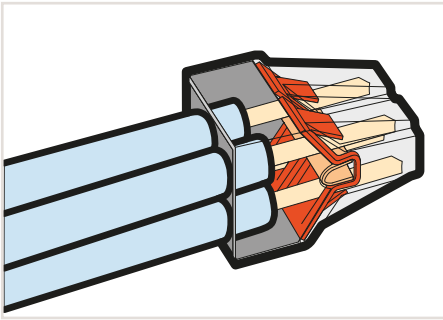

Strip solid conductor to 10 ... 13 mm.



Termination: Insert stripped solid conductor until it hits backstop.



Removal: Hold conductor to be removed and twist alternately left and right while pulling the connector.

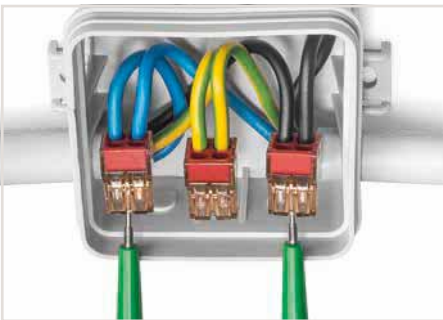

Testing via test ports opposite to conductor entry.



## Mounting Carrier for CLASSIC PUSH WIRE® Junction Box Connectors, for DIN-35 Rail or Screw Mount, 773 Series



Use the cover as an end plate.

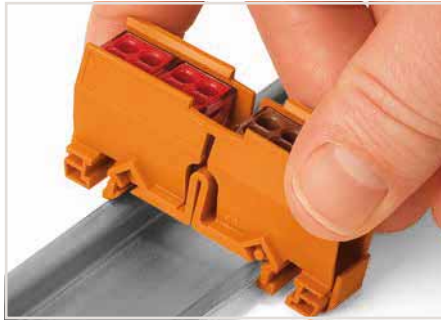

Snap the mounting carrier onto the DIN-rail.

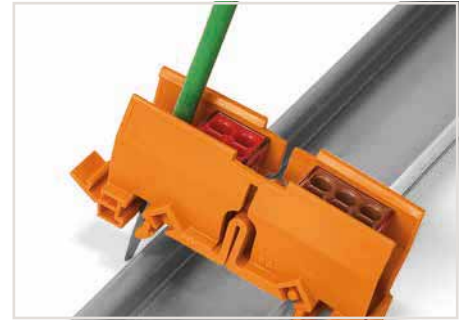

Remove the mounting carrier from the DIN-rail.



A mounting carrier (see accessories) suits applications where the connectors must be marked and secured in position. The DIN-35 rail-mount carrier fits up to two connectors and can also be mounted on a flat surface using two screws.

Using this PUSH WIRE® connector, a large range of wiring applications can be achieved in distribution or junction boxes. To mention just a few: potential multiplication and changing from or to 6 mm<sup>2</sup> conductor size.

## PUSH WIRE® Connectors for Junction Boxes and Solid Conductors

### 4 mm<sup>2</sup>, 773 Series

Approved: EN 60998  
Not approved: UL



Dimensions in mm

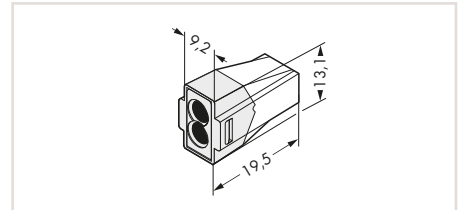

PUSH WIRE® junction box connector for solid conductors up to 4 mm<sup>2</sup>, 2-cond. connector, transparent brown housing, white cover

Item No.	Pack. Unit
773-602	1000 (100)

#### Technical data

Nominal voltage (II / 2)	400 V
Nominal surge voltage (II / 2)	4 kV
Rated current	32 A

#### Connection Data

Solid conductor	1.5 ... 4 mm <sup>2</sup>
Strip length	12 mm / 0.47 inch
Continuous service temperature (max.)	105 °C
Ambient operating temperature (max.)	60 °C

#### Note

In grounded power lines

#### Accessories (Selection)

Mounting carrier, for all 773 Series PUSH WIRE® Connectors for Junction Boxes	orange	773-332	739
Syringe, contains 20 ml "Alu-Plus" contact paste		249-130	739

	Item No.	Page
orange	773-332	739
	249-130	739

Mounting carrier installation, see page 731

Aluminum conductors, see notes in Section 14

Accessories, see page 739

Approvals and corresponding ratings, visit [www.wago.com](http://www.wago.com)



Dimensions in mm

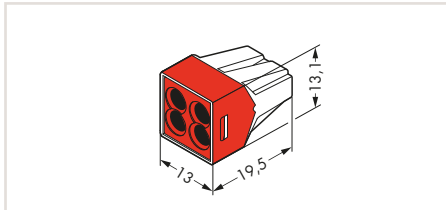

PUSH WIRE® junction box connector for solid conductors up to 4 mm<sup>2</sup>, 4-cond. connector, transparent brown housing, red cover

Item No.	Pack. Unit
773-604	1000 (100)

400 V
4 kV
32 A

1.5 ... 4 mm <sup>2</sup>
12 mm / 0.47 inch
105 °C
60 °C
In grounded power lines

	Item No.	Page
orange	773-332	739
	249-130	739

Dimensions in mm

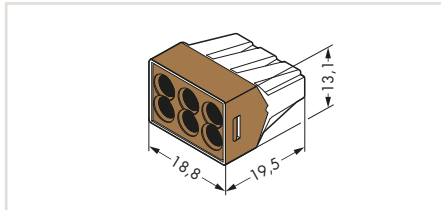

PUSH WIRE® junction box connector for solid conductors up to 4 mm<sup>2</sup>, 6-cond. connector, transparent brown housing, brown cover

Item No.	Pack. Unit
773-606	500 (50)

400 V
4 kV
32 A

1.5 ... 4 mm <sup>2</sup>
12 mm / 0.47 inch
105 °C
60 °C
In grounded power lines

	Item No.	Page
orange	773-332	739
	249-130	739

## PUSH WIRE® Connectors for Junction Boxes

### 2.5 mm<sup>2</sup> and 6 mm<sup>2</sup>, 773 Series



#### PUSH WIRE® connectors in distribution boxes

During distribution box retrofits or expansions, conductors often require extensions or additional clamping points. Individual PUSH WIRE® connectors (e.g., 773 Series) are approved as interconnect components for building wiring applications per EN 60998. Application standards for building installation (e.g., Parts 510 and 520 from DIN VDE 0100) also place the following requirements on junction box connectors:

- They must be arranged so that operation, inspection, maintenance and access to the removable connectors is simplified.
- It must be possible to test them.
- Conductors connected from outside must be clearly and permanently assigned to their associated circuits.

These requirements cannot be met with PUSH WIRE® connectors alone. In combination with WAGO mounting carriers, the PUSH WIRE® connectors clearly meet these requirements, making them comparable to rail-mount terminal blocks. Using PUSH WIRE® connectors with mounting carriers in distribution boxes is accepted by testing authorities.

#### Technical data

Nominal voltage (II / 2)

Nominal surge voltage (II / 2)

Rated current

Approval

#### Connection Data

Solid conductor

Stranded conductor

Strip length

Continuous service temperature (max.)

Ambient operating temperature (max.)

#### Note

#### Accessories (Selection)

Mounting carrier, for all 773 Series PUSH WIRE® Connectors for Junction Boxes

Syringe, contains 20 ml "Alu-Plus" contact paste

Self-adhesive marking strips, 5 mm high, 48 self-adhesive strips per card, plain



Dimensions in mm

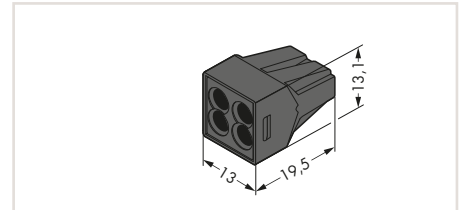

PUSH WIRE® connector for junction boxes, 4-cond. connector

Color	Item No.	Pack. Unit
● black	773-514	1000 (100)



400 V

4 kV

24 A

600 V, 20 A<sup>Ⓢ</sup>; 600 V, 20 A<sup>Ⓢ</sup>

0.75 ... 2.5 mm / 18 ... 12 AWG

12 mm / 0.47 inch

150 °C

105 °C

In grounded power lines

	Item No.	Page
orange	773-332	739
	249-130	739

Mounting carrier installation, see page 731

Aluminum conductors, see notes in Section 14

Accessories, see page 739

Approvals and corresponding ratings, visit [www.wago.com](http://www.wago.com)



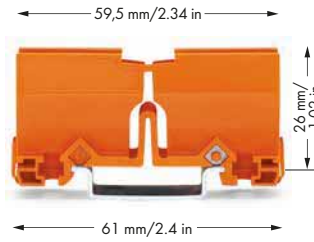

Dimensions in mm

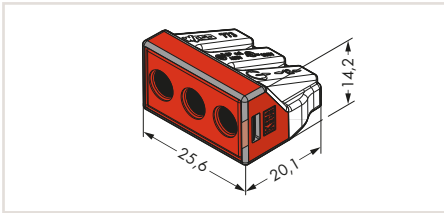

PUSH WIRE® connector for junction boxes, 3-cond. connector, transparent housing, red cover

	Item No.	Pack. Unit
transparent	773-173	500 (50)

Mounting carrier, for all 773 Series PUSH WIRE® Connectors for Junction Boxes

Color	Item No.	Pack. Unit
orange	773-332	50 (10)



- 400 V
- 4 kV
- 41 A
- 600 V, 30 A<sup>Ⓢ</sup>; 600 V, 30 A<sup>Ⓢ</sup>
- 2.5 ... 6 mm / 14 ... 10 AWG
- 2.5 ... 6 mm / 14 ... 10 AWG
- 12 ... 13 mm / 0.47 ... 0.51 in.
- 105 °C
- 60 °C
- In grounded power lines

	Item No.	Page
orange	773-332	739
	249-130	739

	Item No.	Page
	210-334	739

## Ex PUSH WIRE® Connectors for Junction Boxes

### 2.5 mm<sup>2</sup>, 773 Series

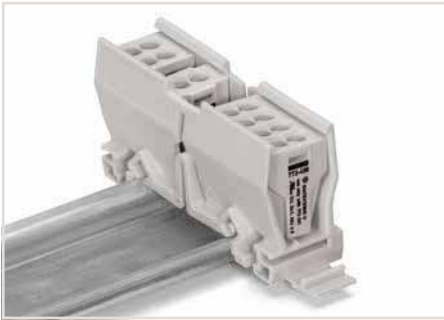

Insert the connectors into the carrier.

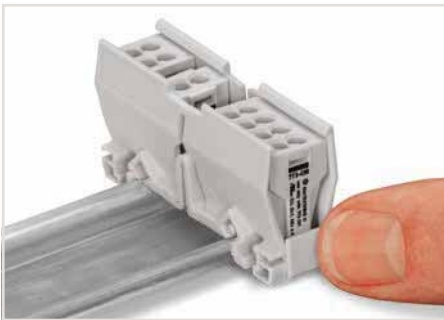

Use the cover as an end plate.



Remove the mounting carrier from the DIN-rail.

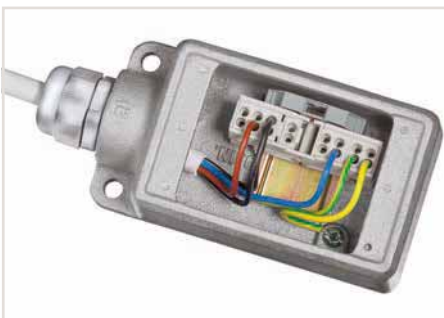

Wiring example in an Ex junction box

#### Technical data

Rated voltage EN (Ex e II)	550 V
Rated current	24 A
<b>Connection Data</b>	
Connection technology	PUSH WIRE®
Solid conductor	0.75 ... 2.5 mm / 18 ... 12 AWG
Strip length	12 mm / 0.47 inch
<b>Note</b>	275 V at a distance < 10 mm to parts of other potentials To be used only in conjunction with a mounting carrier (773-331)

WAGO Ex PUSH WIRE® connectors are ideal for distribution and junction boxes, as well as control and operating systems. When used in hazardous areas, they offer the following advantages over traditional connectors:

- Time- and cost-saving PUSH WIRE® connection
- Vibration-proof, maintenance-free connections
- 100 % touch-proof protection
- Connectors can be secured in position via mounting carriers
- One single carrier equipped with 2-, 4-, 6- and 8-cond. connectors holds up to 16 clamping units according to user requirements, saving materials and related costs
- Available as OEM products for manufacturers and suppliers of enclosures and distribution boxes used in hazardous areas

#### Accessories (Selection)

Mounting carrier, for Ex PUSH WIRE® junction box connectors

Item No.

773-331

Page

739

## Ex PUSH WIRE® Connectors for Junction Boxes 2.5 mm<sup>2</sup>, 773 Series



Dimensions in mm

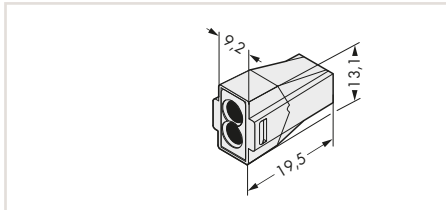

PUSH WIRE® connector for junction boxes, 2-cond. connector

Color	Item No.	Pack. Unit
○ light gray ☺	773-492	1000 (100)

Dimensions in mm

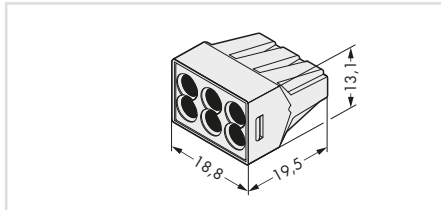

PUSH WIRE® connector for junction boxes, 6-cond. connector

Color	Item No.	Pack. Unit
○ light gray ☺	773-496	500 (50)

Mounting carrier, for Ex PUSH WIRE® junction box connectors

Color	Item No.	Pack. Unit
○ light gray	773-331	50 (10)



Dimensions in mm

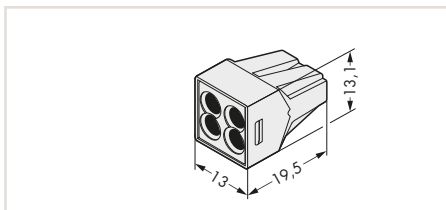

PUSH WIRE® connector for junction boxes, 4-cond. connector

Color	Item No.	Pack. Unit
○ light gray ☺	773-494	1000 (100)

Dimensions in mm

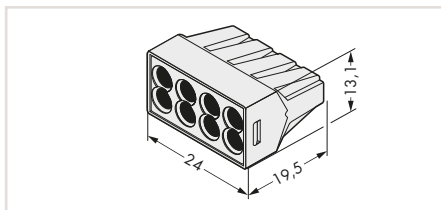

PUSH WIRE® connector for junction boxes, 8-cond. connector

Color	Item No.	Pack. Unit
○ light gray ☺	773-498	500 (50)

## Ex PUSH WIRE® Connectors for Junction Boxes 6 mm<sup>2</sup>, 773 Series



Dimensions in mm

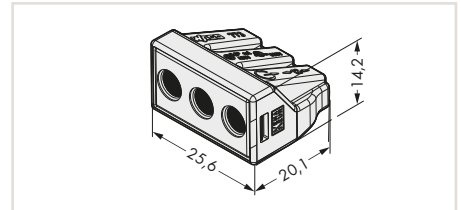

PUSH WIRE® connector for junction boxes,  
3-cond. connector

Color	Item No.	Pack. Unit
○ light gray ☒	773-493	500 (50)

### Technical data

Rated voltage EN (Ex e II)	550 V
Rated current	42 A

### Connection Data

Solid conductor	2.5 ... 6 mm / 14 ... 10 AWG
Strip length	12 ... 15 mm / 0.47 ... 0.59 inch

### Note

275 V at a distance < 10 mm to parts of other potentials  
To be used only in conjunction with a mounting carrier (773-331)

### Accessories (Selection)

Mounting carrier, for Ex PUSH WIRE® junction box connectors	
---	--

	Item No.	Page
light gray	773-331	739

 Mounting carrier installation,  
see page 736

 Accessories,  
see page 739

 Approvals and corresponding ratings,  
visit [www.wago.com](http://www.wago.com)

## Accessories for 773 Series PUSH WIRE® Junction Box Connectors



Mounting carrier, for all 773 Series PUSH WIRE® Connectors for Junction Boxes			
Color	Item No.	Pack. Unit	
orange	773-332	50 (10)	



Mounting carrier, for Ex PUSH WIRE® junction box connectors			
Suitable for:	Color	Item No.	Pack. Unit
Ex PUSH WIRE® Connectors for Junction Boxes	light gray	773-331	50 (10)



Self-adhesive marking strips, 5 mm high, 48 self-adhesive strips per card, plain			
Suitable for:	Color	Item No.	Pack. Unit
Mounting carrier	white	210-334	1



Syringe, contains 20 ml "Alu-Plus" contact paste			
	Item No.	Pack. Unit	
	249-130	20 (5)	

## MICRO PUSH WIRE® Connectors for Junction Boxes and Solid Conductors, 243 Series Description and Installation

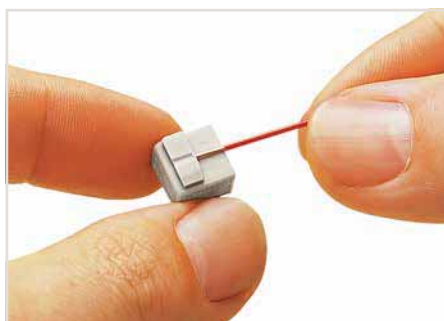
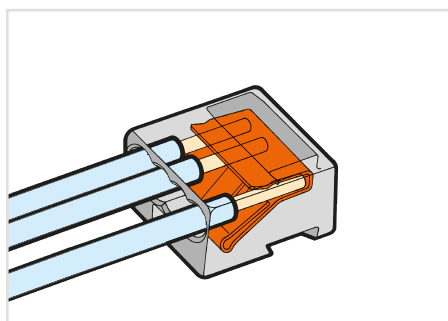

Strip solid conductors to 5 ... 6 mm.



**Connector strips:**  
Assembling modular connectors into connector strips.

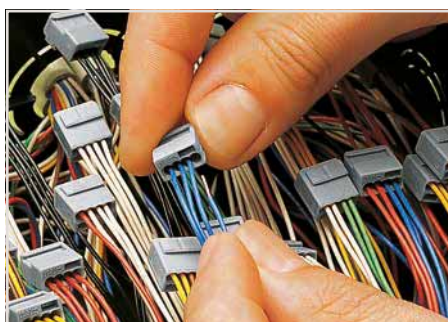

**Termination:** Insert stripped conductor until it hits backstop.

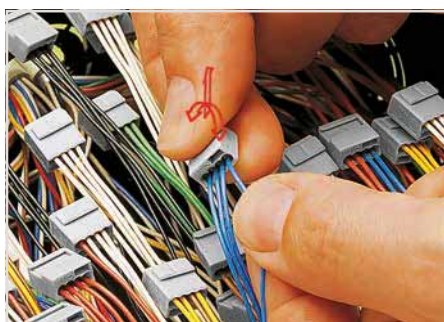

**Removal:** Hold conductor to be removed and twist alternately left and right while pulling the connector.



Testing via test ports opposite to conductor entry.

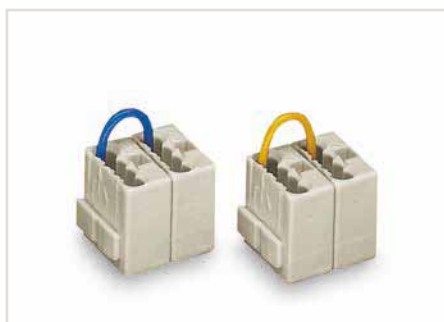

Commoned connector strips



## Mounting Carrier for MICRO PUSH WIRE® Junction Box Connectors, for DIN-35 Rail or Screw Mount, 243 Series

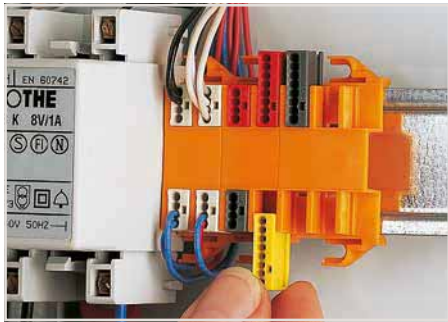

Inserting a MICRO junction box connector into the mounting carrier.

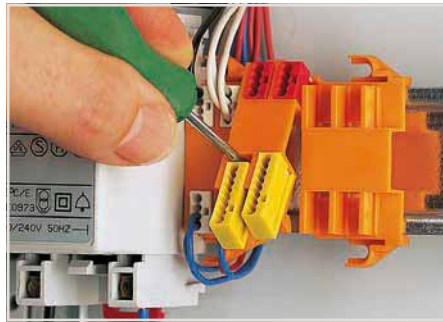

Removing a mounting carrier from the assembly.



Example of a residential door bell application – carriers mounted on a DIN-35 rail

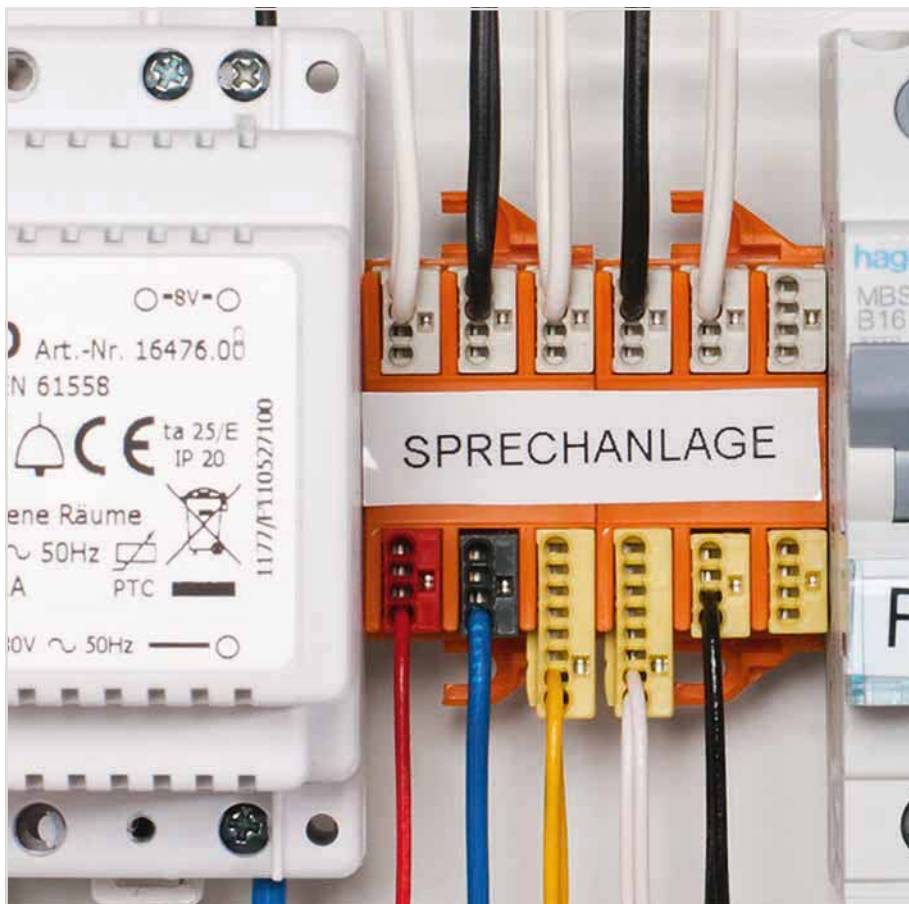

Example of a residential intercom application

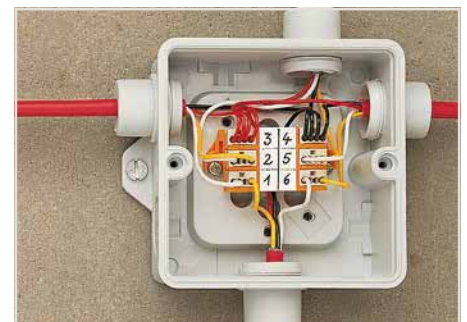

Typical application in a terminal box for burglar alarm – screw-mounted carrier

### Quick Fix Mounting

Realizing MICRO PUSH WIRE® connectors for junction boxes are ideal for DIN-rail-mount panel applications, electrical installers have requested the ability to use them in distribution panels. These connectors provide easy connections for smaller conductors used in low-current applications. They are well-suited to terminating telephone-style conductors for connecting alarms, bells, door sensors, communication systems, etc.

The mounting carrier is WAGO's professional solution. It is available with mounting slots for 4 or 6 connectors.

Depending on the number of conductors, each mounting slot can accommodate a 4- or 8-conductor MICRO PUSH WIRE® connector for junction boxes. The connectors simply snap into the mounting slots and are removable, allowing conductors to be exchanged during changeover.

The carrier is designed for easy mounting directly to the DIN-35 rail, or to a panel, via the screw-mount flanges provided on both sides. A large marking area for direct marking with a permanent felt-tip pen or for pre-printed self-adhesive marking strips is provided for clear circuit identification.

## MICRO PUSH WIRE® Connectors for Junction Boxes

### 0.8 mm Ø, 243 Series

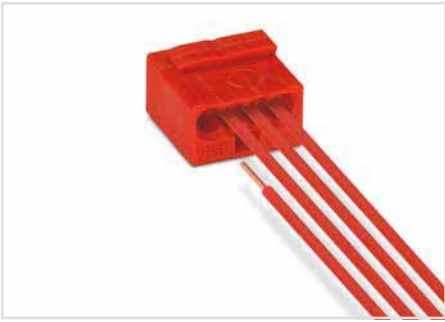

WAGO's 243 Series MICRO PUSH WIRE® Connectors for junction boxes can be used in both communication and alarm systems according to the VdS (German Association of Property Insurers) guidelines.

No general approval is given to PUSH WIRE® connectors by the VdS association. The connectors must be tested together with the different parts of the system.

The requirements for connectors are specified in the VdS guidelines for junction boxes (VdS 2116) in section 8.7: "The junction box connectors must be designed to guarantee a reliable and stable connection."

The verification of the fulfillment of these requirements is documented in the VDE test report No. 2574-1440-4031 for the insulated 243 Series PUSH WIRE® Connectors for junction boxes.

#### Technical data

Nominal voltage (II / 2)	100 V
Nominal surge voltage (II / 2)	1.5 kV
Rated current	6 A
Approval	150 V, 7 A ; 150 V, 7 A

#### Connection Data

Solid conductor	0.6 ... 0.8 mm Ø / 22 ... 20 AWG
Strip length	5 ... 6 mm / 0.2 ... 0.24 inch
Continuous service temperature (max.)	105 °C
Ambient operating temperature (max.)	60 °C

#### Note

When using conductors of the same diameter, 0.5 mm (24 AWG) or 1 mm (18 AWG) diameters are also possible.

#### Accessories (Selection)

Mounting carrier, for 4 connectors	orange	243-112	745
Mounting carrier, for 6 connectors	orange	243-113	745



Dimensions in mm

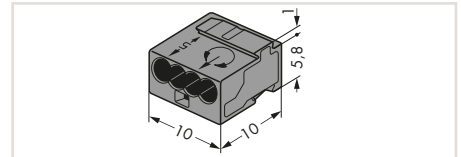

MICRO PUSH WIRE® connector for junction boxes, 4-cond. connector

Color	Item No.	Pack. Unit
dark gray	243-204	1000(100)
red	243-804	1000(100)



Nominal voltage (II / 2)	100 V
Nominal surge voltage (II / 2)	1.5 kV
Rated current	6 A
Approval	150 V, 7 A ; 150 V, 7 A

Solid conductor	0.6 ... 0.8 mm Ø / 22 ... 20 AWG
Strip length	5 ... 6 mm / 0.2 ... 0.24 inch
Continuous service temperature (max.)	105 °C
Ambient operating temperature (max.)	60 °C

When using conductors of the same diameter, 0.5 mm (24 AWG) or 1 mm (18 AWG) diameters are also possible.

	Item No.	Page
orange	243-112	745
orange	243-113	745

Mounting carrier installation, see page 741

Accessories, see page 745

Approvals and corresponding ratings, visit [www.wago.com](http://www.wago.com)



Dimensions in mm

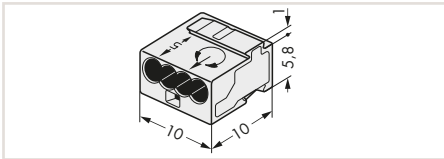

MICRO PUSH WIRE® connector for junction boxes, 4-cond. connector

Color	Item No.	Pack. Unit
○ light gray	243-304	1000 (100)
● yellow	243-504	1000 (100)



100 V  
1.5 kV  
6 A  
150 V, 7 A **VA**; 150 V, 7 A **CE**

0.6 ... 0.8 mm Ø / 22 ... 20 AWG  
5 ... 6 mm / 0.2 ... 0.24 inch  
105 °C  
60 °C

When using conductors of the same diameter, 0.5 mm (24 AWG) or 1 mm (18 AWG) diameters are also possible.

	Item No.	Page
orange	243-112	745
orange	243-113	745



Dimensions in mm

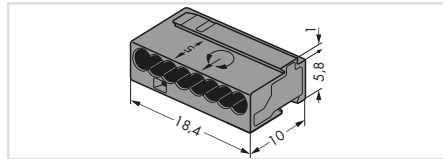

MICRO PUSH WIRE® connector for junction boxes, 8-cond. connector

Color	Item No.	Pack. Unit
● dark gray	243-208	500 (50)
● red	243-808	500 (50)



100 V  
1.5 kV  
6 A  
150 V, 7 A **VA**; 150 V, 7 A **CE**

0.6 ... 0.8 mm Ø / 22 ... 20 AWG  
5 ... 6 mm / 0.2 ... 0.24 inch  
105 °C  
60 °C

When using conductors of the same diameter, 0.5 mm (24 AWG) or 1 mm (18 AWG) diameters are also possible.

	Item No.	Page
orange	243-112	745
orange	243-113	745



Dimensions in mm

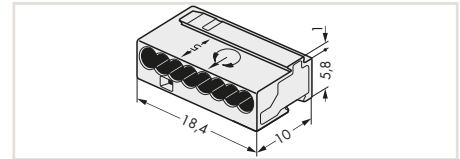

MICRO PUSH WIRE® connector for junction boxes, 8-cond. connector

Color	Item No.	Pack. Unit
○ light gray	243-308	500 (50)
● yellow	243-508	500 (50)



100 V  
1.5 kV  
6 A  
150 V, 7 A **VA**; 150 V, 7 A **CE**

0.6 ... 0.8 mm Ø / 22 ... 20 AWG  
5 ... 6 mm / 0.2 ... 0.24 inch  
105 °C  
60 °C

When using conductors of the same diameter, 0.5 mm (24 AWG) or 1 mm (18 AWG) diameters are also possible.

	Item No.	Page
orange	243-112	745
orange	243-113	745

## MICRO PUSH WIRE® Connectors for Junction Boxes

### 0.5 mm Ø, 243 Series



Dimensions in mm

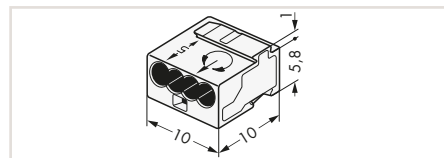

MICRO PUSH WIRE® connector for junction boxes,  
4-cond. connector

Color	Item No.	Pack. Unit
transparent	243-144	1000(100)

#### Technical data

Nominal voltage (II / 2)	100 V
Nominal surge voltage (II / 2)	1.5 kV
Rated current	6 A

#### Connection Data

Solid conductor	0.4 ... 0.5 mm Ø / 26 ... 24 AWG
Strip length	5 ... 6 mm / 0.2 ... 0.24 inch
Continuous service temperature (max.)	105 °C
Ambient operating temperature (max.)	60 °C

#### Accessories (Selection)

	Item No.	Page
Mounting carrier, for 4 connectors	orange 243-112	745
Mounting carrier, for 6 connectors	orange 243-113	745

 Mounting carrier installation,  
see page 741

 Accessories,  
see page 745

 Approvals and corresponding ratings,  
visit [www.wago.com](http://www.wago.com)

## Accessories for 243 Series MICRO PUSH WIRE® Junction Box Connectors



Mounting carrier, for 4 connectors			
Color		Item No.	Pack. Unit
orange		243-112	50 (10)



Mounting carrier, for 6 connectors			
Color		Item No.	Pack. Unit
orange		243-113	50 (10)



Self-adhesive marking strips, 7 mm high, 6 self-adhesive strips per card, plain			
Suitable for:	Color	Item No.	Pack. Unit
Mounting carrier	white	243-110	1



Felt-tip pen, for permanent marking			
		Item No.	Pack. Unit
		210-110	200 (1)

## COMPACT Splicing Connectors for All Conductor Types, 221 Series Description and Installation

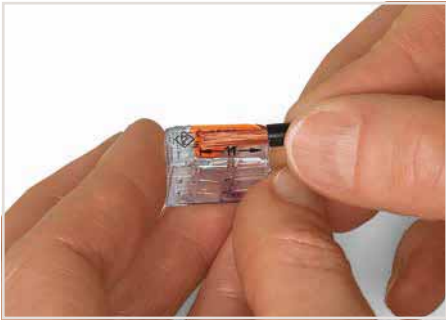

Strip conductor to 11 mm (0.43 inch).



Termination: Lift the lever to open the clamping unit and insert a stripped conductor.

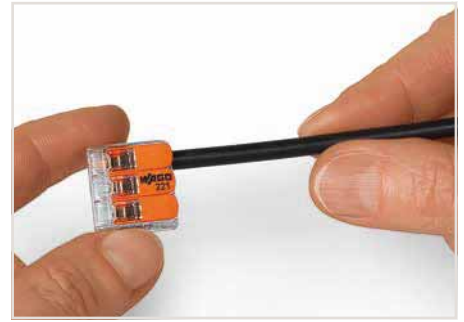

Then, lower the lever to close the clamp.



Wiring fine-stranded conductors in a junction box.



Custom low-voltage lighting system



12



Wiring fine-stranded conductors in a junction box.



Lighting distribution in ceiling canopy



Pendant light connection in suspended ceilings



# Mounting Carrier, 221 Series Types of Assembly



Inserting a connector into the mounting carrier.



Removing a conductor.

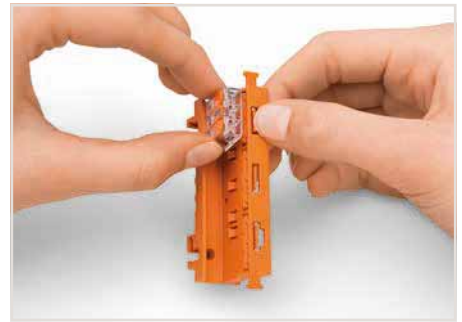

Removing a connector from the mounting carrier.

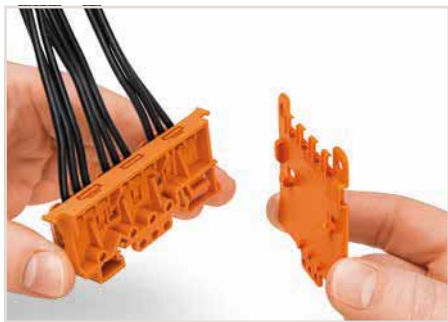

Securing a strain relief plate (222-505) to the mounting carrier.

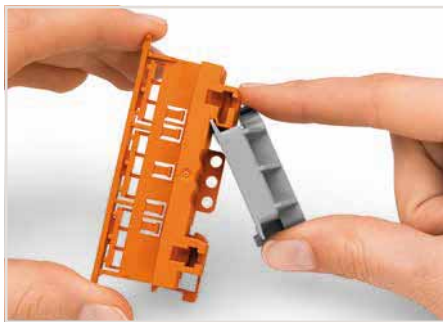

Snapping the angled DIN-rail adapter (222-510) onto the mounting carrier.



Testing connectors via test slots on top of the carrier.



Strain relief via cable ties on the mounting carrier (transverse to the connectors' wiring direction) – clamping units labeled via marking strips (210-334).



Vertical mounting with strain relief plate on DIN-35 rail.



Horizontal mounting on DIN-35 rail using an angled DIN-rail adapter.



Horizontal screw mounting with strain relief plate on a flat surface



Vertical screw mounting with strain relief plate on a flat surface.

## COMPACT Splicing Connectors for All Conductor Types

### 4 mm<sup>2</sup>, 221 Series



**Compact, lever-operated splicing connectors:** Tool-free connection of up to five stripped, fine-stranded conductors from 0.14 ... 4 mm<sup>2</sup>, as well as solid or stranded conductors from 0.2 ... 4 mm<sup>2</sup> (24 ... 12 AWG).

#### How these work:

Pull up one of the orange operating levers to open the clamping unit. Then insert the conductor and push the lever back down, flush with the connector housing.

#### Safety:

The specially designed rest position of the lever reliably prevents accidental unclamping of a connected conductor.

Application safety, for any type of conductor (solid, stranded, fine-stranded), is confirmed by approvals like ENEC or UL.

#### Technical data

Ratings per	EN 60664
Nominal voltage (II / 2)	400 V
Nominal surge voltage (II / 2)	4 kV
Rated current	32 A
Approval	600 V, 20 A <sup>Ⓢ</sup>
<b>Connection Data</b>	
Connection technology	CAGE CLAMP®
Solid conductor	0.2 ... 4 mm / 24 ... 12 AWG
Stranded conductor	0.2 ... 4 mm / 24 ... 12 AWG
Fine-stranded conductor	0.14 ... 4 mm / 24 ... 12 AWG
Strip length	11 mm / 0.43 inch
Continuous service temperature (max.)	105 °C
Ambient operating temperature (max.)	85 °C (T85)
<b>Note</b>	In grounded power lines

Accessories (Selection)	Item No.	Page
Mounting carrier, for 2-, 3- and 5-conductor splicing connectors	221-500	754
Strain relief plate, for 221 or 222 Series Mounting Carriers, snaps on to mounting carrier	222-505	754
Angled DIN-rail adapter, in combination with mounting carrier (221-500 and 222-500) for DIN-35 rail mounting	222-510	754
Syringe, contains 20 ml "Alu-Plus" contact paste	249-130	754

 Aluminum conductors, see notes in Section 14

 Approvals and corresponding ratings, visit [www.wago.com](http://www.wago.com)

# COMPACT Splicing Connectors for All Conductor Types 4 mm², 221 Series



Dimensions in mm

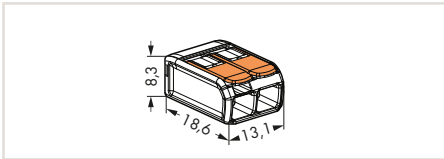

COMPACT splicing connector for all conductor types, 2-cond. connector, with operating levers

	Item No.	Pack. Unit
transparent	221-412	1000 (100)



Dimensions in mm

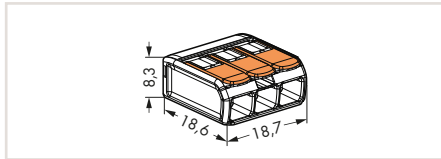

COMPACT splicing connector for all conductor types, 3-cond. connector, with operating levers

	Item No.	Pack. Unit
transparent	221-413	500 (50)



Dimensions in mm

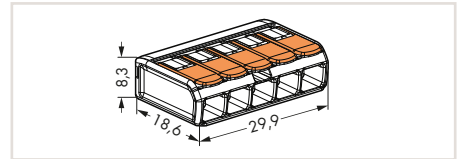

COMPACT splicing connector for all conductor types, 5-cond. connector, with operating levers

	Item No.	Pack. Unit
transparent	221-415	250 (25)



## CLASSIC Splicing Connectors for All Conductor Types, 222 Series Description and Installation

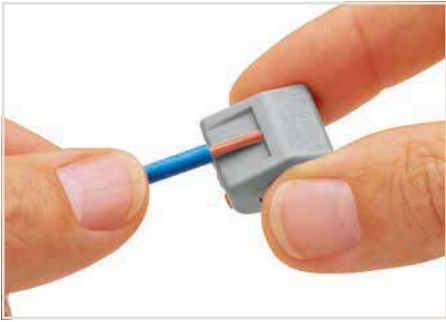

Strip conductor to 9 ... 10 mm (0.35 ... 0.39 inch).

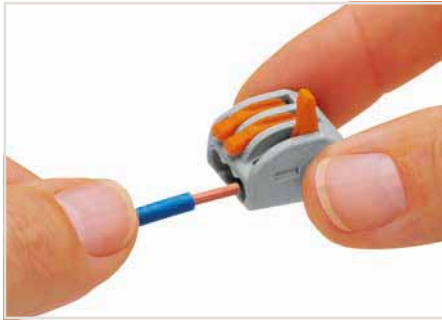

Termination: Lift the lever to open the clamping unit and insert a stripped conductor.

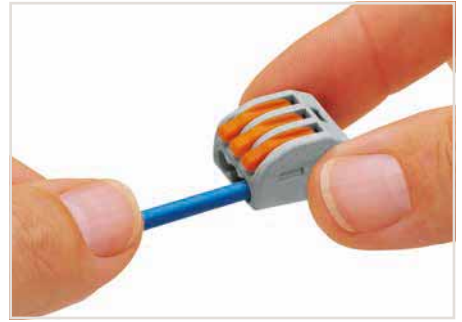

Then, lower the lever to close the clamp.

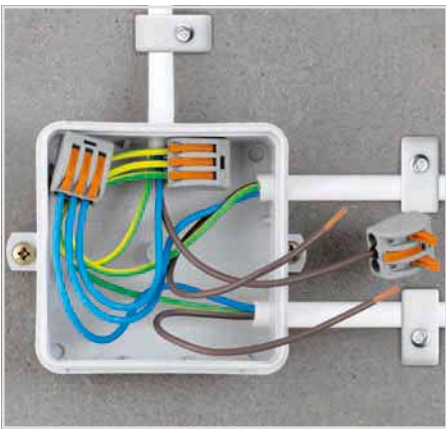

Wiring fine-stranded conductors in a junction box.

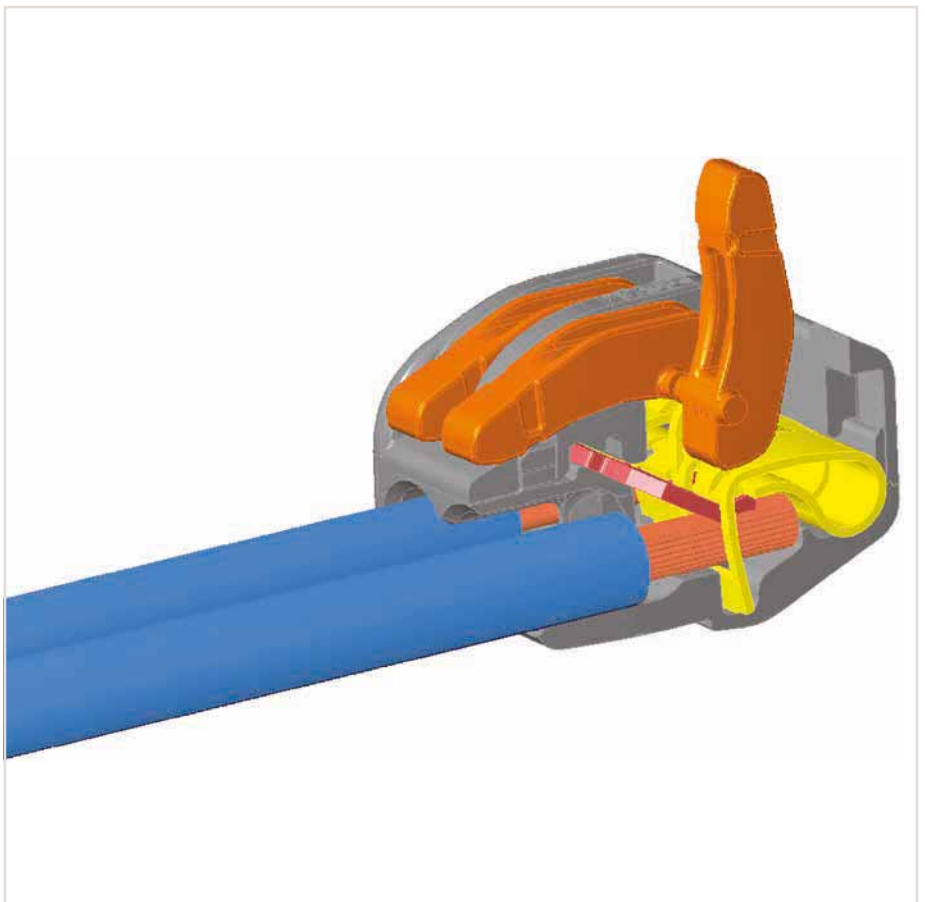

12



Testing via Profi-LED+ voltage tester (206-806).



## Mounting Carrier, 222 Series Types of Assembly



Horizontal mounting on DIN-35 rail using an angled DIN-rail adapter.

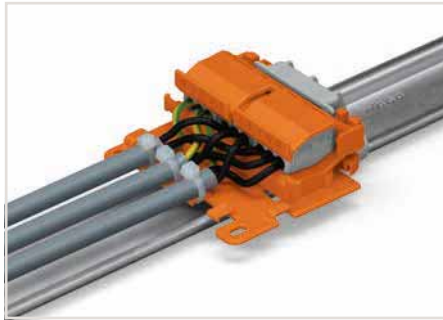

Horizontal mounting with strain relief plate on DIN-35 rail using an angled DIN-rail adapter.

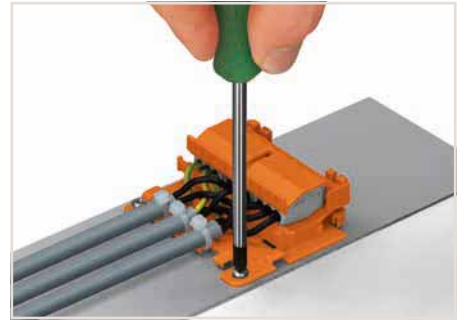

Horizontal screw mounting with strain relief plate on a flat surface



Vertical mounting with strain relief plate on DIN-35 rail. Marking clamping units via marking strips.



Strain relief via cable ties on the mounting carrier (transverse to the connectors' wiring direction) – Molded marking clamping units

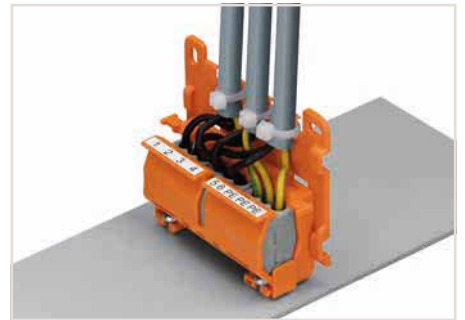

Mounting carrier with strain relief plate mounted vertically on a plate. Round cable secured via strain relief lug.



Snapping the lateral connector safety lock onto the mounting carrier.

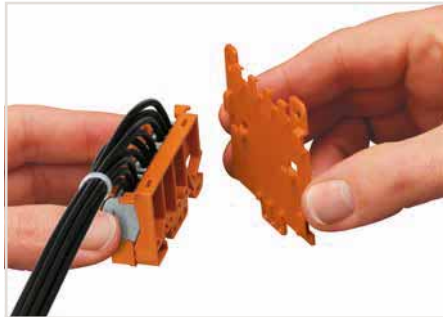

Securing a strain relief plate to the mounting carrier.

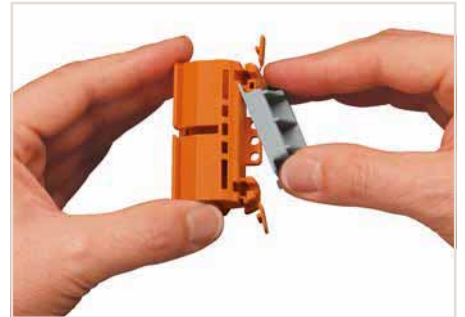

Snapping the angled DIN-rail adapter onto the mounting carrier.

## CLASSIC Splicing Connectors for All Conductor Types

### 2.5 mm<sup>2</sup>, 222 Series



#### Technical data

Nominal voltage (II / 2)	400 V
Nominal surge voltage (II / 2)	4 kV
Rated current	32 A
Approval	600 V, 20 A-Ⓢ-

#### Connection Data

Connection technology	CAGE CLAMP®
Solid conductor	0.08 ... 2.5 mm <sup>2</sup> / 28 ... 12 AWG
Stranded conductor	0.08 ... 2.5 mm <sup>2</sup> / 28 ... 12 AWG
Fine-stranded conductor	0.08 ... 4 mm <sup>2</sup> / 28 ... 12 AWG
Strip length	9 ... 10 mm / 0.35 ... 0.39 inch
Continuous service temperature (max.)	85 °C
Ambient operating temperature (max.)	40 °C

#### Note

In grounded power lines

#### Compact, lever-operated splicing connectors:

Tool-free connection of up to five stripped, fine-stranded conductors from 0.08 ... 4 mm<sup>2</sup> (28 ... 12 AWG), as well as solid or stranded conductors up to 2.5 mm<sup>2</sup> (12 AWG).

#### This is how it works:

Pull up one of the orange operating levers to open the clamping unit so that the lever engages and keeps the clamp in its opened position. Then insert the conductor and push the lever back down, flush with the connector housing.

#### Safety:

The specially designed rest position of the lever reliably prevents accidental unclamping of a connected conductor.

Application safety, for any type of conductor (solid, stranded, fine-stranded), is confirmed by approvals like ENEC or UL.

ENEC is the European mark for electrical products that demonstrates compliance with European safety standards. The ENEC mark is subjected to the same EN standards as the VDE mark.

While the VDE mark is only permitted in Germany, the ENEC mark is accepted in more than 20 European countries.

#### Accessories (Selection)

	Item No.	Page
Mounting carrier, for 2-, 3- and 5-conductor splicing connectors	222-500	754
Strain relief plate, for 221 or 222 Series Mounting Carriers, snaps on to mounting carrier	222-505	754
Angled DIN-rail adapter, in combination with mounting carrier (221-500 and 222-500) for DIN-35 rail mounting	222-510	754
Syringe, contains 20 ml "Alu-Plus" contact paste	249-130	754

 Aluminum conductors, see notes in Section 14

 Approvals and corresponding ratings, visit [www.wago.com](http://www.wago.com)



# CLASSIC Splicing Connectors for All Conductor Types

## 2.5 mm<sup>2</sup>, 222 Series



Dimensions in mm

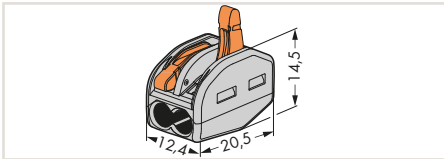

CLASSIC splicing connector for all conductor types, 2-cond. connector, with operating levers

Color	Item No.	Pack. Unit
gray	222-412	500 (50)



Dimensions in mm

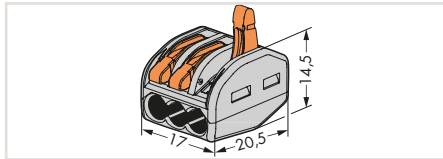

CLASSIC splicing connector for all conductor types, 3-cond. connector, with operating levers

Color	Item No.	Pack. Unit
gray	222-413	500 (50)



Dimensions in mm

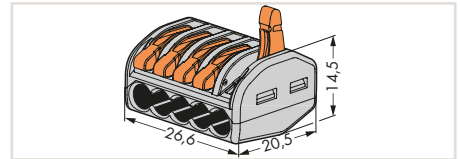

CLASSIC splicing connector for all conductor types, 5-cond. connector, with operating levers

Color	Item No.	Pack. Unit
gray	222-415	400 (40)



## Mounting Carriers and Accessories 222 and 221 Series



Mounting carrier, for 2-, 3- and 5-conductor splicing connectors, 222 Series  
Width 22 mm

Color	Item No.	Pack. Unit
● orange	222-500	50 (10)

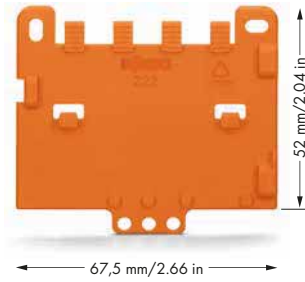

Strain relief plate, for 221 or 222 Series Mounting Carriers, snaps on to mounting carrier  
Width 4 mm

Color	Item No.	Pack. Unit
● orange	222-505	50 (10)

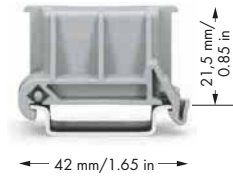

Angled DIN-rail adapter, in combination with mounting carrier (221-500 and 222-500) for DIN-35 rail mounting  
Width 18.5 mm

Color	Item No.	Pack. Unit
○ gray	222-510	50 (10)

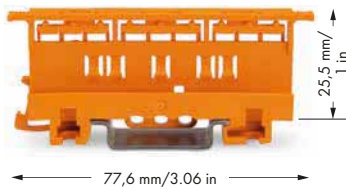

Mounting carrier, for 2-, 3- and 5-conductor splicing connectors, 221 Series  
Width 17.5 mm

Color	Item No.	Pack. Unit
● orange	221-500	50 (10)



Self-adhesive marking strips, 5 mm high, 48 self-adhesive strips per card, plain

Color	Item No.	Pack. Unit
○ white	210-334	1



Syringe, contains 20 ml "Alu-Plus" contact paste

Item No.	Pack. Unit
249-130	20 (5)

## Vario-T-BOXX

### The COMPACT Splicing Connector Line-Up



Vario-T-BOXX		
	Item No.	Pack. Unit
	887-912	1

#### Contains:

#### COMPACT PUSH WIRE® Connectors for Junction Boxes

3 x 0.5 ... 2.5 mm <sup>2</sup>	2273-203	100
5 x 0.5 ... 2.5 mm <sup>2</sup>	2273-205	100
8 x 0.5 ... 2.5 mm <sup>2</sup>	2273-208	50

#### COMPACT Splicing Connectors

3 x 0.14 ... 4 mm <sup>2</sup>	221-413	50
5 x 0.14 ... 4 mm <sup>2</sup>	221-415	25

#### Lighting Connectors

2 x 1 ... 2.5 mm <sup>2</sup> "s"	224-112	100
-----------------------------------	---------	-----

#### PUSH WIRE® Connectors for Junction Boxes

1.5 ... 4 mm <sup>2</sup> "s"	773-604	100
-------------------------------	---------	-----

#### MICRO PUSH WIRE® Connectors for Junction Boxes

4 x 0.6 ... 0.8 mm Ø	243-204	100
4 x 0.6 ... 0.8 mm Ø	243-804	100
8 x 0.6 ... 0.8 mm Ø	243-208	50

#### Mounting Carriers

for 6 Connectors	243-113	10
------------------	---------	----

Width	440 mm / 17.322 inch
Height	80 mm / 3.15 inch
Depth	350 mm / 13.78 inch

# Lighting Connectors, 224 Series

## Installation Side

### Description and Installation

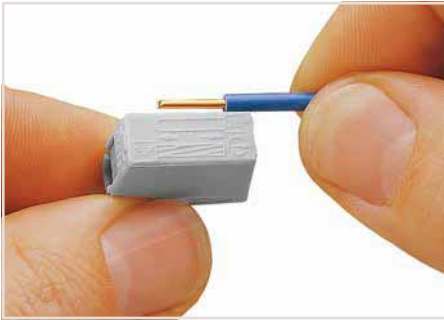

Strip conductor to 9 ... 11 mm (0.35 ... 0.43 inch).

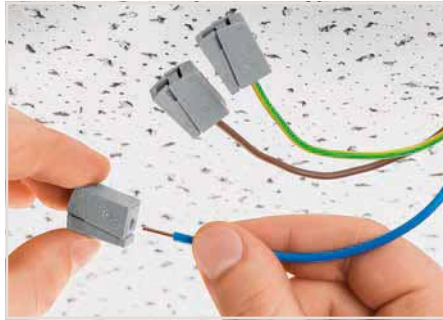

To connect: Insert stripped solid conductor into circular entry and push until it hits the backstop.

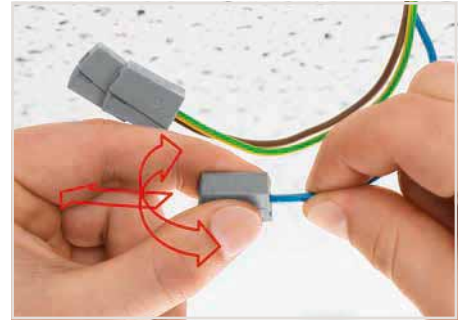

To remove: Hold conductor to be removed and twist alternately left and right while slightly pulling the connector.

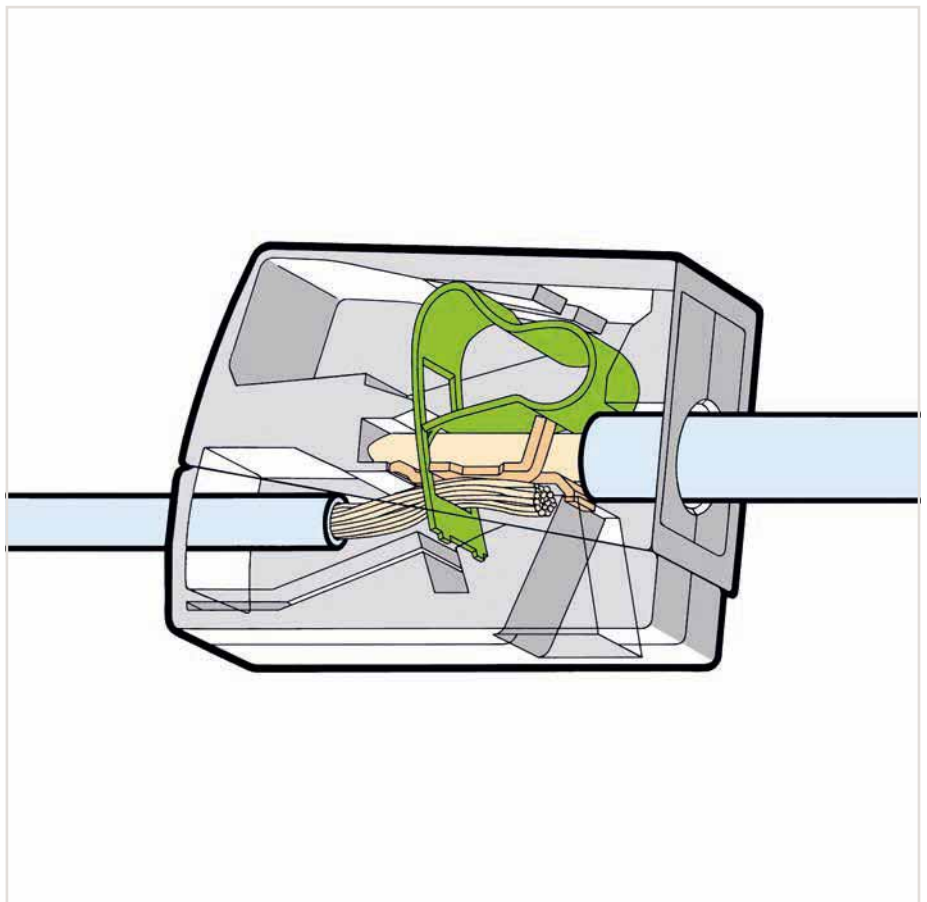

12



Testing via separate test ports.

# Lighting Connectors, 224 Series

## Lighting Side

### Description and Installation

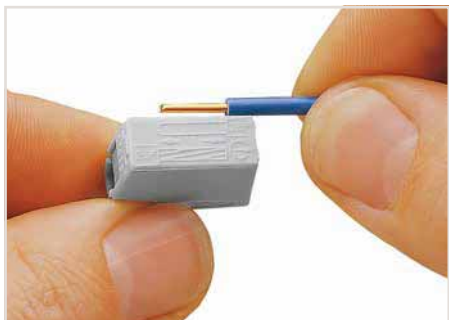

Strip conductor to 9 ... 11 mm (0.35 ... 0.43 inch).



To connect: Press button fully, insert stripped conductor into square entry and release.

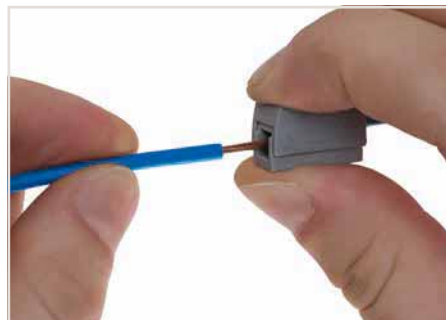

To remove: Press button and withdraw conductor.

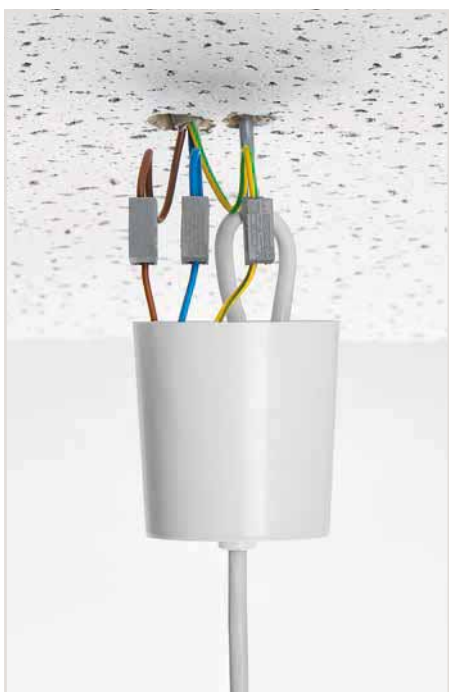

Connecting solid conductors with fine-stranded conductors via lighting connectors (224-101).



Wiring lighting connectors in a junction box.



## Lighting and "Service" Connectors

### 2.5 mm<sup>2</sup>, 224 Series

The WAGO lighting connectors ideally connect solid conductors with fine-stranded conductors. Tested and approved as isolated splicing connectors per VDE 0606, WAGO's 224 Series Lighting Connectors can also be used in applications requiring a connection between solid and fine-stranded conductors. For example, 224 Series connects:

- Blinds, sliding shutters or awning motors
- Window or bathroom fans
- Circulation pumps
- Furnace control systems
- Electrical devices via permanent flexible cables



Dimensions in mm

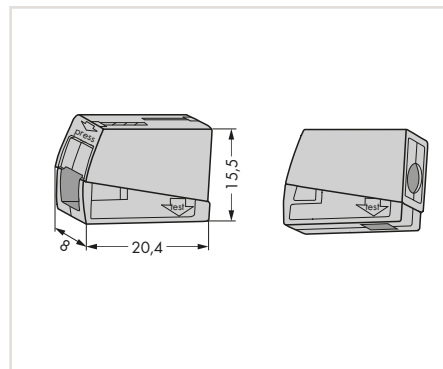

Lighting connector, standard version, max. continuous operating temperature of 105 °C, max. ambient operating temperature of 60 °C

Color	Item No.	Pack. Unit
○ gray	224-101	1000 (100)

Lighting connector, version for increased continuous operating temperature of 120 °C, max. ambient operating temperature of 75 °C

Color	Item No.	Pack. Unit
● black	224-104	100



#### Technical data

Nominal voltage (II / 2)	400 V
Nominal surge voltage (II / 2)	4 kV
Rated current	24 A
Approval	300 V, 20 A <sup>Ⓢ</sup> ; 300 V, 20 A <sup>Ⓣ</sup>

#### Connection Data

Connector	Installation side
Connection technology	PUSH WIRE®
Solid conductor	1 ... 2.5 mm / 14 ... 12 AWG
Fine-stranded conductor	

#### Connection Data (2)

Connector (2)	Lighting side
Connection technology (2)	CAGE CLAMP®
Solid conductor (2)	0.5 ... 2.5 mm / 20 ... 16 AWG
Fine-stranded conductor (2)	0.5 ... 2.5 mm / 20 ... 16 AWG
Strip length	9 ... 11 mm / 0.35 ... 0.43 inch

#### Note

In grounded power lines

#### Accessories (Selection)

Syringe, contains 20 ml "Alu-Plus" contact paste

Item No.	Page
249-130	729

Aluminum conductors, see notes in Section 14

Approvals and corresponding ratings, visit [www.wago.com](http://www.wago.com)





Dimensions in mm

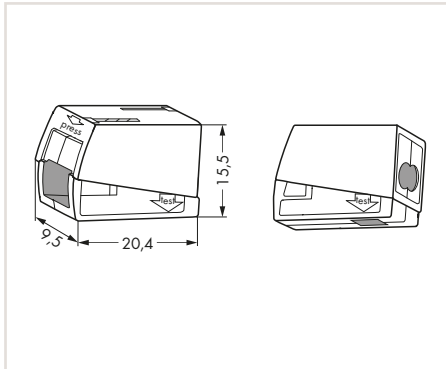

2-conductor lighting connector, standard version, max. continuous operating temperature of 105 °C, max. ambient operating temperature of 60 °C

Color	Item No.	Pack. Unit
○ white	224-112	1000 (100)

2-conductor lighting connector, version for increased continuous operating temperature of 120 °C, max. ambient operating temperature of 75 °C

Color	Item No.	Pack. Unit
● black	224-114	100



400 V  
4 kV  
24 A  
300 V, 20 A<sup>Ⓢ</sup>; 300 V, 20 A<sup>Ⓢ</sup>

Installation side  
PUSH WIRE®  
1 ... 2.5 mm / 14 ... 12 AWG

Lighting side  
CAGE CLAMP®  
0.5 ... 2.5 mm / 20 ... 16 AWG  
0.5 ... 2.5 mm / 20 ... 16 AWG  
9 ... 11 mm / 0.35 ... 0.43 inch  
In grounded power lines

Item No.	Page
249-130	729

Dimensions in mm

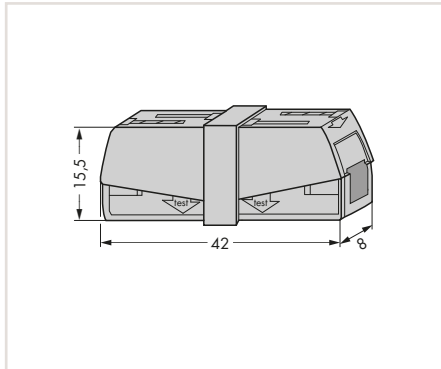

"Service" connector, max. continuous operating temperature of 105 °C, max. ambient operating temperature of 60 °C

Color	Item No.	Pack. Unit
○ gray	224-201	50



400 V  
4 kV  
24 A  
300 V, 20 A<sup>Ⓢ</sup>; 300 V, 20 A<sup>Ⓢ</sup>

CAGE CLAMP®  
0.5 ... 2.5 mm / 20 ... 16 AWG  
0.5 ... 2.5 mm / 20 ... 16 AWG

9 ... 11 mm / 0.35 ... 0.43 inch  
In grounded power lines

Item No.	Page
249-130	729

## Luminaire Disconnect Connectors (U.S. Version), 12 AWG, 873 Series

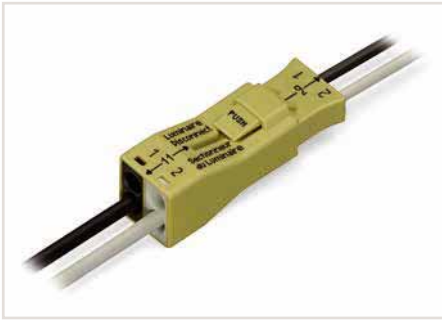

Luminaire disconnect connector, 2-pole (873-902)

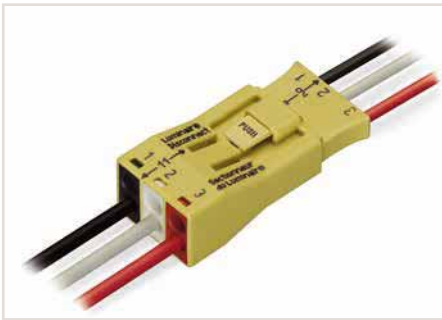

Luminaire disconnect connector, 3-pole (873-903)

873 Series approvals per EN 60998 and EN 61984:

**EN 60998**  
0.75 mm<sup>2</sup> (solid), 6 A for socket  
1.5 ... 4 mm<sup>2</sup> (solid), 32 A for plug  
400 V / 4 kV / 2

**EN 61984**  
0.75 mm<sup>2</sup> (solid), 6 A for socket  
0.75 ... 4 mm<sup>2</sup> (solid), 32 A for plug  
400 V / 4 kV / 2



Luminaire disconnect connector		
Pole No.	Item No.	Pack. Unit
2	873-902	20



### Technical data

Ratings per

EN 60998

Ratings per 2

EN 61984

### Connection Data

Connection technology

PUSH WIRE®

Solid conductor

1.5 ... 4 mm<sup>2</sup> / 16 ... 12 AWG (plug)  
0.75 mm<sup>2</sup> / 18 AWG (socket)

Stranded conductor

1.5 ... 4 mm<sup>2</sup> / 16 ... 12 AWG (plug)

### Connection Data (2)

Solid conductor (2)

0.75 ... 4 mm<sup>2</sup> / 18 ... 12 AWG (plug)  
0.75 mm<sup>2</sup> / 18 AWG (socket)

Strip length

11 ... 13 mm / 0.43 ... 0.51 inch (plug)

Strip length (2)

9 ... 11 mm / 0.35 ... 0.43 inch (socket)

### Accessories (Selection)

Syringe, contains 20 ml "Alu-Plus" contact paste

Item No.	Page
249-130	729

Touchproof connectors are required for ballast supply cables in the USA and Canada. When exchanging a ballast:

1. The touch-proof plug-in connection is disconnected first
2. The ballast is replaced
3. Network connection is restored by plugging the connection This streamlines ballast replacement while enhancing safety by safeguarding the installer from electric shock. The 873 Series connectors are approved to UL 2459 and CSA 22.2 for this type of application.



Approvals and corresponding ratings, visit [www.wago.com](http://www.wago.com)

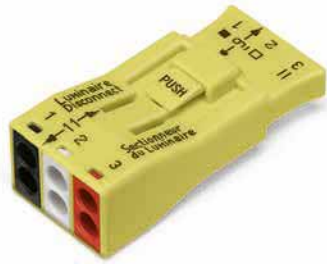

Luminaire disconnect connector

Pole No.	Item No.	Pack. Unit
3	873-903	20



EN 60998  
EN 61984

PUSH WIRE®

1.5 ... 4 mm<sup>2</sup> / 16 ... 12 AWG (plug)  
0.75 mm<sup>2</sup> / 18 AWG (socket)  
1.5 ... 4 mm<sup>2</sup> / 16 ... 12 AWG (plug)

0.75 ... 4 mm<sup>2</sup> / 18 ... 12 AWG (plug)  
0.75 mm<sup>2</sup> / 18 AWG (socket)  
11 ... 13 mm / 0.43 ... 0.51 inch (plug)  
9 ... 11 mm / 0.35 ... 0.43 inch (socket)

Item No.	Page
249-130	729

Luminaire disconnect connector, preceding ground contact, center position

Pole No.	Item No.	Pack. Unit
3	873-953	500



EN 60998  
EN 61984

CAGE CLAMP®

1.5 ... 4 mm<sup>2</sup> / 16 ... 12 AWG (plug)  
0.75 mm<sup>2</sup> / 18 AWG (socket)  
1.5 ... 4 mm<sup>2</sup> / 16 ... 12 AWG (plug)





0.75 ... 4 mm<sup>2</sup> / 18 ... 12 AWG (plug)  
0.75 mm<sup>2</sup> / 18 AWG (socket)  
11 ... 13 mm / 0.43 ... 0.51 inch (plug)  
9 ... 11 mm / 0.35 ... 0.43 inch (socket)

Item No.	Page
249-130	729



## **Accessories and Tools**

## Shield Connection Systems, Marking Systems, Accessories and Tools

		Page
	Shield Clamping Saddles	790 Series 767
	Spring-Equipped Shield Clamping Saddles	790 Series 769
	Busbar Carriers	790 Series 774
	Marking Systems for Varying Terminal Block Widths	780
	End Stops for DIN-35 and DIN-15 Rails	785
	Carrier Rails, Collective Jumper Carriers and Rail-Mount Terminal Block Covers	786
	Operating Tools	792
	Stripping Tools	796
	Crimping Tools for Ferrules	797
	Cable Cutter	797
	Test and Measurement Devices	802
	General Test Accessories	804

## Shield Connection System, 790 Series Description and Installation



Carrier with grounding foot\* (790-113)  
45 mm long, busbar 90° to the rail

\* for all sizes of shield clamping saddles



Carrier with grounding foot\* (790-114)  
45 mm long, busbar parallel to the rail

\* for all sizes of shield clamping saddles

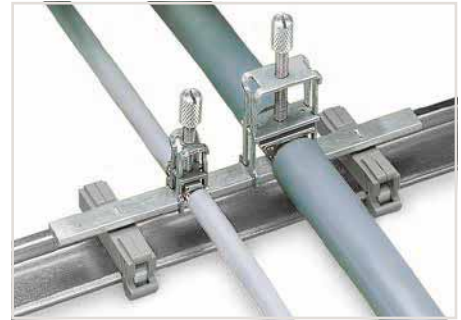

Carrier with grounding foot\* (790-115),  
125 mm long, busbar parallel to the rail

\* for all sizes of shield clamping saddles

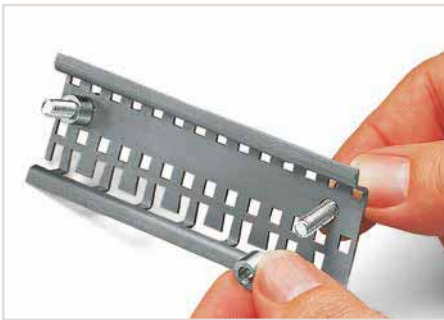

Fitting a spacer sleeve to a specialty slotted carrier rail.



Fitting an additional clamping saddle.

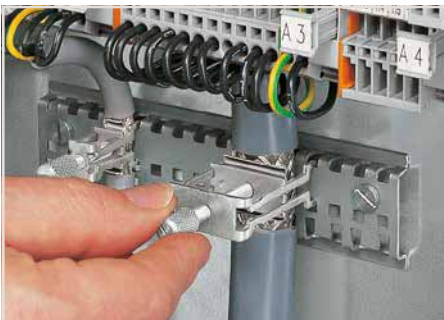
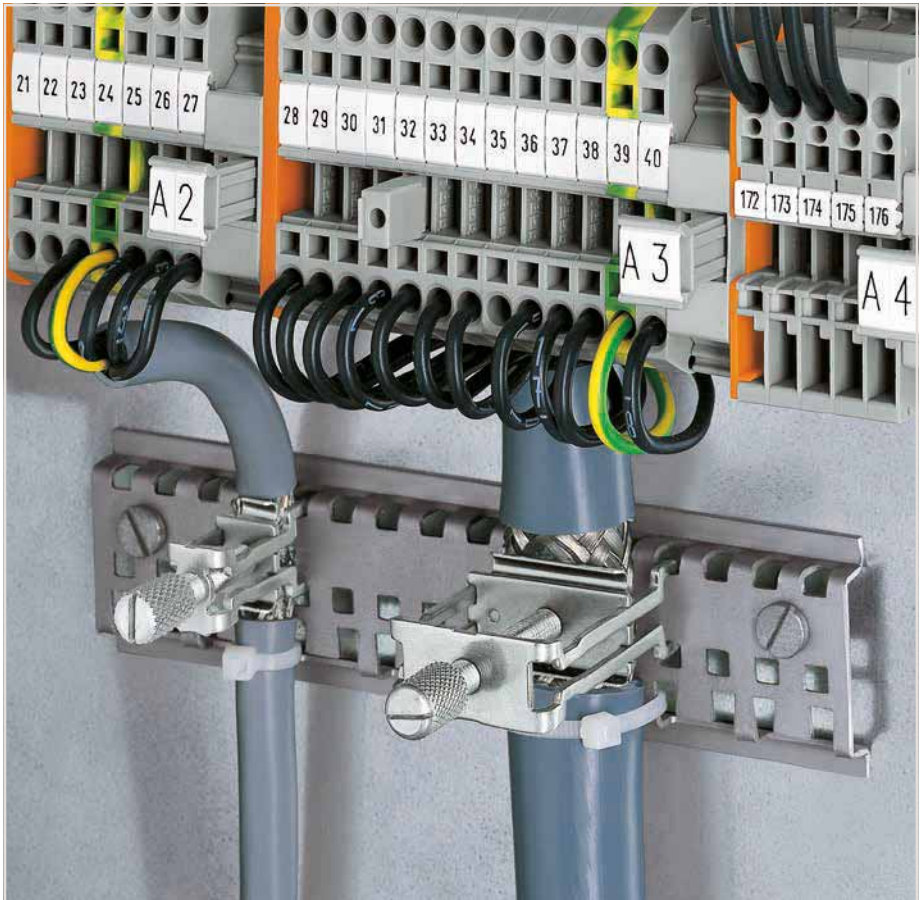

Tightening/removing a shield clamping saddle.

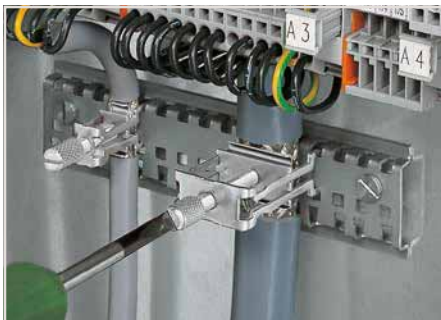

After connection, tighten the knurled screw to complete the installation.  
Recommended tightening torque: 0.5 Nm



To remove the clamping saddle, unscrew until ratcheted mechanism is released, then slightly tip saddle and remove the clamping saddle.



# Shield Connection System, 790 Series Installation

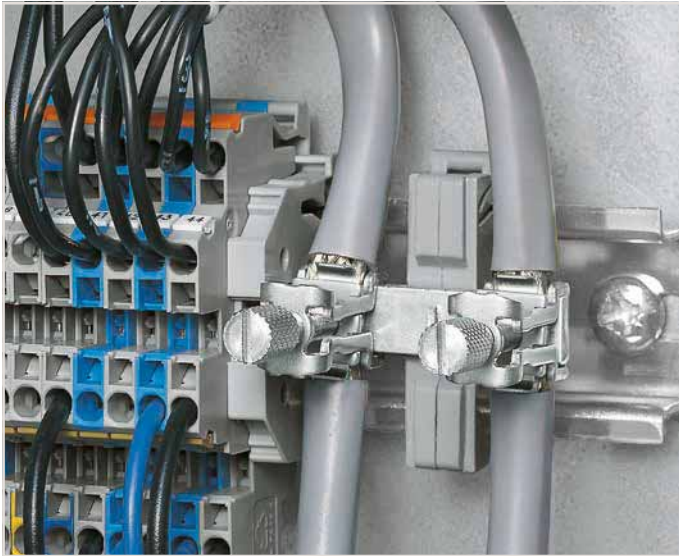

Carrier with grounding foot – busbar parallel to the rail



Insulated mounting carriers for a common shield reference potential, independent of housing potential

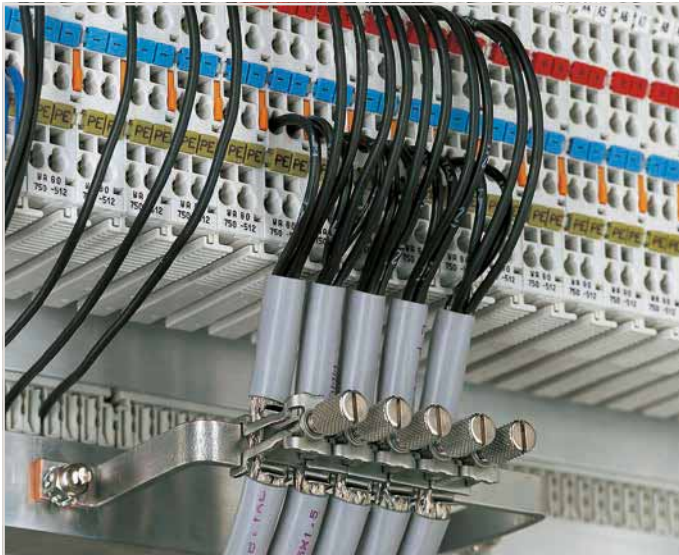

U-shaped (10 x 3) mm copper busbar

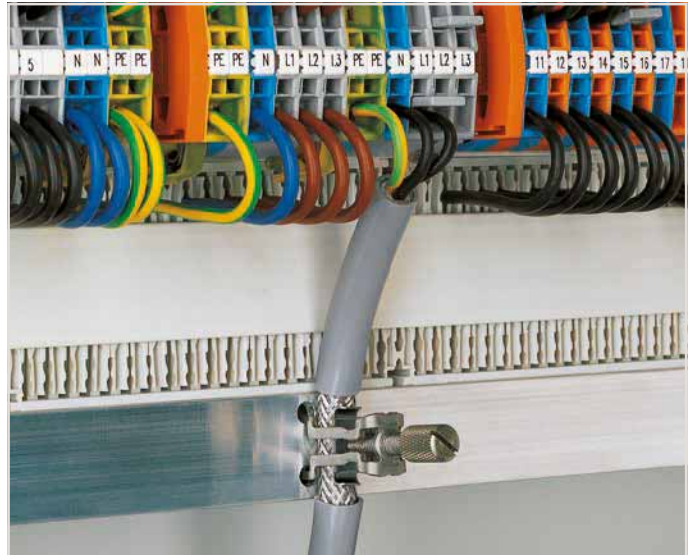

Snap shield clamping saddles into any metal plate (max. thickness: 3 mm).

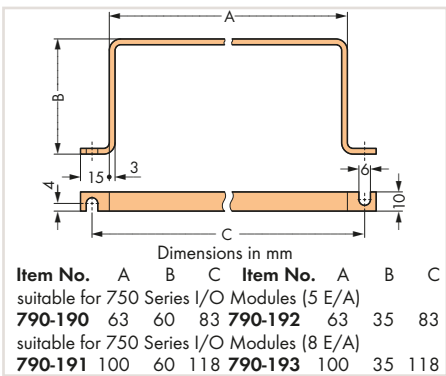

Dimensions in mm

## Hole dimensions for panel mounting

Shield (screen) clamping saddle size

- Distance X  
11 mm 9.5 mm
- Distance Y  
19 mm 17.5 mm  
27 mm 25.5 mm  
43 mm 41.5 mm

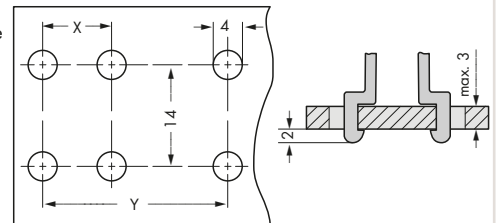

Additionally, the spring material is part of the clamping saddle, providing a good electrical connection (the system also acts as a partial strain relief). The spring element integrated in the shield clamping saddle compensates for deformation and settling that results from a connected shield.

## Shield Connection System, 790 Series Installation



**Assembly:**

The shield clamping saddle is shipped ready for direct connection to the (10 x 3) mm busbar or to a drilled mounting plate. After connection, tighten the knurled screw to complete the installation.  
Maximum tightening torque: 0.5 Nm

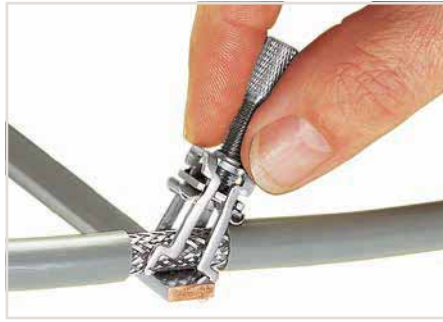

**Removal:**

To remove the clamping saddle, unscrew until ratcheted mechanism is released, then slightly tip saddle and remove the clamping saddle.

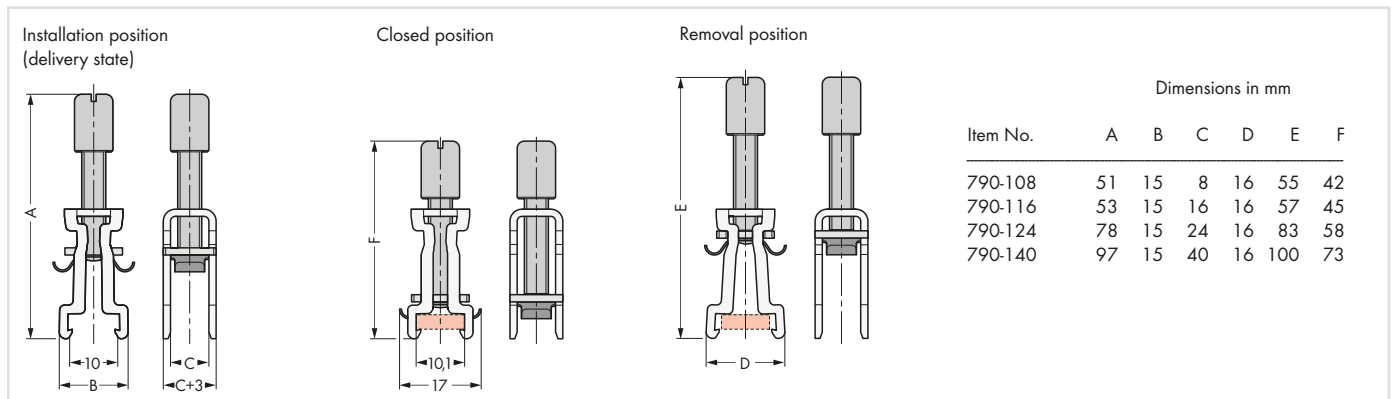

Dimensions in mm

### Negative Shield Attenuation

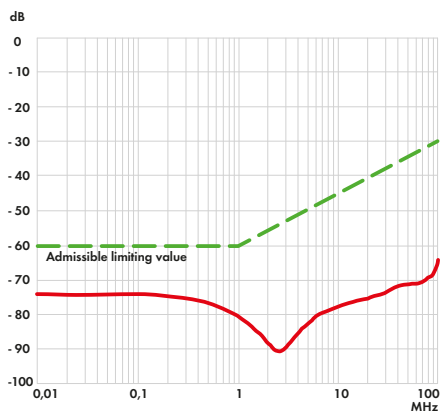

WAGO's shield connection system is highly effective because the clamping unit can be brought very close to the unshielded part of the cable.

## Shield Clamping Saddles 790 Series



Shield clamping saddle, 11 mm wide, max. shield diameter of 8 mm  
Note: Cannot be used for connecting ground conductors!

	Item No.	Pack. Unit
	790-108	50 (10)



Shield clamping saddle, 19 mm wide, 7 ... 16 mm shield diameter  
Note: Cannot be used for connecting ground conductors!

	Item No.	Pack. Unit
	790-116	50 (10)



Shield clamping saddle, 27 mm wide, 6 ... 24 mm shield diameter  
Note: Cannot be used for connecting ground conductors!

	Item No.	Pack. Unit
	790-124	50 (10)



Shield clamping saddle, 43 mm wide, 22 ... 40 mm shield diameter  
Note: Cannot be used for connecting ground conductors!

	Item No.	Pack. Unit
	790-140	50 (10)

## Spring-Equipped Shield Clamping Saddles, 790 Series Installation



Shield clamping saddles are available in three different sizes for shield diameters ranging from 3 to 20 mm.

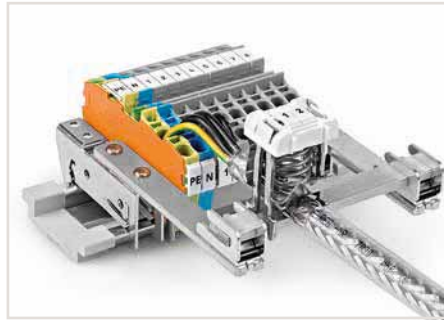

Application example



Compress the clamping saddle until fully engaged.



Mounting a clamping saddle on a specialty slotted carrier rail (790-145).  
When releasing the saddle, do not place your finger under the clamping spring!



Removing the shield clamping saddle.



Shield clamping saddle contacts shield conductor and specialty slotted carrier rail (790-145).



Labelling using a marking strip.



Labelling using WMB markers.

Delivery position

Mounting position

Item No.	Dimensions in mm				
	A	B	C	D	E*
790-208	30	29.9	8	12.4	25.8
790-216	34.6	28.3	16	21.8	30.2
790-220	45.6	28.3	24	30	41.2

\*Height with WMB marker

Dimensions in mm

## Spring-Equipped Shield Clamping Saddles 790 Series



Shield clamping saddle, 12.4 mm wide, 3 ... 8 mm shield diameter  
 Note: Cannot be used for connecting ground conductors and strain relief!

Item No.	Pack. Unit
790-208	50

Shield clamping saddle, 21.8 mm wide, 6 ... 16 mm shield diameter  
 Note: Cannot be used for connecting ground conductors and strain relief!

Item No.	Pack. Unit
790-216	25

Shield clamping saddle, 27 mm wide, 6 ... 20 mm shield diameter  
 Note: Cannot be used for connecting ground conductors and strain relief!

Item No.	Pack. Unit
790-220	25



## Shield Clamps and Shield Termination 791 and 709 Series



Insert the shield termination into the female plug using the operating tool.

Shield clamp, 10 ... 17 mm shield diameter, max. 63 mm high, 23 mm wide  
Note: Cannot be used for connecting ground conductors!

Item No.	Pack. Unit
791-117	50

Shield termination, includes cable ties for 5 mm and 10 mm shield diameter

Item No.	Pack. Unit
709-350	100 (25)

Shield clamp, 1.5 ... 6.5 mm shield diameter, max. 40 mm high, 10 mm wide  
Note: Cannot be used for connecting ground conductors!

Item No.	Pack. Unit
791-107	50

Shield termination, includes cable ties for 5 mm and 10 mm shield diameter

Item No.	Pack. Unit
709-352	100 (25)



Fit the shield termination to the shield cable.

Shield clamp, 5 ... 11 mm shield diameter, max. 47 mm high, 17 mm wide  
Note: Cannot be used for connecting ground conductors!

Item No.	Pack. Unit
791-111	50

Shield clamp, 16 ... 24 mm shield diameter, max. 78 mm high, 30 mm wide  
Note: Cannot be used for connecting ground conductors!

Item No.	Pack. Unit
791-124	50



Secure both shield cable and shield termination to the strain relief plate using cable ties.

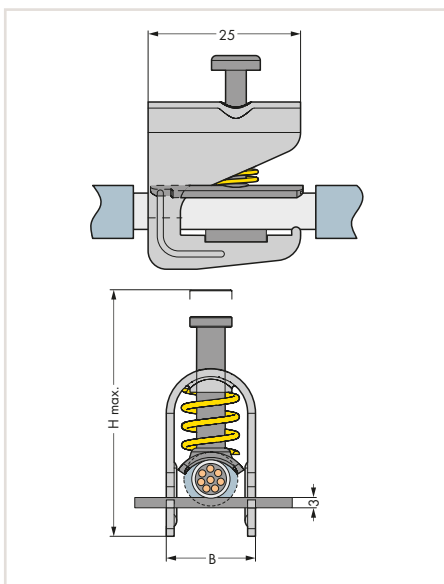

Dimensions in mm



Shield termination connected to an X-COM® female plug



## Accessories for Shield Connection Systems



Carrier with grounding foot, busbar parallel to the rail, 15 mm long, for (10 x 3) mm copper busbars, for shield clamping saddles (790-108)

Item No.	Pack. Unit
790-110	25



Carrier with grounding foot, busbar parallel to the rail, 25 mm long, for (10 x 3) mm copper busbars, for shield clamping saddles (790-108, 790-116) and shield clamps (791-111, 791-117)

Item No.	Pack. Unit
790-112	25



Carrier with grounding foot, busbar 90° to the rail, 45 mm long, for (10 x 3) mm copper busbars, for shield clamping saddles (790 Series)

Item No.	Pack. Unit
790-113	25



Carrier with grounding foot, busbar parallel to the rail, 45 mm long, for (10 x 3) mm copper busbars, for shield clamping saddles (790 Series) and shield clamps (791 Series)

Item No.	Pack. Unit
790-114	25



Carrier with two grounding feet, busbar parallel to the rail, 125 mm long, for (10 x 3) mm copper busbars

Item No.	Pack. Unit
790-115	25



Busbar, tin-plated, 1000 mm long, copper (10 x 3) mm, I<sub>N</sub> 140 A

Item No.	Pack. Unit
210-133	1



Busbar, tin-plated, 30 mm long, copper (10 x 3) mm

Item No.	Pack. Unit
790-133	20



Busbar, tin-plated, 50 mm long, copper (10 x 3) mm

Item No.	Pack. Unit
790-134	20



Carrier rail, specialty slotted, 1000 mm long, tin-plated

Item No.	Pack. Unit
790-145	1



Spacer sleeve, for carrier rail, for M5-size screw, specialty slotted

Item No.	Pack. Unit
790-144	200 (100)

## Accessories for Shield Connection Systems



Insulated mounting foot, for busbar with M4 x 8 mm screw		
Color	Item No.	Pack. Unit
gray	790-100	50 (25)



Insulated mounting foot, for busbar with (3.5 x 9) mm sheet metal screw		
Color	Item No.	Pack. Unit
gray	790-101	50 (25)



U-shaped busbar, copper (10 x 3) mm, for 750 Series I/O Modules		
	Item No.	Pack. Unit
for 5 I/O	790-190	25 (5)



U-shaped busbar, copper (10 x 3) mm, for 750 Series I/O Modules		
	Item No.	Pack. Unit
for 8 I/O	790-191	25



U-shaped busbar, copper (10 x 3) mm, for 750 Series I/O Modules		
	Item No.	Pack. Unit
for 5 I/O	790-192	25



U-shaped busbar, copper (10 x 3) mm, for 750 Series I/O Modules		
	Item No.	Pack. Unit
for 8 I/O	790-193	25

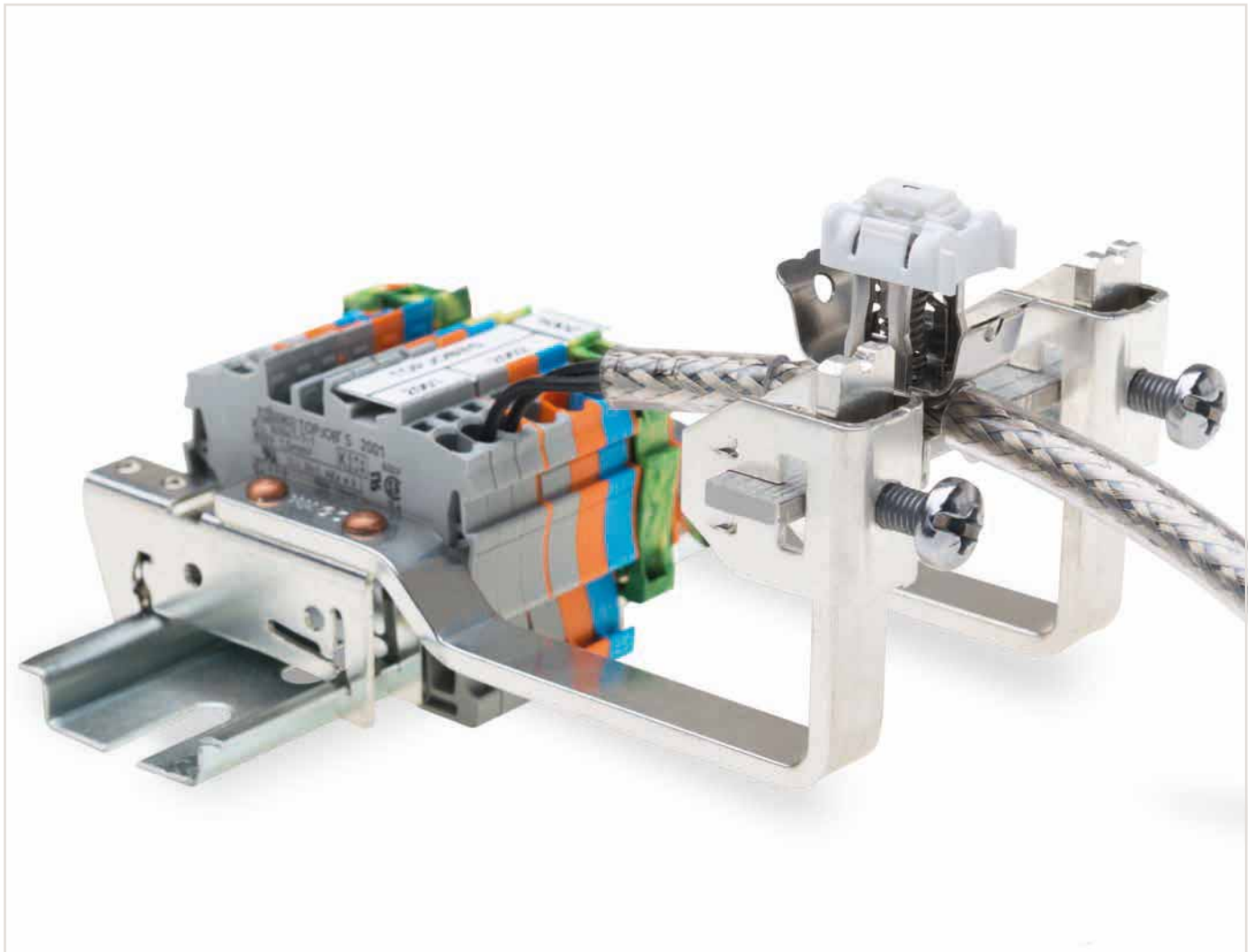

# Busbar Carriers

## 790 Series



Dimensions in mm

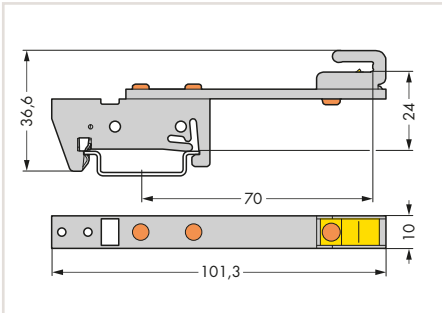

Busbar carrier, for (10 x 3) mm copper busbars, single side, straight, 70 mm between center of DIN-rail and busbar carrier

Item No.	Pack. Unit
790-300	10

Dimensions in mm

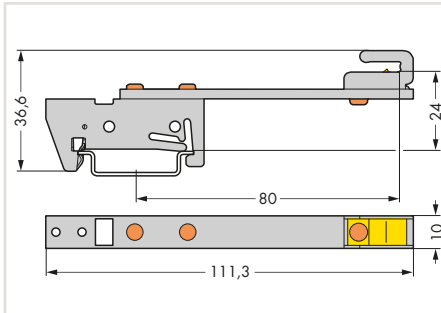

Busbar carrier, for (10 x 3) mm copper busbars, single side, straight, 80 mm between center of DIN-rail and busbar carrier

Item No.	Pack. Unit
790-302	10

Dimensions in mm

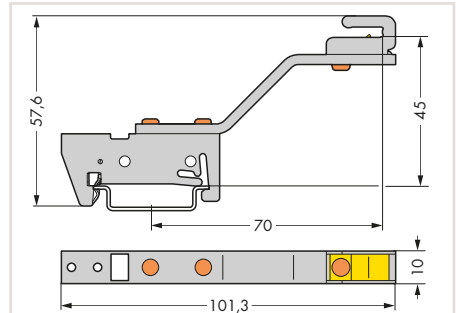

Busbar carrier, for (10 x 3) mm copper busbars, single side, angled, 70 mm between center of DIN-rail and busbar carrier

Item No.	Pack. Unit
790-301	10



Place the busbar in the busbar carrier.



Remove the busbar carrier using an operating tool (type 3, 5.5 x 0.8 mm blade).

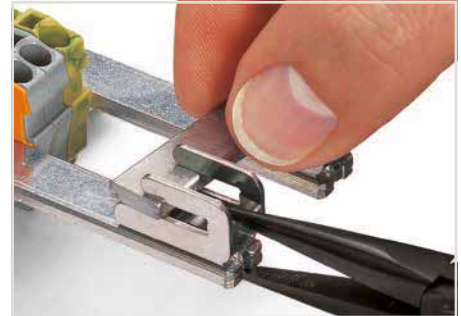

To remove the busbar, compress the spring using pliers.



Dimensions in mm

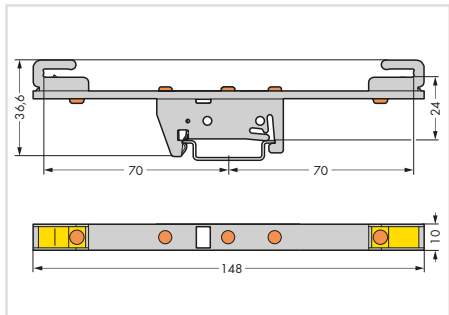

Busbar carrier, for (10 x 3) mm copper busbars, both sides, straight, 70 mm between center of DIN-rail and busbar carrier

Item No.	Pack. Unit
790-310	10

Dimensions in mm

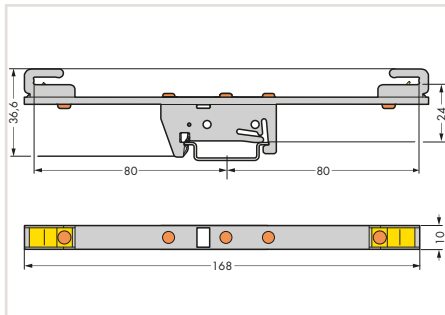

Busbar carrier, for (10 x 3) mm copper busbars, both sides, straight, 80 mm between center of DIN-rail and busbar carrier

Item No.	Pack. Unit
790-312	10

Dimensions in mm

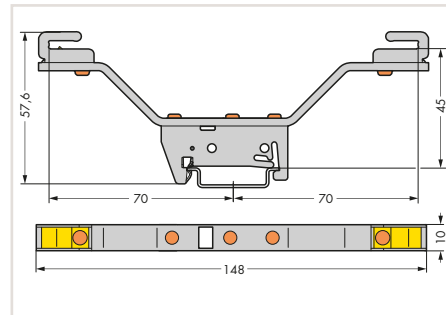

Busbar carrier, for (10 x 3) mm copper busbars, both sides, angled, 70 mm between center of DIN-rail and busbar carrier

Item No.	Pack. Unit
790-311	10

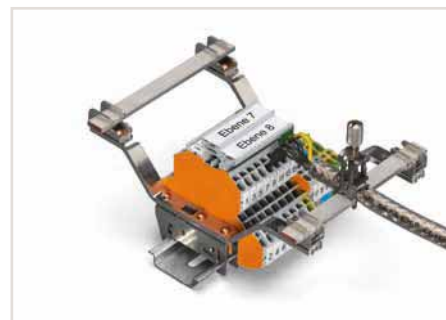

Application example

# Busbar Carriers with a T-Connector (Flexible) and T-Connector 790 Series

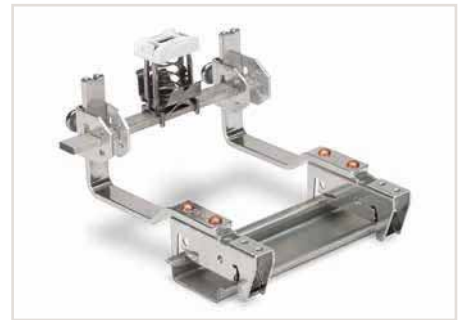

Horizontal mounting position of the busbar

Dimensions in mm

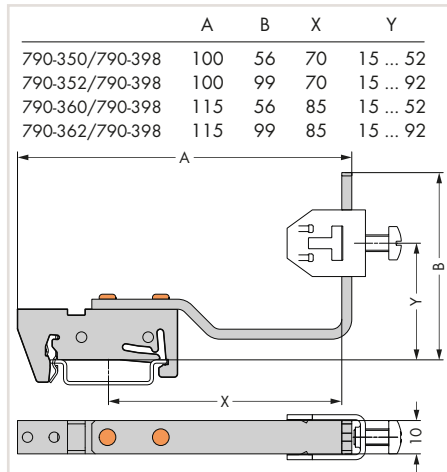

Dimensions in mm

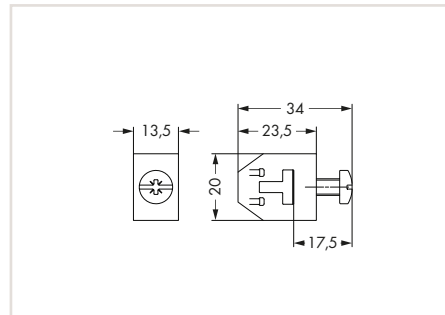

Vertical mounting position of the busbar

Busbar carrier with a T-connector, flexible, for (10 x 3) mm copper busbars, 70 mm between center of DIN-rail and busbar carrier, 56 mm high

Item No.	Pack. Unit
790-350/790-398	12

T-connector, connects two (10 x 3) mm copper busbars

Item No.	Pack. Unit
790-398	10

Busbar carrier with a T-connector, flexible, for (10 x 3) mm copper busbars, 70 mm between center of DIN-rail and busbar carrier, 99 mm high

Item No.	Pack. Unit
790-352/790-398	12



The height of the busbar can be adjusted.

Busbar carrier with a T-connector, flexible, for (10 x 3) mm copper busbars, 85 mm between center of DIN-rail and busbar carrier, 56 mm high

Item No.	Pack. Unit
790-360/790-398	12

Busbar carrier with a T-connector, flexible, for (10 x 3) mm copper busbars, 85 mm between center of DIN-rail and busbar carrier, 99 mm high

Item No.	Pack. Unit
790-362/790-398	25



Secure the busbar by tightening the screws at the required position.



# Busbar Carriers

## 790 Series

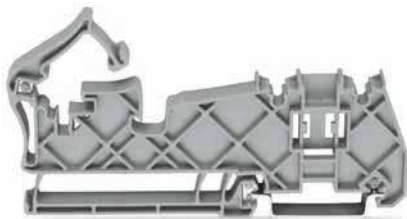

Dimensions in mm

Snap the busbar carrier onto DIN-35 rail.

Vertical mounting position of the busbar

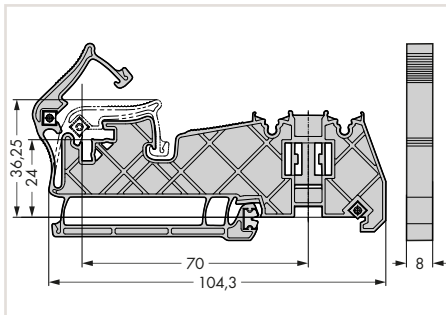

Busbar carrier, for (10 x 3) mm copper busbars, no contact to DIN-rail, insulated

Color	Item No.	Pack. Unit
gray	790-400	20

Place the busbar in the carrier holder.

Horizontal mounting position of the busbar



Snap the mounting bracket into position.

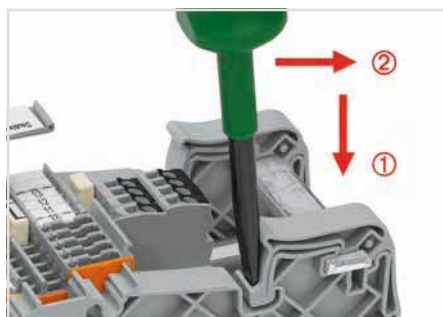

Release the mounting bracket by pushing the operating tool down ① and then forward ②.

# Marking Systems

## Description and Installation

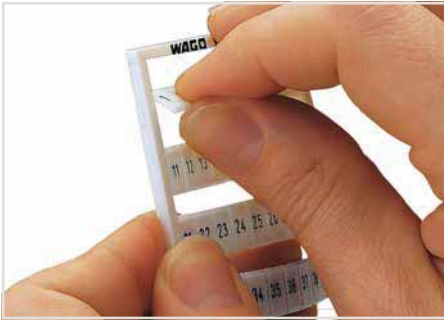

WMB Multi Marking System:  
Separating a strip from the WMB or WMB marker card.



Stretching a strip.



Separating an individual marker from the strip – for larger terminal blocks.



Mini-WSB (WAGO Quick Marking System):  
Marking via Mini-WSB Quick markers.

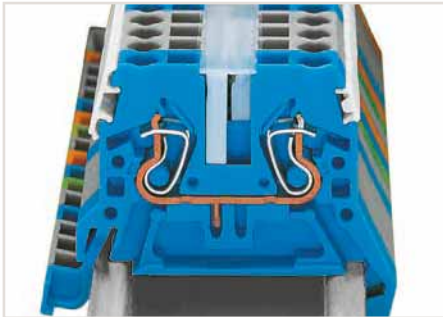
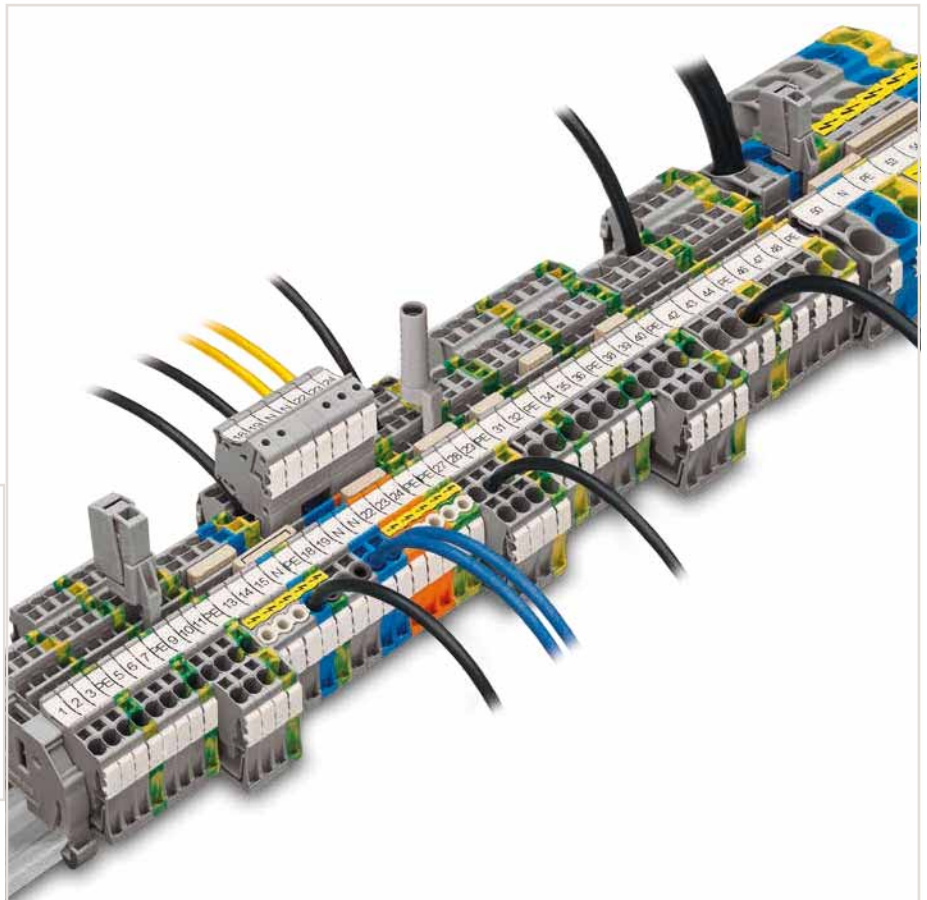

WMB markers in Mini-WSB marker slots  
Marking strip, translucent  
Mini-WSB markers



WMB Inline

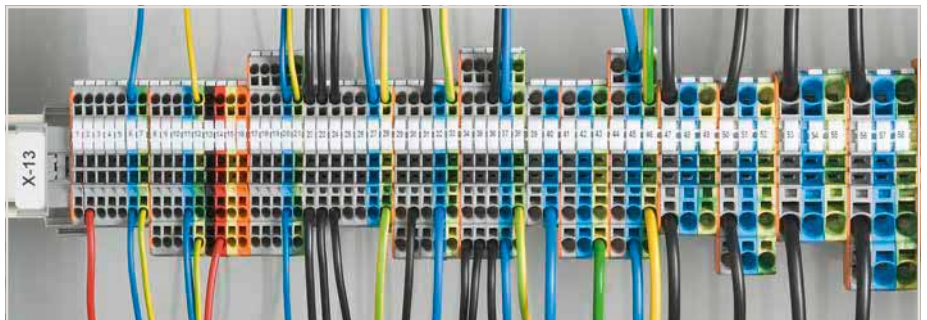

WMB Inline



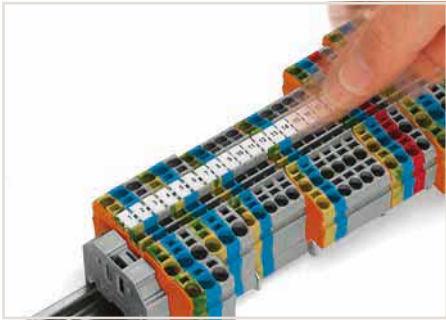

WMB Inline:  
Snapping a strip into the marker slots.

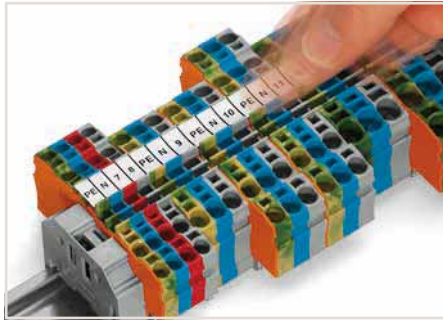

Marking strips:  
Snapping a strip into the marker slots.



WMB "decade" marking

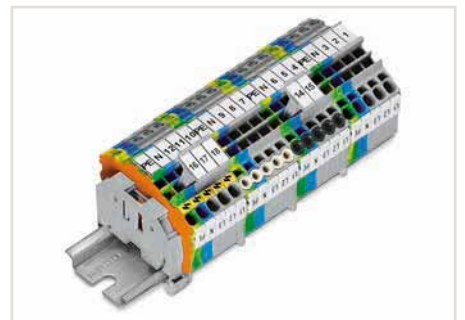

Group marker carriers for TOPJOB® S terminal blocks – snap-on type for jumper slot

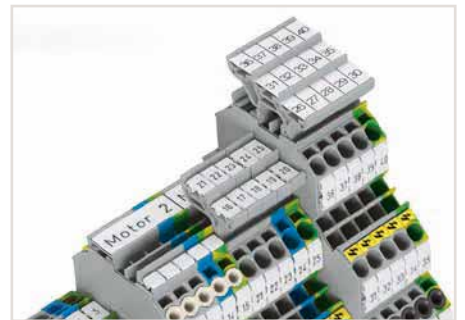

Height-adjustable group marker carrier (249-116) for TOPJOB® S marking strips (2009-110)



Group marking on N-busbar carrier used as end stop



Height-adjustable group marker carrier

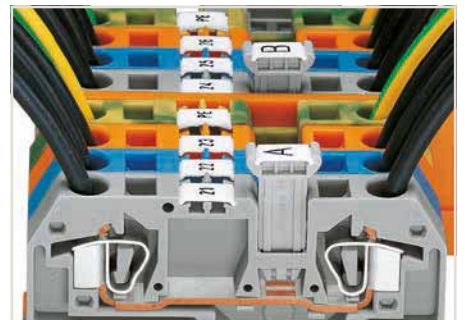

Additional group marking

## WMB Multi Marking Systems for Terminal Widths 3.5 mm, 4 ... 4.2 mm and from 5 mm

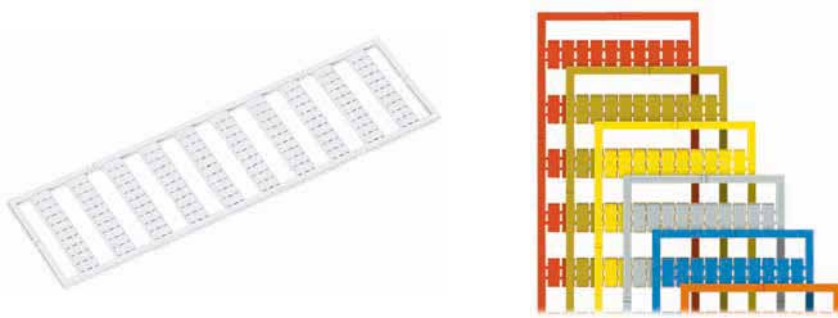

- 5 mm wide markers for continuous marking of 270, 280, 780, 869, 870, 880 and individual marking of 281 ... 285, 781 ... 785, 2002, 2003, 2022, 2004, 2006, 2010 and 2016 Series terminal blocks
- 5 ... 5.2 mm wide markers for continuous marking of 270, 280, 780, 869, 870, 880, 2002, 2003 and 2022 Series terminal blocks and individual marking of terminal blocks larger than 5/5.2 mm
- 4 ... 4.2 mm wide markers for continuous marking of 279 and 2001 Series terminal blocks
- 3.5 mm wide markers for continuous marking of 2000 and 2020 Series terminal blocks

### WMB Multi marking system, 10 strips with 10 markers per card, plain

Marking	5 mm Item No.	5 ... 5.2 mm Item No.	4 ... 4.2 mm Item No.	3.5 mm Item No.	Pack. Unit
white	793-501	793-5501	793-4501	793-3501	5
yellow	793-501/000-002	793-5501/000-002	793-4501/000-002		5
red	793-501/000-005	793-5501/000-005	793-4501/000-005		5
blue	793-501/000-006	793-5501/000-006	793-4501/000-006		5
gray	793-501/000-007	793-5501/000-007	793-4501/000-007		5
orange	793-501/000-012	793-5501/000-012	793-4501/000-012		5
brown		793-5501/000-014	793-4501/000-014		5
light green	793-501/000-017	793-5501/000-017	793-4501/000-017		5
green	793-501/000-023	793-5501/000-023	793-4501/000-023		5
violet	793-501/000-024	793-5501/000-024	793-4501/000-024		5



### WMB Inline, plain, 2,000 WMB markers (4 mm) per reel, 4 ... 4.2 mm stretchable

Color	Item No.	Pack. Unit
white	2009-114	1

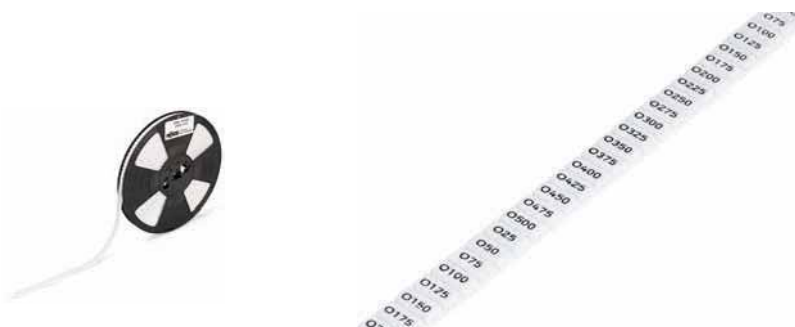

### WMB Inline, plain, 1,500 WMB markers (5 mm) per reel, 5 ... 5.2 mm stretchable

Color	Item No.	Pack. Unit
white	2009-115	1

## Mini-WSB Quick Marking System



Mini-WSB Quick marking system, white, 10 strips with 10 markers per card, 5 mm wide markers		
Marking	Item No.	Pack. Unit
plain	248-501	5

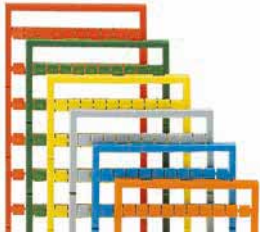

Mini-WSB Quick marking system, 10 strips with 10 markers per card, 5 mm wide markers, plain		
Color	Item No.	Pack. Unit
yellow	248-501/000-002	5
red	248-501/000-005	5
blue	248-501/000-006	5
gray	248-501/000-007	5
orange	248-501/000-012	5
light green	248-501/000-017	5
green	248-501/000-023	5
violet	248-501/000-024	5



Mini-WSB Quick marking system, white, 10 strips with 10 markers per card, 5 mm wide markers			
Suitable for:	Marking	Item No.	Pack. Unit
4-conductor terminal blocks	1, , 2, , 3, , 4, , 5, ; to 46, , 47, , 48, , 49, , 50, ; (each 1x)	264-900	5
	U, , V, , W, , N, , PE, ; (10x)	264-901	5
	L1, , L2, , L3, , N, , PE, ; (10x)	264-902	5
	1, , 1, , 1, , 1, , 1, ; (10x)	264-903	5
	2, , 2, , 2, , 2, , 2, ; (10x)	264-904	5
	3, , 3, , 3, , 3, , 3, ; (10x)	264-905	5



Mini-WSB Inline, plain, 1,700 Mini-WSB markers (5 mm wide) per reel		
Color	Item No.	Pack. Unit
white	2009-145	1

## Specific Marking



WSB Quick marking system, white, 10 strips with 10 markers per card, 4 mm wide WSB markers			
Suitable for:	Marking	Item No.	Pack. Unit
Fuse plugs 281-5..	plain	209-701	5

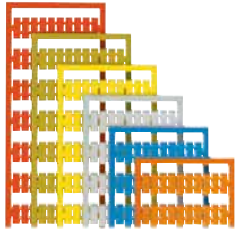

WSB Quick marking system, 10 strips with 10 markers per card, 4 mm wide markers, plain		
Color	Item No.	Pack. Unit
yellow	209-701/000-002	5
red	209-701/000-005	5
blue	209-701/000-006	5
gray	209-701/000-007	5
orange	209-701/000-012	5
light green	209-701/000-017	5
green	209-701/000-023	5
violet	209-701/000-024	5



WSB Quick marking system, for fuse plug (281-5..), white, 10 strips with 10 markers per card, 4 mm wide markers, plain		
Marking	Item No.	Pack. Unit
F1, ..., F10 (10x)	209-787	5
F11, ..., F20 (10x)	209-700/209-124	5
F21, ..., F30 (10x)	209-700/209-125	5
F31, ..., F40 (10x)	209-700/209-126	5
F41, ..., F50 (10x)	209-700/209-127	5



WSB Quick marking system, white, 10 strips with 10 markers per card, 5 mm wide markers			
Suitable for:	Marking	Item No.	Pack. Unit
Matrix patchboards	plain	209-501	5



WSB Quick marking system, 10 strips with 10 markers per card, 5 mm wide markers, plain		
Color	Item No.	Pack. Unit
yellow	209-501/000-002	5
red	209-501/000-005	5
blue	209-501/000-006	5
gray	209-501/000-007	5
orange	209-501/000-012	5
light green	209-501/000-017	5
green	209-501/000-023	5
violet	209-501/000-024	5



WSB Quick marking system, white, 10 strips with 10 markers per card, horizontal marking			
Suitable for:	Marking	Item No.	Pack. Unit
Matrix patchboards	1 ... 10 (10x)	209-502	5



WSB Quick marking system, white, 10 strips with 10 markers per card, horizontal marking			
Suitable for:	Marking	Item No.	Pack. Unit
Matrix patchboards	1 ... 50 (2x)	209-566	5



## Specific Marking



WSB Quick marking system, white, 10 strips with 10 markers per card, horizontal marking			
Suitable for:	Marking	Item No.	Pack. Unit
Matrix patchboards	X (100x)	209-500/209-035	5



WFB continuous marking strip, 1000 mm long			
Suitable for:	Color	Item No.	Pack. Unit
Matrix patchboards Rail-mount terminal blocks, Classic	transparent	210-612	10



Carrier for WFB continuous marking strip, snaps into marker slot			
Suitable for:	Color	Item No.	Pack. Unit
Matrix patchboards Rail-mount terminal blocks, Classic	gray	209-185	200 (25)



Marker carrier, for POWER CAGE CLAMP 35 / 50 / 95 mm <sup>2</sup> Width: 10.4 mm			
Suitable for:	Color	Item No.	Pack. Unit
285-135 285-150 285-195 811 Series	gray	285-442	25



Marking strip, plain, 11 mm wide, 50 m reel			
Suitable for:	Color	Item No.	Pack. Unit
TOPJOB® S terminal blocks 285-135 285-150	white	2009-110	1



Marking strip, plain, 7.5 mm wide, 50 m reel			
Suitable for:	Color	Item No.	Pack. Unit
281-530 and 870, 869, 862, 270 Series	translucent	709-177	1



Marking strip, plain, 7.5 mm wide, 50 m reel			
Suitable for:	Color	Item No.	Pack. Unit
870, 869, 862, 270 Series	white	709-178	1



Marking strip, plain, 7.5 mm wide, 1 m long, for center group marking			
Suitable for:	Color	Item No.	Pack. Unit
870, 869 Series	translucent	709-196	1

## Screwless End Stops for DIN-35 and DIN-15 Rails, Mounting Carriers Installation

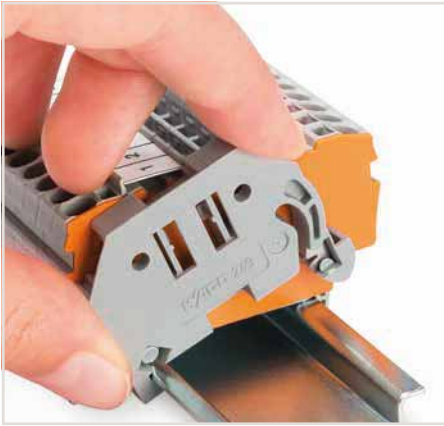

Simply snap on.

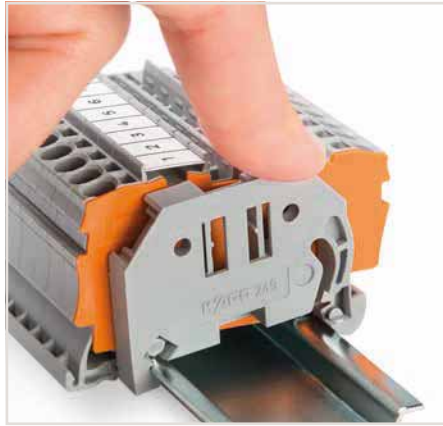

Snap on – that's it! Assembling the new WAGO screwless end stop is as simple and quick as snapping a WAGO rail-mount terminal block onto the rail.

### Without any tools!

This allows rail-mount terminal blocks to be safely secured, at low cost, against any movement on all DIN-35 rails per DIN EN 50022 (35 x 7.5 mm; 35 x 15 mm).

### Entirely without screws!

The "secret" of the excellent tight fit lies in the two small clamping plates that keep the end stop in position, even if the rails are mounted vertically.

### Simply snap on – that's it!

In addition, costs are significantly reduced when using large numbers of end stops.

Additional benefit: Three marker slots for all WAGO rail-mount terminal block markers and one snap-in hole for WAGO adjustable height group marker carriers offer individual marking options.



That's it!

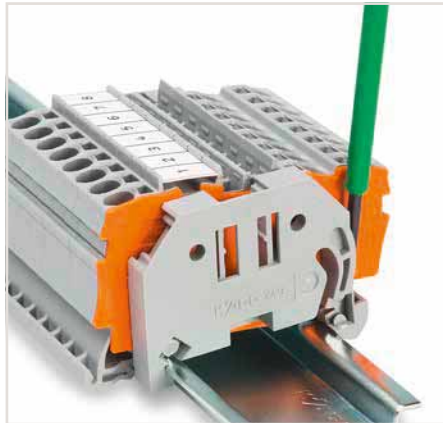

Removing an end stop from the DIN-rail.



**13** Isolated mounting of a carrier rail in a distribution box for protection class II

## Screwless End Stops for DIN-35 Rails, Mounting Carriers

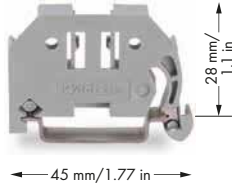

Screwless end stop, for DIN-35 rail, 6 mm wide		
Color	Item No.	Pack. Unit
gray	249-116	100 (25)



Mounting carrier, for isolated mounting on DIN-35 rails		
Color	Item No.	Pack. Unit
gray	209-106	25

Screwless end stop, for DIN-35 rail, 10 mm wide		
Color	Item No.	Pack. Unit
gray	249-117	50 (25)



Screwless end stop, for DIN-35 rail, 14 mm wide		
Color	Item No.	Pack. Unit
gray	249-197	10

## Carrier Rails, Rail End Caps, Angled Support Brackets



Dimensions in mm

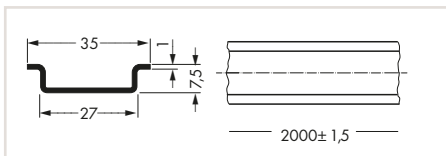

Steel carrier rail, I<sub>N</sub> 76 A (based on 1 m length), 35 x 7.5 mm, 1 mm thick, 2 m long, per EN 60715, unslotted

	Item No.	Pack. Unit
galvanized	210-113	10
continuously galvanized	210-505	1

Dimensions in mm

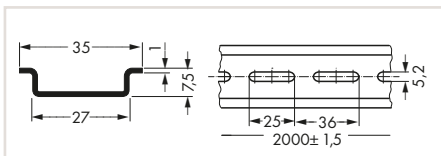

Steel carrier rail, I<sub>N</sub> 76 A (based on 1 m length), 35 x 7.5 mm, 1 mm thick, 2 m long, 25 mm hole width, 36 mm hole spacing, per EN 60715, slotted

	Item No.	Pack. Unit
galvanized	210-112	10 (1)
continuously galvanized	210-504	1

Dimensions in mm

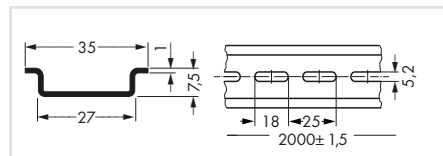

Steel carrier rail, I<sub>N</sub> 76 A (based on 1 m length), 35 x 7.5 mm, 1 mm thick, 2 m long, 18 mm hole width, 25 mm hole spacing, per EN 60715, slotted

	Item No.	Pack. Unit
slotted	210-115	1



Dimensions in mm

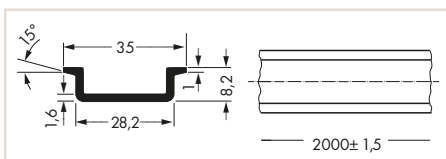

Aluminum carrier rail, I<sub>N</sub> 76 A (based on 1 m length), 35 x 8.2 mm, 1.6 mm thick, 2 m long, similar to EN 60715

	Item No.	Pack. Unit
unslotted	210-196	10

Rail end cap, for DIN-35 rail (7.5 mm high)

Color	Item No.	Pack. Unit
gray	209-109	50 (25)

Dimensions in mm

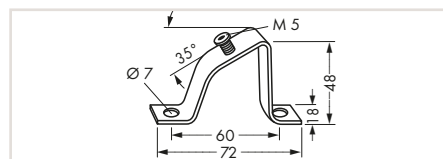

Angled support bracket, without screw

Item No.	Pack. Unit
210-148	10

Screw M5 x 8

Item No.	Pack. Unit
210-149	100 (20)

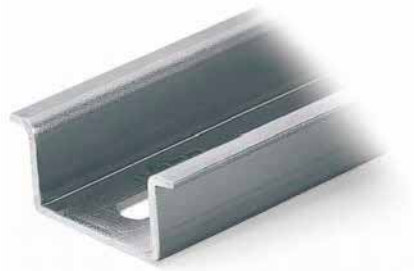

Dimensions in mm

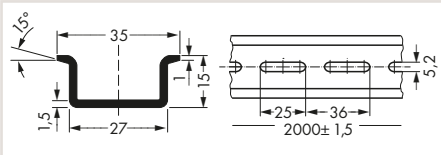

Steel carrier rail, I<sub>N</sub> 125 A (based on 1 m length), 35 x 15 mm, 1.5 mm thick, 2 m long, similar to EN 60715

	Item No.	Pack. Unit
slotted	210-197	10
unslotted	210-114	10

Dimensions in mm

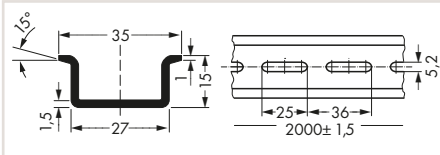

Steel carrier rail, I<sub>N</sub> 125 A (based on 1 m length), 35 x 15 mm, 1.5 mm thick, 2 m long, similar to EN 60715

	Item No.	Pack. Unit
slotted	210-508	1
unslotted	210-506	1

Dimensions in mm

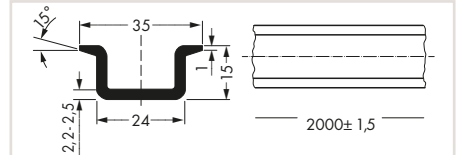

Steel carrier rail, I<sub>N</sub> 125 A (based on 1 m length), 35 x 15 mm, 2.3 mm thick, 2 m long, per EN 60715

	Item No.	Pack. Unit
slotted	210-118	10



Dimensions in mm

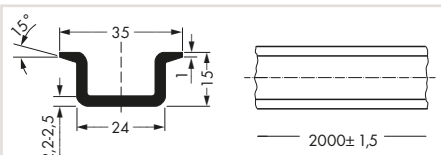

Copper carrier rail, I<sub>N</sub> 309 A (based on 1 m length), 35 x 15 mm, 2.3 mm thick, 2 m long, per EN 60715

	Item No.	Pack. Unit
unslotted	210-198	10

# Transparent Covers for Rail-Mount Terminal Blocks, Usable with Lead Seals, 709 Series

## Description and Installation

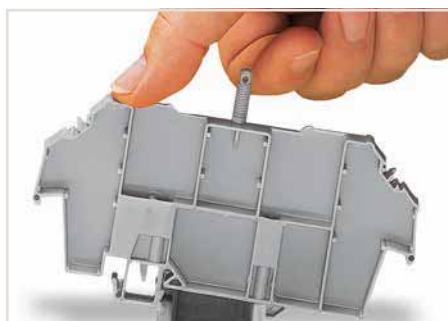

Snapping a cover carrier onto the DIN-rail.

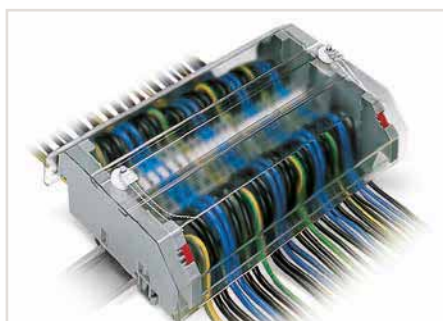

Application example:  
Cover (type 1) without safety warning



Application example:  
Cover (type 1) with safety warning

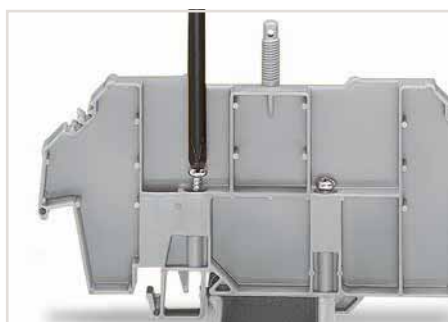

Tightening both securing screw (left) and mounting screw (right).



Application example:  
Cover (type 1) with safety warning

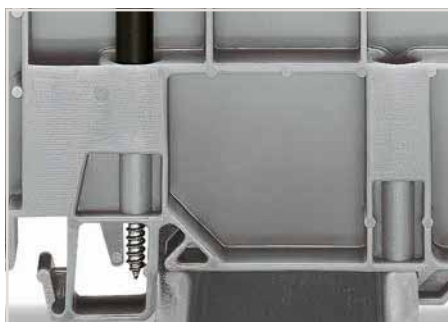

Securing screw – prevents lifting off from the rail.  
Mounting screw – prevents the cover carrier from being moved on the rail.



Removing a cover carrier from the DIN-rail.



Inserting a marking strip into the cover.



Cover with lead seals:  
Using covers without lead seals, the thread dome-head can be broken off.

13



# Transparent Covers for Rail-Mount Terminal Blocks, Usable with Lead Seals 709 Series



Cover, type 1, for cover carrier (type 1), 1 m long		
Color	Item No.	Pack. Unit
transparent	709-153	10



Cover, type 2, for cover carrier (type 2), 1 m long		
Color	Item No.	Pack. Unit
transparent	709-154	10



Spare mounting/securing screw, for cover		
Item No.	Pack. Unit	
209-196	200 (25)	

Spare knurled nut, for cover		
Item No.	Pack. Unit	
210-549	100 (25)	

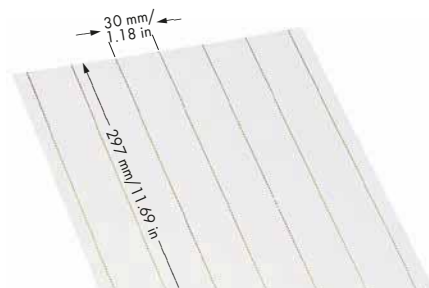

Dimensions in mm

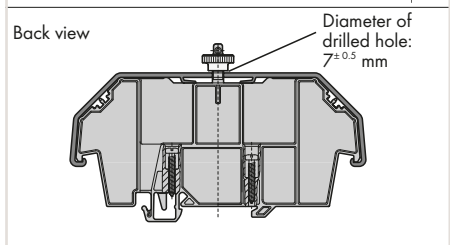
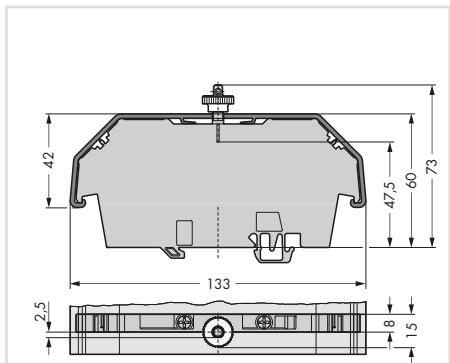

Cover carrier, type 1, for 279 to 282, 880 Series rail-mount terminal blocks, incl. mounting/securing screws and knurled nut, for 264 Series miniature terminal blocks, for 270 Series sensor and actuator blocks

Color	Item No.	Pack. Unit
gray	709-167	10

Dimensions in mm

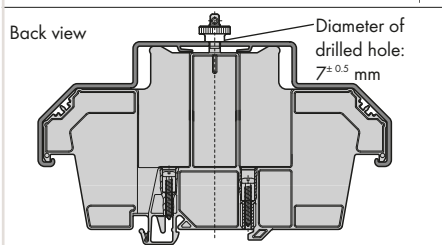
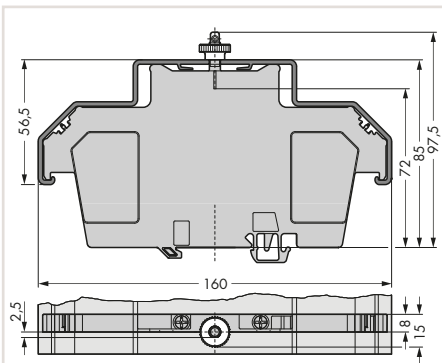

Cover carrier, type 2, for 283 to 285 Series Rail-Mount Terminal Blocks, incl. mounting/securing screws and knurled nut, for 279 to 281 Series Double- and Triple-Deck Terminal Blocks, 780 to 785, 775, 776 and 777 Series TOPJOB® Rail-Mount Terminal Blocks

Color	Item No.	Pack. Unit
gray	709-168	10

Marking card with 6 marking strips, for group marking or safety instructions

Marking	Item No.	Pack. Unit
plain	709-183	1

## Collective Jumper Carriers

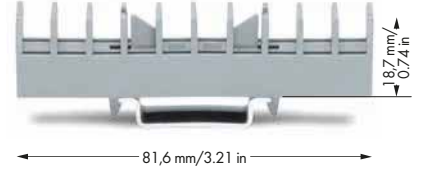
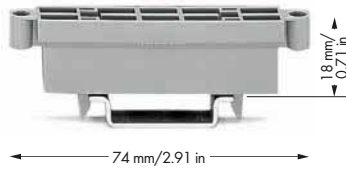

Collective jumper carrier, for DIN-35 rail, for 2000 to 2016 Series jumpers

Collective carrier for adjacent jumpers, for DIN-35 rail, for 279 to 284 Series Adjacent Jumpers and 215 Series Banana Plugs  
The collective carrier can be snapped onto DIN-35 rails.  
It serves as a depository for adjacent jumpers and banana plugs during maintenance work.

Collective jumper carrier, for DIN-35 rail, compatible with jumpers for transverse switching terminal block (282-811) and longitudinal switching disconnect terminal block (282-821)  
The collective carrier can be snapped onto DIN-35 rails.  
It serves as a depository for jumpers during maintenance.

Color	Item No.	Pack. Unit
gray	2009-180	25

Color	Item No.	Pack. Unit
gray	209-100	50 (25)

Color	Item No.	Pack. Unit
gray	282-369	25

## Carrier Rails and Screwless End Stops for DIN-35 Rails



Dimensions in mm

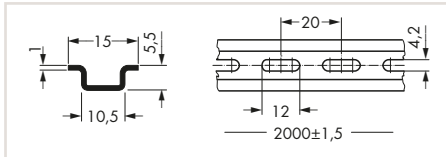

Dimensions in mm

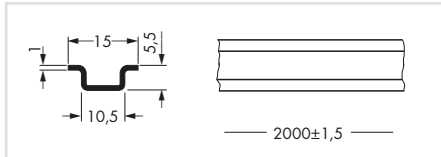

Steel carrier rail, I<sub>N</sub> 57 A (based on 1 m length), 15 x 5.5 mm, 1 mm thick, 2 m long, per EN 60715

	Item No.	Pack. Unit
slotted	210-111	1

Steel carrier rail, I<sub>N</sub> 57 A (based on 1 m length), 15 x 5.5 mm, 1 mm thick, 2 m long, per EN 60715

	Item No.	Pack. Unit
unslotted	210-295	1

Screwless end stop, for DIN-15 rail, 6 mm wide

Color	Item No.	Pack. Unit
gray	249-101	25



Dimensions in mm

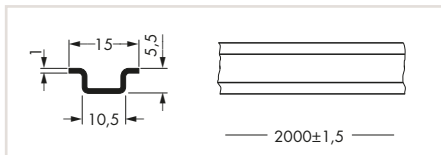

Aluminum carrier rail, I<sub>N</sub> 57 A (based on 1 m length), 15 x 5.5 mm, 1 mm thick, 2 m long, per EN 60715

	Item No.	Pack. Unit
unslotted	210-296	10

## Operating Tools



Operating tool with a partially insulated shaft, type 1, (2.5 x 0.4) mm blade, for 279, 726, 727, 2000, 2001 and 2020 Series

Item No.	Pack. Unit
210-719	1



Set of operating tools with a partially insulated shaft, type 1, (2.5 x 0.4) mm blade, type 2, (3.5 x 0.5) mm blade, type 3, (5.5 x 0.8) mm blade

Item No.	Pack. Unit
210-722	1



Operating tool with a partially insulated shaft, (2.5 x 0.4) mm blade, short, for 279, 726, 727, 2000, 2001 and 2020 Series

Item No.	Pack. Unit
210-647	1

Operating tool with a partially insulated shaft, type 2, (3.5 x 0.5) mm blade, for 260, 261, 262, 264, 270, 280, 281, 290, 775, 776, 777, 769, 780, 781, 869, 870, 880, 2002, 2003, 2004, 2005 and 2022 Series

Item No.	Pack. Unit
210-720	1

Operating tool with a partially insulated shaft, (2.5 x 0.4) mm blade, short, angled, for 279, 2000, 2001 and 2020 Series

Item No.	Pack. Unit
210-648	1

Operating tool with a partially insulated shaft, type 3, (5.5 x 0.8) mm blade, for 282, 283, 284, 285, 782, 783, 784, 785, 2006, 2010 and 2016 Series

Item No.	Pack. Unit
210-721	1

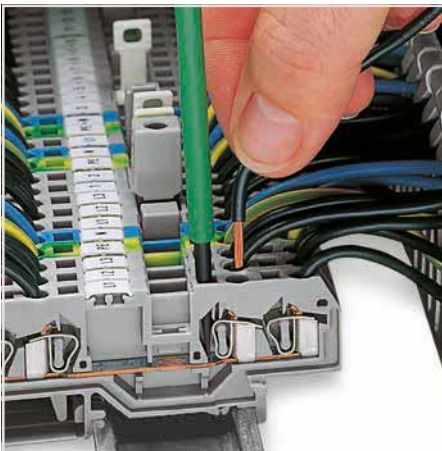

The blade dimensions of the above-listed operating tools with a partially insulated shaft are ideal for easy operation of front-entry terminal blocks.



Set of operating tools in a box

## Operating Tools



Operating tool with a partially insulated shaft, (3.5 x 0.5) mm blade, short, for 260, 261, 262, 264, 270, 280, 281, 869, 870 and 880 Series

Item No.	Pack. Unit
210-657	1



Operating tool, insulated, for 279 Series

	Item No.	Pack. Unit
1-way	209-129	1
2-way	279-432	1
3-way	279-433	1
10-way	279-440	1



Operating pliers, for side-entry rail-mount terminal blocks (281, 282, 283 and 284 Series)

Item No.	Pack. Unit
210-141	1

Operating tool with a partially insulated shaft, (3.5 x 0.5) mm blade, short, angled, ideal for 280 Series Actuator/Sensor Terminal Blocks and for 260, 261, 262, 264, 280, 281, 869, 870, 880, 2002, 2004 Series

Item No.	Pack. Unit
210-658	1

Operating tool, insulated, for 264 Series (1- and 2-way only) and 280, 281 Series (up to 3-way only)

	Item No.	Pack. Unit
1-way	209-130	1
2-way	280-432	1
3-way	280-433	1
4-way	280-434	1
5-way	280-435	1
6-way	280-436	1
7-way	280-437	1
8-way	280-438	1
9-way	280-439	1
10-way	280-440	1

Operating pliers, for side-entry rail-mount terminal blocks (279 and 280 Series)

Item No.	Pack. Unit
210-143	1

Operating tool, insulated, for 281 Series

	Item No.	Pack. Unit
10-way	281-440	1

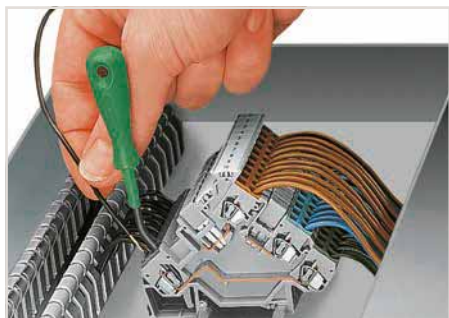

The blade dimensions (DIN 5264) of the above-listed operating tools are ideal for operating 280 Series Front-Entry Sensor/Actuator Terminal Block.



Commoning front-entry disconnect terminal blocks via comb-style jumper bar using a 10-pole operating tool.

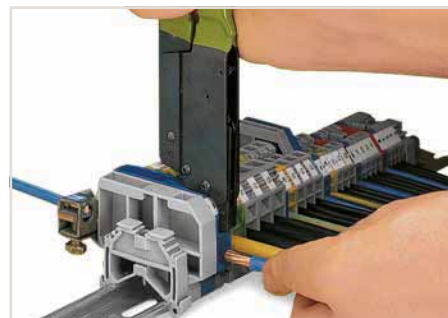

When operating the handles beyond the locked position, the ratchet allows the tool to open and be removed from the terminal block.

## Cable Strippers

### Installation

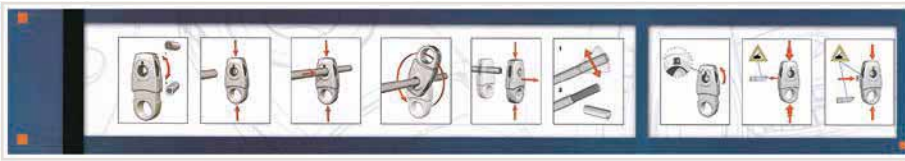

#### Cable Stripper (206-171):

- 10-position adjustment wheel ensures consistent stripping results
- Precision via 10-position blade cutting depth adjustment
- Strips the sheath from multi-core and fiber optic cables up to 11 mm/0.43 inch diameter
- Safe and easy to use through closed stripping cavity

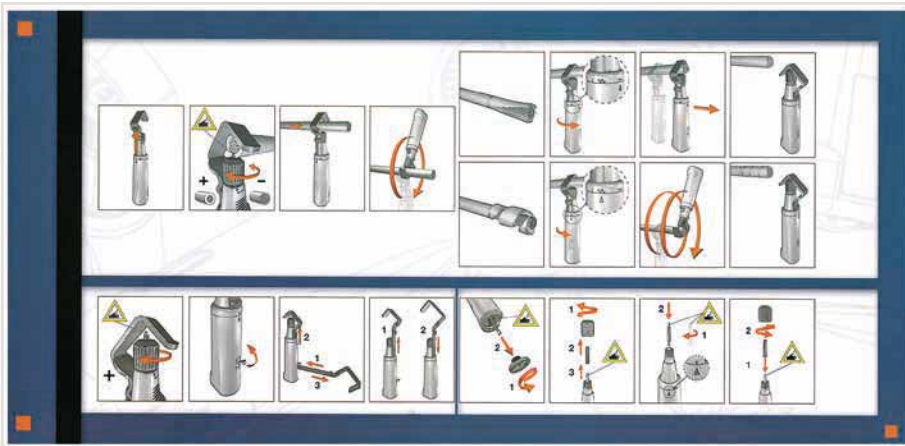

#### Cable Stripper (206-174):

- Safe and easy to use: Three locking positions for circular, longitudinal and spiral cuts
- High cable stripping capacity of up to 40 mm diameter
- Ergonomic design features rests for thumb, index and pinky fingers to ease raising of the cable retention hook
- Replacement blades can be stored within the tool's handle



Set the cable diameter.



Strip the cable.



## Cable Strippers



Cable stripper, for round cables with 2.5 ... 11 mm outer diameter

Item No.	Pack. Unit
206-171	1



Cable stripper, for round cables with 4.5 ... 45 mm outer diameter

Item No.	Pack. Unit
206-174	1



Replacement blade, for 2.5 ... 11 mm Ø, for 206-171 Cable Stripper

Item No.	Pack. Unit
206-170	1

Replacement blade, for 4.5 ... 45 mm Ø, for 206-174 Cable Stripper

Item No.	Pack. Unit
206-173	1



## Stripping Tools



"Quickstrip 10" wire stripper, 0.02 ... 10 mm<sup>2</sup> "f-st" (6 mm<sup>2</sup> "s"), wire cutter up to 10 mm<sup>2</sup> "f-st" (1.5 mm<sup>2</sup> "s")

"Quickstrip 16" wire stripper, 4 ... 16 mm<sup>2</sup>, wire cutter up to 10 mm<sup>2</sup> "f-st" (1.5 mm<sup>2</sup> "s")

"Standard" blade cassette, 0.02 ... 10 mm<sup>2</sup>, for wire stripper (206-124)

Item No.	Pack. Unit
206-124	1

Item No.	Pack. Unit
206-125	1

Item No.	Pack. Unit
206-126	1

V-blade cassette, 0.1 ... 4 mm<sup>2</sup>, for PTFE, for wire stripper (206-124)

Item No.	Pack. Unit
206-127	1

"Standard" blade cassette, 4 ... 16 mm<sup>2</sup>, for wire stripper (206-125)

Item No.	Pack. Unit
206-128	1

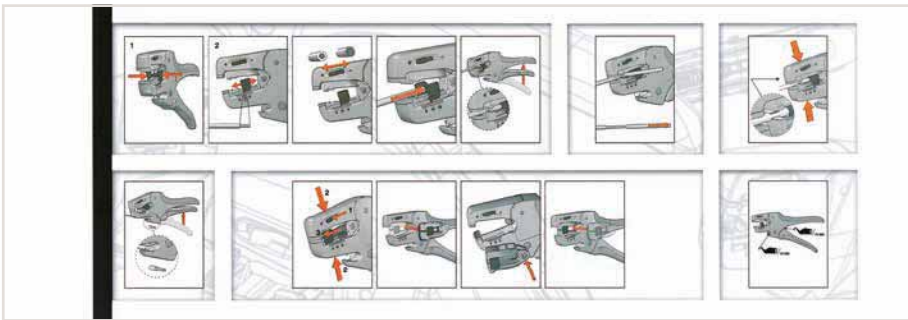

Operating instructions are included.

### Wire Strippers:

- Automatically adjust to conductor size
- Stripping blades cause no damage to conductor strands
- Gripping pressure of jaws adjusts automatically to conductor insulation diameter
- Clamping jaws and stripping blades automatically open once the stripping process is completed – no splaying of the conductor strands
- Exact strip length may be set by sliding black setting stop
- Stripping blades can be replaced
- Self-sharpening, fully protected cutter (replaceable\*)
- Entire body made of glass-fiber-reinforced polyamide

\*applies to Microstrip



Cutting a conductor.



Stripping a conductor.

13

## Crimping Tools



"Variocrimp 4" crimping tool, for insulated and uninsulated ferrules, 0.25 ... 4 mm<sup>2</sup>/24 ... 12 AWG

Item No.	Pack. Unit
206-204	1



"Variocrimp 16" crimping tool, for insulated and uninsulated ferrules, 6 ... 16 mm<sup>2</sup>/10 ... 6 AWG

Item No.	Pack. Unit
206-216	1



Cable cutter, for copper and aluminum cables up to 35 mm<sup>2</sup> (2 AWG)

Item No.	Pack. Unit
206-118	1



Insert the ferruled conductor into the crimping station.



Squeeze handles until ratchet mechanism is released.



Cutting a cable.

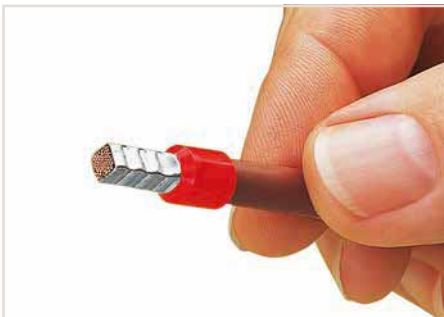

A perfect gas-tight crimp – both electrically and mechanically reliable



Only for "Variocrimp 16":  
Adjust conductor cross-section with crimping tool in open position.

### Application notes:

- The built-in crimping pressure control of "Variocrimp 4" automatically adjusts the crimping force to the conductor cross-section. Select the wire gauge on "Variocrimp 16" before crimping.
- Only one crimping station is needed to handle the specified conductor range.
- Uniform, compact crimping on all four sides for high conductor retention.
- No need to center the conductor into the ferrule.
- Crimping can be performed from either side (for left- or right-handed users).
- Built-in ratchet mechanism ensures gas-tight crimp connection.
- Crimping tools open automatically after crimping operation is complete.
- Ergonomically designed handles.

## Insulated and Uninsulated Ferrules per DIN 46228, Part 4/09.90

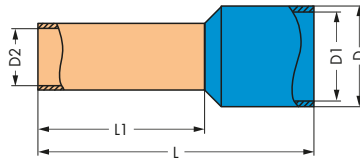

Ferrule, insulated, electro-tin-plated, electrolytic copper, gastight crimped, per DIN 46288, Part 4/09.09

Conductor Size	Color	Strip Length	L	L 1	D	D 1	D 2	Item No.	Pack. Unit
0.25 mm <sup>2</sup> / 24 AWG	yellow	7 mm / 0.28 inch	10,5	6	2,5	2	0,8	216-321	1000
0.25 mm <sup>2</sup> / 24 AWG	yellow	9 mm / 0.35 inch	12,5	8	2,5	2	0,8	216-301	1000
0.34 mm <sup>2</sup> / 24 AWG	green	7 mm / 0.28 inch	10,5	6	2,5	2	0,8	216-322	1000
0.34 mm <sup>2</sup> / 24 AWG	green	9 mm / 0.35 inch	12,5	8	2,5	2	0,8	216-302	1000
0.5 mm <sup>2</sup> / 22 AWG	white	7 mm / 0.28 inch	11,5	6	3	2,5	1,1	216-221	1000
0.5 mm <sup>2</sup> / 22 AWG	white	9 mm / 0.35 inch	13,5	8	3	2,5	1,1	216-201	1000
0.75 mm <sup>2</sup> / 20 AWG	gray	8 mm / 0.31 inch	12	6	3,3	2,8	1,3	216-222	1000
0.75 mm <sup>2</sup> / 20 AWG	gray	10 mm / 0.39 inch	14	8	3,3	2,8	1,3	216-202	1000
1 mm <sup>2</sup> / 18 AWG	red	8 mm / 0.31 inch	12	6	3,6	3	1,5	216-223	1000
1 mm <sup>2</sup> / 18 AWG	red	10 mm / 0.39 inch	14	8	3,6	3	1,5	216-203	1000
1.5 mm <sup>2</sup> / 16 AWG	black	8 mm / 0.31 inch	12	6	4	3,4	1,8	216-224	1000
1.5 mm <sup>2</sup> / 16 AWG	black	10 mm / 0.39 inch	14	8	4	3,4	1,8	216-204	1000
2.08 mm <sup>2</sup> / 14 AWG	yellow	10 mm / 0.39 inch	14,5	8	4,2	3,6	2,05	216-205	1000
2.5 mm <sup>2</sup> / 14 AWG	blue	10 mm / 0.39 inch	15	8	4,8	4,2	2,3	216-206	1000
4 mm <sup>2</sup> / 12 AWG	gray	12 mm / 0.47 inch	16,8	9,5	5,4	4,8	2,9	216-207	1000
6 mm <sup>2</sup> / 10 AWG	yellow	14 mm / 0.55 inch	20	12	6,8	6,3	3,5	216-208	100
10 mm <sup>2</sup> / 8 AWG	red	16 mm / 0.63 inch	21	12	8,1	7,5	4,6	216-209	100
16 mm <sup>2</sup> / 6 AWG	blue	23 mm / 0.91 inch	28	18	9,6	8,8	5,8	216-210	100

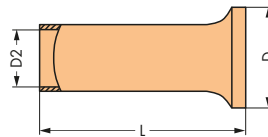

Ferrule, uninsulated, electro-tin-plated, electrolytic copper, gastight crimped, per DIN 46288, Part 4/09.90

Conductor Size	Strip Length	L	D	D 2	Item No.	Pack. Unit
0.25 mm <sup>2</sup> / 24 AWG	5 mm / 0.2 inch	5	1,7	0,75	216-151	1000
0.25 mm <sup>2</sup> / 24 AWG	7 mm / 0.28 inch	7	1,7	0,75	216-131	1000
0.34 mm <sup>2</sup> / 24 AWG	5 mm / 0.2 inch	5	1,7	0,85	216-152	1000
0.34 mm <sup>2</sup> / 24 AWG	7 mm / 0.28 inch	7	1,7	0,85	216-132	1000
0.5 mm <sup>2</sup> / 22 AWG	6 mm / 0.48 inch	6	2,1	1	216-121	1000
0.5 mm <sup>2</sup> / 22 AWG	8 mm / 0.31 inch	8	2,1	1	216-101	1000
0.75 mm <sup>2</sup> / 20 AWG	6 mm / 0.48 inch	6	2,3	1,2	216-122	1000
0.75 mm <sup>2</sup> / 20 AWG	8 mm / 0.31 inch	8	2,3	1,2	216-102	1000
1 mm <sup>2</sup> / 18 AWG	6 mm / 0.48 inch	6	2,5	1,4	216-123	1000
1 mm <sup>2</sup> / 18 AWG	8 mm / 0.31 inch	8	2,5	1,4	216-103	1000
1.5 mm <sup>2</sup> / 16 AWG	6 mm / 0.48 inch	6	2,8	1,7	216-124	1000
1.5 mm <sup>2</sup> / 16 AWG	8 mm / 0.31 inch	8	2,8	1,7	216-104	1000
2.5 mm <sup>2</sup> / 14 AWG	10 mm / 0.39 inch	10	3,4	2,2	216-106	1000
4 mm <sup>2</sup> / 12 AWG	10 mm / 0.39 inch	10	4	2,8	216-107	1000
6 mm <sup>2</sup> / 10 AWG	12 mm / 0.47 inch	12	4,7	3,5	216-108	250
10 mm <sup>2</sup> / 8 AWG	12 mm / 0.47 inch	12	5,8	4,5	216-109	250
16 mm <sup>2</sup> / 6 AWG	12 mm / 0.47 inch	15	7,5	5,8	216-110	250

## Rail-Mount Terminal Blocks, TOPJOB® S

### Insulated and Uninsulated Ferrules per DIN 46228, Part 4/09.90

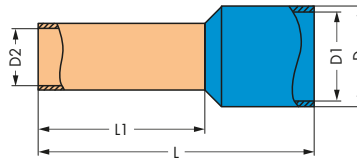

Ferrule, insulated, electro-tin-plated, electrolytic copper, gastight crimped, per DIN 46288, Part 4/09.09

Conductor Size	Color	Strip Length	L	L 1	D	D 1	D 2	Item No.	Pack. Unit
0.5 mm <sup>2</sup> / 22 AWG	○ white	12 mm / 0.47 inch	16	10	3,1	2,6	1	216-241	1000
0.75 mm <sup>2</sup> / 20 AWG	○ gray	12 mm / 0.47 inch	16	10	3,3	2,8	1,2	216-242	1000
0.75 mm <sup>2</sup> / 20 AWG	○ gray	14 mm / 0.55 inch	18	12	3,3	2,8	1,2	216-262	1000
1 mm <sup>2</sup> / 18 AWG	● red	12 mm / 0.47 inch	16	10	3,5	3	1,4	216-243	1000
1 mm <sup>2</sup> / 18 AWG	● red	14 mm / 0.55 inch	18	12	3,5	3	1,4	216-263	1000
1.5 mm <sup>2</sup> / 16 AWG	● black	12 mm / 0.47 inch	16	10	4	3,5	1,7	216-244	1000
1.5 mm <sup>2</sup> / 16 AWG	● black	14 mm / 0.55 inch	18	12	4	3,5	1,7	216-264	1000
1.5 mm <sup>2</sup> / 16 AWG	● black	20 mm / 0.79 inch	24	18	4	3,5	1,7	216-284	1000
2.5 mm <sup>2</sup> / 14 AWG	● blue	12 mm / 0.47 inch	17	10	4,7	4,2	2,2	216-246	1000
2.5 mm <sup>2</sup> / 14 AWG	● blue	14 mm / 0.55 inch	19	12	4,7	4,2	2,2	216-266	1000
2.5 mm <sup>2</sup> / 14 AWG	● blue	20 mm / 0.79 inch	25	18	4,7	4,2	2,2	216-286	1000
4 mm <sup>2</sup> / 12 AWG	○ gray	14 mm / 0.55 inch	20	12	5,4	4,8	2,8	216-267	1000
4 mm <sup>2</sup> / 12 AWG	○ gray	20 mm / 0.79 inch	26	18	5,4	4,8	2,8	216-287	500
6 mm <sup>2</sup> / 10 AWG	● yellow	14 mm / 0.55 inch	20	12	6,8	6,3	3,5	216-208	100
6 mm <sup>2</sup> / 10 AWG	● yellow	20 mm / 0.79 inch	26	18	6,9	6,3	3,5	216-288	500
10 mm <sup>2</sup> / 8 AWG	● blue	20 mm / 0.79 inch	28	18	8,4	7,6	4,5	216-289	500
16 mm <sup>2</sup> / 6 AWG	● blue	23 mm / 0.91 inch	28	18	9,6	8,8	5,8	216-210	100

## Crimping Tools



Crimping tool 25, for insulated and uninsulated ferrules, crimping range: 10 mm<sup>2</sup>, 16 mm<sup>2</sup> and 25 mm<sup>2</sup>

Item No.	Pack. Unit
206-225	1



Crimping tool 25, for insulated and uninsulated ferrules, crimping range: 35 mm<sup>2</sup> and 50 mm<sup>2</sup>

Item No.	Pack. Unit
206-250	1



Insert the ferruled conductor into the crimping station.



Squeeze handles until ratchet mechanism is released.



A perfect gas-tight crimp – both electrically and mechanically reliable

**Application notes:**

- Improved crimping for higher conductor retention
- Crimping can be performed from either side (for left- or right-handed users).
- Built-in ratchet mechanism ensures gas-tight crimp connection.
- Crimping tools open automatically after crimping operation is complete.
- Ergonomically designed handles.

**What is a "gas-tight" connection?**

In a gas-tight connection, the conductor and the ferrule are compressed, eliminating all spaces. Under normal atmospheric conditions, neither a liquid nor gaseous medium can penetrate the crimped connection.

Oxidation between crimped single conductors is prevented, virtually eliminating the possibility of any increase in the crimped connection's resistance. In some exceptional cases, minute, isolated spaces may be present. However, these instances can be considered as closed off due to the twisted conductor.

Inadequate crimping can allow the conductor to be pulled out of the connection. Hollow spaces also remain, permitting oxidation formation and leading to an increase in contact resistance.

Elevated resistance is detrimental for both signal transmission (signal flow is damped) and power transmission, resulting in power loss and contact heating (risk of fire).

Crimping tools with built-in ratchets are recommended, such as the WAGO Variocrimp tools. These tools open automatically after the crimping operation is complete. Space-saving crimping from all four sides is ideal for spring clamp termination.

Ferruled conductor cross-sections specified for WAGO products are based on this crimping method.



## High-Current, Rail-Mount Terminal Blocks Insulated and Uninsulated Ferrules per DIN 46228, Part 4/09.90

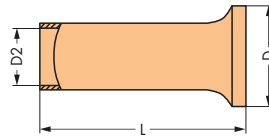

Ferrule, uninsulated, electro-tin-plated, electrolytic copper, gastight crimped, per DIN 46288, Part 4/09.90

Conductor Size	Strip Length	L	D	D 2	Item No.	Pack. Unit
25 mm <sup>2</sup> / 4 AWG	25 mm / 0.98 inch	25	9,5	7,3	216-413	50
35 mm <sup>2</sup> / 2 AWG	25 mm / 0.98 inch	25	11	8,3	216-414	50
35 mm <sup>2</sup> / 2 AWG	30 mm / 1.18 inch	30	11	8,3	216-424	50
50 mm <sup>2</sup> / 1 AWG	30 mm / 1.18 inch	30	13	10,3	216-425	50
50 mm <sup>2</sup> / 1 AWG	35 mm / 1.38 inch	35	13	10,3	216-435	50

## Test and Measurement Devices



Profi LED+, 2-pole voltage tester with LED display, removable 4 mm Ø test probes

Item No.	Pack. Unit
206-707	1



Profi LED+, 2-pole voltage tester with LED display, removable 4 mm Ø test probes

Item No.	Pack. Unit
206-706	1



Spare test probes, 4 mm Ø (2 pieces)

Item No.	Pack. Unit
206-808	25



Additional Profi LED+ features:

- Automatic measurement range selection
- Single-pole phase testing (AC >100 V)
- Two-pole sequence testing (R and L)
- Continuity testing
- FI/RCD testing (30 mA) via buttons
- One-hand operation for SCHUKO and CEE sockets
- LED torch lamp function
- Automatic backlight
- Auto power-off function
- CAT IV 1000 V
- TÜV/GS tested and approved
- IEC/EN 61243-3 (DIN VDE 0682-401)



Additional Profi LED+ features:

- Automatic measurement range selection
- Single-pole phase testing (AC >100 V)
- Two-pole sequence testing (R and L)
- Continuity testing
- FI/RCD testing (30 mA) via buttons
- One-hand operation for SCHUKO and CEE sockets
- LED torch lamp function
- CAT IV 1000 V
- TÜV/GS tested and approved
- IEC/EN 61243-3 (DIN VDE 0682-401)

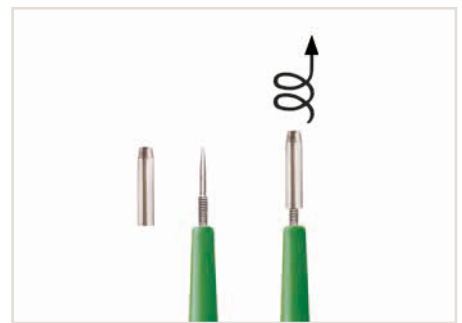

Profi LED+:

- Improved socket contact via 4 mm Ø test probes
- Removable test probes for small test ports (suitable for all WAGO terminal blocks)

# Test and Measurement Devices

## 206 Series



Multi-Tester, digital multimeter with non-contact voltage tester

Item No.	Pack. Unit
206-810	1



Clamp-Multi-Tester

Item No.	Pack. Unit
206-816	1



Testboy, with integrated flashlight, non-contact voltage tester

Item No.	Pack. Unit
206-804	1



Additional Multi-Tester features:

- Contact-less voltage test AC >100 V (optical and acoustical)
- Resistance measurement up to 20 MΩ
- Acoustical continuity test
- Diode test
- Data hold function
- Auto power-off function
- LED torch lamp function
- CAT IV 600 V
- TÜV/GS tested and approved
- IEC/EN 61010-1 (DIN VDE 0411)



Voltage testing in switchgear cabinet

Additional Clamp-Multi-Tester features:

- DC and AC current up to 600 A
- True RMS and min./max. value measurement
- DC and AC voltage up to 600 V
- Manual or automatic measurement range selection
- Resistance up to 60 MΩ
- Capacitance measurement, acoustical continuity test
- Diode test, data hold function
- Large LCD with backlight
- LED measuring point lighting
- CAT III 600 V overvoltage protection
- IEC/EN 61010-1 (DIN VDE 0411)
- Includes batteries, measurement leads and carrying bag



A device that will reliably detect AC voltage in cables, sockets, fuses, switches, outlets and other installations.

Testboy can detect the following:

- Live conductors
- Cable breaks
- Blown fuses (in cartridges or holders)
- Defective switches
- Defective lamps in strings of lights



Current measurement in a switchgear cabinet

## General Test Accessories



Measuring range category	CAT I
Test voltage (AC)	30 V
Test voltage (DC)	60 V
Test current	10 A

Test plug, with 500 mm cable, 2 mm Ø		
Color	Item No.	Pack. Unit
red	210-136	50 (1)



Measuring range category	CAT I
Test voltage (AC)	30 V
Test voltage (DC)	60 V
Test current	10 A

Test plug, with 500 mm cable, 2.3 mm Ø		
Color	Item No.	Pack. Unit
yellow	210-137	50 (1)



Measuring range category	CAT I
Test voltage (AC)	30 V
Test voltage (DC)	60 V
Test current	20 A

Connection Data	
Connection technology	CAGE CLAMP®
Solid conductor	0.08 ... 2.5 mm <sup>2</sup> / 28 ... 14 AWG
Fine-stranded conductor	0.08 ... 2.5 mm <sup>2</sup> / 28 ... 14 AWG
Strip Length	9 ... 11 mm / 0.35 ... 0.43 inch

Banana plug, for 4 mm socket diameter, color mixed, 10 x orange, white, black, blue, yellow		
Item No.	Pack. Unit	
215-111	50	



Measuring range category	CAT I
Test voltage (AC)	30 V
Test voltage (DC)	60 V
Test current	20 A

Connection Data	
Connection technology	CAGE CLAMP®
Solid conductor	0.08 ... 2.5 mm <sup>2</sup> / 28 ... 14 AWG
Fine-stranded conductor	0.08 ... 2.5 mm <sup>2</sup> / 28 ... 14 AWG
Strip Length	9 ... 11 mm / 0.35 ... 0.43 inch

Banana plug, for 4 mm socket diameter		
Color	Item No.	Pack. Unit
orange	215-211	50
red	215-212	50
black	215-311	50
green	215-411	50
yellow	215-511	50
white	215-611	50
Blue	215-711	50
gray	215-811	50
green-yellow	215-911	50









## **Technical Section**

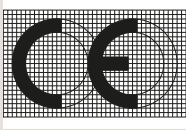

## Technical Section

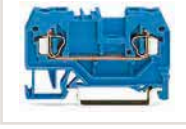
	Page
 <p><b>Technical Information</b> CE Marking and EC Directives</p>	808
<p><b>Tests and Testing Procedures</b> Mechanical, Electrical, Material and Environmental Tests</p>	810
<p><b>UL Specifications – Underwriters Laboratories, USA</b> Tests and Testing Procedures per UL Standards</p>	830
 <p>"Alu-Plus" Contact Paste</p>	835
<p><b>Material Specifications</b> Insulation Materials, Contact Plating, Contact Materials and Clamping Spring Material</p>	836
 <p><b>General Technical Information on Electrical Equipment</b> Used in Hazardous Areas</p>	840
 <p>All terminal blocks used in hazardous areas "Ex e II" have their item numbers marked with the Ex symbol.</p>	
 <p>All terminal blocks used in intrinsically safe current circuits "Ex i" have their item numbers marked with a blue circle.</p>	
<p><b>International Certification Organizations – Overview</b></p>	852
<p><b>Electrical Engineering Laboratory</b> Product Safety for Our Customers</p>	839

## CE Marking and EC Directives

### CE Conformity Marking:

The CE conformity marking consists of the characters "CE" with the following script:

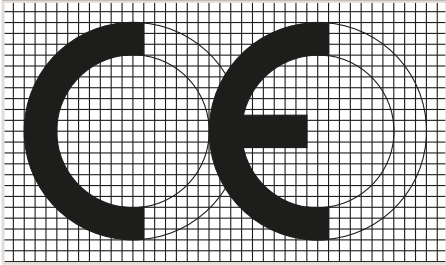

Communauté Européenne  
(European Community)

**EC directives** are legally binding specifications for the European Union. Their goal is aligning legal and administrative specifications in the various EU member countries, in order to prevent trading hindrances arising from different national specifications.

In order to launch a product on the market, it must comply with the relevant directives. Several directives may apply for one single product, for example, EMC and low voltage directives.

For WAGO products the following **EC directives** apply:

#### 2014/35/EU – Low Voltage Directive (LVD)

The LVD covers all electrical equipment operating with a voltage between 50 and 1000 VAC and between 75 and 1500 VDC.

This directive applies to products, such as rail-mount terminal blocks, splicing connectors, modular terminal blocks, terminal strips, etc., which comply with the specifications of the coordinated European standards and their specific parts (e.g., EN 60947 for rail-mount terminal blocks and EN 60998 for splicing connectors).

The CE conformity marking must be applied to all electrical equipment; should on-unit marking not be possible, mark the smallest packing unit. With this marking, manufacturers attest conformity of their products to relevant directives.

In addition to the CE marking, manufacturers provide an EC "Declaration of Conformity" for their products. This declaration of conformity must be retained and submitted to a national surveillance authority upon request.

#### 2014/30/EU – EMC Directive

This directive applies to any devices, equipment and systems containing electric or electronic components. The German Federal Office for Post and Telecommunications (Bundesamt für Post und Telekommunikation, BAPT) is authorized to draw a distinction between elementary and complex components. Elementary components, such as resistors, transformers, ICs, relays, etc., are not provided with marking. For complex components, such as electro-motors, electronic cards, thermostats, etc., the EMC directives apply only if these components are sold directly to the end user.

All products subject to the application range of the EMC directive must display the CE marking on their housing. This marking proves conformity with the corresponding standards.

#### 2006/42/EC – Machinery Directive

This directive applies to complete machines or equipment.

The manufacturers of machines or equipment are, however, obliged to use components which meet the corresponding EC directives (e.g., Low Voltage or EMC Directives). Fulfillment and conformity with these directives is required for the free exchange of goods within Europe.

#### 2014/34/EU – ATEX Directive

General technical information on electrical equipment used in hazardous areas

## IEC/EN Specifications

The following standards apply to the design and application of the terminal blocks and connectors contained in this catalog:

IEC 60364-1 HD 60364-1 VDE 0100-100 / Erection of power installations with nominal voltages up to 1000 V - Part 1: Fundamental principles, assessment of general characteristics, definitions	VDE 0118-1 / Installation of electrical equipment in mines - General rules	IEC 60999-2 EN 60999-2 VDE 0609-101 /- Part 2: General requirements and particular requirements for clamping units for conductors from 35 mm <sup>2</sup> up to 300 mm <sup>2</sup> (included)
IEC 60364-7-710 HD 60364-7-710 VDE 0100-710 /- Part 7-710: Requirements for special installations or locations - Medically used areas	IEC 60038 EN 60038 VDE 0175-1 / IEC CENELEC standard voltages	IEC 60998-1 EN 60998-1 VDE 0613-1 / Connecting devices for low-voltage circuits for household and similar purposes - Part 1: General requirements
IEC 60364-7-718 HC 60364-7-718 VDE 0100-718 /- Part 7-718: Requirements for special installations or locations - Communal facilities and workplaces	VDE 0298-4 / Use of cables and insulated conductors in power installations - Part 4: Recommended values for current carrying capacities of cables for fixed installation and for flexible cables	IEC 60998-2-1 EN 60998-2-1 VDE 0613-2-1 /- Part 2-1: Particular requirements for connecting devices as separate entities with screw-type clamping units
EN 50110-1 VDE 0105-1 / Operation of electrical installations - Part 1: General requirements	IEC 60112 EN 60112 VDE 0303-11 / Method for determining the comparative and the proof tracking indices of solid insulation materials	IEC 60998-2-2 EN 60998-2-2 VDE 0613-2-2 /- Part 2-2: Particular requirements for connecting devices as separate entities with screwless-type clamping units
IEC 60664-1 EN 60664-1 VDE 0110-1 / Insulation coordination for equipment within low-voltage systems - Part 1: Principles, requirements and tests	IEC 60529 EN 60529 VDE 0470-1 / Degrees of protection provided by enclosures (IP Code) - Testing equipment and testing method	IEC 60998-2-3 EN 60998-2-3 VDE 0613-2-3 /- Part 2-3: Particular requirements for connecting devices as separate entities with insulation-piercing clamping units
IEC 60204-1 EN 60204-1 VDE 0113-1 / Safety of machinery – Electrical equipment of machines - Part 1: General requirements	IEC 61439-1 EN 61439-1 VDE 0660-600-1 / Low-voltage switchgear and control-gear assemblies - Part 1: General rules	IEC 60947-1 EN 60947-1 VDE 0660-100 / Low-voltage switchgear and controlgear - Part 1: General rules
IEC 61140 EN 61140 VDE 0140-1 / Protection against electric shock - Common aspects for installation and equipment	IEC 61439-3 EN 61439-3 VDE 0660-600-3 /- Low-voltage switchgear and control-gear assemblies - Part 3: Distribution boards intended to be operated by ordinary persons (DBO)	IEC 60947-7-1 EN 60947-7-1 VDE 0611-1 - Part 7-1: Ancillary equipment - Terminal blocks for copper conductors
IEC 60079-0 EN 60079-0 VDE 0170-1 / Hazardous areas - Part 0: Equipment - General requirements	IEC 61643-11 EN 61643-11 VDE 0675-6-11 / Low-voltage surge protective devices - Part 11: Surge protective devices connected to low-voltage power systems - Requirements and test methods	IEC 60947-7-2 EN 60947-7-2 VDE 0611-3 /- Part 7-2: Ancillary equipment - Ground conductor terminal blocks for copper conductors
IEC 60079-7 EN 60079-7 VDE 0170-6 / Explosive atmospheres - Part 7: Equipment protection by increased safety "e"	IEC 60335-1 EN 60335-1 VDE 0700-1 / Safety of household and similar electrical appliances - Part 1: General requirements	IEC 60947-7-3 EN 60947-7-3 VDE 0611-6 - Part 7-3: Ancillary equipment - Safety requirements for fuse terminal blocks
IEC 60079-11 EN 60079-11 VDE 0170-7 / Hazardous areas - Part 11: Equipment protection by intrinsic safety "i"	IEC 60598-1 EN 60598-1 VDE 0711-1 / Lighting fixtures - Part 1: General requirements and tests	VDE 0611-4 / Rail-mount terminal blocks for connection of copper conductors; - Multi-level distribution rail-mount terminal blocks up to 6 mm <sup>2</sup>
IEC 60079-14 EN 60079-14 VDE 0165-1 / Hazardous areas - Part 14: Electrical installations design, selection and erection	IEC 60715 EN 60715 / Standardized mounting on rails for mechanical support of electrical devices in switchgear and control-gear installations	IEC 61984 EN 61984 VDE 0627 / Connectors – Safety requirements and tests
IEC 60079-15 EN 60079-15 VDE 0170-16 / Explosive atmospheres - Part 15: Equipment protection by type of protection "n"	IEC 60999-1 EN 60999-1 VDE 0609-1 / Connecting devices – Electrical copper conductors - Safety requirements for screw-type and screwless-type clamping units - Part 1: General requirements and particular requirements for clamping units for conductors from 0.2 mm <sup>2</sup> up to 35 mm <sup>2</sup>	

## Tests and Testing Procedures per IEC/EN Standards

Products such as connecting devices, rail-mount terminal blocks and connectors, etc., have their own product-specific test specifications. The following sections describe the most important tests and are limited to a description of the test procedures and an explanation of the test purpose. The data shown (e.g., voltages, temperatures, forces) only serve as illustration and may differ depending on the test.

### Mechanical Tests

All WAGO products meet requirements for the following mechanical tests:

#### • Termination Requirements

##### Conductor Termination

Two WAGO connection systems are proven in the field of Spring Pressure Connection Technology:

The **PUSH WIRE® connection** for applications requiring solid conductors (e.g., for lighting and building wiring, telecommunications, house communication or alarm systems).

Conductor range:

0.2 ... 4 mm<sup>2</sup> (24 ... 12 AWG)

The **universal CAGE CLAMP® spring pressure connection system** for solid, stranded and fine-stranded conductors, designed for a variety of industrial, electrical and electronic applications (e.g., fine-stranded conductors in the elevator industry, in power stations, in the chemical and automotive industry, and aboard ships).

Conductor range:

0.08 ... 35 mm<sup>2</sup> (28 ... 2 AWG)

The **Push-in CAGE CLAMP® connection** takes universal CAGE CLAMP® connections further by allowing the termination of 0.2 ... 16 mm<sup>2</sup> (24 ... 6 AWG) solid, stranded and fine-stranded conductors (25 mm<sup>2</sup>/4 AWG only "f-st") and offering all the benefits and safety of the original CAGE CLAMP®. Furthermore, the Push-in CAGE CLAMP® connection technology allows solid, stranded and fine-stranded conductors with ferrules from 0.5 ... 16 mm<sup>2</sup> (20 ... 6 AWG) to be terminated by simply pushing them in.

The conductor entry hole is perfectly suited for the insulation diameter of the rated conductor cross-section, thus providing good conductor guidance.

This is particularly important for vibration-prone applications.

Fine-stranded conductors of small or very small size are highly flexible, and deform when pushed against the conductor stop in terminal blocks. As a result, the conductor insulation – not the copper conductor – may be clamped, causing intermittent contact or no contact at all.

In order to prevent conductor insulation from being inserted into the clamp, insulation stops are available for WAGO rail-mount terminal blocks up to 4 mm<sup>2</sup> (12 AWG), even providing protection for 0.08 mm<sup>2</sup> (28 AWG) conductors (see Section 5).

### Rated Cross-Sections and Connectable Conductors

I. Per IEC 60999-1 / EN 60999-1 / VDE 0609-1, Table 1:

Rated Cross-Section	Theoretical Largest Conductor Diameter							Connectable Conductor	
	Metric			AWG				Rigid	Flexible
	Rigid		Flexible	Rigid		Flexible			
	Solid	Stranded		Cond. Cross-Section	b) Solid	b) Class B Stranded	c) Class I, K, M Stranded		
mm <sup>2</sup>	mm	mm	mm		mm	mm	mm		
0.2	0.51	0.53	0.61	24	0.54	0.61	0.64	To be defined in the corresponding product standard	
0.34	0.63	0.66	0.8	22	0.68	0.71	0.8		
0.5	0.9	1.1	1.1	20	0.85	0.97	1.02		
0.75	1	1.2	1.3	18	1.07	1.23	1.28		
1	1.2	1.4	1.5	–	–	–	–		
1.5	1.5	1.7	1.8	16	1.35	1.55	1.6		
2.5	1.9	2.2	2.3 <sup>a)</sup>	14	1.71	1.95	2.08		
4	2.4	2.7	2.9 <sup>a)</sup>	12	2.15	2.45	2.7		
6	2.9	3.3	3.9 <sup>a)</sup>	10	2.72	3.09	3.36		
10	3.7	4.2	5.1	8	3.34	3.89	4.32		
16	4.6	5.3	6.3	6	4.32	4.91	5.73		
25	–	6.6	7.8	4	5.45	6.18	7.26		
35	–	7.9	9.2	2	6.87	7.78	9.02		

NOTE: The diameters of the largest rigid and flexible conductors are based on Table 1 of IEC 60228 A/IEC 60344 and on ASTM B172-71 [4], IECA Publication S-19-81 [5], IECA Publication S-66-524 [6], as well as IECA Publication S-66-516 [7] for AWG conductors.

a) Dimensions for Class 5 flexible conductors only (IEC 60228 A)

b) Nominal diameter + 5 %

c) Largest diameter for conductors of classes I, K, M + 5 %

In practical use, the conductor cross-sections are approximately 5 % below the values stated in the table!

The IEC 60999-1/EN 60999-1/ VDE 0609-1 Specification (Section 7.1) requires that:

**Clamping units must be able to connect unprepared conductors.**

Under normal operating conditions, direct clamping (i.e., directly connecting a conductor to the terminal block's current bar) provides optimal contact quality, because all risk factors arising from anti-splaying methods are prevented.

Occasionally, conductor anti-splaying protection may be required, including various methods (see illustrations below).

Special requirements apply only in special application areas exposed to extremely corrosive atmospheres.

In this case, we recommend using either solid copper conductors or fine-stranded copper conductors with properly crimped, tin-coated copper ferrules or copper pin terminals.

As with solid copper conductors, the fine strands are crimped to a dense inner core. This prevents ingress of aggressive atmospheres (depending on the ppm concentration), which can diffuse into the conductor bundle along the individual strands and cause corrosion deposits between individual strands and the clamping point.

**One Conductor per Clamping Unit**

A number of VDE specifications specify that **only one conductor must be connected per clamping unit** (e.g., DIN VDE 0611-4, 02.91, Section 3.1.9). The same applies to the recommendations of the German Automotive Industry Association (VDA) "Supply specification for the electrical equipment of machines, mechanical installations and buildings in the automotive industry" according to Section 15.1.1.3; Draft 8.93.

Other VDE and EN specifications also recommend the connection of **only one conductor per clamping unit**, unless the clamping unit is specifically tested and approved for the connection of several conductors, for example:

- VDE 0609-1, 12.00/
- EN 60999-1:2000, Section 7.1
- VDE 0660-600, 06.12/
- EN 61439-1:2011
- Section 8.6.3
- VDE 0113-1, 06.07/
- EN 60204-1:2006, Section 13.1.1

One conductor per clamping unit is therefore recommended to meet the safety requirements of these relevant specifications. This WAGO principle is the basis for a number of other technical and economic advantages:

- Each conductor may be terminated or removed without affecting previously connected conductors.
- Where re-wiring is required, only the conductor to be changed is removed from the clamping point, all other conductors remain safely clamped.
- Each conductor is clamped independently.
- Any conductor size combination can be connected.

II. Per IEC 60999-2, Table 1:

Rated Cross-Section	Theoretical Largest Conductor Diameter					Connectable Conductor	
	Metric		AWG/kcmil				
	Rigid Stranded	Fine-Stranded <sup>a)</sup>	Gauge	Rigid Stranded	Fine-Stranded	Rigid	Flexible
mm <sup>2</sup>	mm	mm		mm	mm		
50	9.1	11	1/0	9.64	12.08	To be defined in the corresponding product standard	
70	11	13.1	2/0	11.17	13.54		
95	12.9	15.1	3/0	12.54	15.33		
–	–	–	4/0	14.08	17.22		
120	14.5	17	250	15.34	19.01		
150	16.2	19	300	16.8	20.48		
185	18	21	350	18.16	22.05		
–	–	–	400	19.42	24.05		
240	20.6	24	500	21.68	26.57		
300	23.1	27	600	23.82	30.03		

a) Dimensions for Class 5 flexible conductors only (IEC 60228 A)

NOTE: The diameters of the largest rigid and flexible conductors are based on Table 1 and Table 3 of IEC 3 A/IEC 60228 and on ASTM B172-71 [1], IECA Publication S-19-81 [2], IECA Publication S-66-524 [3], as well as IECA Publication S-66-516 [7] for AWG conductors.



Tip-bonded conductor



Tin-plated copper ferrule (gas-tight crimped)



Ultrasonically bonded conductor

Anti-splaying methods require a terminal block one size larger than the nominal cross-section of the conductor to be terminated. Ferruled conductor cross-sections specified for individual products are based on WAGO's Variocrimp square crimping technology. Gas-tight, crimped twin ferrules may be used, provided the ferrule is inserted all the way into the clamping unit and that there is a sufficient clearance and creepage distance between adjacent potentials.



Crimped pin terminal (gas-tight), preferably made of copper with a tin-plated surface

WAGO rail-mount terminal blocks offer different solutions to increase the number of clamping points.

The most common way is by branching one conductor into two or three conductors.

WAGO offers 3- and 4-conductor terminal blocks, making additional jumpers unnecessary.

## Tests and Testing Procedures per IEC/EN Standards (continued)

### Mechanical Tests (continued)

#### • Pull-Out Test per IEC/EN 60947-7-1, IEC/EN 60998-2-2, IEC/EN 60999-1

The pull-out test simulates the mechanical stress on the clamping unit when, for example, the installer pushes the conductor aside to better access/operate the adjacent clamping unit, or verifies if the conductor is connected properly by briefly pulling on it.

During the test, a pulling force is applied without jerking, for one minute, to the connected conductor. The pulling force is selected according to the cross-sectional area. The larger the cross-section of the conductor, the higher the pull-out force that is selected. For example, the pulling force is 40 N for a conductor having a cross-section of 1.5 mm<sup>2</sup> (16 AWG) and 100 N for a conductor with a cross-section of 16 mm<sup>2</sup> (6 AWG). The values specified by these standards are the same for both screw clamp and spring clamp terminal blocks. During the test, the conductor must neither slip out of the clamping unit, nor break near the clamping unit.

#### Conductor Pull-Out Forces

The clamping units of screwless terminal blocks must withstand the pull-out forces as follows:

IEC 60947-1/EN 60947-1/VDE 0660-100, Table 5:

Low-voltage switchgear and control-gear, general rules

IEC 60947-7-1/EN 60947-7-1/

VDE 0611-1, rail-mount terminal blocks for copper conductors

IEC 60998-2-1/EN 60998-2-1/

VDE 0613-2-1, Table 104:

IEC 60998-2-2/EN 60998-2-2

VDE 0613-2-2, Table 103:

Connecting devices for low-voltage circuits for household and similar purposes

Particular requirements for connecting devices as separate entities with screw-clamp or screwless terminal blocks.

IEC 60999-1/EN 60999-1/VDE 0609-1, Table 3:

IEC 60999-2/EN 60999-2/VDE 0609-101, Table 2:

Safety requirements for screw-clamp and screwless clamping units for electrical copper conductors

Rated Cross-Section		Pull-Out Forces per IEC/EN		
mm <sup>2</sup>	AWG/kcmil	60947-7-1	60998-2-2	60999-1/-2
		N	N	N
0.2	24	10	10	10
0.34	22	15	15	15
0.5	20	20	20	20
0.75	18	30	30	30
1	–	35	35	35
1.5	16	40	40	40
2.5	14	50	50	50
4	12	60	60	60
6	10	80	80	80
10	8	90	90	90
16	6	100	100	100
25	4	135	135	135
–	3	156		
35	2	190	190	190
–	1	236		
50	1/0	236		236
70	2/0	285		285
95	3/0	351		351
–	4/0	427		427
120	250	427		427
150	300	427		427
185	350	503		503
–	400	503		503
240	500	578		578
300	600	578		578



• Shock Test per IEC/EN 60068-2-27; IEC/EN 61373 (Railway Applications)

The shock test is similar to the vibration test except that, instead of continuous vibrations, single shocks are applied to the specimen. Shock tests are usually performed with an acceleration of 20g, for example, over a period of 11 ms. Tests for special requirements often call for much higher values.

Like the vibration tests, shock tests are primarily used to test the voltage drop variation or contact breaks, etc.

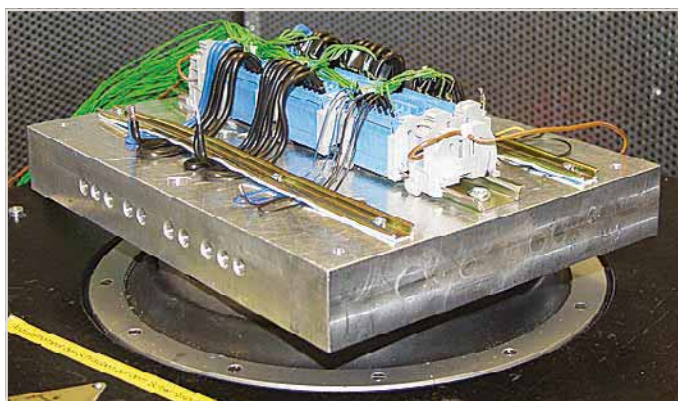
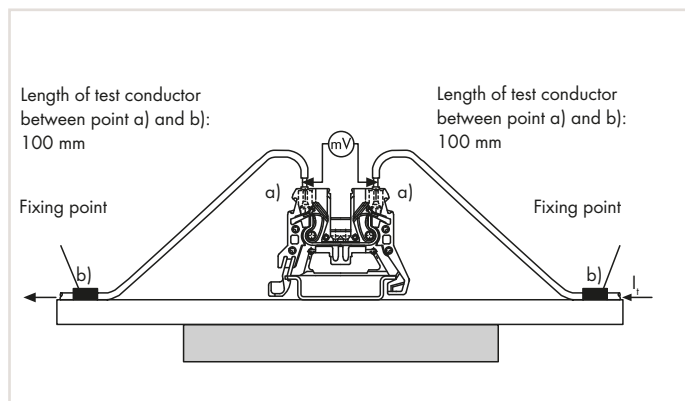

Example:

Per IEC/EN 60068-2-27  
 (half-sine shock)  
 Acceleration: 100g      Duration: 6 ms      Shock direction: Three axes  
 (three shocks each in positive and negative direction)

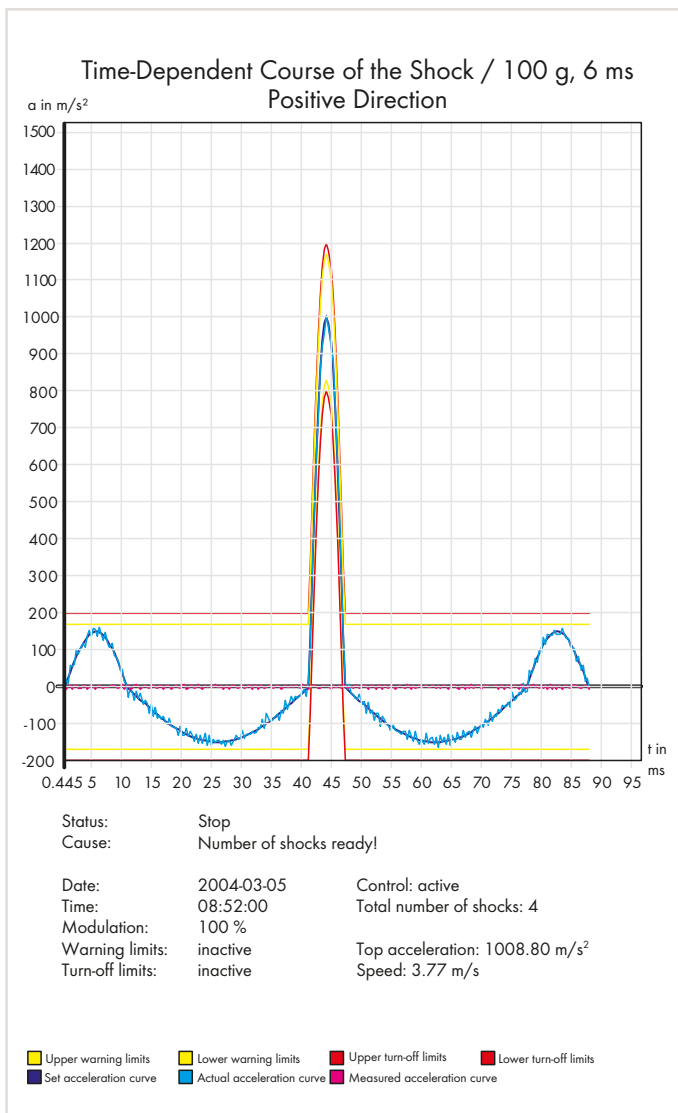
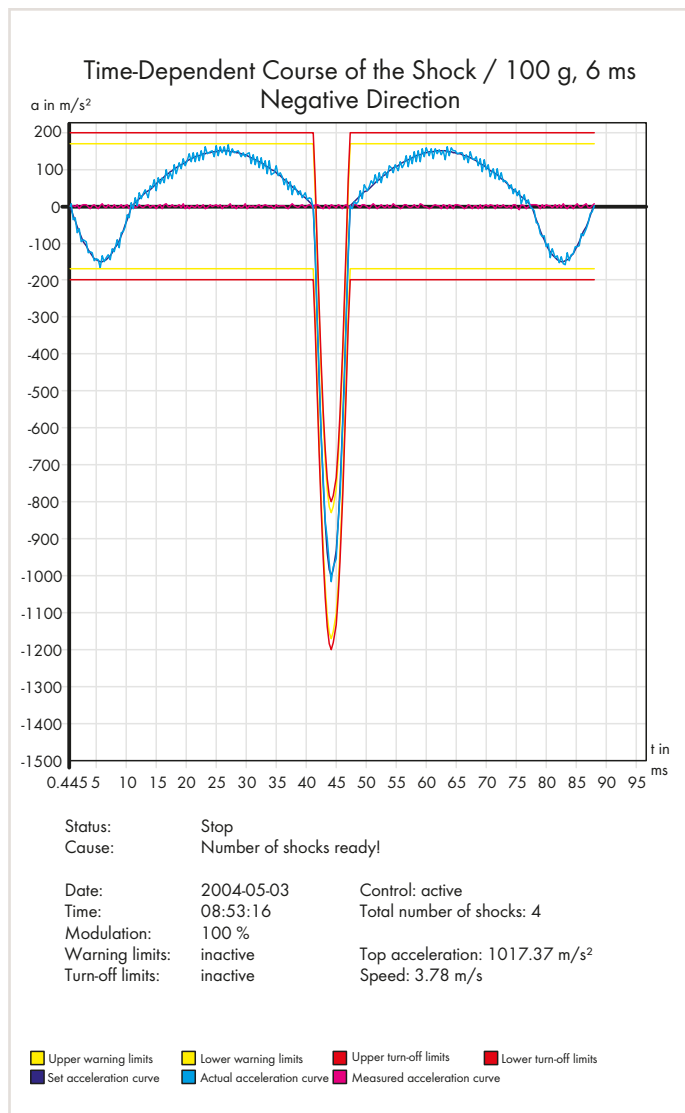

## Tests and Testing Procedures per IEC/EN Standards (continued)

### Mechanical Tests (continued)

- Vibration Test per IEC/EN 60068-2-6; DNV GL, LR (Marine Applications); EN 61373 (Railway Applications)

The vibration test determines whether vibrations, such as those produced in the vicinity of machines or in vehicles, will permanently affect the electrical connection, or if contact breaks will occur during vibrations. Using a vibration table, the test specimen is subjected to vibration in each of the X, Y and Z axes (see pictures).

The amplitude, acceleration and in particular the frequency of the vibration must vary during the test.

In a common test procedure, for example, a wide frequency band is continuously run up to 2000 Hz, at different accelerations up to 20g and different amplitudes up to 20 mm. Test duration is 90 minutes per axis.



Other test types are performed using a single fixed frequency. The exact test procedure may vary considerably, depending on how the product will be used. Some test specifications require the determination of possible resonant frequencies, i.e., determining if resonance occurs within the frequency spectrum to be passed through. Analyzing the specimen behavior under the influence of resonant frequencies is performed using a special testing procedure.

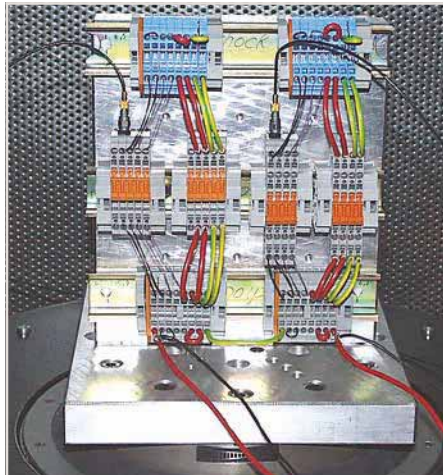

Beyond these standard procedures, each market segment performs additional testing. Examples include railway authorities testing rolling electrical equipment, or the testing performed multiple marine agencies (e.g., DNV GL Group, Lloyd's Register of Shipping). Though the requirements of such testing procedures are particularly demanding, test arrangements are identical for all of them. During vibrations, possible contact breaks are monitored on an oscilloscope. Voltage drop is measured before and after the test to detect permanent failures, i.e., checking if electrical resistance at the clamping unit has not increased beyond the permissible limit. The smaller this value is, the smaller the contact resistance of the clamping unit.

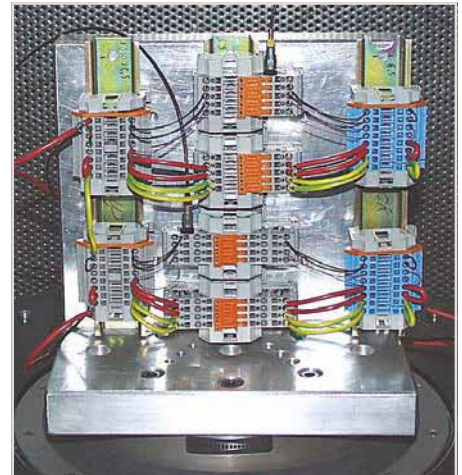

The test is passed if:

- the conductor has neither slipped out of the terminal block nor been damaged,
- the maximum permissible voltage drop has not been exceeded
- and neither contact breaks have occurred nor a defined break time has been exceeded.

The test specimen must not be damaged in any way that might affect future use.

Since their inception, both CAGE CLAMP® and Push-in CAGE CLAMP® connections have been routinely tested for their resistance to vibration in connection with approval tests.

Additionally, WAGO conducts special self-resonance behavior tests on clamping systems, using different terminal block and conductor arrangements. In these tests, a wide frequency band is continuously run up to 2,000 Hz, at different accelerations up to 20g and different amplitudes up to 20 mm. The figure provides an example of a self-resonance vibration test configuration.

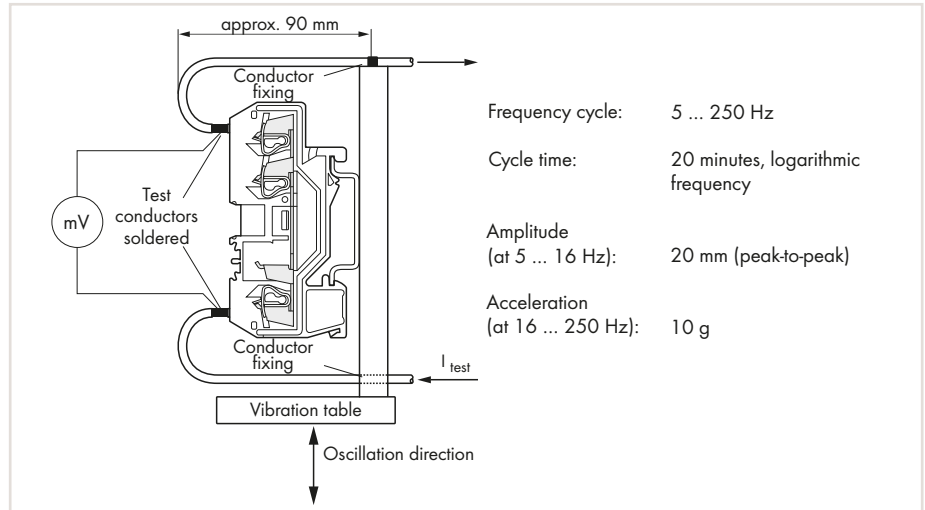

Self-resonance vibration test set-up

All WAGO spring clamp connections meet these test requirements.

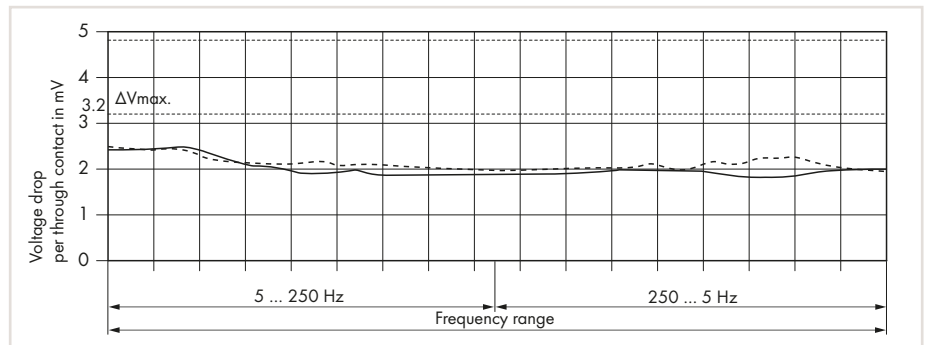

Frequency cycle      Rail-mount terminal block: Item no. 280-681      ----- Test specimen no. 1  
 Test current: 1/10 I<sub>N</sub> = 2.4 A      - - - - - Test specimen no. 2

## Tests and Testing Procedures per IEC/EN Standards (continued)

### Electrical Tests

All WAGO products meet requirements for the following electrical tests:

- Temperature-Rise Test per IEC/EN 60947-7-1

The temperature-rise test examines the clamping unit – including the surrounding insulation – at rated current, over-current and short-circuit current levels.

Unless otherwise specified in the related equipment specification, e.g., by specifying the nominal currents of the equipment, terminal blocks and connectors are tested with current loads as specified in the respective construction specification.

For rail-mount terminal blocks complying with IEC 60947-7-1/EN 60947-7-1/VDE 0611-1, or terminal blocks complying with IEC 60998-1/EN 60998-1/ VDE 0613-1, the temperature rise must not exceed 45 Kelvin.

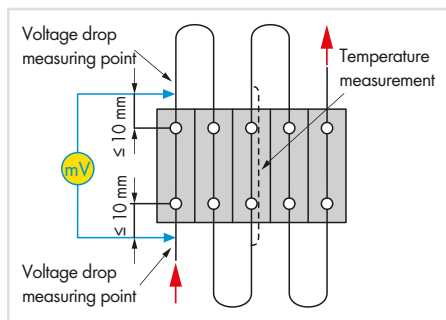

Test arrangement: "Temperature-Rise Test"

Rated Cross-Section	Test Current per IEC/EN		Conductor Size	Test Current per IEC/EN
	60947-7-1 Table 4	60998-1 Table 2		
mm <sup>2</sup>	A	A	AWG/kcmil	A
0.2	4	4	24	4
0.34	5	5	22	6
0.5	6	6	20	8
0.75	9	9	18	10
1	13.5	13.5	-	-
1.5	17.5	17.5	16	16
2.5	24	24	14	22
4	32	32	12	29
6	41	41	10	38
10	57	57	8	50
16	76	76	6	67
25	101	101	4	90
35	125	125	2	121
-	-	-	1	139
50	150	-	1/0	162
70	192	-	2/0	185
95	232	-	3/0	217
-	-	-	4/0	242
120	269	-	250 kcmil	271
150	309	-	300 kcmil	309
185	353	-	350 kcmil	353
240	415	-	500 kcmil	415
300	520	-	600 kcmil	520

#### • Current-Carrying Capacity Curve per IEC/EN 60512-5-2

Both the design requirements (e.g., dimensions) and the current-carrying capacity of a connector must be checked by the user when selecting connectors.

This data depends on the following factors: connected conductor cross-section, ambient temperature, number of simultaneously loaded poles, connector's internal resistance, as well as PCB layout and connector materials if required. In accordance with IEC/EN 60512-5-2, the relationship between current, ambient temperature and temperature rise up to the connector's upper temperature limit is illustrated via current-carrying capacity curve. The connector must only be operated up to this temperature limit (sum of the self-generated heat and the ambient temperature) without being damaged or destroyed during operation.

Functioning of a current-carrying capacity curve per EN 60512-5-2 is shown by an application using a current-carrying capacity curve for the X-COM®-SYSTEM:

This application requires each pole of a 4-pole connector be subjected to a load of 32 A. Based on the basic curve determined for this pole number with a conductor cross-section of 4 mm<sup>2</sup>, it has been determined the maximum ambient temperature is 42 °C (107.6 °F). The current must be reduced at higher ambient temperatures, e.g., to 19 A at an ambient temperature of 70 °C (158 °F).

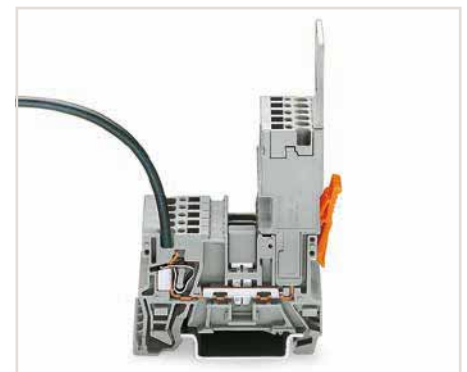
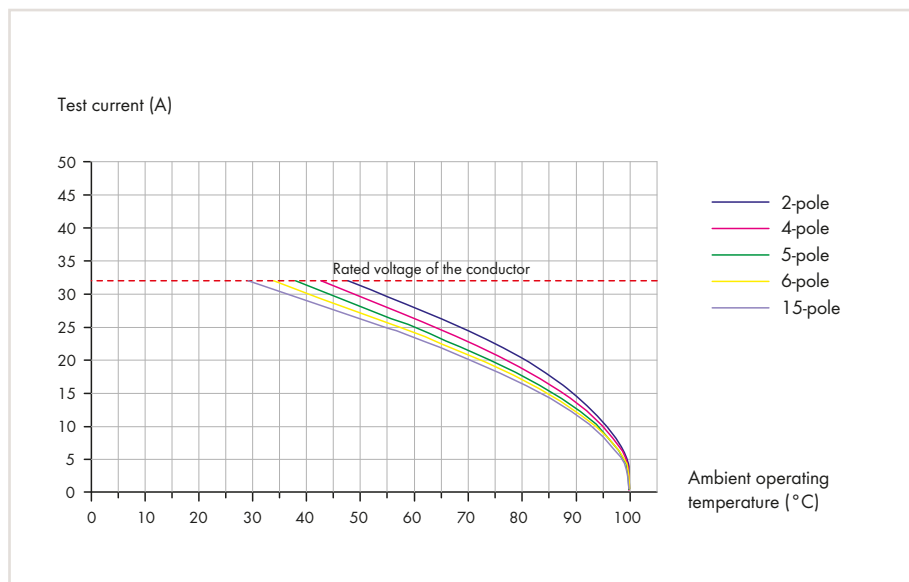

1-conductor/1-pin carrier terminal block (769-176)  
Conductor cross-section: 4 mm<sup>2</sup> (12 AWG)

1-conductor female plugs (769-102 to 769-115)  
Conductor cross-section: 4 mm<sup>2</sup> (12 AWG)  
Conductor loop length: 1 m

## Tests and Testing Procedures per IEC/EN Standards (continued)

### Electrical Tests (continued)

- Voltage Drop Test per IEC/EN 60947-7-1

The voltage drop test evaluates clamping point quality under stress such as vibration, temperature change, industrial climate and salt spray, in order to verify that the contact point is gas-tight.

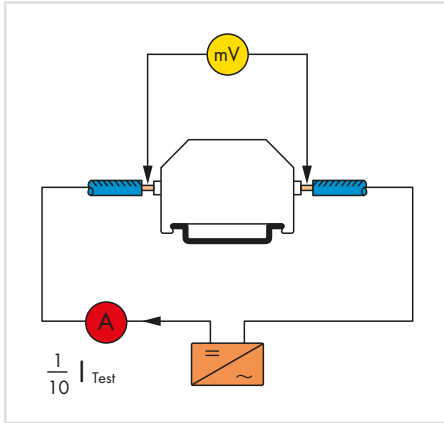

The CAGE CLAMP® and Push-in CAGE CLAMP® connections enclose and contain fine-stranded conductors. Therefore, a variation of the voltage drop with solid and fine-stranded conductors is so small that its influence may be negligible for the practical application of the terminal blocks.

Test arrangement: "Voltage Drop Test"

Typical voltage drop variations for solid and fine-stranded conductors of 280 to 285 Series CAGE CLAMP® Rail-Mount terminal Blocks:

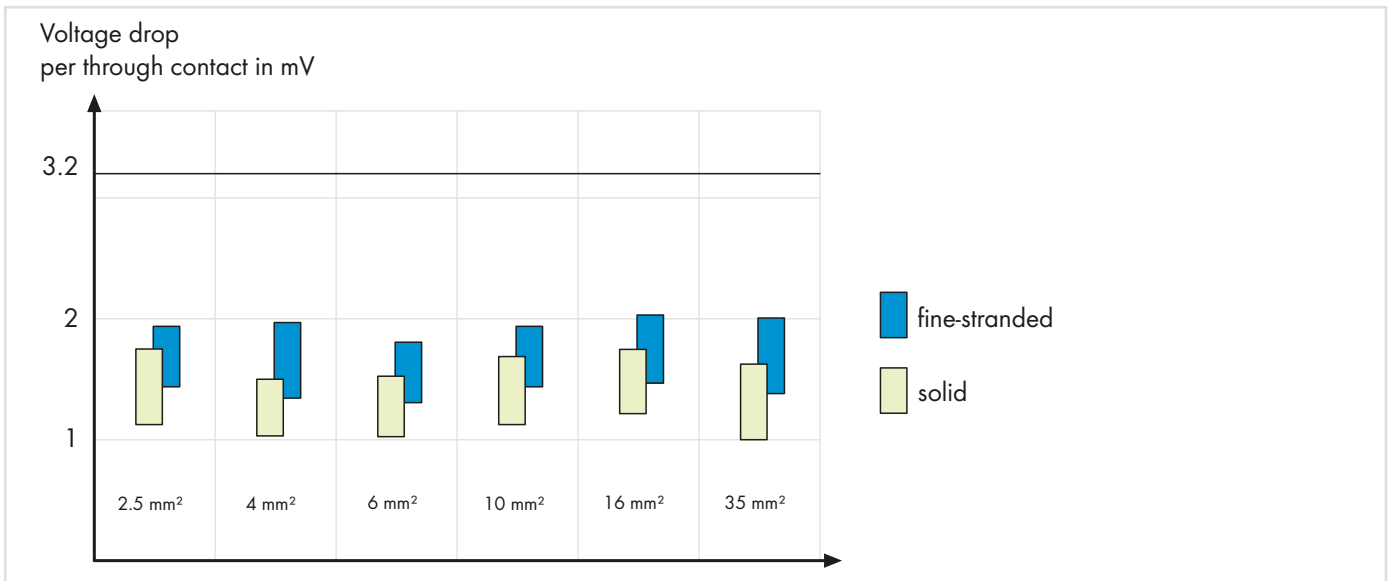

Example: Current load cycling test result for rail-mount terminal blocks (item no. 285-195) using 95 mm² (4/0 AWG) fine-stranded copper conductors:

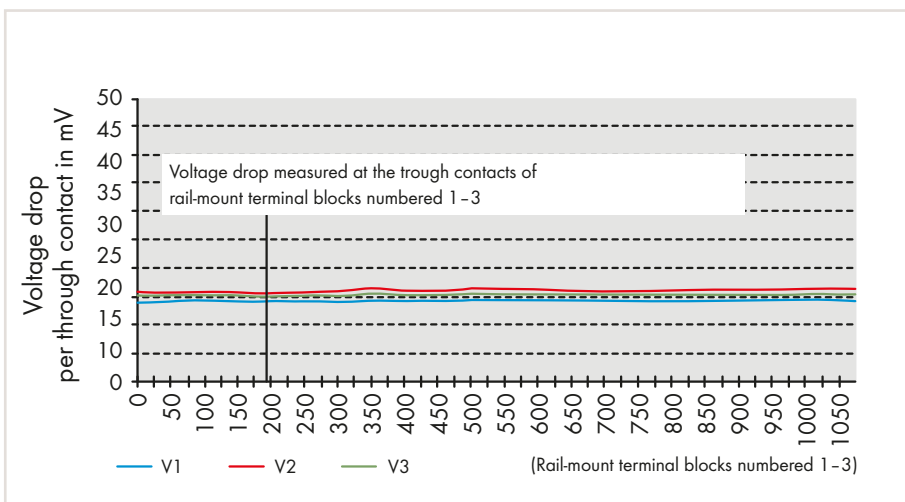

Voltage drop variation over longer periods under current load cycling conditions is shown for WAGO 285-195 (95 mm²/4/0 AWG) Rail-Mount Terminal Blocks

using solid copper conductors. The diagram shows that the voltage drop is constant, far beyond the 192 cycles required in IEC 60947-7-1.

(The voltage drop was determined at rated current.)



• Short-Time Withstand Current Test (Short-Circuit Withstand Capacity) per IEC/EN 60947-7-1

Apart from the rated current that can be constantly applied to an electrical device, operation-related short peak currents consistently occur in electrical installations; e.g., when motors are started. Also, in the event of a short circuit, a high current can flow for a short time until the fuse element melts. Terminal blocks and connecting devices must be able to withstand such conditions. For example, in the short-time withstand current test per IEC/EN 60947-7-1, a through rail-mount terminal blocks must be capable of withstanding for one second the rated short-time withstand current which corresponds to 120 A/mm<sup>2</sup> of its nominal cross-section.

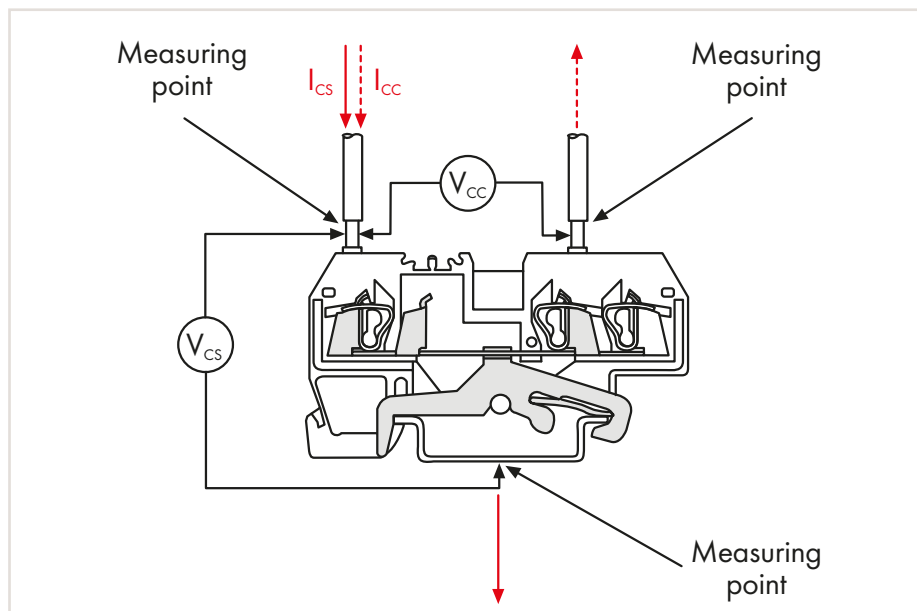
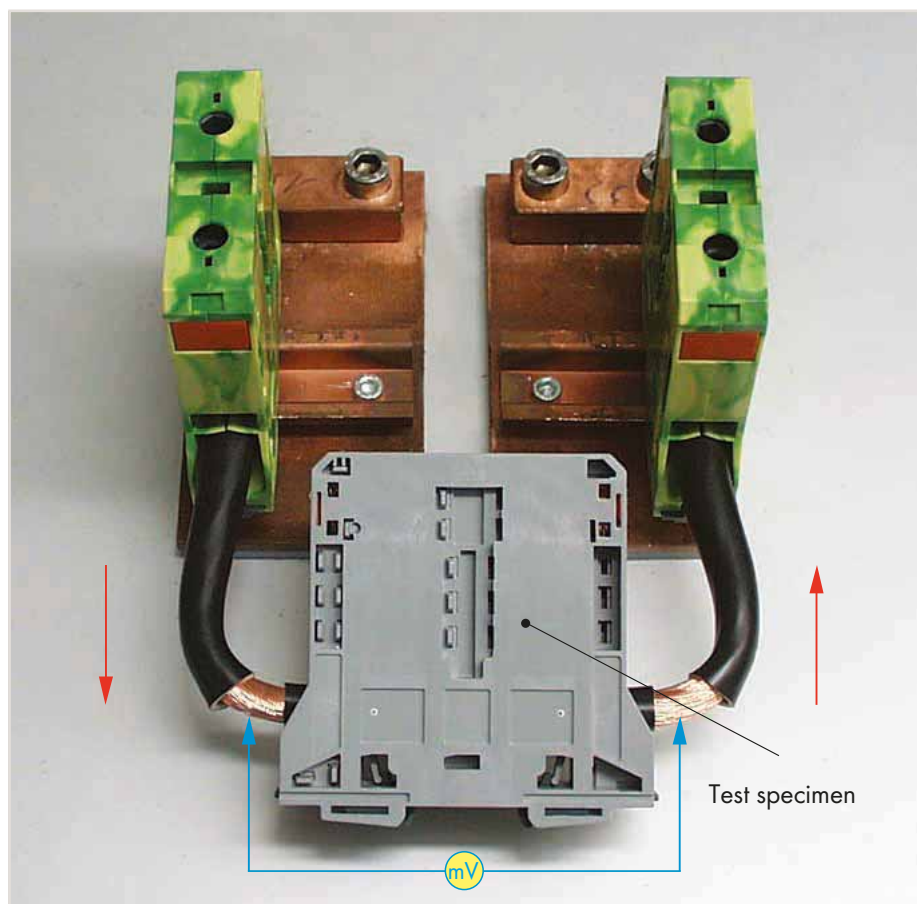

During the short-time withstand current test, the ground conductor rail-mount terminal blocks are subjected three times for one second each to a current load of 120 A/mm<sup>2</sup>. The pass criterion for the test is the voltage drop (limiting value and constant measured values).

## Tests and Testing Procedures per IEC/EN Standards (continued)

### Electrical Tests (continued)

#### • Insulation Parameters per IEC/EN 60664-1

##### Clearances and Creepage Distances

The following generally applies:  
The equipment specification contains data for the measurement of clearances and creepage distances, or refers to the data contained in the basic DIN EN 60664-1/VDE 0110-1 standard. This standard contains new clearances and creepage distances in compliance with insulation coordination requirements. That is, the insulation parameters of equipment are assigned to:

- the anticipated surge voltages,
- the parameters of the protection device against impulse voltage and
- the anticipated environmental conditions and the protection measures against pollution.

This standard is based on IEC 60604-1.

##### Clearances, Rated Surge Voltages, Overvoltage Categories, Pollution Degrees

Surge voltages (Table 1) are a decisive factor in determining clearances.

The basis forms the **overvoltage category**, i.e., the allocation of the equipment to the expected overvoltage, and the **conductor-ground voltage** derived from the nominal mains voltage in installations with a grounded Y (star) point.

In ungrounded installations, or installations where the conductor is not grounded, the voltage between conductors is applicable in the same way as conductor voltage to ground.

- ① Voltage pulse: 1.2/50  $\mu$ s

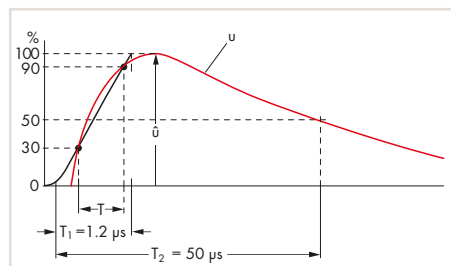

per EN 60060-1/VDE 0432-1

##### Overvoltage Categories for Electrical Equipment

A specific overvoltage category must be defined on the basis of the following, general description:

- Equipment in **overvoltage category I** is intended to be connected to the fixed electrical installations of buildings. Protective means are taken outside the equipment – either in the fixed installation or between the fixed installation and the equipment – to limit transient overvoltages to the specific level.
- Equipment in **overvoltage category II** is to be connected to the fixed electrical installations of buildings.  
**Note:** Examples of such equipment are household appliances, portable tools and similar loads.
- Equipment in **overvoltage category III** is part of the fixed electrical installations and other equipment where a higher degree of availability is expected.  
**Note:** Examples of such equipment are distribution boards, circuit breakers, wiring systems (IEV 826-16-08, including cables, bus bars, junction boxes, switches, socket outlets) in the fixed installation and equipment for industrial use and other equipment, e.g., stationary motors with permanent connection to the fixed installation.
- Equipment in **overvoltage category IV** is for use in or near the feed-in in electrical building installations upstream of the main distribution board in the direction of the network.  
**Note:** Examples include electricity meters, primary overcurrent protection devices and ripple control units.

The rated surge voltage must be selected from Table F.1 corresponding to the overvoltage category specified and to the rated voltage of the equipment.

Table F.1: Rated surge voltage for equipment energized directly from the low-voltage mains (DIN EN 60664-1/VDE 0110-1)

- ① Voltage curve: 1.2/50  $\mu$ s per IEC 60060-1/VDE 0432-1

Nominal voltage of the power supply system <sup>1)</sup> (mains) per IEC 60038 <sup>3)</sup>		Conductor-to-neutral voltage, derived from the nominal AC or DC voltage up to and including: V	Rated surge voltage <sup>2)</sup> Overvoltage category <sup>4)</sup>			
Three-phase V	Single-phase V		I V	II V	III V	IV V
		50	330	500	800	1500
		100	500	800	1500	2500
	120-240	150 <sup>5)</sup>	800	1500	2500	4000
230 / 400 277 / 480		300	1500	2500	4000	6000
400 690		600	2500	4000	6000	8000
1000		1000	4000	6000	8000	12000

<sup>1)</sup> See Annex B for application to existing different low-voltage mains and their nominal voltages.

<sup>2)</sup> Equipment with these rated impulse voltage levels can be used in installations complying with IEC 60364-4-443.

<sup>3)</sup> The / mark indicates a three-phase, 4-conductor system. The lower value is the conductor-to-neutral voltage, while the higher value is the conductor-to-conductor voltage. Where only one value is indicated, it refers to three-phase, 3-conductor systems and specifies the conductor-to-conductor voltage.

<sup>4)</sup> See 4.3.3.2.2 for an explanation of the overvoltage categories.

<sup>5)</sup> The nominal voltages for single-phase systems in Japan are 100 V or 100 ... 200 V. The value for the rated impulse voltage is, however, derived from the voltage gaps conductor-to-neutral for a voltage level of 150 V (see Annex B).

The nominal supply voltage and the corresponding rated impulse voltage values apply for grounded and ungrounded circuits.

## Pollution Degrees

Pollution factors are all solid, liquid or gaseous foreign matter which may reduce the dielectric strength or the specific surface resistance. Factors are divided into four classes based on expected environmental conditions:

		Examples of pollution degrees for assigned areas:
Pollution degree 1:	No pollution, or only dry, non-conductive pollution occurs. Pollution has no influence.	Open, unprotected insulated equipment in air-conditioned or clean, dry rooms
Pollution degree 2:	Only non-conductive pollution occurs. Occasional, temporary conductivity caused by condensation can also be expected.	Open, unprotected insulated equipment in occupied areas, shops, laboratories, mechanical workshops and medical rooms.
Pollution degree 3:	Conductive pollution occurs, or dry, non-conductive pollution occurs which will become conductive due to condensation.	Open, unprotected insulated equipment in industrial, business and farming areas (e.g., unheated rooms, workshops and boiler rooms)
Pollution degree 4:	The pollution generates persistent conductivity caused by conductive dust, rain or wet conditions.	Open, unprotected insulated equipment for outdoor use

## Dimensioning Clearances

(DIN EN 60664-1/VDE 0110-1, Table F.2) Select the minimum clearances in accordance with the rated surge voltages and pollution degrees. To maximize the operating life of the equipment, do not go below these minimum clearances.

Table F.2 contains a list of information for Case A, the inhomogeneous field and for Case B, the homogeneous field.

This involves an electric field with essentially constant (Case B) or non-constant (Case A) voltage gradients between the electrodes.

**Equipment with a clearance that is dimensioned per Case A, in other words rated for the most unfavorable case, requires no verification by the impulse voltage test.**

Equipment with a clearance that is dimensioned per Case B, or between A and B, requires verification by the impulse voltage test.

The clearances shown in Table F.2 are applicable for an installation height of up to 2000 m above sea level.

Values for clearances above 2000 m must be multiplied by a high correction factor in accordance with Table A.2.

**Table F.2: Clearances to Withstand Transient Overvoltages**  
DIN EN 60664-1/VDE 0110-1

Required impulse withstand voltage <sup>1)5)</sup>	Minimum clearances in air up to 2000 m above sea level					
	Case A (inhomogeneous field, see 3.15)			Case B (homogeneous field, see 3.14)		
	Pollution degree <sup>6)</sup>			Pollution degree <sup>6)</sup>		
	1	2	3	1	2	3
kV	mm	mm	mm	mm	mm	mm
0.33 <sup>2)</sup>	0.01	0.2 <sup>3)4)</sup>	0.8 <sup>4)</sup>	0.01	0.2 <sup>3)4)</sup>	0.8 <sup>4)</sup>
0.4	0.02			0.02		
0.5 <sup>2)</sup>	0.04			0.04		
0.6	0.06			0.06		
0.8 <sup>2)</sup>	0.10			0.10		
1	0.15			0.15		
1.2	0.25	0.25	0.2	0.3	0.3	
1.5 <sup>2)</sup>	0.5	0.5	0.3			
2	1	1	1	0.45	0.45	
2.5 <sup>2)</sup>	1.5	1.5	1.5	0.6	0.6	
3	2	2	2	0.8	0.8	
4 <sup>2)</sup>	3	3	3	1.2	1.2	1.2
5	4	4	4	1.5	1.5	1.5
6 <sup>2)</sup>	5.5	5.5	5.5	2	2	2
8 <sup>2)</sup>	8	8	8	3	3	3
10	11	11	11	3.5	3.5	3.5
12 <sup>2)</sup>	14	14	14	4.5	4.5	4.5
15	18	18	18	5.5	5.5	5.5
20	25	25	25	8	8	8
25	33	33	33	10	10	10
30	40	40	40	12.5	12.5	12.5
40	60	60	60	17	17	17
50	75	75	75	22	22	22
60	90	90	90	27	27	27
80	130	130	130	35	35	35
100	170	170	170	45	45	45

<sup>1)</sup> This voltage is for:

- Functional insulation: the maximum impulse voltage expected to occur across the clearance (see 5.1.5)
- Basic insulation directly exposed to or significantly influenced by transient overvoltages from the low-voltage mains (see 4.3.3.3, 4.3.3.4.1 and 5.1.6): the rated impulse voltage for the equipment
- Other basic insulation (see 4.3.3.4.2): the highest impulse voltage that can occur in the circuit  
For reinforced insulation, see 5.1.6.

<sup>2)</sup> Preferred values specified in 4.2.3

<sup>3)</sup> For printed wiring material, the values for pollution degree 1 apply, except that the value must not be less than 0.04 mm, as specified in Table F.4.

<sup>4)</sup> The minimum clearances given for pollution degree 2 and 3 are based on the reduced withstand characteristics of the associated creepage distance under humidity conditions (see IEC 60664-5).

<sup>5)</sup> For parts or circuit within equipment subject to surge voltages based on 4.3.3.4.2, interpolation of values is allowed. However, standardization is achieved by using the preferred series of impulse voltage values based on 4.2.3.

<sup>6)</sup> The dimensions for pollution degree 4 are as specified for pollution degree 3, except that the minimum clearance is 1.6 mm.

## Tests and Testing Procedures per IEC/EN Standards (continued)

### Electrical Tests (continued)

#### • Insulation Parameters per IEC/EN 60664-1 (continued)



#### Creepage Distances, Rated Voltages, Material Groups

Criteria for dimensioning creepage distances are the rated voltages, pollution degrees and material groups.

The pollution degrees specified for the clearances, and its quoted allocation to locations, is also applicable for creepage distances.

Tables F.3 a and F.3 b of DIN EN 60664-1/VDE 0110-1 contain the rated voltages that have to be considered for dimensioning the minimum creepage distances.

Table F.3a: Single-Phase, 3- or 2-Conductor, AC or DC Systems

Nominal voltage of the power supply system (mains)*	Voltages for Table F.4	
	For insulation conductor-to-conductor <sup>1)</sup>	For insulation conductor-to-ground <sup>1)</sup>
	All systems 	Three-conductor systems, center-point grounded 
V	V	V
12.5	12.5	
24 25	25	
30	32	
42 48 50**	50	
60	63	
30 to 60	63	32
100**	100	
110 120	125	
150**	160	
200	200	
110 to 200	200	100
220	250	
110 to 220 120 to 240	250	
300**	320	
220 to 440	500	250
600**	630	
480 to 960	1000	500
1000**	1000	

<sup>1)</sup> Conductor-to-ground insulation level for non-grounded or impedance-grounded systems equals that for conductor-to-conductor, as the operating voltage to ground of any conductor can, in practice, approach full conductor-to-conductor voltage. This is because the actual voltage to ground is determined by the insulation resistance and capacitive reactance of each conductor to ground; thus, low (but acceptable) insulation resistance of one conductor can in effect ground it and raise the other two to full conductor-to-conductor voltage to ground.

\*For the relationship to rated voltage, see 4.3.2.

\*\*These values correspond to the values given in Table F.1.

Altitude (in m)	Standard Air Pressure (in kPa)	Multiplier for Clearances
2000	80	1
3000	70	1.14
4000	62	1.29
5000	54	1.48
6000	47	1.7
7000	41	1.95
8000	35.5	2.25
9000	30.5	2.62
10000	26.5	3.02
15000	12	6.67
20000	5.5	14.5

Table F.3b: Single-Phase, 4- or 3-Conductor AC Systems

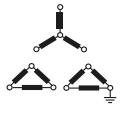
Nominal voltage of the power supply system (mains)*	Voltages for Table F.4		
	For insulation conductor-to-conductor <sup>1)</sup>	For insulation conductor-to-ground <sup>1)</sup>	
	All systems	Three-phase, 4-conduct. systems with grounded neutral conductor <sup>2)</sup>	Three-phase, 3-conduct. systems, non-grounded <sup>1)</sup> or grounded conductor
V	V		
V	V	V	V
60	63	32	63
110 120 127	125	80	125
150**	160		160
200	200		200
208	200	125	200
220 230 240	250	160	250
300**	320		320
380 400 415	400	250	400
440	500	250	500
480 500	500	320	500
575	630	400	630
600**	630		630
660 690	630	400	630
720 830	800	500	800
960	1000	630	1000
1000**	1000		1000

<sup>1)</sup> Conductor-to-ground insulation level for non-grounded or impedance-grounded systems equals that for conductor-to-conductor, as the operating voltage to ground of any conductor can, in practice, approach full conductor-to-conductor voltage. This is because the actual voltage to ground is determined by the insulation resistance and capacitive reactance of each conductor to ground; thus, low (but acceptable) insulation resistance of one conductor can in effect ground it and raise the other two to full conductor-to-conductor voltage to ground.

<sup>2)</sup> For equipment used on both three-phase, 4-conductor and three-phase, 3-conductor systems, grounded and non-grounded, use only the values for 3-conductor systems.

\*For the relationship to rated voltage, see 4.3.2.

\*\*These values correspond to the values given in Table F.1.

**Material Groups**

Insulation materials are classified into four groups according to their Comparative Tracking Index (CTI) as follows:

Material Group I:	$600 \leq \text{CTI}$
Material Group II:	$400 \leq \text{CTI} < 600$
Material Group IIIa:	$175 \leq \text{CTI} < 400$
Material Group IIIb:	$100 \leq \text{CTI} < 175$

The CTI values above refer to values obtained in accordance with DIN EN 60664-1/VDE 0110-1 on samples specially made for this purpose and tested with Solution A.

## Tests and Testing Procedures per IEC/EN Standards (continued)

### Electrical Tests (continued)

- Insulation Parameters per IEC/EN 60664-1 (continued)

**Table F.4: Creepage Distances to Avoid Failure due to Tracking**  
DIN EN 60664-1/VDE 0110-1

Voltage <sup>1)</sup> (RMS)	Minimum Creepage Distances								
	Printed Circuits		Pollution Degree						
	Pollution Degree		1	2	2	2	3	3	3
	1 All Material Groups	2 All Material Groups except IIIb	All Material Groups	Material Group I	Material Group II	Material Group III	Material Group I	Material Group II	Material Group III <sup>2)</sup>
V	mm	mm	mm	mm	mm	mm	mm	mm	mm
10	0.025	0.04	0.08	0.4	0.4	0.4	1	1	1
12.5	0.025	0.04	0.09	0.42	0.42	0.42	1.05	1.05	1.05
16	0.025	0.04	0.1	0.45	0.45	0.45	1.1	1.1	1.1
20	0.025	0.04	0.11	0.48	0.48	0.48	1.2	1.2	1.2
25	0.025	0.04	0.125	0.50	0.5	0.5	1.25	1.25	1.25
32	0.025	0.04	0.14	0.53	0.53	0.53	1.3	1.3	1.3
40	0.025	0.04	0.16	0.56	0.8	1.1	1.4	1.6	1.8
50	0.025	0.04	0.18	0.6	0.85	1.2	1.5	1.7	1.9
63	0.04	0.063	0.2	0.63	0.9	1.25	1.6	1.8	2
80	0.063	0.1	0.22	0.67	0.95	1.3	1.7	1.9	2.1
100	0.1	0.16	0.25	0.71	1	1.4	1.8	2	2.2
125	0.16	0.25	0.28	0.75	1.05	1.5	1.9	2.1	2.4
160	0.25	0.4	0.32	0.8	1.1	1.6	2	2.2	2.5
200	0.4	0.63	0.42	1	1.4	2	2.5	2.8	3.2
250	0.56	1	0.56	1.25	1.8	2.5	3.2	3.6	4
320	0.75	1.6	0.75	1.6	2.2	3.2	4	4.5	5
400	1	2	1	2	2.8	4	5	5.6	6.3
500	1.3	2.5	1.3	2.5	3.6	5	6.3	7.1	8 (7.9) <sup>4)</sup>
630	1.8	3.2	1.8	3.2	4.5	6.3	8 (7.9) <sup>4)</sup>	9 (8.4) <sup>4)</sup>	10 (9) <sup>4)</sup>
800	2.4	4	2.4	4	5.6	8	10 (9) <sup>4)</sup>	11 (9.6) <sup>4)</sup>	12.5 (10.2) <sup>4)</sup>
1000	3.2	5	3.2	5	7.1	10	12.5 (10.2) <sup>4)</sup>	14 (11.2) <sup>4)</sup>	16 (12.8) <sup>4)</sup>
1250			4.2	6.3	9	12.5	16 (12.8) <sup>4)</sup>	18 (14.4) <sup>4)</sup>	20 (16) <sup>4)</sup>
1600			5.6	8	11	16	20 (16) <sup>4)</sup>	22 (17.6) <sup>4)</sup>	25 (20) <sup>4)</sup>
2000			7.5	10	14	20	25 (20) <sup>4)</sup>	28 (22.4) <sup>4)</sup>	32 (25.6) <sup>4)</sup>
2500			10	12.5	18	25	32 (25.6) <sup>4)</sup>	36 (28.8) <sup>4)</sup>	40 (32) <sup>4)</sup>
3200			12.5	16	22	32	40 (32) <sup>4)</sup>	45 (36) <sup>4)</sup>	50 (40) <sup>4)</sup>
4000			16	20	28	40	50 (40) <sup>4)</sup>	56 (44.8) <sup>4)</sup>	63 (50.4) <sup>4)</sup>
5000			20	25	36	50	63 (50.4) <sup>4)</sup>	71 (56.8) <sup>4)</sup>	80 (64) <sup>4)</sup>
6300			25	32	45	63	80 (64) <sup>4)</sup>	90 (72) <sup>4)</sup>	100 (80) <sup>4)</sup>
8000			32	40	56	80	100 (80) <sup>4)</sup>	110 (88) <sup>4)</sup>	125 (100) <sup>4)</sup>
10000			40	50	71	100	125 (100) <sup>4)</sup>	140 (112) <sup>4)</sup>	160 (128) <sup>4)</sup>
12500			50 <sup>3)</sup>	63 <sup>3)</sup>	90 <sup>3)</sup>	125 <sup>3)</sup>			
16000			63 <sup>3)</sup>	80 <sup>3)</sup>	110 <sup>3)</sup>	160 <sup>3)</sup>			
20000			80 <sup>3)</sup>	100 <sup>3)</sup>	140 <sup>3)</sup>	200 <sup>3)</sup>			
25000			100 <sup>3)</sup>	125 <sup>3)</sup>	180 <sup>3)</sup>	250 <sup>3)</sup>			
32000			125 <sup>3)</sup>	160 <sup>3)</sup>	220 <sup>3)</sup>	320 <sup>3)</sup>			
40000			160 <sup>3)</sup>	200 <sup>3)</sup>	280 <sup>3)</sup>	400 <sup>3)</sup>			
50000			200 <sup>3)</sup>	250 <sup>3)</sup>	360 <sup>3)</sup>	500 <sup>3)</sup>			
63000			250 <sup>3)</sup>	320 <sup>3)</sup>	450 <sup>3)</sup>	600 <sup>3)</sup>			

<sup>1)</sup> This voltage is for:

- Functional insulation; the working voltage
- Basic and supplementary insulation of the circuit energized directly from the mains (see 4.3.2.2.1): for the voltage rationalized through Table F.3a or F.3b, based on the rated voltage of the equipment, or the rated insulation voltage
- Basic and supplementary insulation of systems, equipment and internal circuits not energized directly from the mains (see 4.3.2.2.2): the highest rms voltage which can occur in the system, equipment or internal circuit when supplied at rated voltage and under the most taxing combination of operation conditions within equipment rating

<sup>2)</sup> Material group IIIb is not recommended for applications in pollution degree 3 above 630 V.

<sup>3)</sup> Provisional data based on extrapolation. Technical committees who have other information based on experience may use their dimensions.

<sup>4)</sup> The values in brackets must only be applied for reducing creepage distances if a rib is used (see 5.2.5).

The high degree of accuracy of the creepage distances given in the table does not imply that the measuring accuracy must be of the same quality.



Depending on the intended use, WAGO's terminal blocks, as well as splicing and pluggable connectors, are suitable for pollution degrees 2 or 3 and for overvoltage categories II or III.

Example:

**WAGO Rail-Mount Through Terminal Blocks**

According to IEC 60947-7-1/EN 60947-7-1/VDE 0611-1), these blocks have the following ratings:

800 V / 8 kV / 3

Rated voltage:	800 V
Rated surge voltage:	8 kV
Pollution degree:	3
Overvoltage category:	III

WAGO's connectors for household and similar mounted installations are rated per IEC 60998-1/EN 60998-1/VDE 0613-1, Table 3.

Example:

**WAGO PUSH WIRE® Connectors for Junction Boxes**

According to this standard, these connectors are rated for:

\* 400 V / 4 kV / 2

\* grounded circuits

Rated voltage:	400 V
Rated surge voltage:	4 kV
Pollution degree:	2
Overvoltage category:	II

**Table 3: Clearances and Creepage Distances**  
(IEC/EN 60998-1)

Rated Insulation Voltage V	Clearances/Creepage Distances mm
≤ 130	1.5
> 130 and ≤ 250	3
> 250 and ≤ 450	4
> 450 and ≤ 750	6
> 750	8

## Tests and Testing Procedures per IEC/EN Standards (continued)

### Electrical Tests (continued)

• Power-Frequency Withstand Voltage Test per IEC/EN 60947-7-1, IEC/EN 60947-1

This testing procedure verifies creepage distances. Creepage distances, i.e., the distances of creeping currents, are caused by conductive impurities on the surface of the insulation housing. Apart from the amount of impurities to which a terminal block is subjected, for example, the plastic material and housing design are also involved in generating creeping currents. The insulation material of the housing may be carbonized by a creeping current, which increases conductivity even more. The specimen is tested using a power-frequency withstand voltage for a short time. For example, a rail-mount terminal block designed to operate at 800 V nominal voltage is usually tested using 2000 V alternating voltage for one minute. The test is passed if no flashovers or breakdowns have occurred.

• Rated Impulse Withstand Voltage Test per IEC/EN 60947-7-1, IEC/EN 60947-1

This test verifies the clearances of a product. In simplified terms, a clearance is the distance between two poles of a terminal block. If this distance is too small, voltage peaks may cause flashovers or breakdowns. The arrangement of the rated impulse withstand voltage test is identical to that of the power frequency withstand voltage test; the test voltages, however, are comparatively higher and the testing times shorter, e.g., 7.3 kV over 50 µs (see figure).

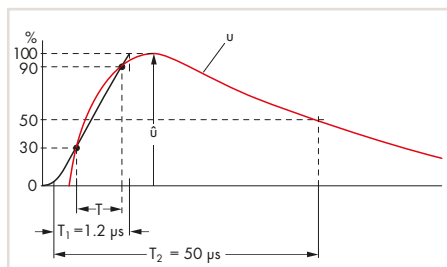

Voltage pulse: measurement curve (red) and auxiliary curve (black) for calculating the rate of rise of the pulse and the resulting (virtual) peak of the curve.

- T: Time interval for calculating the rate of rise
- T<sub>1</sub>: Front time (duration between start of impulse and reaching the peak)
- T<sub>2</sub>: Total pulse duration

The test values are the values at sea level as specified in the relevant test specification. The values indicated in the catalog correspond to an altitude of 2000 m. The test is passed if no flashovers or breakdowns have occurred.

• IP Ratings for Electrical Equipment per IEC/EN 60529

Alphanumeric Nomenclature for Type of Protection			IP vs. NEMA		
Code letters IP	Protection against accidental contact and against the penetration of foreign objects or water	IP (Ingress Protection) = International degree of protection		IP Code	NEMA
First code number 0 to 6	Indicates the degree of protection against accidental contact and the penetration of foreign objects.	If indicating the degree of protection requires only one digit, the other (second) digit must be substituted for with an X.		10	1
Second code number 0 to 8				11	2
First code number:		Second code number:		54	3
IP0X	No protection against accidental contact or the penetration of foreign objects	IPX0	No protection against water	14	3R
IP1X	Protection against foreign objects > 50 mm	IPX1	Protection against vertically falling water	54	3S
IP2X	Protection against foreign objects > 12 mm (e.g., finger)	IPX2	Protection against diagonally dripping water (15° angle)	55	4&4X
IP3X	Protection against foreign objects > 2.5 mm	IPX3	Protection against water spray	52	5
IP4X	Protection against foreign objects > 1 mm	IPX4	Protection against water spray	67	6&6P
IP5X	Protection against damaging dust deposits	IPX5	Protection against water jet, e.g., from a nozzle	52	12&12K
IP6X	Protection against dust penetration	IPX6	Protection against flooding	54	13
		IPX7	Protection against temporary immersion		
		IPX8	Protection against continuous immersion		
		IPX9	Protection against high-pressure and high-temperature water jets		

## Tests and Testing Procedures per IEC/EN Standards (continued)

### Material Tests

All WAGO products meet requirements for the following material tests:

- Needle Flame Test per IEC/EN 60947-7-1, IEC/EN 60695-11-5

This test simulates flames that may arise under certain conditions (e.g. fault current over a creepage distance, overloading of parts or components). Nearby parts can also be affected by such flames. Not only the ignition of the test specimen resulting from an intrinsic defect is tested, but also its behavior when other parts ignite.

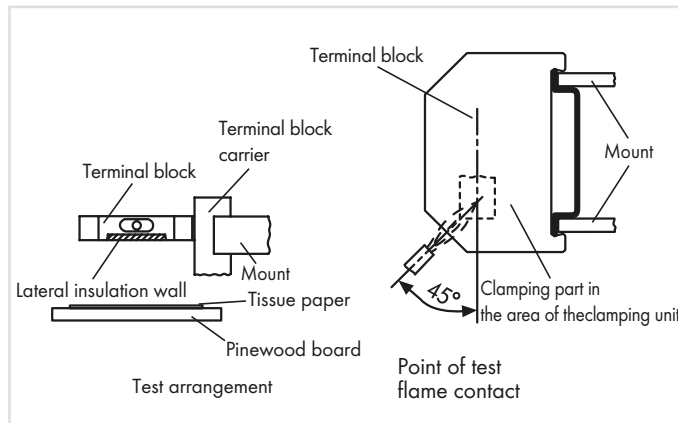

Flames must not be fuelled by the insulation materials used, thus creating a larger fire. The test specimen is exposed to a standard gas flame during a defined time period (e.g., ten seconds).

After the test flame has been removed, the specimen must self-extinguish within 30 seconds. Furthermore, a layer of tissue paper located beneath the specimen shall not be ignited by glowing particles falling from the specimen.

- Glow-Wire Test per IEC/EN 60998-1, IEC/EN 60695-2-11

In the event of failure, a high current may cause a conductor to glow.

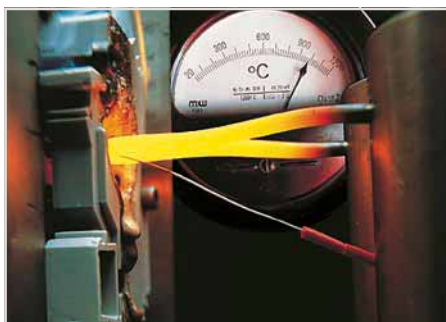

However, the glowing conductor shall not cause ignition of the product involved (e.g., a rail-mount terminal block). For the glow-wire test, the tip of the glow-wire is pressed against a surface of the test specimen (see picture). The position of the test specimen, surface to be tested, test duration and glow-wire temperature (e.g., 960 °C/1760 °F over 30 seconds, or 850 °C/1562 °F over 5 seconds) are specified in the standards. The specimen must be positioned such that the tip of the glow-wire acts on the surface section of the specimen (vertical surface of the specimen) that is most likely to be exposed to thermal loading during normal use.

As the highest temperature in the event of a fault is anticipated at the contact insert/wire connection, the tip of the glow-wire must act upon the section of the insulation housing that is the closest to this contact point.

The test is passed if there are no visible flames or permanent glowing, or if flames or glowing extinguish within 30 seconds after removal of the glow-wire. Furthermore, a layer of tissue paper located beneath the specimen shall not be ignited by glowing particles falling from the specimen.

## Tests and Testing Procedures per IEC/EN Standards (continued)

### Environmental Tests

The following tests show how a product reacts when exposed to an aggressive environment. Climatic chambers simulate standard atmospheres that could impact long-term constancy of clamping units.

All WAGO products meet requirements for the following environmental tests:

- Temperature Cycling Test per IEC/EN 60947-7-1, IEC/EN 60998-2-2

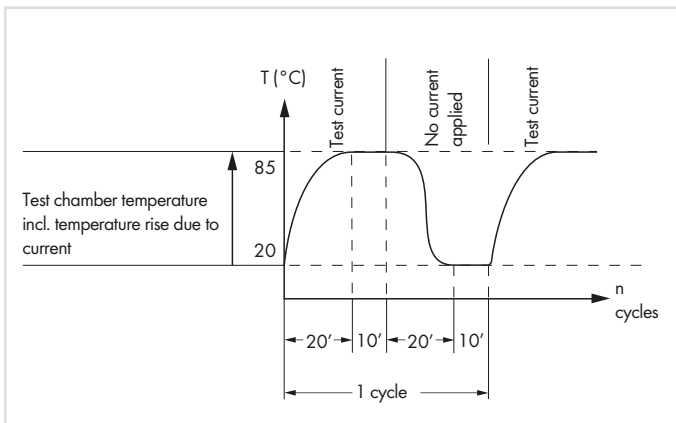

The rated current is applied to the test specimen during temperature rise and when the temperature has reached its maximum value; during the second half of the cycle, the current is zero. Voltage drop is measured every 24 cycles and must not exceed a maximum value or vary greatly. The voltage drop measured at the end of the 192nd cycle must not exceed 1.5 times the value measured after the 24th cycle. After the test, an inspection must show no changes that would impair further use of the product.

- Industrial Atmospheres per EN ISO 6988, IEC/EN 60068-2-42, IEC/EN 60068-2-60

Sulphur and its combustion products are particularly aggressive pollutants commonly found in industrial environments. A test procedure simulating such corrosive conditions consists of exposing a test specimen to water condensation in variable atmospheres containing sulphur dioxide.



A saturated atmosphere is first created in a climatic chamber by heating an aqueous sulphur dioxide solution. After less than half an hour, the test specimen is fully saturated by the condensing vapors and exposed to this atmosphere for eight hours.

After exposure to a humid atmosphere, the test specimen is subjected to dry and cooler conditions at room temperature for 16 hours. Depending on the test severity, the specimen is exposed to both these conditions several times. The gas-tightness of the clamping unit is verified by a voltage drop test.

In other test procedures, products are exposed to a dry corrosive gas atmosphere containing sulfide, nitrogen and sulfur oxides or chloride gas. These tests can be performed over a period of four to 21 days.

• Salt Spray Test per IEC/EN 60068-2-11; DNV GL, LR (Marine Applications)

This test is similar to the test performed in water condensation alternating atmospheres, except that instead of industrial atmospheres, salt mist conditions will be simulated in a heated test chamber (see picture).

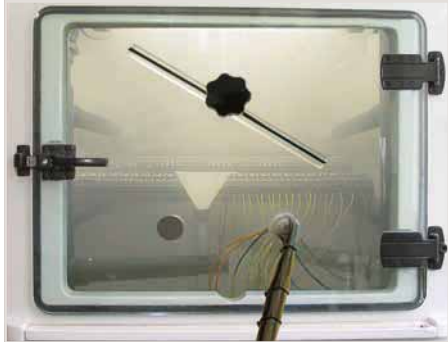

Depending on the test procedure being used, the test specimen is sprayed with salt mist for 16 hours up to 672 hours (4 weeks).

Salt spray tests are widely used, especially for ship approvals.

However, this test is performed differently than the test procedures described previously for general applications:

During a typical test, the test specimen is sprayed with a salt solution for two hours and is then stored for seven days in an atmosphere with a relative humidity between 90 and 95 %.

This procedure is repeated four times.

Voltage drop measurements are used as an evaluation criterion.

• Quick Change of Temperature per IEC/EN 60068-2-14

Without air-conditioning, distribution panels and terminal boxes are exposed to seasonal (and ever-changing) temperature extremes – especially on the open field side.

In process technology, for example, a terminal block is exposed to even quicker changes in temperature.

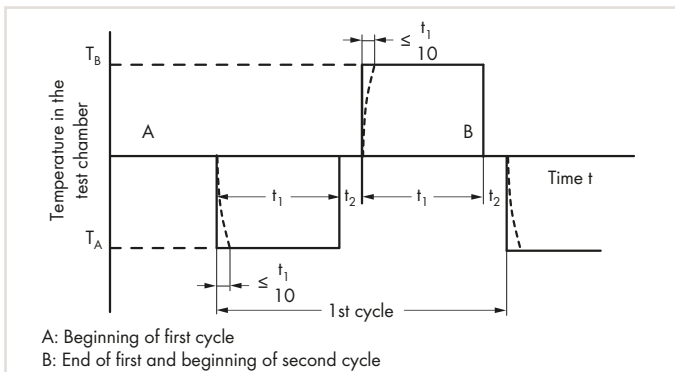

To simulate such conditions, the test specimen is exposed to repeated temperature changes, for example, between  $T_A -40\text{ °C} (-104\text{ °F})$  and  $T_B +70\text{ °C} (+158\text{ °F})$ .

The dwell time  $t_1$  depends on the thermal capacity of the test specimen and should be between maximum of 3 hours and minimum of 10 minutes and the transition time  $t_2 \dots 3\text{ min.}, 20 \dots 30\text{ sec.}$  or less than 10 seconds.

The mechanical and electrical properties of the product are checked at the end of the test.

• Damp Heat, Cyclic (12 + 12 Hour Cycle) per IEC/EN 60068-2-30, DNV GL, LR (Marine Applications)

This test determines the suitability of electrical equipment for use and storage under conditions of high relative humidity when combined with cyclic temperature changes and, in general, producing condensation on the surface of the specimen.

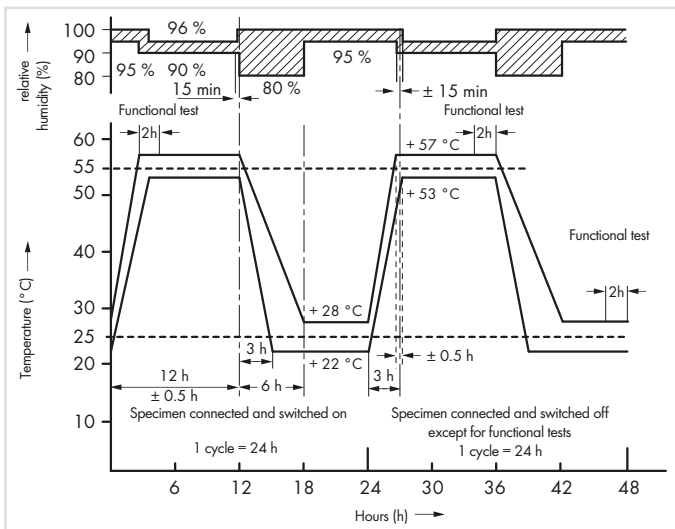

In addition to the salt spray tests, the damp heat test is also used for marine approvals.

For this test, the specimens are subjected to temperatures varying cyclically between  $+25\text{ °C} (+77\text{ °F})$  and  $+55\text{ °C} (+131\text{ °F})$  with a relative humidity of 95 % (for tolerances see figure).

Functional tests are performed at defined times during the storage period.

The mechanical and electrical properties of the product are checked at the end of the test.

## UL Specifications – Underwriters Laboratories, USA

WAGO's terminal blocks and connectors are tested by Underwriters Laboratories Inc. according to one or more of the relevant following UL standards:

- |   |                     |   |
|---|---------------------|---|
| • The 273 Series PUSH WIRE® Connectors for Junction Boxes or the 224 Series Lighting Connectors are splicing wire connectors and are certified per UL 486C. These stand-alone devices carry the <b>UL Listing Mark</b> ®.   | UL 486 C            | Splicing wire connectors  |
| • Rail-mount terminal blocks or modular terminal blocks (e.g., 280 Series, TOPJOB® S or 260 to 262 Series terminal blocks) are approved as non-stand-alone components per UL 1059 in connection with UL 486E.   | UL 1059<br>UL 486 E | Standard for terminal blocks<br>Equipment wiring terminals for use with aluminum and/or copper conductors |
| • The X-COM®-SYSTEM is approved as terminal blocks per UL 1059 standard in connection with UL 486 E. It is therefore defined for field and factory wiring with at 300 V.  |                     |   |
| • It is also approved as connectors for use in data, signal, control and power applications per UL 1977 for factory wiring at 600 V (i.e., the clamping unit must be wired under controlled manufacturing conditions).  | UL 1977             | Component connectors for use in data, signal, control and power applications                              |
| • Ex e II terminal blocks are approved to UL 60079-7.   | UL 60079-7          | Electrical apparatus for explosive gas atmospheres – Part 7: Increased safety                             |
| • Ground terminal blocks are tested for grounding and bonding applications per UL 467. Components bearing the <b>UR Recognition Mark</b> ® are recognized product. Additionally, after being mounted in their special applications, these components are submitted to an end-product test according to the relevant device or equipment standard. | UL 467              | Grounding and bonding equipment   |
| • Insulation materials are tested for flammability and performance per UL 94.   | UL 94               | Tests for flammability of plastic materials for parts in devices and appliances                           |



**Tests and Testing Procedures per UL Standards**

All WAGO products meet requirements for the following tests:

- Pull-Out Test per UL 1059, UL 486 E (Rail-Mount Terminal Blocks), UL 486 C (Splicing Wire Connectors)

In this test, the connected conductors are subjected to the appropriate pull-out forces specified in the following table without jerking for a period of one minute. Different test arrangements are specified for rail-mount terminal blocks and splicing wire connectors.

Conductor Size AWG or kcmil		Pull-Out Force, Pounds (N)					
		UL 486 E, Table 22				UL 486 C, Table 20	
		Copper		Aluminum		Copper	
30	(0.05)	0,5	(2.2)	-	-	1,5	(6.7)
28	(0.08)	1	(4.5)	-	-	2	(8.9)
26	(0.13)	2	(8.9)	-	-	3	(13.4)
24	(0.2)	3	(13.4)	-	-	5	(22.3)
22	(0.32)	4,5	(20)	-	-	8	(35.6)
20	(0.52)	6,75	(30)	-	-	10	(44.5)
18	(0.82)	6,75	(30)	-	-	10	(44.5)
16	(1.3)	9	(40)	-	-	15	(66.7)
14	(2.1)	11,5	(50)	-	-	25	(111)
12	(3.3)	13,5	(60)	10	(44)	35	(155)
10	(5.3)	18	(80)	10	(44)	40	(178)
8	(8.4)	20,5	(90)	10	(44)	45	(200)
6	(13.3)	21	(94)	28	(124)	50	(222)
4	(21.2)	30	(133)	36	(160)		
3	(26.7)	35	(156)	42	(187)		
2	(33.6)	42	(186)	50	(222)		
1	(42.4)	53	(236)	61	(271)		
1/0	(53.5)	64	(285)	72	(320)		
2/0	(67.4)	64	(285)	78	(347)		
3/0	(85.0)	79	(351)	97	(432)		
4/0	(107)	96	(427)	116	(516)		
250	(127)	96	(427)	116	(516)		
300	(156)	99	(441)	116	(516)		

Test Arrangement per UL 1059, UL 486 E:

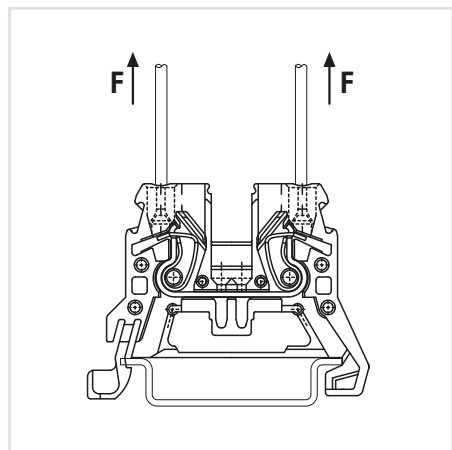

Test Arrangement per UL 486 C:

During the test, the conductors must neither slip out of the clamping unit, nor break near the clamping unit.

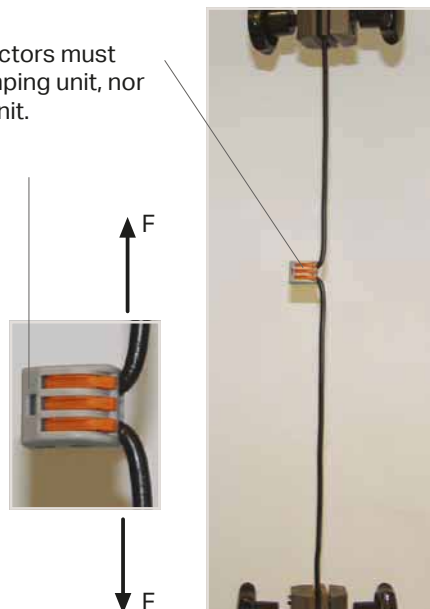

## UL Specifications – Underwriters Laboratories, USA (continued)

### Tests and Testing Procedures per UL Standards (continued)

#### • Heat Cycling Test per UL 1059, UL 486 E

Test performed per:

**UL 1059**

Test performed with maximum rated cross-section

Test current: 150 % of maximum rated current

84 cycles of: 3 1/2 h ON / 1/2 h OFF

The temperature rise is measured after the first and the 84th cycle.

The temperature rise must not exceed 5 °C (41 °F) after the 84th cycle, compared to the temperature measured after the first cycle.

**UL 486 C** (Splicing wire connectors)

**UL 486 E** (Equipment wiring terminals)

Test performed with maximum rated cross-section

Test current: Increased test current per  
UL 486 C, Table 6  
UL 486 E, Table 4

500 cycles of: 1 h ON / 1 h OFF  
1 1/2 h ON / 1 1/2 h OFF  
(from 4/0 AWG up to 400 kcmil  
per UL 486 E)

The temperature rises at the terminal blocks and control conductors are measured and recorded after: 1, 25, 50, 75, 100, 125, 175, 225, 275, 350, 425 and 500 cycles.

The temperature rise must not exceed 125 °C (257 °F) and the stability factor "S" must not exceed ± 10.

Conductor Size		Test Current for Copper Conductors in A								
		UL 486 E, Table 4						UL 486 C, Table 6		
		Assigned Maximum Ampere Rating <sup>b</sup>	Static Heating <sup>a,c,g</sup>	Heat Cycling Temperature Rating <sup>a</sup>			Static Heating	Heat Cycling		
75 °C (167 °F) <sup>d,g</sup>	90 °C (194 °F) <sup>e,g</sup>									
AWG or kcmil	(mm <sup>2</sup> )									
30	(0.05)	-		3		3.5		4	3	3.5
28	(0.08)	-		3.5		4		5	3.5	4
26	(0.13)	-		5.5		6		8	5.5	6
24	(0.2)	-		7		8		10	7	8
22	(0.32)	-		9		12		13	9	12
20	(0.52)	-		12		16		17	12	16
18	(0.82)	-		17		19		24	17	19
16	(1.3)	-		18		20		31	18	20
14	(2.1)	15	[20]	30	[22]	33	[27]	40	30	33
12	(3.3)	20	[25]	35	[28]	39	[40]	54	35	38
10	(5.3)	30	[40]	50	[45]	56	[60]	75	50	56
8	(8.4)	50		70		80		100	70	80
6	(13.3)	65		95		105		131	95	105
4	(21.2)	85		125		140		175		
3	(26.7)	100		145		165		205		
2	(33.6)	115		170		190		240		
1	(42.4)	130		195		220		275		
1/0	(53.5)	150		230		255		320		
2/0	(67.4)	175		265		300		370		
3/0	(85.0)	200		310		345		435		
4/0	(107)	230		360		405		505		
250	(127)	255		405		445		565		
300	(152)	285		445		500		625		

<sup>a</sup> See Section 7.2, 8.2 and 9.2 (UL 486 E)

<sup>b</sup> Values are for 75 °C (167 °F), not more than 3 conductors in raceway or cable ampacities, National Electric Code, ANSI/NFPA 70.

<sup>c</sup> Values are for 75 °C (167 °F) single conductors in free air ampacities, National Electric Code, ANSI/NFPA 70.

<sup>d</sup> Values are approximately 112 % of the static heating test currents.

<sup>e</sup> Values for 8 AWG and larger conductors are approximately 140 % of the static heating test currents.

<sup>f</sup> See Section 9.2.4

<sup>g</sup> Values in parentheses apply to connectors with assigned ampere ratings.

• Conditioning – Temperature-Rise Rest per UL 1059, UL 486 C

Test performed per:

**UL 1059** (Rail-mount terminal blocks)

**UL 486 C**

(Splicing wire connectors)

**Conditioning:**

The clamping units are **pre-wired/pre-inserted nine times** using a conductor with maximum rated cross-section. At the 10th time, a new conductor is connected. After this, a static heating test is performed.

**Static Heating Test:**

Test current: Terminal block rated current

Test current:

Increased test current (see Table 6)

Test duration: 30 days

Test duration:

30 days

Max. permissible temperature rise: 30 °C (86 °F)

Max. permissible temperature rise:

50 °C (122 °F)

• Grounding and Bonding Equipment per UL 467

When used in grounding and bonding equipment, e.g., terminal blocks, must withstand a short circuit test using the test currents and test durations as specified in Table 5.

In the following example, a 2 AWG (35 mm<sup>2</sup>) ground conductor terminal block (285-635) is tested for 6 seconds at 3900 A.

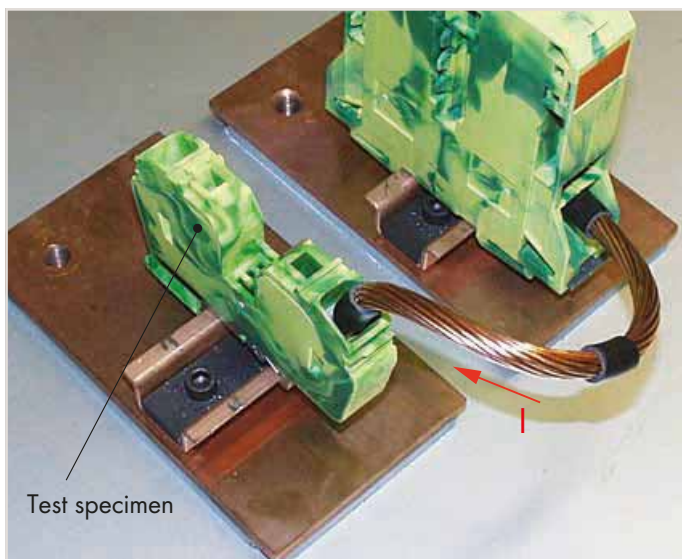

Table 5:

Conductor Size Copper		Test Duration	Test Current
AWG	mm <sup>2</sup>		
14	(2.1)	4	300
12	(3.3)	4	470
10	(5.3)	4	750
8	(8.4)	4	1180
6	(13.3)	6	1530
4	(21.2)	6	2450
3	(26.7)	6	3100
2	(33.6)	6	3900
1	(42.4)	6	4900
1/0	(53.5)	9	5050
2/0	(67.4)	9	6400
3/0	(85.0)	9	8030
4/0	(107)	9	10100
250 kcmil	(127)	9	12000

After the test, the specimen must neither show evidence of cracking, breaking or melting, nor any changes in electrical properties.

## UL Specifications – Underwriters Laboratories, USA (continued)

### Tests and Testing Procedures per UL Standards (continued)

#### • Insulation Parameters per UL 1059

The table below shows the potential involved and the corresponding clearances and creepage distances required in different applications.

**Table 8.1: Minimum Acceptable Spacing for Terminal Blocks per UL 1059 Standard**

Application	Potential Involved in Volts	Spacing in inches (mm) between uninsulated live parts of opposite polarity, uninsulated live parts and uninsulated grounded parts other than the enclosure			
		Through Air		Over Surfaces	
A. Dead-front switchboards, panelboards, service equipment and similar applications	51 ... 150	1/2	(12.7)	3/4	(19.1)
	151 ... 300	3/4	(19.1)	1-1/4	(31.8)
	301 ... 600	1	(25.4)	2	(50.8)
B. Commercial appliances, including business equipment, electronic data processing equipment and similar applications	51 ... 150	1/16 <sup>a</sup>	(1.6) <sup>a</sup>	1/16 <sup>a</sup>	(1.6) <sup>a</sup>
	151 ... 300	3/32 <sup>a</sup>	(2.4) <sup>a</sup>	3/32 <sup>a</sup>	(2.4) <sup>a</sup>
	301 ... 600	3/8	(9.5)	1/2	(12.7)
C. Industrial, general	51 ... 150	1/8 <sup>a</sup>	(3.2) <sup>a</sup>	1/4	(6.4)
	151 ... 300	1/4	(6.4)	3/8	(9.5)
	301 ... 600	3/8	(9.5)	1/2	(12.7)
D. Industrial, devices having limited ratings <sup>b</sup>	51 ... 300	1/16 <sup>a</sup>	(1.6) <sup>a</sup>	1/8 <sup>a</sup>	(3.2) <sup>a</sup>
	301 ... 600	3/16 <sup>a</sup>	(4.8) <sup>a</sup>	3/8	(9.5)
E. Terminal blocks rated 601 ... 1500 V <sup>c</sup>	601 ... 1000	0.55	(14.0)	0.85	(21.6)
	1001 ... 1500	0.70	(17.8)	1.20	(30.5)

Notes:

1 A slot, groove, or similar, 0.013 inch (0.33 mm) wide or less in the contour of the insulating material is to be disregarded.

2 Air space of 0.33 mm or less between a live part and an insulating surface is to be disregarded for the purpose of measuring over surface spacing.

<sup>a</sup> The spacing between terminal blocks of opposite polarity and the spacing between a terminal block and a grounded dead metal part shall not be less than 1/4 inch (6.4 mm) if short-circuiting or grounding of such terminal blocks may result from protruding wire strands.

<sup>b</sup> See Section 8.5 (UL 1059)

The spacing values indicated in sub-paragraph D in Table 8.1 are applicable to a terminal block for use only in or with industrial control equipment where the load on any single circuit of the terminal block does not exceed

15 A at 51 ... 150 V, 10 A at 151 ... 300 V, 5 A at 301 ... 600 V or the maximum ampere rating, whichever is less.

<sup>c</sup> Applies only to terminal blocks investigated to Part II of this standard. See Section 22.1 (UL 1059).

#### • Flammability Test per UL 94

This test provides an indication of the material's ability to extinguish a flame, once ignited.

Several ratings can be applied, based on the rated of burning, time to extinguish, ability to resist dripping, and after-glow extinguishing time.

Each material tested may receive several ratings, depending on the wall thickness.

UL 94 Rating Categories:

##### V2

- Specimen mounted vertically
- Burning stops within 30 seconds after the flame is removed
- Flaming drips allowed
- After-glow extinguishes within 60 seconds max.

##### V1

- Specimen mounted vertically
- Burning stops within 30 seconds after the flame is removed
- No flaming drips allowed
- After-glow extinguishes within 60 seconds max.

##### V0

- Specimen mounted vertically
- Burning stops within 10 seconds after the flame is removed
- No flaming drips allowed
- After-glow extinguishes within 30 seconds max.

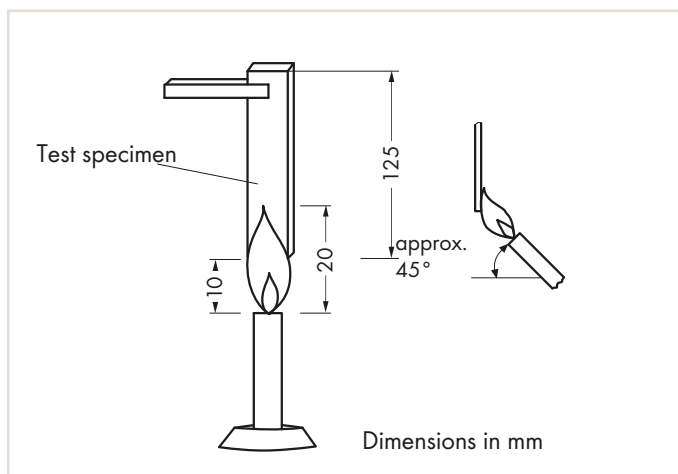

During the test, a 3/4 inch (20 ± 1 mm) flame is applied for two 10-second intervals to the specified bar specimen held vertically.

## "Alu-Plus" Contact Paste

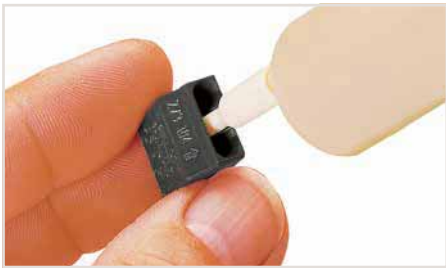

**WAGO Junction Box Connectors:**  
Push nozzle of the "Alu-Plus" syringe into the center conductor entry hole of the WAGO junction box connector.



Press plunger down until "Alu-Plus" is visible in the other holes.

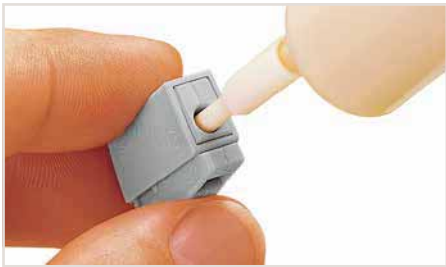

**WAGO Lighting Connectors:**  
Push nozzle of the "Alu-Plus" syringe first into the circular and then into the square conductor entry hole of the WAGO lighting connector.

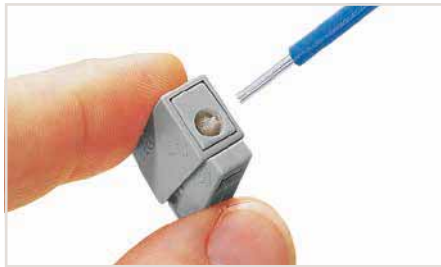

Press plunger down until the "Alu-Plus" has filled both entry holes.

**Note:** Not suitable for higher temperature applications!



**WAGO Rail-Mount Terminal Blocks (up to 4 mm<sup>2</sup>/12 AWG):**  
For each conductor entry: Insert nozzle of the "Alu-Plus" syringe in every open conductor entry hole (one after the other).

WAGO "Alu-Plus" in the syringe offers a higher degree of reliability and cleanness when terminating solid aluminum conductors. Filling is quickly performed on selected WAGO connectors and terminal blocks (see pictures).



Press plunger down until "Alu-Plus" has filled all conductor entry holes.

① Aluminum conductors per IEC 61545 standard, Class B, "Alloy 1370" with 90 ... 180 N/mm<sup>2</sup> tensile strength and 1 ... 4 % elongation. Standard values: 90 ... 180 MPa tensile strength, 1 ... 4 % elongation (per EN 615.4.1)

**Terminating Aluminum Conductors**  
WAGO spring clamp terminal blocks are suitable for solid aluminum conductors up to 4 mm<sup>2</sup>/12 AWG if WAGO "Alu-Plus" contact paste is used for termination.

WAGO "Alu-Plus":

- Automatically destroys the oxide film during clamping
- Prevents fresh oxidation at the clamping point
- Prevents electrolytic corrosion between aluminum and copper conductors (in the same terminal block)
- Offers permanent protection against corrosion

Using terminal blocks with CAGE CLAMP® Spring Pressure Connection Technology, aluminum conductors must first be cleaned with a blade and then immediately be inserted into the clamping units filled with "Alu-Plus" contact paste.

It is also possible to apply WAGO "Alu-Plus" additionally on the whole surface of the aluminum conductor before termination.

Please note that the nominal currents must be adapted to the reduced conductivity of the aluminum conductors:

2.5 mm<sup>2</sup> (14 AWG) = 16 A  
4 mm<sup>2</sup> (12 AWG) = 22 A

## Material Specifications

### Insulation Materials

WAGO primarily uses polyamide (PA 66 and PA 46) as carriers of current-conducting parts and polycarbonate (PC) as insulation material (see table). For more than 40 years, these materials have proven themselves in WAGO products and all are approved by certified, third-party agencies.

WAGO primarily uses polyamide (PA 66 and PA 46) for housing current-conducting parts, as well as polyphthalamide (PPA) and polycarbonate (PC) for insulation material (see table). For more than 50 years, these materials have proven themselves in WAGO products and all are approved by certified, third-party agencies. All listed halogen-free and flame-retardant polymer materials do not contain any heavy metals, silicone, asbestos, or formaldehyde as formulation components.

**Table: Standard Insulation Materials**

Material	PA 66	PA 66 GF	PPA GF	PA 46	PC	PC
Flammability UL 94 flammability test ratings	V0	V0	V0	V2	V2	V0
Oxygen Index (OI) per EN ISO 4589-2	> 32 %	> 33 %	> 37 %	> 27 %	> 26 %	> 35 %
Glow-wire test per IEC 60695-2-12 GWFI* IEC 60695-2-13 GWIT*	850 °C 775 °C	850 °C 775 °C	850 °C 775 °C	750 °C 725 °C	800 °C 850 °C	960 °C 850 °C
Comparative Tracking Index (CTI) per IEC 60112	600 V	600 V	600 V	375 V	225 V	225 V
Temperature of the ball indentation hardness test per IEC 60695-10-2	≥ 125 °C	≥ 175 °C	≥ 225 °C	n.s.**	≥ 125 °C	≥ 125 °C
RTI impact per UL 746B	105 °C	100 °C	115 °C	115 °C	125 °C	120 °C
Heat deflection temperature (HDT/B) per ISO 75 (bending stress A*: 1.8 MPa; B: 0.45 MPa)	215 °C	235 °C	285 °C	280 °C	130 °C (1.8 MPa)	130 °C (1.8 MPa)
Surface resistivity per IEC 60093	10 <sup>12</sup> Ω	10 <sup>12</sup> Ω	10 <sup>15</sup> Ω	10 <sup>13</sup> Ω	10 <sup>15</sup> Ω	10 <sup>15</sup> Ω
Specific contact resistance per IEC 60093	10 <sup>15</sup> Ω/cm	10 <sup>15</sup> Ω/cm	10 <sup>13</sup> Ω/cm	10 <sup>13</sup> Ω/cm	10 <sup>11</sup> Ω/cm	10 <sup>13</sup> Ω/cm
Dielectric strength per IEC 60243-1	30 kV/mm	40 kV/mm	25 kV/mm	25 kV/mm	25 kV/mm	29 kV/mm

\*Value depends on wall thickness, EN 60335 compliance upon request; \*\*n. s. = not specified



**Polyamide (PA 66)**

WAGO uses modified, halogen-free, flame-retardant polyamides.

These materials do not corrode, are difficult to ignite and feature self-extinguishing properties (V0 rating per UL 94).

Adhering to UL 746C, the polyamides used at WAGO have a continuous operating temperature of 105 °C (221 °F) based on the relative temperature index with impact load ( $RTI_{imp}$ ). This ensures that the necessary electrical and mechanical insulating properties are maintained at a sufficiently guaranteed level over a long period of time.

The short-term upper temperature limit is 200 °C (392 °F).

In lower temperature ranges, it has been determined that no damage to the insulation material occurs during usage down to -35 °C (-31 °F). After installation and wiring, WAGO products can even be used at temperatures down to -60 °C (-76 °F).

Environmental humidity (up to 2.5 % in a standard atmosphere) is absorbed, providing the polyamides with optimum elasticity, strength and durability.

In practical use, basic stabilization of WAGO's polyamides has been proven over many years as sufficient to prevent damage caused by ozone or UV radiation exposure in intended applications.

Polyamides have excellent resilience against the most demanding climates and have proven themselves in tropical applications worldwide. Insulation parts made of polyamide are resistant to insects. The material does not provide oxygen or other biogenic elements to microorganisms.

The presence of anaerobic earth bacteria, mold, fungus and enzymes does not degrade the material.

Polyamides are resistant to most fuels, greases, and oils, as well as the most commonly used cleaners, such as alcohol, Freon, Frigen, and carbon tetrachloride. Acid resistance depends on the acid type and concentration, as well as the exposure time.

The use of insulation materials during in-house production at WAGO only occurs after acceptance of factory test certificates and specified material tests.

**Glass Fiber-Reinforced Polyamide (PA 66 GF)**

WAGO uses glass-fiber-reinforced polyamides for components with increased mechanical demands, such as levers, push-buttons or housings exposed to high stresses, because glass-reinforced polyamides have significantly higher characteristic properties than non-reinforced polyamides.

In general, materials are used that have excellent creepage current resistance, flammability ratings and high temperature resistance.

More data can be found in the table.

**Polyphthalamide (PPA GF)**

Glass-fiber-reinforced, high-performance polyamides are ideal for high-temperature applications, due to the material's high level of thermal dimensional stability, its low dependence on ambient conditions and its excellent strength properties. The material's outstanding tracking resistance permits short creepage distances to be incorporated into miniature components. Fire protection equipment enables placement into flammability class V0 per UL 94 – even for extremely thin walls. PPA GF absorbs minute amounts of moisture from the ambient air, making it ideal for reflow soldering applications and for thin-walled, dimensionally stable components.

More data can be found in the table.

**Polyamide (PA 46)**

In comparison with PA 66, PA 46 has substantially higher dimensional stability under heat. The relative temperature index with impact load ( $RTI_{imp}$ ) is 115 °C (239 °F) for PA 4.6.

The reliable short-term temperature for the type used by WAGO is 280 °C (536 °F).

More data can be found in the table.

**Polycarbonate (PC)**

Polycarbonate has excellent dimensional stability under heat. The electrical and mechanical properties remain intact at extremely high temperatures up to approximately 120 °C (248 °F) per UL Yellow Card. Its excellent electrical insulating properties and dimensional stability are virtually independent of environmental conditions, such as humidity and temperature. Highly precise components can be created due to the low shrinkage of the material during injection molding. Polycarbonate has excellent weather resistance and is also highly resistant to high-energy radiation.

If the PC is not colored, then the components are glass-clear.

Thanks to its desirable properties (e.g., dimensional stability, heat resistance, non-flammability, durability and transparency), PC is a proven and widely used material in the electrical industry.

Depending on the demands placed on the finished product, WAGO uses polycarbonates that carry flammability classifications V2 and V0 per UL 94.

Medium-viscosity PC is used that features excellent chemical resistance.

## Material Specifications

### Contact Materials

Hard and extra-hard electrolytic copper (ECu), as well as extra-hard copper alloys are the standard materials used for the current-carrying parts of all WAGO products.

These materials combine excellent conductivity and good chemical resistance without the risk of stress-induced cracking.

### Contact Plating

The special tin layer, which is the standard layer for all current-carrying parts in WAGO products, ensures perfect long-term protection against corrosive substances. Furthermore, these layers provide a gas-tight contact that ensures a durable transition resistance.

At the clamping unit, the conductor is embedded into the soft tin layer via high contact pressure. This protects the contact area against corrosion.

The thick tin layer also ensures good solderability of both PCB terminal block and connector solder pins.

### Clamping Spring Material

Every WAGO clamping spring is made of high-quality, accurately tested austenitic chrome nickel steel (CrNi) with high tensile strength, which boasts proven corrosion resistance through long-term usage.

It is resistant to sea spray, city pollutants and industrial emissions (e.g., sulfur dioxide, hydrogen sulfide).

At room temperatures of approximately 20 °C (68 °F), the material is resistant to salt solutions up to 30 % and dilute phosphoric acids up to 30 %.

Even after decades of use, no galvanic corrosion between the chrome nickel spring steel (in connection with the contact materials used by WAGO) and the connected copper conductors has been detected.

The relaxation of the material as a function of time and surrounding temperatures up to 105 °C (221 °F) can be ignored. Samples loaded with 500 N/mm<sup>2</sup> at a temperature of 250 °C (482 °F) showed a relaxation of only 1.5 %.

In certain product lines, the clamping springs are thermally treated at temperatures between 350 °C (662 °F) and 420 °C (788 °F) after production.

This treatment reduces internal stress due to the material's mechanical deformation, which may result in a slight brown discoloration of the spring surface.

WAGO only accepts deliveries of chrome nickel spring steel against certificates of conformity and after select material tests have been performed.

## Electrical Engineering Laboratory Product Safety for Our Customers

WAGO's Minden, Germany laboratory is an "accredited test lab for electrical and mechanical tests on terminal blocks and connectors, as well as for environment simulations."

Accreditation, as ISO/IEC 17011:2004 defines, is a third party-attestation related to a conformity assessment body conveying formal demonstration of its competence to carry out specific conformity assessment tasks.

Accreditation, according to DIN EN ISO/IEC 17025, is granted by the Deutsche Akkreditierungsstelle GmbH DAkkS (German Accreditation Office GmbH DAkkS). This national accreditation office, which was established by the German Federal Ministry for Economics and Technology (BMWi), certifies that our test laboratory is officially recognized as possessing the necessary expertise to conduct defined tests and types of tests independently and objectively.



### Visitor Center

Through obtaining the accreditation, the following objectives were achieved:

- Exceeding customer requirements
- Workflow optimization
- Clearly defined processes
- Clear organization and structure
- Greater transparency
- Consistent, high-quality laboratory testing
- Maximum traceability
- Traceable measurement results
- Sustainable quality awareness

### Conductor Retention Force Testing



### High-Voltage Test



### Vibration- and Shock- Resistance Testing



## General Technical Information on Electrical Equipment Used in Hazardous Areas

A prerequisite for a potentially explosive hazard is the formation of an explosive atmosphere. Such an atmosphere can be produced at any location where flammable gases or liquids are manufactured, processed, transported and/or stored.

Such **hazardous areas** can be found in a wide range of industries, including chemical plants, refineries, power plants, paint producing facilities, painting shops, filling stations, vehicles, sewage treatment plants, airports, grain mills or harbor facilities.

### THE FOLLOWING APPLIES AS A GUIDELINE FOR THE UNDERLYING PRINCIPLE FOR EXPLOSION PROTECTION:

#### General Requirements

The European EN 60079-0 Standard – VDE 0170 Classification, Part 1 – contains general requirements for the design and testing of electrical equipment to be used in hazardous areas.

This ensures this equipment does not cause an explosion in the surrounding atmosphere.

EN 60079-0 is supplemented or revised by the European standards indicated on the right which refer to the specifically standardized types of protection.

#### Electrical Equipment

Electrical equipment includes all items used in whole or in part with electricity. This includes items for generation, transport, distribution, storage, measurement, control, conversion and consumption of electrical power, as well as telecommunications.

#### Ex Components

Ex components are elements of electrical equipment for hazardous areas that are marked with the "U" letter. These components must not be used on their own in such areas and require an additional certificate when used in such areas when installed in the electrical equipment.

#### Ignition Protection Categories

Only explosion-proof (protected) equipment must be used in areas in which an explosive atmosphere may still be expected despite the implementation of prevention measures.

Explosion-protected electrical equipment can have various types of protection in accordance with the EN 60079 standard requirements.

Protection used by the manufacturer essentially depends on the type and function of the apparatus. From a safety point of view, all standardized types of protection should be viewed as equal. The ignition protection category "n" exclusively describes the use of explosion-protected electrical components in Zone 2. This zone includes areas in which hazardous, potentially explosive atmospheres are likely to occur rarely or short-term. This represents a transition between Zone 1, in which explosion protection is required, and the safe area in which, for example, welding may be performed at any time.

Regulations covering these electrical components are being prepared worldwide. Organizations such as KEMA in the Netherlands, or PTB in Germany certify that the devices meet the requirements of the EN 60079-15 standard.

Ignition protection category "n" also requires that electrical equipment be provided with additional ID markings as follows:

- A – non-sparking (function modules without relays/switches)
- AC – sparking, contacts protected with seals (function modules with relays/without switches)
- L – limited power (function modules with switches)

The table on the opposite page shows an overview of the standardized ignition protection categories and describes their basic principle, as well as typical applications.

Ignition Protection Categories			
Symbol	Standard	Explanation	Application Area
"o"	IEC 60079-6 EN 60079-6	<b>Equipment protection by oil immersion:</b> Electrical equipment or parts of such equipment are immersed in oil.	Zones 1 + 2
"p"	IEC 60079-2 EN 60079-2	<b>Equipment protection by pressurized enclosure:</b> The ingress of the external (explosive) atmosphere into the electrical equipment housing is prevented by maintaining a protective gas internally at a pressure above that of the external atmosphere.	Zones 1 + 2
"q"	IEC 60079-5 EN 60079-5	<b>Equipment protection by sand filling:</b> Filling the electrical equipment housing with fine grain sand prevents the ignition of a surrounding explosive atmosphere by an electric arc generated in the housing.	Zones 1 + 2
"d"	IEC 60079-1 EN 60079-1	<b>Equipment protection by flameproof enclosures:</b> The parts that could ignite an explosive atmosphere are encapsulated in a housing, which will withstand the explosion pressure within the housing.	Zones 1 + 2
"e"	IEC 60079-7 EN 60079-7	<b>Equipment protection by increased safety:</b> Additional measures applied to achieve increased security against the possibility of excessive temperatures and the occurrence of arcs or sparks.	Zones 1 + 2
"i"	IEC 60079-11 EN 60079-11	<b>Equipment protection by intrinsic safety:</b> Power circuit in which no sparks or thermal effects can occur and cause the ignition of a certain explosive atmosphere.	Zones 1 + 2 following special testing Zone 0
"n"	IEC 60079-15 EN 60079-15	<b>Equipment protection by type of protection "n":</b> Electrical equipment of group II for use in areas in which an explosive mixture of gas, vapor or mist is unlikely to occur during normal operation and, if it does, will be for a short period.	Zone 2
"m"	IEC 60079-18 EN 60079-18	<b>Equipment protection by cast encapsulation:</b> Dangerous electrical equipment is embedded in a cast mass. This corresponds approximately to the known special Ex s protection type.	Zones 1 + 2
	IEC 60079-25 EN 60079-25	<b>Intrinsically safe electrical systems "i":</b> Assembly of interconnected electrical equipment in which the circuits intended for use, as a whole or in part, in hazardous environments are intrinsically safe. It is documented accordingly in the system description	Zones 1 + 2 following special testing Zone 0
	IEC / TS 60079-27	<b>FISCO standard:</b> Electrical equipment for explosive gas atmospheres – Part 27: Fieldbus intrinsically safe concept (FISCO) and Fieldbus non-incendive concept (FNICO)	



## General Technical Information on Electrical Equipment Used in Hazardous Areas (continued)

### Hazardous Areas

Hazardous areas are zones in which the atmosphere may become explosive. An explosive atmosphere is a mixture of flammable substances in the form of gases,

vapors or mixtures with air under atmospheric conditions in critically mixed ratios such that excessive high temperature, arcs or sparks may cause an explosion.

DIN EN 1127-1 and all other related standards that are well-known divide up hazardous areas according to the likelihood of the occurrence of an explosive atmosphere into the following zones:

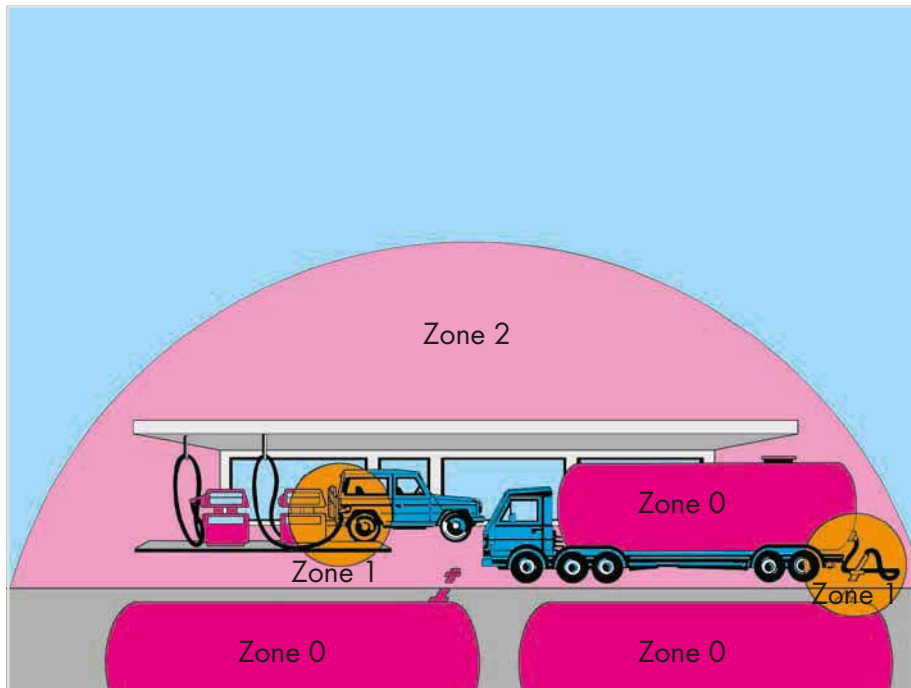

Hazardous areas due to explosive gases, vapors and mists:

#### Zone 0:

Areas in which an explosive atmosphere is present continuously, for long periods or frequently.

#### Zone 1:

Areas in which hazardous, potentially explosive atmospheres are likely to occur occasionally during normal operation.

#### Zone 2:

Areas in which an explosive atmosphere is likely to occur rarely or only for a short period during normal operation.

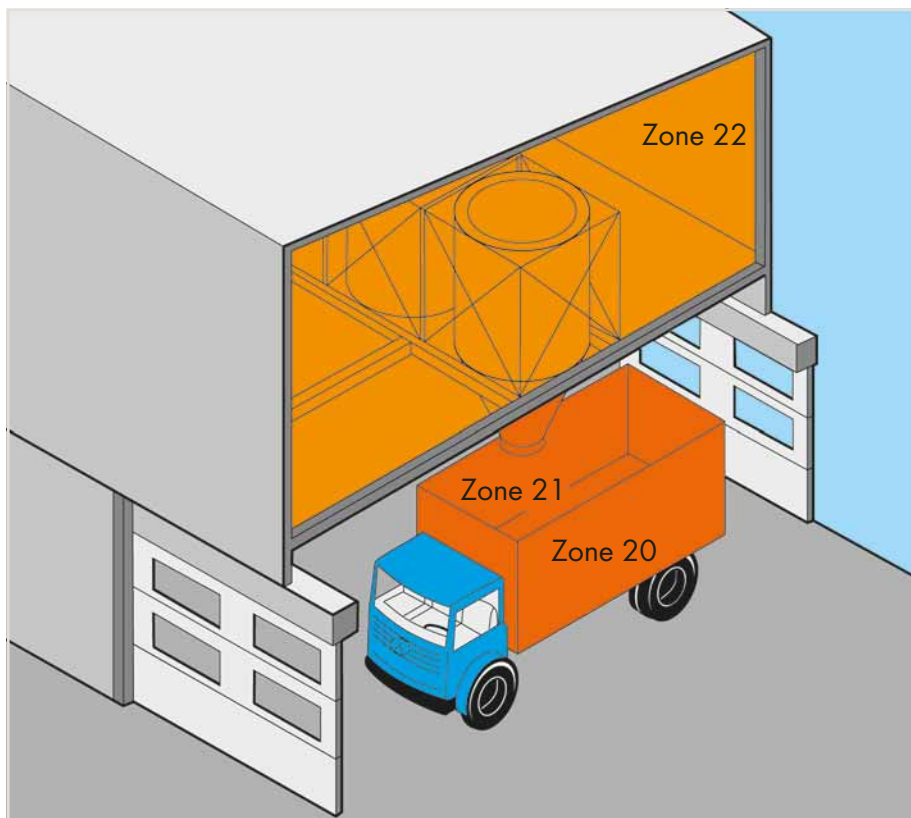

Hazardous areas due to explosive dust/air mixtures:

#### Zone 20:

Areas in which an explosive atmosphere due to dust/air mixtures is present continuously, for long periods or frequently and in which dust deposits of known or excessive thickness may form. Dust deposits alone do not constitute a Zone 20.

#### Zone 21:

Areas in which the occurrence of an explosive atmosphere due to dust/air mixtures is to be expected occasionally and in which deposits or layers of combustible dust can generally be present.

#### Zone 22:

Areas in which an explosive atmosphere due to dust/air mixtures is not likely to occur during normal operation and, if it occurs, will only exist for a short period, or in which accumulations or layers of combustible dust are present.



EN 60079-0 also classifies electrical equipment for use in hazardous areas into two groups:

#### Group I:

Electrical equipment for mines susceptible to firedamp

#### Group II:

Electrical equipment for hazardous areas, except for mines susceptible to fire-damp.

As this broad application range encompasses a large number of potentially flammable gases, Group II is broken down into subgroups IIA, IIB and IIC. This breakdown is based on different gases/materials exhibiting differing ignition power levels as parameters. Therefore, representative gases have been allocated to these three sub-groups:

- IIA – Propane
- IIB – Ethylene
- IIC – Hydrogen

Publication of the WBK Mining Authority dated March 1989.

Quote: "... terminal blocks that have been certified for the type of protection Ex e II will also be accepted, for example, for Group I – equipment with "e" (increased safety) protection type."

This information is also given under Item 12 in the EC Prototype Test Certificates, based on which the terminal blocks have been approved for Group I and Group II.

Temperature Class	Maximum Surface Temperature (°C)
T1	450
T2	300
T3	200
T4	135
T5	100
T6	85

Depending on the maximum surface temperature, electrical equipment in Group II are classified in temperature categories T1 to T6 for all protection types. The ambient temperature, which must be accounted for in dimensioning, is defined as 40 °C/104 °F (deviations are acceptable under some conditions). Terminal blocks for "e" (increased safety) protection type are generally assigned to temperature category T 6. When rail-mount terminal blocks are used in equipment of temperature categories T1 to T5, ensure that the highest temperature on the insulating parts does not exceed 85 °C (185 °F). The highest measured surface temperature rise must not exceed 40 K.

Thermal resistance of the insulation material must be at least 20 °C (68 °F) greater than the highest operating temperature. Low temperature stability is considered to be sufficient when the insulation material can withstand 24-hour storage at a temperature of –60 °C (–76 °F) without nullifying the type of protection.

#### Special Requirements "Increased Safety Ex e"

The European EN 60079-7 Standard – VDE 0170-6 Classification – contains special requirements for the design and testing of electrical equipment with "e" (increased safety) protection type for use in hazardous areas.

This standard is a supplement to EN 60079-0 and applies to equipment or parts thereof that neither generate sparks or arcing under normal operating conditions, nor exhibit hazardous temperatures.

This standard describes special measures, which have to be observed to obtain a safety degree according to the "e" (increased safety) protection type. Ex components such as rail-mount terminal blocks are covered by Section 4.2 "Terminal Blocks for External Conductors."

The following are the most important design requirements for terminal blocks for external supply conductors to electrical equipment:

These must:

- be sufficiently large to permit reliable connection of external supply conductors with cross-section of at least the size required by the nominal current of the equipment
- be protected against self-loosening and designed such that the supply conductors cannot slip out of their clamping units
- be designed such that adequate contact pressure is ensured without damaging the conductors
- be designed such that their contact pressure does not change with temperature cycling
- be equipped with a spring connecting link for the connection of stranded conductors
- be designed so as to allow secure connection of smaller conductors for terminal blocks up to 4 mm<sup>2</sup> (12 AWG).

#### Minimum Ignition Power of Typical Gases:

Explosion Group	I	IIA	IIB	IIC
Gas	Methane	Propane	Ethylene	Hydrogen
Ignition Power	280	250	82	16

The following table shows a comparison between the current practice based on **ExeV, DIN VDE 0165: 1991** and the new **EN 1127-1**:

Device Group II				
Category	Protection degree	Adequate safety for	Comparable to current practice	New, per EN 1127
1: Ex atmosphere is very probable, swirled dust	Highest	Two protective measures Two faults	Group II Zone 0 Zone 10	Zone 0, Zone 20
2: Occasional Ex atmosphere	Increased	Equipment failure or fault	Group II, Zone 1	Zone 1 Zone 21
3: Low probability of Ex atmosphere, settled dust	Normal	Fault-free operation	Group II, Zone 2 Zone 11	Zone 2 Zone 22

## General Technical Information on Electrical Equipment Used in Hazardous Areas (continued)

It is expressly prohibited to use insulating parts for transferring contact forces. Terminal blocks with sharp edges which could damage supply lines and those types that can be rotated, turned or permanently deformed when fixed in place are not permitted for use. Terminal blocks for internal connections in electrical equipment must not be subjected to excessive mechanical stress. These items must fulfill the requirements for terminal blocks used for external supply conductors.

Clearances between conductive parts having different potentials must be at least 3 mm for external connections, as specified in Table 1.

The value of the creepage distances depends on the working voltage, surface geometry of the insulating parts and tracking resistance of the insulation material.

Grooves on the surface may only be considered if they are at least 2.5 mm deep and wide; ribs on the surface only if their height is at least 2.5 mm and their width corresponds to the mechanical strength of the material, however not smaller than 1 mm.

**Table 1: Creepage Distances and Clearances**

Voltage <sup>1)</sup> RMS Value for AC or DC Voltage	Minimum Creepage Distance (in mm)			Minimum Clearance
	Material Group			
V	I	II	III a	mm
10 <sup>2)</sup>	1.6	1.6	1.6	1.6
12.5	1.6	1.6	1.6	1.6
16	1.6	1.6	1.6	1.6
20	1.6	1.6	1.6	1.6
25	1.7	1.7	1.7	1.7
32	1.8	1.8	1.8	1.8
40	1.9	2.4	3	1.9
50	2.1	2.6	3.4	2.1
63	2.1	2.6	3.4	2.1
80	2.2	2.8	3.6	2.2
100	2.4	3	3.8	2.4
125	2.5	3.2	4	2.5
160	3.2	4	5	3.2
200	4	5	6.3	4
250	5	6.3	8	5
320	6.3	8	10	6
400 (440) <sup>1)</sup>	8	10	12.5	6
500 (550) <sup>1)</sup>	10	12.5	16	8
630 (690) <sup>1)</sup>	12	16	20	10
800	16	20	25	12
1000	20	25	32	14
1250	22	26	32	18
1600	23	27	32	20
2000	25	28	32	23
2500	32	36	40	29
3200	40	45	50	36
4000	50	56	63	44
5000	63	71	80	50
6300	80	90	100	60
8000	100	110	125	80
10000	125	140	160	100

<sup>1)</sup> The listed voltages are taken from IEC 60664-1. The working voltage \*) may exceed the voltage indicated in the table by 10 %. This is based on the simplification of the supply voltages in accordance with Table 3b for IEC 60664-1.

The listed values for creepage distances and clearances are based on a maximum limit deviation for supply voltage of  $\pm 10\%$ .

<sup>2)</sup> CTI values are not applicable for voltages of 10 V or less. Materials that do not meet the requirements of material group III a can be used.

Classification of insulation materials according to their tracking resistance is based on their Comparative Tracking Index (CTI) and is defined in Table 2 as follows:

This classification applies to insulating parts without ribs or grooves. If the insulating parts have ribs or grooves sufficiently large to be considered, the minimum creepage distances must be set according to values for the insulation materials in the next-higher level (e.g., Group I, instead of Group II). Accounting for the ambient temperature of 40 °C (104 °F) specified for electrical equipment, the current-carrying capacity of rubber-insulated conductors is reduced to 82 %, based on DIN VDE 0298-4:2013-06, Table 12 and to 87 % for PVC-insulated conductors for the current-carrying capacity defined for 30 °C (86 °F) in accordance with Item 4.3.3 in DIN VDE 0298-4:2013-06.

**Table 2:  
Tracking Resistance for  
Insulation Materials**

Material Group	Comparative Tracking Index
I	$600 \leq \text{CTI}$
II	$400 \leq \text{CTI} < 600$
III a	$175 \leq \text{CTI} < 400$

### Conductor Types and Conductor Preparation

In accordance with EN 60079-14/DIN VDE 0165-1, the ends of stranded and fine-stranded conductors must be protected against splaying (e.g., via cable lugs or ferrules) or by the type of terminal blocks used. Soldering alone is not sufficient.

According to EN 60069-7/DIN VDE 0170-6, connecting electrical equipment to terminal blocks having an "e" (increased safety) protection type must not lead to a reduction of the clearances and creepage distances.

Based on experience through the application of terminal blocks in aggressive atmospheres in the chemical industry, WAGO recommends gas-tight tinned copper ferrules or tinned copper pin terminals when connecting fine-stranded conductors to terminal blocks in corrosive atmospheres.

## Approvals

Terminal blocks may be used in Zones 1 and 2, provided that the terminal blocks are accommodated in an enclosure that has a minimum IP54 protection and an Ex e certification.

Terminal blocks are considered to be Ex components, because they are a part of the equipment. Part certificates provided by Ex Certification Agencies serve as a basis for issuing the complete conformity declaration for the unit.

An EC-type examination certificate is issued in accordance with the 2014/34/EU ATEX Directive.

In addition, an IEXEx Certificate may also be obtained from an appropriate, recognized certification agency in accordance with the IECEx Certification Agreement that is accepted throughout Europe and also in countries such as Canada, China and Australia.

These certificates can also be viewed at: [www.iecex.com](http://www.iecex.com).

## Terminal block marking per 2014/34/EU ATEX Directive:

	⊕	II	2	G	Ex e II
Explosion prevention marking					
Group II (for equipment used in areas in which an explosive atmosphere might occur)					
Category 2 (high safety, equipment used in areas [zones] in which a potentially explosive atmosphere occurs only occasionally. Explosion protection must continue to be provided even in the event of frequent device faults.)					
Gases					
Explosion protection in Europe, "increased safety" protection type, Group II					
or					
	⊕	I	M 2		Ex e I
Explosion prevention marking					
Group I (for equipment used in underground applications)					
Mining applications					
Explosion protection in Europe, "increased safety" protection type, Group I					

## Example of marking (rear):

Series

Manufacturer's name

Nominal isolation voltage

Protection type

Part certification no.

Nominal cross-section

(solid, stranded or fine-stranded conductors)

The embossed details on the terminal blocks show the manufacturer's name, the series no., the type of protection Ex e II, the approval no., the approval data and the name of the testing authority.

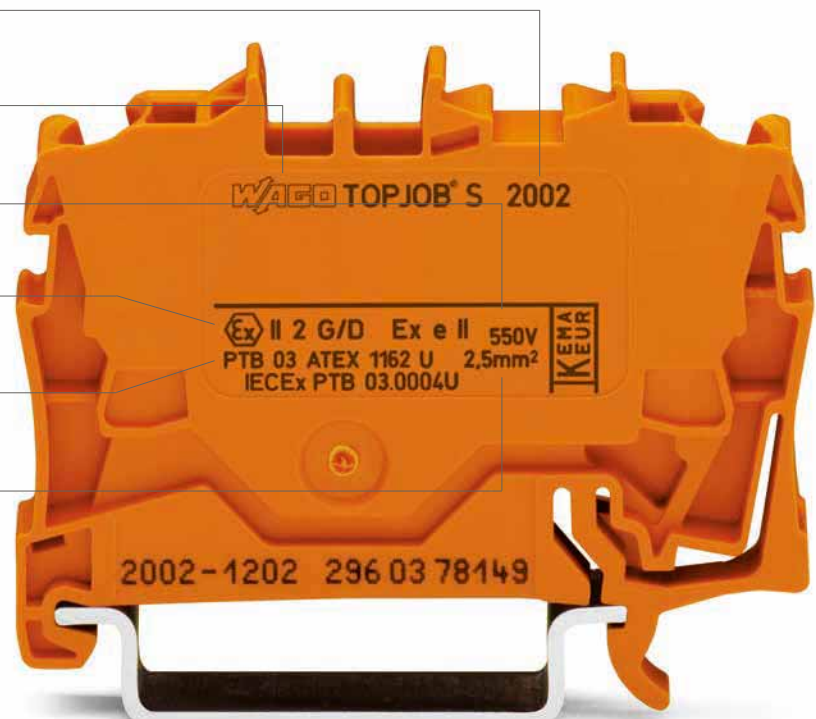

## General Technical Information on Electrical Equipment Used in Hazardous Areas (continued)

Terminal blocks for Class I, Zone 1, Ex e II hazardous locations can be approved for Ex applications per UL 60079-7 standard.

As a result of international harmonization efforts, the UL certificate can be issued on the basis of EN 60079-0 or EN 60079-7 standards, provided that the terminal blocks have also been approved per UL 1059 (ordinary location).

If desired by the applicant, terminal blocks can simultaneously be approved in accordance with the Canadian Standards E79-0-95 and E79-7-95 and released for use in Canada.

The terminal blocks are marked with  Cl. I, Zn. 1, AExI, Zn. 1, AEx e II.

EC-type examination certificates have been granted to all WAGO terminal blocks listed in this catalog. WAGO terminal blocks approved for use in Ex e II areas are manufactured of flame-resistant, self-extinguishing Polyamide 66. The same applies to the terminal blocks used in non-hazardous areas. Tracking resistance with a CTI value of 600 as per IEC 60112 and a constant operating temperature of 105 °C (22 °F) in accordance with IEC 60216-1 and -2 are provided.

Factory part quality tests are performed on all CAGE CLAMP® rail-mount terminal blocks with Ex e II approval to monitor and ensure the quality features described above.

IECEx Certificate of Conformity	
INTERNATIONAL ELECTROTECHNICAL COMMISSION IEC Certification Scheme for Explosive Atmospheres	
for rules and details of the IECEx Scheme visit <a href="http://www.iecex.com">www.iecex.com</a>	
Certificate No.:	IECEx PTB 03.0004U
Status:	Current
Date of Issue:	2003-12-12
Issue No.:	0
Page:	Page 1 of 3
Applicant:	WAGO Kontakttechnik GmbH Hansastraße 27 32423 Minden Germany
Electrical Apparatus:	TOPJOB S, 2002-1... and 2002-1.7 PE & Through terminal blocks
Optional accessory:	
Type of Protection:	Increased Safety
Marking:	Ex e II Tamb: -55 °C to +45 °C
Approved for issue on behalf of the IECEx Certification Body:	Dr.-Ing. Uwe Klausmeyer
Position:	Head of Section "Flameproof Enclosure"
Signature: (for printed version)	
Date:	
1. This certificate and schedule may only be reproduced in full. 2. This certificate is not transferable and remains the property of the issuing body. 3. The Status and authenticity of this certificate may be verified by visiting the Official IECEx Website.	
Certificate issued by: <b>Physikalisch-Technische Bundesanstalt (PTB)</b> Bundesallee 100 38116 Braunschweig Germany	

Physikalisch-Technische Bundesanstalt	
Braunschweig und Berlin	
PTB	
	
<b>EG-Baumusterprüfbescheinigung</b>	
(1)	Geräte und Schutzsysteme zur bestimmungsgemäßen Verwendung in explosionsgefährdeten Bereichen - <b>Richtlinie 94/9/EG</b>
(2)	EG-Baumusterprüfbescheinigungsnummer
(3)	<b>PTB 05 ATEX 1030 U</b>
(4)	Komponente: Durchgangsreihenklammern Typ TOPJOB S Baureihe 2006-12... und 2006-13... Schutzleiterreihenklammern Typ TOPJOB S Baureihe 2006-1207 und 2006-1307
(5)	Hersteller: WAGO Kontakttechnik GmbH
(6)	Anschrift: Hansastraße 27, 32423 Minden, Deutschland
(7)	Die Bauart dieser Komponente sowie die verschiedenen zulässigen Ausführungen sind in der Anlage und den darin aufgeführten Unterlagen zu dieser Baumusterprüfbescheinigung festgelegt.
(8)	Die Physikalisch-Technische Bundesanstalt bescheinigt als benannte Stelle Nr. 0102 nach Artikel 9 der Richtlinie des Rates der Europäischen Gemeinschaften vom 23. März 1994 (94/9/EG) die Erfüllung der grundlegenden Sicherheits- und Gesundheitsanforderungen für die Konzeption und den Bau von Geräten und Schutzsystemen zur bestimmungsgemäßen Verwendung in explosionsgefährdeten Bereichen gemäß Anhang II der Richtlinie.
(9)	Die Ergebnisse der Prüfung sind in dem vertraulichen Prüfbericht PTB Ex 05-15105 festgehalten.
(10)	Die grundlegenden Sicherheits- und Gesundheitsanforderungen werden erfüllt durch Übereinstimmung mit
	<b>EN 60079-0:2004      EN 60079-7:2003      EN 50281-1-1:1998</b>
(11)	Das Zeichen "U" hinter der Zertifikatsnummer gibt an, dass dieses Zertifikat nicht mit einem für ein Gerät oder Schutzsystem vorgesehenen Zertifikat verwechselt werden darf. Diese Teilbescheinigung darf nur als Basis für die Bescheinigung eines Gerätes oder Schutzsystems verwendet werden.
(12)	Diese EG-Baumusterprüfbescheinigung bezieht sich nur auf Konzeption und Prüfung der festgelegten Komponente gemäß Richtlinie 94/9/EG. Weitere Anforderungen dieser Richtlinie gelten für die Herstellung und das Inverkehrbringen dieser Komponente. Diese Anforderungen werden nicht durch diese Bescheinigung abgedeckt.
(13)	Die Kennzeichnung der Komponente muß die folgenden Angaben enthalten:
	 <b>II 2 G Ex e II bzw. IM 2 Ex e I und</b>  <b>II 2 D</b>
	Zertifizierungsstelle Explosionsschutz      Braunschweig, 30. Mai 2005
	Dr.-Ing. U. Klausmeyer Direktor und Professor
	
	Seite 1/3
<small>EG-Baumusterprüfbescheinigungen ohne Unterschrift und ohne Siegel haben keine Gültigkeit.            Diese EG-Baumusterprüfbescheinigung darf nur unverändert weiterverbreitet werden.            Auszüge oder Änderungen bedürfen der Genehmigung der Physikalisch-Technischen Bundesanstalt.            Physikalisch-Technische Bundesanstalt • Bundesallee 100 • D-38116 Braunschweig</small>	

### Classifications per NEC 500

The following classifications, as defined in article 500 of the National Electric Code (NEC), are valid for North America.

### Divisions

Divisions describe the degree of probability for a dangerous situation occurring. The following assignments apply:

Hazardous Areas due to Flammable Gases, Vapors, Mists or Dusts	
Division 1	Areas in which an explosive atmosphere is likely to occur occasionally ( $> 10 \text{ h} \leq 1000 \text{ h/year}$ ), as well as continuously or long-term ( $> 1000 \text{ h/year}$ ).
Division 2	Areas in which an explosive atmosphere is likely to occur rarely or only for a short period ( $> 1 \text{ h} \leq 1 \text{ h/year}$ ).

### Explosion Protection Groups

Electrical components for explosive areas are subdivided in three danger categories:

Class I (gases and fumes)	Group A	(Acetylene)
	Group B	(Hydrogen)
	Group C	(Ethylene)
	Group D	(Methane)
Class II (dust)	Group E	(Metal dust)
	Group F	(Coal dust)
	Group G	(Flour, starch and cereal dusts)
Class III (fibers)	No subgroups	

### Temperature Classes

Electrical components for hazardous areas are differentiated by temperature classes:

Temperature Class	Maximum Surface Temperature	Ignition Temperature of Combustible Materials
T1	450 °C	$> 450 \text{ °C}$
T2	300 °C	$> 300 \text{ °C} \leq 450 \text{ °C}$
T2A	280 °C	$> 280 \text{ °C} \leq 300 \text{ °C}$
T2B	260 °C	$> 260 \text{ °C} \leq 280 \text{ °C}$
T2C	230 °C	$> 230 \text{ °C} \leq 260 \text{ °C}$
T2D	215 °C	$> 215 \text{ °C} \leq 230 \text{ °C}$
T3	200 °C	$> 200 \text{ °C} \leq 215 \text{ °C}$
T3A	180 °C	$> 180 \text{ °C} \leq 200 \text{ °C}$
T3B	165 °C	$> 165 \text{ °C} \leq 180 \text{ °C}$
T3C	160 °C	$> 160 \text{ °C} \leq 165 \text{ °C}$
T4	135 °C	$> 135 \text{ °C} \leq 160 \text{ °C}$
T4A	120 °C	$> 120 \text{ °C} \leq 135 \text{ °C}$
T5	100 °C	$> 100 \text{ °C} \leq 120 \text{ °C}$
T6	85 °C	$> 85 \text{ °C} \leq 100 \text{ °C}$

# General Technical Information on Electrical Equipment Used in Hazardous Areas (continued)

For America  
Per NEC 500

Side Marking I/O Modules  
(e.g., 750-400, 2-Channel Digital Input Module, 24 VDC):

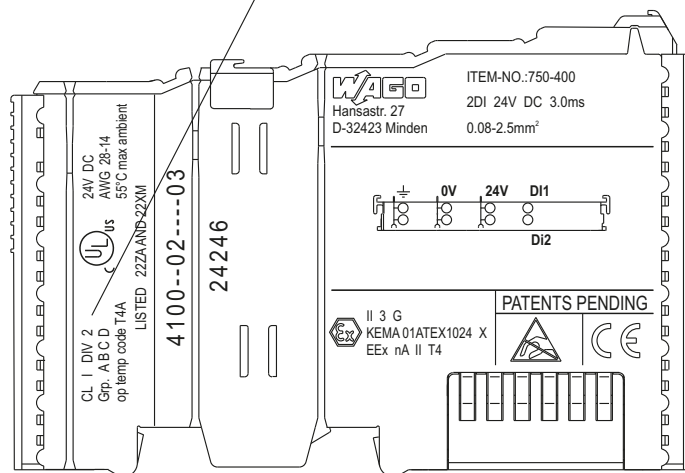
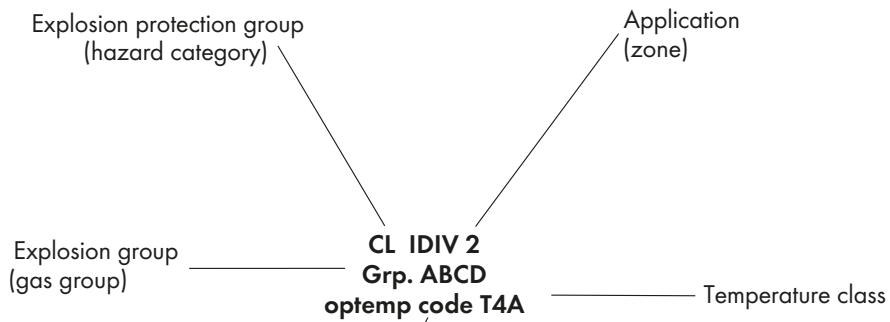



### Special Requirements "Intrinsic safety Ex i"

The European EN 60079-11 Standard – DIN EN 60079-11 Classification (VDE 0170-7) – contains special requirements for the design and testing of electrical equipment with "i" (intrinsic safety) protection type for use in hazardous areas.

A circuit is "intrinsically safe" when, under normal operating conditions and in the event of specific fault conditions, no sparks or thermal effects can occur and cause the ignition of a certain explosive atmosphere.

A distinction is made here between:

- intrinsically safe electrical equipment when all circuits are intrinsically safe and
- associated electrical equipment including both intrinsically and non-intrinsically safe circuits, and being designed such that the non-intrinsically safe circuits cannot affect the intrinsically safe ones.

Intrinsically safe electrical equipment and intrinsically safe parts of associated electrical equipment are classified at "ia" or "ib" protection level.

Electrical equipment classified Ex "ia" must not ignite when current is applied in the following cases:

- a) During fault-free operation, with those non-discreet faults present that result in the most adverse condition;
- b) During fault-free operation and with a discreet fault, plus those non-discreet faults that result in unfavorable conditions;
- c) During fault-free operation with two discreet faults, plus those non-discreet faults that result in the most adverse conditions.

Electrical equipment classified Ex "ib" must not ignite when current is applied in the following cases:

- a) During fault-free operation, with those non-discreet faults present that result in the most adverse condition;
- b) During fault-free operation and with a discreet fault, plus those non-discreet faults that result in unfavorable conditions.

No special approval is required for terminal blocks used as simple electrical equipment for "Ex i" protection type, as they do not contain a voltage source and precise information is available concerning electrical data and temperature rise performance.

The terminal blocks must be identifiable, for example by their type designation, and the following design requirements must also be upheld:

- The clearance between bare, conducting parts of terminal blocks of different intrinsically safe circuits has to be equal or higher than the values specified in the standard. In addition, clearances between the terminal blocks must be so that the clearances between the bare, conductive parts of the connected external conductors is at least 6 mm when measured. Each possible motion of metallic parts that are not rigidly secured must be considered.
- When a possible connection has not been considered during safety analysis, the minimum clearance between grounded metallic or other conducting parts and the uninsulated conducting parts of the conductors that are connected to the terminal blocks must be 3 mm.
- Terminal block marking must be unique and clearly visible. If a color is used for this, the color must be light blue (similar to RAL 5015).

Note also when using terminal blocks: Terminal blocks used for intrinsically safe circuits must be isolated from those used in non-intrinsically safe circuits. This is accomplished by several accepted methods. First, intrinsically safe circuits are separated by at least 50 mm of air space from non-intrinsically safe circuits.

Second, intrinsically safe circuits are housed in a separate enclosure. Third, intrinsically safe terminal blocks are separated from non-intrinsically safe terminal blocks by either an insulated partition or grounded metal partition. The partition size must allow for either 1.5 mm or less distance from the sides of the housing or provide at least 50 mm of creepage distance between the intrinsically and non-intrinsically safe circuits in all directions.

The insulation between an intrinsically safe circuit and the chassis of an electrical equipment or parts, which may be grounded, has to withstand an effective AC voltage corresponding to double the value of the voltage of the intrinsically safe circuit or a minimum of at least 500 V, depending on which value is higher.

The insulation between an intrinsically safe and a non-intrinsically safe circuit has to withstand an effective AC voltage of  $2 \times \text{nominal value (U)} + 1000 \text{ V}$  or a minimum of 1500 kV, whereby U represents the total of the effective voltages of the intrinsically safe and the non-intrinsically safe circuit.

Short circuit between different intrinsically safe circuits could cause dangerous conditions. The insulation between these circuits should withstand an effective voltage of at least 500 VAC or 2 UAC where U is the total of the effective voltages of the related circuits.

In accordance with EN 60079-14/ DIN VDE 0165-1, in intrinsically safe circuits, the ends of stranded and fine-stranded conductors must be protected against splaying (e.g., via cable lugs or ferrules) or by the type of terminal blocks used. Soldering alone is not sufficient.

WAGO recommends gas-tight tinned copper ferrules or tinned copper pin terminals when connecting fine-stranded conductors to terminal blocks in corrosive atmospheres.

## General Technical Information on Electrical Equipment Used in Hazardous Areas (continued)

### IECEx and ATEX 100a Approvals



IEC scheme for certification to standards for safety of equipment for use in explosive atmospheres (iecex scheme):

**IECEx Scheme Online Certificate of Conformity**

View by Certificates: (All)

Previous Page | Next Page | First Page | Last Page | Expand | Collapse  
(Year Selection: All | 2003 | 2004)

Year	Certificate Reference Number	Status	Manufacturer country	Manufacturer name	Protection type	Tested Standard	Apparatus
2003	IECEX TUN 03.0000	Current	Germany	Pepperl + Fuchs GmbH	Intrinsic safety	IEC 60079-0 (Ed.3.1) ...	Intepute Evaluat...
	IECEX SR 03.0001	Current	United Kingdom	Deaeger PLMS Ltd	Intrinsic Safety	IEC 60079-0 (Ed.3.1) ...	Open Path Gas D...
	IECEX SR 03.0000	Current	United Kingdom	Deaeger PLMS Ltd	Intrinsic Safety, Pt...	IEC 60079-0 (Ed.3.1) ...	Open Path Gas D...
	IECEX SM 03.0003X	Current	Australia	CSE Ex Pty Ltd	Flameproof, Dust Ign...	IEC 60079-0 (Ed.3.1) ...	F3 Series Ex of...
	IECEX SM 03.0002X	Current	Australia	CSE Ex Pty Ltd	Flameproof, Dust Ign...	IEC 60079-0 (Ed.3.1) ...	F2 Series Ex of...
	IECEX SM 03.0001U	Current	Australia	CSE Ex Pty Ltd	Flameproof, Dust Ign...	IEC 60079-0 (Ed.3.1) ...	FCM1, FCM2, F...
	IECEX PTB 03.0004U	Current	Germany	WAGO Kontakttechnik	Increased Safety	IEC 60079-0 (Ed.3.1) ...	TOPJOB S, 2002...
	IECEX PTB 03.0003	Current	Germany	Pepperl + Fuchs GmbH	General requirements	IEC 60079-0 (Ed.3.1) ...	Field bus barr...
	IECEX PTB 03.0000	Current	Germany	CEAG-Sicherheitsste...	Increased Safety	IEC 60079-0 (Ed.3.1) ...	Blanking Element
	IECEX ITS 03.0008	Current	United Kingdom	Etron Chromatex	Flameproof Enclosure	IEC 60079-0 (Ed.3.1) ...	Attkoordenable...
	IECEX ITS 03.0007S	Current	United Kingdom	Etron Chromatex	Flameproof Enclosure	IEC 60079-0 (Ed.3.1) ...	Attkoordenable...

**TOPJOB® S Rail-Mount Terminal Blocks**  
The IECEx certificate awarded to WAGO for the TOPJOB® S Rail-Mount Terminal Blocks (Approval No. IECEx PTB 03.0004U), which first debuted at the Hannover Fair 2003, is one of the first ten certificates that have been issued worldwide so far. It is the fourth certificate of this type (Reference No. ...0004U) that has been published online by the German certification body PTB in Braunschweig (publication dated December 15, 2003). These rail-mount terminal blocks are also certified for use in Ex e applications per ATEX 100 a. Both approvals are available for all through terminal blocks, as well as ground conductor terminal blocks.























They provide major cost savings and simplicity to WAGO customers:









- Double inventories are no longer necessary for standard and Ex e rail-mount terminal blocks.
- The time-, cost- and space-saving features of the system can automatically apply to Ex e applications.
- Project planning is essentially performed using a single range of rail-mount terminal blocks.
- Enhanced plant safety: Standard terminal blocks cannot be accidentally used in Ex e areas.
- The IECEx certificate is valid for the international trade of Ex equipment.

Other WAGO products with IECEx approval are available upon request.



## International Certification Organizations – Overview

		Abbreviation			Abbreviation
	Underwriters Laboratories USA <a href="http://www.ul.com">http://www.ul.com</a>	UL		Danmarks Elektriske Materiel- kontrol Denmark <a href="http://www.demko.dk">http://www.demko.dk</a>	DEMKO
	Underwriters Laboratories USA <a href="http://www.ul.com">http://www.ul.com</a>	UL		CENELEC CERTIFICATION AGREEMENT Danmarks Elektriske Materiel- kontrol Denmark <a href="http://www.cenelec.org">http://www.cenelec.org</a>	CCA Appr. No. with NL
Y	Underwriters Laboratories USA <a href="http://www.ul.com">http://www.ul.com</a>	cURus			
	Underwriters Laboratories USA <a href="http://www.ul.com">http://www.ul.com</a>	cULus		SETI – FEMKO Sähkötarkastuskeskus Elin- spektionscentralen Finland <a href="http://www.seti.fi">http://www.seti.fi</a>	
	Canadian Standards Associa- tion Canada <a href="http://www.csa.ca">http://www.csa.ca</a>	CSA		Sähkötarkastuskeskus Elin- spektionscentralen Finland <a href="http://www.fimko.com">http://www.fimko.com</a>	FIMKO
	VDE-Gutachten mit Ferti- gungsüberwachung Germany <a href="http://www.vde.de/vde/html/e/home.htm">http://www.vde.de/vde/html/e/home.htm</a>	VDE	<b>SABS</b>	South African Bureau of Stan- dards South Africa <a href="http://www.sabs.co.za">http://www.sabs.co.za</a>	SABS
	VDE – Deutscher Verband für Elektrotechnik Germany <a href="http://www.vde.de">http://www.vde.de</a>			RosTesT Russia <a href="http://www.rostest.ru">http://www.rostest.ru</a>	ROTEST
VDE	VDE – Prüfbericht Germany			Departamentul Moldovastan- dard Moldova <a href="http://www.moldova.md/ro/government/ol/D_STAND/en/strcent2.htm">http://www.moldova.md/ro/government/ol/D_STAND/en/strcent2.htm</a>	CSM
	Österreichischer Verband für Elektrotechnik Austria <a href="http://www.ove.at">http://www.ove.at</a>	ÖVE		Certificate of Registration Great Britain <a href="http://www.astacertification.com">http://www.astacertification.com</a>	ASTA
	Schweizerischer Elektrotech- nischer Verein Switzerland <a href="http://www.sev.ch/">http://www.sev.ch/</a>	SEV		Rheinisch-Westfälischer Tech- nischer Überwachungsverein e.V. Germany <a href="http://www.rwtuv.de">http://www.rwtuv.de</a>	RWTÜv
	N.V. tot Keuring van Elektro- technische Materialen Netherlands <a href="http://www.kema.nl">http://www.kema.nl</a>	KEMA		Elektrotechnický ústav a projektový ústav Czech Republic <a href="http://www.ezu.cz">http://www.ezu.cz</a>	EZU
CCA	CENELEC CERTIFICATION AGREEMENT N.V. tot Keuring van Elektro- technische Materialen Netherlands <a href="http://www.cenelec.org">http://www.cenelec.org</a>	CCA Appr. No. with NL		Stowarzyszenie Elektryków Polskich Poland <a href="http://www.sep.com.pl">http://www.sep.com.pl</a>	BBJ
	Norges Elektriske Materialkon- troll Norway <a href="http://express.nemko.com">http://express.nemko.com</a>	NEMKO		Stowarzyszenie Elektryków Polskich Poland <a href="http://www.bbj.pl">http://www.bbj.pl</a>	SEP
	Svenska Elektriska Materiel- kontrollanstalten AB Sweden <a href="http://www.semko.com">http://www.semko.com</a>	SEMKO			

	Abbreviation		Abbreviation	
<b>CNET</b>	Centre National d'Etudes des Télécommunications France <a href="http://www.lannion.cnet.fr">http://www.lannion.cnet.fr</a>	<b>CNET</b>	 Robbanásbiztos Villamos Berendezések Hungary <a href="http://www.bki.hu">http://www.bki.hu</a>	<b>BKI</b>
<b>LCIE</b>	Laboratoire Central des Industries Electriques France <a href="http://www.lcie.fr">http://www.lcie.fr</a>	<b>LCIE</b>	<b>CB</b>	<b>CB</b>
	Fyzikálne Technické Ústav, Ostrava-Radvanice Czech Republic <a href="http://www.ftzu.cz">http://www.ftzu.cz</a>	<b>FTZU</b>	<b>CB</b>	<b>CB</b>
				<b>ENEC</b>
			<b>UL-International Demko A/S</b> Denmark <a href="http://www.ul-europe.com">http://www.ul-europe.com</a>	
<b>Marine Approvals</b>			<b>Ex Approvals</b>	
Germanischer Lloyd Germany <a href="http://www.gl-group.com">http://www.gl-group.com</a>	<b>GL</b>		Physikalisch Technische Bundesanstalt Germany Ex e II <a href="http://www.ptb.de">http://www.ptb.de</a>	<b>PTB</b>
Bureau Veritas France <a href="http://www.bureauveritas.fr">http://www.bureauveritas.fr</a>	<b>BV</b>			
Lloyd's Register of Shipping Great Britain <a href="http://www.lloydsregister.com">http://www.lloydsregister.com</a>	<b>LR</b>		Underwriters Laboratories USA <a href="http://www.ul.com">http://www.ul.com</a>	<b>cURus-EX</b>
NV – Det Norske Veritas Norway <a href="http://www.dnv.com">http://www.dnv.com</a>	<b>DNV</b>		N.V. tot Keuring van Elektrotechnische Materialen Netherlands <a href="http://www.kemaquality.com">http://www.kemaquality.com</a>	<b>KEMA-EX</b>
Russian Maritime Register of Shipping GUS <a href="http://www.rs-head.spb.ru">http://www.rs-head.spb.ru</a>	<b>RMR</b>		<b>GOSENERGO-Ex</b> <b>GOSENERGONADZOR</b> Russia	<b>GOSENERGO-EX</b>
Polski Rejestr Statków Poland <a href="http://www.prs.pl">http://www.prs.pl</a>	<b>PRS</b>		Fyzikálne Technické Ústav, Ostrava-Radvanice Czech Republic <a href="http://www.ftzu.cz">http://www.ftzu.cz</a>	<b>FTZU</b>
Korean Register of Shipping Korea <a href="http://www.krs.co.kr">http://www.krs.co.kr</a>	<b>KR</b>		Robbanásbiztos Villamos Berendezések Hungary <a href="http://www.bki.hu">http://www.bki.hu</a>	<b>BKI-Ex</b>
American Bureau of Shipping USA <a href="http://www.eagle.org">http://www.eagle.org</a>	<b>ABS</b>			



## Index and Addresses



## Indexes Addresses

	Page
Product Index	856
Item Number Index	860
WAGO Worldwide	876



Item	Page	Item	Page	Item	Page
<b>M</b>					
Male connectors					
– X-COM®-SYSTEM	509				
Marking accessories	Section 13, Volume 6				
Material specifications for insulation/contact materials, contact plating	836				
Matrix patchboards	684				
Matrix patching and common potential terminal blocks (4- and 8-level terminal blocks)	700				
MICRO PUSH WIRE® connectors for junction boxes	742				
Miniature ground terminal blocks, f.-e.					
– for DIN-15 and DIN-35 rails	543				
Mini through terminal blocks, f.-e.					
– for DIN-15 and DIN-35 rails	542				
Modular test plug adapters					
– see "Test plug adapters"					
Modular terminal blocks and terminal strips					
– see "Terminal blocks and terminal strips"					
Modular terminal blocks and terminal strips with mounting flanges or snap-in mounting feet	582				
– f.-e.	590				
– s.-e.	602				
Mounting carrier for splicing connectors					
– 221 Series	754				
– 222 Series	754				
– 243 Series	745				
– 273 Series	727				
– 773 Series	733				
– 2273 Series	723				
Mounting foot					
– for isolated mounting on DIN-rails	785				
– for busbars	772				
Multilevel installation terminal blocks					
– TOPJOB® S	234				
Multilevel rail-mount terminal blocks					
– see "Double-, triple-, quadruple-deck terminal blocks"					
Multilevel terminal blocks					
– see "Multilevel installation terminal blocks"					
– see "Double-, triple- and quadruple-deck terminal blocks"					
<b>N</b>					
N-conductor disconnect terminal blocks					
– TOPJOB®, Classic	340				
– TOPJOB® S	242				
Neon lamp modules	436				
<b>O</b>					
Operating stickers					
– see www.wago.com					
Operating tools	792				
– TOPJOB® S	252				
– TOPJOB®, Classic	462				
– High-current, rail-mount terminal blocks	275				
Order form available upon request					
<b>P</b>					
Pin modules for rail-mount terminal blocks for Wire-Wrap or Termini-Point connections	708				
Pluggable connectors					
– TOPJOB® S	156				
– X-COM®S-SYSTEM	Section 2				
– X-COM®-SYSTEM	Section 6				
Pluggable tap-off modules	567				
Push-in type wire jumpers for rail-mount terminal blocks	438				
– TOPJOB® S	160				
PUSH WIRE® connection	3				
POWER CAGE CLAMP connection	3				
Power distribution disconnect terminal blocks					
– TOPJOB® S	242				
– TOPJOB®, Classic	341				
POWER CAGE CLAMP connection	Section 4				
PUSH WIRE® connection	3				
PUSH WIRE® connectors for junction boxes					
	Section 12				
PUSH WIRE® connectors for junction boxes, Ex e II	736				
<b>P</b>					
PUSH WIRE® connectors for junction boxes, CLAS-SIC	726				
PUSH WIRE® connectors for junction boxes, COM-PACT	720				
PUSH WIRE® connectors for junction boxes, MICRO	742				
Push-in CAGE CLAMP® connection	3				
<b>Q</b>					
Quadruple-deck rail-mount terminal blocks (for fast electric motor wiring)	328				
– TOPJOB® S	78				
<b>R</b>					
Rail end cap for DIN-35 rail	786				
Rail-mount spacer blocks	441				
Patchboard systems					
– Matrix patchboards	684				
– Common potential matrix patchboards	688				
– Matrix patching and common potential terminal blocks (4- and 8-level terminal blocks)	700				
– Terminal blocks for matrix patching (3-conductor, double-potential terminal blocks)	707				
<b>S</b>					
Sales regions					
– in Germany and worldwide	880				
Screwdrivers					
– see "Operating tools"					
Sensor and sensor LED terminal blocks					
– Rail-mount terminal blocks, TOPJOB® S	126				
– Rail-mount terminal blocks, Classic	396				
– Rail-mount terminal blocks	572				
"Service" connectors	759				
Shield clamping saddles	767				
Shield clamps	770				
Shield terminal blocks					
– angled type	295				
– TOPJOB®, Classic	333				
– TOPJOB® S	47				
– horizontal type	289				
– TOPJOB® S	40				
– Double- and triple-deck terminal blocks	59				
– Triple-deck terminal blocks	327				
– TOPJOB® S	77				
Spacers for sensor/actuator terminal blocks	399				
Specifications UL – Underwriters Laboratories, USA	830				
Splicing connectors, COMPACT, for all conductor types	749				
Splicing connectors, CLASSIC, for all conductor types	753				
Spring-equipped shield clamping saddles	769				
Staggered jumpers for rail-mount terminal blocks					
– TOPJOB® S	440				
Star point jumper	164				
Step-down jumpers for through terminal blocks	160				
– TOPJOB® S	162				
– High-current, 35 mm <sup>2</sup>	274				
– f.-e.	438				
– s.-e.	670				
Strain relief housings					
– X-COM®-SYSTEM	524				
Strain relief plates					
– X-COM®S-SYSTEM	227				
– X-COM®-SYSTEM	532				
– for 294 Series	645				
Subsidiaries and representatives					
– in Germany and worldwide	880				
Supply terminal blocks					
– Ground conductor terminal block					
– TOPJOB® S	243				
– TOPJOB®, Classic	332				
– N-conductor disconnect terminal blocks					
– TOPJOB® S	243				
– TOPJOB®, Classic	343				
<b>T</b>					
Tap-off modules	567				
Technical information					
– general	808				
– hazardous areas	840				
– miniature fuses	388				
Terminal blocks for matrix patching (3-conductor, double-potential terminal blocks)	707				
Terminal strips and modular terminal blocks with mounting flanges or snap-in mounting feet	582				
– f.-e.	590				
– s.-e.	602				
Terminating aluminum conductors	835				
Test and disconnect terminal blocks					
– see "Disconnect and test terminal blocks"					
Tests and testing procedures	Section 14				
Testboy	803				
Test pin	227				
Test plug adapters					
– TOPJOB® S	175				
Test plug modules	444				
– TOPJOB® S	157				
– with CAGE CLAMP® connection	444				
– Mini rail-mount terminal blocks	546				
– with Push-in CAGE CLAMP® connection	156				
Through terminal blocks, f.-e.					
– angled type	294				
– TOPJOB® S	46				
– TOPJOB®, Classic	332				
– for transformer circuits	356				
– TOPJOB® S	114				
– for fuse terminal blocks for mini-automotive, blade-style fuses	372				
– horizontal type	286				
– TOPJOB® S	34				
– 5 mm wide; 4 mm <sup>2</sup>	296				
– Double- and triple-deck terminal blocks	314				
– TOPJOB® S	58				
– Distribution terminal blocks	311				
– TOPJOB® S	244				
Through terminal blocks, Mini					
– for DIN-15 and DIN-35 rails	542				
Through terminal blocks, s.-e.	654				
– High-current~	258				
Tools	Section 13				
TOPJOB® terminal blocks with CAGE CLAMP® connection					
– Through terminal blocks	332				
– Shield terminal blocks	333				
– Ground conductor terminal blocks	333				
– Tools	462				
– N-conductor disconnect terminal blocks	340				
– Power distribution disconnect terminal blocks	341				
TOPJOB® S terminal blocks with Push-in CAGE CLAMP® connection					
– Carrier terminal blocks	83				
– Through terminal blocks	34				
– Double-potential terminal blocks	35				
– Ground conductor terminal blocks	36				
– Shield terminal blocks	40				
– Double-deck terminal blocks	58				
– Triple-deck terminal blocks	76				
– Quadruple-deck terminal blocks	78				
– Double-deck disconnect/test terminal blocks	80				
– Disconnect and test terminal blocks	82				
– Fuse terminal blocks	88				
– Fuse disconnect terminal blocks with a pivoting fuse holder	90				
– Ground conductor disconnect terminal blocks	101				
– Terminal block assemblies for transformer circuits	116				
– Fuse plugs	121				
– Sensor terminal blocks	126				
– Actuator terminal blocks	130				
– Diode and LED terminal blocks	132				
– Diode modules, pluggable	148				
– Pluggable connectors	156				
– Test plug modules	157				
– Multilevel installation terminal blocks with an N-disconnect slide link	234				
– Multilevel installation terminal blocks with an internal N-disconnection	236				
– N-conductor disconnect terminal blocks	242				

## Product Index

Item	Page	Item	Page	Item	Page
<b>T</b>					
TOPJOB® S terminal blocks with Push-in CAGE CLAMP® connection					
– Power distribution disconnect terminal blocks	242				
– Distribution supply terminal blocks	244				
Transformer terminal blocks					
– see “Disconnect and test terminal blocks”					
Transverse switching terminal blocks	364				
Triple-deck installation terminal blocks, TOPJOB® S	234				
Triple-deck rail-mount terminal blocks, f.-e.	326				
– TOPJOB® S	76				
– Diode and LED terminal blocks	562				
– TOPJOB® S	142				
<b>U</b>					
UL Specifications – Underwriters Laboratories, USA	830				
<b>V</b>					
Variable resistor terminal blocks, f.-e.	425				
Vario-T-BOXX	755				
Voltage testers	802				
<b>W</b>					
WAGO					
– worldwide	864				
– in Germany	866				
WAGO CAGE CLAMP® connection	2				
WAGO POWER CAGE CLAMP connection	3				
WAGO Push-in CAGE CLAMP® connection	3				
WAGO PUSH WIRE® connection	3				
WFB continuous marking strips	783				
Wire harness support	705				
Wire jumpers for rail-mount terminal blocks, push-in type	438				
– TOPJOB® S	160				
Wire strippers	796				
<b>X</b>					
X-COM®S-SYSTEM					
– Carrier terminal blocks	198				
– Double-deck carrier terminal blocks	202				
– Female plugs with Push-in CAGE CLAMP® connection	207				
X-COM®S-SYSTEM-MINI					
– Carrier terminal blocks	180				
– Double-deck carrier terminal blocks	184				
– Female plugs with Push-in CAGE CLAMP® connection	189				
X-COM®-SYSTEM					
– Carrier terminal blocks	470				
– Double-deck carrier terminal blocks	498				
– Female plugs with CAGE CLAMP® connection	519				
– Male connectors with CAGE CLAMP® connection	509				
– Male headers with solder pins	513				

Item	Page	Item	Page	Item	Page

## Item Number Index

Item No.	Page	Item No.	Page	Item No.	Page	Item No.	Page
<b>206 Series</b>		<b>210 Series</b>		<b>216 Series</b>		<b>243 Series</b>	
206-118	797	210-113	786	216-123	798	243-110	745
206-124	796	210-114	786	216-124	798	243-112	745
206-125	796	210-115	786	216-131	798	243-113	745
206-126	796	210-118	786	216-132	798	243-144	744
206-127	796	210-123	175	216-141	635		
206-128	796	210-133	771	216-142	635	243-204	743
206-170	795	210-136	804	216-143	635	243-208	743
206-171	795	210-137	804	216-144	635		
206-173	795	210-141	793	216-151	798	243-304	743
206-174	795	210-143	793	216-152	798	243-308	743
		210-148	786				
206-204	797	210-149	786	216-201	798	243-504	743
206-216	797	210-154	587	216-202	798	243-508	743
206-225	800	210-196	786	216-203	798		
206-250	800	210-197	786	216-204	798	243-804	743
206-294	645	210-198	786	216-205	798	243-808	743
				216-206	798		
206-706	802	210-254	119	216-207	798	<b>248 Series</b>	
206-707	802	210-281	252	216-208	798	248-501	781
		210-295	791	216-209	798	248-501/000-002	781
206-804	803	210-296	791	216-210	798	248-501/000-005	781
206-808	802	210-297	461	216-221	798	248-501/000-006	781
206-810	803			216-222	798	248-501/000-007	781
206-816	803	210-334	723	216-223	798	248-501/000-012	781
				216-224	798	248-501/000-017	781
<b>209 Series</b>		210-412	356	216-241	799	248-501/000-023	781
209-100	790	210-413	356	216-242	799	248-501/000-024	781
209-105	252	210-414	356	216-243	799		
209-106	785	210-415	356	216-244	799	<b>249 Series</b>	
209-107	451	210-423	364	216-246	799	249-101	791
209-108	451	210-424	364	216-262	799	249-106	445
209-109	786	210-490	532	216-263	799	249-107	445
209-120	625			216-264	799	249-109	709
209-122	625	210-504	786	216-266	799	249-116	785
209-123	625	210-505	786	216-267	799	249-117	785
209-129	793	210-506	786	216-284	799	249-125	438
209-130	793	210-508	786	216-286	799	249-126	438
209-132	622	210-549	789	216-287	799	249-127	438
209-137	509			216-288	799	249-130	723
209-144	361	210-612	783	216-289	799	249-135	622
209-170	460	210-647	792			249-136	623
209-173	524	210-648	792	216-301	798	249-137	624
209-174	524	210-657	793	216-302	798	249-138	622
209-185	783	210-658	793	216-321	798	249-139	623
209-190	161			216-322	798	249-140	624
209-191	161	210-719	792			249-141	444
209-192	168	210-720	792	216-413	801	249-142	445
209-196	789	210-721	792	216-414	801	249-143	445
		210-722	792	216-424	801	249-144	450
209-500/209-035	783			216-425	801	249-145	450
209-501	782	<b>215 Series</b>		216-435	801	249-146	450
209-501/000-002	782	215-111	804			249-147	451
209-501/000-005	782			216-545	385	249-148	451
209-501/000-006	782	215-211	804	216-546	385	249-197	785
209-501/000-007	782	215-212	804	216-547	385		
209-501/000-012	782					<b>260 Series</b>	
209-501/000-017	782	215-311	804	<b>221 Series</b>		260-102	602
209-501/000-023	782			221-412	749	260-103	602
209-501/000-024	782	215-411	804	221-413	749	260-104	602
209-502	782			221-415	749	260-105	602
209-566	782	215-511	804			260-106	602
				221-500	754	260-107	602
209-700/209-124	782	215-611	804			260-108	602
209-700/209-125	782			<b>222 Series</b>		260-109	602
209-700/209-126	782	215-711	804	222-412	753	260-110	602
209-700/209-127	782			222-413	753	260-111	602
209-701	782	215-811	804	222-415	753	260-112	602
209-701/000-002	782					260-152	602
209-701/000-005	782	215-911	804	222-500	754	260-153	602
209-701/000-006	782			222-505	754	260-154	602
209-701/000-007	782	<b>216 Series</b>		222-510	754	260-155	602
209-701/000-012	782	216-101	798			260-156	602
209-701/000-017	782	216-102	798	<b>224 Series</b>		260-157	602
209-701/000-023	782	216-103	798	224-101	758	260-158	602
209-701/000-024	782	216-104	798	224-104	758	260-159	602
209-787	782	216-106	798	224-112	759	260-160	602
		216-107	798	224-114	759	260-161	602
		216-108	798			260-162	602
<b>210 Series</b>		216-109	798	224-201	759		
210-103	175	216-110	798			260-202	603
210-110	745	216-111	798			260-203	603
210-111	791	216-121	798				
210-112	786	216-122	798				



Item No.	Page	Item No.	Page	Item No.	Page	Item No.	Page
<b>260 Series</b>		<b>261 Series</b>		<b>261 Series</b>		<b>261 Series</b>	
260-204	603	261-109/341-000	614	261-253/342-000	615	261-334/342-000	613
260-205	603	261-110	606	261-254	607	261-336	605
260-206	603	261-110/331-000	610	261-254/332-000	611	261-336/332-000	609
260-207	603	261-110/341-000	614	261-254/342-000	615	261-336/342-000	613
260-208	603	261-111	606	261-255	607	261-337	605
260-209	603	261-111/331-000	610	261-255/332-000	611	261-337/332-000	609
260-210	603	261-111/341-000	614	261-255/342-000	615	261-337/342-000	613
260-211	603	261-112	606	261-256	607	261-341	605
260-212	603	261-112/331-000	610	261-256/332-000	611	261-341/332-000	609
260-252	603	261-112/341-000	614	261-256/342-000	615	261-341/342-000	613
260-253	603	261-152	606	261-257	607	261-343	605
260-254	603	261-152/331-000	610	261-257/332-000	611	261-343/332-000	609
260-255	603	261-152/341-000	614	261-257/342-000	615	261-343/342-000	613
260-256	603	261-153	606	261-258	607	261-344	605
260-257	603	261-153/331-000	610	261-258/332-000	611	261-344/332-000	609
260-258	603	261-153/341-000	614	261-258/342-000	615	261-344/342-000	613
260-259	603	261-154	606	261-259	607	261-346	605
260-260	603	261-154/331-000	610	261-259/332-000	611	261-346/332-000	609
260-261	603	261-154/341-000	614	261-259/342-000	615	261-346/342-000	613
260-262	603	261-155	606	261-260	607	261-347	605
		261-155/331-000	610	261-260/332-000	611	261-347/332-000	609
260-301	600	261-155/341-000	614	261-260/342-000	615	261-347/342-000	613
260-303	600	261-156	606	261-261	607	261-351	605
260-304	600	261-156/331-000	610	261-261/332-000	611	261-351/332-000	609
260-306	600	261-156/341-000	614	261-261/342-000	615	261-351/342-000	613
260-307	600	261-157	606	261-262	607	261-353	605
260-311	600	261-157/331-000	610	261-262/332-000	611	261-353/332-000	609
260-313	600	261-157/341-000	614	261-262/342-000	615	261-353/342-000	613
260-314	600	261-158	606			261-354	605
260-316	600	261-158/331-000	610	261-301	604	261-354/332-000	609
260-317	600	261-158/341-000	614	261-301/331-000	608	261-354/342-000	613
260-321	600	261-159	606	261-301/341-000	612	261-356	605
260-323	600	261-159/331-000	610	261-303	604	261-356/332-000	609
260-324	600	261-159/341-000	614	261-303/331-000	608	261-356/342-000	613
260-326	600	261-160	606	261-303/341-000	612	261-357	605
260-327	600	261-160/331-000	610	261-304	604	261-357/332-000	609
260-331	601	261-160/341-000	614	261-304/331-000	608	261-357/342-000	613
260-333	601	261-161	606	261-304/341-000	612	261-361	623
260-334	601	261-161/331-000	610	261-306	604	261-371	623
260-336	601	261-161/341-000	614	261-306/331-000	608		
260-337	601	261-162	606	261-306/341-000	612	261-402	623
260-341	601	261-162/331-000	610	261-307	604	261-404	623
260-343	601	261-162/341-000	614	261-307/331-000	608	261-405	623
260-344	601			261-307/341-000	612	261-410	623
260-346	601	261-202	607	261-311	604	261-411	616
260-347	601	261-202/332-000	611	261-311/331-000	608	261-411/331-000	616
260-351	601	261-202/342-000	615	261-311/341-000	612	261-411/341-000	616
260-353	601	261-203	607	261-313	604	261-422	617
260-354	601	261-203/332-000	611	261-313/331-000	608	261-422/331-000	617
260-356	601	261-203/342-000	615	261-313/341-000	612	261-422/341-000	617
260-357	601	261-204	607	261-314	604	261-423	617
260-361	622	261-204/332-000	611	261-314/331-000	608	261-423/331-000	617
260-371	622	261-204/342-000	615	261-314/341-000	612	261-423/341-000	617
		261-205	607	261-316	604	261-424	617
260-402	622	261-205/332-000	611	261-316/331-000	608	261-424/331-000	617
260-404	622	261-205/342-000	615	261-316/341-000	612	261-424/341-000	617
260-405	622	261-206	607	261-317	604	261-425	617
		261-206/332-000	611	261-317/331-000	608	261-425/331-000	617
<b>261 Series</b>		261-206/342-000	615	261-317/341-000	612	261-425/341-000	617
261-102	606	261-207	607	261-321	604	261-426	617
261-102/331-000	610	261-207/332-000	611	261-321/331-000	608	261-426/331-000	617
261-102/341-000	614	261-207/342-000	615	261-321/341-000	612	261-426/341-000	617
261-103	606	261-208	607	261-323	604	261-427	617
261-103/331-000	610	261-208/332-000	611	261-323/331-000	608	261-427/331-000	617
261-103/341-000	614	261-208/342-000	615	261-323/341-000	612	261-427/341-000	617
261-104	606	261-209	607	261-324	604	261-428	617
261-104/331-000	610	261-209/332-000	611	261-324/331-000	608	261-428/331-000	617
261-104/341-000	614	261-209/342-000	615	261-324/341-000	612	261-428/341-000	617
261-105	606	261-210	607	261-326	604	261-429	617
261-105/331-000	610	261-210/332-000	611	261-326/331-000	608	261-429/331-000	617
261-105/341-000	614	261-210/342-000	615	261-326/341-000	612	261-429/341-000	617
261-106	606	261-211	607	261-327	604	261-430	617
261-106/331-000	610	261-211/332-000	611	261-327/331-000	608	261-430/331-000	617
261-106/341-000	614	261-211/342-000	615	261-327/341-000	612	261-430/341-000	617
261-107	606	261-212	607	261-331	605	261-431	617
261-107/331-000	610	261-212/332-000	611	261-331/332-000	609	261-431/331-000	617
261-107/341-000	614	261-212/342-000	615	261-331/342-000	613	261-431/341-000	617
261-108	606	261-252	607	261-333	605	261-432	617
261-108/331-000	610	261-252/332-000	611	261-333/332-000	609	261-432/331-000	617
261-108/341-000	614	261-252/342-000	615	261-333/342-000	613	261-432/341-000	617
261-109	606	261-253	607	261-334	605		
261-109/331-000	610	261-253/332-000	611	261-334/332-000	609		

## Item Number Index

Item No.	Page	Item No.	Page	Item No.	Page	Item No.	Page
<b>262 Series</b>		<b>262 Series</b>		<b>264 Series</b>		<b>264 Series</b>	
262-102	620	262-280	619	264-162	592	264-346	591
262-103	620	262-281	619	264-180	591	264-347	591
262-104	620	262-282	621	264-182	593	264-351	591
262-105	620	262-283	621	264-183	593	264-354	591
262-106	620	262-284	621	264-184	593	264-356	591
262-107	620	262-285	621	264-185	593	264-357	591
262-108	620	262-286	621	264-186	593	264-361	595
262-109	620	262-287	621	264-187	593	264-363	595
262-110	620	262-288	621	264-188	593	264-364	595
262-111	620	262-289	621	264-189	593	264-367	546
262-112	620	262-290	621	264-190	593	264-368	546
262-130	619	262-291	621	264-191	593	264-369	546
262-132	621	262-292	621	264-192	593	264-370	546
262-133	621					264-371	595
262-134	621	262-301	618	264-202	593	264-373	595
262-135	621	262-304	618	264-203	593	264-374	595
262-136	621	262-306	618	264-204	593		
262-137	621	262-307	618	264-205	593	264-402	546
262-138	621	262-311	618	264-206	593		
262-139	621	262-314	618	264-207	593	264-701	544
262-140	621	262-316	618	264-208	593	264-704	544
262-141	621	262-317	618	264-209	593	264-706	544
262-142	621	262-321	618	264-210	593	264-711	542
262-152	620	262-324	618	264-211	593	264-714	542
262-153	620	262-326	618	264-212	593	264-716	542
262-154	620	262-327	618	264-220	545	264-721	545
262-155	620	262-331	619	264-225	543	264-724	545
262-156	620	262-334	619	264-230	591	264-726	545
262-157	620	262-336	619	264-231	591	264-727	545
262-158	620	262-337	619	264-232	593	264-727/999-950	545
262-159	620	262-341	619	264-233	593	264-731	543
262-160	620	262-344	619	264-234	593	264-734	543
262-161	620	262-346	619	264-235	593	264-736	543
262-162	620	262-347	619	264-236	593	264-737	543
262-180	619	262-351	619	264-237	593	264-737/999-950	543
262-181	619	262-354	619	264-238	593		
262-182	621	262-356	619	264-239	593	264-900	781
262-183	621	262-357	619	264-240	593	264-901	781
262-184	621	262-361	619	264-241	593	264-902	781
262-185	621	262-363	624	264-242	593	264-903	781
262-186	621	262-371	624	264-252	593	264-904	781
262-187	621	262-373	624	264-253	593	264-905	781
262-188	621			264-254	593		
262-189	621	262-402	624	264-255	593	<b>270 Series</b>	
262-190	621			264-256	593	270-319	571
262-191	621	<b>264 Series</b>		264-257	593	270-320	571
262-192	621	264-102	592	264-258	593	270-321	571
		264-103	592	264-259	593	270-322	571
262-202	621	264-104	592	264-260	593		
262-203	621	264-105	592	264-261	593	270-409	571
262-204	621	264-106	592	264-262	593	270-417	571
262-205	621	264-107	592	264-280	591	270-480	571
262-206	621	264-108	592	264-282	593		
262-207	621	264-109	592	264-283	593	270-560	572
262-208	621	264-110	592	264-284	593	270-560/281-434	573
262-209	621	264-111	592	264-285	593	270-560/281-507	573
262-210	621	264-112	592	264-286	593	270-564	573
262-211	621	264-120	544	264-287	593	270-564/281-483	573
262-212	621	264-125	542	264-288	593	270-570	574
262-230	619	264-130	590	264-289	593	270-570/281-434	575
262-232	621	264-131	590	264-290	593	270-570/281-507	575
262-233	621	264-132	593	264-291	593	270-572	576
262-234	621	264-133	593	264-292	593	270-572/281-434	577
262-235	621	264-134	593			270-574	575
262-236	621	264-135	593	264-301	591	270-574/281-483	575
262-237	621	264-136	593	264-304	591	270-577	577
262-238	621	264-137	593	264-306	591	270-585	576
262-239	621	264-138	593	264-307	591	270-585/281-507	577
262-240	621	264-139	593	264-311	591	270-586	577
262-241	621	264-140	593	264-314	591		
262-242	621	264-141	593	264-316	591	<b>273 Series</b>	
262-252	621	264-142	593	264-317	591	273-100	726
262-253	621	264-152	592	264-321	591	273-101	727
262-254	621	264-153	592	264-324	591	273-102	729
262-255	621	264-154	592	264-326	591	273-104	729
262-256	621	264-155	592	264-327	591	273-105	729
262-257	621	264-156	592	264-331	591	273-108	727
262-258	621	264-157	592	264-334	591	273-112	728
262-259	621	264-158	592	264-336	591	273-150	727
262-260	621	264-159	592	264-337	591	273-153	726
262-261	621	264-160	592	264-341	591	273-155	727
262-262	621	264-161	592	264-344	591	273-158	727

Item No.	Page	Item No.	Page	Item No.	Page	Item No.	Page
<b>273 Series</b>		<b>279 Series</b>		<b>280 Series</b>		<b>280 Series</b>	
273-252	728	279-915/281-411	418	280-440	793	280-573	403
273-253	729	279-992	286	280-470	446	280-574	402
273-254	729	279-993	287	280-471	446	280-574/281-483	401
273-255	729	279-994	287	280-472	446	280-575	413
		279-995	287	280-473	708	280-575/280-320	413
				280-474	709	280-575/280-323	413
<b>279 Series</b>		<b>280 Series</b>		280-475	708	280-576	414
279-101	654	280-101	655	280-476	708	280-576/281-496	401
279-104	654	280-104	655	280-477	708	280-577	403
		280-107	655	280-478	708	280-577/281-496	401
279-308	439			280-482	440	280-578	415
279-309	439	280-301	670	280-483	440	280-580	404
279-325	438	280-302	670	280-484	440	280-580/281-434	406
279-326	439	280-303	443	280-485	440	280-581/281-413	406
279-328	438	280-304	443	280-490	440	280-582	399
279-329	439	280-305	443	280-492	440	280-583	417
279-330	438	280-306	443	280-494	708	280-584	404
279-331	439	280-308	441			280-584/281-483	407
279-339	439	280-308	441	280-510	323	280-585	416
279-340	439	280-309	441	280-513	321	280-586	417
279-341	439	280-310	441	280-514	323	280-586/281-496	407
279-342	439	280-311	441	280-514	417	280-587	405
279-344	439	280-312	442	280-515	417	280-588	405
279-345	439	280-313	442	280-515	417	280-588/280-320	405
279-346	439	280-314	442	280-517	319	280-588/280-323	405
279-347	439	280-315	442	280-519	319	280-592	409
279-348	439	280-318	442	280-520	319	280-593	413
279-349	439	280-319	444	280-521	321	280-597	327
		280-320	444	280-522	321		
279-402	438	280-321	444	280-523	319	280-610	382
279-405	670	280-322	670	280-524	319	280-615/281-412	425
279-409	438	280-323	444	280-525	321	280-615/281-428	425
279-415	439	280-324	441	280-526	319	280-637	295
279-422	438	280-325	708	280-527	319	280-637/999-950	295
279-432	438	280-326	441	280-528	323	280-640	295
279-432	793	280-330	425	280-529	319	280-641	294
279-433	793	280-331	425	280-530	319	280-641	294
279-440	793	280-332	670	280-531	323	280-645/281-412	425
279-470	439	280-333	707	280-532	323	280-646	295
279-471	439	280-334	442	280-533	319	280-650/056-000	441
279-482	438	280-335	442	280-534	319	280-651	294
279-483	438	280-336	443	280-537	319	280-654/056-000	442
279-490	438	280-339	443	280-543	321	280-656	295
279-492	438	280-340	443	280-547	327	280-673/281-410	423
		280-341	443	280-548	327	280-673/281-411	423
279-501	314	280-342	443	280-549	327	280-675	707
279-504	314	280-343	443	280-550	327	280-681	291
279-507	315	280-344	441	280-551	327	280-683	349
279-508	315	280-346	441	280-552	327	280-684	291
279-509	315	280-348	442	280-553	396	280-687	293
279-512	314	280-352	442	280-554	411	280-687/999-950	293
279-513	314	280-353	442	280-555	411		
279-517	315	280-354	442	280-556	411	280-801/281-411	434
279-518	439	280-355	442	280-557	327	280-801/281-413	436
279-519	439	280-356	441	280-558	327	280-801/281-414	436
279-527	315	280-357	441	280-559	399	280-801/281-415	436
279-529	Volume 6	280-358	441	280-560	396	280-801/281-416	436
		280-359	441	280-560/281-434	400	280-801/281-417	436
279-673/281-410	418	280-366	443	280-561	397	280-801/281-418	436
279-673/281-411	418	280-369	443	280-561/281-413	400	280-801/281-420	434
279-674/281-413	420	280-371	443	280-562	408	280-801/281-421	434
279-674/281-434	420	280-373	443	280-562/281-411	408	280-803/281-411	435
279-681	287	280-374	443	280-562/281-420	415	280-803/281-413	437
279-684	287	280-376	443	280-562/281-434	415	280-803/281-414	437
279-687	289	280-394	708	280-563	397	280-803/281-415	437
279-687/999-950	289	280-395	708	280-564	397	280-803/281-416	437
				280-564/281-483	401	280-803/281-417	437
279-809/281-413	421	280-402	440	280-564/281-483	407	280-803/281-418	437
279-809/281-434	421	280-404	460	280-565	409	280-803/281-420	435
279-815/281-410	419	280-405	530	280-565/280-319	409	280-803/281-421	435
279-815/281-411	419	280-409	440	280-565/280-321	409	280-809/281-413	424
279-826	287	280-415	445	280-566	410	280-809/281-434	424
279-831	287	280-418	444	280-566/281-496	401	280-815/281-410	423
279-834	287	280-419	444	280-567	398	280-815/281-411	423
279-837	289	280-422	440	280-568	411	280-816	382
279-837/999-950	289	280-432	793	280-570	402	280-826	291
279-838	289	280-433	793	280-570/281-434	401	280-829	349
		280-434	793	280-571	403	280-833	291
279-901	286	280-435	793	280-571/281-413	401	280-834	291
279-904	286	280-436	793	280-572	412	280-835/056-000	442
279-907	288	280-437	793	280-572/281-411	412	280-836	349
279-907/999-950	288	280-438	793	280-572/281-420	415	280-837	293
279-915/281-410	418	280-439	793	280-572/281-434	415	280-837/999-950	293

## Item Number Index

Item No.	Page	Item No.	Page	Item No.	Page	Item No.	Page
<b>280 Series</b>		<b>281 Series</b>		<b>281 Series</b>		<b>282 Series</b>	
280-838	293	281-342	449	281-635/281-489	431	282-329	453
280-839	349	281-343	449	281-635/281-490	431	282-330	453
280-850	382	281-344	448	281-635/281-491	431	282-331	453
280-850/281-413	383	281-345	448	281-635/281-492	431	282-332	673
280-852	382	281-346	448	281-636/281-487	431	282-333	454
280-852/281-413	383	281-347	449	281-636/281-488	431	282-334	454
280-854	382	281-348	449	281-637	303	282-339	453
280-854/281-413	383	281-349	448	281-637/999-950	303	282-340	453
280-856	382	281-350	448	281-651	301	282-341	453
280-856/281-413	383	281-355	448	281-652	301	282-342	453
280-868	347	281-356	448	281-654	301	282-357	453
280-869	347	281-357	449	281-656	452	282-358	453
280-870	347	281-358	449	281-657	303	282-360	363
280-871	347	281-365	449	281-657/999-950	303	282-361	363
280-874	347	281-366	449	281-658	303	282-365	363
280-875	347			281-659	351	282-366	363
280-876	347	281-402	447	281-660	351	282-367	453
280-879	347	281-405	672	281-665/281-400	427	282-368	453
280-880	347	281-407	460	281-665/281-401	427	282-369	790
280-881	347	281-409	447	281-665/281-410	427	282-370	363
280-882	347	281-415	451	281-665/281-411	427	282-372	363
280-883	347	281-418	450	281-666	351	282-373	363
280-884	347	281-419	450	281-672	377	282-374	363
280-885	347	281-421	440	281-673/281-400	427	282-384	361
280-889	323	281-422	447	281-673/281-401	427	282-385	360
280-891	323	281-440	793	281-673/281-410	427	282-386	360
		281-470	451	281-673/281-411	427	282-387	360
280-901	290	281-471	451	281-681	301	282-390	360
280-902/056-000	441	281-472	451	281-683	351	282-391	360
280-904	290	281-482	447	281-684	301	282-392	360
280-907	292	281-483	447	281-687	303		
280-907/999-950	292	281-485	447	281-687/999-950	303	282-402	453
280-912	348	281-490	447			282-405	674
280-914	348	281-492	447	281-901	300	282-409	453
280-915/281-410	422			281-904	300	282-415	454
280-915/281-411	422	281-503	175	281-907	303	282-422	453
280-916	446	281-511	380	281-907/999-950	303	282-424	453
280-940/281-410	428	281-512	381	281-912	351	282-432	118
280-940/281-411	428	281-512/281-417	381	281-915/281-400	427	282-432/100-000	118
280-941/281-489	429	281-512/281-418	381	281-915/281-401	427	282-433	118
280-941/281-490	429	281-512/281-501	381	281-915/281-410	426	282-433/100-000	118
280-941/281-491	429	281-530	328	281-915/281-411	426	282-434	118
280-941/281-492	429	281-531	329	281-916	452	282-434/100-000	118
280-942/281-487	429	281-532	329	281-992	300	282-435	118
280-942/281-488	429			281-993	301	282-435/011-000	118
280-943/281-413	432	281-610	452	281-994	301	282-435/301-000	118
280-943/281-434	432	281-611	376	281-998	301	282-436	118
280-992	290	281-611/281-417	377			282-436/301-000	118
280-993	291	281-611/281-418	377	<b>282 Series</b>		282-436/304-000	118
280-994	291	281-611/281-541	377	282-101	657	282-437	118
280-995	291	281-611/281-542	377	282-104	657	282-437/011-000	118
280-996	295	281-612	376	282-107	657	282-437/012-000	118
280-998	294	281-612/281-417	377	282-120	667	282-438	118
		281-612/281-418	377	282-122	388	282-438/300-000	118
		281-612/281-541	377	282-122	666	282-438/301-000	118
		281-612/281-542	377	282-124	667	282-439	118
281-101	656	281-613	378	282-126	667	282-439/011-000	118
281-104	656	281-613/281-417	379	282-128	668	282-440	118
281-107	657	281-613/281-418	379	282-128/281-413	669	282-442	363
		281-613/281-541	379	282-128/281-417	669	282-443	363
		281-613/281-542	379	282-128/281-418	669	282-444	363
281-301	672	281-616	376	282-131	662	282-445	363
281-302	672	281-619	324	282-133	663	282-446	363
281-309	449	281-620	324	282-135	663	282-451	674
281-311	449	281-622	376	282-137	674	282-452	674
281-312	449	281-622/281-417	377	282-138	665	282-453	674
281-313	449	281-622/281-418	377	282-139	665	282-454	674
281-318	449	281-622/281-541	377	282-140	665	282-457	674
281-322	672	281-622/281-542	377	282-141	665	282-458	674
281-324	448	281-623	378				
281-326	448	281-623/281-417	379	282-301	673	282-638	367
281-328	448	281-623/281-418	379	282-302	673	282-639	367
281-329	448	281-623/281-541	379	282-308	453	282-640	367
281-330	448	281-623/281-542	379	282-309	453	282-641	367
281-331	448	281-624	377	282-311	673	282-681	305
281-332	672	281-629	324	282-312	673	282-684	305
281-333	670	281-630	324	282-314	673	282-687	305
281-334	448	281-631	301	282-315	673	282-687/999-950	305
281-335	448	281-633/281-410	430	282-322	673	282-694	369
281-336	670	281-633/281-411	430	282-325	453	282-695	368
281-338	449	281-634/281-413	433	282-326	453	282-696	372
281-339	449	281-634/281-434	433	282-328	453	282-697	368
281-340	449						
281-341	449						

Item No.	Page	Item No.	Page	Item No.	Page	Item No.	Page
<b>282 Series</b>		<b>284 Series</b>		<b>285 Series</b>		<b>294 Series</b>	
282-698/281-413	373	284-101	658	285-435	274	294-4255	642
282-698/281-429	373	284-104	658	285-440	275	294-4275	642
282-698/281-434	373	284-107	659	285-441	275		
282-698/281-449	373			285-442	783	294-4313	640
282-699	369	284-301	675	285-447	263	294-4314	642
		284-302	675	285-450	275	294-4315	644
282-811	364	284-308	455	285-495	276	294-4323	640
282-821	365	284-309	456			294-4324	642
282-841	365	284-322	675	285-634	310	294-4325	644
282-841/049-000	365	284-325	455	285-635	310	294-4335	644
282-860	357	284-326	455	285-637	310	294-4353	640
282-865	357	284-328	455	285-637/999-950	310	294-4355	644
282-866	357	284-329	455			294-4375	644
282-868	358	284-330	455	285-935	258		
282-870	356	284-331	455	285-950	262	294-4413	640
282-881	119	284-332	675	285-992	310	294-4414	640
282-882	119	284-333	673	285-995	264	294-4415	642
282-883	119	284-334	448			294-4423	640
282-884	119	284-336	448	285-1161	268	294-4424	640
282-885	119	284-339	455	285-1164	268	294-4425	642
282-886	119	284-340	456	285-1167	269	294-4435	642
282-887	119	284-341	455	285-1169	277	294-4453	640
282-888	119	284-342	456	285-1171	277	294-4455	642
		284-343	673	285-1175	267	294-4475	642
282-901	304	284-344	448	285-1177	277		
282-904	304	284-346	448	285-1178	277	294-5002	639
282-907	305	284-357	455	285-1179	277	294-5003	639
282-907/999-950	305	284-358	455	285-1184	266	294-5004	640
282-992	304	284-367	455	285-1185	266	294-5005	642
282-993	305	284-368	455	285-1187	267	294-5012	639
						294-5013	639
<b>283 Series</b>		284-400	456	<b>293 Series</b>		294-5014	640
283-101	659	284-402	455	293-219	649	294-5015	642
283-104	659	284-405	676	293-220	649	294-5022	639
283-107	659	284-409	455	293-220	649	294-5023	639
		284-412	455	293-221	649	294-5024	640
283-301	677	284-413	448	293-225	648	294-5025	642
283-302	677	284-414	438	293-228	649	294-5032	639
283-322	677	284-415	456	293-230	649	294-5035	642
283-325	457	284-422	455			294-5042	639
283-326	457			293-325	648	294-5043	639
283-328	457	284-621	311			294-5044	640
283-329	457	284-624	311	<b>294 Series</b>		294-5045	642
283-330	457	284-681	307	294-199	645	294-5052	639
283-331	457	284-684	307			294-5053	639
283-332	677	284-687	307	294-364	645	294-5055	642
283-333	677	284-687/999-950	307	294-384	645	294-5072	639
283-335	677					294-5075	642
283-350	457	284-901	306	294-4002	639	294-5113	639
283-351	457	284-904	306	294-4003	639	294-5114	640
283-352	457	284-907	307	294-4004	640	294-5123	639
283-353	457	284-907/999-950	307	294-4005	642	294-5124	640
283-354	457	284-992	306	294-4006	644	294-5153	639
283-355	457	284-993	307	294-4007	644	294-5155	642
283-357	457			294-4012	639	294-5175	642
283-367	457	<b>285 Series</b>		294-4013	639		
		285-134	258	294-4014	640	294-5213	640
283-400	458	285-135	258	294-4015	642	294-5214	642
283-402	457	285-137	259	294-4022	639	294-5215	642
283-404	458	285-137/999-950	259	294-4023	639	294-5223	640
283-407	259	285-139	274	294-4024	640	294-5224	642
283-409	457	285-150	262	294-4025	642	294-5225	642
283-414	457	285-154	262	294-4032	639	294-5235	642
283-415	458	285-157	263	294-4035	642	294-5253	640
283-422	457	285-157/999-950	263	294-4042	639	294-5255	642
		285-159	275	294-4043	639	294-5275	642
283-609	697	285-169	276	294-4044	640		
283-610	697	285-170	276	294-4045	642	294-5313	640
283-611	697	285-172	275	294-4052	639	294-5314	642
283-671	309	285-194	264	294-4053	639	294-5315	644
283-674	309	285-195	264	294-4055	642	294-5323	640
283-677	309	285-197	265	294-4072	639	294-5324	642
283-677/999-950	309	285-197/999-950	265	294-4075	642	294-5325	644
		285-199	276			294-5335	644
283-901	308			294-4213	640	294-5353	640
283-904	308	285-401	459	294-4214	642	294-5355	644
283-907	309	285-407	265	294-4215	642	294-5375	644
283-907/999-950	309	285-416	459	294-4223	640		
283-992	308	285-420	274	294-4224	642	294-5413	640
283-998	309	285-421	274	294-4225	642	294-5414	640
		285-427	259	294-4235	642	294-5415	642
		285-430	274	294-4253	640		



## Item Number Index

Item No.	Page	Item No.	Page	Item No.	Page	Item No.	Page
<b>294 Series</b>		<b>726 Series</b>		<b>734 Series</b>		<b>769 Series</b>	
294-5423	640	726-902	697	734-326	175	769-112/021-000	519
294-5424	640	726-903	696	734-327	175	769-112/022-000	521
294-5425	642	726-904	696	734-328	175	769-113	519
294-5435	642	726-905	696	734-329	175	769-113/000-036	519
294-5453	640	726-906	696			769-113/000-037	520
294-5455	642	726-907	696	734-430	227	769-113/000-038	520
294-5475	642			734-431	227	769-113/000-039	520
		<b>727 Series</b>				769-113/021-000	519
<b>709 Series</b>		727-105	704	<b>769 Series</b>		769-113/022-000	521
709-107	697	727-106	704	769-101	519	769-114	519
709-110	360	727-107	704	769-101/022-000	521	769-114/000-036	519
709-111	360	727-108	705	769-102	519	769-114/000-037	520
709-112	360	727-113	704	769-102/021-000	519	769-114/000-038	520
709-153	789	727-114	704	769-102/022-000	521	769-114/000-039	520
709-154	789	727-115	704	769-103	519	769-114/021-000	519
709-167	789	727-116	704	769-103/000-036	519	769-114/022-000	521
709-168	789	727-117	704	769-103/000-037	520	769-115	519
709-170	446	727-119	702	769-103/000-038	520	769-115/000-036	519
709-177	783	727-120	703	769-103/000-039	520	769-115/000-037	520
709-178	783	727-121	702	769-103/021-000	519	769-115/000-038	520
709-183	789	727-122	703	769-103/022-000	521	769-115/000-039	520
709-196	783	727-123	702	769-104	519	769-115/021-000	519
		727-124	703	769-104/000-036	519	769-115/022-000	521
709-310	454	727-125	703	769-104/000-037	520	769-121	521
709-311	454	727-126	703	769-104/000-038	520	769-122	521
709-312	456	727-127	703	769-104/000-039	520	769-123	521
709-322	454	727-128	703	769-104/021-000	519	769-124	521
709-324	454	727-129	702	769-104/022-000	521	769-125	521
709-326	454	727-130	703	769-105	519	769-126	521
709-332	456	727-131	702	769-105/000-036	519	769-127	521
709-334	456	727-132	703	769-105/000-037	520	769-128	521
709-336	456	727-133	702	769-105/000-038	520	769-129	521
709-350	770	727-134	703	769-105/000-039	520	769-130	521
709-352	770	727-135	703	769-105/021-000	519	769-131	521
		727-136	703	769-105/022-000	521	769-132	521
<b>726 Series</b>		727-137	703	769-106	519	769-133	521
726-121	684	727-138	703	769-106/000-036	519	769-134	521
726-122	684	727-155	704	769-106/000-037	520	769-135	521
726-141	684	727-156	704	769-106/000-038	520	769-151	475
726-142	684	727-157	704	769-106/000-039	520	769-156	471
		727-158	705	769-106/021-000	519	769-161	493
726-221	685	727-159	704	769-106/022-000	521	769-162/769-313	493
726-222	685	727-160	704	769-107	519	769-163/769-313	493
726-241	685	727-161	704	769-107/000-036	519	769-164/769-313	493
726-242	685	727-162	705	769-107/000-037	520	769-165/769-313	493
		727-163	704	769-107/000-038	520	769-171	474
726-321	687	727-164	704	769-107/000-039	520	769-171/000-006	474
726-322	687	727-165	704	769-107/000-039	520	769-176	470
726-325	687	727-166	705	769-107/021-000	519	769-176/000-006	470
726-326	687	727-167	704	769-107/022-000	521	769-181	492
726-341	687	727-168	704	769-108	519	769-181	492
726-342	687	727-169	704	769-108/000-036	519	769-182/769-314	493
726-345	687	727-170	704	769-108/000-037	520	769-183/769-314	493
726-346	687	727-171	705	769-108/000-038	520	769-184/769-314	493
		727-197	705	769-108/000-039	520	769-185/769-314	493
726-421	685	727-198	705	769-108/021-000	519	769-191	496
726-441	685	727-199	705	769-108/022-000	521	769-192/769-319	496
				769-109	519	769-193/769-319	496
726-521	685	727-205	704	769-109/000-036	519	769-194/769-319	496
726-541	685	727-206	704	769-109/000-037	520	769-195/769-319	496
		727-207	704	769-109/000-038	520		
726-601	688	727-208	704	769-109/000-039	520	769-201	475
726-602	688	727-217	704	769-109/021-000	519	769-202	483
726-611	689	727-219	700	769-109/022-000	521	769-203	483
726-612	689	727-220	701	769-110	519	769-207	475
726-621	689	727-221	700	769-110/000-036	519	769-208/281-410	485
726-622	689	727-222	701	769-110/000-037	520	769-208/281-411	485
726-651	690	727-223	700	769-110/000-038	520	769-209/281-413	487
726-652	690	727-224	701	769-110/000-039	520	769-209/281-434	487
726-661	691	727-225	701	769-110/021-000	519	769-211	474
726-662	691	727-226	701	769-110/022-000	521	769-212	483
726-671	691	727-227	701	769-111	519	769-213	483
726-672	691	727-228	701	769-111/000-036	519	769-214	479
		727-229	700	769-111/000-037	520	769-217	475
726-721	686	727-230	701	769-111/000-038	520	769-218/281-410	485
726-741	686	727-231	700	769-111/000-039	520	769-218/281-411	485
726-770	694	727-232	701	769-111/021-000	519	769-219/281-413	487
		727-233	700	769-111/022-000	521	769-219/281-434	487
726-821	687	727-234	701	769-112	519	769-221	471
726-841	687	727-235	701	769-112/000-036	519	769-222	483
		727-236	701	769-112/000-037	520	769-223	483
726-901	696	727-237	701	769-112/000-038	520	769-227	471
		727-238	701	769-112/000-039	520	769-228/281-410	485



Item No.	Page	Item No.	Page	Item No.	Page	Item No.	Page
<b>769 Series</b>		<b>769 Series</b>		<b>769 Series</b>		<b>769 Series</b>	
769-228/281-411	485	769-513/000-016	522	769-614/006-000	510	769-666/004-000	515
769-229/281-413	487	769-515	522	769-615	509	769-667	513
769-229/281-434	487	769-515/000-006	522	769-615/001-000	509	769-667/003-000	514
769-231	470	769-515/000-016	522	769-615/002-000	509	769-667/004-000	515
769-232	482			769-615/004-000	510	769-668	513
769-233	482	769-602	509	769-615/005-000	510	769-668/003-000	514
769-237	471	769-602/001-000	509	769-615/006-000	510	769-668/004-000	515
769-238/281-410	484	769-602/002-000	509	769-632	513	769-669	513
769-238/281-411	484	769-602/004-000	510	769-632/003-000	514	769-669/003-000	514
769-239/281-413	486	769-602/005-000	510	769-632/003-036	514	769-669/004-000	515
769-239/281-434	486	769-602/006-000	510	769-632/004-000	515	769-670	513
769-242	490	769-603	509	769-632/007-000	515	769-670/003-000	514
769-243	490	769-603/001-000	509	769-633	513	769-670/004-000	515
769-251	478	769-603/002-000	509	769-633/003-000	514	769-671	513
769-251/000-006	478	769-603/004-000	510	769-633/003-036	514	769-671/003-000	514
769-257	479	769-603/005-000	510	769-633/004-000	515	769-671/004-000	515
		769-603/006-000	510	769-633/007-000	515	769-672	513
769-301	526	769-604	509	769-634	513	769-672/003-000	514
769-302	526	769-604/001-000	509	769-634/003-000	514	769-672/004-000	515
769-303	526	769-604/002-000	509	769-634/003-036	514	769-673	513
769-304	526	769-604/004-000	510	769-634/004-000	515	769-673/003-000	514
769-305	526	769-604/005-000	510	769-634/007-000	515	769-673/004-000	515
769-306	526	769-604/006-000	510	769-635	513	769-674	513
769-307	526	769-605	509	769-635/003-000	514	769-674/003-000	514
769-308	526	769-605/001-000	509	769-635/003-036	514	769-674/004-000	515
769-309	527	769-605/002-000	509	769-635/004-000	515	769-675	513
769-310	527	769-605/004-000	510	769-635/007-000	515	769-675/003-000	514
769-311	527	769-605/005-000	510	769-636	513	769-675/004-000	515
769-312	527	769-605/006-000	510	769-636/003-000	514		
769-313	527	769-606	509	769-636/003-036	514	769-1602	524
769-314	527	769-606/001-000	509	769-636/004-000	515	769-1603	524
769-315	527	769-606/002-000	509	769-636/007-000	515	769-1604	524
769-316	527	769-606/004-000	510	769-637	513	769-1605	524
769-317	527	769-606/005-000	510	769-637/003-000	514	769-1606	524
769-318	527	769-606/006-000	510	769-637/004-000	515	769-1607	524
769-319	527	769-607	509	769-637/007-000	515	769-1608	524
769-320	527	769-607/001-000	509	769-638	513	769-1609	524
769-321	527	769-607/002-000	509	769-638/003-000	514	769-1610	524
		769-607/004-000	510	769-638/004-000	515	769-1611	524
769-402	531	769-607/005-000	510	769-638/007-000	515	769-1612	524
769-410	532	769-607/006-000	510	769-639	513	769-1613	524
769-411	532	769-608	509	769-639/003-000	514	769-1614	524
769-412	532	769-608/001-000	509	769-639/004-000	515	769-1615	524
769-413	532	769-608/002-000	509	769-639/007-000	515		
769-414	532	769-608/004-000	510	769-640	513	<b>773 Series</b>	
769-428	531	769-608/005-000	510	769-640/003-000	514	773-173	735
769-429	531	769-608/006-000	510	769-640/004-000	515		
769-430	531	769-609	509	769-640/007-000	515	773-331	739
769-431	531	769-609/001-000	509	769-641	513	773-332	739
769-434	532	769-609/002-000	509	769-641/003-000	514		
769-435	527	769-609/004-000	510	769-641/004-000	515	773-492	737
769-436	531	769-609/005-000	510	769-641/007-000	515	773-493	738
769-438	527	769-609/006-000	510	769-642	513	773-494	737
769-439	527	769-610	509	769-642/003-000	514	773-496	737
769-470	528	769-610/001-000	509	769-642/004-000	515	773-498	737
769-471	528	769-610/002-000	509	769-642/007-000	515		
769-472	528	769-610/004-000	510	769-643	513	773-514	733
769-499	509	769-610/005-000	510	769-643/003-000	514		
		769-610/006-000	510	769-643/004-000	515	773-602	732
769-501	522	769-611	509	769-643/007-000	515	773-604	733
769-501/000-006	522	769-611/001-000	509	769-644	513	773-606	733
769-501/000-016	522	769-611/002-000	509	769-644/003-000	514		
769-502	522	769-611/004-000	510	769-644/004-000	515	<b>777 Series</b>	
769-502/000-006	522	769-611/005-000	510	769-644/007-000	515	777-300	462
769-502/000-016	522	769-611/006-000	510	769-645	513	777-303	252
769-503	522	769-612	509	769-645/003-000	514	777-305	461
769-503/000-006	522	769-612/001-000	509	769-645/004-000	515	777-310	462
769-503/000-016	522	769-612/002-000	509	769-645/007-000	515		
769-504	522	769-612/004-000	510	769-662	513	<b>780 Series</b>	
769-504/000-006	522	769-612/005-000	510	769-662/003-000	514	780-317	443
769-504/000-016	522	769-612/006-000	510	769-662/004-000	515	780-321	461
769-505	522	769-613	509	769-663	513		
769-505/000-006	522	769-613/001-000	509	769-663/003-000	514	780-452	440
769-505/000-016	522	769-613/002-000	509	769-663/004-000	515	780-453	440
769-506	522	769-613/004-000	510	769-664	513	780-454	440
769-506/000-006	522	769-613/005-000	510	769-664/003-000	514	780-455	440
769-506/000-016	522	769-613/006-000	510	769-664/004-000	515	780-456	440
769-512	522	769-614	509	769-665	513	780-457	440
769-512/000-006	522	769-614/001-000	509	769-665/003-000	514	780-458	440
769-512/000-016	522	769-614/002-000	509	769-665/004-000	515		
769-513	522	769-614/004-000	510	769-666	513		
769-513/000-006	522	769-614/005-000	510	769-666/003-000	514	780-601	332

## Item Number Index

Item No.	Page	Item No.	Page	Item No.	Page	Item No.	Page
<b>780 Series</b>		<b>790 Series</b>		<b>811 Series</b>		<b>862 Series</b>	
780-602	332	790-100	772	811-310	387	862-593	632
780-604	332	790-101	772	811-311	387	862-594	632
780-607	333	790-108	767	811-314	387		
780-607/999-950	333	790-110	771	811-316	387	862-603	632
780-613	341	790-112	771	811-317	387	862-604	633
780-631	333	790-113	771	811-320	387	862-605	633
780-637	333	790-114	771	811-321	387	862-615	633
780-637/999-950	333	790-115	771	811-330	387	862-625	633
780-640	333	790-116	767	811-331	387	862-632	631
780-651	333	790-124	767			862-633	632
780-654	333	790-133	771	811-410	387	862-634	633
		790-134	771	811-411	387	862-652	631
780-992	332	790-140	767	811-414	387	862-662	631
780-993	333	790-144	771	811-420	387	862-693	632
		790-145	771	811-421	387	862-694	633
<b>781 Series</b>		790-190	772	811-430	387		
781-452	447	790-191	772	811-431	387	862-1503	632
781-453	447	790-192	772	811-471	385	862-1503/999-950	632
781-454	447	790-193	772	811-472	385	862-1504	632
781-455	447			811-473	385	862-1504/999-950	632
781-456	447	790-208	769	811-474	385	862-1505	633
		790-216	769	811-475	385	862-1505/999-950	633
781-601	334	790-220	769	811-476	385	862-1515	633
781-604	334			811-477	385	862-1515/999-950	633
781-607	335	790-300	774	811-478	385	862-1525	633
781-607/999-950	335	790-301	774	811-479	385	862-1525/999-950	633
781-613	341	790-302	774	811-480	385	862-1532	631
781-623	341	790-310	774	811-481	385	862-1532/999-950	631
781-631	335	790-311	774	811-482	385	862-1533	632
781-637	335	790-312	774			862-1533/999-950	632
781-637/999-950	335	790-350/790-398	776	811-612	385	862-1534	632
781-643	341	790-352/790-398	776			862-1534/999-950	632
781-651	335	790-360/790-398	776	<b>812 Series</b>		862-1552	631
781-653	341	790-362/790-398	776	812-100	713	862-1552/999-950	631
		790-398	776	812-101	713	862-1562	631
781-992	334			812-102	713	862-1562/999-950	631
781-993	335	790-400	777	812-103	713	862-1593	632
				812-104	713	862-1593/999-950	632
<b>782 Series</b>		<b>791 Series</b>		812-110	713	862-1594	632
782-300	462	791-107	770	812-111	713	862-1594/999-950	632
782-317	454	791-111	770	812-112	713		
782-321	461	791-117	770	812-113	713	862-1603	632
		791-124	770	812-114	714	862-1603/999-950	632
782-601	336			812-140	714	862-1604	633
782-604	336	<b>793 Series</b>		812-141	713	862-1604/999-950	633
782-607	337	793-501	780			862-1605	633
782-607/999-950	337	793-501/000-002	780	<b>834 Series</b>		862-1605/999-950	633
782-613	341	793-501/000-005	780	834-137	273	862-1615	633
782-623	341	793-501/000-006	780			862-1615/999-950	633
		793-501/000-007	780	834-1102	273	862-1625	633
782-992	336	793-501/000-012	780	834-1103	273	862-1625/999-950	633
		793-501/000-017	780	834-1104	273	862-1632	631
<b>783 Series</b>		793-501/000-023	780	834-1105	273	862-1632/999-950	631
783-317	457	793-501/000-024	780	834-1106	273	862-1633	632
783-321	461			834-1107	273	862-1633/999-950	632
		793-3501	780	834-1108	273	862-1634	633
783-601	338					862-1634/999-950	633
783-604	338	793-4501	780	834-1202	273	862-1652	631
783-607	339	793-4501/000-002	780	834-1203	273	862-1652/999-950	631
783-607/999-950	339	793-4501/000-005	780	834-1204	273	862-1662	631
783-613	343	793-4501/000-006	780	834-1205	273	862-1662/999-950	631
783-623	343	793-4501/000-007	780	834-1206	273	862-1693	632
		793-4501/000-012	780	834-1207	273	862-1693/999-950	632
783-992	338	793-4501/000-014	780	834-1208	273	862-1694	633
		793-4501/000-017	780			862-1694/999-950	633
<b>784 Series</b>		793-4501/000-023	780	<b>859 Series</b>		862-2503	632
784-601	337	793-4501/000-024	780	859-500	227	862-2504	632
784-604	337					862-2505	633
784-607	337	793-5501	780	<b>862 Series</b>		862-2515	633
784-607/999-950	337	793-5501/000-002	780	862-482	634	862-2525	633
784-613	343	793-5501/000-005	780			862-2532	631
784-623	343	793-5501/000-006	780	862-503	632	862-2533	632
		793-5501/000-007	780	862-504	632	862-2534	632
784-992	337	793-5501/000-012	780	862-505	633	862-2552	631
		793-5501/000-014	780	862-515	633	862-2562	631
<b>785 Series</b>		793-5501/000-017	780	862-525	633	862-2593	632
785-601	339	793-5501/000-023	780	862-532	631	862-2594	632
785-604	339	793-5501/000-024	780	862-533	632		
785-607	339	794-5553/000-002	119	862-534	632	862-2603	632
785-613	343	794-5554/000-006	119	862-552	631	862-2604	633
785-613	343			862-562	631	862-2605	633

Item No.	Page	Item No.	Page	Item No.	Page	Item No.	Page
<b>862 Series</b>		<b>869 Series</b>		<b>870 Series</b>		<b>870 Series</b>	
862-2615	633	869-161	585	870-107	499	870-577	559
862-2625	633	869-162	585	870-108	499	870-590/281-410	562
862-2632	631	869-182	585	870-109	499	870-590/281-411	562
862-2633	632	869-183	585	870-117	499	870-590/281-675	563
862-2634	633	869-184	585	870-118	529	870-590/281-676	563
862-2652	631	869-185	585	870-119	529	870-593/281-413	565
862-2662	631	869-186	585	870-127	499	870-593/281-434	565
862-2693	632	869-187	585	870-131	502	870-596/281-673	563
862-2694	633	869-188	585	870-137	503	870-596/281-674	563
		869-189	585	870-138	503		
862-8503	632	869-190	585	870-148	529	870-681	551
862-8504	632	869-191	585	870-151	500	870-684	551
862-8505	633	869-192	585	870-157	501	870-687	553
862-8515	633			870-158	501		
862-8525	633	869-202	585	870-168	529	870-826	551
862-8533	632	869-203	585	870-169	529	870-831	551
862-8534	632	869-204	585			870-834	551
862-8593	632	869-205	585	870-402	529	870-837	553
862-8594	632	869-206	585	870-403	529		
		869-207	585	870-404	529	870-901	550
862-8603	632	869-208	585	870-405	529	870-904	550
862-8604	633	869-209	585	870-405/011-000	529	870-907	552
862-8605	633	869-210	585	870-406	529	870-907/999-950	552
862-8615	633	869-211	585	870-407	529	870-909	550
862-8625	633	869-212	585	870-407/011-000	529	870-911	551
862-8633	632	869-232	585	870-408	529	870-914	551
862-8634	633	869-233	585	870-409	529	870-917	553
862-8693	632	869-234	585	870-409/011-000	529	870-919	551
862-8694	633	869-235	585	870-410	529	870-923	568
		869-236	585	870-425	567	870-924	568
862-9503	632	869-237	585	870-426	567	870-925	568
862-9504	632	869-238	585	870-427	567	870-926	568
862-9505	633	869-239	585	870-433	529	870-928	568
862-9515	633	869-240	585	870-434	529	870-929	568
862-9525	633	869-241	585	870-435	529	870-933	568
862-9533	632	869-242	585	870-436	529	870-934	568
862-9534	632			870-437	529	870-943	569
862-9593	632	869-301	583	870-438	529	870-944	551
862-9594	632	869-304	583	870-439	529	870-946	568
		869-307	583	870-440	529	870-947	568
862-9603	632	869-309	583			870-948	569
862-9604	633	869-311	583	870-501	554	870-949	569
862-9605	633	869-314	583	870-502	554	870-951	558
862-9615	633	869-316	583	870-503	554	870-957/999-950	559
862-9625	633	869-317	583	870-504	554	870-961	554
862-9633	632	869-319	583	870-507	555	870-967/999-950	555
862-9634	633	869-321	582	870-508	555		
862-9693	632	869-324	582	870-509	555	<b>873 Series</b>	
862-9694	633	869-326	582	870-517	555	873-902	761
		869-327	582	870-518	569	873-903	761
<b>869 Series</b>		869-328	582	870-519	569	873-953	761
869-102	585	869-329	582	870-527	555		
869-103	585	869-331	583	870-531	557	<b>880 Series</b>	
869-104	585	869-334	583	870-532	557	880-308	442
869-105	585	869-337	583	870-533	557	880-309	442
869-106	585	869-339	583	870-534	557	880-325	442
869-107	585	869-341	583	870-535	557	880-326	442
869-108	585	869-344	583	870-536	557	880-328	442
869-109	585	869-347	583	870-537	557	880-329	442
869-110	585	869-349	583	870-538	557	880-339	442
869-111	585	869-351	583	870-539	557	880-340	442
869-112	585	869-354	583	870-540/281-410	560	880-344	442
869-132	585	869-357	583	870-540/281-411	560	880-345	443
869-133	585	869-359	583	870-541/281-489	561	880-346	442
869-134	585	869-375	586	870-541/281-490	561	880-347	443
869-135	585	869-377	586	870-541/281-491	561		
869-136	585	869-378	586	870-541/281-492	561	880-681/999-940	297
869-137	585	869-379	586	870-542/281-487	561	880-684/999-940	297
869-138	585	869-385	586	870-542/281-488	561	880-687/999-940	299
869-139	585	869-387	586	870-543/281-413	564		
869-140	585	869-388	586	870-543/281-434	564	880-831/999-940	297
869-141	585	869-389	586	870-551	558	880-834/999-940	297
869-142	585	869-395	586	870-553	558	880-837/999-940	299
869-152	585	869-397	586	870-556	559		
869-153	585	869-398	586	870-557	559	880-901/999-940	296
869-154	585	869-399	586	870-558	559	880-904/999-940	296
869-155	585			870-559	559	880-907/999-940	298
869-156	585	<b>870 Series</b>		870-567	559		
869-157	585	870-101	498	870-568	569	<b>887 Series</b>	
869-158	585	870-102	498	870-569	569	887-912	755
869-159	585	870-103	498	870-573	569		
869-160	585	870-104	498	870-574	569		

## Item Number Index

Item No.	Page	Item No.	Page	Item No.	Page	Item No.	Page
<b>2000 Series</b>		<b>2000 Series</b>		<b>2001 Series</b>		<b>2002 Series</b>	
2000-115	223	2000-2203/099-000	60	2001-405	162	2002-407	164
2000-402	160	2000-2204	58	2001-405/011-000	162	2002-407/000-005	164
2000-402/000-005	160	2000-2204/099-000	60	2001-406	162	2002-407/000-006	164
2000-402/000-006	160	2000-2207	59	2001-406/020-000	162	2002-408	164
2000-402/000-018	160	2000-2207/099-000	61	2001-407	162	2002-408/000-005	164
2000-403	160	2000-2208	59	2001-408	162	2002-408/000-006	164
2000-403/000-005	160	2000-2208/099-000	61	2001-409	162	2002-409/000-005	164
2000-403/000-006	160	2000-2209	59	2001-410	162	2002-409/000-006	164
2000-404	160	2000-2209/099-000	61	2001-433	162	2002-410	164
2000-404/000-005	160	2000-2217	59	2001-434	162	2002-410/000-005	164
2000-404/000-006	160	2000-2217/099-000	61	2001-435	162	2002-410/000-006	164
2000-405	160	2000-2218	59	2001-436	162	2002-423	165
2000-405/000-005	160	2000-2218/099-000	61	2001-437	162	2002-423/000-005	165
2000-405/000-006	160	2000-2227	59	2001-438	162	2002-423/000-006	165
2000-405/011-000	160	2000-2227/099-000	61	2001-439	162	2002-433	164
2000-406	160	2000-2228	59	2001-440	162	2002-434	164
2000-406/000-005	160	2000-2228/099-000	61	2001-511	157	2002-435	164
2000-406/000-006	160	2000-2231	58	2001-519	157	2002-436	164
2000-406/020-000	160	2000-2231/099-000	60	2001-549	157	2002-437	164
2000-407	160	2000-2232	58	2001-552	157	2002-438	164
2000-407/000-005	160	2000-2232/099-000	60	2001-553	157	2002-439	164
2000-407/000-006	160	2000-2233	58	2001-554	157	2002-440	164
2000-408	160	2000-2233/099-000	60	2001-555	157	2002-472	164
2000-408/000-005	160	2000-2234	58	2001-556	157	2002-473	164
2000-408/000-006	160	2000-2234/099-000	60	2001-557	157	2002-473/011-000	164
2000-409	160	2000-2237	59	2001-558	157	2002-474	164
2000-409/000-005	160	2000-2237/099-000	61	2001-559	157	2002-475	164
2000-409/000-006	160	2000-2238	59	2001-560	157	2002-475/011-000	164
2000-410	160	2000-2238/099-000	61	2001-1201	38	2002-476	164
2000-410/000-005	160	2000-2239	59	2001-1204	38	2002-477	164
2000-410/000-006	160	2000-2239/099-000	61	2001-1207	40	2002-477/011-000	164
2000-433	160	2000-2247	59	2001-1207	40	2002-478	164
2000-434	160	2000-2247/099-000	61	2001-1208	40	2002-479	164
2000-435	160	2000-2248	59	2001-1211/1000-410	132	2002-479/011-000	164
2000-436	160	2000-2248/099-000	61	2001-1211/1000-411	132	2002-480	164
2000-437	160	2000-2257	59	2001-1301	39	2002-481	164
2000-438	160	2000-2257/099-000	61	2001-1304	39	2002-481/011-000	164
2000-439	160	2000-2258	59	2001-1307	41	2002-482	164
2000-440	160	2000-2258/099-000	61	2001-1307	41	2002-492	165
2000-492	161	2000-2291	161	2001-1308	41	2002-492/000-012	165
2000-510	156	2000-2292	161	2001-1311/1000-410	133	2002-493	166
2000-511	156	2000-5310/101-000	130	2001-1311/1000-411	133	2002-511	157
2000-549	156	2000-5310/102-000	130	2001-1321/1000-413	134	2002-541	156
2000-552	156	2000-5310/1101-951	131	2001-1321/1000-434	134	2002-549	157
2000-553	156	2000-5310/1102-950	131	2001-1401	39	2002-552	157
2000-554	156	2000-5311	126	2001-1404	39	2002-553	157
2000-555	156	2000-5311/1101-951	127	2001-1407	41	2002-554	157
2000-556	156	2000-5311/1102-950	127	2001-1408	41	2002-555	157
2000-557	156	2000-5317/101-000	130	2001-1411/1000-410	133	2002-556	157
2000-558	156	2000-5317/102-000	130	2001-1411/1000-411	133	2002-557	157
2000-559	156	2000-5317/1101-951	131	2001-1421/1000-413	135	2002-558	157
2000-560	156	2000-5317/1102-950	131	2001-1421/1000-434	135	2002-559	157
2000-1201	34	2000-5352	127	2001-1441	39	2002-560	157
2000-1204	34	2000-5352/1102-953	127	<b>2002 Series</b>		2002-611	157
2000-1207	36	2000-5357/101-000	131	2002-115	168	2002-641	157
2000-1291	161	2000-5357/102-000	131	2002-171	168	2002-649	157
2000-1292	161	2000-5372	127	2002-172	168	2002-800	152
2000-1301	35	2000-5372/1102-953	127	2002-191	168	2002-800/1000-410	148
2000-1304	35	2000-5377/101-000	131	2002-192	168	2002-800/1000-411	148
2000-1307	37	2000-5377/102-000	131	2002-194	168	2002-800/1000-541	150
2000-1391	161	2000-5391	161	2002-400	165	2002-800/1000-542	150
2000-1392	161	2000-5410	128	2002-401	168	2002-800/1000-836	150
2000-1401	35	2000-5410/1101-951	129	2002-402	164	2002-810	153
2000-1404	35	2000-5410/1102-950	129	2002-402/000-005	164	2002-820	153
2000-1407	37	2000-5417	128	2002-402/000-006	164	2002-880	149
2000-1491	161	2000-5417/1101-951	129	2002-403	164	2002-880/1000-411	149
2000-1492	161	2000-5417/1102-950	129	2002-403/000-005	164	2002-880/1000-541	151
2000-2141	35	2000-5457	129	2002-403/000-006	164	2002-880/1000-542	151
2000-2195	161	2000-5457/1102-953	129	2002-404	164	2002-880/1000-836	151
2000-2196	161	2000-5477	129	2002-404/000-005	164	2002-991	167
2000-2201	58	2000-5477/1102-953	129	2002-404/000-006	164	2002-992	167
2000-2202	58	2000-5491	161	2002-405	164	2002-1091	167
2000-2202/099-000	60	<b>2001 Series</b>		2002-405/000-005	164	2002-1092	167
2000-2203	58	2001-115	163	2002-405/000-006	164	2002-1201	42
		2001-171	163	2002-405/011-000	165	2002-1204	42
		2001-402	162	2002-406	164		
		2001-403	162	2002-406/000-005	164		
		2001-404	162	2002-406/000-006	164		
				2002-406/020-000	165		

Item No.	Page	Item No.	Page	Item No.	Page	Item No.	Page
<b>2002 Series</b>		<b>2002 Series</b>		<b>2002 Series</b>		<b>2002 Series</b>	
2002-1207	44	2002-1891	167	2002-2258/099-000	65	2002-3217	77
2002-1208	44	2002-1892	167	2002-2291	166	2002-3218	77
2002-1211/1000-410	136			2002-2292	166	2002-3221/1000-413	147
2002-1211/1000-411	136	2002-1901	93	2002-2295	166	2002-3221/1000-434	147
2002-1291	163	2002-1904	93	2002-2296	166	2002-3227	77
2002-1292	163	2002-1907	93			2002-3228	77
2002-1293	163	2002-1907	93	2002-2401	68	2002-3231	76
2002-1294	163	2002-1911	96	2002-2402	68	2002-3232	76
		2002-1911/1000-541	97	2002-2403	68	2002-3234	76
2002-1301	43	2002-1911/1000-542	97	2002-2404	68	2002-3237	77
2002-1304	43	2002-1911/1000-836	97	2002-2407	69	2002-3238	77
2002-1307	45	2002-1911/1000-867	97	2002-2408	69	2002-3239	77
2002-1308	45	2002-1961	93	2002-2409	69	2002-3247	77
2002-1311/1000-410	137	2002-1971	92	2002-2417	69	2002-3248	77
2002-1311/1000-411	137	2002-1971/401-000	93	2002-2418	69	2002-3257	77
2002-1321/1000-413	138	2002-1974	92	2002-2427	69	2002-3258	77
2002-1321/1000-434	138	2002-1974/401-000	93	2002-2428	69	2002-3291	167
2002-1391	163	2002-1981	94	2002-2431	68	2002-3292	167
2002-1392	163	2002-1981/1000-413	95	2002-2432	68		
2002-1393	163	2002-1981/1000-414	95	2002-2433	68	2002-4101	79
2002-1394	163	2002-1981/1000-429	95	2002-2434	68	2002-4111	79
		2002-1981/1000-434	95	2002-2437	69	2002-4127	78
2002-1401	43	2002-1981/1000-435	95	2002-2438	69	2002-4131	79
2002-1404	43	2002-1981/1000-449	95	2002-2439	69	2002-4141	79
2002-1407	45	2002-1991	167	2002-2447	69	2002-4157	78
2002-1408	45	2002-1992	167	2002-2448	69	2002-4191	167
2002-1411/1000-410	137			2002-2457	69	2002-4192	167
2002-1411/1000-411	137	2002-2201	62	2002-2458	69		
2002-1421/1000-413	139	2002-2201/097-000	66	2002-2491	166	2002-6301	46
2002-1421/1000-434	139	2002-2201/098-000	67	2002-2492	166	2002-6304	46
2002-1441	43	2002-2201/099-000	64			2002-6307	47
2002-1491	163	2002-2202	62	2002-2601	70	2002-6308	47
2002-1492	163	2002-2202/099-000	64	2002-2602	70	2002-6391	166
2002-1493	163	2002-2203	62	2002-2603	70	2002-6392	166
2002-1494	163	2002-2203/099-000	64	2002-2604	70		
		2002-2204	62	2002-2607	71	2002-6401	47
2002-1601	83	2002-2204/099-000	64	2002-2608	71	2002-6404	47
2002-1604	83	2002-2207	63	2002-2609	71	2002-6407	47
2002-1611	90	2002-2207/099-000	65	2002-2611	75		
2002-1611/1000-541	90	2002-2208	63	2002-2611/1000-541	75	2002-7111	242
2002-1611/1000-542	90	2002-2208/099-000	65	2002-2611/1000-542	75	2002-7114	242
2002-1611/1000-836	90	2002-2209	63	2002-2611/1000-836	75	2002-7192	247
2002-1611/1000-867	90	2002-2209/099-000	65	2002-2611/1000-867	75		
2002-1661	83	2002-2211/1000-410	142	2002-2612	75	2002-7211	243
2002-1671	82	2002-2211/1000-411	142	2002-2647	71	2002-7214	243
2002-1671/401-000	83	2002-2213/1000-487	143	2002-2657	71	2002-7292	248
2002-1674	82	2002-2213/1000-488	143	2002-2661	73		
2002-1674/401-000	83	2002-2214/1000-489	143	2002-2662	73	<b>2003 Series</b>	
2002-1681	88	2002-2214/1000-490	143	2002-2667	73	2003-499	248
2002-1691	167	2002-2214/1000-491	143	2002-2671	72		
2002-1692	167	2002-2214/1000-492	143	2002-2672	72	2003-500	248
		2002-2217	63	2002-2678	73		
2002-1701	85	2002-2217/099-000	65	2002-2691	167	2003-911	239
2002-1704	85	2002-2218	63	2002-2692	167	2003-911/1000-923	239
2002-1707	85	2002-2218/099-000	65				
2002-1711	91	2002-2221/1000-413	146	2002-2941	81	2003-6640	238
2002-1711/1000-541	91	2002-2221/1000-434	146	2002-2944	81	2003-6641	236
2002-1711/1000-542	91	2002-2227	63	2002-2951	80	2003-6642	237
2002-1711/1000-836	91	2002-2227/099-000	65	2002-2952	80	2003-6643	238
2002-1711/1000-867	91	2002-2228	63	2002-2954	80	2003-6644	236
2002-1761	85	2002-2228/099-000	65	2002-2958	81	2003-6645	237
2002-1771	84	2002-2231	62	2002-2959	81	2003-6646	237
2002-1771/401-000	85	2002-2231/099-000	64	2002-2961	81	2003-6649	237
2002-1774	84	2002-2232	62	2002-2963	81	2003-6650	237
2002-1774/401-000	85	2002-2232/099-000	64	2002-2971	81	2003-6651	237
2002-1781	89	2002-2233	62	2002-2972	81	2003-6660	238
2002-1791	167	2002-2233/099-000	64	2002-2974	81	2003-6692	247
2002-1792	167	2002-2234	62	2002-2991	167	2003-6693	247
		2002-2234/099-000	64	2002-2992	167		
2002-1801	87	2002-2237	63			2003-7300	248
2002-1804	87	2002-2237/099-000	65	2002-3201	76		
2002-1811	91	2002-2238	63	2002-3202	76	2003-7640	235
2002-1811/1000-541	91	2002-2238/099-000	65	2002-3204	76	2003-7641	234
2002-1811/1000-542	91	2002-2239	63	2002-3207	77	2003-7642	235
2002-1811/1000-836	91	2002-2239/099-000	65	2002-3208	77	2003-7645	235
2002-1811/1000-867	91	2002-2247	63	2002-3209	77	2003-7646	235
2002-1861	87	2002-2247/099-000	65	2002-3211/1000-410	144	2003-7649	235
2002-1871	87	2002-2248	63	2002-3211/1000-411	144	2003-7650	235
2002-1871/401-000	87	2002-2248/099-000	65	2002-3211/1000-675	145	2003-7651	235
2002-1874	87	2002-2257	63	2002-3211/1000-676	145	2003-7659	235
2002-1874/401-000	87	2002-2257/099-000	65	2002-3212/1000-673	145	2003-7692	247
2002-1881	89	2002-2258	63	2002-3212/1000-674	145		



## Item Number Index

Item No.	Page	Item No.	Page	Item No.	Page	Item No.	Page
<b>2004 Series</b>		<b>2006 Series</b>		<b>2006 Series</b>		<b>2010 Series</b>	
2004-115	170	2006-401	172	2006-1631/1099-859	106	2010-100	173
2004-171	170	2006-401/000-050	172	2006-1631/1099-867	106	2010-115	173
2004-172	170	2006-402	171	2006-1661	99		
		2006-403	171	2006-1664	99	2010-402	173
2004-402	169	2006-404	171	2006-1671	98	2010-403	173
2004-403	169	2006-405	171	2006-1671/1000-848	101	2010-404	173
2004-404	169	2006-405/011-000	171	2006-1671/1000-849	101	2010-405	173
2004-405	169	2006-433	171	2006-1671/1000-850	101	2010-405/011-000	173
2004-405/011-000	169	2006-434	171	2006-1671/1000-851	101	2010-433	173
2004-406	169	2006-435	171	2006-1674	98	2010-434	173
2004-406/020-000	169	2006-451	172	2006-1681	102	2010-435	173
2004-407	169	2006-499	162	2006-1681/1000-413	103		
2004-408	169			2006-1681/1000-414	103	2010-511	159
2004-409	169	2006-511	159	2006-1681/1000-429	103	2010-549	159
2004-410	169	2006-549	159	2006-1681/1000-434	103		
2004-433	169			2006-1681/1000-435	103	2010-1201	54
2004-434	169	2006-911	122	2006-1681/1000-449	103	2010-1204	54
2004-435	169	2006-911/1000-541	122	2006-1691	171	2010-1207	55
2004-436	169	2006-911/1000-542	122	2006-1692	171	2010-1208	55
2004-437	169	2006-911/1000-836	122	2006-1695	171	2010-1291	173
2004-438	169	2006-911/1000-867	122	2006-1696	171	2010-1292	173
2004-439	169	2006-921	123				
2004-440	169	2006-921/1000-541	123	2006-7111	243	2010-1301	55
		2006-921/1000-542	123	2006-7114	243	2010-1304	55
2004-511	158	2006-921/1000-836	123	2006-7192	250	2010-1307	55
2004-541	158	2006-921/1000-859	123			2010-1391	173
2004-549	158	2006-921/1000-867	123	2006-7300	250	2010-1392	173
2004-552	158	2006-931	123				
2004-553	158	2006-931/099-000	123	2006-8401	172		
2004-554	158	2006-931/1000-541	123			<b>2016 Series</b>	
2004-555	158	2006-931/1000-542	123	2006-8601	109	2016-100	174
		2006-931/1000-836	123	2006-8604	109	2016-115	174
2004-911	121	2006-931/1000-859	123	2006-8661	109		
2004-911/1000-541	121	2006-931/1000-867	123	2006-8664	109	2016-402	174
2004-911/1000-542	121	2006-931/1099-541	123	2006-8671	109	2016-403	174
2004-911/1000-836	121	2006-931/1099-542	123	2006-8674	109	2016-404	174
2004-911/1000-867	121	2006-931/1099-836	123	2006-8691	172	2016-405	174
		2006-931/1099-859	123	2006-8692	172	2016-405/011-000	174
		2006-931/1099-867	123			2016-433	174
2004-1201	48	2006-991	172	<b>2007 Series</b>		2016-434	174
2004-1204	48	2006-992	172	2007-8442	118	2016-435	174
2004-1207	50			2007-8443	118	2016-499	173
2004-1211/1000-400	140	2006-1201	52	2007-8444	118		
2004-1211/1000-401	140	2006-1204	52	2007-8445	118	2016-511	159
2004-1291	169	2006-1207	53	2007-8446	112	2016-549	159
2004-1292	169	2006-1208	53	2007-8446	118		
2004-1293	169	2006-1291	171	2007-8447	118	2016-1201	56
2004-1294	169	2006-1292	171	2007-8448	118	2016-1204	56
		2006-1293	171			2016-1207	57
2004-1301	49	2006-1294	171	2007-8801	115	2016-1208	57
2004-1304	49			2007-8807	115	2016-1291	174
2004-1307	51	2006-1301	53	2007-8811	115	2016-1292	174
2004-1311/1000-400	141	2006-1304	53	2007-8821	114		
2004-1311/1000-401	141	2006-1307	53	2007-8873	116	2016-1301	57
2004-1391	169	2006-1391	171	2007-8876	116	2016-1304	57
2004-1392	170	2006-1392	171	2007-8891	118	2016-1307	57
2004-1393	170	2006-1393	171	2007-8892	118	2016-1391	174
2004-1394	170	2006-1394	171	2007-8893	118	2016-1392	174
				2007-8894	117		
2004-1401	49	2006-1601	99	2007-8894	118	2016-7111	243
2004-1404	49	2006-1604	99	2007-8899	118	2016-7114	243
2004-1407	51	2006-1611	104			2016-7192	251
2004-1408	51			<b>2009 Series</b>			
2004-1411/1000-400	141	2006-1611/1000-541	104	2009-110	783	2016-7601	244
2004-1411/1000-401	141	2006-1611/1000-542	104	2009-114	780	2016-7604	244
2004-1491	170	2006-1611/1000-836	104	2009-115	780	2016-7607	245
2004-1492	170	2006-1611/1000-867	104	2009-145	781	2016-7692	251
2004-1493	170	2006-1621	105	2009-174	781		
2004-1494	170	2006-1621/1000-541	105	2009-180	790	2016-7711	245
		2006-1621/1000-542	105	2009-182	175	2016-7714	245
		2006-1621/1000-836	105			2016-7792	251
		2006-1621/1000-859	105				
		2006-1621/1000-867	105	2009-304	252	<b>2020 Series</b>	
2005-7300	248	2006-1631	105	2009-305	252	2020-100	223
		2006-1631/099-000	106	2009-309	252	2020-102	189
2005-7640	241	2006-1631/1000-541	105	2009-310	252	2020-102/122-000	194
2005-7641	240	2006-1631/1000-542	105			2020-102/132-000	194
2005-7642	241	2006-1631/1000-836	105	2009-402	160	2020-102/142-000	194
2005-7649	241	2006-1631/1000-859	105	2009-404	160	2020-103	189
2005-7659	241	2006-1631/1000-867	105	2009-406	160	2020-103/000-036	190
2005-7692	249	2006-1631/1099-541	106	2009-412	162	2020-103/000-037	190
		2006-1631/1099-542	106	2009-414	162	2020-103/000-038	190
<b>2006 Series</b>		2006-1631/1099-836	106	2009-416	162	2020-103/000-039	190
2006-115	172						
2006-191	172						



Item No.	Page	Item No.	Page	Item No.	Page	Item No.	Page
<b>2020 Series</b>		<b>2020 Series</b>		<b>2020 Series</b>		<b>2020 Series</b>	
2020-103/122-000	194	2020-113/145-000	194	2020-209/134-000	196	2020-2217	185
2020-103/132-000	194	2020-114	189	2020-209/144-000	196	2020-2227	185
2020-103/142-000	194	2020-114/000-036	190	2020-210	189	2020-2231	184
2020-104	189	2020-114/000-037	190	2020-210/000-036	191	2020-2232	184
2020-104/000-036	190	2020-114/000-038	190	2020-210/000-037	191	2020-2233	184
2020-104/000-037	190	2020-114/000-039	190	2020-210/000-038	191	2020-2234	184
2020-104/000-038	190	2020-114/125-000	194	2020-210/000-039	191	2020-2237	185
2020-104/000-039	190	2020-114/135-000	194	2020-210/125-000	196	2020-2238	185
2020-104/124-000	194	2020-114/145-000	194	2020-210/135-000	196	2020-2239	185
2020-104/133-000	194	2020-115	189	2020-210/145-000	196	2020-2247	185
2020-104/143-000	194	2020-115/000-036	190	2020-211	189	2020-2257	185
2020-105	189	2020-115/000-037	190	2020-211/000-036	191	2020-2291	223
2020-105/000-036	190	2020-115/000-038	190	2020-211/000-037	191	2020-2292	223
2020-105/000-037	190	2020-115/000-039	190	2020-211/000-038	191		
2020-105/000-038	190	2020-115/125-000	194	2020-211/000-039	191	<b>2022 Series</b>	
2020-105/000-039	190	2020-115/135-000	194	2020-211/125-000	196	2022-100	226
2020-105/124-000	194	2020-115/145-000	194	2020-211/135-000	196	2022-101	207
2020-105/133-000	194	2020-161	192	2020-211/145-000	196	2022-101/000-006	207
2020-105/143-000	194	2020-164	192	2020-212	189	2022-101/000-012	207
2020-106	189	2020-167	192	2020-212/000-036	191	2022-101/000-016	207
2020-106/000-036	190	2020-181	192	2020-212/000-037	191	2022-101/122-000	212
2020-106/000-037	190	2020-184	192	2020-212/000-038	191	2022-101/122-006	212
2020-106/000-038	190	2020-187	192	2020-212/000-039	191	2022-101/122-016	212
2020-106/000-039	190			2020-212/125-000	196	2022-101/132-000	212
2020-106/124-000	194	2020-202	189	2020-212/135-000	196	2022-101/132-006	212
2020-106/133-000	194	2020-202/122-000	196	2020-212/145-000	196	2022-101/132-016	212
2020-106/143-000	194	2020-202/132-000	196	2020-213	189	2022-101/142-000	212
2020-107	189	2020-202/142-000	196	2020-213/000-036	191	2022-101/142-006	212
2020-107/000-036	190	2020-203	189	2020-213/000-037	191	2022-101/142-016	212
2020-107/000-037	190	2020-203/000-036	191	2020-213/000-038	191	2022-101/142-016	212
2020-107/000-038	190	2020-203/000-037	191	2020-213/000-039	191	2022-102	207
2020-107/000-039	190	2020-203/000-038	191	2020-213/125-000	196	2022-102/000-006	207
2020-107/124-000	194	2020-203/000-039	191	2020-213/135-000	196	2022-102/000-012	207
2020-107/134-000	194	2020-203/122-000	196	2020-213/145-000	196	2022-102/000-016	207
2020-107/144-000	194	2020-203/132-000	196	2020-214	189	2022-102/122-000	212
2020-108	189	2020-203/142-000	196	2020-214/000-036	191	2022-102/132-000	212
2020-108/000-036	190	2020-204	189	2020-214/000-037	191	2022-102/142-000	212
2020-108/000-037	190	2020-204/000-036	191	2020-214/000-038	191	2022-102/999-953	221
2020-108/000-038	190	2020-204/000-037	191	2020-214/000-039	191	2022-103	207
2020-108/000-039	190	2020-204/000-038	191	2020-214/125-000	196	2022-103/000-006	207
2020-108/124-000	194	2020-204/000-039	191	2020-214/135-000	196	2022-103/000-012	207
2020-108/134-000	194	2020-204/124-000	196	2020-214/145-000	196	2022-103/000-036	208
2020-108/144-000	194	2020-204/133-000	196	2020-215	189	2022-103/000-037	208
2020-109	189	2020-204/143-000	196	2020-215/000-036	191	2022-103/000-038	208
2020-109/000-036	190	2020-205	189	2020-215/000-037	191	2022-103/000-038/999-953	221
2020-109/000-037	190	2020-205/000-036	191	2020-215/000-038	191	2022-103/000-039	208
2020-109/000-038	190	2020-205/000-037	191	2020-215/000-039	191	2022-103/000-039/999-953	221
2020-109/000-039	190	2020-205/000-038	191	2020-215/125-000	196	2022-103/123-000	212
2020-109/124-000	194	2020-205/000-039	191	2020-215/135-000	196	2022-103/133-000	212
2020-109/134-000	194	2020-205/124-000	196	2020-215/145-000	196	2022-103/143-000	212
2020-109/144-000	194	2020-205/133-000	196	2020-261	192	2022-103/999-953	221
2020-110	189	2020-205/143-000	196	2020-264	192	2022-104	207
2020-110/000-036	190	2020-206	189	2020-267	192	2022-104/000-006	207
2020-110/000-037	190	2020-206/000-036	191	2020-281	192	2022-104/000-012	207
2020-110/000-038	190	2020-206/000-037	191	2020-284	192	2022-104/000-036	208
2020-110/000-039	190	2020-206/000-038	191	2020-287	192	2022-104/000-037	208
2020-110/125-000	194	2020-206/000-039	191			2022-104/000-038	208
2020-110/135-000	194	2020-206/124-000	196	2020-1201	180	2022-104/000-038/999-953	221
2020-110/145-000	194	2020-206/133-000	196	2020-1204	180	2022-104/000-039	208
2020-111	189	2020-206/143-000	196	2020-1207	182	2022-104/000-039/999-953	221
2020-111/000-036	190	2020-207	189	2020-1291	223	2022-104/123-000	212
2020-111/000-037	190	2020-207/000-036	191	2020-1292	223	2022-104/133-000	212
2020-111/000-038	190	2020-207/000-037	191			2022-104/143-000	212
2020-111/000-039	190	2020-207/000-038	191	2020-1301	181	2022-104/999-953	221
2020-111/125-000	194	2020-207/000-039	191	2020-1304	181	2022-105	207
2020-111/135-000	194	2020-207/124-000	196	2020-1307	183	2022-105/000-006	207
2020-111/145-000	194	2020-207/134-000	196	2020-1391	223	2022-105/000-012	207
2020-112	189	2020-207/144-000	196	2020-1392	223	2022-105/000-036	208
2020-112/000-036	190	2020-208	189			2022-105/000-037	208
2020-112/000-037	190	2020-208/000-036	191	2020-1401	181	2022-105/000-038	208
2020-112/000-038	190	2020-208/000-037	191	2020-1404	181	2022-105/000-038/999-953	221
2020-112/000-039	190	2020-208/000-038	191	2020-1407	183	2022-105/000-039	208
2020-112/125-000	194	2020-208/000-039	191	2020-1491	223	2022-105/000-039/999-953	221
2020-112/135-000	194	2020-208/124-000	196	2020-1492	223	2022-105/123-000	212
2020-112/145-000	194	2020-208/134-000	196			2022-105/134-000	212
2020-113	189	2020-208/144-000	196	2020-2201	184	2022-105/144-000	212
2020-113/000-036	190	2020-209	189	2020-2202	184	2022-105/999-953	221
2020-113/000-037	190	2020-209/000-036	191	2020-2203	184	2022-106/000-006	207
2020-113/000-038	190	2020-209/000-037	191	2020-2204	184	2022-106/000-012	207
2020-113/000-039	190	2020-209/000-038	191	2020-2207	185	2022-106/000-036	208
2020-113/125-000	194	2020-209/000-039	191	2020-2208	185	2022-106/000-037	208
2020-113/135-000	194	2020-209/124-000	196	2020-2209	185	2022-106/000-038	208

## Item Number Index

Item No.	Page	Item No.	Page	Item No.	Page	Item No.	Page
<b>2022 Series</b>		<b>2022 Series</b>		<b>2022 Series</b>			
2022-106/000-038/999-953	221	2022-114/000-036	208	2022-2239	203		
2022-106/000-039	208	2022-114/000-037	208	2022-2247	203		
2022-106/000-039/999-953	221	2022-114/000-038	208	2022-2257	203		
2022-106/123-000	212	2022-114/000-039	208	2022-2291	226		
2022-106/134-000	212	2022-114/126-000	212	2022-2292	226		
2022-106/144-000	212	2022-114/136-000	212				
2022-106/999-953	221	2022-114/146-000	212	<b>2273 Series</b>			
2022-107	207	2022-115	207	2273-202	720		
2022-107/000-006	207	2022-115/000-006	207	2273-203	721		
2022-107/000-012	207	2022-115/000-012	207	2273-204	721		
2022-107/000-036	208	2022-115/000-036	208	2273-205	721		
2022-107/000-037	208	2022-115/000-037	208	2273-208	722		
2022-107/000-038	208	2022-115/000-038	208				
2022-107/000-039	208	2022-115/000-039	208	2273-500	723		
2022-107/123-000	212	2022-115/127-000	212				
2022-107/135-000	212	2022-115/137-000	212				
2022-107/144-000	212	2022-115/147-000	212				
2022-107/999-953	221	2022-141	227				
2022-108	207	2022-142	227				
2022-108/000-006	207	2022-151	227				
2022-108/000-012	207	2022-152	227				
2022-108/000-036	208	2022-161	210				
2022-108/000-037	208	2022-162	210				
2022-108/000-038	208	2022-164	210				
2022-108/000-039	208	2022-167	210				
2022-108/123-000	212	2022-171	210				
2022-108/135-000	212	2022-172	210				
2022-108/145-000	212	2022-174	210				
2022-108/999-953	221	2022-177	210				
2022-109	207	2022-181	210				
2022-109/000-006	207	2022-182	210				
2022-109/000-012	207	2022-184	210				
2022-109/000-036	208	2022-187	210				
2022-109/000-037	208						
2022-109/000-038	208	2022-1201	198				
2022-109/000-039	208	2022-1201/999-953	214				
2022-109/123-000	212	2022-1202	198				
2022-109/135-000	212	2022-1204	198				
2022-109/145-000	212	2022-1204/999-953	214				
2022-110	207	2022-1207	200				
2022-110/000-006	207	2022-1207/999-953	216				
2022-110/000-012	207	2022-1291	226				
2022-110/000-036	208	2022-1292	226				
2022-110/000-037	208						
2022-110/000-038	208	2022-1301	199				
2022-110/000-039	208	2022-1301/999-953	215				
2022-110/123-000	212	2022-1302	199				
2022-110/135-000	212	2022-1304	199				
2022-110/145-000	212	2022-1304/999-953	215				
2022-111	207	2022-1307	201				
2022-111/000-006	207	2022-1307/999-953	217				
2022-111/000-012	207	2022-1391	226				
2022-111/000-036	208	2022-1392	226				
2022-111/000-037	208						
2022-111/000-038	208	2022-1401	199				
2022-111/000-039	208	2022-1401/999-953	215				
2022-111/125-000	212	2022-1402	199				
2022-111/136-000	212	2022-1404	199				
2022-111/146-000	212	2022-1404/999-953	215				
2022-112	207	2022-1407	201				
2022-112/000-006	207	2022-1407/999-953	217				
2022-112/000-012	207	2022-1491	226				
2022-112/000-036	208	2022-1492	226				
2022-112/000-037	208						
2022-112/000-038	208	2022-2201	202				
2022-112/000-039	208	2022-2201/999-953	218				
2022-112/126-000	212	2022-2202	202				
2022-112/136-000	212	2022-2203	202				
2022-112/146-000	212	2022-2204	202				
2022-113	207	2022-2207	203				
2022-113/000-006	207	2022-2207/999-953	219				
2022-113/000-012	207	2022-2208	203				
2022-113/000-036	208	2022-2209	203				
2022-113/000-037	208	2022-2217	203				
2022-113/000-038	208	2022-2227	203				
2022-113/000-039	208	2022-2231	202				
2022-113/126-000	212	2022-2232	202				
2022-113/136-000	212	2022-2233	202				
2022-113/146-000	212	2022-2234	202				
2022-114	207	2022-2234/999-953	219				
2022-114/000-006	207	2022-2237	203				
2022-114/000-012	207	2022-2238	203				

Item No.	Page	Item No.	Page	Item No.	Page	Item No.	Page

## WAGO Worldwide Companies and Representatives

- Algeria**  
please contact WAGO France
- Argentina**  
Bruno Schillig S.A.  
Arenales 4030, B1604CFD  
Florida, PBA  
Phone +54 11 4730 1100  
Fax +54 11 4761 7244  
wago@schillig.com.ar
- Austria**  
WAGO Kontakttechnik Ges.m.b.H.  
Europaring F15 602  
Campus 21  
2345 Brunn am Gebirge  
Phone +43 1 6150780  
Fax +43 1 6150775  
wago-at@wago.com
- Azerbaijan**  
AZ Technics LTD  
Zulfi V. Alizade  
Y.Safarov str.33, AZ1025,  
Baku  
Republic of Azerbaijan  
Phone +994 12 496 8335  
Fax +994 12 496 8334  
info@AZtechnics.az
- Australia**  
WAGO Pty. Ltd.  
2-4 Overseas Drive  
Noble Park Victoria 3174  
Phone +61 03 8791 6300  
Fax +61 03 9701 0177  
sales.anz@wago.com
- Bangladesh**  
please contact WAGO India
- Belarus**  
OOO FEK  
pr-t Pushkina 29-B  
220015 Minsk  
Phone +375 17 2102189  
Fax +375 17 2102189  
wago@fek.by
- UP ATAVA  
ul. Denisovskaya, 47, office 1  
220006 Minsk  
Phone +375 17 2054015  
Fax +375 17 2851759
- Belgium**  
WAGO BeLux nv  
Excelsiorlaan 11  
1930 Zaventem  
Phone +32 2 717 9090  
Fax +32 2 717 9099  
info-be@wago.com
- Bolivia**  
ISOTEK S.R.L.  
Zona Casco Viejo  
Calle Isso #578, B/San Roque  
Santa Cruz  
Phone +591 721 000 27
- Bosnia and Herzegovina**  
please contact WAGO Bulgaria
- Brazil**  
WAGO Eletroeletrônicos Ltda  
Rua Américo Simões 1470  
São Roque da Chave  
Itupeva SP Brasil 13295-000  
Phone +55 11 4591 0199  
Fax +55 11 4591 0190  
info.br@wago.com
- Bulgaria**  
WAGO Kontakttechnik GmbH & Co.  
KG/  
Representative Office Sofia  
Business Center Serdika  
2E Akad. Ivan Geshov Blvd.  
Building 1, Floor 4, Office 417  
1330 Sofia  
Phone +359 2 489 46 09/10  
Fax +359 2 928 28 50  
info-BG@wago.com
- Canada**  
please contact WAGO USA
- Chile**  
Desimat Chile  
Av Puerto Vespuccio 9670  
Pudahuel Santiago  
Phone +56 2 747 0152  
Fax +56 2 747 0153  
ventaschile@desimat.cl
- China**  
WAGO ELECTRONIC (TIANJIN) Co. LTD  
No.5, Quan Hui Road  
Wuqing Development Area  
Tianjin 301700  
Phone +86 22 5967 7688  
Fax +86 22 5961 7668  
info-cn@wago.com
- Colombia**  
T.H.L. Ltda.  
Cra. 49 B # 91-33  
Bogotá  
Phone +57 1 621 85 50  
Fax +57 1 621 60 28  
ventas-thl@thl-ltada.com
- Croatia**  
M.B.A. d.o.o.  
Frana Supila 5  
51211 Matulji  
Phone +385 51 275-736  
Fax +385 51 275-066  
mba@ri.htnet.hr
- MICROSTAR d.o.o.  
Siget 18 b  
10020 Zagreb  
Phone +385 1 3647 849  
Fax +385 1 3636 662  
wago@microstar.hr
- Czech Republic**  
WAGO Elektro spol. sr. o.  
Rozvodova 1116/36  
143 00 Praha 4 - Modřany  
Phone +420 261 090 143  
Fax +420 261 090 144  
info.cz@wago.com  
wago-cz@wago.com
- Denmark**  
WAGO Denmark A/S  
Lejrvej 17  
3500 Værløse  
Phone +45 44 357 777  
info.dk@wago.com
- Egypt**  
IBN Engineering Instrumentation &  
Control  
71 a El Shaheed Ahmed Hamdi St.  
King Faisal, Giza  
Phone +20 2 721 4350  
Fax +20 2 722 1709  
sales@ibnengineering.com
- Ecuador**  
ECUAINSETEC CIA LTDA  
Yugoslavia N34-110 y Azuay  
Quito  
Phone +593 2 24 50 475  
Fax +593 2 22 51 242  
g.castro@ecuainsetec.com.ec
- Estonia**  
Eltarko OÜ  
Laki 14 - 502  
10621 Tallinn  
Phone +372 651 7731  
Fax +372 651 7786  
andres@eltarko.ee
- Finland**  
WAGO Finland Oy  
Vellamonkatu 30 B  
00550 Helsinki  
Phone +358 9 7744 060  
Fax +358 9 7744 0660  
tilaus@wago.fi
- France**  
WAGO Contact SAS  
Paris Nord 2  
83 Rue des Chardonnerets  
B.P. 55065 - Tremblay en France  
95947 - ROISSY CDG CEDEX  
Phone +33 1 4817 2590  
Fax +33 1 4863 2520  
info-fr@wago.com
- Germany**  
WAGO Kontakttechnik GmbH & Co. KG  
Postfach 28 80, 32385 Minden  
Hansastraße 27  
32423 Minden  
Phone +49 571 887-0  
Fax +49 571 887-844169  
info@wago.com
- Germany**  
WAGO Kontakttechnik GmbH & Co. KG  
Waldstraße 1  
99706 Sondershausen  
Phone +49 3632 659-0  
Fax +49 3632 659-100  
info@wago.com
- Great Britain**  
WAGO Limited  
Triton Park, Swift Valley Industrial  
Estate  
RUGBY  
Warwickshire, CV21 1SG  
Phone +44 1788 568 008  
Fax +44 1788 568 050  
uksales@wago.com
- Greece**  
PANAGIOTIS SP. DIMOULAS - BIOMAT  
DIMOULAS AUTOMATIONS  
Kritis Str. 26  
10439 Athen  
Phone +30 210 883 3337  
Fax +30 210 883 4436  
wago.info@dimoulas.com.gr
- Honduras**  
CILASAS S.A. de C.V.  
Barrio Los Andes  
7 Calle entre 14 y 15 Ave. N.O.  
P.O. Box. 1061  
San Pedro Sula  
Phone +504 2557 1146/7  
Fax +504 2557 1149
- Hong Kong**  
National Concord Eng., Ltd.  
Unit A-B, 5/F.  
Southeast Industrial Building  
611-619 Castle Peak Road  
Tsuen Wan, N.T.  
Phone +852 2429 2611  
Fax +852 2429 2164  
sales@nce.com.hk
- Hungary**  
WAGO Hungária KFT  
Ipari Park, Gyár u. 2  
2040 Budapest  
Phone +36 23 502-170  
Fax +36 23 502-166  
info.hu@wago.com
- Iceland**  
S. Gudjonsson ehf.  
Audbrekku 9-11  
202 Kopavogur  
Phone +354 520-4500  
Fax +354 520-4501  
export@wago.com
- India**  
WAGO Private Limited  
C-27, Sector-58, Phase-III  
Noida-201 301  
Gautam Budh Nagar (U.P)  
Phone +91 120 438 8700  
Fax +91 120 438 8799  
info.india@wago.com
- Indonesia**  
please contact WAGO Singapore
- Iraq**  
please contact WAGO Middle East
- Ireland**  
Drives & Controls  
Unit F4, Riverview Business Park  
Nangor Road  
Dublin 12  
Phone +353 1 4604474  
Fax +353 1 4604507  
wago@drivesandcontrols.ie
- Israel**  
Comtel Israel Electronic Solutions Ltd.  
Bet Hapaamon  
20 Hataas Street  
P.O. Box 66  
44425 Kefar-Saba  
Phone +972 9 76 77 240  
Fax +972 9 76 77 243  
sales@comPhoneco.il
- Italy**  
WAGO ELETTRONICA SRL a Socio  
Unico  
Via Parini 1  
40033 Casalecchio di Reno (BO)  
Phone +39 051 6132112  
Fax +39 051 6272174  
info-ita@wago.com
- Japan**  
WAGO Co. of JAPAN Ltd.  
Kinshicho Prime Tower  
5-7, Kameido, Koto-Ku  
Tokyo 136-0071  
Phone +81 3 5627 2059  
Fax +81 3 5627 2055  
info-jp@wago.com
- Jordan**  
please contact WAGO Middle East
- Kazakhstan**  
TOO INTANT  
232/2, Ryskulov avenue  
050061 Almaty  
Phone +7 727 356 52 91/92/93  
Fax +7 727 327 14 92/93  
ee@intant.net  
ees\_sm1@intant.net
- TOO Technik-Trade  
ul. i. A. Protosanova, 81  
070004 Ust-Kamenogorsk  
Phone +7 7232 254 064  
Fax +7 7232 253 251  
info@technik.kz
- Korea**  
WAGO Korea Co., Ltd.  
Room 205 AnyangMegaValley,  
268, Hagui-ro, Dongan-gu, Anyang-si,  
Gyeonggi-do, 14056, South Korea  
Phone +82 31 421 9500  
info.korea@wago.com
- Kosovo**  
please contact WAGO Bulgaria
- Latvia**  
INSTABALT LATVIA SIA  
Vestienas iela 6  
Riga, LV-1035  
Phone +371 790 1188  
Fax +371 790 1180  
info@instabalt.lv
- Lebanon**  
Gemayel Trading & Contracting  
Antonins Project  
P.O. BOX 70-1096  
Antelias  
Lebanon  
Phone +961 4 521 029  
Fax +961 4 521 029  
info@uae.com
- Lithuania**  
INSTABALT LIT UAB  
Savanorių 187  
Vilnius, 2053  
Phone +370 52 322 295  
Fax +370 52 322 247  
info@instabalt.lt
- Luxembourg**  
please contact WAGO Belgium
- Macedonia**  
please contact WAGO Bulgaria
- Kompjunet Inzenering  
Vladimir Komarov 1A-3/9  
1000 Skopje  
Republic of Macedonia  
Phone +389 2 521 12 00  
Phone +389 2 246 11 08
- Malaysia**  
WAGO Representative Office Malaysia  
No 806, Block A4, Leisure Commerce  
Square,  
No 9, Jalan PJS 8/9, 46150 Petaling  
Jaya,  
Selangor Darul Ehsan, Malaysia  
Phone +60 3 7877 1776  
Fax +60 3 7877 2776  
kian.guan.tan@wago.com
- HPH Materials (M) Sdn Bhd  
No. 4, Jalan Nilam 1/6  
Suban Hi-Tech Industrial Park  
40000 Shah Alam  
Selangor, D.E. Malaysia  
Phone +60 3 5638 2213  
Fax +60 3 5638 8213  
info@hphmaterials.com
- Maldives**  
please contact WAGO India

**Mexico**

WAGO SA de CV  
Av. Del Marques 38 Bodega 3  
P. I. Bernardo Quintana  
76246 El Marques, Querétaro  
Phone +52 442 221 5946  
Fax +52 442 221 5063  
info.mx@wago.com

**Moldova**

Electroservice Slavinski T.T.  
str. Bolgarskaia 9, office 6  
2001 Kishinev  
Phone +373 22 274427  
Fax +373 22 224481  
es@es.mldnet.com

**Morocco**

Automatisme & Connection Maroc  
23, Rue Bourred, 2ème étage, appt4  
Roche Noire  
20300 Casablanca  
Phone +212 522 24 21 72/73  
Fax +212 522 24 21 75  
info-fr@wago.com

**Nepal**

please contact WAGO India

**Netherlands**

WAGO Nederland BV.  
Laan van de Ram 19  
7234 BW APELDOORN  
Phone +31 55 36 83 500  
Fax +31 55 36 83 599  
info-nl@wago.com

**New Zealand**

please contact WAGO Australia

**NHP NZ**

7 Lockhart Place  
Mt Wellington  
New Zealand  
Phone +64 9 2761967  
Fax +64 9 2761992  
export@wago.com

**Nigeria**

GIL Automations Ltd.  
Daily Times Complex  
2 Lateef Jakande Rd., Agidingbi  
100271 Ikeja, Lagos State  
Phone +234 17132672335  
sales@gilautomation.com

**Norway**

WAGO Norge AS  
Jerikoveien 20  
1067 Oslo  
Phone +47 22 30 94 50  
Fax +47 22 30 94 51  
info.no@wago.com

**Oman**

please contact WAGO Middle East

**Pakistan**

FuziLogiX Automation & Control  
Suit No. 14, 5th Floor, Shan Arcade  
New Garden Town, Lahore  
Pakistan  
Phone +92 42 594 1503 - 4  
Fax +92 42 585 1431  
info@fuzilogix.com

**Paraguay**

AESA  
Av. Madame Lynch  
c/Antolin Irala  
2309 Asunción  
Tel. +59 521674524  
info@aesa.com.py

**Peru**

Manufacturas Eléctricas S.A.  
Av O.R. Benavides 1215  
15000 Lima  
Phone +511 6196200  
Fax +511 6196247

**Philippines**

please contact WAGO Singapore

**Poland**

WAGO ELWAG sp. z o. o.  
ul. Piekna 58 a  
50-506 Wrocław  
Phone +48 71 3602970  
Fax +48 71 3602999  
wago.elwag@wago.com

**Portugal**

MORGADO & CA. LDA - SEDE  
Estrada Exterior da  
Circunvalação 3558/3560  
Apartado 1057  
4435 Rio Tinto  
Phone +351 22 9770600  
Fax +351 22 9770699  
geral@morgadocl.pt

**Quatar**

please contact WAGO Middle East

**Romania**

WAGO Kontakttechnik GmbH & Co. KG  
Representative Office Romania  
Sos. Pipera-Tunari nr. 1/1  
building 1, 2nd floor  
077190 Voluntari, Ilfov  
Tel. +40-(0)31 421 85 68  
info-RO@wago.com

**VDR & Servicii srl**

Str. Valeriu Braniște, nr. 60, ap.1, sector 3  
Romania  
Phone +40 21 3225074/76  
Fax +40 21 3225075  
office@componente-automatizari.ro

**Russia**

OOO WAGO Contact Rus  
Dmitrovskoe shosse, 157,  
bldg. 12/5  
127411 Moscow  
Russia  
Phone +7 495 663-3305  
Fax +7 495 663-3308  
info.ru@wago.com

**OOO Decima**

Projesd 4922, d. 4, str. 1  
124460 Moscow / Selenograd  
Phone +7 495 988 4858  
Fax +7 495 988 4858

**OOO Prosoft**

ul. Profsoznaya, 108  
117437 Moscow  
Phone +7 495 2340636  
Fax +7 495 2340640  
info@prosoft.ru

**ITC Electronics: Moscow**

Radio str. 24  
105005 Moscow  
Phone +7 495 775 1845  
Fax +7 495 775 1848  
moscow@itc-electronics.com

**WAGO Branch office**

Ekaterinburg  
Phone +7 343 216 3426

**WAGO Branch office**

Novosibirsk  
Phone +7 383 217 9244

**WAGO Branch office**

St. Petersburg  
Phone +7 812 312 1918

**Saudi Arabia**

Saudi Electronic Trading Company  
(SETRA), P.O. Box 60712  
11555-Riyadh  
Phone +966 1 2062277  
Fax +966 1 2062277  
khaled.wafai@setra.com.sa

**Serbia**

please contact WAGO Bulgaria

**Avalon Partners doo**

Patrijarha Dimitrija 24  
11000 Beograd  
Phone +381 11 268 5311  
Fax +381 11 268 5311  
office@avalon.rs

**Sigma doo**

Balzakova 3  
21000 Novi Sad  
Phone +381 21 468 431  
Fax +381 21 636 1785  
office@sigmadoo.co.rs

**Singapore**

WAGO Electronic Pte Ltd  
No. 10 Upper Aljunied Link #04-04  
Singapore 367904  
Phone +65 62866776  
Fax +65 62842425  
info-sing@wago.com

**Slovakia**

Proelektr spol. s r.o.  
Na barine 22  
841 03 Bratislava - Lamač  
Phone +421 2 4569 2503  
info@wago.sk

**Slovenia**

IC elektronika d.o.o.  
Vodovodna cesta 100  
1000 Ljubljana  
Phone +386 1568 0126  
Fax +386 1568 9107  
info@ic-elect.si

**GENERA d.o.o.**

Prevala 10  
1236 Trzin  
Phone +386 14393050  
Fax +386 14393090  
genera@genera.si

**Slovenia**

Elektronabava d.o.o.  
Cesta 24 junija 3  
1231 Ljubljana  
Phone +386 1 58 99 300  
Fax +386 1 58 99 409  
info@elektronabava.si

**South Africa**

Shorrock Automation (Pty) Ltd  
Postnet Suite # 219  
Private Bag X 8, Elardus Park  
0047 PRETORIA  
Phone +27 12 4500300  
Fax +27 12 4500322  
sales@shorrock.co.za

**Spain**

DICOMAT S.L.  
Avda. de la Industria, 36  
Apartado Correos, 1.178  
28108-Alcobendas (Madrid)  
Phone +34 91 662 1362  
Fax +34 91 661 0089  
info@dicomat.com

**Sweden**

WAGO Sverige AB  
Tyskland Filial  
Box 11 1127, 161 11 BROMMA  
Besöksadress: Adolfsbergsv. 31  
Phone +46 858410680  
Fax +46 858410699  
info.se@wago.com

**Switzerland**

WAGO CONTACT SA  
Rte. de l'Industrie 19  
Case Postale 168  
1564 Domdidier  
Phone +41/26 676 75 00  
Fax +41/26 676 75 01  
info.switzerland@wago.com

**Sri Lanka**

please contact WAGO India

**Syria**

Zahabi Co.  
8/5 Shouhadaa St., P.O. Box 8262  
Aleppo  
Phone +963 21 22 235 / 6  
Fax +963 21 22 23 7  
info.uae@wago.com

**Taiwan R.O.C.**

WAGO Contact, Ltd.  
5F., No.168, Jiankang Rd  
Zhonghe City  
Taipei County 23585, Taiwan  
Phone +886 2 2225 0123  
Fax +886 2 2225 1511  
info.taiwan@wago.com

**Thailand**

WAGO Representative Office Thailand  
4th Floor, KS Building  
213/6-8 Rachada-Phisek Road  
Dingdaeng, Bangkok 10400  
Phone +66 2 6935611  
Fax +66 2 6935612  
warongkon.khankham@wago.com

**US Power Distribution Co., Ltd.**

4th Floor, KS Building  
213/6-8 Rachada-Phisek Road  
Dingdaeng, Bangkok 10400  
Phone +66 2 2763040  
Fax +66 2 2763049  
uspowers2014@gmail.com

**Thailand**

Itthirrit Technology Co., Ltd.  
Vision Business Park 2 Floor 4  
Soi Raminthra 55/8, Watcharapon Road  
Tharaeng, Bangkok District  
Bangkok Thailand 10220  
Tel. +66 2 347 0780  
Fax +66 2 347 0772  
sales@itthirrittechnology.com

**Tunisia**

please contact WAGO France

**Turkey**

WAGO Elektronik Sanayi ve Ticaret  
Ltd. Şti.  
Yukan Dudullu Mahallesi Bayraktar  
Bulvarı  
Cad. Hattat Sok. No. 10  
34775 Umraniye - Istanbul  
Phone +90 216 472 1133  
Fax +90 216 472 9910  
info.tr@wago.com

**Ukraine**

NPP Logicon  
Predslavinskaya street, 39, office 303  
03150 Kiev  
Phone +380 44 5228019  
Fax +380 44 2611803  
info@logicon.ua

**OOO Micropribor**

ul. Kotelnikova, 4  
03115 Kiev  
Phone +380 44 5369386  
Fax +380 44 5369387  
sales@micropribor.kiev.ua

**United Arab Emirates (UAE)**

WAGO Middle East (FZC)  
SAIF Zone, Q4-282  
P.O. Box 120665  
Sharjah, UAE  
Phone +971 6 5579920  
Fax +971 6 5579921  
info.uae@wago.com

**Uruguay**

Fivisa Electricidad  
Avda. Uruguay 1274  
11100 Montevideo  
Phone +59 829 020 808  
Fax +59 829 021 230  
info@fivisa.com.uy

**USA**

WAGO CORPORATION  
N120 W19129 Freistadt Road  
Germantown, WI 53022  
Phone +1 262 255 6222  
Fax +1 262 255 3232  
Toll-Free: 1-800 DIN Rail (346-7245)  
info.us@wago.com

**Venezuela**

PETROBORNAS S.A.  
C.C. PLAZA AEROPUERTO - PISO 1 -  
LOCAL P1-B-03  
(8015) UNARE - PUERTO ORDAZ -  
ESTADO BOLÍVAR  
REPÚBLICA BOLIVARIANA DE  
VENEZUELA  
Phone +58 286 951 3382  
Fax +58 286 951 3382  
info@petrobornas.com

**Vietnam**

please contact WAGO Germany  
(Minden)











**WAGO Kontakttechnik GmbH & Co. KG**

Postfach 2880 · D · 32385 Minden  
Hansastraße 27 · D · 32423 Minden  
info@wago.com  
www.wago.com

Headquarters	+49 571 887 - 0
Sales	+49 571 887 - 44222
Order Service	+49 571 887 - 44333
Fax	+49 571 887 - 844169