

## Smart camera IVC-3D

A 3D smart camera for stand-alone solutions  
in factory automation

# IVC-3D smart camera: Stand-alone solution in factory automation

## IVC-3D Applications



### Increase yield and quality with true 3D shape inspection

#### The first 3D smart camera in the world!

The real world has three dimensions and therefore traditional 2D camera solutions will always be a compromise in applications where height matters. The IVC-3D is the first smart camera in the world that is designed to inspect and measure in three dimensions. With IVC-3D's tools, designed to measure height, volume, shape and profiles, 3D applications are easily turned into robust solutions.

#### A self-contained camera

The IVC-3D is a self-contained factory-calibrated smart camera that combines imaging, lighting and analysis into one camera housing. When your application needs measurement or verification of non-flat dimensions, a smart camera that highlights height differences in the captured image is preferable compared to traditional two-dimensional imaging.

#### Easy PC configuration and stand-alone operation

The IVC-3D is a smart camera in every aspect: easy configuration via a PC user interface, a set of image processing tools, and easy connection via I/O, serial and Ethernet interface. After programming it operates stand-alone or as part of the factory network. The inspection result can be sent directly to a PLC or handling equipment and be monitored for example via Ethernet. The 3D image is scanned while the object passes the IVC-3D on the conveyor belt.

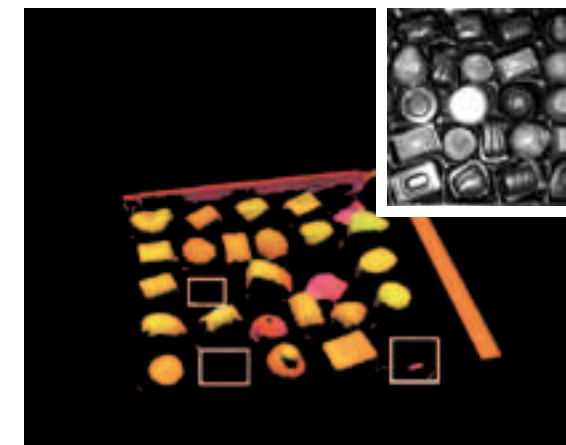
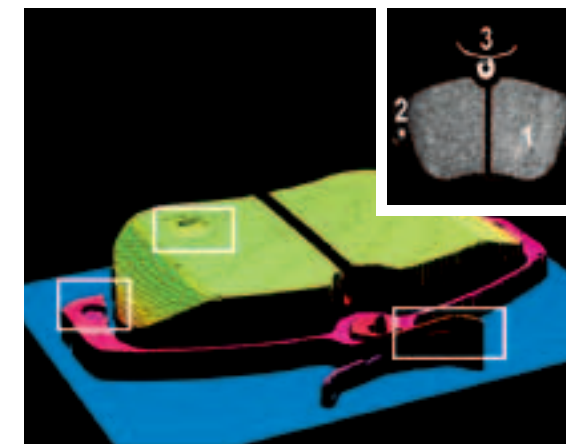

#### IVC-3D is the key to true shape inspection

The break pad application is an example of several inspections in one single shot:

- Surface defects
- Height position of the plug
- Angle of the metallic spring

Features like these are very difficult to detect in a conventional 2D image. With IVC-3D however the application is quickly developed in the graphical IVC Studio user interface.

#### Contrast-independent inspection by 3D measurement

The verification of praline box content requires a system that can check dark objects on a dark background. 3D is superior when there is low contrast. The praline application is an example of:

- Correct 3D shape inspection
- Verification of individual praline position
- Missing praline detection by robust height measurement

#### Calibrated 3D inspection at production speeds

The factory calibrated IVC-3D enables in-line inspection also of continuous material flow. Special tools for height profile analysis make the solution accurate and fast. Verification of material position and product quality is done simultaneously with one standalone smart camera.

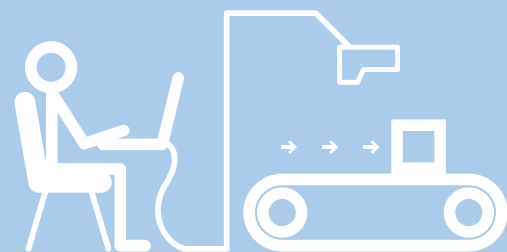
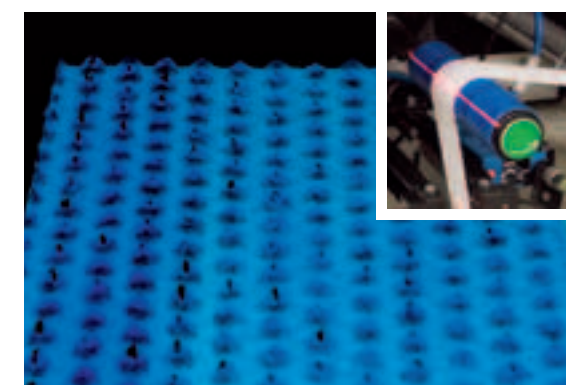

Development

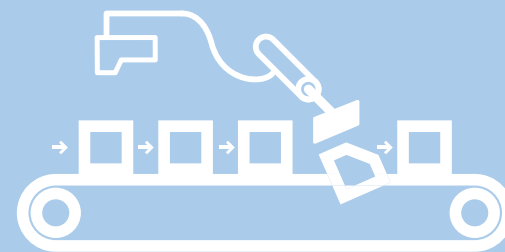

Production

## Easy capturing of 3D images

The IVC-3D is based on a unique CMOS chip optimized for 3D imaging using a laser and fast data processing. The third dimension is determined by triangulation; The laser draws a line on the object and the camera, which is viewing this line from an angle, sees a curve that follows the height profile of the object. As the object passes under the laser beam a three-dimensional image is built up. The field-of-view, imaging accuracy, resolution and image capture rate are dependent on the camera type and can be optimized in the measurement set-up for each application.

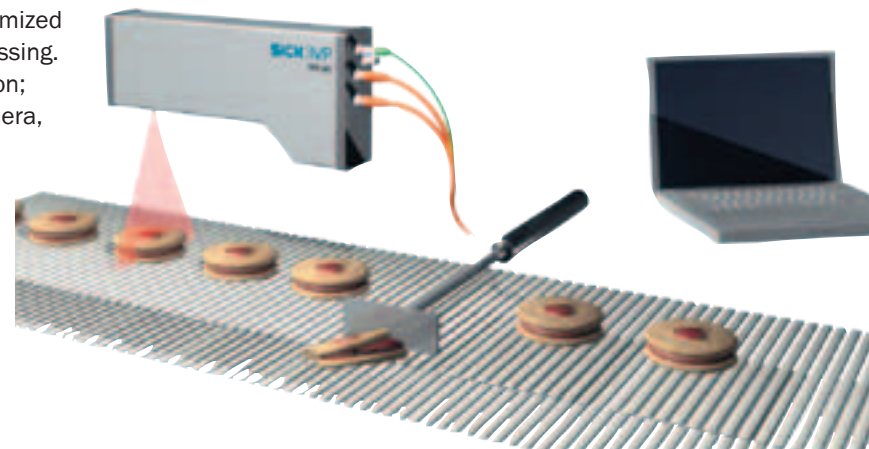

### Real measurements in calibrated units

The IVC-3D is factory calibrated and outputs millimeter units by default. The height values are always given in millimeter, but the length and width values can be given also in numbers of pixels. To ensure accurate length measurements, the camera automatically compensates a varying conveyor speed if it is connected to an encoder. The encoder input is compatible with RS-422 and includes support for both forward and backward movement.

### Overlapping images

When a continuous flow of products is inspected, there is a risk that some products are only partially scanned in one image whereas the remaining parts appear in the next. The IVC-3D takes care of this by overlapping images, thus ensuring that each item is fully scanned in at least one image and none is left unanalysed.

### Image capture

The IVC-3D can either work on single profiles or on 3D images. The number of profiles defines the image size and thereby sets the maximum length of an object in the moving direction. The 3D image rate depends on the profile rate and the analysis speed.

### Built-in triggering

Image triggering possibilities are built-in to the image grab software. A simple lightswitch is easily connected to the triggering input of the camera thus ensuring repeatable images of the objects passing by.

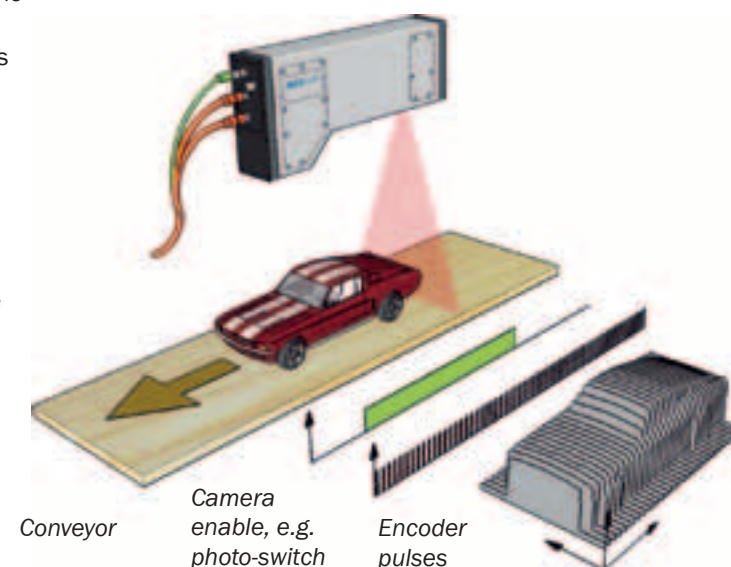

Conveyor  
Camera enable, e.g. photo-switch  
Encoder pulses

### Benefits

- Reliable measurements also when the object has the same color as the background
- Choice of field-of-views: IVC-3D 30, IVC-3D 50, IVC-3D 100, IVC-3D 200 and IVC-3D 300
- Short development time with IVC Studio graphical user interface
- Easy encoder connection
- True millimeter values are directly available as the IVC-3D is factory calibrated
- Robust housing made for industrial environments and IP 65 classified

## Field of view

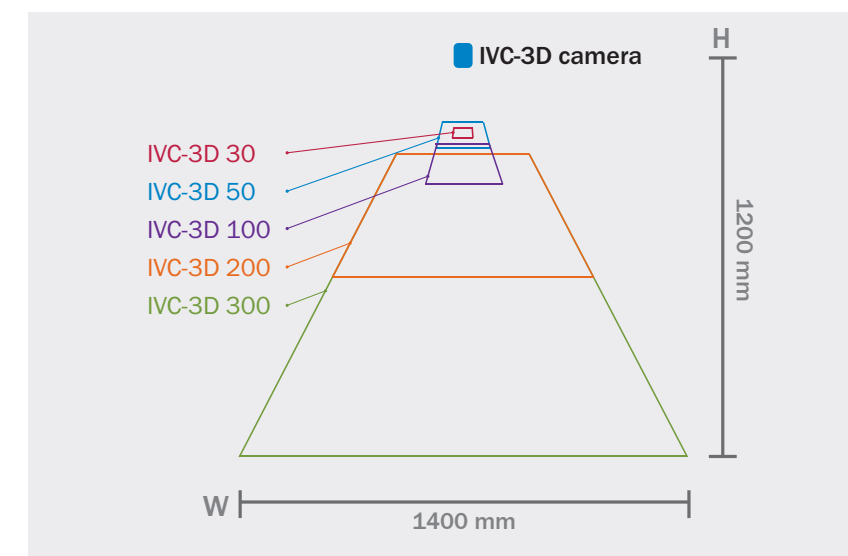

The field of view (FOV) is a trapezoid-shaped area in which the object must fit. This means that there is a relation between the object's maximum height, width and its distance from the camera. To optimize the image capturing speed, the dimensions of the FOV can be customized to fit a certain object. The distance between the camera and the upper part of the FOV is called the stand-off, and for each camera type there is a specified min. stand-off.

### Measurement details

	IVC-3D 30	IVC-3D 50	IVC-3D 100	IVC-3D 200	IVC-3D 300
Example FOV <sup>1)</sup>	30 mm x 50 mm	50 mm x 150 mm	100 x 200 mm	200 mm x 600 mm	300 mm x 1000 mm
Max height range	31 mm	84 mm	140 mm	375 mm	920 mm
Width at max working distance <sup>2)</sup>	60 mm	185 mm	260 mm	830 mm	1400 mm
Robust method	1024 points	1024 points	1024 points	1024 points	700 points
High resolution method	2048 points	2048 points	2048 points	2048 points	700 points
Max profile width	2048 points	2048 points	2048 points	2048 points	1400 points
Min working distance <sup>2)</sup>	207 mm	190 mm	260 mm	300 mm	280 mm
Height resolution <sup>3)</sup>	0.015 mm	0.04 mm	0.05 mm	0.2 mm	1.2 mm
Profile rate in image mode <sup>4)</sup>	< 5000 profiles/s	< 5000 profiles/s	< 5000 profiles/s	< 5000 profiles/s	< 5000 profiles/s
Profile rate in profile mode <sup>4)</sup>	< 3700 profiles/s	< 3700 profiles/s	< 3700 profiles/s	< 3700 profiles/s	< 3700 profiles/s

<sup>1)</sup> Typical

<sup>2)</sup> ± 10% for IVC-3D 30, ± 5% for the other FOV variants

<sup>3)</sup> Represents what may be achieved but is application dependent

<sup>4)</sup> Dependent on settings in grab setup

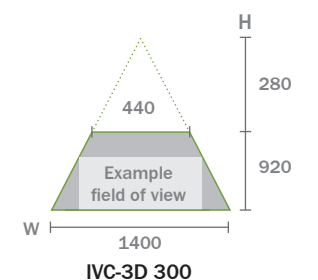
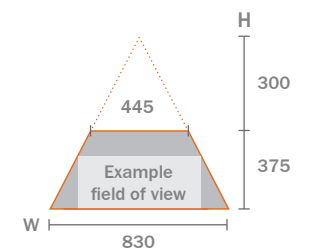
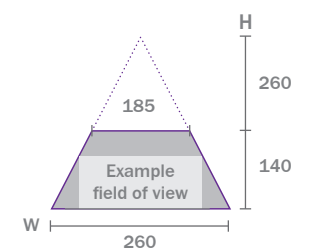
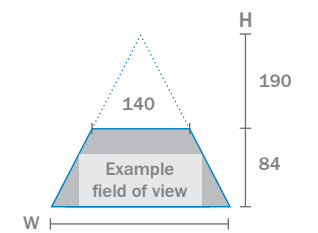
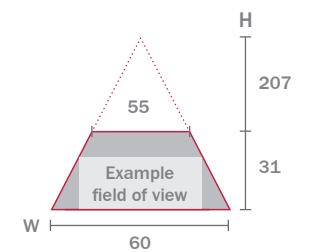



## User-friendly programming in IVC Studio

In IVC Studio the cameras are programmed by selecting tools shown as icons in the toolbar. The actual parameters are set either in interactive setups or by entering values in parameter fields. The settings are simplified by graphical feedback in preview windows. Input and result values can be stored in a table for easy access and later adjustments.

### Image processing tools

All IVC cameras can easily be configured in the IVC Studio, which is a graphical user interface run on a PC with Windows XP or Windows 2000. Many image processing tools included in the IVC-3D product are the same as for IVC-2D which enables fast prototyping and short development times.



### Image

The Image tools are used for grabbing images and profiles, for operations on captured images and for adding graphics such as text and lines.



### Region of interest

The Region of interest (ROI) tools make it possible to select a smaller portion of the image for other tools to work on. This will speed up the image processing and increase the robustness of the program.



### Edge

The Edge tools are used to find object edges in the picture. It is possible to examine the image from all different directions and to find multiple edges along one specific line.



### Measure

Area, cross section areas, volume, blobs and distance can be measured by dedicated tools.



### Filter

Image features can be enhanced by applying filters. Among filters there are erode and dilate tools as well as binarization tools to transform grayscale images to binary.



### Calculation

Calculation tools are used to find if values are in correct ranges, fit surfaces, circularity of round object etc.

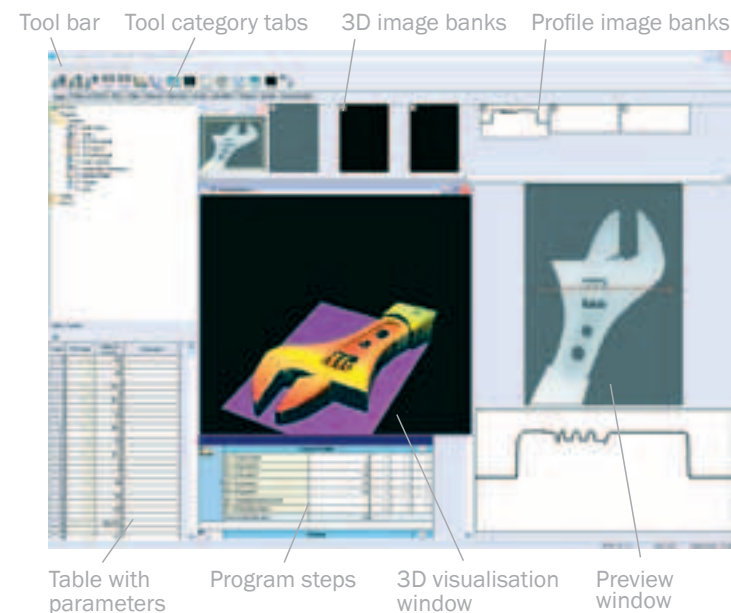

### Circular

A specific set of Circular tools is available. It is possible to check the perimeter, diameter, the surface and the outer shape of objects.



### Matching

The Matching tools can match, locate and count shapes of taught objects in the image.



### Program

The IVC step programming principle is very flexible. With these tools, loops and conditions can be used to gain control and overview of the application program.



### Communication

The Communication tools are used to set outputs and read inputs, to send values over RS-485 and Ethernet. It is also possible to transfer 3D images and profiles to an external ftp server.



### System

The System category contains tools to insert delays in the program, to save values or results to a permanent flash memory, and to write and read values to a separate memory called the Table.

## Flexible sharing of information

### Tailor-made operator interfaces

Customized user interfaces make it easy for line operators and installation technicians to watch over the processes and do maintenance operations:

#### Special purpose user interfaces through ActiveX

Application designed user interfaces for HMI Controls can be created via Microsoft's COM technology, running the IVC Studio in the background.

#### Visualization and operation via Web interfaces

The IVC Web interface enables creation of very flexible user interfaces that can be reached through standard web browsers.

#### Visualization and control through OPC

Windows client applications can communicate through OPC (OLE for process control). This is a straightforward way of data exchange between the IVC camera and e.g. SCADA visualization systems.

### Integration with robots

Shape is more important than 2D pattern when a robot is picking up objects. Using IVC-3D, shape and distance are obtained simultaneously. The IVC-3D coordinate system is easily aligned with the robot's using an interactive tool in the IVC Studio, and after this the IVC-3D conveniently delivers results in robot coordinates.

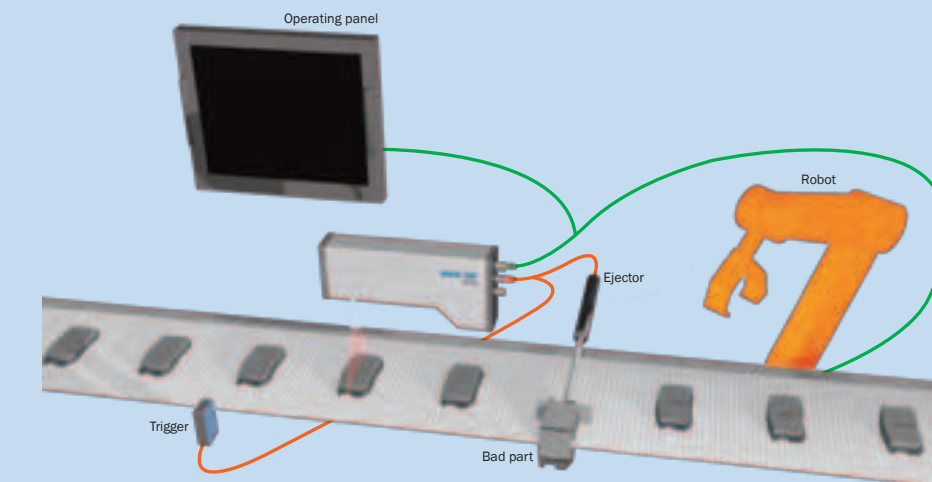

	Field of view (H x W) 30 x 50 mm, 50 x 150 mm, 100 x 200 mm, 200 x 600 mm, 300 x 1000 mm
Smart Cameras	

- The first 3D Smart Camera available
- Calibrated 3D inspection at production speed
- Contrast-independent inspection
- Robust industrial design

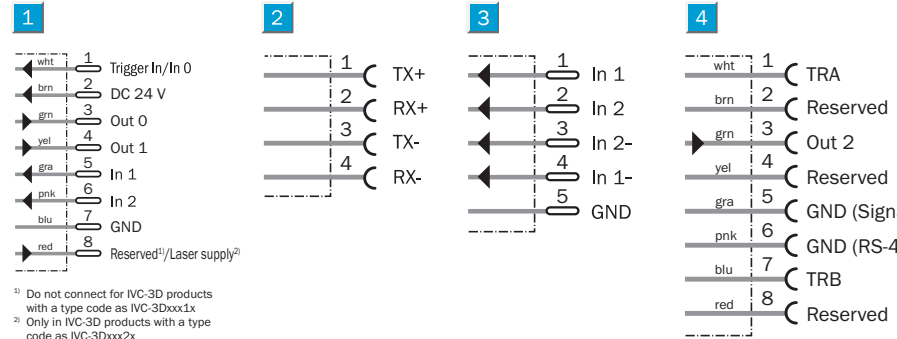
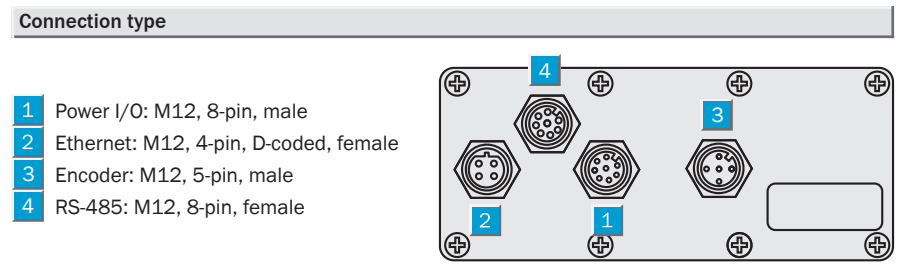
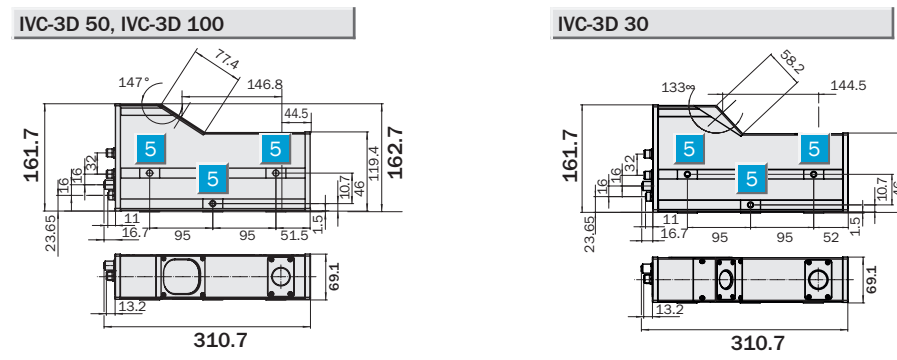
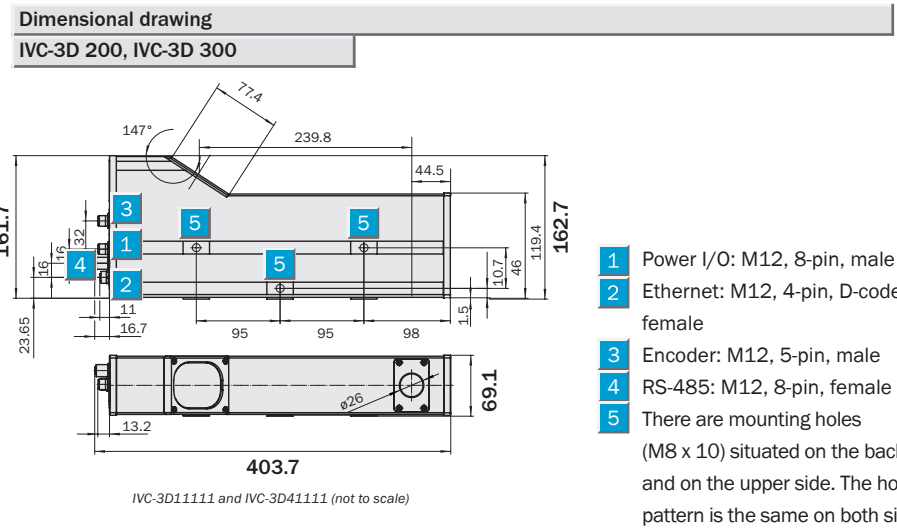

M12, 8-pin, female plug with cable, 2 m, for power and I/O <b>Order no.</b> 6020633	M12, 4-pin, (D-coded) to RJ45 Ethernet cable, 3m <b>Order no.</b> 6029630	M12, 5-pin, female with 2 m cable for Encoder <b>Order no.</b> 6008899	M12, 8-pin, male with 2 m cable for RS-485 and secondary I/O <b>Order no.</b> 6029330
M12, 8-pin, female plug with cable, 5 m, for power and I/O <b>Order no.</b> 6020993	M12, 4-pin, (D-coded) to RJ45 Ethernet cable, 10 m <b>Order no.</b> 6030928	M12, 5-pin, female with 5 m cable for Encoder <b>Order no.</b> 6009868	M12, 8-pin, male with 5 m cable for RS-485 and secondary I/O <b>Order no.</b> 6029331
	M12, 4-pin, (D-coded) to RJ45 Ethernet cable, 25 m <b>Order no.</b> 6033555	M12, 5-pin, female with 10 m cable for Encoder <b>Order no.</b> 6010544	M12, 8-pin, male with 10 m cable for RS-485 and secondary I/O <b>Order no.</b> 6032324

Technical data	IVC-3D																						
		31111 IVC-3D 30	31112 IVC-3D 30	21111 IVC-3D 50	21112 IVC-3D 50	51111 IVC-3D 100	51112 IVC-3D 100	51121 IVC-3D 100	11111 IVC-3D 200	11112 IVC-3D 200	41111 IVC-3D 300	41112 IVC-3D 300											
Performance	5,000 profiles/second, image mode 800 MHz processor and FPGA acceleration																						
Interface	10/100 MB Fast Ethernet <sup>1)</sup>																						
Serial interface	RS-485																						
Digital I/O	3 program controlled inputs (1 trigger input) 3 program controlled outputs																						
Digital inputs	HIGH = 10 V ... 28.8 V																						
Digital outputs	B-type <100 mA tot. current of all digital outputs																						
Encoder interface	RS-422																						
Max encoder frequency	2 MHz																						
Enclosure rating	IP 65																						
Dimensions W x H x L	69 mm x 163 mm x 387 mm 69 mm x 163 mm x 294 mm																						
Weight	Approx. 4 kg Approx. 3.2 kg																						
Housing material	Aluminium, anodized																						
Connector material	Nickel-plated brass																						
Window material	Compound safety glass PMMA																						
Shock load	15 g, 3 x 6 directions																						
Vibration load	5g, 58 ... 150 Hz																						
Laser class	Class II/2M Class IIIb/3B																						
Imager	CMOS																						
Imaging angle	60.5 ° 58 ° 61 ° 53 °																						
3D height resolution	0.015 0.04 mm 0.05 mm 0.2 mm 1.2 mm																						
Max. profile width	1,400 points 2,048 points																						
Laser wavelength	Typ. 658 nm ± 15 nm																						
Laser filter	60 nm FWHM																						
Laser modes	Continuous or flashed, software controlled																						
Power supply	DC 24 V ± 20 %																						
Current consumption	< 1 A																						
Ripple	< 5 Vpp																						
Ambient temperature	Operation: 0 °C ... +40 °C Storage: -20 °C ... +70 °C																						

IVC Studio PC application development tool  
Min system req. 550 MHz CPU, 128 MB RAM, CD-ROM or DVD, Fast Ethernet, Win 2000/WinXP. Graphics driver support for OpenGL 1.3 or higher.  
IVC Studio in English and in German.  
1) TCP/IP/ UDP/IP, Ethernet/IP

Ordering information Smart Cameras		Ordering information Smart Cameras		Ordering information Smart Cameras		Ordering information Smart Cameras	
Type	Order no.	Type	Order no.	Type	Order no.	Type	Order no.
IVC-3D31111	1041205	IVC-3D21112	1041710	IVC-3D51121	1046868	IVC-3D41111	1041204
IVC-3D 30		IVC-3D 50		IVC-3D 100		IVC-3D 300	
IVC-3D31112	1046810	IVC-3D51111	1043579	IVC-3D11111	1027539	IVC-3D41112	1048269
IVC-3D 30		IVC-3D 100		IVC-3D 200		IVC-3D 300	
IVC-3D21111	1027538	IVC-3D51112	1046912	IVC-3D11112	1042152		
IVC-3D 50		IVC-3D 100		IVC-3D 200			

**Australia**

Phone +61 3 9497 4100  
1800 33 48 02 - tollfree  
E-Mail sales@sick.com.au

**Belgium/Luxembourg**

Phone +32 (0)2 466 55 66  
E-Mail info@sick.be

**Brasil**

Phone +55 11 3215-4900  
E-Mail sac@sick.com.br

**Ceská Republika**

Phone +420 2 57 91 18 50  
E-Mail sick@sick.cz

**China**

Phone +852-2763 6966  
E-Mail ghk@sick.com.hk

**Danmark**

Phone +45 45 82 64 00  
E-Mail sick@sick.dk

**Deutschland**

Phone +49 211 5301-301  
E-Mail kundenservice@sick.de

**España**

Phone +34 93 480 31 00  
E-Mail info@sick.es

**France**

Phone +33 1 64 62 35 00  
E-Mail info@sick.fr

**Great Britain**

Phone +44 (0)1727 831121  
E-Mail info@sick.co.uk

**India**

Phone +91-22-4033 8333  
E-Mail info@sick-india.com

**Israel**

Phone +972-4-999-0590  
E-Mail info@sick-sensors.com

**Italia**

Phone +39 02 27 43 41  
E-Mail info@sick.it

**Japan**

Phone +81 (0)3 3358 1341  
E-Mail support@sick.jp

**Nederlands**

Phone +31 (0)30 229 25 44  
E-Mail info@sick.nl

**Norge**

Phone +47 67 81 50 00  
E-Mail austefjord@sick.no

**Österreich**

Phone +43 (0)22 36 62 28 8-0  
E-Mail office@sick.at

**Polska**

Phone +48 22 837 40 50  
E-Mail info@sick.pl

**Republic of Korea**

Phone +82-2 786 6321/4  
E-Mail kang@sickkorea.net

**Republika Slovenija**

Phone +386 (0)1-47 69 990  
E-Mail office@sick.si

**România**

Phone +40 356 171 120  
E-Mail office@sick.ro

**Russia**

Phone +7 495 775 05 34  
E-Mail info@sick-automation.ru

**Schweiz**

Phone +41 41 619 29 39  
E-Mail contact@sick.ch

**Singapore**

Phone +65 6744 3732  
E-Mail admin@sicksgp.com.sg

**Suomi**

Phone +358-9-25 15 800  
E-Mail sick@sick.fi

**Sverige**

Phone +46 10 110 10 00  
E-Mail info@sick.se

**Taiwan**

Phone +886 2 2375-6288  
E-Mail sales@sick.com.tw

**Türkiye**

Phone +90 216 587 74 00  
E-Mail info@sick.com.tr

**United Arab Emirates**

Phone +971 4 8865 878  
E-Mail info@sick.ae

**USA/Canada/México**

Phone +1(952) 941-6780  
1 800-325-7425 - tollfree  
E-Mail info@sickusa.com

More representatives and agencies  
in all major industrial nations at  
[www.sick.com](http://www.sick.com)