

More Projects of...



Joe Grand



Zoz Brooks

Prototype This!

- Engineering entertainment program on Discovery Channel
- Four guys building prototypes of crazy things
- Followed the design/test/refine process
- Limited time & budget per episode
- Premiered October 2008 (US), ~February 2009 (World), 2012 (Netflix)
- Thirteen episodes total

Prototype This!

- Original fan site:
 - <http://dsc.discovery.com/tv/prototype-this/prototype-this.html>
- Engineering documentation & details:
 - www.grandideastudio.com/prototype-this/

The "Talent"



joe
grand



zoz
brooks



mike
north



terry
sandin

Production and Friends



Previously @ DCI7

- Traffic Busting Truck
- Fire Fighter PyroPack
- Virtual Sea Adventure
- Waterslide Simulator
- Flying Lifeguard



Now @ DC20

- Boxing Robots
- Mind Controlled Car
- 6-Legged All Terrain Vehicle
- Get Up and Go
- Autonomous Pizza Delivery

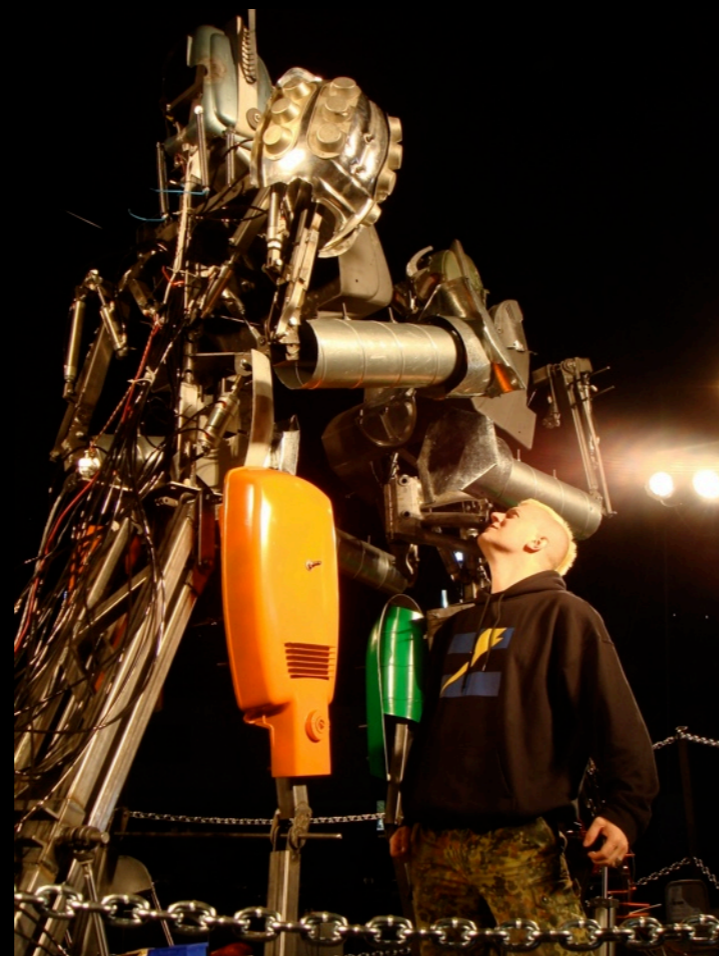

Boxing Robots

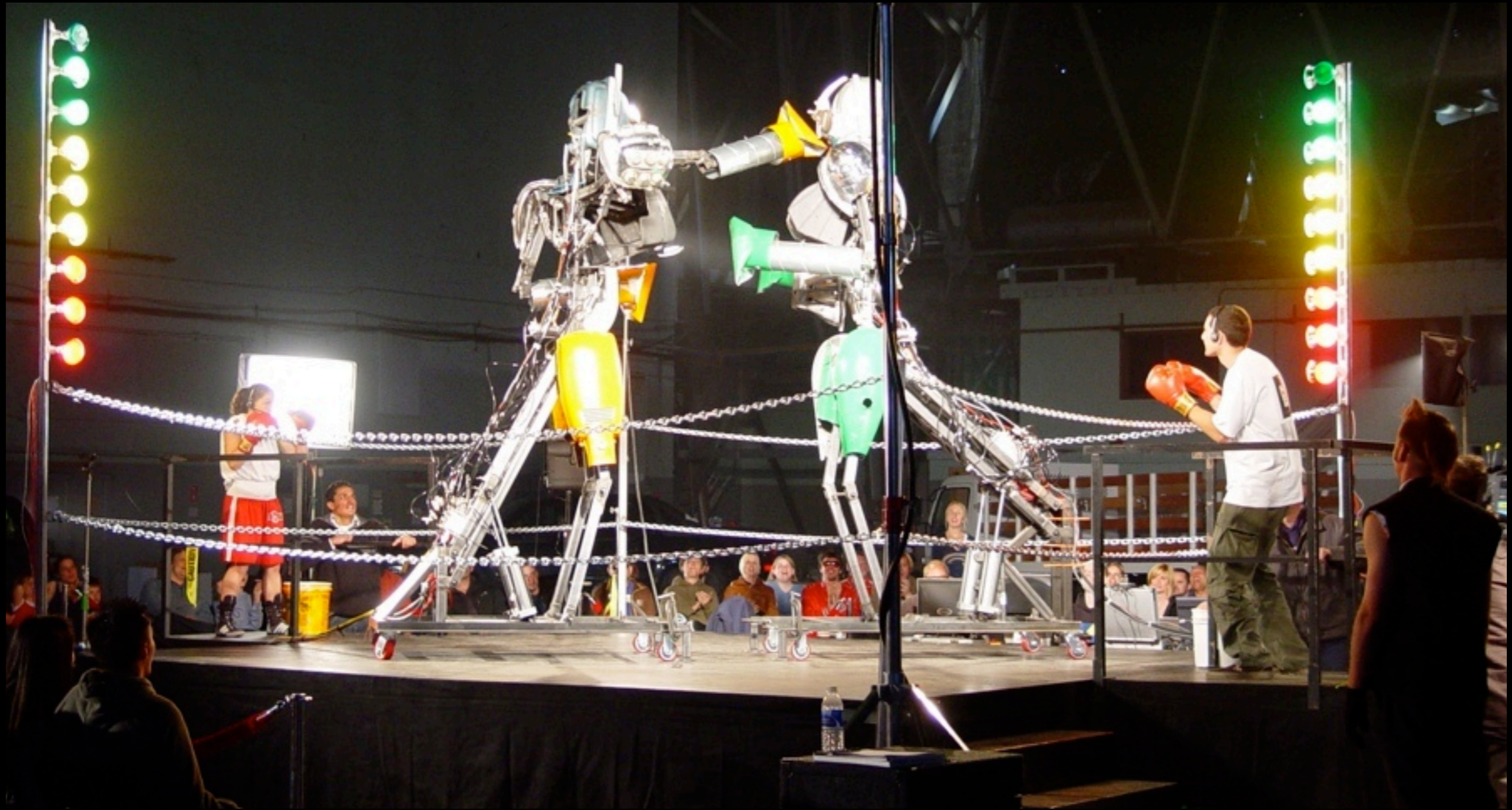

- 1st official build
- ~2 weeks
- Controlled by players outside the ring
- No \$\$\$ for real mocap solution
- Camera/AR + accelerometers

Boxing Robots

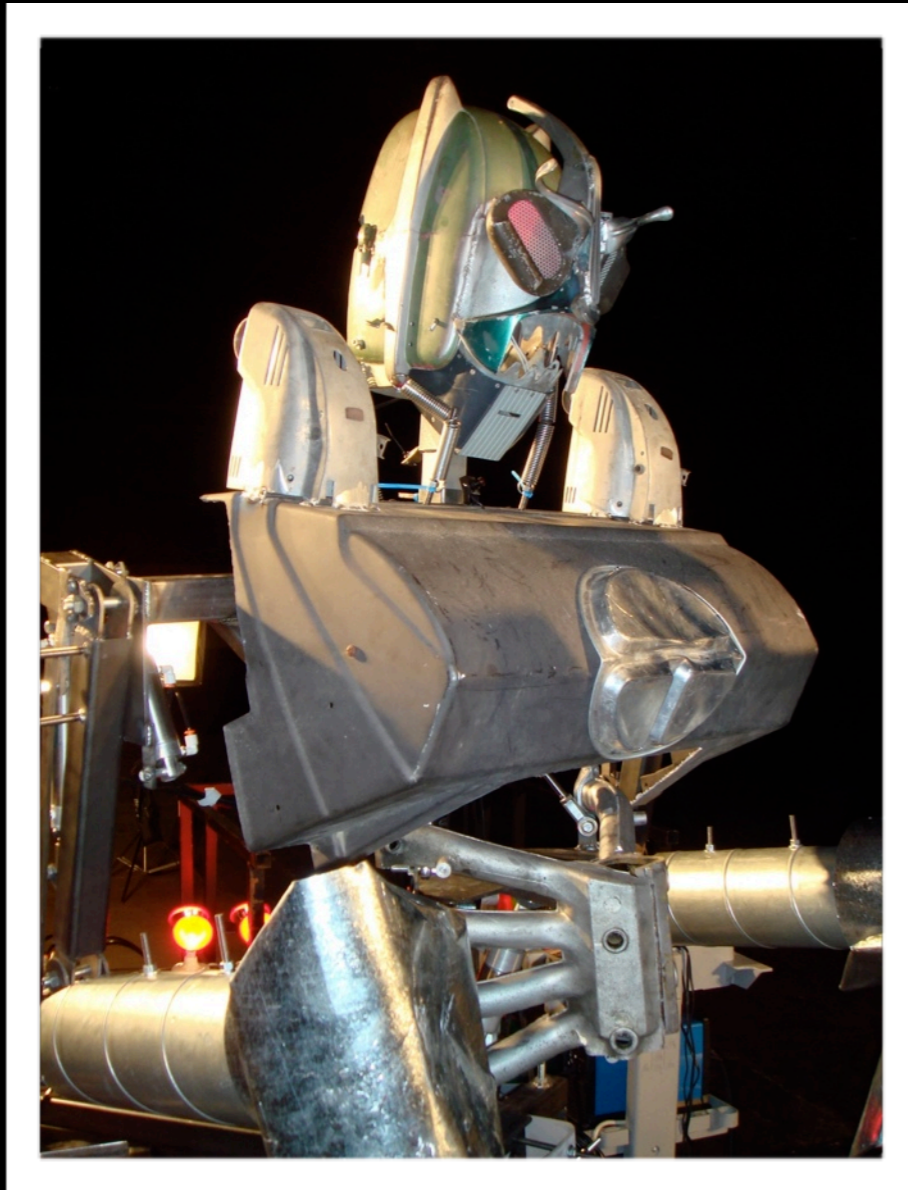

vs.



- Built out of custom articulated steel skeleton
- Covered in body made of recycled/surplus materials
 - Visual design by Nemo Gould (nemomatic)
- Pneumatics controlled via ProXR RS-232 Relay Controller

Boxing Robots

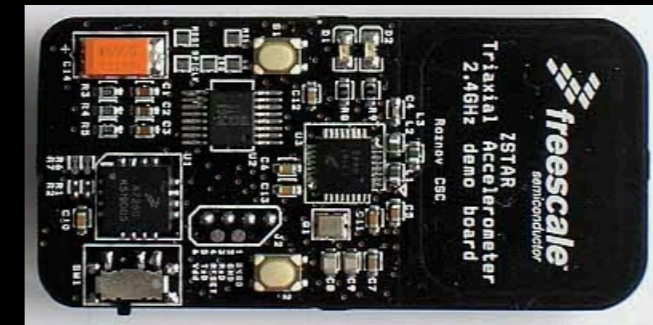

- Freescale ZSTAR Wireless 3-Axis Reference Design (MMA7260QT + MCI3191 2.4GHz transceiver) on gloves
- Highest sensitivity setting (6 Gs max)

Boxing Robots



- The boxing game: C/Windows due to camera drivers
 - IDS μ Eye LE compact CMOS industrial cameras
- Shape filter for punch detection & classification
- ARToolkit tracking for body orientation
- Assembled motion queue and sent via UDP to pneumatics controller

Boxing Robots

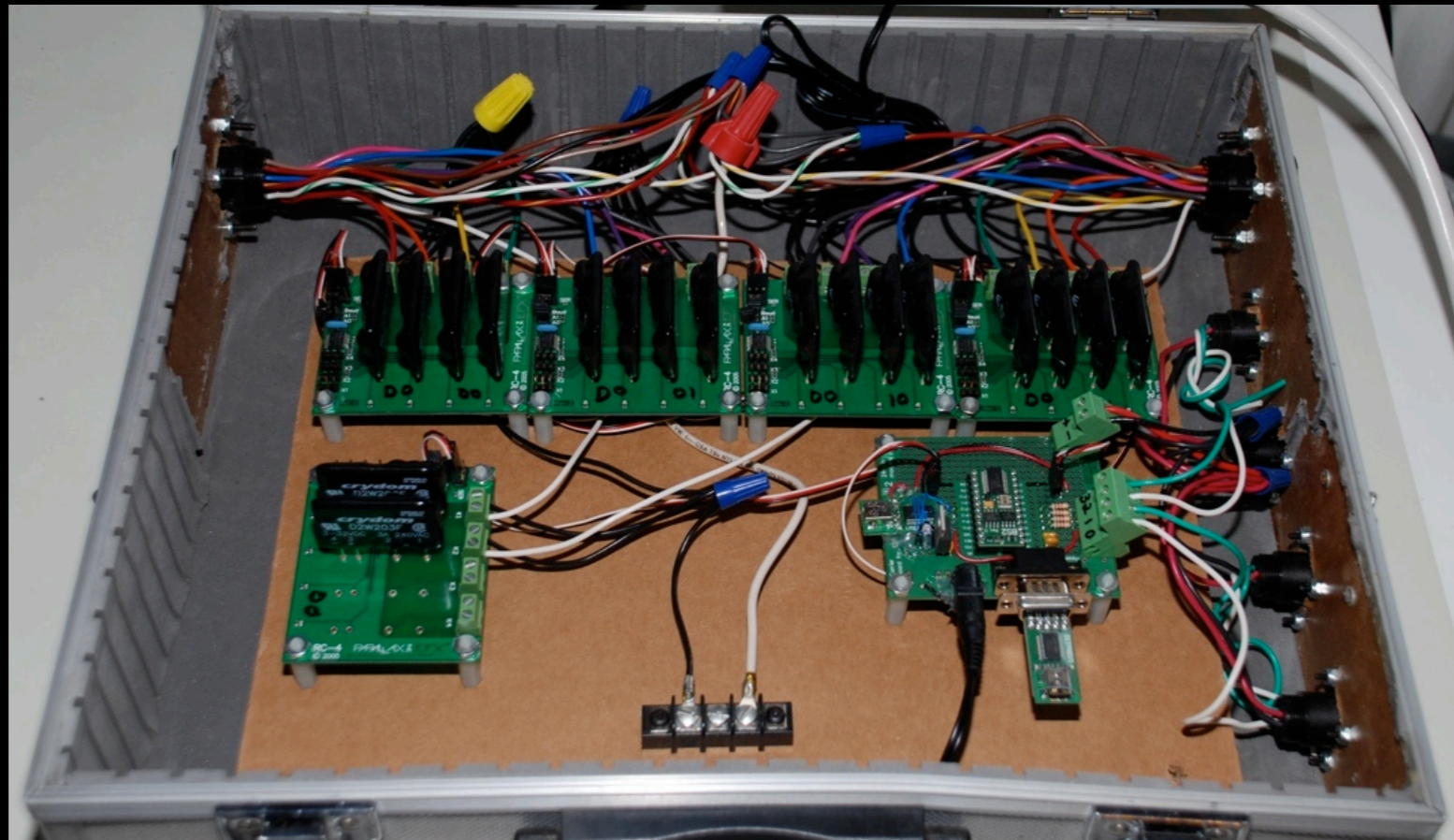

- Health-o-Meter/Scoring System
- BASIC Stamp 2
- EFX-TEK RC-4 + Crydom D2W203F SSRs
- Magnet + hall effect sensor in neck to determine a "hit"
- Serial port I/F to communicate w/ Zoz's control S/W



Boxing Robots

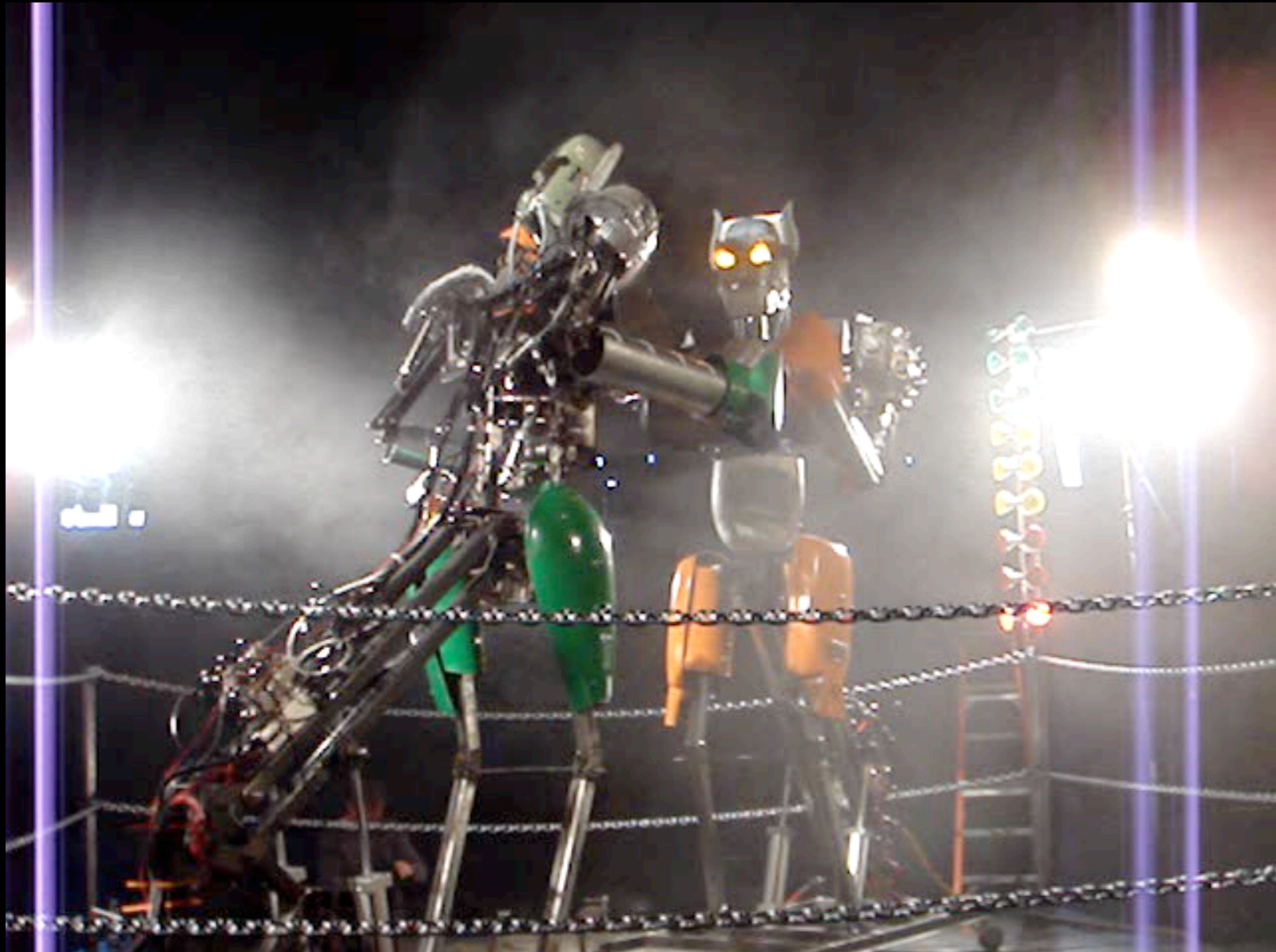

Mind Control Car

ANGER MANAGEMENT



- Anger Management Demolition Derby
- Measure EKG, GSR, heart rate
- Must stay calm/relaxed in order for car to move

Mind Controlled Car

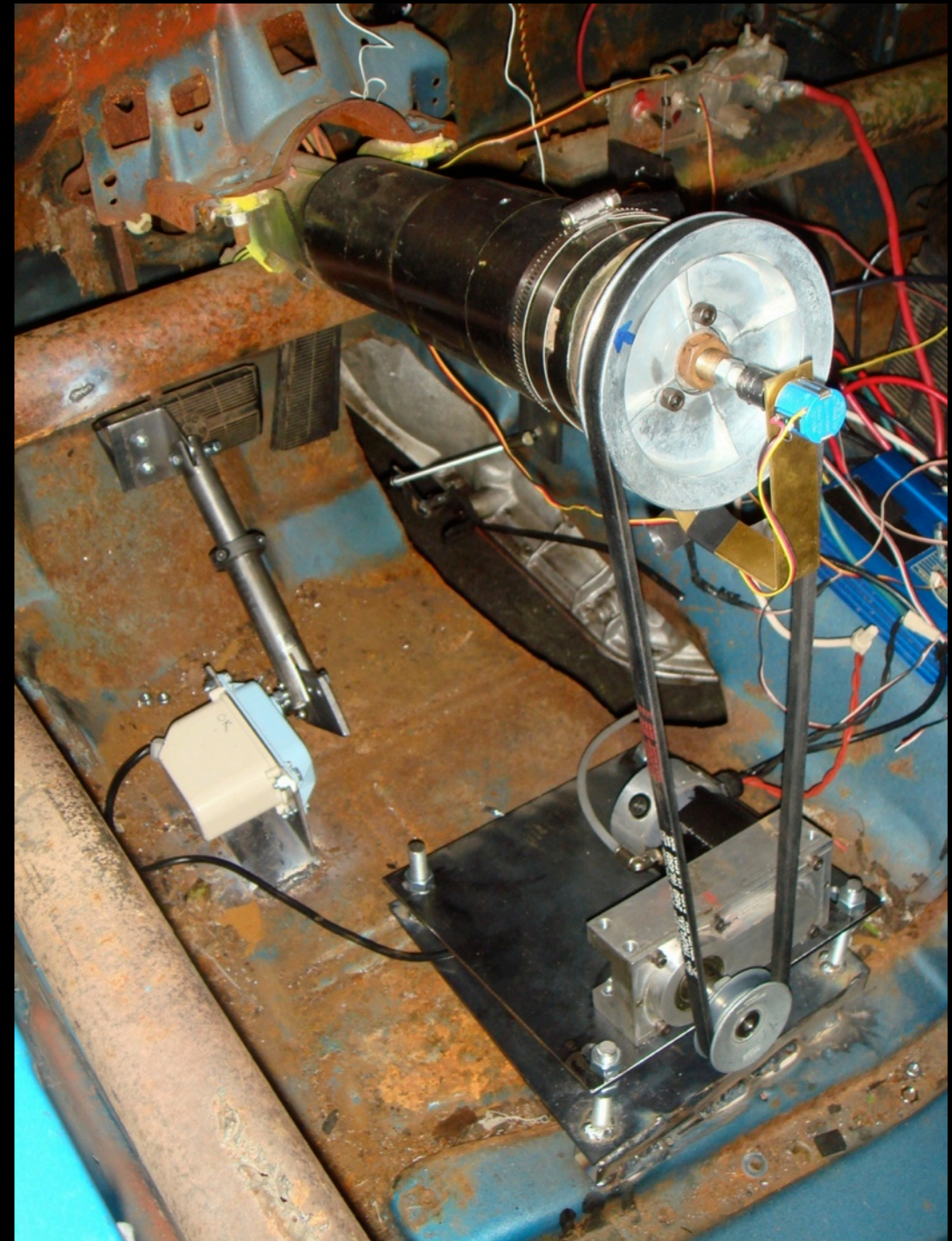

Mind Controlled Car

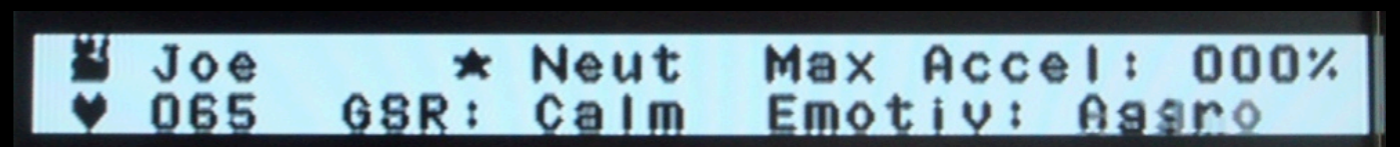
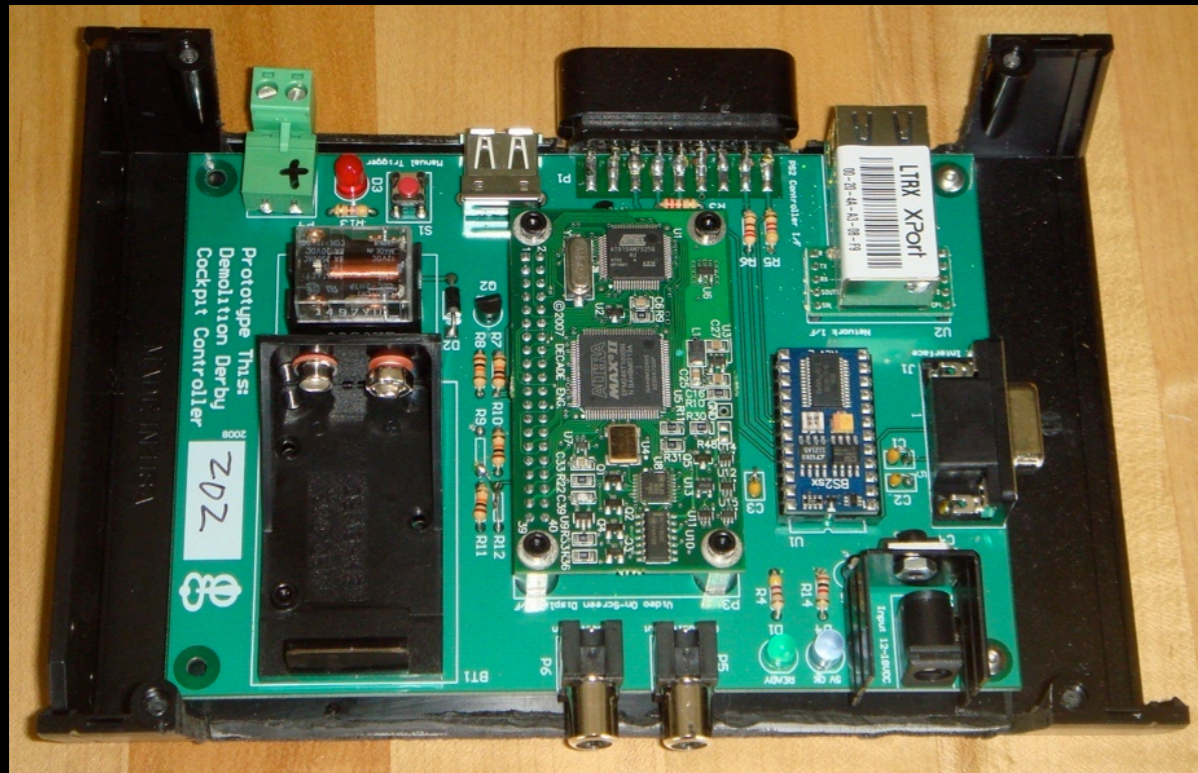

- Playstation 2 driving controller
- BASIC Stamp 2sx
- Lantronix XPORT
- BOB-4-H OSD
- Piezoelectric shockerator to make driver angry (unused)
- Data from each unit sent to Zoz's PC for processing

Mind Controlled Car

- Headset evaluation
 - Neurosky: single electrode, attention/meditation
 - Emotiv: multi electrode, facial expressions, engagement/excitement, “mind control” classifier
- Emotiv loaned us a few of their only prototypes
- Event-driven Emotiv API -> Spoon bending test



Mind Controlled Car

- Heartbeat detection: FIR bandpass filter & threshold
- PCTX USB interface to Futaba R/C controller
 - Windows USB hell
- Multithreaded 4-car derby game system

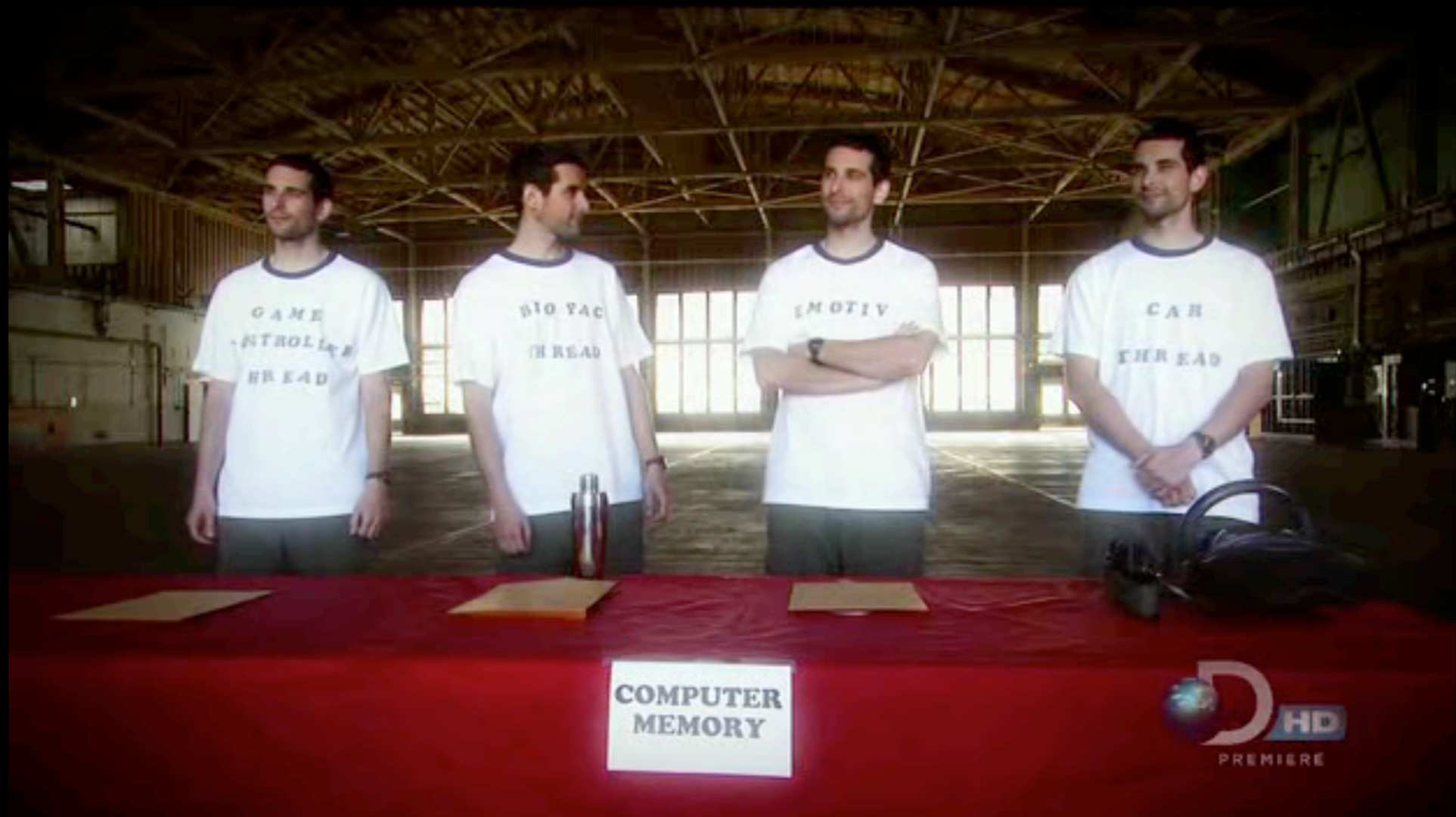

Mind Controlled Car



Six-Legged All Terrain Vehicle



- Gigantic, bio-inspired off-road robotic vehicle
- Human controlled
- ~2 weeks (twice!)

Six-Legged All Terrain Vehicle

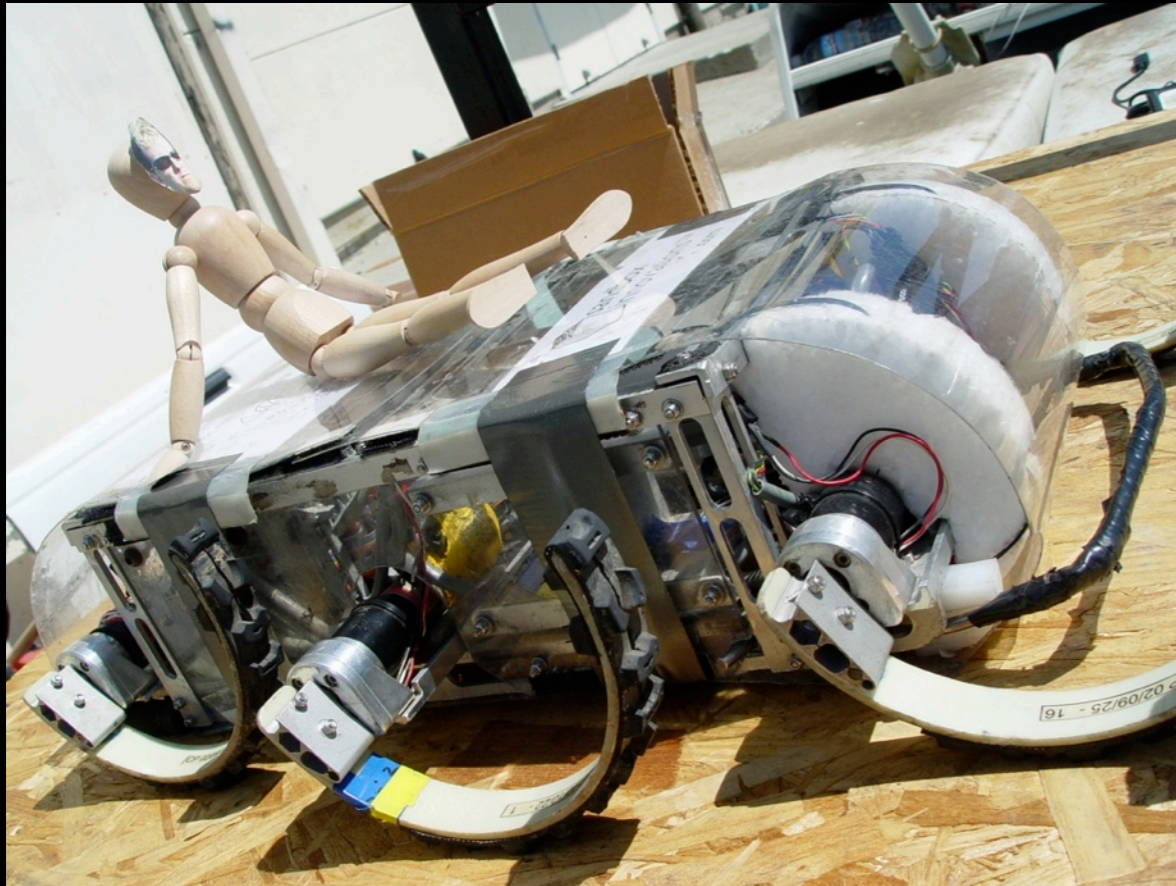

- Synchronized alternating tripod gait
- Based on RHex robot (UPenn Kod*lab/Sandbox Innovations)
- System dynamics depend on materials properties
 - Leg springiness for forward locomotion
 - Ground slip for turning locomotion

Six-Legged All Terrain Vehicle



- Chassis engineering by Speck Design & manufactured by Top of the Hill Performance Center
 - Chromoly tube = heavy!
- Custom carbon fiber "legs" manufactured by Finish Line Advanced Composites

Six-Legged All Terrain Vehicle



Extremely strong and flexible...

Six-Legged All Terrain Vehicle



- Drive train
 - Motor: Custom DC MagMotor
 - Gear Box: 40:1 reduction planetary (Parker Bayside)
 - Encoder: Dynapar industrial shaft encoder
 - 3x RoboteQ DC motor controller (1st try)
 - 6x Sevcon Millipak electric vehicle controller (2nd try)
- 48V @ > 1000A (!)

Six-Legged All Terrain Vehicle

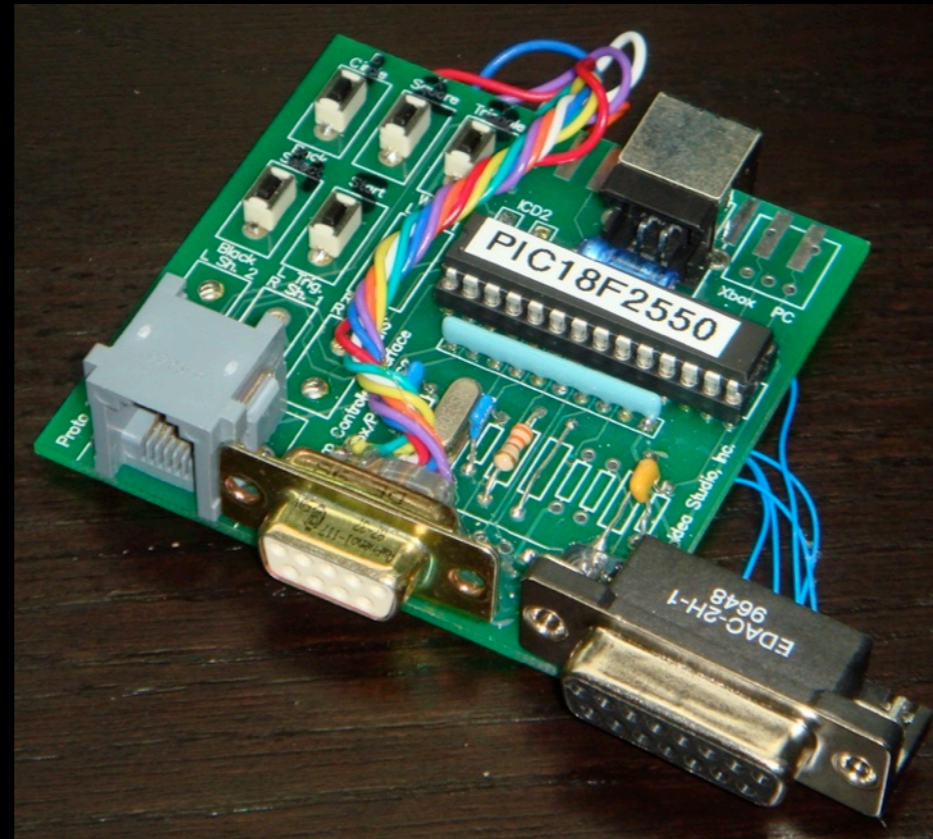

- Control software on laptop running Linux
- Arcade-style joystick and buttons
- USB HID Joystick via PIC18F2550 (based on Joe's Stelladaptor Atari 2600 I/F design)
- Trigger serves as "dead man's switch" for safety

Six-Legged All Terrain Vehicle



- Custom battery management system
- Monitor charge and discharge
- International Battery/Thunder Sky TS-LFP90AHA (90Ah!)
- MAX745 Switch-Mode Lithium-Ion Battery Charger IC
- 4A charge current = 15 hours for full charge

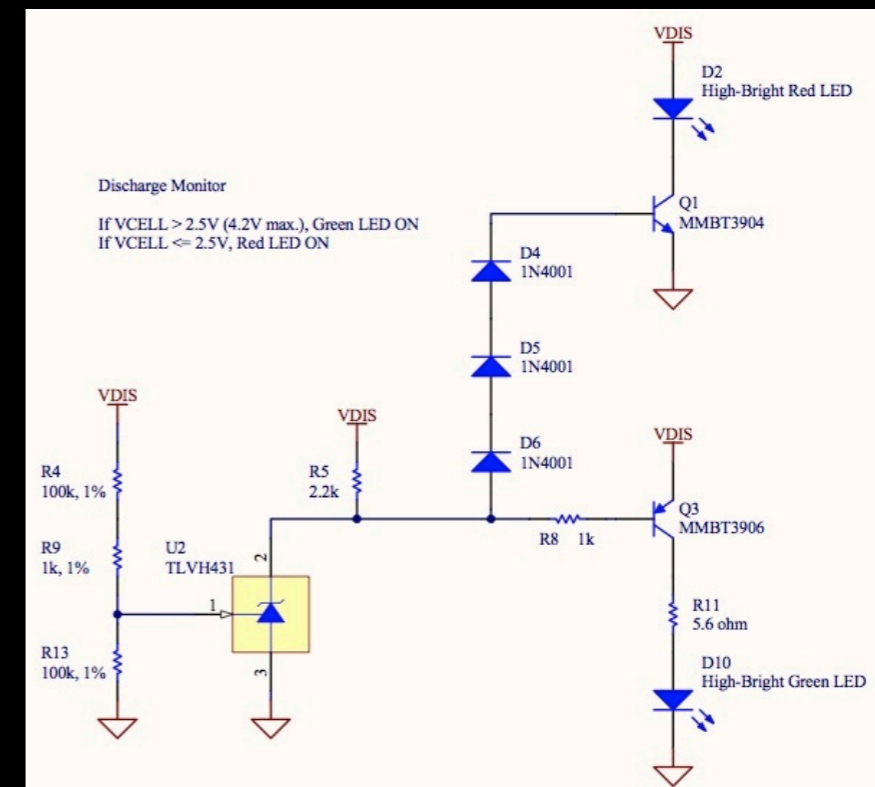

Get Up and Go



- "Futuristic" sleeping pod
- Wake, feed, shower, groom, dress
- HVAC
- Projection system
- ~2 weeks
- Public debut in Union Sq., San Francisco

- Biggest challenge:
 - Fitting everything in there!

Get Up and Go

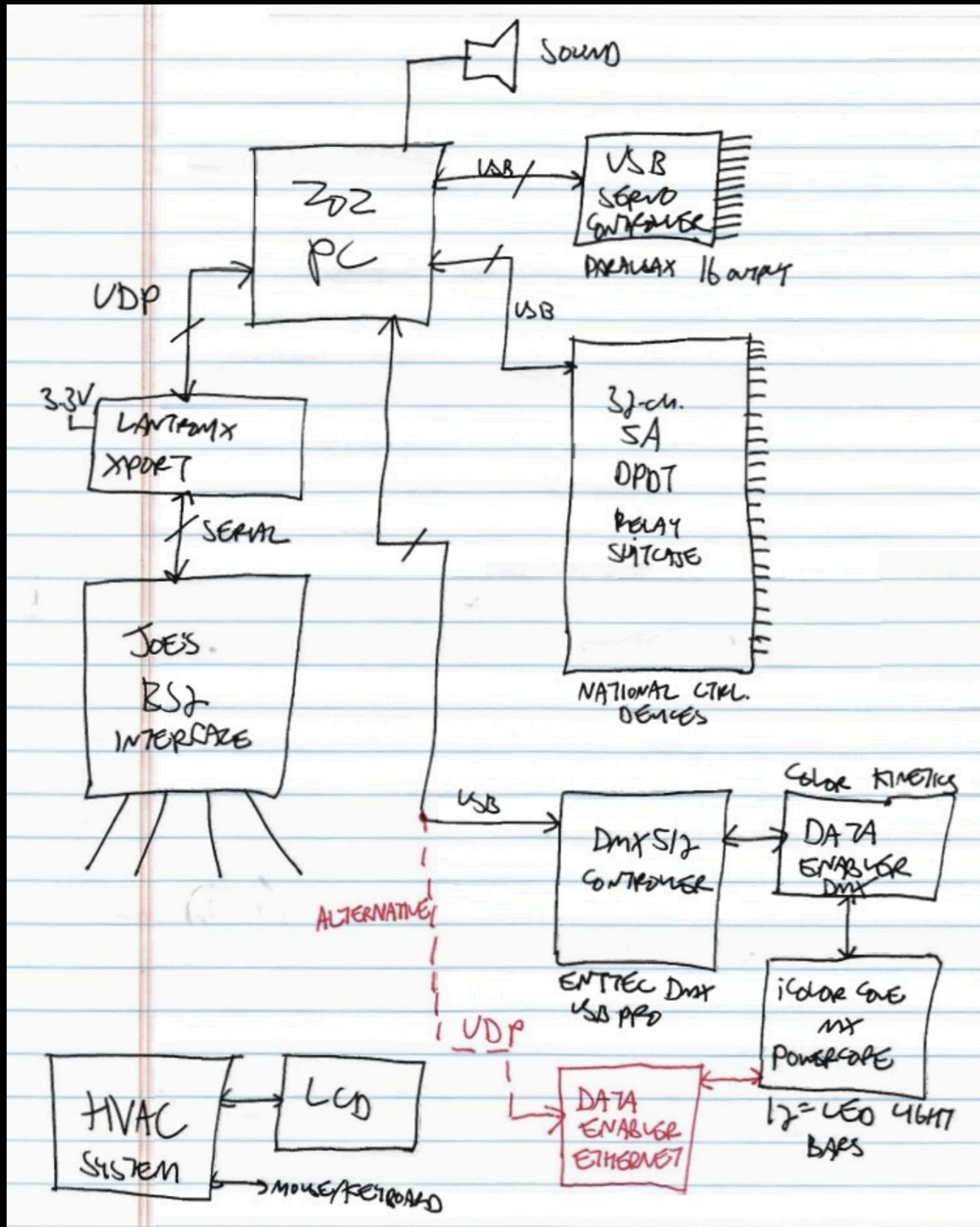

Get Up and Go

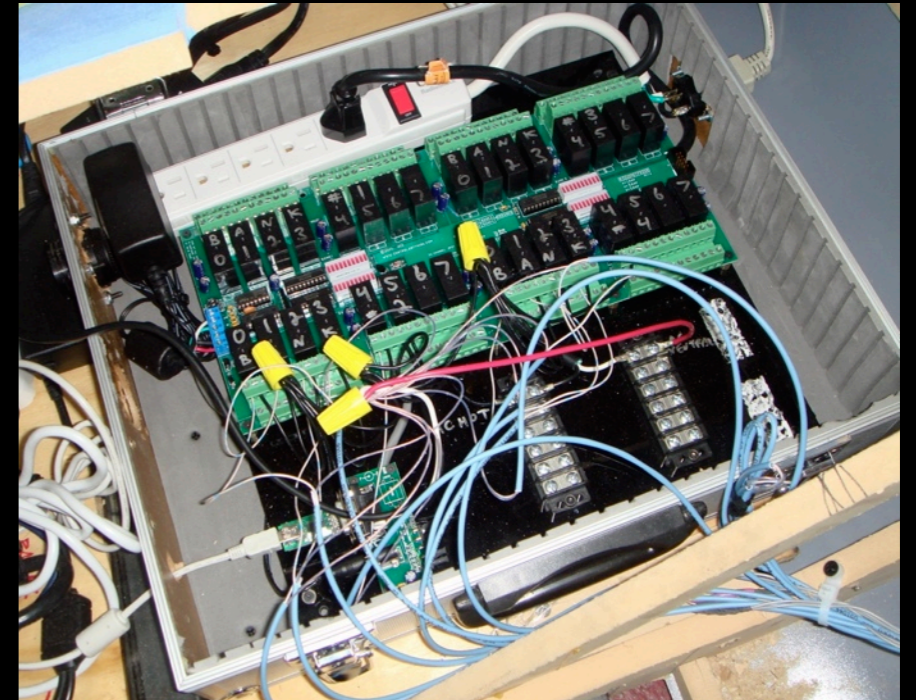
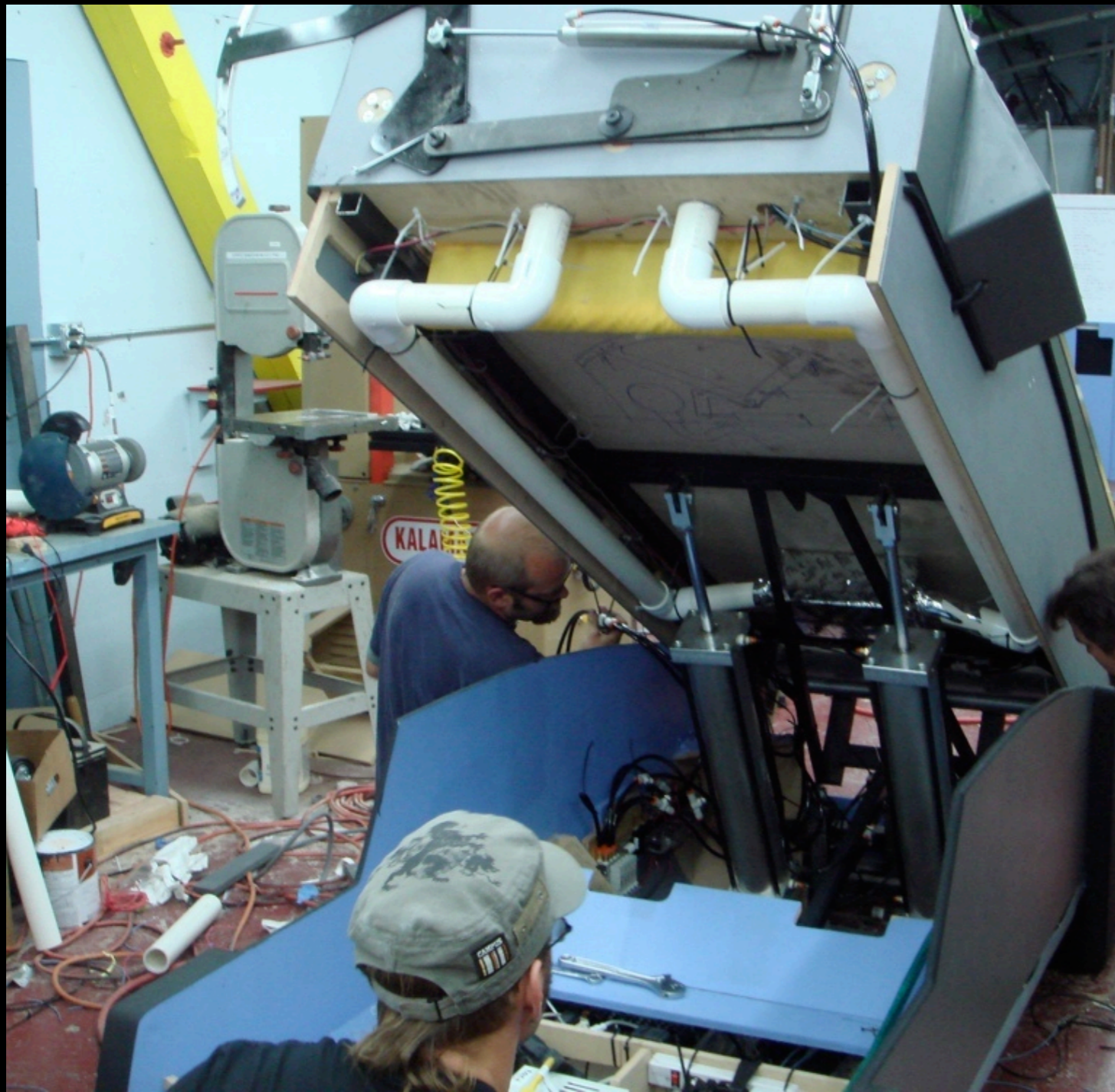

- Pneumatics controlled via ProXR RS-232 Relay Controller

Get Up and Go



- Sensor control board
- BASIC Stamp 2sx
- Photo interrupters (optical encoder)
- Servo controller
- Lantronix XPORT
- Communicates to Zoz's Mac Mini & HVAC system

Get Up and Go

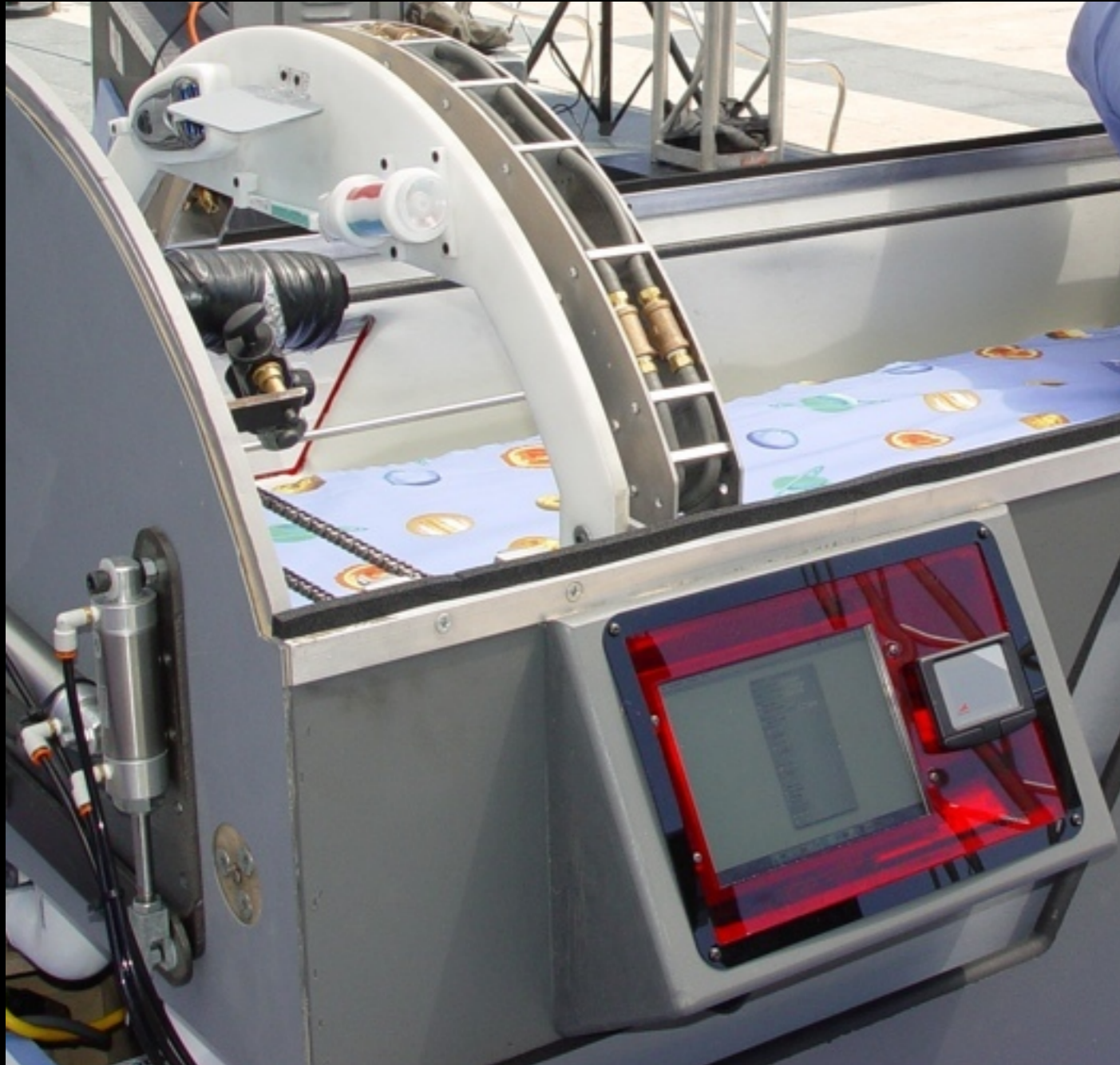

- Mac Mini drives GUI & Color Kinetics lighting system
 - iColor Cove MX Powercore
 - Ethernet Data Enabler
- Pay no attention to the man behind the curtain...

Get Up and Go



Automated Pizza Delivery

- Autonomous pizza delivery to hungry engineers
- Original version requested by network: Blimp (WTF?)
 - Weighing the pizza
- Final versions: Robot (city streets) & vehicle (longer distances)



Automated Pizza Delivery



- Pizza Pie Pack
- BASIC Stamp 2px
- Optrex 4x20 LCD
- Magtek 21040082 mag. stripe reader
- 12-button keypad
- HB25 motor controllers
- Optical detectors for tray limits

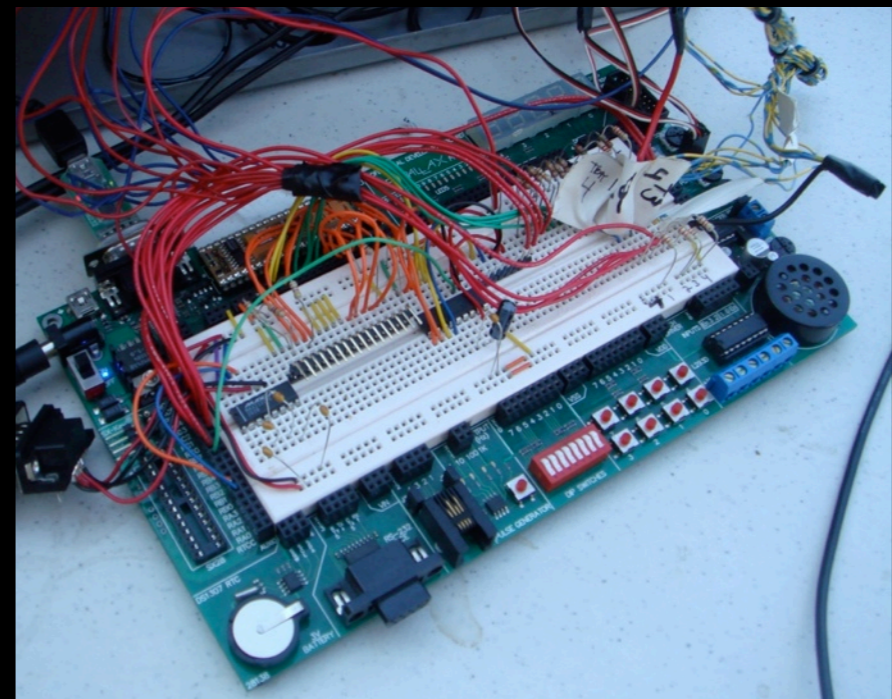
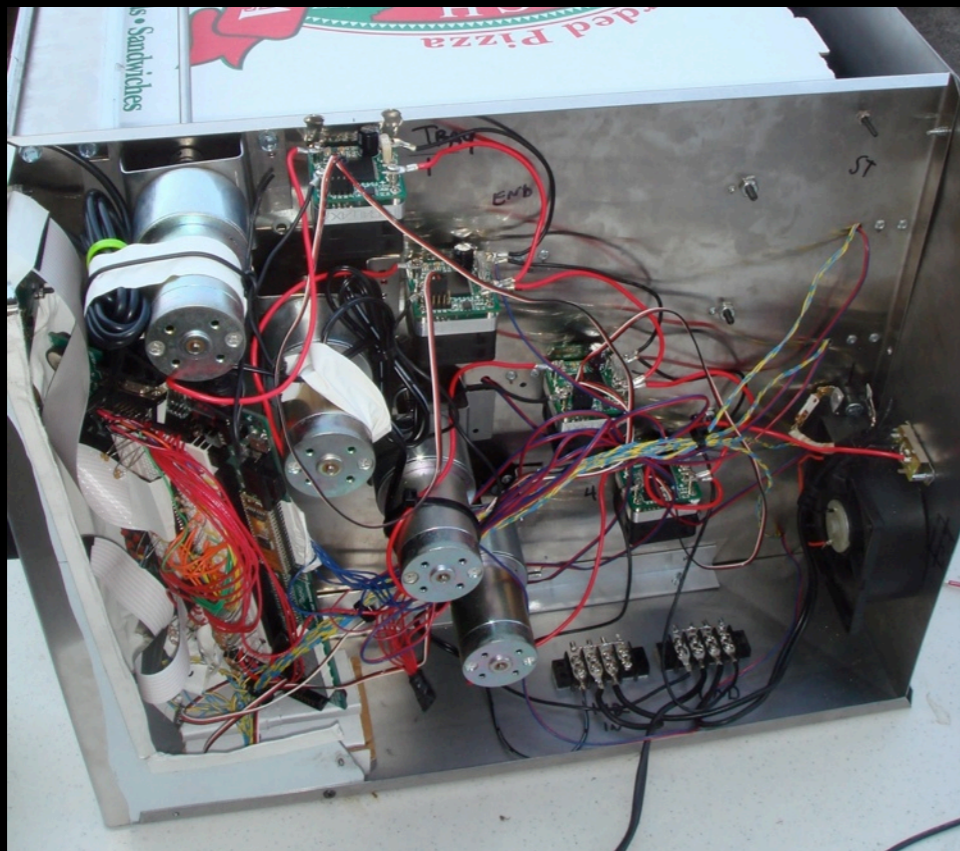

Automated Pizza Delivery



Automated Pizza Delivery

- Marathon Robotics (now Marathon Targets)
- Intended as military live-fire target for sniper training
 - Also good for delivering pizza!



Automated Pizza Delivery

- Marathon Live-Fire Target
 - Mobility platform: Segway RMP + bulletproof steel armor
 - Principal sensor: SICK LIDAR
- Urban challenges
 - Steep inclines (SF streets!)
 - Low obstacles & discontinuities: ex: curbs!

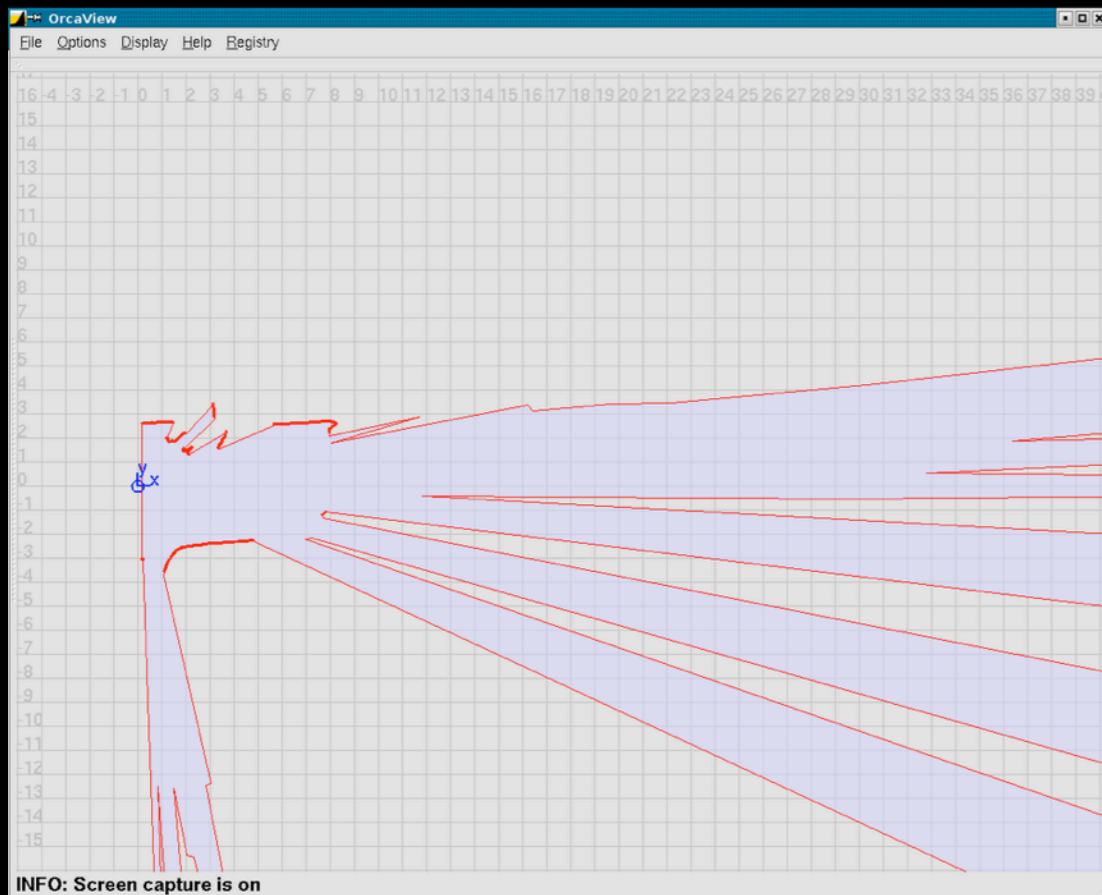

Automated Pizza Delivery



- Project by Anthony Levandowski
 - Differential GPS
 - 2x SICK linescan LIDAR
 - 1x omnidirectional LIDAR
 - 2x wheel encoder odometry
- First bridge crossing of an autonomous vehicle
 - Rolling roadblock on San Francisco's Bay Bridge
- Turned into Google's Self-Driving Car (thanks to Prototype This!)

Automated Pizza Delivery



THANK - U + GOODNITE
FROM PACSAT : KU - 1



MENU

MUTE
EXIT

VOLUME

CHANNEL

INPUT