

Pigtails, Brackets and Grommets

Spirales de Raccord, Bague de Montage et Supports Conectores / Soportes rígidos y flexibles



66930



66931



67001



66850



66851



66801



67050



66800



66840



66980



66981



66982



67120

THIN-LINE LED PIGTAILS

Factory-molded plugs for use with ULTRA-BLUE-SEAL® trailer wiring system

- UBS sealing ring
- Uses patented double-seal protection
- Grease grooves for additional sealing protection
- Slim-Line .180 male

66930 5" Long, Chassis Ground System

66931 6" Long, Ground Return

SEALED MARKER LAMP PIGTAILS

Factory-molded plugs for use with ULTRA-BLUE-SEAL® trailer wiring system

- Double seal resists corrosion
- Fits 2", and 2 1/2" round and beehive-style LED and incandescent lamps
- Slim-Line .180 male

DOUBLE SEAL:

67001 6" Long, Ring Terminal Ground, Blunt Cut Wire

67001-5 6" Long, Ring Terminal Ground, Blunt Cut Wire

RETAIL

66850 6" Long, Chassis Ground

66851 6" Long, Ground Return

SINGLE SEAL:

66801 6" Long, Ground Return

67050 6" Long, Ring Terminal Ground, Blunt Cut Wire

67050-5 6" Long, Ring Terminal Ground, Blunt Cut Wire

RETAIL

66840 6" Long, Chassis Ground, Standard .180 Male

66800 6" Long, Chassis Ground, Slim-Line .180 Male

CLEARANCE / MARKER PIGTAILS

Factory-molded plugs for use with ULTRA-BLUE-SEAL® trailer wiring system

- Fits 4674 series clearance / marker lamps, and 4709 and 6029 / 6030 license and utility lamps
- Pigtail designed to be integral part of mounting bracket (43780)

66980 6" Long, Chassis Ground, Slim-Line .180 Male

66981 6" Long, Universal Replacement, Blunt Cut, Ring Terminal Grommet

66982 8" Long, Ground Return

MARKER LAMP PIGTAIL

Fits all Grote 2-bulb marker lamps with flag terminals, including 4526-, 4546-, 4593-, 4630-, 4678- and 4679- series lamps

67120 7 3/4" Long, .180 Slim-Line Male

SEALED, ECONOMY CLEARANCE/ MARKER LAMP PIGTAIL

Fits 4607 series lamps

66360 6 3/4" Long w/ 3/8" Wire Strip



TURTLEBACK® II DOUBLE-SEAL LAMP PIGTAILS

Factory-molded plugs for use with ULTRA-BLUE-SEAL® trailer wiring system

• Pigtail for 4680-, 4684-, 4686- and 4687- series lamps • All connections fit under lamps

- 66910** 6" Long, Chassis Ground, Slim-Line .180 Male
- 66911** 6" Long, Ground Return, Standard .180 Male
- 67070** 2 1/2" Long, Ground Wire, Standard .180 Male
- 67071** Two-Wire, Standard .180 Male



SENTRY LAMP PIGTAILS

Factory-molded plugs for use with ULTRA-BLUE-SEAL® trailer wiring system

• Sealed plug-in pigtail for 5206-, 5202-, and 5306- lamps • O-ring helps prevent moisture and corrosion

- 66900** 6" Long, Chassis Ground, Slim-Line .180 Male, 3 1/2" Ground, Star Ring Terminal
- 66903** Three-Wire, Standard .180 Male (5306 Lamps Only)
- 66904** 6" Long, Ground Return, Slim-Line .180 Male
- 66905** 6" Long, Chassis Ground, Slim-Line .180 Male



SENTRY LAMP SINGLE FUNCTION 90° PIGTAIL

90° molded plug at lamp • Packard connector at power end (15300027)

• O-ring resists moisture and corrosion

66920 30" Long, 90° Plug



Pigtails, Brackets and Grommets

Spirales de Raccord, Bague de Montage et Supports Conectores / Soportes rígidos y flexibles



SENTRY HIGH-MOUNT STOP PIGTAIL

Fits 54012 lamp • Sealin -ring to lamp base • O-ring resists moisture and corrosion

66902 6" Long, Slim-Line .180 Male, 3" Ground, Star Ring Terminal



HIGH-MOUNT STOP LAMP PIGTAIL

Factory-molded plugs for use with the ULTRA-BLUE-SEAL® trailer wiring system • Fits 4925 series lamps for use in HMSL applications

66870 12 1/2" Long, Slim-Line .180 Male

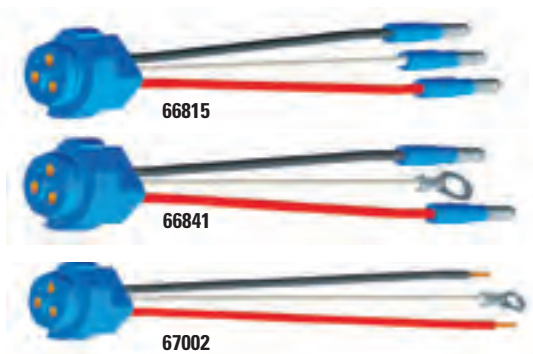

STOP /TAIL /TURN THREE-WIRE PLUG-IN PIGTAILS FOR MALE PIN LAMPS

Dual function for S/T/T lamps • O-ring seal resists moisture and corrosion • Quality ULTRA-BLUE-SEAL® construction • Grease grooves for additional sealing protection

66815 6" Long, Ground Return, Slim-Line .180 Male

66841 8" Long, Chassis Ground, Slim-Line .180 Male

67002 11" Long, Chassis Ground, Blunt Cut Wire

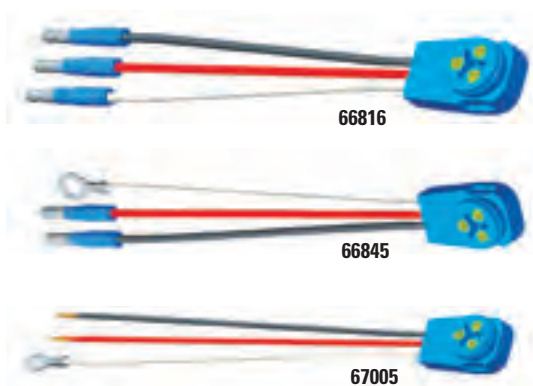

STOP /TAIL /TURN THREE-WIRE 90° PLUG-IN PIGTAILS FOR MALE PIN LAMPS

Dual function for S/T/T lamps • O-ring seal resists moisture and corrosion • 90° plug for reduced clearance applications • Quality ULTRA-BLUE-SEAL® construction • Grease grooves for additional sealing protection

66816 6" Long, Ground Return System, 90° Plug, Slim-Line .180 Male

66845 8" Long, Chassis Ground, 90° Plug, Slim-Line .180 Male

67005 11" Long, Chassis Ground, 90° Plug, Blunt Cut Wires

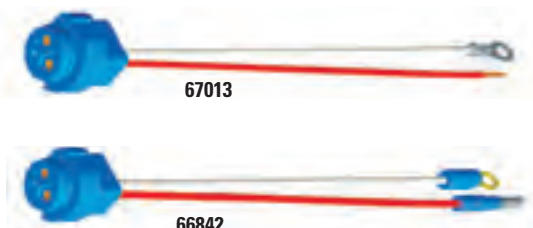

STOP /TAIL /TURN TWO-WIRE PLUG-IN PIGTAILS FOR MALE PIN LAMPS

Straight-in pigtail • Single function • O-ring seal resists moisture and corrosion • Quality ULTRA-BLUE-SEAL® construction • Grease grooves for additional sealing protection

67013 11" Long, Chassis Ground, Blunt Clut Wire

66842 10" Long, Chassis Ground, Slim-Line .180 Male

STOP /TAIL /TURN TWO-WIRE 90° PLUG-IN PIGTAILS FOR MALE PIN LAMPS

Factory-molded plugs for use with quality ULTRA-BLUE-SEAL® trailer wiring system • 90° plug for reduced clearance applications • Single function • O-ring seal resists moisture and corrosion • Grease grooves for additional sealing protection

- 66846** 10" Long, Chassis Ground, 90° Plug, Slim-Line .180 Male
- 67016** 11" Long, Chassis Ground, 90° Plug, Blunt Cut Wires



66846



67016

STOP /TAIL /TURN THREE-WIRE PLUG-IN PIGTAILS FOR FEMALE PIN LAMPS

Dual function for S/T/T lamps • Factory molded plugs for use with ULTRA-BLUE-SEAL® trailer wiring system

- 66812** 6" Long, Chassis Ground, Slim-Line .180 Male
- 66825** 8" Long, Ground Return, Slim-Line .180 Male
- 67000** 11 1/2" Long, Chassis Ground, Blunt Cut Wires



66812



66825



67000

STOP /TAIL /TURN THREE-WIRE 90° PLUG-IN PIGTAILS FOR FEMALE PIN LAMPS

Factory-molded plugs for use with ULTRA-BLUE-SEAL® trailer wiring system • Dual function for S/T/T lamps

- 66811** 18" Long, Chassis Ground, Slim-Line .180 Male, Star Ring Terminal
- 66843** 18" Long, Chassis Ground, Blunt Cut Wires, Star Ring Terminal
- 66843-5** 18" Long, Chassis Ground, Blunt Cut Wires, Star Ring Terminal **RETAIL**
- 66844** 18" Long, Ground Return, Slim-Line .180 Male

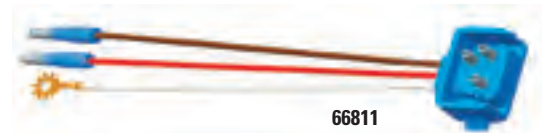

66811

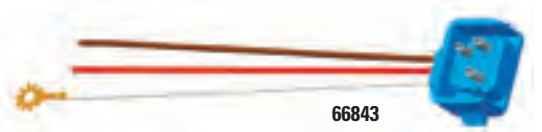

66843



66844

UNIVERSAL 3-WIRE 90° PLUG-IN PIGTAIL FOR FEMALE-PIN LAMPS

90° construction for reduced clearance applications • Dual function for S/T/T lamps • Mates to Grote® and competitive lamps with female termination

- 67090** 13" Long, Chassis Ground, 90° Plug, Blunt Cut Wires
- 67090-5** 13" Long, Chassis Ground, 90° Plug, Blunt Cut Wires **RETAIL**



67090

Pigtails, Brackets and Grommets

Spirales de Raccord, Bague de Montage et Supports Conectores / Soportes rígidos y flexibles

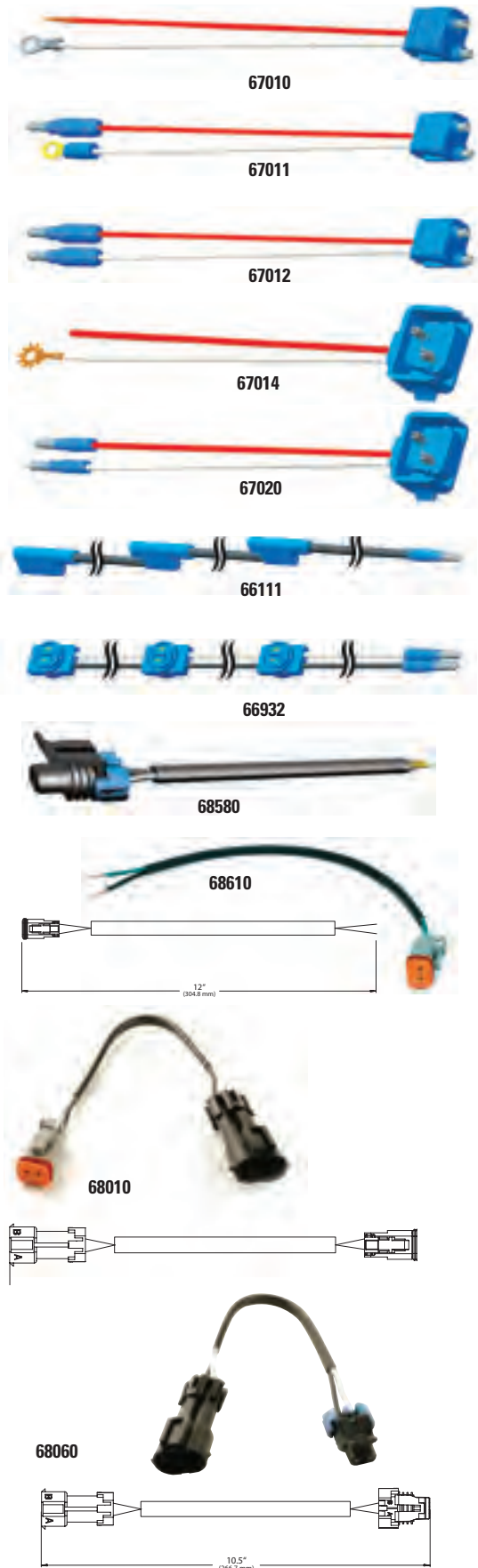

TWO-WIRE PLUG-IN PIGTAILS FOR FEMALE-PIN LAMPS

Factory-molded plugs for use with ULTRA-BLUE-SEAL® trailer wiring system • Single function • Includes dummy pin to help guide the pigtail into lamp

STRAIGHT:	
67010	11 1/2" Long, Chassis Ground, Blunt Cut
67011	10 1/4" Long, Chassis Ground, Standard .180 Male
67012	10" Long, (2) Standard .180 Male
90° PLUG:	
67014	10" Long, Chassis Ground, Blunt Cut
67020	10" Long, Ground Return, Slim-Line .180 Male

TRIPLE-LAMP ID HARNESSSES

Designed for use with ULTRA-BLUE-SEAL® wiring system • Factory-molded plugs resist moisture and corrosion • Slim-Line .180 male terminations at power end

66111	54" Long, Universal Triple-ID Jumper (31"x12"x12")
66932	60" Long, LED Triple-ID Jumper (36"x12"x12")

HARD SHELL SUPERSEAL CONNECTOR

Mates with Trilliant® Work Lamps and competitive lamps using AMP superseal connectors

68580	9" Long, Blunt Cut Wires
--------------	--------------------------

DEUTSCH CONNECTOR

Mates with Trilliant® Work Lamps and competitive lamps using Deutsch connectors

68010	Deutsch to Packard
68020	Packard to Deutsch
68030	Deutsch to Packard (Hard Shell SuperSeal)
68060	Packard to Packard
68610	12" Long, Blunt Cut Wires

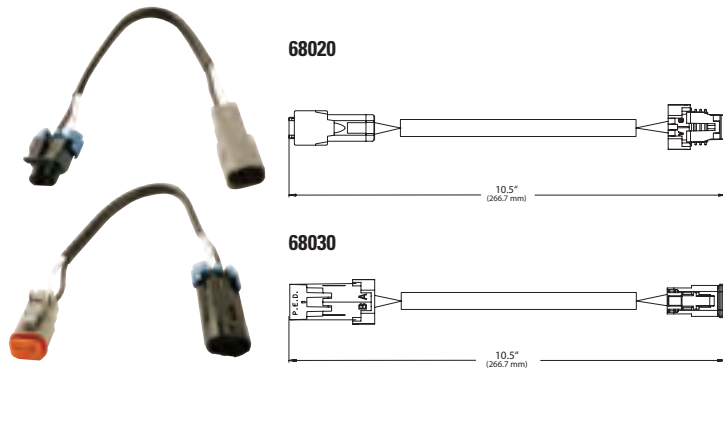

HARD-SHELL CONNECTOR PIGTAILS

Mates with Grote and competitive lamps using Hard Shell SuperSeal 1.5 series connectors

DUAL FUNCTION:

66861 11" Long, Chassis Ground, Blunt Cut Wires

SINGLE FUNCTION:

66862 11" Long, Chassis Ground, Blunt Cut Wires



66861



66862

PACKARD® CONNECTOR PIGTAIL

Sealed plug-in style pigtail for Grote® Hybrid Midturn / Marker LED lamp

66826 6" Long, Slim-Line .180 Males



METRI-PACK® PLUG-IN SEALED PIGTAIL

Fits either 4- or 5-wire applications • Fits 5370-, 5371-, 5372- and 5376- series lamps

66880 20" Long, Sealed, Blunt Cut Wires



TWO LAMP 9" Y ADAPTER PIGTAILS

Accommodates 6-lamp systems • Molded termination avoids moisture and corrosion buildup • For use with 4" round and oval S/T/T lamps • Retrofits to superior Grote male pin LED lamps without the need for new wiring

90° PLUG:

66814 9" Long, Adapter, Female-to-Male Pin

STRAIGHT:

66810 9" Long, Adapter, Female-to-Female Pin

66813 9" Long, Adapter, Male-to-Male Pin

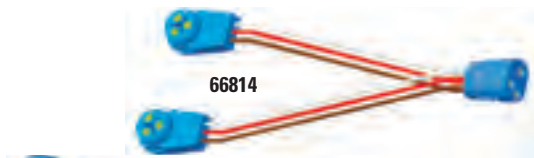

66814



66810



66813

MIDTURN ADAPTER PIGTAILS

Factory-molded plugs for use with ULTRA-BLUE-SEAL® trailer wiring system • For use with 4" round and oval S/T/T lamps • 6" midturn adapter harness • Dummy plug in brown female .180 receptacle

66820 Adapter, Female-to-Female Pin, (2) Additional Standard .180 Receptacles

66823 Adapter, Male-to-Male Pin, (2) Additional Standard .180 Receptacles



66820



66823

Pigtails, Brackets and Grommets

Spirales de Raccord, Bague de Montage et Supports Conectores / Soportes rígidos y flexibles



ADAPTER PLUGS

Includes female-to-male pin lamp termination, and male-to-female pin lamp termination • For use with 4" round and oval, S/T/T lamps

- 66830** 6" Long, Female Pin to Male Pin Lamp Termination
- 66831** 6" Long, Male Pin to Female Pin Lamp Termination
- 66831-5** 6" Long, Female Pin to 90° Male Pin Lamp Termination
- 66836** 6" Long, Female Pin to 90° Male Pin Lamp Termination

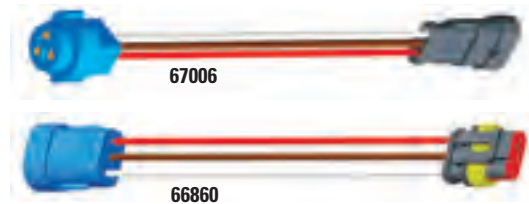

ADAPTER PLUGS FOR HARD SHELL CONNECTORS

For use with 4" round and oval S / T / T lamps

COMPETITIVE HARNESS TO MALE PIN:

- 67006** 6" Long, Hard Shell to Male Pin Connector

FEMALE PIN HARNESS TO AMP CONNECTOR:

- 66860** 6" Long, Female Pin to Hard Shell Connector



COMBO PIGTAILS

For new 4" integrated B/U Lamp

- 66863** Male Pin to Lamp Termination (10" Long)
- 66864** Female Pin to Lamp Termination (10" Long)
- 66865** Hard Shell to Lamp Termination (10" Long)



REPLACEMENT LAMP SOCKET PIGTAILS

Ensures positive bulb contact in all types of weather • Exceeds all existing automotive requirements • Heavy gauge thermoplastic wire with brass contacts, terminals and flags

DOUBLE CONTACT:

- 68110** 9 1/2" Long
- 68130** 7 1/2" Long
- 68150** 6 1/2" Long

SINGLE CONTACT:

- 68080** 9 1/2" Long
- 68170** 9 1/2" Long

TWIST-IN SOCKET PIGTAIL

Includes 194 bulb • Fits 46002, 46003, 46913, 45662, 45563, 45712 and 45713 marker lamps

68380 9 1/2" Long, Socket, Blunt Cut Wires

Voltage / Amp: 12V / .27A



HOODED MICRONOVA® DOT GROMMET

Fits MicroNova® Dot lamps • For plate thickness to 1/4"

94360 Black

Material: PVC
Finish: Black

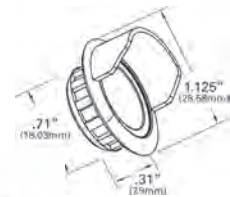

MICRONOVA® SECURITY PLATE

Installs over grommet mounted MicroNova® Dot without impeding light output performance • Use stainless steel rivets (.119 rivet) or screws (not included) to mount directly to the vehicle

42063 Stainless Steel

Material: Stainless Steel
Finish: Stainless Steel

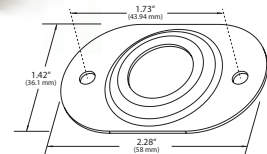

RECESSED MOUNTING GROMMET FOR 2" ROUND LAMPS

Requires 2 5/16" mounting hole • Fits panel thickness up to 1/4"

92120 Open Grommet

92150 Closed Back Grommet

KITS:

94100 Open Grommet (92120 + 67050)

Material: PVC
Finish: Black

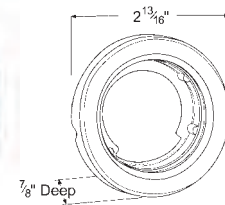

92120

SNAP-IN THEFT-RESISTANT MOUNTING FLANGE FOR 2" ROUND LAMPS

Snap-in flanges make installation more efficient in a variety of situations • Lamp snaps into the flange and flange snaps into the trailer body, making it more theft resistant • Requires a 2 5/16" hole and panel thickness from 1/16" up to 1/4" thick

42190 Gray

CAP:

93860 Gray

Material: Polycarbonate
Finish: Gray

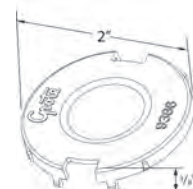
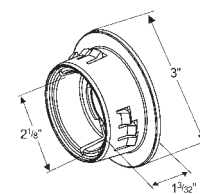

Pigtails, Brackets and Grommets

Spirales de Raccord, Bague de Montage et Supports Conectores / Soportes rígidos y flexibles

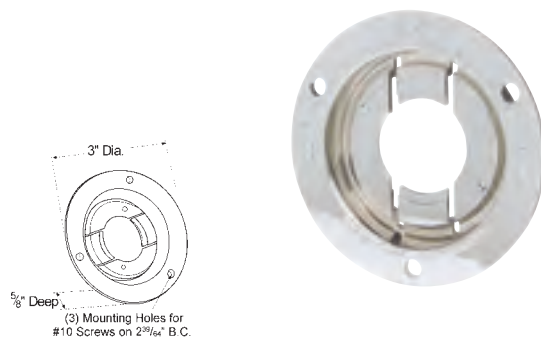

THEFT-RESISTANT MOUNTING FLANGE FOR 2" ROUND LAMPS

Patented twist-in locking system keeps lamp from backing out • Ideal for LED lighting • For use with 2" LED and incandescent lamps • Requires 2 1/4" mounting hole

- 43150** Gray, Polycarbonate
- 43152** Black, Polycarbonate
- 43153** Chrome-Plated, ABS

Material: Polycarbonate/ABS
Finish: Gray/Black/Chrome



SURFACE MOUNT BRACKET WITH GROMMET FOR 2" ROUND LAMPS

4 1/4" mounting screw hole spacing

- 93760** Gray

Material: Polycarbonate
Finish: Gray
Grommet: 92120

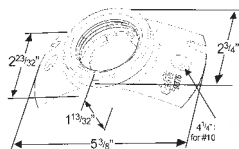

LICENSE LAMP MOUNTING BRACKET

Anti-glare shield eliminates stray light from distracting following motorists

- 43040** White

Material: Polycarbonate
Finish: White

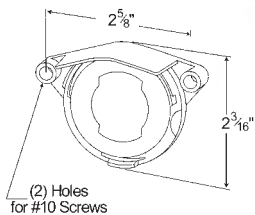

RECESSED MOUNTING GROMMET FOR 2 1/2" ROUND LAMPS

• Requires 2 25/32" hole • Fits panel thickness up to 1/8"

- 91400** Open Grommet
- 92070** Closed Back Grommet

KITS:

- 94010** Open Grommet (91400 + 67050)

Material: PVC
Finish: Black

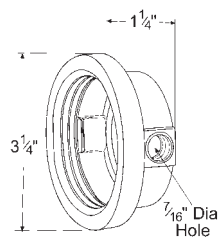

RECESSED MOUNTING GROMMET FOR 2 1/2" ROUND LAMPS

- Requires 3" hole • Fits panel thickness up to 1/4"

91410 Open Grommet

KITS:

94000 Open Grommet (91410 + 67050)

Material: PVC
Finish: Black

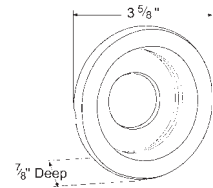

45° ANGLED BEVELED-EDGE RECESSED MOUNTING GROMMET FOR 2 1/2" ROUND LAMPS

- Fits 2 3/4" hole • Open back fits panel thickness up to 3/16", closed back fits up to 3/8"

91880 Open Grommet

92920 Closed Back Grommet

Material: PVC
Finish: Black

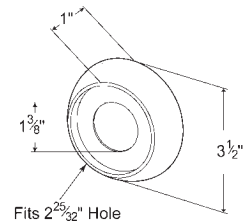

SURFACE MOUNT GROMMET FOR 2 1/2" ROUND LAMPS

Protective brass eyelets for mounting screw

91890 Open Grommet

Material: PVC
Finish: Black

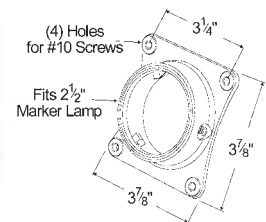

THEFT-RESISTANT MOUNTING FLANGE FOR 2 1/2" ROUND LAMPS

- Patented twist-in locking system keeps lamp from backing out • Ideal for LED lighting • Fits 2 1/2" LED and incandescent lamps • Requires 2 5/8" mounting hole

MOUNTING FLANGE:

43160 Gray, Polycarbonate

43162 Black, Polycarbonate

43163 Chrome-Plated, ABS

PIGTAIL RETENTION CAP:

93670 Gray

Material: Polycarbonate/ABS
Finish: Gray/Black/Chrome

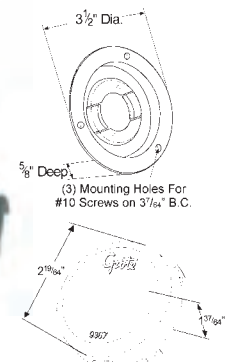

Pigtails, Brackets and Grommets

Spirales de Raccord, Bague de Montage et Supports Conectores / Soportes rígidos y flexibles

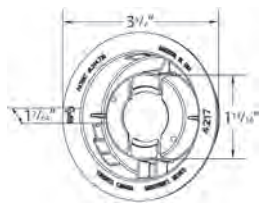

(3) Mounting Holes For #10 Screw on 3/16" B.C.

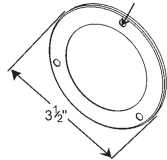

SNAP-IN MOUNTING FLANGE FOR 2 1/2" ROUND LAMPS

Flange is held into place by snap tabs for a quicker, easier installation

- Snap tabs on the flange lock the flange into place, keeping it from backing out of the hole
- Foam gasket allows for mounting in materials from 1/8" to 1/4" thick
- Requires 2 25/32" mounting hole

MOUNTING FLANGE:

42170 Gray

CAP:

93860 Gray

SECURITY RING:

43823 Stainless Steel

Material: Polycarbonate/Stainless Steel
Finish: Gray/Chrome

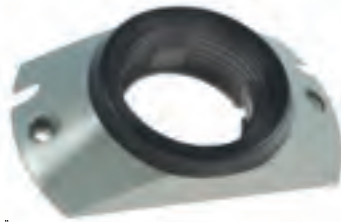

SURFACE MOUNTING BRACKET WITH GROMMET FOR 2 1/2" ROUND LAMPS

- Includes grommet 91400
- 4 3/4" mounting screw hole spacing

93750 Gray

Material: Polycarbonate/PVC
Finish: Gray/Black

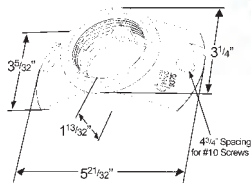

TWIST-IN SURFACE MOUNT BRACKET FOR 2" AND 2 1/2" ROUND LAMPS

- 4" mounting screw hole spacing

43690 Gray

KITS:

43430 Gray (43690 + 67050)

Material: Polycarbonate
Finish: Gray

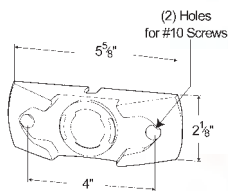

TWIST-IN SURFACE MOUNT BRACKET FOR 2" AND 2 1/2" ROUND LAMPS

- 3" mounting screw hole spacing
- Supports the use of PC-rated lamps for greater visibility

42180 Gray

Material: Polycarbonate
Finish: Gray

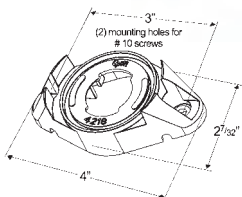

4 5/8" CORNER RADIUS SURFACE MOUNT BRACKET FOR 2" AND 2 1/2" ROUND LAMPS

Fits 4 5/8" corner radius • Use with PC-rated lights

43760 Gray

Material: Polycarbonate
Finish: Gray

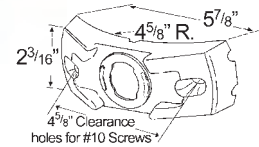

90° ANGLE MOUNTING BRACKET FOR 2" AND 2 1/2" ROUND LAMPS

Baked black enamel finish • Grommet required for mounting • 2 1/4" mounting screw hole spacing

FOR 2 1/2" LAMPS:

43512 Accommodates 94010, 91400, 92070 Grommets (2 25/32" Hole)

43522 Accommodates 94000, 91410 Grommets (3" Hole)

FOR 2" LAMPS:

43532 Accommodates 94100, 92120, and 92150 Grommets (2 5/16" Hole)

Material: Steel
Finish: Black Enamel

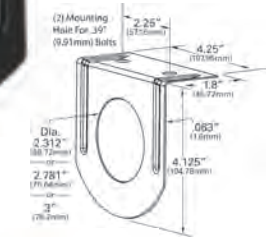

BAR LAMP BRACKET FOR 2" AND 2 1/2" ROUND LAMPS

Includes chassis ground UBS harness with blunt-cut power feed

49140 Black

Material: Steel
Finish: Black Enamel
Accessory: Harness: 67740

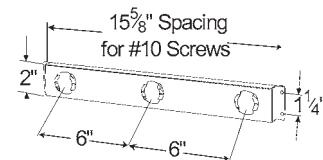

GROMMET FOR SMALL RECTANGULAR LAMPS

Requires 1 1/2" x 2 7/8" hole (with 3/8" radius corners) • Fits panel thickness up to .2"

91380 Black

Material: PVC
Finish: Black

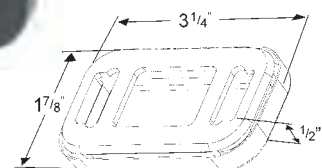

Pigtails, Brackets and Grommets

Spirales de Raccord, Bague de Montage et Supports Conectores / Soportes rígidos y flexibles

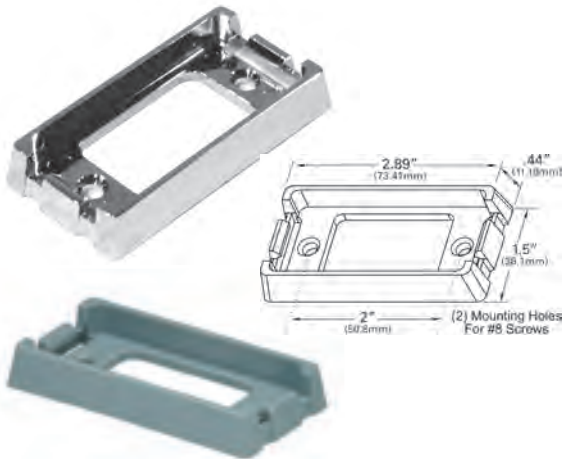

BRACKET FOR SMALL RECTANGULAR LAMPS

2" mounting screw hole spacing • Kits include pigtail and mounting pad

94233 Chrome-Plated

KITS:

43970 Gray

43980 Chrome-Plated

Material: Polycarbonate/ABS
Finish: Chrome/Gray

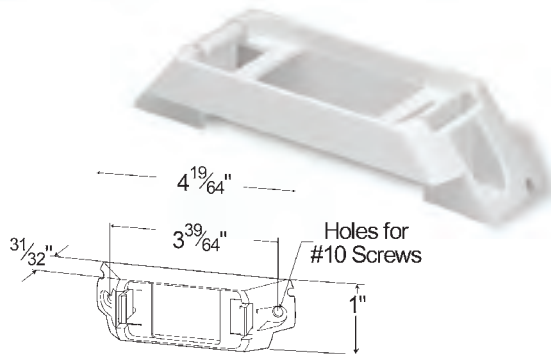

RAIL-MOUNT BRACKET FOR SMALL RECTANGULAR LAMPS

Mountable at 45° angle for PC applications • Cut-out design for rail mountings • 3 39/64" mounting screw hole spacing • Kit includes single-seal pigtail

42131 White

KITS:

43370 White (42131 + 67050)

Material: Polycarbonate
Finish: White

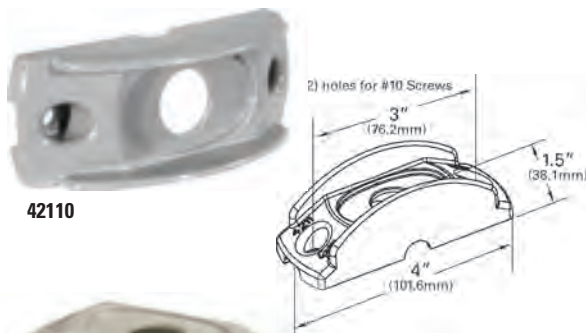

42110

SURFACE MOUNT BRACKET FOR MICRONOVA® OR MICRONOVA DOT

Armored design to protect the lamp from damage • 3" mounting screw hole spacing (2 3/4" spacing for radius bracket)

42110 Gray

42112 Black

42120 Gray, Corner Radius Bracket

Material: Polycarbonate
Finish: Gray/Black



42120

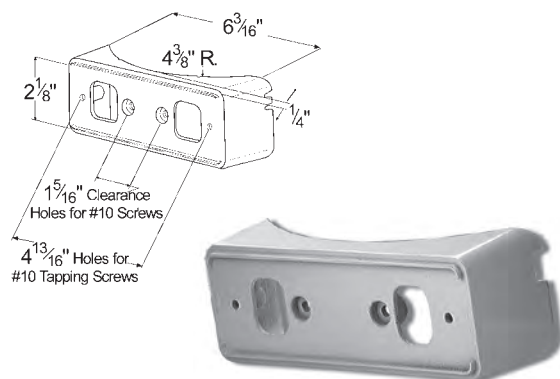

4 3/4" CORNER RADIUS BRACKET

For use with PC-rated lights • 4 13/16" mounting screw hole spacing • works with Turtleback® II style lamps

43050 Gray

Material: Polycarbonate
Finish: Gray

HEADER-MOUNT BRACKET FOR SMALL RECTANGULAR LAMPS

Mountable at 45° angle for PC applications • Narrow rail applications
 • 3 39/64" mounting screw hole spacing • Kit includes single-seal pigtail

42141 White

KITS:
43380 White (42141 + 67050)

Material: Polycarbonate
 Finish: White

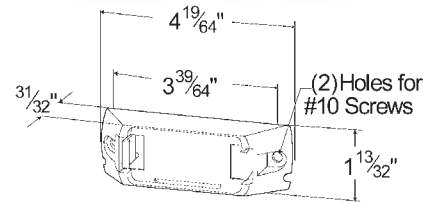

GROMMET FOR SMALL RECTANGULAR LAMPS

• Requires 2 1/2" x 3 1/2" hole (with 17/32" corners) • Fits panel thickness up to 3/16"

93400 White

93402 Black

Material: PVC
 Finish: Black/White

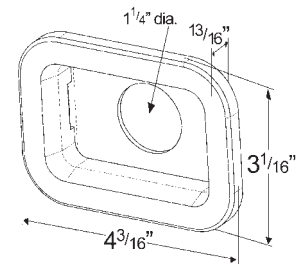
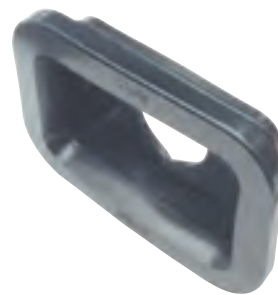

MICRONOVA® LAMP BEZEL

Corrosion resistant, chrome-plated • Snap-fit mounting

93803 Chrome-Plated

Material: ABS
 Finish: Chrome

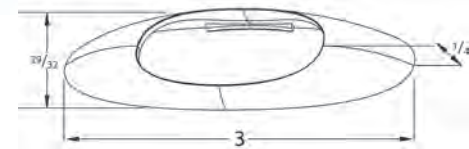

LICENSE LAMP BRACKET FOR SMALL RECTANGULAR LAMPS

Anti-glare shield eliminates stray light from distracting following motorists
 • 3" mounting screw hole spacing • Snap-in lamp installation

42162 Black

Material: Polycarbonate
 Finish: Black

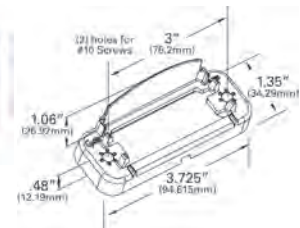

LICENSE LAMP MOUNTING BRACKET

Features Snap-in lamp installation • Fits license lamp 60671, 60261, 60601
 Anti-glare shield eliminates stray light from distracting following motorists
 • 2" mounting screw hole spacing

43960 Gray

43962 Black

Material: Polycarbonate
 Finish: Gray/Black

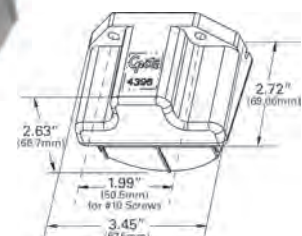

Pigtails, Brackets and Grommets

Spirales de Raccord, Bague de Montage et Supports Conectores / Soportes rígidos y flexibles

© 2015 All rights reserved. Grote Industries, Inc. PIGTAILS, BRACKETS AND GROMMETS

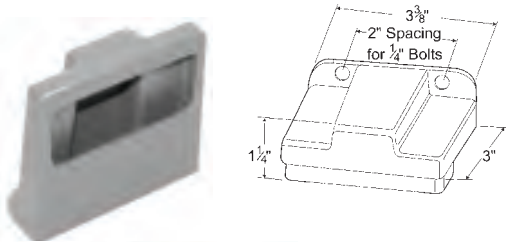

LICENSE LAMP MOUNTING BRACKET

Fits license lamp 60261 • 2" mounting screw hole spacing • Thin design reduces mounting space requirements

43830 Gray

Material: Polycarbonate
Finish: Gray
Grommet: 92520

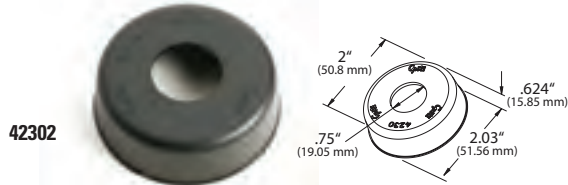

42302

MICRONOVA® DOT ROUND ADAPTER BRACKETS

Assembles directly into 2" and 2.5" PVC grommets • Replaces any incandescent or LED 2" or 2.5" round clearance/marker • Flanges torque to a maximum of 25 in-lbs and mount with three #10 pan or round head screws into existing hole patterns of 2" and 2.5" flanges

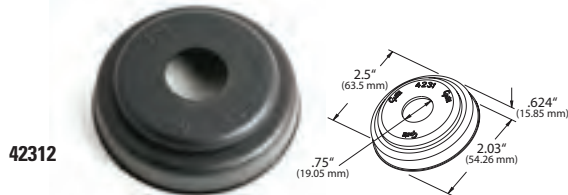

42312

- 42302** 2" Round Grommet Adapter
- 42312** 2.5" Round Grommet Adapter
- 42292** 3" Round Flange Adapter
- 42282** 3.5" Round Flange Adapter

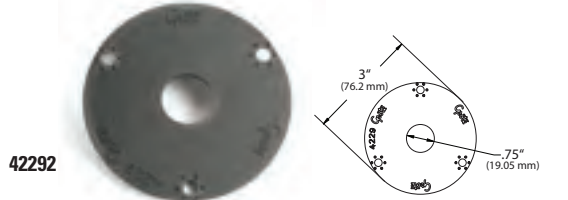

42292

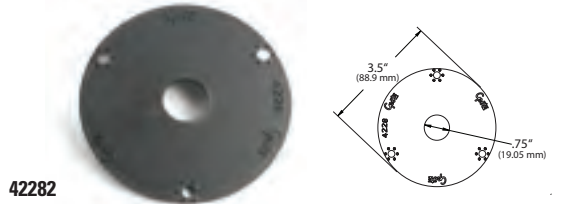

42282

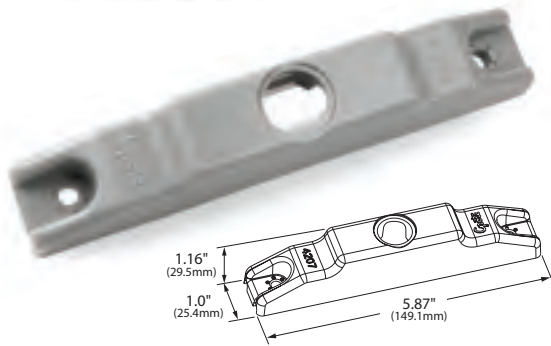

MICRONOVA® SURFACE MOUNT BRACKET

4 13/16" mounting hole separation provides easy retrofit • Great for narrow surface mounting applications

42070 Gray

Material: Polycarbonate
Finish: Gray

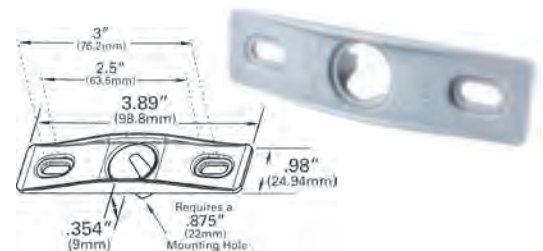

MICRONOVA® DOT ADAPTER BRACKET

Allows the MicroNova® DOT to mount directly to the vehicle using this bracket or snap-fit into compatible 4378 series mounting brackets • 2 1/2" - 3" mounting screw hole spacing

94350 Gray

Material: Polycarbonate
Finish: Gray



MOUNTING BRACKET FOR LARGE RECTANGULAR LAMPS

- 3" mounting screw hole spacing
- Kits include unique connector design with plug-in pigtail

- 43780** Gray Bracket
43783 Chrome-Plated Bracket, ABS

- KITS:**
43390 Gray (43780 + 66981)
43790 Gray (43780 + 66980)

Material: Polycarbonate/ABS
 Finish: Gray/Chrome

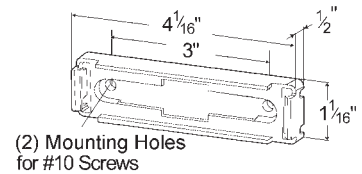

LOW PROFILE MOUNTING BRACKET

- Integrated plug connection
- Legal mount for combination clearance/ marker lamp when mounted on a 45° angle (PC)
- 3" mounting screw hole spacing

- 43850** Gray

Material: Polycarbonate
 Finish: Gray

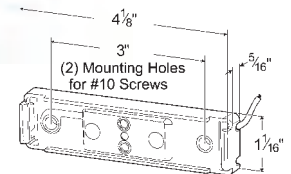

M3 SERIES LAMP BEZEL

For use with M3 style cab markers

- 93473** Chrome

Material: ABS
 Finish: Chrome

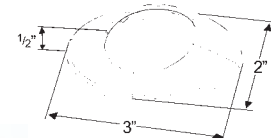

M1 SERIES LAMP BEZEL

For use with M1 style cab markers

- 93453** Chrome

Material: ABS
 Finish: Chrome

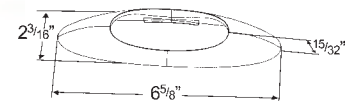

SMALL CAB MARKER BEZEL

Can be installed while lamps are mounted

- 92583** Bezel

Material: ABS
 Finish: Chrome

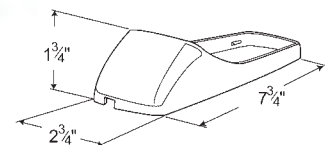

THIN-LINE LED LAMP GUARD

- Cutaway to accept plug-in pigtail
- For use with 4690, 4692, and 4693 series lamps

- 43074** Aluminum

Material: Aluminum
 Finish: Aluminum

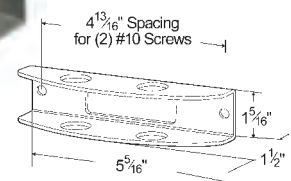

Pigtails, Brackets and Grommets

Spirales de Raccord, Bague de Montage et Supports Conectores / Soportes rígidos y flexibles

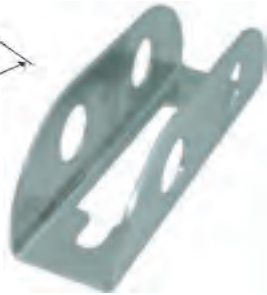
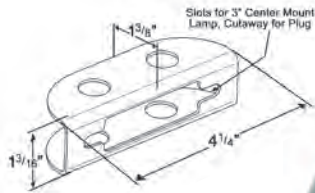

THIN-LINE 3" LAMP GUARD

Cutaway to accept plug-in pigtail • For use with Supernova® thin line lamps

43230 Aluminum

Material: Aluminum
Finish: Aluminum

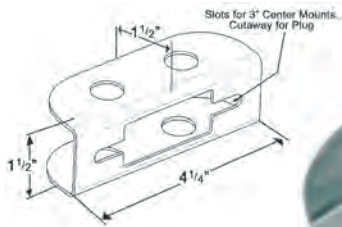

LAMP GUARD FOR SMALL RECTANGULAR LAMPS

Cutaway to accept plug-in pigtail

43120 Aluminum

Material: Aluminum
Finish: Aluminum

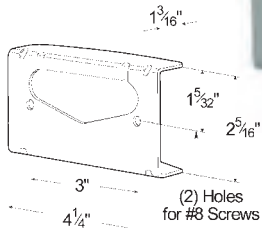

STEEL LAMP GUARD

For use with 2" x 4" oval and square corner surface mount clearance/marker lamps • 3" mounting screw hole spacing

43144 Steel

Material: Steel
Finish: Silver

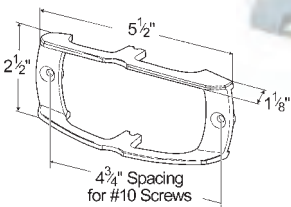

CHROME BUTTRESS-STYLE LAMP GUARD

For use with 2" x 4" oval and square corner surface mounted lamps • 4 3/4" mounting screw hole spacing

43673 Chrome-Plated

43673-5 Chrome-Plated RETAIL

Material: ABS
Finish: Chrome

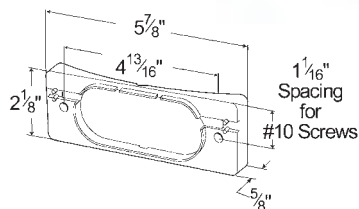

9 1/2" CORNER RADIUS BRACKET

PC-regulation mount for Turtleback® II • 4 13/16" mounting screw hole spacing

43030 White

Material: Polycarbonate
Finish: White

RECESSES MOUNTING GROMMET FOR 4" ROUND LAMPS

Requires 4 1/2" mounting hole • Fits panel thickness up to 1/4"

91740 Grommet

KITS:

67150 Grommet w/Pigtail (91740 + 67000)

Material: PVC
Finish: Black



CLOSED BACK RECESSED MOUNTING GROMMET FOR 4" ROUND LAMPS

For open installations where splash plate is not used • Requires a 4 1/2" mounting hole • Fits panel thickness up to 1/4"

91950 Grommet

Material: PVC
Finish: Black

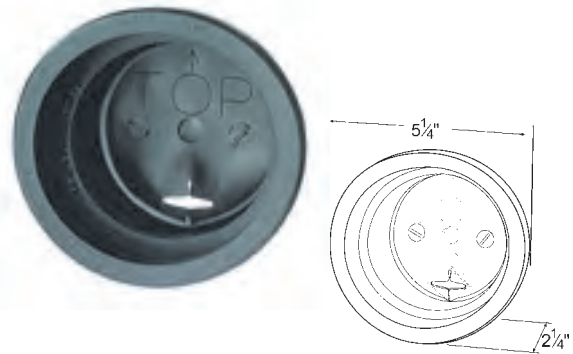

STAINLESS STEEL SNAP-IN THEFT-RESISTANT MOUNTING FLANGE FOR 4" ROUND LED LAMPS

Foam gasket allows for mounting in materials from 1/8" to 1/4" thick • Requires 4 1/2" mounting hole • No drilling necessary to install

93683 Stainless Steel

Material: Stainless Steel
Finish: Stainless Steel

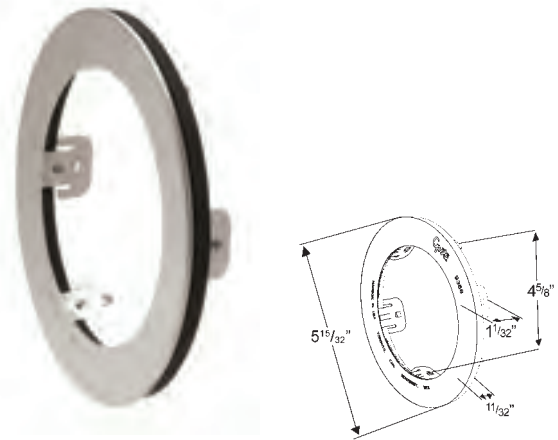

SNAP-IN THEFT-RESISTANT MOUNTING FLANGE FOR 4" ROUND LED LAMPS

Fits panel thickness 1/8" to 1/4" • Requires 4 1/2" mounting hole

93552 Black
93553 Chrome-Plated

Material: ABS
Finish: Black/Chrome

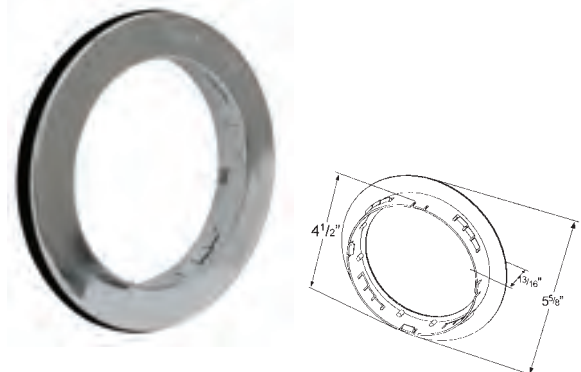

Pigtails, Brackets and Grommets

Spirales de Raccord, Bague de Montage et Supports Conectores / Soportes rígidos y flexibles

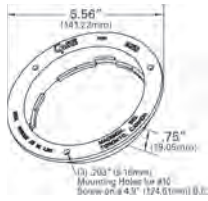

(3) Mounting Holes for #10 Screw on 4 1/2" B.C.

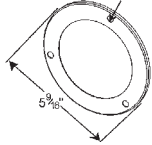

43343



THEFT-RESISTANT MOUNTING FLANGE FOR 4" ROUND LAMPS

For use with 4" round LED and incandescent lamps • Mounting hole size 4 1/2" diameter

- 92510 White, Polycarbonate
- 92512 Black, Polycarbonate
- 92513 Chrome-Plated, ABS
- 92511 Gray, Polycarbonate
- 43253 Stainless Steel

SECURITY RING

- 43343 Stainless Steel Security Ring (must be used with flange)

Material: Polycarbonate; Stainless Steel; ABS
Finish: White; Gray; Black; Chrome; Stainless Steel

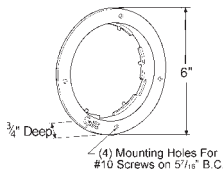

(4) Mounting Holes For #10 Screws on 5 1/8" B.C.



THEFT-RESISTANT BETTS LIGHTING MOUNTING ADAPTER

Allows users to retrofit their Betts® brand lighting to Grote mounting dimensions • Retrofits to Grote 4" round sealed lamps and LEDs
• Requires 4 1/2" diameter mounting hole

- 93190 Gray

Material: Polycarbonate
Finish: Gray

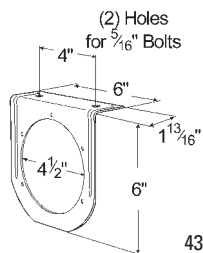

43572



ANGLED MOUNTING BRACKET FOR 4" ROUND LAMPS

Accepts lamp equipped with a grommet or flange • 4" mounting screw hole spacing

- 43572 Black, 90° angle bracket
- 42052 Black, 45° angle bracket

Material: Steel
Finish: Black Powder Coated
Grommet: 91740

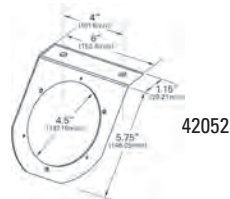

42052



MOUNTING MODULE FOR 4" ROUND LAMPS

Closed back, rear lamp module for lamps requiring 4 1/2" mounting hole opening • Accepts lamps equipped with a grommet or flange

- 43655 Yellow Zinc
- 51090 Gray

Material: Steel
Finish: Yellow Zinc/Gray Powder Coated

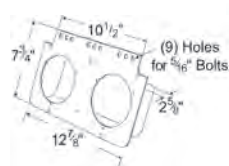

(9) Holes for 3/16" Bolts

2-LAMP MOUNTING MODULE FOR 4" ROUND LAMPS

Two 4 1/2" mounting holes to hold standard recessed lamps or grommet-mounted 4" round lamps • Accepts lamps equipped with a grommet or flange • #10 mounting screw hole in center accepts 2 1/2" round reflector

43642 Black, Powder Coated

Material: Steel
Finish: Black

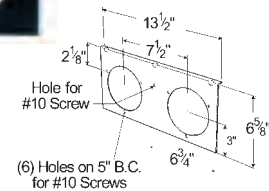

MOUNTING MODULE FOR 4" ROUND LAMPS

Black enamel-coated steel construction • Use with 4" LED strobes or any 4" round lamp • Accepts lamp equipped with a grommet or flange

43732 Black

Material: Steel
Finish: Black

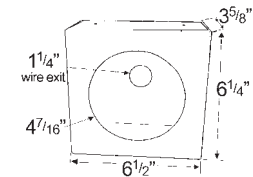
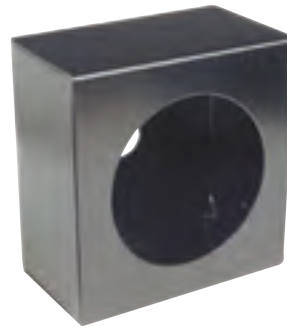

O - RING

94110 O-Ring for use with 46782 and 46783 lamps.

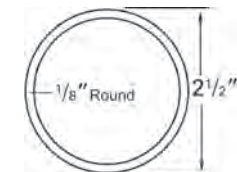

SNAP RING

99593 Use with 50222 and 50352
99595 Use with 50232 and 55092

Material: Stainless Steel
Finish: Stainless Steel



RECESSED MOUNTING GROMMET FOR 6" OVAL LAMPS

Fits 2 1/2" x 6 3/4" oval mounting hole • Fits panel thickness up to 1/4"

92420 Open Grommet
92720 Closed Back Grommet

KITS:
67151 Open Grommet (92420 + 67000)

Material: PVC
Finish: Black

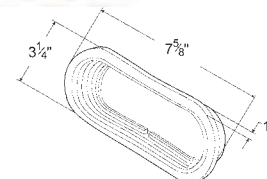

Pigtails, Brackets and Grommets

Spirales de Raccord, Bague de Montage et Supports Conectores / Soportes rígidos y flexibles



SURFACE MOUNT SNAP-IN BRACKET FOR 6" OVAL LAMPS

Allows for quick and easy surface mount application • Designed to work with 5413, 5414, 5416, 5417 product lines only. • 6" mounting screw hole spacing

42152 Black, Polycarbonate
42153 Chrome, ABS

Material: Polycarbonate/ABS
Finish: Black/Chrome



SURFACE MOUNT BRACKET FOR 6" OVAL LAMPS

Can be used with any Grote 6" oval LED or incandescent lamp • Ideal for adding LED strobe lamps to a vehicle • 7 5/16" mounting screw hole spacing

43172 Black

Material: Polycarbonate
Finish: Black

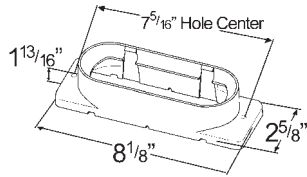

THEFT-RESISTANT MOUNTING FLANGE FOR 6" OVAL LAMPS

For use with most LED and incandescent lamps • Security ring fits over oval theft resistant mounting flanges • 7 1/4" x 3" mounting screw hole spacing

43220 Gray, Polycarbonate
43222 Black, Polycarbonate
43223 Chrome-Plated, ABS
43723 Stainless Steel

SECURITY RING

42103 Stainless Steel Security Ring (must be used with flange)

Material: Polycarbonate/Stainless Steel/ABS
Finish: Gray/Black/Stainless Steel/Chrome

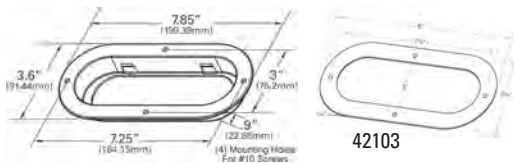

ANGLED MOUNTING BRACKET FOR 6" OVAL LAMPS

Accepts lamp equipped with a grommet or flange • 6 1/4" mounting screw hole spacing

43362 Black, 90° angle bracket

Material: Steel
Finish: Black
Grommet: 92420

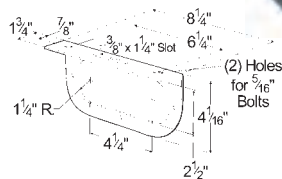

"Z" MOUNTING BRACKET FOR 6" OVAL LAMPS

Heavy gauge steel, baked black enamel finish • Accepts lamp equipped with a grommet or flange • 6 1/4" mounting screw hole spacing

43952 Black

Material: Steel
Finish: Black
Grommet: 92420

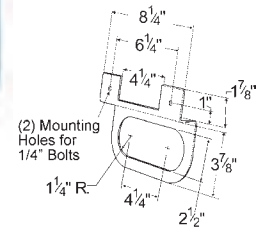

MOUNTING BRACKET FOR 7" ROUND LAMPS

Heavy gauge steel • For use with 7800, 7830 and 7831 series lamps

43282 Black, Powder Coated

Material: Steel
Finish: Black

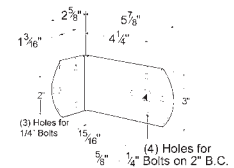

MOUNTING BRACKET FOR UTILITY LAMPS

Detachable angle mounting bracket for utility work lamps with standard 3/8" mounting

43292 Black, Powder Coated

Material: Steel
Finish: Black

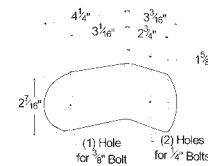

MOUNTING BRACKET FOR 6" OVAL LAMPS AND STROBES

Accepts lamp equipped with a grommet or flange • 8 1/4" mounting screw hole spacing

43100 Black

Material: Steel
Finish: Black
Grommet: 92420

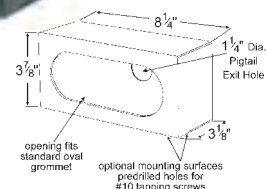

90° ANGLE BRACKET FOR RECTANGULAR STOP/TAIL/TURN LAMPS

Rugged 11 gauge steel construction • Black enamel-coated finish • 4" mounting screw hole spacing • Accepts lamp equipped with a grommet

43212 Black

Material: Steel
Finish: Black

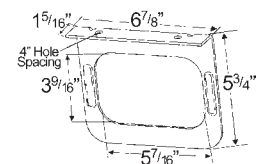

Pigtails, Brackets and Grommets

Spirales de Raccord, Bague de Montage et Supports Conectores / Soportes rígidos y flexibles

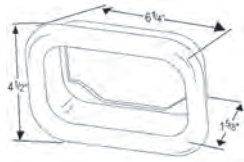

RECESSED MOUNTING GROMMET FOR RECTANGULAR LAMPS

Requires 5 7/16" x 3 9/16" mounting hole with 1" radius corners
 • Fits panel thicknesses up to 5/16"

94180 Mounting Grommet

Material: PVC
 Finish: Black

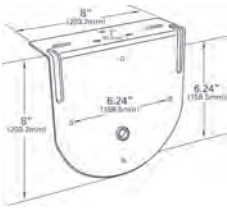

90° ANGLE BRACKET FOR 7" ROUND LAMPS

Provides multiple mounting options for flush mount 7" round lamps

93982 Black, Powder Coated

Material: Steel
 Finish: Black

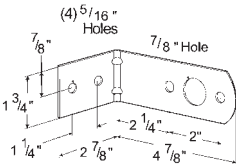

MOUNTING BRACKET FOR PEDESTAL LAMPS

For use with right- or left-hand 2-stud class "A" pedestal lamps

43112 Black, Powder Coated

Material: Steel
 Finish: Black

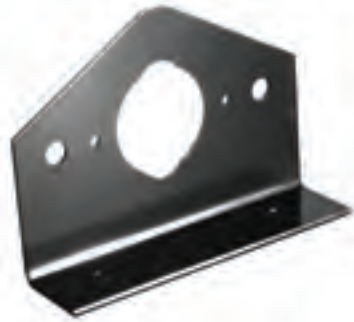

4/5/6 POLE KNOCKOUT MOUNTING BRACKET

Can accommodate 4-pole to 6-pole socket requirements • Made of anti-corrosive steel, painted black

43942 4 and 6 pole socket bracket

Material: Steel
 Finish: Black

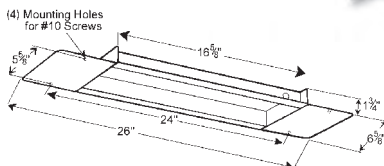

RECESSED FLUORESCENT LAMP PAN

Provides a rigid mounting surface for fluorescent lamps • Fits Grote's fluorescent lamp 61511 • Keeps insulation away from lamp

43540 Recessed Pan

Material: Aluminum
 Finish: Polished

12" RECESSED MOUNTING PAN FOR 7" LED DOME LAMPS

Provides a rigid mounting surface for LED lamps • Fits Grote® LED 61811 and 61061 lamps • Grommet available for wire exit hole, 60-1000-06 • Keeps insulation away from lamp

43744 Recessed Pan

Material: Aluminum
Finish: Aluminum



SLOW-MOVING VEHICLE EMBLEM BRACKETRY

Easy installation • Use with slow moving vehicle emblem 71152 (emblem not included)

EMBLEM BRACKET:

43325 Steel

MOUNTING BRACKET:

43335 Steel

Material: Steel
Finish: Galvanized

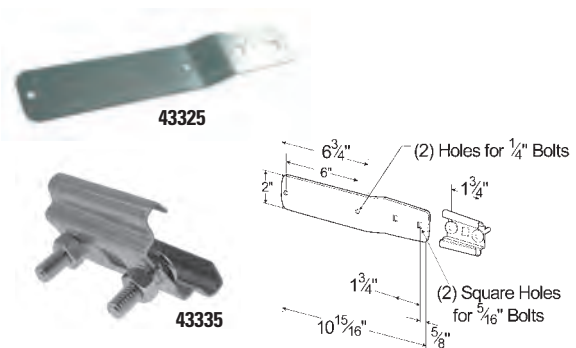

STROBE AND BEACON MOUNTING ADAPTER FOR MIRROR BRACKET ASSEMBLY

Allows for mounting of strobe and beacon warning lamps to mirror bracket assembly

PIPE MOUNT:

93600 Aluminum/Steel Bracket w/ 1" Built-in Mount

Material: Aluminum / Steel
Finish: Gray

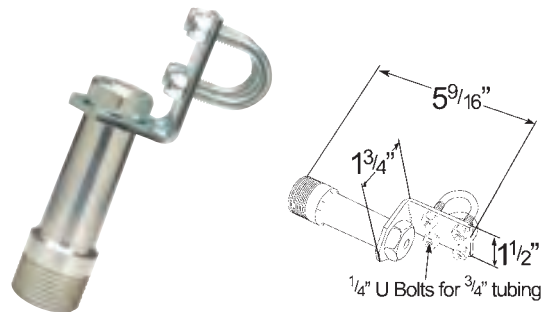

STROBE MOUNTING KIT

Use with low-, medium-, and high-profile strobe lamps • Includes an adhesive magnet pad to prevent scratching of vehicle surface

97750 Magnet Kit & Lighter Plug



REPLACEMENT MAGNETIC MOUNT

Can be used as a magnetic mount on PAR 36 rubber tractor and utility lamps • Has adhesive magnet pad to prevent scratching of vehicle • 80 lbs. pull magnet

43300 Magnetic Mount

Material: Steel
Finish: Chrome



Pigtails, Brackets and Grommets

Spirales de Raccord, Bague de Montage et Supports Conectores / Soportes rígidos y flexibles

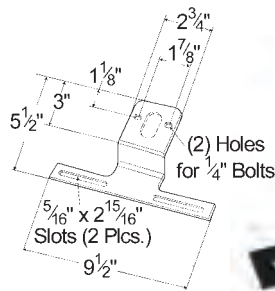

UNIVERSAL OFFSET LICENSE PLATE BRACKET

For use with most standard two-stud box-style lamps and license plates

43262-5 Black **RETAIL**

Material: Polypropylene
Finish: Black

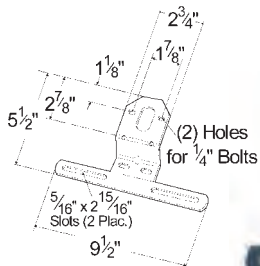

UNIVERSAL STEEL OFFSET LICENSE PLATE BRACKET

For use with most standard two-stud box-style lamps and license plates

43022 Black, Powder Coated
43022-5 Black, Powder Coated **RETAIL**

Material: Steel
Finish: Black

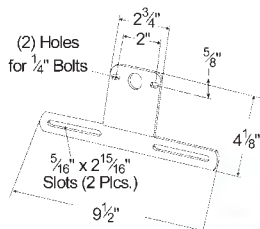

UNIVERSAL STEEL LICENSE PLATE BRACKET

For use with most standard two-stud box-style lamps and license plates

43272 Black, Powder Coated
43272-5 Black, Powder Coated **RETAIL**

Material: Steel
Finish: Black

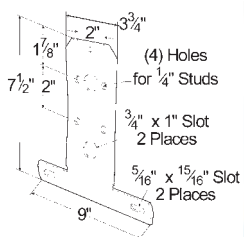

UNIVERSAL STEEL LICENSE PLATE BRACKET

For use with most standard two- or three-stud box-style lamps and license plates

43842 Black, Powder Coated

Material: Steel
Finish: Black

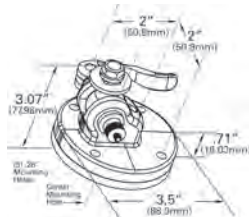

ADJUSTABLE BRACKET FOR TRILLIANT® LAMPS

Adjustable and lockable bracket for the Trilliant® LED Whitelight™ lamps

- Provides more aiming control and more reliability than the standard bracket
- Cantilever locking mechanism stays in place in even the harshest environments

43651 Bracket, White
43652 Bracket, Black

Material: Zinc
Finish: Black or White

FLUSH-MOUNT WORK LAMP BRACKET

Add-on bracket to convert the Trilliant® Mini LED Work Lamp into a flush-mount lamp

94690 Stainless Steel

Material: Stainless Steel
Finish: Stainless Steel

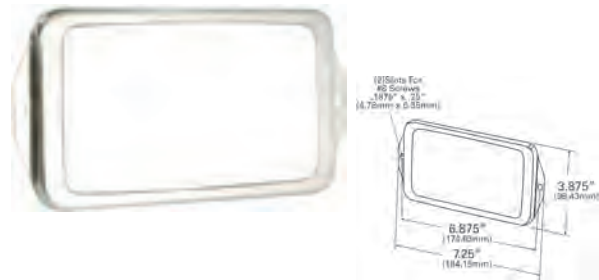

PAR 36 RUBBER TRACTOR HOUSING

Shock-absorbing, weather-proof body • Swivel mount

64930 Black

Material: Rubber
Finish: Black

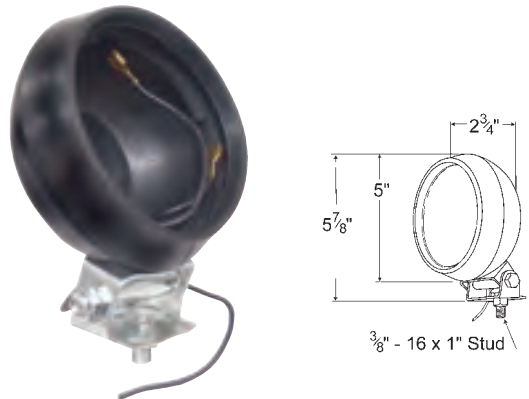

VINYL PERMIT HOLDER

Laminated for all-weather protection • Sealing zipper for easy insertion of paper

43411 Vinyl

Material: Vinyl/Aluminum
Finish: Green/Aluminum

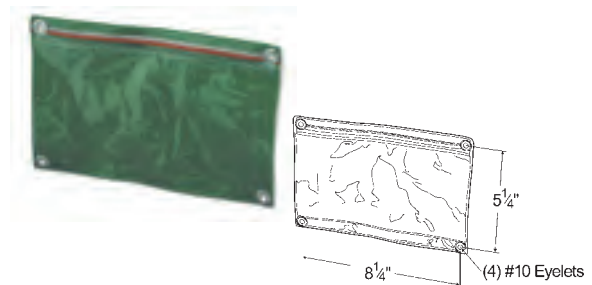

ALUMINUM PERMIT HOLDER

Heavy-formed, rustproof housing • Includes vinyl pouch
• 6 3/8 inch mounting screw hole spacing

43424 Aluminum

Material: Aluminum w/ Vinyl Pouch
Accessory: Vinyl Pouch: 43441

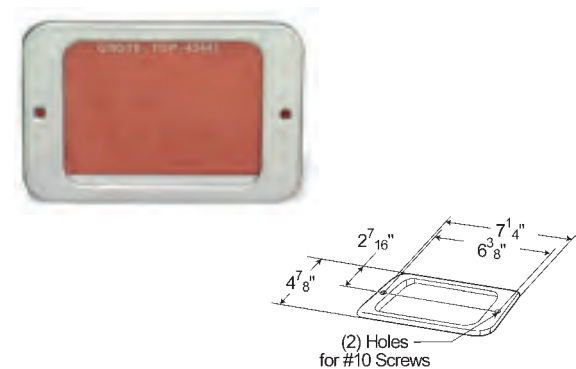

Pigtails, Brackets and Grommets

Spirales de Raccord, Bague de Montage et Supports Conectores / Soportes rígidos y flexibles



DOCUMENT HOLDER

Rugged construction • Chemical-resistant, Ray-Ban® colored lens now has a darker tint • Comes with document protector polybag • Two mounting options for flexibility • Can be installed using pop-rivets

43901 Gray

Material: Polycarbonate
Finish: Gray/Smoke
Lens: Smoke 93351



ELECTRICAL SEALANT

Special dielectric silicone compound seals out moisture, salt and corrosives.
• Protects plug-ins and other electrical fittings

99580 1 1/4 Oz. Tube



ULTRA-SEAL CORROSION-PREVENTIVE SEALANT

Cost-effective product prevents rust and corrosion • Good mechanical stability • Added tackifiers improve adhesion and resistance to washout
• Has a 25% higher non-conductivity rating compared to the competition
• Operating range -40°F to 302°F

99170 4 oz. (118 ml.) Tube

99180 8 oz. (236 ml.) Tub

99170-GT 14 oz. (414 ml.) Tub

RETAIL DISPLAY:

99170-1 Display (12 of 99170)

RETAIL