

## 4" LED STOP/TAIL/TURN WITH INTEGRATED BACK-UP LAMP

Innovative patent-pending design combines all Stop/Tail/Turn and Back-up functions into one industry standard size lamp • Symmetrical design meets legal requirements at any mounting angle • LED technology provides less maintenance costs and long life • Industry-standard design fits existing mounting grommets, brackets, and flanges • Reduces inventory, SKUs, and carrying costs

- 55162** Red, Hard Shell NEW
- 55202** Red, Stainless Steel, Theft Resistant Flange, Hardshell NEW
- 55212** Red, Gray, Theft Resistant Flange, Hardshell NEW

Material: Lens: Red/Clear Polycarbonate; Housing: Black Polycarbonate/ABS blend  
 Flange: Stainless Steel/Polycarbonate  
 FMVSS 108: I, S, T, R2  
 Voltage: 14 Volts Design Current  
 Current Draw: (±15%) @ 14V  
 Stop: Range 80mA - 185mA  
 Tail: Range 19mA - 22mA  
 Back-Up: 306mA



55162

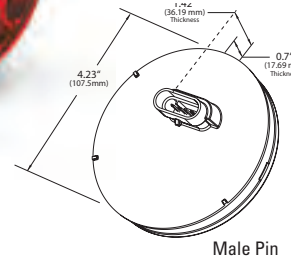

Male Pin

## SUPERNOVA® 4" 10-DIODE PATTERN LED STOP/TAIL/TURN LAMP

Lens design spreads light for maximum dispersion • Potted for total circuit board protection • Hermetic lens-to-housing seal • Advanced Pin Connection System uses tin-plated, solid brass pin terminals • Uses same UBS pigtail as male pin incandescent



53252

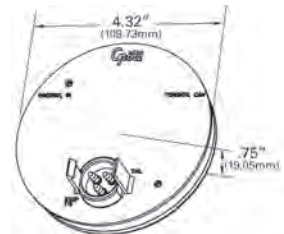

### STOP/TAIL/TURN:

- 53252** Red, Grommet Mount, Male Pin
- 53272** Red, Gray Theft-Resistant Flange, Male Pin
- 53282** Red, White Theft-Resistant Flange, Male Pin
- 53292** Red, Black Theft-Resistant Flange, Male Pin
- 53302** Red, Stainless Steel Theft-Resistant Flange, Male Pin
- 52092** Red, Grommet Mount, Male Pin 24
- 54622** Red, Integrated Flange w/ Gasket, Male Pin
- 53552** Red, Grommet Mount, Hard Shell
- 54032** Red, Gray Snap-In Flange, Hard Shell
- 54042** Red, Stainless Steel Snap-In Flange, Hard Shell
- 53532** Red, Grommet Mount, Hardwire

### STOP/TAIL/TURN KITS:

- 53462** Red, Male Pin, (53252 + 91740 + 67002)
- 53432** Red, Male Pin, (53302 + 67002)
- 53342** Red, Male Pin, (53252 + 66830)

### AUXILIARY:

- 53253** Yellow, Grommet Mount, Male Pin
- 52093** Yellow, Grommet Mount, Male Pin 24
- 53273** Yellow, Gray Theft-Resistant Flange, Male Pin
- 53293** Yellow, Black Theft-Resistant Flange, Male Pin
- 53303** Yellow, Stainless Steel Theft-Resistant Flange, Male Pin
- 53553** Yellow, Grommet Mount, Hard Shell

Material: Lens - Acrylic; Housing - ABS; Flange - Polycarbonate / Stainless Steel  
 FMVSS: S/T/T - I, P2, S, T; Auxiliary - P2  
 Finish: Red / Yellow  
 Volts / Amps: Red - 12V / .24A (I,S)/.03A (T)  
 Volts / Amps: Yellow - 12V / .15A (P2)  
 Volts / Amps: Red - 24V / .24A(I,S)/.03A (T)  
 Volts / Amps: Yellow - 24V / .12A (P2)  
 Bracket: 93552, 43253, 92510, 92512, 92513, 43572, 43642, 43655, 43732, 93190, 93553, 93683, 92511, 51090  
 Grommet: 91740, 91950  
 Pigtail: Male Pin: 66815, 67002, 66841, 66816, 67005, 66845  
 Hard Shell: 66861, 66862



53303

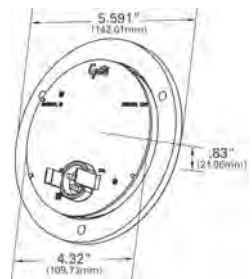

54622

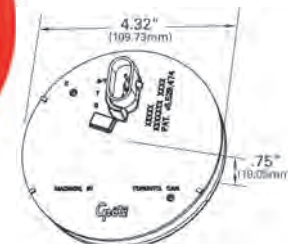
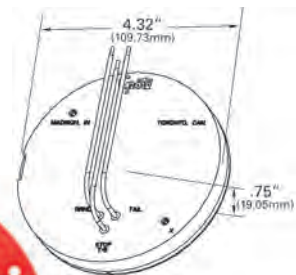

# Stop/Tail/Turn Lamps

Feux Arrêt / Arrière / Direction Lâmparas de Freno / Cuarto / Direccional

LED

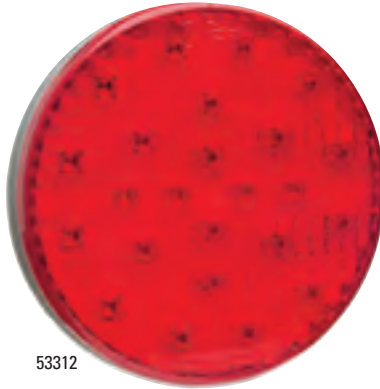

53312

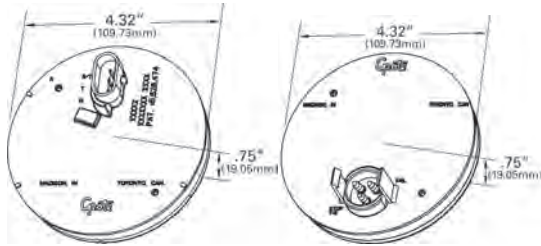

53523



53182

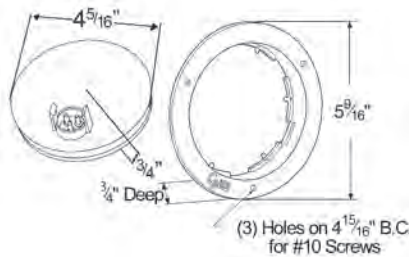

## SUPERNOVA® 4" FULL-PATTERN LED STOP/TAIL/TURN LAMP

Potted for total circuit board protection • Hermetic lens-to-housing seal  
 • Advanced pin connection system uses tin-plated, solid brass pin terminations

### STOP/TAIL/TURN:

- 53312 Red, Grommet Mount, Male Pin
- 52162 Red, Grommet Mount, Male Pin 24
- 53322 Red, White Theft-Resistant Flange, Male Pin
- 53182 Red, Black Theft-Resistant Flange, Male Pin
- 53192 Red, Stainless Steel Theft-Resistant Flange, Male Pin
- 54562 Red, Grommet Mount, Hard Shell

### 3 PIN REAR TURN:

- 53413 Yellow, Grommet Mount, Male Pin
- 53523 Yellow, Stainless Steel Theft-Resistant Flange, Male Pin
- 52163 Yellow, Grommet Mount, Male Pin 24

### FRONT PARK/TURN:

- 53313 Yellow, Grommet Mount, Male Pin

### 2 PIN REAR TURN:

- 55103 Yellow, Grommet Mount, Male Pin

Material: Lens - Acrylic; Housing - ABS  
 FMVSS: S / T / T - I, P2, S, T; Rear Turn - I; Front P / T - I, P  
 Finish: Red / Yellow  
 Volts / Amps: Red - 12V / .48A (I,S) / .04A (P2,T)  
 Volts / Amps: Rear Turn - 12V / .71A (I) / .14A (P2)  
 Volts / Amps: Front P/T - 12V / 1.06A (I) / .13A (P,P2)  
 Volts / Amps: Red - 24V / .2A (I,S) / .02A (P2,T)  
 Volts / Amps: Yellow - 24V / .34A (I) / .06A (P2)  
 Bracket: 93552, 43253, 92510, 92512, 92513, 43572, 43642, 43655, 43732, 93190, 93553, 93683  
 Grommet: 91740, 91950  
 Pigtail: Male Pin: 66815, 67002, 66841, 66816, 67005, 66845  
 Hard Shell: 66861, 66862

## SUPERNOVA® 4" NEXGEN™ LED STOP/TAIL/TURN

Less current draw than standard incandescent lamps, leaving more power available to other vehicle systems • Uses existing pigtails and wiring for cost-effective retrofit • 20% less current draw than major competitor LED products • Fits all Grote bracket and grommet mounting options • Fully encapsulated circuitry for total circuit board protection • Similar look to incandescent light, which helps prevent theft

### STOP/TAIL/TURN:

- 54332** Red, Grommet Mount, Male Pin
- 54472** Red, Gray Flange, Male Pin
- 54482** Red, Black Flange, Male Pin
- 54492** Red, Stainless Steel Flange, Male Pin
- 54602** Red, Integrated Flange w/ Gasket, Male Pin
- 54362** Red, Grommet Mount, Hard Shell
- 54572** Red, Integrated Flange w/ Gasket, Hard Shell
- 54582** Red, Integrated Flange w/ Gasket, Hardware

### AUXILIARY:

- 54333** Yellow, Grommet Mount, Male Pin
- 54483** Yellow, Black Flange, Male Pin
- 54493** Yellow, Stainless Steel Flange, Male Pin
- 54363** Yellow, Grommet Mount, Hard Shell

### 2-PIN TURN LAMP:

- 54643** Yellow, Grommet Mount, Male Pin
- 54633** Yellow, Integrated Flange w/ Gasket, Male Pin

Material: Lens - Acrylic; Housing - ABS  
 FMVSS: S / T / T-1, P2, S, T- Auxiliary - P2  
 Finish: Red / Yellow  
 Volts / Amps: 12V / .24A (I,S) / .03A (T)  
 Bracket: 93552, 43253, 92510, 92511, 92512, 92513, 43572, 43642, 43655, 43732, 93190, 93683, 51090  
 Grommet: 91740, 91950  
 Pigtail: Male Pin: 66815, 67002, 66841, 66816, 67005, 66845; Hard Shell: 66861, 66862

## HI COUNT® 4" LED STOP/TAIL/TURN LAMP

Standard female connection accepts all popular plug-in connectors  
 • Concentric, high-count diode design: 24 in red, 39 in yellow • Fits all popular mountings and grommets

### STOP/TAIL/TURN:

- G4002** Red
- G4002-5** Red **RETAIL**
- G4022** Red, Clear Lens

### STOP/TAIL/TURN KIT:

- G4012** Red (G4002 + 91740 + 67090)

### AUXILIARY:

- G4003** Yellow
- G4003-5** Yellow **RETAIL**
- G4023** Yellow

Material: Lens - Acrylic; Housing - ABS  
 FMVSS: Red - I, P2, S, T; Yellow - Auxiliary  
 Finish: Red / Yellow  
 Volts / Amps: Red - 12V / .48A (I,S) / .04A (P2,T); Yellow - 12V / .71A (I)  
 Bracket: 93552, 43253, 92510, 92511, 92512, 92513, 43572, 43642, 43655, 43732, 93190, 93683, 51090  
 Grommet: 91740, 91950  
 Pigtail: 66825, 67000, 66812, 66844, 66843, 66811, 67090

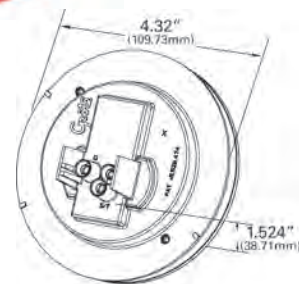
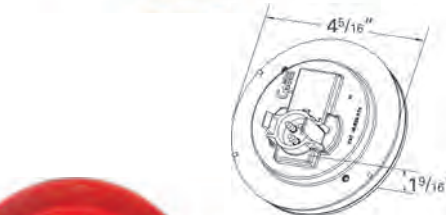
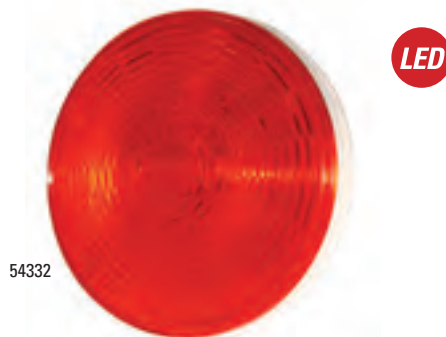

# Stop/Tail/Turn Lamps

Feux Arrêt / Arrière / Direction Lámparas de Freno / Cuarto / Direccional

LED

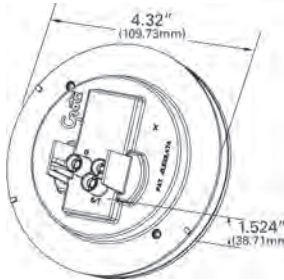

## GROTE SELECT™ 4" LED STOP/TAIL/TURN

Faster light-on response time provides greater stopping alert distance than incandescent lamps • Longer life and less current draw than standard incandescent lamps leaves more voltage available to other vehicle systems • Uses existing pigtailed wiring for cost-effective retrofit • Similar look to incandescent light which helps prevent theft • Hermetic lens-to-housing seal prevents moisture intrusion

- 54342** Red, Female Pin
- 54343** Yellow, Female Pin

Material: Lens - Acrylic; Housing - ABS  
 FMVSS: S / T / T- I, P2, S, T; Auxiliary- P2  
 Finish: Red / Yellow  
 Volts / Amps: 12V / .24A (I,S) / .03A (T)  
 Bracket: 93552, 43253, 92510, 92511, 92512, 92513, 43572, 43642, 43655, 43732, 93190, 93553, 93683, 51090  
 Grommet: 91740, 91950  
 Pigtail: 66825, 67000, 66812, 66844, 66843, 66811, 67090



53102

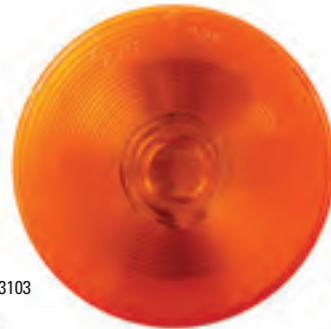

53103

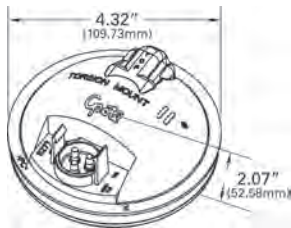
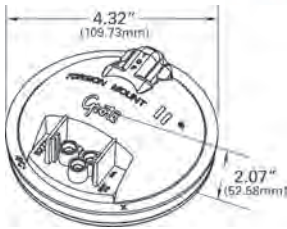

## TORSION MOUNT® II 4" STOP/TAIL/TURN LAMP

Torsion Mount® II Gel-Mount®, bulb cradle design • Heavy-duty bulb provides greater reliability • O-ring seal and male pin design reduce corrosion • Locking tabs ensure solid pigtail connection • 53100 lamp has clear back for interior illumination

### STOP/TAIL/TURN:

- 53102** Red, Male Pin
- 53102-5** Red, Male Pin RETAIL
- 53100** Red, Clear Housing, Male Pin
- 52770** Red, Clear Housing, Female Pin
- 52772** Red, Female Pin
- 52772-5** Red, Female Pin RETAIL
- 52152** Red, Female Pin 24 VOLT

### STOP/TAIL/TURN KIT:

- 53112** Red, Male Pin (53102 + 91740 + 67002)
- 52782** Red, Female Pin (52772 + 91740 + 67000)

### FRONT PARK/TURN:

- 53103** Yellow, Male Pin
- 52773** Yellow, Female Pin
- 52153** Yellow, Female Pin 24 VOLT

### SINGLE FUNCTION:

- 55572** Red, Female Pin
- 55573** Yellow, Female Pin

### BUILT-IN REFLECTOR:

- 52672** Red, Female Pin
- 52682** Red, Female Pin (52672 + 91740 + 67000)

Material: Polycarbonate  
 FMVSS: Red - I, P2, S, T; Yellow - I, P; 53100, 52770 - I, S, T  
 Finish: Red / Yellow  
 Bulb: 2057, 32/2 CP  
 Volts / Amps: Red - 12V / 2.1A (I,S)/.48A (P2,T)  
 Volts / Amps: Yellow - 12V / 2.1A (I)/.48A (P)  
 Bracket: 43572, 43253, 92510, 92512, 92513, 43642, 43655  
 Grommet: 91740, 91950  
 Pigtail: Male Pin: 66815, 67002, 66841, 66816, 67005, 66845; Female Pin: 66825, 67000, 66812, 66844, 66843, 66811, 67090

## 4" ECONOMY STOP/TAIL/TURN LAMP

Standard female connection • Fits all competitive pigtails, brackets and grommets • Hermetic lens-to-housing seal

### STOP/TAIL/TURN:

- 52922** Red, Female Pin
- 52922-5** Red, Female Pin RETAIL
- 53612** Red, Gray Theft-Resistant Flange, Female Pin

### STOP/TAIL/TURN KIT:

- 53012** Red, Female Pin (52922 + 91740 + 67090)
- 53012-5** Red, Female Pin (52922 + 91740 + 67090) RETAIL

### FRONT PARK/TURN:

- 52923** Yellow, Female Pin

Material: Polycarbonate  
 FMVSS: Red - I, P2, S, T; Yellow - I, P  
 Finish: Red / Yellow  
 Bulb: 2057, 32/2 CP  
 Volts / Amps: 12V / 2.1A (I,S)/.48A (T,P,P2)  
 Bracket: 43572,92510, 92512, 92513  
 Grommet: 91740, 91950  
 Pigtail: 66825, 67000, 66812, 66844, 66843, 66811, 67090

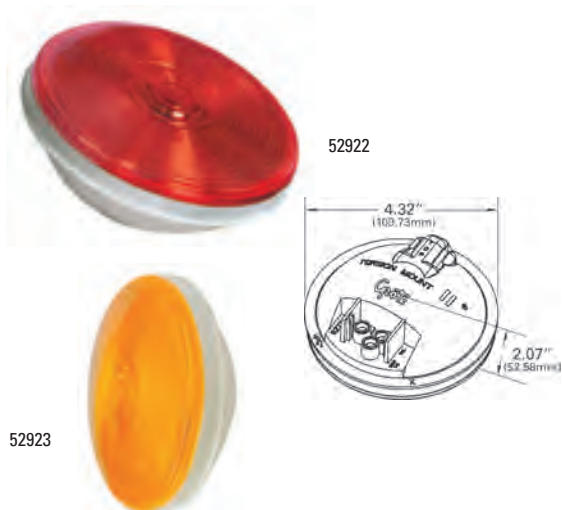

## SUPERNOVA® 10-DIODE LED STOP/TAIL/TURN POWER MODULE WITH SIDEMARKER

Heavy-gauge steel plate and can • Pre-assembled with wiring • Uses SuperNova® 10-Diode Pattern 4" LED lamps • Exceeds SAE J914, Nov. '87 • Includes reflector

- 51002** Red, Male Pin, RH
- 51012** Red, Male Pin, LH

Material: Lens - Acrylic; Housing - Steel; Grommet - PVC  
 FMVSS: A, I, P2, S, T  
 Finish: Gray/Red  
 Volts / Amps: 12V / .24A (I,S)/.06A (P2)/.03A (T)  
 Accessory: Lamp: S/T/T 53252; Marker 47092  
 Grommet: 91740

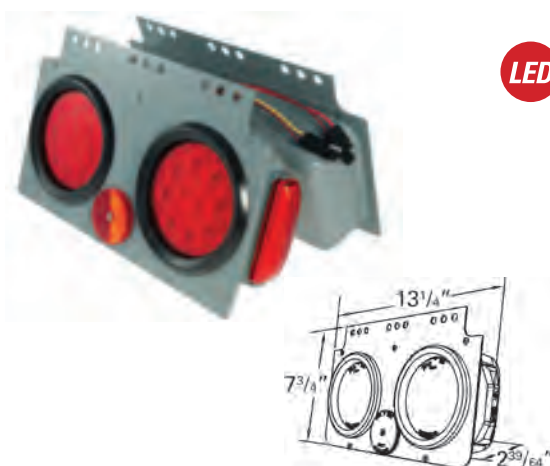

## STOP/TAIL/TURN 4" LAMP POWER MODULE

Heavy-gauge steel plate and can • Torsion Mount® II 4" round sealed lamps • Right or left hand application • Includes reflector

- 51052** Red

Material: Material: Lens - Polycarbonate; Housing - Steel; Grommet - PVC  
 FMVSS: A, I, P2, S, T  
 Finish: Gray/Red  
 Bulb: 2057, 32/2 CP  
 Volts / Amps: 12V / 2.1A (I)/2.1A (S)/.48A (P2)/.48A (T)  
 Accessory: Lamp: S/T/T - Red 52922  
 Bracket: 51090  
 Grommet: 91740

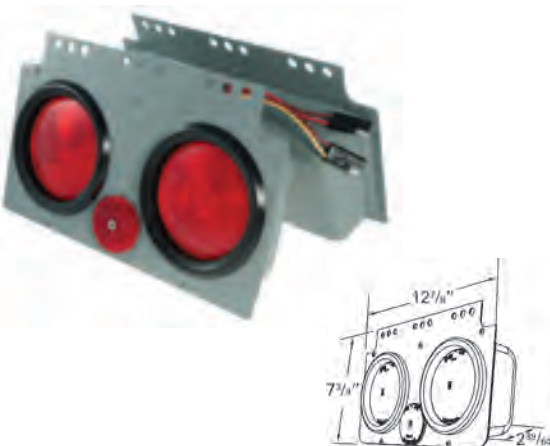

# Stop/Tail/Turn Lamps

Feux Arrêt / Arrière / Direction Lâmparas de Freno / Cuarto / Direccional

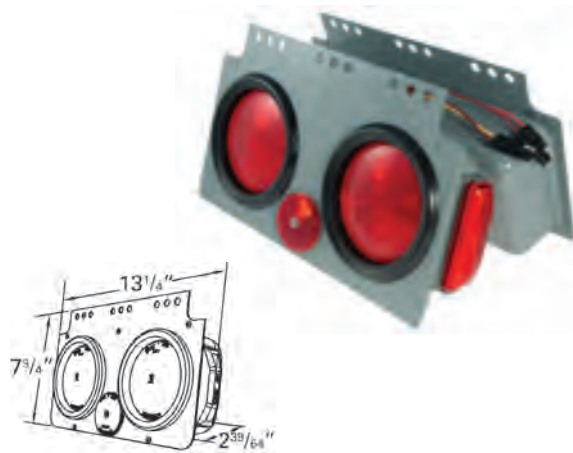

## STOP/TAIL/TURN 4" LAMP POWER MODULE WITH SIDEMARKER

Heavy-gauge steel plate and can • Includes reflector

**51022** Red, RH

**51032** Red, LH

Material: Lens - Polycarbonate; Housing - Steel; Grommet - PVC

FMVSS: A, I, P2, S, T

Finish: Gray

Bulb: 2057, 32/2 CP

Volts / Amps: 12V / 2.1A (I,S) / .48A (P2,T)

Bulb: 193 (2), 2 CP

Volts / Amps: 12V / .54A (P2)

Accessory: Lamps: S/T/T 52922; Marker 46742

Grommet: 91740

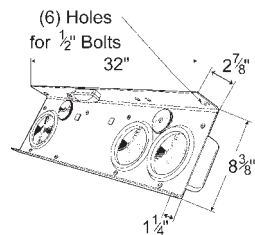

## POWER UNIT MODULE

Heavy-gauge steel plate and can • Torsion Mount® II 4" round female pin S/T/T lamps • Pre-assembled wiring harness and 5-way connector

• Includes reflector

**50820** Female Pin Lamps

Material: Lens - Polycarbonate ; Housing - Stainless Steel

FMVSS: A, I, L, R, S, T

Finish: Black

Bulb: 2057 (2), 32/2 CP

Volts / Amps: 12V - 4.2A (I,S) / .96A (P2,T)

Bulb: 2057, 32/2 CP

Volts / Amps: 12V / 2.1A (R)

Bulb: 193 (2), 2 CP

Volts / Amps: 12V / .66A (L)

Accessory: Lamp: S/T/T - Female Pin 52772; Backup - Female Pin 62271;

License - 62271; License Bracket 43780; Reflector - 40092; Grommet: 91740

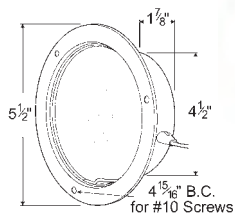

## FIELD RESEALABLE STAINLESS STEEL LAMP

Electro-polished stainless steel body • Torsion Mount® bulb cradle design • Polycarbonate lens

### DOUBLE CONTACT:

**52612** Red

Material: Stainless Steel/Polycarbonate

FMVSS: I, P2, P3, S, T

Finish: Red / Stainless

Bulb: 1157, 32/3 CP

Volts / Amps: 12V / 2.1A (I,S) / .59A (P2,P3,T)

Pigtail: 68130

Lens: 90762

## PLASTIC HOUSING LAMP

Snap-ring lens application • 2-wire pigtail

### DOUBLE CONTACT:

**50222** Red

Material: Lens - Acrylic; Housing - Polypropylene  
 FMVSS: I, P2, P3, S, T  
 Finish: Red / Black  
 Bulb: 1157, 32/3 CP  
 Volts / Amps: 12V / 2.1A (I,S)/.59A (P2,P3,T)  
 Accessory: Snap Ring 99593  
 Pigtail: 68130  
 Lens: Red 90012

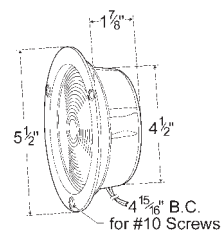

## RUBBER HOUSING LAMP

Lens held in by rubber flange • Standard exterior wiring • Brass eyelets in two mounting holes

### DOUBLE CONTACT:

**50502** Red

Material: Lens - Acrylic; Housing - Rubber  
 FMVSS: I, P2, P3, S, T  
 Finish: Red / Black  
 Bulb: 1157, 32/3 CP  
 Volts / Amps: 12V / 2.1A (I,S)/.59A (P2,P3,T)  
 Pigtail: 68150  
 Lens: Red 90012

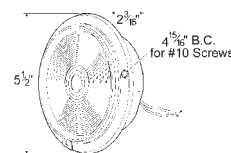

## ECONOMY STAINLESS STEEL LAMP

Easy snap-on lens • Rugged stainless steel construction

### DOUBLE CONTACT:

**52522** Red

Material: Lens - Polycarbonate; Housing - Stainless Steel  
 FMVSS: I, P2, P3, S, T  
 Finish: Red / Stainless  
 Bulb: 1157, 32/3 CP  
 Volts / Amps: 12V / 2.1A (I,S)/.59A (P2,P3,T)  
 Pigtail: 68150  
 Lens: Red 90762

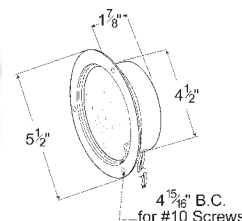

## ECONOMY STEEL LAMP

Easy snap-on lens • Rugged steel construction

### DOUBLE CONTACT:

**50232** Red

**50232-5** Red **RETAIL**

### SINGLE CONTACT:

**55092** Red

Material: Lens - Acrylic; Housing - Steel  
 FMVSS: Double - I, P2, P3, S, T; Single - I, S  
 Finish: Red / Black  
 Bulb: 1156, 32 CP  
 Volts / Amps: 12 V - 2.1(I,S)/.59A(T)  
 Bulb: 1157, 32/3 CP  
 Volts / Amps: 12V / 2.1A (I,S)/.59A (P2,P3,T)  
 Accessory: Snap Ring 99595  
 Pigtail: 68130, 68150  
 Lens: Red 90012

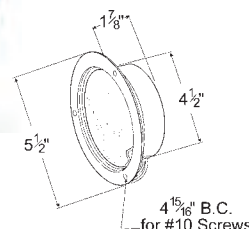

# Stop/Tail/Turn Lamps

Feux Arrêt / Arrière / Direction L mparas de Freno / Cuarto / Direccional

LED

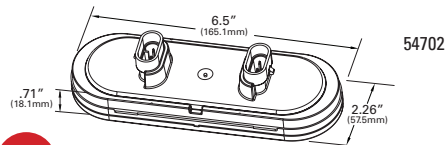
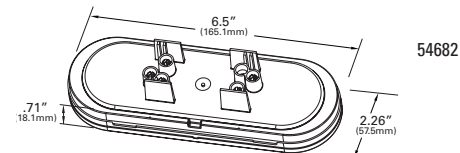
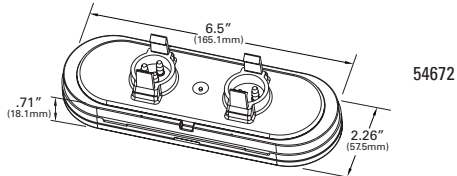

## OVAL LED STOP/TAI/TURN WITH INTEGRATED BACK-UP LAMP

Innovative patent-pending design combines all Stop/Tail/Turn and Back-up functions into one industry standard size lamp • Symmetrical design meets legal requirements at any mounting angle • LED technology provides less maintenance costs and long life • Industry-standard design fits existing mounting grommets, brackets, and flanges • Reduces inventory, SKUs, and carrying costs

- 54672** Red, Male Pin
- 54682** Red, Female Pin
- 54702** Red, Hard Shell

Material: Red High Impact Acrylic, Clear Polycarbonate  
FMVSS: I, S, T, R2  
Voltage Amp: 12V

LED

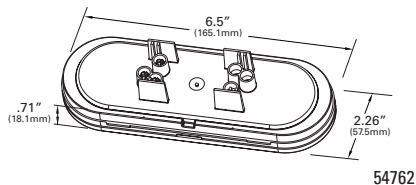
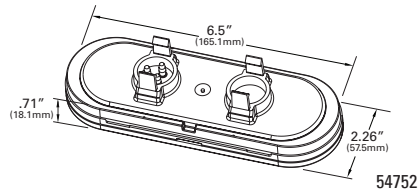
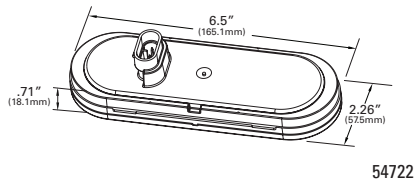
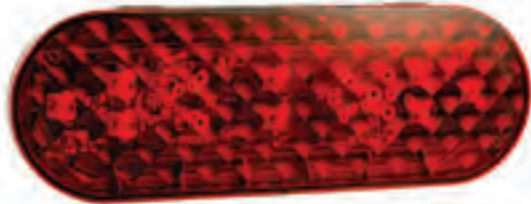

## OVAL LED STOP/TAI/TURN WITHOUT INTEGRATED BACK-UP LAMP

Thin profile design minimizes chance of external impact damage • LED technology provides less maintenance costs and long life • Industry-standard design fits existing mounting grommets, brackets, and flanges • Symmetrical design meets legal requirements at any mounting angle

- 54722** Red, Hard Shell
- 54752** Red, Male Pin
- 54762** Red, Female Pin

Material: Red High Impact Acrylic  
FMVSS: I, S, T  
Voltage Amp: 12V



## SUPERNOVA® OVAL LED STOP/TAIL/TURN LAMP

Advanced pin connection system uses tin-plated, solid brass terminals

- Potted for total circuit board protection
- Male pin connection for maximum moisture and corrosion protection
- Meets specifications for vertical and horizontal mounting

STOP/TAIL/TURN:	
53962	Red, Grommet Mount
53592	Red, Gray Theft-Resistant Flange
53622	Red, Black Theft-Resistant Flange
53972	Red, Stainless Steel Theft-Resistant Flange
52072	Red, Grommet Mount <b>24</b> Volts
STOP/TAIL/TURN KIT:	
53122	Red (53962 + 92420 + 67005)
AUXILIARY:	
53963	Yellow, Grommet Mount
53593	Yellow, Gray Theft-Resistant Flange
53623	Yellow, Black Theft-Resistant Flange
53973	Yellow, Stainless Steel Theft-Resistant Flange
52073	Yellow, Grommet Mount <b>24</b> Volts
AUXILIARY KITS:	
53123	Yellow (53963 + 92420 + 67005)

Material: Lens - Acrylic; Housing - ABS  
 FMVSS: Red - I, P2, S, T; Yellow - P2  
 Finish: Red / Yellow  
 Volts / Amps: Red - 12V / .48A (I,S) / .06A (T)  
 Volts / Amps: Yellow - 12V / .48A  
 Volts / Amps: Red - 24V / .48A (I,S) / .06A (T)  
 Volts / Amps: Yellow - 24V / .48A  
 Bracket: 43362, 43952, 43220, 43223, 43222, 43100, 43723, 42152, 42153, 42103, 43172; Grommet: 92420, 92720  
 Pigtail: Male Pin: 66815, 67002, 66841, 66816, 67005, 66845, 67006, 66813, 66823, 66830, 66836  
 Male Pin 2-Wire: 66842, 67013, 66846, 67016

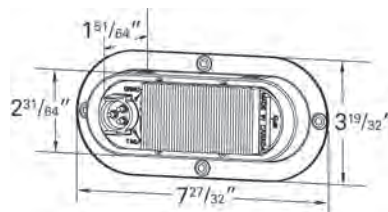
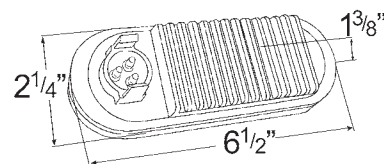

## SUPERNOVA® 9-DIODE OVAL LED STOP /TAIL/TURN LAMP

Available in male pin, hard shell and, hardwired connection options for easy retrofit or replacement

- Electronics completely encapsulated with durable epoxy for maximum protection from the environment
- Fits current mounting flanges and grommets

54132	Red, Male Pin
54133	Yellow, Male Pin
54142	Red, Hard Shell
54143	Yellow, Hard Shell

Material: Lens - Acrylic; Housing - ABS  
 FMVSS: I6, P, S, T, P2  
 Finish: Red/Yellow  
 Volts / Amps: 13.5V / .02A (T) / .14A (I,S)  
 Accessory: Chrome Bezel 42153  
 Bracket: 43362, 43952, 43220, 43223, 43222, 43100, 43723, 42152, 42153, 42103, 43132  
 Grommet: 92420, 92720  
 Pigtail: Male Pin: 66815, 67002, 66841, 66816, 67005, 66845  
 Hard Shell: 66861, 66862

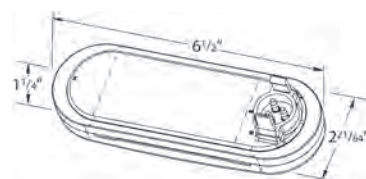
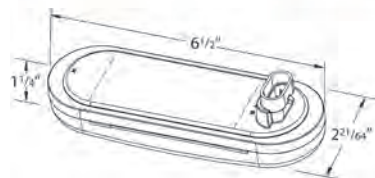

# Stop/Tail/Turn Lamps

Feux Arrêt / Arrière / Direction Lámparas de Freno / Cuarto / Direccional

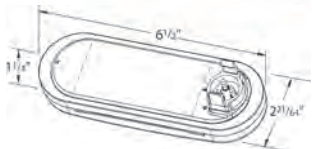

## SUPERNOVA® NEXGEN™ OVAL LED STOP/TAIL/TURN LAMP

Available in male pin and hardwire for retrofit or replacement

- Electronics encapsulated with durable epoxy for maximum protection from the environment
- Fits current mounting flanges and grommets

### STOP/TAIL/TURN:

**54162** Red, Male Pin

### AUXILIARY:

**54163** Yellow, Male Pin

Material: Lens - Acrylic; Housing - ABS

FMVSS: I6, P, S, T, P2

Finish: Red/Yellow

Volts / Amps: 13.5V / .02A (T)/.14A (I,S)

Bracket: 43362, 43952, 43220, 43223, 43222, 43100, 43723, 42152, 42153, 42103, 42173

Grommet: 92420, 92720

Pigtail: 66815, 67002, 66841, 66816, 67005, 66845

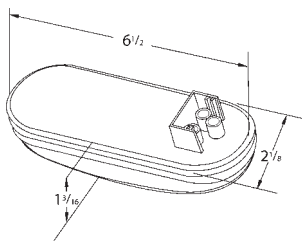

## HI COUNT® 56-DIODE OVAL LED STOP/TAIL/TURN LAMP

Female pin connection accepts all popular plug-in connectors • Fits same connections as female incandescent lamps • Lower amp draw of LEDs allows use of more lamps without draining vehicle power • LEDs provide faster stop warning for trailing vehicles

**G6002** Red

**G6002-5** Red

RETAIL

**G6003** Yellow

**G6003-5** Yellow

RETAIL

**G6012** Red, Clear Lens

**G6013** Yellow, Clear Lens

Material: Polycarbonate

FMVSS: I, S, T, P, P2

Finish: Red / Yellow

Volts / Amps: 12V / .43A (I,S)/.05A (T)

Bracket: 43362, 43952, 43220, 43223, 43222, 43100, 43723, 42152, 42153, 42103, 43173

Grommet: 92420, 92720

Pigtail: 67090

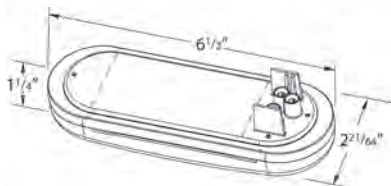

## GROTE SELECT™ OVAL LED STOP/TAIL/TURN LAMP

Encapsulant potting protects against moisture, vibration, and corrosion

- Fits current mounting flanges and grommets
- Female pin connection accepts all popular connectors

### STOP/TAIL/TURN:

**54172** Red

### AUXILIARY:

**54173** Yellow

Material: Lens - Acrylic; Housing - ABS

FMVSS: I6, P, S, T, P2

Finish: Red/Yellow

Volts / Amps: Red 12V / .48A (I,S)/.04A (P2, T)

Volts / Amps: Yellow 12V / .71A (I)

Bracket: 43362, 43952, 43220, 43223, 43222, 43100, 43723, 42152, 42153, 42103, 43173

Grommet: 92420, 92720

Pigtail: 66825, 67000, 66812, 66844, 66843, 66811, 67090

## OVAL LED STOP/TAIL/TURN LIGHT

10 LED configuration • 100,000 hours of service life • Sonically sealed polycarbonate light • Mounted vertical, horizontal, or 45° degrees • Impact resistant

**52592-5** Chrome Trim Ring - Red

Material: Polycarbonate  
FMVSS: I, S, T  
Color: Red  
Voltage Amp: 12V / .22A (I,S) / .04A (T)



LED

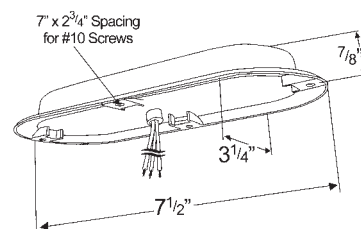

## TORSION MOUNT® III OVAL STOP/TAIL/TURN LAMP

Torsion Mount® III, Gel-Mount® bulb cradle design minimizes bulb vibration  
• Locking tabs ensure solid pigtail connection

### STOP/TAIL/TURN:

- 52562** Red, Male Pin
- 52892** Red, Female Pin
- 52892-5** Red, Female Pin **RETAIL**

### STOP/TAIL/TURN KIT:

- 52582** Red, Male Pin (52562 + 92420 + 67002)
- 52572** Red, Female Pin (52892 + 92420 + 67000)

### FRONT PARK/TURN:

- 52563** Yellow, Male Pin
- 52893** Yellow, Female Pin
- 52893-5** Yellow, Female Pin **RETAIL**

### FRONT PARK/TURN KIT:

- 52573** Yellow, Female Pin (52893 + 92420 + 67000)

### TURN LAMPS:

- 55772** Red, Female Pin
- 55773** Yellow, Female Pin

Material: Lens and Housing - Polycarbonate; Grommet - PVC (Kits)  
FMVSS: Red - I, P2, S, T; Yellow - I, P  
Finish: Red / Yellow  
Bulb: 1157, 32/3 CP  
Volts / Amps: 12V / 2.1A (I,S) / .59A (P,P2,T)  
Bracket: 43362, 43952, 43220, 43223, 43222, 43100, 43723, 42152, 42153, 42103  
Grommet: 92420, 92720  
Pigtail: Male Pin: 66815, 67002, 66841, 66816, 67005, 66845;  
Female Pin: 66825, 67000, 66812, 66844, 66843, 66811, 67090

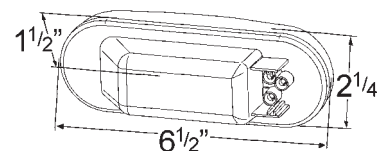
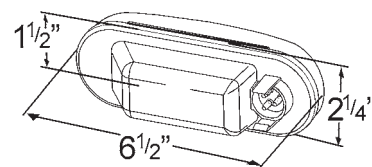

# Stop/Tail/Turn Lamps

Feux Arrêt / Arrière / Direction Lámparas de Freno / Cuarto / Direccional

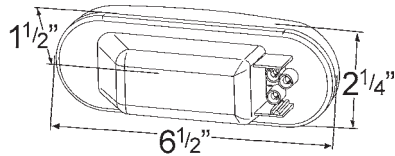

## ECONOMY OVAL STOP/TAIL/TURN

Female pin connection • Available in both red and amber

### STOP/TAIL/TURN:

**52182** Red  
**52182-5** Red **RETAIL**

### STOP/TAIL/TURN KIT:

**53092** Red (52182 + 92420 + 67090)

### FRONT PARK/TURN:

**52183** Yellow  
**52183-5** Yellow **RETAIL**

### FRONT PARK/TURN KIT:

**53093** Yellow (52183 + 92420 + 67090)

Material: Polycarbonate  
 FMVSS: Red - I, P2, S, T; Yellow - I, P  
 Finish: Red/Yellow  
 Bulb: 1157, 32/3 CP  
 Volts / Amps: 12V / 2.1A (I,S) / .59A (P,P2,T)  
 Bracket: 43362, 43952, 43220, 43223, 43222, 43100, 43723, 42152, 42153, 42103  
 Grommet: 92420, 92720  
 Pigtail: 66825, 67000, 66812, 66844, 66843, 66811, 67090

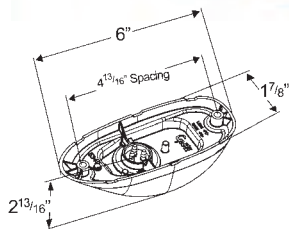

## SUPERNOVA® SURFACE MOUNT LED SIDE TURN/MARKER LAMP

50 state legal, meets SAE J914 E/E2 and California Title 13 requirements •  
 Lamp is visible from driver's rearview mirror while flashing • Metal-core circuit board dissipates heat from electronic components to extend LED life  
 • Durable screw bosses withstand excessive screw torque without cracking  
 • Industry-standard 122.2-mm mounting for easy retrofits

**53493** Yellow

Material: Polycarbonate  
 FMVSS: Optic - E, E2, P2  
 Finish: Yellow  
 Volts / Amps: 12V / .35A (E/E2) / .82A (P2)  
 Pigtail: 66905, 66904, 66900

## SUPERNOVA® OVAL LED SIDETURN/MARKER LAMP

Flashing turn signal is visible to driver during operation • Available in recessed grommet/flange, surface, and integrated flange mount versions  
 • Male pin and hard shell connection options • 50 state legal, meets SAE J914 E/E2 and California Title 13 • Single circuit board and single reflector component design

### GROMMET MOUNT:

<b>54183</b>	Yellow, Male Pin	<b>NEW</b>
<b>54193</b>	Yellow, Hard Shell	<b>NEW</b>
<b>54253</b>	Yellow, Male Pin, w/ Black Theft-Resistant Flange	<b>NEW</b>
<b>54263</b>	Yellow, Male Pin, w/ Stainless Steel Theft-Resistant Flange	<b>NEW</b>
<b>54243</b>	Yellow, Male Pin, w/ Gray Theft-Resistant Flange	<b>NEW</b>

### INTERGRATED FLANGE MOUNT:

<b>54203</b>	Yellow, Male Pin	<b>NEW</b>
<b>54213</b>	Yellow, Hard Shell	<b>NEW</b>

### SURFACE MOUNT:

<b>54223</b>	Yellow, Male Pin	<b>NEW</b>
<b>54233</b>	Yellow, Hard Shell	<b>NEW</b>

Material: Polycarbonate  
 FMVSS: Optic - E, E2, P2  
 Finish: Yellow  
 Volts / Amps: 13.5V / .45A/.06A  
 Bracket: 43362, 43952, 43220, 43223, 43222, 43100, 43723, 42152, 42153, 42103, 43172  
 Grommet: 92420, 92720  
 Pigtail: Male Pin: 66815, 67002, 66841, 66816, 67005, 66845  
 Hard Shell: 66861, 66862

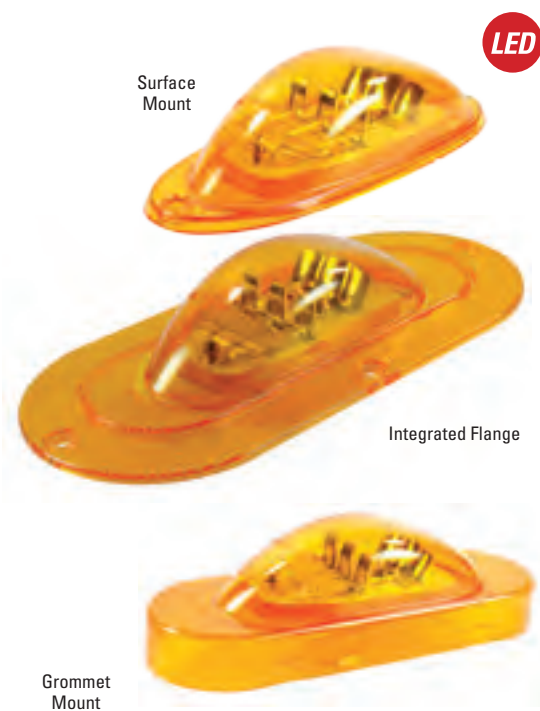
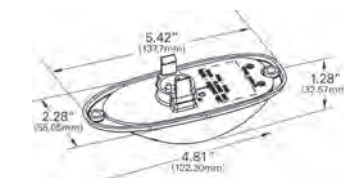
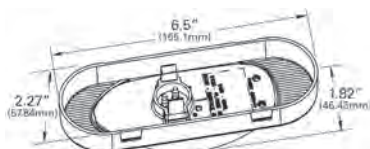

## LED HYBRID SIDETURN/MARKER LAMP

Hybrid LED/Incandescent technology provides a low cost-to-life ratio with an incandescent flashing function and an LED marker • 1,200-hour, field-replaceable midturn bulb • Vent filters in housing expel water vapor when lamp is lit to prevent water pooling inside lamp • Foam gasket provides protection against moisture intrusion • Sealed Packard® style connector minimizes potential failure points associated with conventional pigtail connections • Used on Navistar® vehicles

**54243** Yellow

Material: Polycarbonate  
 FMVSS: E, E2, P2  
 Finish: Yellow  
 LED: Volts / Amps: 12V / .06A (P2)  
 Bulb: 3156, 32 CP; Volts / Amps: 12V / 2.1A (E, E2)  
 Pigtail: 66826

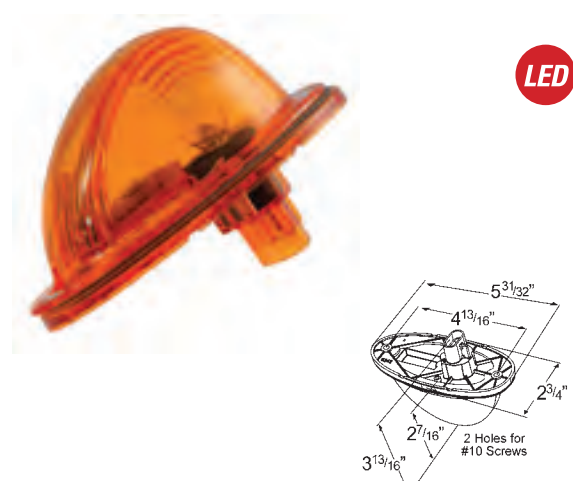

# Stop/Tail/Turn Lamps

Feux Arrêt / Arrière / Direction Lámparas de Freno / Cuarto / Direccional

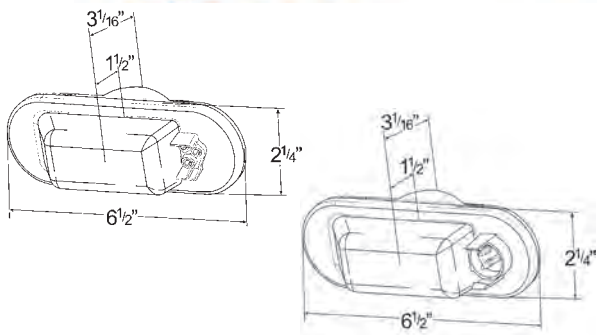

## TORSION MOUNT™ III OVAL SIDETURN/MARKER LAMP

Torsion Mount® III, Gel-Mount® bulb cradle design minimizes bulb vibration

- Extended dome for added visibility from front and rear
- Fits standard oval lamp grommets and brackets
- Contains reflex reflector
- Exceeds SAE J914, Nov. '87

### SIDE TURN/MARKER:

**52533** Yellow, Male Pin

**52513** Yellow, Female Pin

### SIDE TURN/MARKER KIT:

**52553** Yellow, Male Pin (52533 + 92420 + 67002)

**52543** Yellow, Female Pin (52513 + 92420 + 67000)

### SIDE MARKER:

**52512** Red, Female Pin

Material: Polycarbonate

FMVSS: A, E, P2, P3

Finish: Red, Yellow

Bulb: 1157, 32/3 CP; Volts / Amps: 12V / 2.1A (E)/.59A (P2,P3)

Bracket: 43362, 43952, 43220, 43223, 43222, 43100, 43723, 42152, 42153, 42103

Grommet: 92420, 92720

Pigtail: Male Pin: 66815, 67002, 66841, 66816, 67005, 66845

Female Pin: 66825, 67000, 66812, 66844, 66843, 66811, 67090

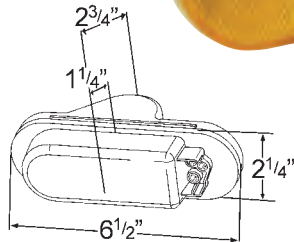

## ECONOMY OVAL SIDETURN/MARKER LAMP

Hermetic lens-to-housing seal • Vibration resistant bulb mounting system • Standard female pin connection

**52193** Yellow

### KITS:

**52253** Yellow (52193 + 92420 + 67090)

Material: Polycarbonate

FMVSS: A, E, P2

Finish: Yellow

Bulb: 2057, 32/2 CP

Volts / Amps: 12V / 2.1A (E)/.48A (P2)

Bracket: 43362, 43952, 43220, 43223, 43222, 43100, 43723, 42152, 42153, 42103

Grommet: 92420, 92720

Pigtail: 66825, 67000, 66812, 66844, 66843, 66811, 67090

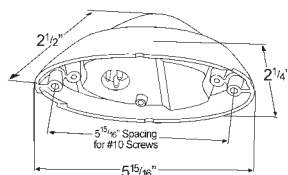

## SMALL AERODYNAMIC COMBINATION MARKER/SIDETURN LAMP

One-way check valve expels water • High-impact base, polycarbonate lens

- Uses reliable 3157, wedge base bulb
- Retrofits to Sentry lamp 53063 and 53163
- Great upgrade/replacement on Freightliner® midturn lamps
- Exceeds SAE J2039 June '94

### SIDE TURN/MARKER:

**52023** Yellow, Black Base

**52063** Yellow, White Base

### SIDE MARKER:

**52062** Red, White Base **PC**

Material: Polycarbonate

FMVSS: Red - P2, PC; Yellow - E, P2

Finish: Red / Yellow

Bulb: 3157, 32/2 CP

Volts / Amps: 12V / 2.1A (E)/.59A (P2,P3,PC)

Pigtail: 66905, 66904, 66900, 66901, 66920, 66903

Lens: Red 92892, Yellow 92893

## OEM SIDETURN MARKER LAMP

- Surface mount lamp • Combination turn signal and side marker (53853 only)
- 4.54" mounting holes • Lens hermetically sealed to the base
  - Includes Packard connector and mounting pad

<b>SIDETURN:</b>	
<b>53833</b>	Yellow, Sealed
<b>SIDETURN/MARKER:</b>	
<b>53853</b>	Yellow, Bulb Replaceable

Material: Polycarbonate  
 FMVSS: 53853 - E, P2 / 53833 - E  
 Finish: Yellow  
 Bulb: 53833- 3156, 26 Watts  
 Volts / Amps: 12.8V / 2.1A  
 Bulb: 53853 - P27/7W  
 Volts / Amps: 12.8V - 14.0V / 2.1A - .59A



## SENTRY SEALED COMBINATION MARKER/SIDETURN LAMP

- High-impact base • Uses male pin connection; accepts UBS pigtail
- Not recommended for rear of vehicles in padded dock applications
  - Yellow exceeds SAE J914 Nov. '87

<b>SIDE MARKER:</b>	
<b>53062</b>	Red, White Base
<b>SIDETURN/MARKER:</b>	
<b>53063</b>	Yellow, White Base
<b>SIDETURN:</b>	
<b>53163</b>	Yellow, Black Base

Material: Polycarbonate  
 FMVSS: 53062 - P2/ 53063 - E2, P2; 53163 - E2  
 Finish: Red / Yellow  
 Bulb: 1141, 21 CP - Single Function, 53163  
 Volts / Amps: 12V / 1.34A (E2)  
 Bulb: 1016, 21/6 CP - Multi-Function, 53062, 53063  
 Volts / Amps: 12V / 1.34A (E2)/.59A (P2)  
 Pigtail: 53062, 53063: 66905, 66900, 66903, 66904  
 53163: 66902, 66920

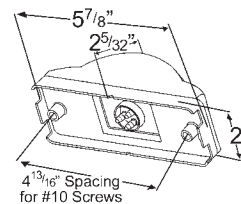

## SENTRY SUPPLEMENTAL HIGH MOUNT STOP LAMP

- Application for vehicles over 80" only • High-impact base • Single filament bulb
- Not recommended for rear of vehicle in padded dock applications
  - Must be used in conjunction with a legal CHMSL

**54012** Red

Material: Polycarbonate  
 FMVSS: U  
 Finish: Red  
 Bulb: 1141, 21 CP  
 Volts / Amps: 12V / 1.34A  
 Pigtail: 66902

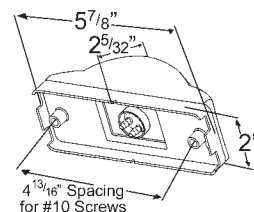

# Stop/Tail/Turn Lamps

Feux Arrêt / Arrière / Direction Lâmparas de Freno / Cuarto / Direccional

LED

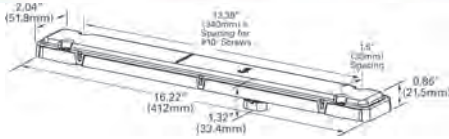

01-5444-71

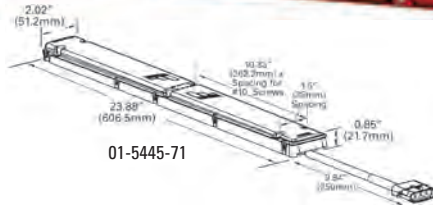

01-5445-71

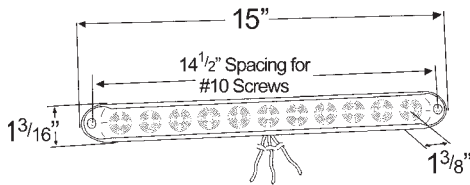

## FONTAINE® REVOLUTION LED LAMP SYSTEM

Unique and innovative lighting system developed for Fontaine® Trailers

- Stop, tail, turn system utilizes one lamp that can be rotated for left-hand or right-hand installations

01-5445-73

S/T/T Lamp LH/RH

01-5444-73

High Mount Stop/Turn Clearance or ID Lamp

Material: Lens - Acrylic; Housing - ABS

FMVSS: I, P2, S, T (STT), P2, U (CHMSL)

Finish: Red

Volts / Amps: 01-5444-71 - 12V / .03A / .21A

Volts / Amps: 01-5445-71 - 12V / .127A / .21A / .21A

## STOP/TAI/TURN LED BAR LAMP

11-LED configuration • Can be mounted in vertical, horizontal or 45° angle

- Impact-resistant housing is sealed for moisture protection • 15" length

53582 Red

Material: Polycarbonate

FMVSS: I, S, T

Color: Red

Voltage Amp: 12V / .35 (S, I) / .04 (P2, T)

LED

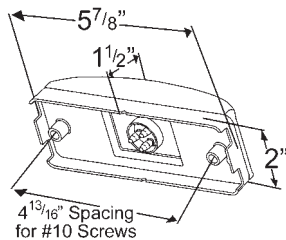

## SUPERNOVA® TURTLEBACK® II LED HIGH-MOUNT STOP/TURN AND MARKER LAMP

Lamp functions as a marker, clearance, ID, and supplemental high-mount stop or turn lamp • Supplemental high-mount function provides greater visibility in a location that normally serves as an ID function or clearance function

- Sealed Turtleback® II lens profile makes lamp more durable and impact resistant
- Potted for total circuit board protection against vibration and corrosion.
- Three-wire connection

54002 Red

54003 Yellow

Material: Polycarbonate

FMVSS: P2, U

Finish: Red

Volts / Amps: 12V / .25A (U) / .025A (P2)

Bracket: 43030, 43050

Pigtail: 66900, 66904, 66905



## HI COUNT® RECTANGULAR LED STOP/TAIL/TURN LAMP

15 Diodes • Vertical or horizontal mount • Hermetically sealed polycarbonate lens and body • Standard female pin connection provides easy retrofits • LED instant-on feature provides early stop warning for trailing motorists • Yellow lens meets photometric requirements for front park and turn • Potted circuit board protects against vibration and corrosion

**G4502** Red  
**G4503** Yellow

Material: Polycarbonate  
FMVSS: I, P2, S, T  
Finish: Red / Yellow  
Volts / Amps: Red - 12V / .50A (I,S)/.07 (P2,T)  
Volts / Amps: Yellow - 12V / .52A (I)/.09A (P)  
Bracket: 43212  
Grommet: 94180  
Pigtail: 66825, 67000, 66812, 66844, 66843, 66811, 67090

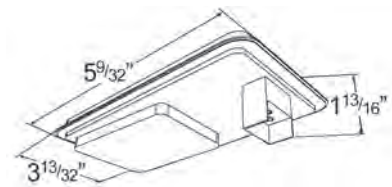

## RECTANGULAR STOP/TAILO/TURN LAMP

Rubber shock mounted bulb socket • Hermetic lens-to-housing sealed lamp • Industry standard female pin connection

**STOP/TAILO/TURN LAMP (DOUBLE CONTACT):**  
**52202** Red

**PARK/TURN LAMP (DOUBLE CONTACT):**  
**52203** Yellow

Material: Polycarbonate  
FMVSS: 52202 - I, P2, S, T; 52203 - I, P  
Finish: Red / Yellow  
Bulb: 2057, 32/2 CP  
Volts / Amps: 52202 - 12V / 2.1A (S,I)/.48A (P2,T)  
Volts / Amps: 52203 - 12V / 2.1A (I)/.48A (P)  
Bracket: 43212  
Grommet: 94180  
Pigtail: 66825, 67000, 66812, 66844, 66843, 66811, 67090

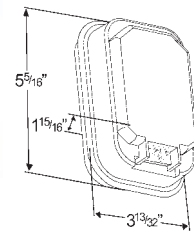

## RECTANGULAR SURFACE MOUNT TURN LAMP

Double-filament bulb provides park and turn function • 3 1/2" mounting centers • Less than 75 sq. cm lens area • For use on vehicles less than 80" wide

**53132** Red  
**53133** Yellow

Material: Steel/Polycarbonate  
FMVSS: Red - I, S, T; Yellow - I, P  
Finish: Red / Yellow  
Bulb: 2057, 32/2 CP  
Volts / Amps: 12V / 2.1A (I,S)/.48A (P,T)

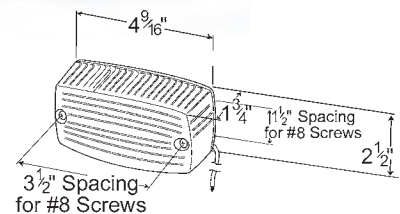

# Stop/Tail/Turn Lamps

Feux Arrêt / Arrière / Direction Lámparas de Freno / Cuarto / Direccional

LED

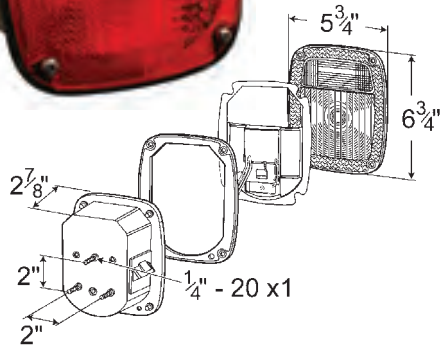

## SUPERNOVA® THREE-STUD METRI-PACK® LED STOP/TAI/TURN LAMP

SuperNova® single-LED technology in both the S/T/T and license function

- Encapsulant potting for total circuit board protection
- Replaces GM® 15613944 and 15565732 (53630), 15613943 and 15565731 (53640)
- LED replacement for Navistar® 1661282C91 (53630)
- Includes reflex reflector

**53630** Red, RH

**53640** Red, LH w/ License Window

Material: Polycarbonate

FMVSS: A, I, L, (2)R, S, T

Finish: Red

Bulb: 1156, 32CP (L)

Volts / Amps: 12V / 2.1A (R2)/.35A (I,S)/.16A (L,T)

Bracket: 43842

Pigtail: 68680

Lens: 91302

LED

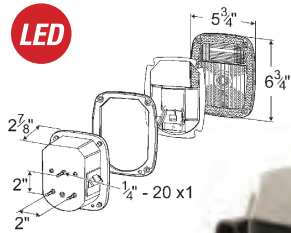

## SUPERNOVA® THREE-STUD METRI-PACK® LED STOP/TAI/TURN LAMP WITH DOUBLE CONNECTOR

Features Grote's latest SuperNova® single-LED technology in both the S/T/T and license function

- Encapsulant potting for total circuit board protection
- LED replacement for Navistar® 1661281C91
- Backup function remains incandescent
- Includes reflex reflector

WITH LICENSE LAMP:

**53650** Red

Material: Polycarbonate

FMVSS: A, I, L, (2)R, S, T

Finish: Red

Bulb: 1156, 32CP (L)

Volts / Amps: 12V / 2.1A (R2)/.35A (I,S)/.16A (L,T)

Bracket: 43842

Pigtail: 68680

Lens: 91302

LED

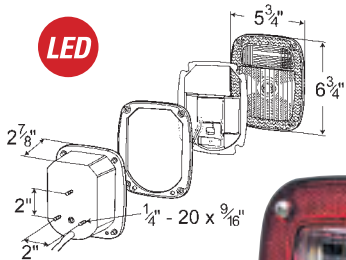

## SUPERNOVA® THREE-STUD LED STOP/TAI/TURN LAMP

SuperNova® single-LED technology in both the S/T/T and license functions

- Encapsulant potting for total circuit board protection
- Replaces Chevrolet®/GMC® 370867 and 370868
- Replaces Jeep® SF5457197 and SF5457198
- Replaces Peterbilt® 16-02600R and 16-02600L
- Backup function remains incandescent
- Includes reflex reflector

**50920** Red w/ License Window

Material: Polycarbonate

FMVSS: A, I, L, (2)R, S, T

Finish: Red

Bulb: 1156, 32CP (L)

Volts / Amps: 12V / 2.1A (R2)/.35A (I,S)/.16A (L,T)

Bracket: 43842

Lens: 91302

## HI COUNT® LED STOP/TAIL/TURN LAMP

All functions utilize LED technology • Gasket between lens and housing protects against moisture intrusion • Potted circuit board protects against vibration and corrosion • Sidemarker version directly replaces Jeep® Wrangler® lamps through 2006 • Sidemarker version features circuit board protection that is compatible with the existing flasher technology • 3 stud mounting design incorporates ground function • Sidemarker version has 16 stop/tail/turn diodes, 22 backup diodes, 4 license diodes and 2 sidemarker diodes • Standard version has 16 stop/tail/turn diodes, 22 backup diodes and 4 license diodes • Mounting hardware and instructions included for easy installation / retrofit • Includes reflex reflector

### WITH SIDEMARKER:

- G5202** Red, RH w/ Sidemarker
- G5212** Red, LH w/ License Window & Sidemarker

### WITHOUT SIDEMARKER:

- G5082** Red, RH
- G5082-5** Red, RH RETAIL
- G5092** Red, LH w/ License Window
- G5092-5** Red, LH w/ License Window RETAIL

Material: Lens - Acrylic; Housing - Polycarbonate  
 FMVSS: RH - A, I, (2)R, S, T; LH - A, I, L, R2, S, T  
 Finish: Red  
 G5092 - Volts / Amps: 12V / .21A (I,S)/.34A (R2)/.12A (L)  
 G5082 - Volts / Amps: 12V / .21A (I,S)/.34A (R2)/.06A (T)  
 G5212 - Volts / Amps: 12V / 1.4A (I,S)/.34A (R2)/.12A (T,L)  
 G5202 - Volts / Amps: 12V / 1.4A (I,S)/.34A (R2)/.06A (T)  
 Bracket: 43842



## THREE-STUD METRI-PACK® STOP/TAIL/TURN LAMP

Replaces GM® 15613943 and 15565731 • Features a license window  
 • Metri-Pack® connector on right side • Includes reflex reflector

- 53702** Red, RH w/ License Window
- 53712** Red, LH w/ License Window

Material: Lens - Acrylic and Polycarbonate; Housing - Polycarbonate  
 FMVSS: A, I, L, R2, S, T  
 Finish: Red  
 Bulb: 1156, 32 CP; Volts / Amps: 12V / 2.1A (R2)  
 Bulb: 2057, 32/3 CP; Volts / Amps: 12V / 2.1A (I,S)/.59A (T,L)  
 Bracket: 43842  
 Pigtail: 68680  
 Lens: Red 91302

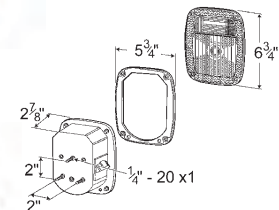

## FORD® STOP/TAIL/TURN BOX LAMP

Junction box with Ford® OEM connector • Features a license window  
 • Ford® Drivers Side: F4HZ 13404 A • Ford® Passengers Side: F4HZ 13405 A • Includes reflex reflector

- 53782** Red, RH w/ License Window
- 53792** Red, LH w/ License Window

Material: Polycarbonate/Acrylic  
 FMVSS: A, I, L, P2, (2)R, S, T  
 Finish: Red  
 Bulb: 3057, 32/3 CP; Volts / Amps: 12V / 2.1A (I,S, R2) / .59A (T,L,P2)  
 Bracket: 43842  
 Pigtail: 01-6868-82  
 Lens: Red 91302

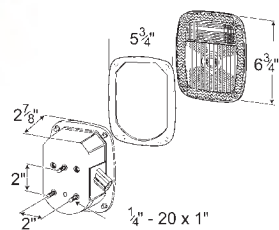

# Stop/Tail/Turn Lamps

Feux Arrêt / Arrière / Direction Lámparas de Freno / Cuarto / Direccional

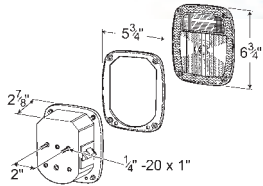

## TWO-STUD METRI-PACK® STOP/TAIL/TURN LAMP WITH SINGLE CONNECTOR

Features a license window • Metri-Pack® connector on left side  
• Replaces Mack® 14M052M • Includes reflex reflector

**53722** Red

Material: Lens - Acrylic and Polycarbonate; Housing - Polycarbonate  
FMVSS: A, I, L, (2)R, S, T

Finish: Red

Bulb: 1156, 32 CP; Volts / Amps: 12V / 2.1A (R2)

Bulb: 1157, 32/3 CP; Volts / Amps: 12V / 2.1 (I,S)/.59A (T,L)

Bracket: 43262-5, 43022, 43022-5, 43272, 43272-5, 43842

Pigtail: 68680

Lens: Red 91302

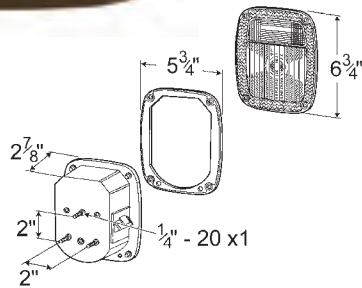

## THREE-STUD METRI-PACK® STOP/TAIL/TURN LAMP WITH DOUBLE CONNECTOR

Features a license window • Metri-Pack® connectors on both sides  
• Replaces Navistar® 1661281C91 • Includes reflex reflector

**53762** Red

Material: Lens - Acrylic and Polycarbonate; Housing - Polycarbonate  
FMVSS: A, I, L, (2)R, S, T

Finish: Red

Bulb: 1156, 32 CP

Volts / Amps: 12V / 2.1A (R2)

Bulb: 1157, 32/3 CP

Volts / Amps: 12V / 2.1A (I,S)/.59A (T,L)

Bracket: 43842

Pigtail: 68680

Lens: Red 91302

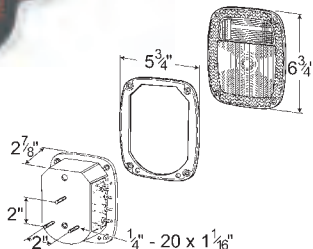

## TORSION MOUNT® UNIVERSAL STOP/TAIL/TURN LAMP

6-in-1 lamp • Four screw posts in junction box • Fits all 3-stud mounting on heavy duty trucks • Includes reflex reflector

**52902** Red, RH w/ License Window

**52912** Red, LH w/ License Window

Material: Lens - Acrylic and Polycarbonate; Housing - Polycarbonate  
FMVSS: A, I, L, (2)R, S, T

Finish: Red

Bulb: 1156, 32 CP

Volts / Amps: 12V / 2.1A (R2)

Bulb: 1157, 32/3 CP

Volts / Amps: 12V / 2.1A (I,S)/.59A (T,L)

Bracket: 43842

Lens: Red 91302

## TORSION MOUNT® THREE-STUD GMC® STOP/TAI/TURN LAMP

Junction box with quick splice or ring connectors • Replaces GMC® 715103 or 2063933 (RH) • Replaces GMC® 715104 or 2063931 (LH) • Includes reflex reflector and wire cover

**50902** Red, RH w/ License Window

**50912** Red, LH w/ License Window

Material: Lens - Acrylic and Polycarbonate; Housing - Polycarbonate  
FMVSS: A, I, L, R2, S, T

Finish: Red

Bulb: 1156, 32 CP; Volts / Amps: 12V / 2.1A (R2)

Bulb: 2057, 32/2 CP; Volts / Amps: 12V / 2.1A (I,S)/.59A (T,L)

Bracket: 43842

Lens: Red 91302

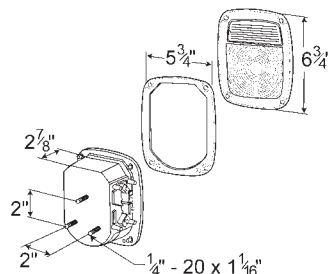

## TORSION MOUNT® THREE-STUD NAVISTAR®/VOLVO® STOP/TAI/TURN LAMP

Replaces LH Navistar® 424537-C91 and 424538-C91 • Replaces RH Volvo® 83701-0002 • Replaces RH Navistar® 424539-C91 • Replaces LH Volvo® 83702-0002 • Includes reflex reflector and wire cover

**50942** Red, RH w/ License Window

**50952** Red, LH w/ License Window

Material: Lens - Acrylic and Polycarbonate; Housing - Polycarbonate  
FMVSS: A, I, L, R2, S, T

Finish: Red

Bulb: 1156, 32 CP; Volts / Amps: 12V / 2.1A (R2)

Bulb: 2057, 32/2 CP; Volts / Amps: 12V / 2.1A (I,S)/.59A (T,L)

Bracket: 43842

Lens: Red 91302

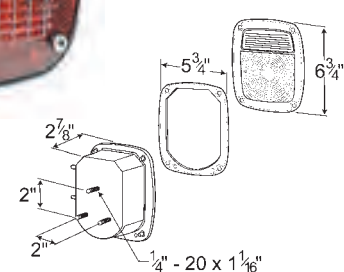

## TORSION MOUNT® TWO-STUD MACK®/DODGE® STOP/TAI/TURN LAMP

Fits both right hand and left hand • Includes OE 39" pigtail with ring terminal • Replaces Mack® 14M0444RP1 and 14M0444RP4 shock mount • Features a license window • Includes reflex reflector

**50992** Red

Material: Lens - Acrylic and Polycarbonate; Housing - Polycarbonate  
FMVSS: A, I, L, R2, S, T

Finish: Red

Bulb: 1156, 32 CP; Volts / Amps: 12V / 2.1A (R2)

Bulb: 2057, 32/3 CP; Volts / Amps: 12V / 2.1A (I,S)/.59A (T,L)

Bracket: 43262-5, 43022, 43022-5, 43272, 43272-5, 43842

Lens: Red 91302

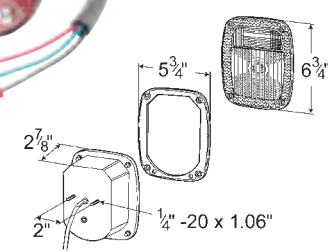

# Stop/Tail/Turn Lamps

Feux Arrêt / Arrière / Direction Lámparas de Freno / Cuarto / Direccional

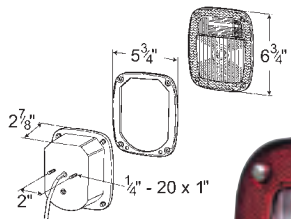
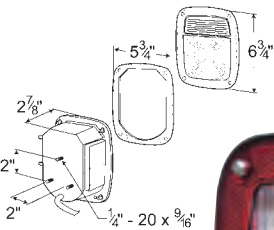
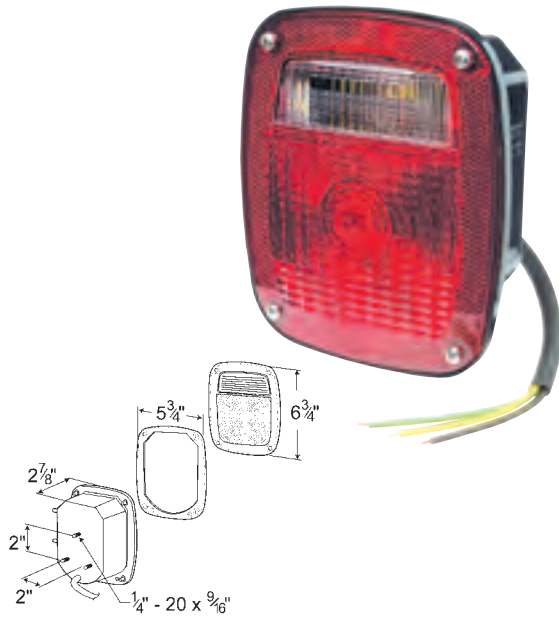

## THREE-STUD PETERBILT®/CHEVROLET®/JEEP®/GMC® STOP/TAI/TURN LAMP WITH PIGTAIL

Replaces Peterbilt® 16-02600R and 16-02600L • Replaces Chevrolet®/GMC® 370867 and 370868 • Replaces Jeep® SF5457197 and SF5457198  
• Features license window • Includes reflex reflector

**50972** Red w/ License Window

**50972-5** Red w/ License Window

RETAIL

Material: Lens - Acrylic and Polycarbonate; Housing - Polycarbonate  
FMVSS: A, I, L, R2, S, T

Finish: Red

Bulb: 1156, 32 CP

Volts / Amps: 12 V / 2.1A (R2)

Bulb: 1157, 32/3 CP

Volts / Amps: 12V / 2.1A (I,S)/.59A (T,L)

Bracket: 43842

Lens: Red 91302

## THREE-STUD, CHEVROLET®/FORD®/JEEP® STOP/TAI/TURN LAMP WITH SIDE MARKER LAMP AND MOLDED PIGTAIL TERMINATION

Round molded terminals • Replaces Chevrolet®/GMC® 477331 and 477332 (RH) • Replaces Jeep® SF5758255 and SF5758254 (LH)  
• Features sidemarkers • Includes reflex reflector

WITHOUT LICENSE WINDOW:

**52802** Red, RH

WITH LICENSE WINDOW:

**52812** Red, LH

Material: Lens - Acrylic; Housing - Polycarbonate  
FMVSS: RH - A, I, P2, R2, S, T; LH - A, I, L, P2, R2, S, T

Finish: Red

Bulb: 1156, 32 CP; Volts / Amps: 12V / 2.1A (R2)

Bulb: 1157, 32/3 CP; Volts / Amps: 12V / 2.1A (I,S)/.59A (T,L)

Bracket: 43842

Lens: Red 91302

## TORSION MOUNT® TWO-STUD DODGE® STOP/TAI/TURN LAMP WITH SIDE MARKER LAMP AND MOLDED PIGTAIL TERMINATION

Replaces Dodge® 4114562 (RH) • Replaces Dodge® 4114561 and 4114563 (LH) • Includes reflex reflector

WITHOUT LICENSE WINDOW:

**52822** Red, RH

WITH LICENSE WINDOW:

**52832** Red, LH

Material: Lens - Acrylic; Housing - Polycarbonate  
FMVSS: RH - A, I, P2, R2, S, T; LH - A, I, L, P2, R2, S, T

Finish: Red

Bulb: 1156, 32 CP; Volts / Amps: 12 V / 2.1A (R2)

Bulb: 1157, 32/3 CP; Volts / Amps: 12 V / 2.1(I,S)/.59A (T,L)

Bulb: 193, 2CP; Volts / Amps: 12V / .33A(P2)

Bracket: 43262-5, 43022, 43022-5, 43272, 43272-5, 43842

Lens: Red 91302

## TORSION MOUNT® TWO-STUD DODGE® STOP/TAIL/TURN LAMP

Standard mount pigtail • Replaces Dodge® truck 3895020 and 3895021  
 • Features license window • Includes reflex reflector

**52602** Red

Material: Lens - Acrylic and Polycarbonate; Housing - Polycarbonate  
 FMVSS: A, I, L, R2, S, T  
 Finish: Red  
 Bulb: 1156, 32 CP  
 Volts / Amps: 12V / 2.1A (R2)  
 Bulb: 1157, 32/2 CP  
 Volts / Amps: 12V / 2.1A (I,S)/.59A (T,L)  
 Bracket: 43262-5, 43022, 43022-5, 43272, 43272-5, 43842  
 Lens: Red 91302

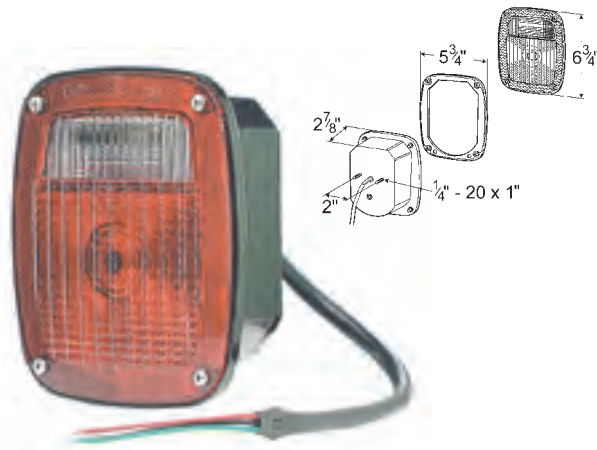

## TWO-STUD FORD® STOP/TAIL/TURN LAMP WITH PIGTAIL AND MOLDED PLUG

Studs on 1 3/4" centers • Retrofits Ford® OEM C7TZ13404C, DOTZ13404A, D3KZ13404A, D3TZ13403B, E2TB13404A, E2TB13405A • Features license window • Includes reflex reflector

**52972** Red

Material: Lens - Acrylic and Polycarbonate; Housing - Polycarbonate  
 FMVSS: A, I, L, R2, S, T  
 Finish: Red  
 Bulb: 1156, 32 CP  
 Volts / Amps: 12 V / 2.1A (R2)  
 Bulb: 2057, 32/2 CP  
 Volts / Amps: 12V / 2.1A (I,S)/.59A (T,L)  
 Bracket: 43262-5, 43022, 43022-5, 43272, 43272-5, 43842  
 Lens: Red 91302

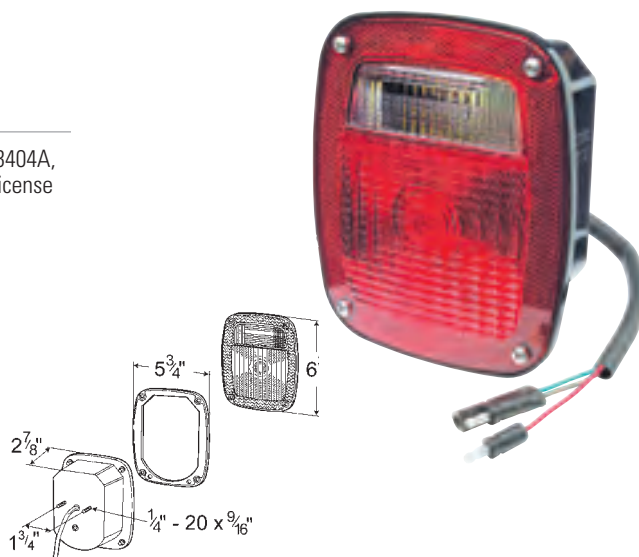

## 4" TWO-STUD STOP/TAIL/TURN LAMP

Snap-on lens • Rubber compression-sealed pigtail • Removable studs for school bus application

**WITH LICENSE WINDOW:**

**50852** Red

**50852-5** Red **RETAIL**

**WITHOUT LICENSE WINDOW:**

**50862** Red

**50862-5** Red **RETAIL**

Material: Lens - Acrylic and Polycarbonate (50832/-5); Housing - Polycarbonate  
 Lens - Acrylic and Polycarbonate (50862/-5)  
 FMVSS: I, L, P2, S, T  
 Finish: Red  
 Bulb: 1157, 32/3 CP  
 Volts / Amps: 12V / 2.1A (I,S)/.59A (P2,T,L)  
 Bracket: 43262-5, 43022, 43022-5, 43272, 43272-5, 43842  
 Pigtail: 68150  
 Lens: Red 90232

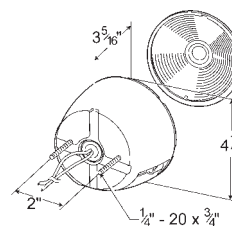

# Stop/Tail/Turn Lamps

Feux Arrêt / Arrière / Direction L mparas de Freno / Cuarto / Direccional

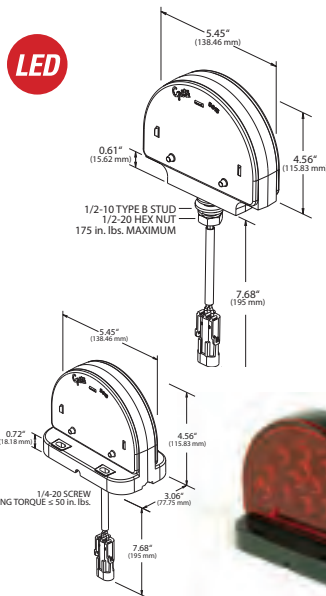
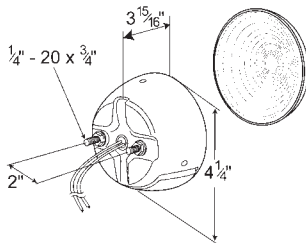
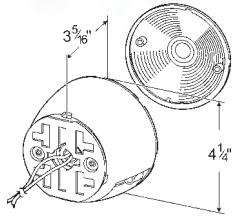

## 4" UNIVERSAL MOUNT STOP/TAIL/TURN LAMP

2-screw lens • Less than 75 sq. cm. of effective, projected luminous lens area • Rubber compression-sealed pigtail • Features license window  
• For use on vehicles less than 80" wide

### WITH LICENSE WINDOW:

**50872** Red

**50872-5** Red **RETAIL**

Material: Lens - Acrylic ; Housing - Polypropylene  
FMVSS: I, L, P2, S, T  
Finish: Red  
Bulb: 1157, 32/3 CP  
Volts / Amps: 12V / 2.1A (I,S)/.59A (L,P2,T)  
Bracket: 43262-5, 43022, 43022-5, 43272, 43272-5, 43842  
Pigtail: 68150  
Lens: Red 91482

## 4" STEEL TWO-STUD MOUNT STOP/TAIL/TURN LAMP

Less than 75 sq. cm. of effective, projected luminous lens area  
• Heavy-gauge, formed steel body • Rubber compression-sealed pigtail  
• For use on vehicles less than 80" wide

### WITH LICENSE WINDOW:

**50882** Red

### WITHOUT LICENSE WINDOW:

**50892** Red

Material: Lens - Acrylic ; Housing - Steel  
FMVSS: 50882 - I, L, P2, S, T; 50892 - I, P2, S, T  
Finish: Red  
Bulb: 1157, 32/3 CP  
Volts / Amps: 12V / 2.1A (I,S)/.59A (L,P2,T)  
Bracket: 43262-5, 43022, 43022-5, 43272, 43272-5, 43842  
Pigtail: 68150  
Lens: Red 90252

## LED STOP/TAIL/TURN LAMP FOR AGRICULTURE & OFF-HIGHWAY APPLICATIONS

Lamps meet the latest ASABE S279 specifications • Lamps may be mounted right side up, upside down, or vertically and still meet compliance specifications • Lamps employ bi-voltage circuitry – 12/24 volt

**56150-5** Yellow and Yellow, Pedestal

**56160-5** Yellow and Yellow, Surface Mount

**56170-5** Red, Pedestal

**56180-5** Red, Surface Mount

Material: Lens - High Impact Acrylic / Housing - ABS  
FMVSS: 56150-5 & 56160-5: I6; 56170-5 & 56180-5: I, S, T  
Other: IP67 Compliant  
Finish: Yellow, Red  
Voltage: Bi-voltage, 12 and 24 Vol



## HI COUNT® DOUBLE-FACE LED STOP/TAIL/TURN LAMP WITH SIDEMARKER

Attractive multiple diode design • 2-stud mounting bolts • 25 diodes on either front or back with two diodes in the sidemarker • Attached three-wire harness • Includes reflex reflector

- G5530** Red and Yellow, LH
- G5530-5** Red and Yellow, LH RETAIL
- G5540** Red and Yellow, RH
- G5540-5** Red and Yellow, RH RETAIL
- G5543-5** Yellow and Yellow, w/ Packard Connector RETAIL

Material: Lens - Acrylic ; Housing - Chrome Plated ABS  
 FMVSS: A, I, T, P, P2  
 Finish: Chrome/Red/Amber  
 Volts / Amps: 12V / .775A (I)/.038A (P/P2/T)

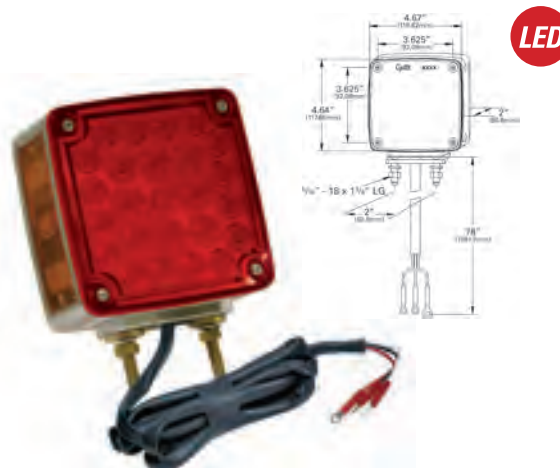

## TWO-STUD PLUG-IN LAMP WITH SIDEMARKER

Incorporates sidemarker light • Fits right or left side • Keyed, plug-in receptacle, accepts OEM harness • Standard with Navistar®/Volvo®  
 • Vertical mount • Includes reflex reflector

- 55470** Red and Yellow

Material: Lens - Acrylic ; Housing - Polycarbonate  
 FMVSS: A, I, P2  
 Finish: Red / Yellow  
 Bulb: 1156, 32 CP  
 Volts / Amps: 12V 2.1A (I)  
 Bulb: 193, 2 CP  
 Volts / Amps: 12V / .33A (P2)  
 Lens: Red 91502; Yellow 91503; Sidemarker - Yellow 91513

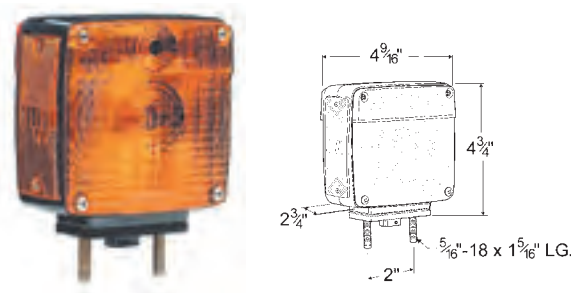

## TWO-STUD CHROME LAMP WITH PIGTAIL

Switch lens for right or left applications • Ground wire plus tab • PVC wire jacket material • 73" color coded pigtail • Vertical mount • Includes reflex reflector

- 55340** Red and Yellow

Material: ABS/Acrylic/Polycarbonate  
 FMVSS: A, I, P2  
 Finish: Red / Yellow  
 Bulb: 1156, 32 CP  
 Volts / Amps: 12V / 2.1A (I)  
 Bulb: 193, 2 CP  
 Volts / Amps: 12V / .33A (P2)  
 Lens: Red 90482, Yellow 90483; Sidemarker - Yellow 94643

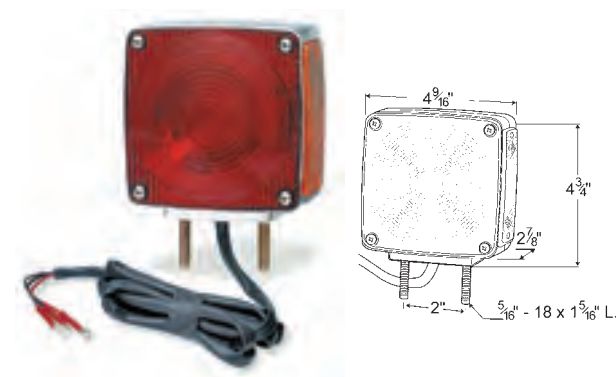

## TWO-STUD LAMP WITH PIGTAIL

High-heat acrylic lens • 2" mounting centers • Incorporates sidemarker light • Replaces Chevrolet®/GMC® 2017747 (RH) and 2017751 (LH)  
 • Includes reflex reflector

- 55410** Red and Yellow, RH
- 55420** Red and Yellow, LH

Material: Lens - Acrylic; Housing - Polycarbonate  
 FMVSS: A, I, P, P2  
 Finish: Red / Yellow  
 Bulb: 1156, 32 CP  
 Volts / Amps: 12V / 2.1A (I)  
 Bulb: 193, 2 CP (X2)  
 Volts / Amps: 12V / .66A (P,P2)  
 Lens: Red 91502, Yellow 91503; Sidemarker - Yellow 91513

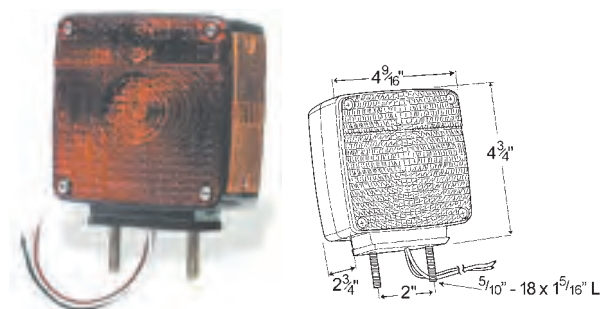

# Stop/Tail/Turn Lamps

Feux Arrêt / Arrière / Direction Lámparas de Freno / Cuarto / Direccional

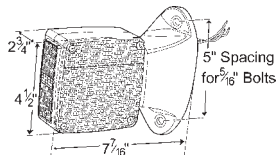

## PEDESTAL-MOUNT LAMP WITH PIGTAIL

Polycarbonate pedestal for fender contours • Incorporates sidemarker light  
 • Replaces Chevrolet®/GMC® 2017745 and 2006674 (RH) • Replaces Chevrolet®/GMC® 2017746 and 2006673 (LH) • Includes reflex reflector

**55430** Red and Yellow, RH

**55440** Red and Yellow, LH

Material: Lens - Acrylic; Housing - ABS/Polycarbonate

FMVSS: A, I, P, P2

Finish: Red / Yellow

Bulb: 1156, 32 CP

Volts / Amps: 12V / 2.1 A(I)

Bulb: 193, 2 CP (x2)

Volts / Amps: 12V / .66A (P,P2)

Lens: Red 91502, Yellow 91503; Sidemarker - Yellow 91513

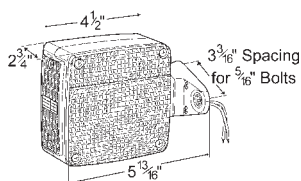

## PEDESTAL-MOUNT LAMP WITH PIGTAIL

High-heat acrylic-lens • Incorporates sidemarker light • Replaces Chevrolet®/GMC® 694628 (RH) • Replaces Chevrolet®/GMC® 694627 (LH) • Includes reflex reflector

**55450** Red and Yellow, RH

**55460** Red and Yellow, LH

Material: Lens - Acrylic; Housing - ABS/Polycarbonate

FMVSS: A, I, P, P2

Finish: Red / Yellow

Bulb: 1156, 32 CP

Volts / Amps: 12V / 2.1A (I)

Bulb: 193, 2 CP (X2)

Volts / Amps: 12V / .66A (P,P2)

Lens: Red 91502, Yellow 91503; Sidemarker - Yellow 91513

LED

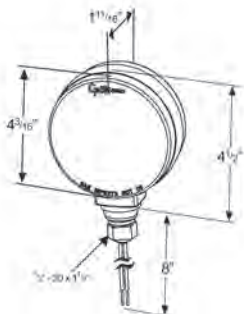

## 4" HI COUNT® DOUBLE-FACE LED LAMP

Attractive multiple diode design • Heavy-duty housing with hardwired connection for variable wiring options • Two-wire, double-contact installation

**G5300** Red and Yellow

Material: Lens - Acrylic; Housing - Chrome Plated Die-cast Zinc

FMVSS: I, T

Finish: Chrome/Red/Yellow

Volts / Amps: 12V / .77A (I), .038A (T)

Lens: Red: 92062; Yellow: 92063

## 4" ZINC DIE-CAST DOUBLE-FACE LAMP

Less than 75 sq cm of effective, projected luminous lens area • For use on vehicles less than 80" wide

### DOUBLE CONTACT:

- 53000** Red and Yellow, Chrome-Plated
- 53020** Red and Yellow, Black Enamel Finish
- 53023** Yellow and Yellow, Black Enamel Finish

### SINGLE CONTACT:

- 56000** Red and Yellow, Chrome-Plated
- 56020** Red and Yellow, Black Enamel Finish

Material: Lens - Acrylic; Housing - Chrome Plated Die-cast Zinc  
 FMVSS: Double - I, P; Single - I  
 Finish: Red / Yellow  
 Bulb: (53000, 53020, 53023) 1157, 32/3 CP  
 Volts / Amps: 12V / .59A (P)/2.1A (I)  
 Bulb: (56000, 56020) 1156, 32 CP  
 Volts / Amps: 12V / 2.1A (I)  
 Pigtail: 68130, 68170  
 Lens: Red 91582; Yellow 91583

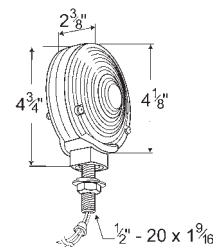

## 4" DIE-CAST SINGLE-FACE LAMP

Less than 75 sq cm of effective, projected luminous lens area • For use on vehicles under 80" wide • Wire exit includes a grommet to protect the jacket from abrasion

### DOUBLE CONTACT:

- 53032** Red, Chrome-Plated
- 53052** Red, Black Finish
- 53053** Yellow, Black Finish

### SINGLE CONTACT:

- 56052** Red, Black Finish
- 56053** Yellow, Black Finish

Material: Lens - Acrylic; Housing - Chrome Plated Die-cast Zinc  
 FMVSS: Double - I, S, T; Single - I, S  
 Finish: Red / Yellow  
 Bulb: (53032, 53093) 1157, 32/3 CP  
 Volts / Amps: 12V / .59A (P,T)/2.1A (I)  
 Bulb: (56052, 56033) 1156, 32 CP  
 Volts / Amps: 12V / 2.1A (I,S)  
 Bulb: (53032) 2057, 32 CP  
 Volts / Amps: 12V / 2.1A (I,S)/.48A (T)  
 Pigtail: 68130, 68170  
 Lens: Red 91582

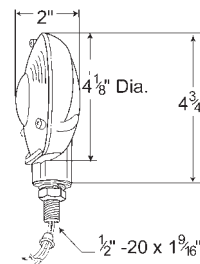

## THIN-LINE ZINC DIE-CAST DOUBLE-FACE LAMP

For fender or front bracket mount • Wire exit has a grommet to protect the jacket from abrasion • Single contact

- 55280** Red and Yellow, Baked Aluminum Finish
- 55290** Red and Yellow, Chrome-Plated

Material: Lens - Polycarbonate; Housing - Die-cast Zinc  
 FMVSS: I  
 Finish: Red/ Yellow  
 Bulb: 1156, 32 CP  
 Volts / Amps: 12V / 2.1A  
 Pigtail: 68170  
 Lens: Red 90232, Yellow 90233

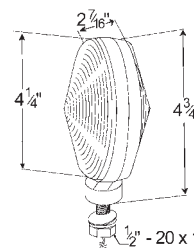

# Stop/Tail/Turn Lamps

Feux Arrêt / Arrière / Direction Lámparas de Freno / Cuarto / Direccional

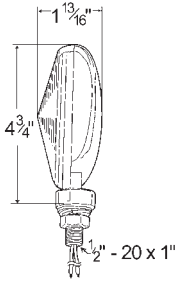

## THIN-LINE DIE-CAST SINGLE-FACE LAMP

Snap-grip acrylic lens • Rubber o-rings • Easy bulb and lens replacement  
• Wire exit has a grommet to protect the jacket from abrasion

### DOUBLE CONTACT:

**50652** Red, Chrome-Plated  
**50662** Red, Silver Finish

Material: Lens - Acrylic; Housing - Chrome Plated Die-cast Zinc  
FMVSS: Double - I, S, T; Red  
Finish: Red  
Bulb: 1157, 32/3 CP  
Volts / Amps: 12V / 2.1A (I,S)/.59A (T)  
Pigtail: 68130, 68170  
Lens: Red 90232, Yellow 90233

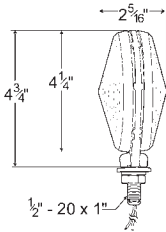

## THIN-LINE DOUBLE-FACE LAMP

Easy snap-on lenses • Molded-in baffle • Molded-in o-ring • Wire exit has a grommet to protect jacket against abrasion

### DOUBLE CONTACT:

**50630** Red and Yellow  
**50630-5** Red and Yellow **RETAIL**

### SINGLE CONTACT:

**55220** Red and Yellow  
**55220-5** Red and Yellow **RETAIL**  
**55223** Yellow and Yellow  
**55223-5** Yellow and Yellow **RETAIL**

Material: Lens - Acrylic; Housing - Polycarbonate  
FMVSS: Double - I, P; Single - I  
Finish: Red / Yellow  
Bulb: (50630, 50630-5) 1157, 32/3 CP  
Volts / Amps: 12V / 2.1A (I), .59A (P)  
Bulb: (55220, 55220-5, 55223, 55223-5) 1156, 32 CP  
Volts / Amps: 12V / 2.1A (I)  
Pigtail: 68170, 68130  
Lens: Red 90232, Yellow 90233

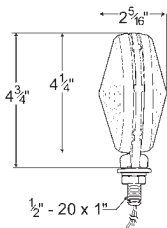

## SINGLE-FACE LAMP

Easy snap-on lens • Molded-on baffle • Rubber plug-in pedestal

### DOUBLE CONTACT:

**50642** Red  
**50642-5** Red **RETAIL**

### SINGLE CONTACT:

**55243** Yellow

Material: Polycarbonate  
FMVSS: (50642, 50642-5) Red; I, S, T; (55243) Yellow; I  
Finish: Red / Yellow  
Bulb: (50642, 50642-5) - 1157, 32/3 CP  
Volts / Amps: 12V / 2.1A (I,S)/.59A (T)  
Bulb: (55243) 1156, 32 CP  
Volts / Amps: 12V / 2.1A (I,S)  
Pigtail: 68130, 68170  
Lens: Red 90232, Yellow 90233

## STEEL SINGLE-FACE LAMP

Snap-ring lens application • Two-wire pigtail • Long-life bulb

**DOUBLE CONTACT:**  
**50352** Red

Material: Lens - Acrylic; Housing - Steel  
 FMVSS: I, P2, P3, S, T  
 Finish: Red  
 Bulb: 1157, 32/3 CP  
 Volts / Amps: 12V / 2.1A (I,S)/.59A (P2,P3,T)  
 Accessory: Snap Ring 99593  
 Pigtail: 68130  
 Lens: Red 90012



## 7" LED STOP/TAIL/TURN LAMP

Encapsulant potting provides protection for the circuit board • UV-protected lenses • Male .180 bullet connectors • Surface mount installation (no cut-outs required) • Install using 10 screws

**STOP/TAIL/TURN LAMP**  
**53422** Red, Stop/Tail/Turn Lamp w/Reflex

**SINGLE FUNCTION:**  
**55982** Red, Turn Lamp w/ Reflex  
**55983** Yellow, Front Turn Lamp w/ Reflex  
**55992** Red, Turn Lamp w/o Reflex  
**55993** Yellow, Turn Lamp w/o Reflex

Material: Polycarbonate  
 FMVSS: 53422 - A, I, P2, S, T; 55982 - A, I, S; 55983 - A, I; 55992/3 - I  
 Finish: Red/Yellow  
 Volts / Amps: S/T/T - 12V / .39A (A,I)/.03A (P2,T)  
 Volts / Amps: Single Function - 12V / .39A (I,S)  
 Bracket: 93982

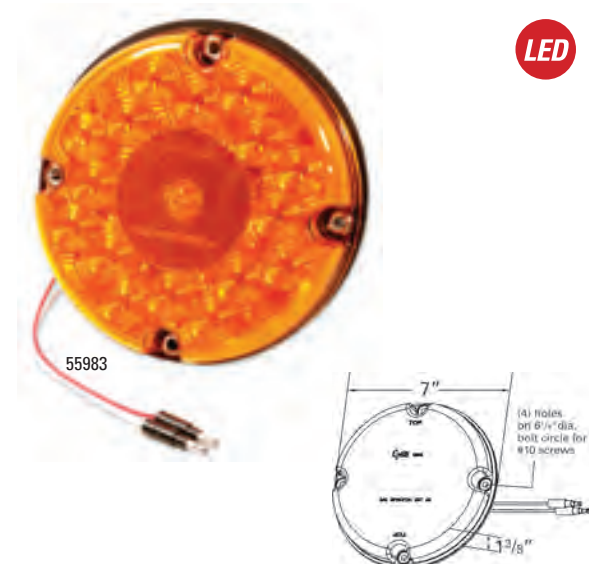

LED

## 7" LED ARROWTURN LAMP

Large arrow pattern makes it easier for road traffic to identify turning vehicles • Meets FMVSS 108 Front and Rear Turn requirements • Auxiliary for midturn and/or wide turn indications • Surface mount for easy installation • UV-coated lens prevents weathering from the elements • Mounts with 10 screws

**53883** Yellow, Turn Lamp

Material: Polycarbonate  
 FMVSS: I  
 Finish: Yellow  
 Volts / Amps: 12V / .327A  
 Bracket: 93982



LED

# Stop/Tail/Turn Lamps

Feux Arrêt / Arrière / Direction Lámparas de Freno / Cuarto / Direccional

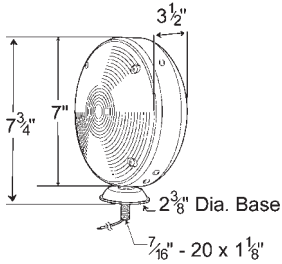

## 7" DOUBLE-FACE PEDESTAL LAMP

For simultaneous front and rear warning • Pedestal mounting • Baked black enamel finish

### TURN:

**78150** Red and Yellow  
**78153** Yellow and Yellow

### AUXILIARY:

**78152** Red and Red

Material: Lens - Acrylic; Housing - Steel  
 FMVSS: 78150, 78153 - I, S  
 Finish: Red / Yellow  
 Bulb: 1156, 32 CP  
 Volts / Amps: 12V / 2.1A (I)  
 Pigtail: 68080  
 Lens: Red 90092, Yellow 90093



## 7" SINGLE-FACE LAMP

Two-stud or bracket mounting • Heavy-gauge formed steel housing  
 • Yellow arrow design for rear turn only • 78303 and 78313 not for front turn use

**78002** Red  
**78003** Yellow  
**78303** Yellow, Arrow Lens, Molded .180 Terminal Pigtail  
**78313** Yellow, Arrow Lens, Blunt Cut Pigtail

Material: Lens - Acrylic; Housing - Steel  
 FMVSS: Red - I, S; Yellow & Yellow Arrow - I; Arrow Lens - I  
 Finish: Yellow / Red / Black  
 Bulb: 1156, 32 CP  
 Volts / Amps: 12V / 2.1A (I,S)  
 Bracket: 43282, 93982  
 Pigtail: 68080  
 Lens: Red 90092, Yellow 90093; Arrow Lens - Yellow 90103

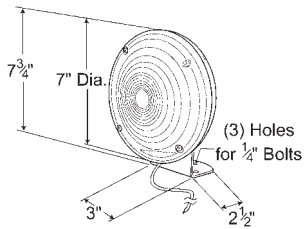

## 7" SCHOOL BUS LAMPS

Rugged housing • Acrylic lens • Flush mount • Blunt cut wires

### SINGLE CONTACT:

**56072** Red  
**56073** Yellow  
**56083** Yellow w/ Arrow Lens

### DOUBLE CONTACT:

**50132** Red

Material: Lens - Acrylic; Housing - Steel  
 FMVSS: I, S, T  
 Finish: Red / Yellow / Black  
 Bulb: 1157, 32/3 CP (x2) (50132)  
 Volts / Amps: 12V / 2.1A (I,S)/.59A (T) Double Contact  
 Bulb: 1156, 32 CP (56072, 56073, 56083)  
 Volts / Amps: 12V / 2.1A (I,S) Single Contact  
 Lens: Red 99842, Yellow 99843

