

Clearance/Marker Lamps

Feux de Gabarit / Position L mparas de G libo / Demarcadora

MICRONOVA® DOT LED CLEARANCE/MARKER LAMP

Available in PC and P2 versions with .180 bullet connectors • Sleek aerodynamic styling extends less than 3/8" from mounted surface • No fasteners required

P2 RATED:			
49322	Red, w/ Grommet		
49323	Yellow, w/ Grommet	NEW	
PC RATED:			
49452	Red, w/ Bracket	PC	NEW
49453	Yellow, w/ Bracket	PC	NEW
49332	Red, w/ Grommet	PC	
49333	Yellow, P2/PC w/ Grommet	PC	
49412	Red, w/ Adapter Bracket	PC	
49413	Yellow, w/ Adapter Bracket	PC	
45302	Red, w/ Hardshell	PC	NEW
45303	Yellow, w/ Hardshell	PC	NEW
ECE RATED:			
49341	White, w/ Grommet	ECE	
49342	Red, w/ Grommet	ECE	
49343	Yellow, w/ Grommet	ECE	
49351	White, w/ Grommet	ECE	24 VOLT
49352	Red, w/ Grommet	ECE	24 VOLT
49353	Yellow, w/ Grommet	ECE	24 VOLT
MULTI VOLT			
49262	Red, w/ Grommet	PC	MULTI NEW
49282	Red, w/ Grommet	PC	MULTI NEW ECE
49263	Yellow, w/ Grommet	PC	MULTI NEW
49283	Yellow, w/ Grommet	PC	MULTI NEW ECE

Material: Lens - Acrylic; Bracket - Polycarbonate; Grommet - PVC
 FMVSS: P2, P3, PC, ECE
 Finish: Red, Yellow, White
 Volts / Amps: 12V / .05A
 24V / .05A
 9-32V / .03A
 Brackets: 42110, 42270, 94350

DUAL INTENSITY MICRONOVA® DOT LED CLEARANCE/MARKER LAMP

Dual Intensity allows for better visibility • Hermetic lens-to-housing seal
 • Encapsulant potting for total circuit board protection against vibration and corrosion
 • Sleek aerodynamic styling, small size fits in narrow applications

49362	Red, w/ Grommet, Standard
49363	Yellow, w/ Grommet, Standard

Material: Lens - Acrylic; Grommet - PVC
 FMVSS: P2
 Finish: Red/ Black ; Yellow/ Black
 Volts / Amps: High - 12V / .05A; Low - 12V / .02A;

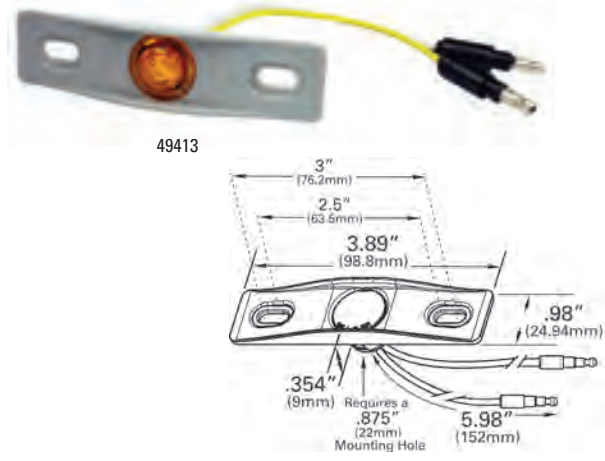
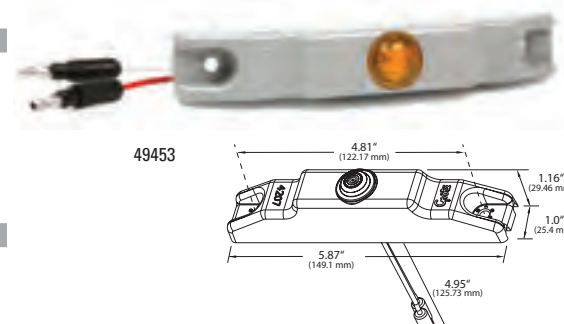

Clearance/Marker Lamps

Feux de Gabarit / Position Lámparas de Gálibo / Demarcadora

LED



MICRONOVA® LED CLEARANCE/MARKER LAMP

Low profile makes lamp less susceptible to damage • Small size fits narrow applications • Hermetic lens-to-housing seal • Potted for total circuit board protection against vibration and corrosion • All PC versions meet requirements when mounted at 45° angle

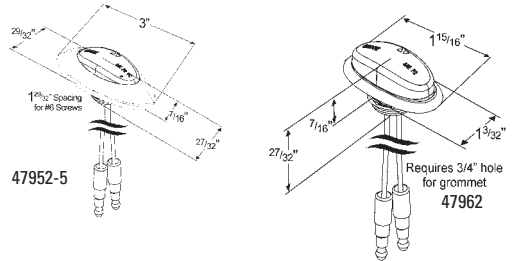

- 47952 Red, w/ Chrome Bezel
- 47982 Red, Clear Lens w/ Chrome Bezel
- 47953 Yellow, w/ Chrome Bezel
- 47983 Yellow, Clear Lens w/ Chrome Bezel
- 47962 Red, w/ Grommet
- 47963 Yellow, w/ Grommet

PC RATED:		
45282	Red, surface mount	PC
45283	Yellow, surface mount	PC
47972	Red, w/ Grommet	PC
47973	Yellow, w/ Grommet	PC
45302	Red, w/ Hardshell	PC NEW
45303	Yellow, w/ Hardshell	PC NEW



Material: Lens - Acrylic; Bracket - Polycarbonate; Grommet - PVC
 FMVSS: P2, PC
 Finish: Red / Yellow / Chrome
 Volts / Amps: 12V / .05A
 Pigtail: 68580
 Accessory: Bezel Chrome 93803; Mounting Gasket: 94220
 Bracket: 42110

LED



DUAL INTENSITY MICRONOVA® LED CLEARANCE/MARKER LAMP

Dual Intensity enhances signaling visibility and safety • Hermetic lens-to-housing seal • Encapsulant potting for total circuit board protection against vibration and corrosion • Small size fits in narrow applications • Grommet mount versions have no exposed fasteners

- 49372 Red, w/ Grommet, Slim-Line .180
- 49373 Yellow, w/ Grommet, Slim-Line .180
- 49382 Red, w/ Grommet, Standard .180
- 49383 Yellow, w/ Grommet, Standard .180

Material: Lens - Acrylic; Grommet - PVC
 FMVSS: P2
 Finish: Red, Yellow
 Volts / Amps: 12V / .05A
 Brackets: 42110, 42112

LED

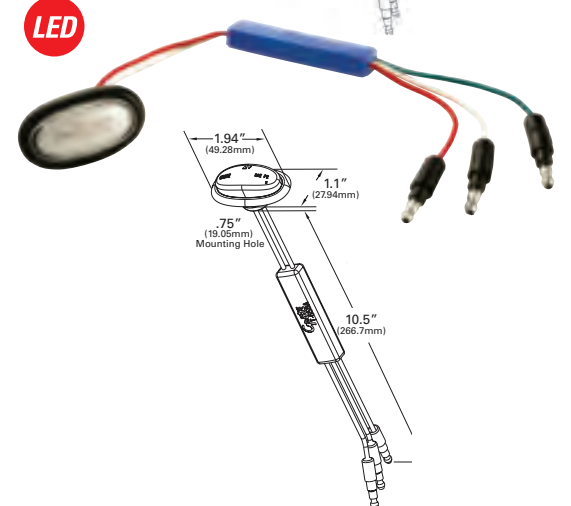

MICRONOVA® RED/GREEN INDICATOR LAMP

Suitable for bright sunlight applications • Dual color circuiting molded into pigtail with Bullet Connectors • Clear lens with Red / Green LEDs • Grommet mount with no exposed fasteners

- 49460 Red/Green, Clear Lens w/ Grommet

Material: Lens - Clear; Grommet - Polycarbonate
 Ingress Protection: IP69K
 Voltage Amp: 12 Volt

MICRONOVA® DOT LED INDICATOR LAMP

LED

Durable one-piece LED lamp • No mounting hardware required • Hardwired with .180 standard UBS plug connectors for maximum performance

60824 Green, w/Grommet

Material: Polycarbonate
Finish: Green
Voltage Amp: 12V / .05A
Brackets: 42110, 42270, 94350

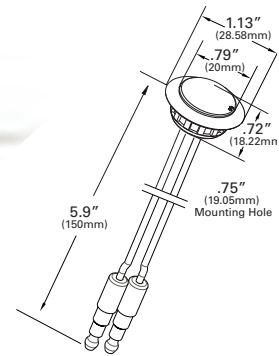

SUPERNOVA® 2" LED CLEARANCE/MARKER LAMP

LED

Encapsulant potting for total circuit board protection • Hermetic lens-to-housing seal • Uses same UBS double-seal pigtail as incandescent for quick Plug-and-Go® retrofit • Tin-plated, solid-brass terminals are sealed to housing to resist corrosion and eliminate failure causing leak paths

- | | | |
|--------------|--------|-------------------|
| 47112 | Red | |
| 47113 | Yellow | |
| 47332 | Red | 24
VOLT |
| 47333 | Yellow | 24
VOLT |
| 46132 | Red | PC |
| 46133 | Yellow | PC |

ABS LAMP:
78433 Yellow

Material: Polycarbonate
FMVSS: P2, PC, P3
Finish: Red/Yellow
Volts / Amps: 12V / .06A
Volts / Amps: Red - 24V / .03A
Volts / Amps: Yellow - 24V / .04A
Bracket: 43690, 49140, 43150, 43152, 43153, 43532, 43760, 42180, 42190, 43430
Grommet: 92120, 92150, 93760
Pigtail: 66851, 67001, 66850, 66801, 67050, 66800, 66840



47112

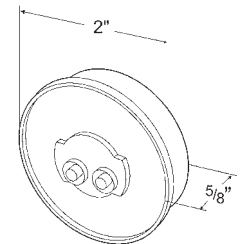

46133

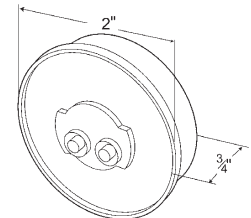

HI COUNT® 2" 9-DIODE LED CLEARANCE/MARKER LAMP

LED

Hermetic lens-to-housing seal • Uses the same UBS double-seal pigtail as our incandescent version for a quick Plug-and-Go® retrofit • Twist-on mounting for easy installation • Fits all popular mountings and grommets

- | | | |
|----------------|--------|---------------|
| G3002 | Red | |
| G3002-5 | Red | RETAIL |
| G3003 | Yellow | |
| G3003-5 | Yellow | RETAIL |

Material: Polycarbonate
FMVSS: P2
Finish: Red / Yellow
Volts / Amps: 12V / .09A
Bracket: 43690, 49140, 43150, 43152, 43153, 43532, 43760, 42180, 42190
Grommet: 92120, 92150, 93760
Pigtail: 66851, 67001, 66850, 66801, 67050, 66800, 66840

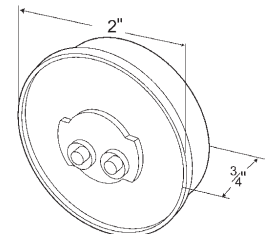

Clearance/Marker Lamps

Feux de Gabarit / Position Lámparas de Gálibo / Demarcadora

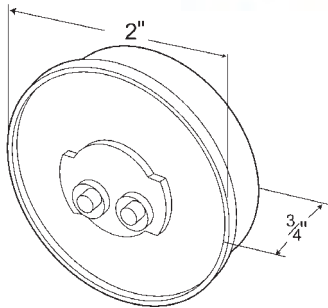

2" CLEARANCE/MARKER LAMP

Hermetic lens-to-housing seal • Twist-on mounting for easy installation
 • Fits all popular mountings and grommets • 12-Volt version features a 12,000+ hour bulb • All versions meet PC requirements when mounted at a 45° angle, recommended bracket 43690

45822	Red	PC
45822-5	Red	PC RETAIL
45823	Yellow	PC
45823-5	Yellow	PC RETAIL
45202	Red	PC 24 VOLT
45203	Yellow	PC 24 VOLT

KITS:

45062	Red (45822 + 92120 + 67050)	PC
45063	Yellow (45823 + 92120 + 67050)	PC
45562	Red (45822 + 43150)	PC
45563	Yellow (45823 + 43150)	PC

ABS LAMP:

78333	Yellow	PC
-------	--------	----

Material: Polycarbonate
 FMVSS: P2, P3, PC, PC2
 Finish: Red / Yellow
 Bulb: 2 CP
 Volts / Amps: 12V / .33A
 Bulb: 3 CP
 Volts / Amps: 24V / .17A
 Bracket: 43690, 49140, 43150, 43152, 43153, 43532, 43760, 42180, 42190
 Grommet: 92120, 92150, 93760
 Pigtail: 66851, 67001, 66850, 66801, 67050, 66800, 66840

LED

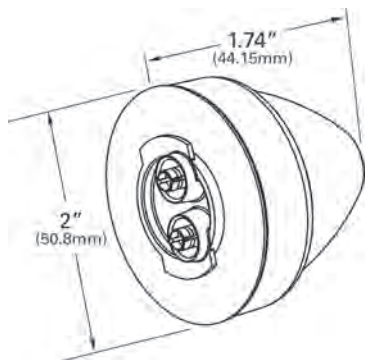

SUPERNOVA® 2" BEEHIVE LED CLEARANCE/MARKER LAMP

Encapsulant potting for total circuit board protection • Tin-plated, solid-brass terminals are sealed to housing to resist corrosion and eliminate failure causing leak paths • Uses same UBS double-seal pigtail as incandescent for a quick Plug-and-Go® retrofit • Hermetic lens-to-housing seal

47212	Red
47213	Yellow

Material: Polycarbonate
 FMVSS: P2
 Finish: Red / Yellow
 Volts / Amps: 12V / .06A
 Bracket: 43690, 49140, 43150, 43152, 43153, 43532, 43760, 42180, 42190
 Grommet: 92120, 92150, 93760
 Pigtail: 66851, 67001, 66850, 66801, 67050, 66800, 66840

Clearance/Marker Lamps

Feux de Gabarit / Position Lámparas de Gálibo / Demarcadora

25

HI COUNT® 2" 9-DIODE BEEHIVE LED CLEARANCE/MARKER LAMP

Uses the same UBS double-seal pigtail as the incandescent version for a quick Plug-and-Go® retrofit • Twist-on mounting for easy installation • Concentric, multiple diode layout • Fits all popular mountings and grommets

G3092 Red **PC**
G3093 Yellow **PC**

Material: Polycarbonate
FMVSS: P2, PC
Finish: Red / Yellow
Volts / Amps: 12V / .09A
Bracket: 43690, 49140, 43150, 43152, 43153, 43532, 43760, 42180, 42190
Grommet: 92120, 92150, 93760
Pigtail: 66851, 67001, 66850, 66801, 67050, 66800, 66840

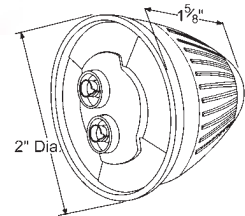

2" BEEHIVE CLEARANCE/MARKER LAMP

12-Volt version features a 12,000+ hour bulb • Fits popular grommet and bracket mountings • Hermetic lens-to-housing seal • Twist-on mounting for easy installation • Fits all popular mountings and grommets • Meets PC function only when mounted at a 45° angle, recommended bracket 43690

47102 Red **PC**
47103 Yellow **PC**

Material: Polycarbonate
FMVSS: P2, PC
Finish: Red / Yellow
Bulb: 2 CP
Volts / Amps: 12V / .33A
Bracket: 43690, 49140, 43150, 43152, 43153, 43532, 43760, 42180, 42190
Grommet: 92120, 92150, 93760
Pigtail: 66851, 67001, 66850, 66801, 67050, 66800, 66840

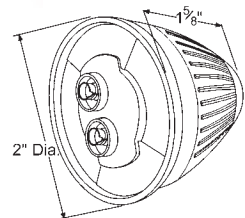

CLEARANCE / MARKER LAMPS

grote.com

Grote

25

Clearance/Marker Lamps

Feux de Gabarit / Position Lámparas de Gálibo / Demarcadora

LED

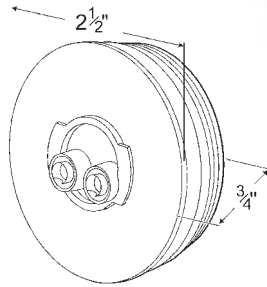

47122



46142

SUPERNOVA® 2 1/2" LED CLEARANCE/MARKER LAMP

Encapsulant potting for total circuit board protection • Hermetic lens-to-housing seal • Uses same UBS double-seal pigtail as incandescent version for a quick Plug-and-Go® Retrofit • Tin-plated, solid-brass terminals are sealed to housing, to resist corrosion and eliminate failure causing leak paths

47122	Red	
47123	Yellow	
47202	Red w/ Black, Theft-Resistant Flange	
47322	Red	24V
47323	Yellow	24V
46142	Red	PC
46143	Yellow	PC

KITS:

47472	Red (47122 + 91400 + 67001)
47473	Yellow (47123 + 91400 + 67001)

ABS LAMP:

78423	Yellow
-------	--------

Material: Polycarbonate
 FMVSS: P2, PC, P3
 Finish: Red / Yellow
 Volts / Amps: 12V / .06A
 Volts / Amps: 24V / .03A
 Bracket: 43690, 43160, 43162, 43163, 43512, 43522, 49140, 93750, 42180, 42170
 Grommet: 91400, 91410, 92070, 91890, 91880, 92920
 Pigtail: 66851, 67001, 66850, 66801, 67050, 66800, 66840

LED

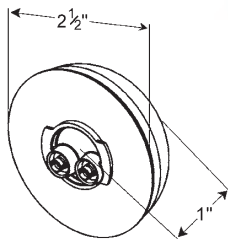

47373

SUPERNOVA® 2 1/2" PC RATED, LED CLEARANCE/MARKER LAMP

Hermetic lens-to-housing seal • Optic lens optimizes photometric performance and broadens light pattern • Encapsulant potting for total circuit board protection • Uses same UBS double-seal pigtail as incandescent for a quick Plug-and-Go® Retrofit • Tin-plated, solid-brass terminals are sealed to housing, to resist corrosion and eliminate failure causing leak paths
 • Available with lamp sealed to flange, for direct mounting in the side of a trailer without creating leaks in the trailer

47232	Red	PC
47233	Yellow	PC

SEALED FLANGE APPLICATIONS:

47423	Yellow w/ Black, Theft-Resistant Flange	PC
47372	Red w/ Gray, Theft-Resistant Flange	PC
47373	Yellow w/ Gray, Theft-Resistant Flange	PC

Material: Polycarbonate
 FMVSS: P2, P3, PC
 Finish: Red / Yellow
 Volts / Amps: 12V / .06A
 Bracket: 43690, 43160, 43162, 43163, 43512, 43522, 49140, 93750, 42180, 42170
 Grommet: 91400, 91410, 92070, 91890, 91880, 92920
 Pigtail: 66851, 67001, 66850, 66801, 67050, 66800, 66840

Clearance/Marker Lamps

Feux de Gabarit / Position Lámparas de Gálibo / Demarcadora

HI COUNT® 2 1/2" LED CLEARANCE/MARKER LAMP

Hermetic lens-to-housing seal • Uses the same UBS double-seal pigtail as the incandescent version for a quick Plug-and-Go® retrofit • Twist-on mounting for easy installation • Fits all popular mountings and grommets

OPTIC LENS:

G1032	Red	
G1032-5	Red	RETAIL
G1033	Yellow	
G1033-5	Yellow	RETAIL
G1042	Red, Clear Lens	
G1043	Yellow, Clear Lens	

REFLEX LENS:

G1002	Red
G1003	Yellow

Material: Polycarbonate
FMVSS: Optic - P2, Reflex - A, P2
Finish: Red / Yellow
Volts / Amps: Optic - 12V / .15A
Volts / Amps: Reflex - 12V / .13A
Bracket: 43690, 43160, 43162, 43163, 43512, 43522, 49140, 93750, 42180, 42170
Grommet: 91400, 91410, 92070, 91890, 91880, 92920
Pigtail: 66851, 67001, 66850, 66801, 67050, 66800, 66840

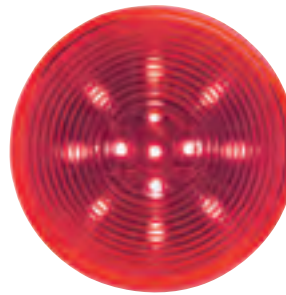

G1032

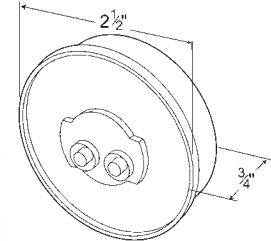

G1003

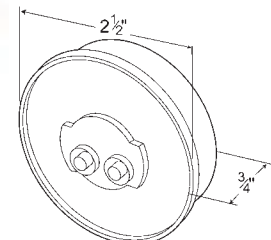

HI COUNT® 2 1/2" 9-DIODE LED CLEARANCE/MARKER LAMP

Hermetic lens-to-housing seal • Uses the same UBS double-seal pigtail as our incandescent version for a quick Plug-and-Go® retrofit • Twist-on mounting for easy installation • Fits all popular mountings and grommets

G1092	Red
G1093	Yellow

Material: Polycarbonate
FMVSS: P2
Finish: Red / Yellow
Volts / Amps: 12V / .09A
Bracket: 43690, 43160, 43162, 43163, 43512, 43522, 49140, 93750, 42180, 42170
Grommet: 91400, 91410, 92070, 91890, 91880, 92920
Pigtail: 66851, 67001, 66850, 66801, 67050, 66800, 66840

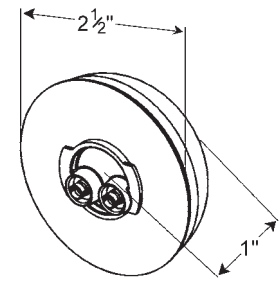

Clearance/Marker Lamps

Feux de Gabarit / Position Lámparas de Gálibo / Demarcadora



45812



45833

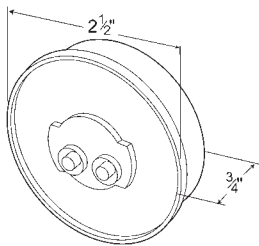

2 1/2" CLEARANCE/MARKER LAMP

Hermetic lens-to-housing seal • Twist-on mounting for easy installation
 • Fits all popular mountings and grommets • 12-Volt version features a 12,000+ hour bulb • Optic lens versions meet PC function only when mounted at a 45° angle, recommended bracket: 43690; grommets: 91880, or 91890 or 92920

OPTIC LENS:

45812	Red	PC
45812-5	Red	PC RETAIL
45813	Yellow	PC
45813-5	Yellow	PC RETAIL
45182	Red	PC 24 VOLT
45183	Yellow	PC 24 VOLT

OPTIC LENS KITS:

45042	Red (45812 + 91400 + 67050)	PC
45043	Yellow (45813 + 91400 + 67050)	PC

REFLEX LENS:

45222	Red	24 VOLT
45223	Yellow	24 VOLT
45832	Red	
45833	Yellow	

BUILT-IN REFLECTOR KITS:

45072	Red (45832 + 91400 + 67050)	
45073	Yellow (45833 + 91400 + 67050)	

ABS LAMP:

78343	Yellow, Optic Lens	PC
-------	--------------------	----

Material: Lens - Acrylic; Housing - Polycarbonate
 FMVSS: Optic - P2, P3, PC, PC2; Reflex - A, P2, P3
 Finish: Red / Yellow

Bulb: 2 CP; Volts / Amps: 12V / .33A

Bulb: 3 CP; Volts / Amps: 24V / .17A

Bracket: 43690, 43160, 43162, 43163, 43512, 43522, 49140, 93750, 42180, 42170

Grommet: 91400, 91410, 92070, 91890, 91880, 92920

Pigtail: 66851, 67001, 66850, 66801, 67050, 66800, 66840

2 1/2" SURFACE MOUNT SINGLE-BULB CLEARANCE/MARKER LAMP

12,000+ hour bulb • Snap-on lens for easy bulb replacement • Heavy-duty 2 CP wedge-base bulb • OE replacement on Mack® MR models • Meets PC function only when mounted at a 45° angle



45412	Red	PC
45412-5	Red	PC RETAIL
45413	Yellow	PC
45413-5	Yellow	PC RETAIL

Material: Polypropylene / Acrylic

FMVSS: P2, PC

Finish: Red/Yellow

Bulb: #193, 2 CP

Volts / Amps: 12V / .33A

Lens: Red 90162, Yellow 90163

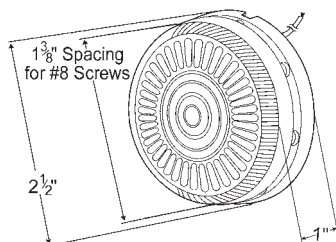

SUPERNOVA® 2 1/2" BEEHIVE LED CLEARANCE/MARKER LAMP

Encapsulant potting for total circuit-board protection • Tin-plated, solid-brass terminals are sealed to housing to resist corrosion and eliminate failure-causing leak paths • Uses same UBS double-seal pigtail as incandescent for a quick Plug-and-Go® retrofit • Hermetic lens-to-housing seal

47222 Red
47223 Yellow

Material: Polycarbonate
FMVSS: P2
Finish: Red / Yellow
Volts / Amps: 12V / .06A
Bracket: 43690, 43160, 43162, 43163, 43512, 43522, 49140, 93750, 42180, 42170
Grommet: 91400, 91410, 92070, 91890, 91880, 92920
Pigtail: 66851, 67001, 66850, 66801, 67050, 66800, 66840

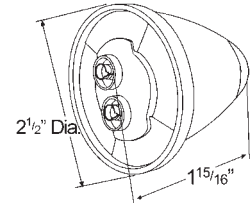

HI COUNT® 2 1/2" 13-DIODE BEEHIVE LED CLEARANCE/MARKER LAMP

Hermetic lens-to-housing seal • Twist-on mounting for easy installation
• Fits all popular mountings and grommets

G1082 Red
G1083 Yellow

Material: Polycarbonate
Reflective: P2
Finish: Red / Yellow
Volts / Amps: 12V / .09A
Bracket: 43690, 43160, 43162, 43163, 43512, 43522, 49140, 93750, 42180, 42170
Grommet: 91400, 91410, 92070, 91890, 91880, 92920
Pigtail: 66851, 67001, 66850, 66801, 67050, 66800, 66840

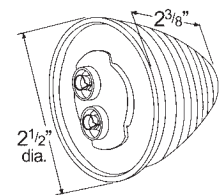

2 1/2" BEEHIVE CLEARANCE/MARKER LAMP

Hermetic lens-to-housing seal • Twist-on mounting for easy installation
• Fits all popular mountings and grommets • All PC versions meet requirements when mounted at 45° angle.

45322 Red **PC**
45323 Yellow **PC**

Material: Polycarbonate
Reflective: P2, PC
Finish: Red / Yellow
Bulb: 2 CP
Volts / Amps: 12V / .33A
Bracket: 43690, 43160, 43162, 43163, 43512, 43522, 49140, 93750, 42180, 42170
Grommet: 91400, 91410, 92070, 91890, 91880, 92920
Pigtail: 66851, 67001, 66850, 66801, 67050, 66800, 66840

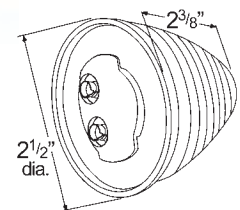

Clearance/Marker Lamps

Feux de Gabarit / Position Lámparas de Gálibo / Demarcadora

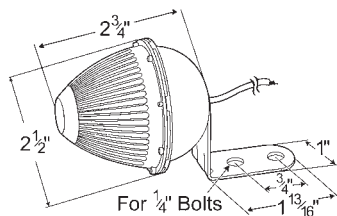

BEEHIVE CLEARANCE/MARKER LAMP WITH FIXED-ANGLE MOUNTING BRACKET

Wide light diffusion optic design • Fade-resistant, snap-on acrylic lens
• Bracket is permanently attached • Meets PC function only when mounted at a 45° angle

45022	Red	PC
45022-5	Red	PC RETAIL
45023	Yellow	PC
45023-5	Yellow	PC RETAIL

Material: ABS / Steel / Acrylic
FMVSS: P2, PC
Finish: Red / Yellow
Bulb: #67, 4 CP
Volts / Amps: 12V / .59A
Lens: Yellow 90303

LED

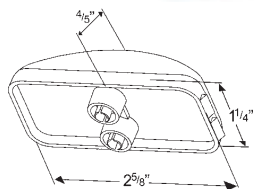

SUPERNOVA® LED CLEARANCE/MARKER LAMP

Encapsulant potting for total circuit board protection • Hermetic lens-to-housing seal • Tin-plated, solid-brass terminals are sealed to housing, to resist corrosion and eliminate failure causing leak paths • Uses the same UBS double-seal pigtail as incandescent for a quick Plug-and-Go® retrofit

47082	Red
47083	Yellow

Material: Polycarbonate
FMVSS: P2
Finish: Red / Yellow
Volts / Amps: 12V / .06A
Bracket: 43370, 43970, 43980, 42131, 42141, 94233, 43380
Grommet: 91380
Pigtail: 66851, 67001, 66850, 66801, 67050, 66800, 66840

LED

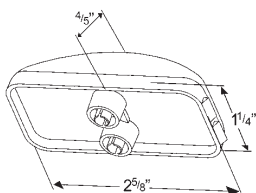

HI COUNT® 3-DIODE LED CLEARANCE/MARKER LAMP

Hermetic lens-to-housing seal • Uses the same UBS double-seal pigtail as the incandescent version for a quick Plug-and-Go® retrofit • Fits popular mountings and grommets

G1502	Red
G1503	Yellow

Material: Polycarbonate
FMVSS: P2
Finish: Red / Yellow
Volts / Amps: 12V / .06A
Bracket: 43370, 43970, 43980, 42131, 42141, 94233, 43380
Grommet: 91380
Pigtail: 66851, 67001, 66850, 66801, 67050, 66800, 66840

Clearance/Marker Lamps

Feux de Gabarit / Position Lámparas de Gálibo / Demarcadora

CLEARANCE/MARKER LAMP

Hermetic lens-to-housing seal • 12-Volt version features a 12,000+ hour bulb • Uses double-seal UBS pigtail • Rectangular shape fits narrow applications • Meets PC function only when mounted at a 45° angle, recommend bracket 43370 or 43380

45162	Red	PC 24 VOLT
45163	Yellow	PC 24 VOLT
46412	Red	PC
46412-5	Red, Pair Pack	PC RETAIL
46413	Yellow	PC
46413-5	Yellow, Pair Pack	PC RETAIL

KITS:		
46422-5	Red (43980 + 67050)	PC
46423-5	Yellow (43980 + 67050)	PC

Material: Polycarbonate
 FMVSS: P2, PC
 Finish: Red / Yellow
 Bulb: 2 CP; Volts / Amps: 12V / .33A; Bulb: 3 CP; Volts / Amps: 24V / .17A
 Bracket: 43370, 43970, 43980, 42131, 42141, 94233, 43380
 Grommet: 91380;
 Pigtail: 66851, 67001, 66850, 66801, 67050, 66800, 66840

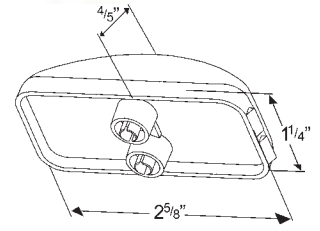

SUPERNOVA® LED CLEARANCE/MARKER LAMP

Encapsulant potting for total circuit board protection • Hermetic lens-to-housing seal • Advanced pin connection system • Uses same UBS pigtail as incandescent for a quick Plug-and-Go® retrofit • Meets PC function only when mounted at a 45° angle.

P2 RATED::	
47092	Red
47093	Yellow

KITS:	
65202	Red (47092 + 43850)
65203	Yellow (47093 + 43850)

PC RATED:	
47492	Red PC
47493	Yellow PC

Material: Polycarbonate
 FMVSS: P2, PC
 Finish: Red / Yellow
 Volts / Amps: P2 Rated - 12V / .06A; PC Rated - 12V / .12A
 Accessory: Lamp Guard: 43120
 Bracket: 43780, 43783, 43850
 Pigtail: 66982, 66980, 66981

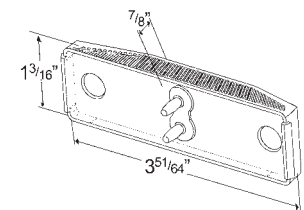

Clearance/Marker Lamps

Feux de Gabarit / Position Lámparas de Gálibo / Demarcadora

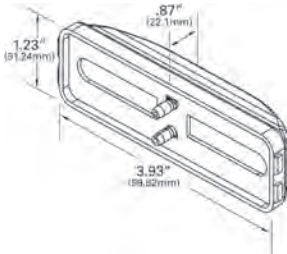

HI COUNT® 3-DIODE LED CLEARANCE/MARKER LAMP

Hermetic lens-to-housing seal • Uses the same UBS double-seal pigtail as the incandescent version for a quick Plug-and-Go® retrofit • Fits all popular mountings and grommets

G1902	Red	
G1902-5	Red	RETAIL
G1903	Yellow	
G1903-5	Yellow	RETAIL
G1913	Yellow, Clear Lens	

Material: Polycarbonate
 FMVSS: P2
 Finish: Red / Yellow
 Volts / Amps: 12V / .06A
 Accessory: Lamp Guard: 43120; Bracket: 43780, 43783, 43850
 Pigtail: 66982, 66980, 66981



46743



46740

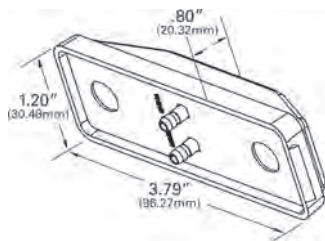

CLEARANCE/MARKER LAMP

Rectangular, double bulb lamp • 12-Volt version features a 12,000+ hour bulb • Narrow mounting applications • Hermetic lens-to-housing seal • Meets PC function only when mounted at a 45° angle

46742	Red	PC
46742-5	Red	PC RETAIL
46743	Yellow	PC
46743-5	Yellow	PC RETAIL
45142	Red	PC 24 VOLT
45143	Yellow	PC 24 VOLT

KITS:

45092	Red (46742 + 43850)	PC
45093	Yellow (46743 + 43850)	PC

ABS LAMP:

78393	Yellow	PC
--------------	--------	----

SPLIT LENS COLOR

46740	Red & Yellow
--------------	--------------

Material: Polycarbonate
 FMVSS: P2, P3, PC, PC2, (46740) - P2
 Finish: Red / Yellow
 Bulb: (2) 2 CP
 Volts / Amps: 12V / .66A
 Bulb: (2) 3 CP
 Volts / Amps: 24V / .34A
 Accessory: Lamp Guard: 43120
 Bracket: 43780, 43783, 43850
 Pigtail: 66980, 66982, 66981

Clearance/Marker Lamps

Feux de Gabarit / Position Lámparas de Gálibo / Demarcadora

2 1/2" OVAL LED CLEARANCE/MARKER LAMP

Surface mount design for easy installation • Sealed lamps provide better protection from moisture intrusion • Self-grounding eyelet grounds lamp when attached to metal plate (47012 and 47013)

45002-5	Red	RETAIL
45003-5	Yellow	RETAIL
45242-5	Red, Clear Lens	RETAIL
45243-5	Yellow, Clear Lens	RETAIL

SELF GROUNDING:

47012	Red
47013	Yellow

Material: Polycarbonate
 FMVSS: P2, P3
 Finish: Red/Yellow
 Volts / Amps: 12V / .05A

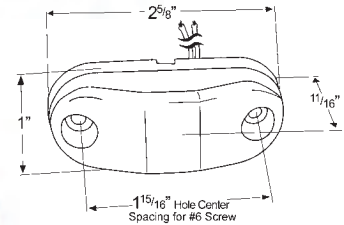

SUPERNOVA® LED CLEARANCE/MARKER LAMP WITH BUILT-IN REFLECTOR

Encapsulant potting for total circuit board protection • Hermetic lens-to-housing seal • Tin-plated, solid-brass terminals are sealed to housing, to resist corrosion and eliminate failure causing leak paths • Fits popular grommets and pigtailed

47502	Red
47503	Yellow

Material: Polycarbonate
 FMVSS: A, P2
 Finish: Red / Yellow
 Volts / Amps: 12V / .06A
 Grommet: 93400, 93402
 Pigtail: 66851, 67001, 66850, 66801, 67050, 66800, 66840

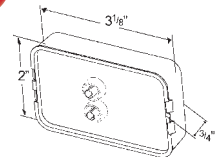

CLEARANCE/MARKER LAMP WITH BUILT-IN REFLECTOR

Fits popular grommets, pigtailed and harnesses
 • Hermetic lens-to-housing seal • 12,000+ hour bulb

45232	Red
45233	Yellow

Material: Polycarbonate
 FMVSS: A, P2
 Finish: Red / Yellow
 Bulb: 2 CP; Volts / Amps: 12V / .33A
 Grommet: 93400, 93402
 Pigtail: 66851, 67001, 66850, 66801, 67050, 66800, 66840



Clearance/Marker Lamps

Feux de Gabarit / Position Lámparas de Gálibo / Demarcadora

LED



47243



47462

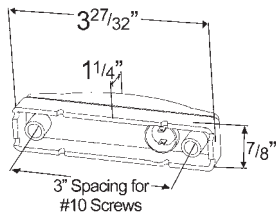

SUPERNOVA® 3" THIN-LINE LED CLEARANCE/MARKER LAMP

3" mounting center • Field-replaceable lens • Encapsulant potting for total circuit board protection • Anti-torque design protects against over tightening and lens cracking • Wire exit holes at ends allow for flow-through harnessing • All PC versions meet requirements when mounted at a 45° angle.

47242	Red	
47243	Yellow	
47362	Red	24 VOLT
47363	Yellow	24 VOLT

KITS:

65512	Red (47242 + 66930)
65513	Yellow (47243 + 66930)

PC RATED:

47462	Red	PC
47463	Yellow	PC

ABS LAMP:

78453	Yellow
-------	--------

Material: Polycarbonate
 FMVSS: P2, PC
 Finish: Red / Yellow
 Volts / Amps: 47242, 47243, 78453 - 12V / .06A
 Volts / Amps: 47462, 47463 - 12V / .12A
 Volts / Amps: Red - 24V / .03A; Yellow - 24V / .04A
 Bracket: 43230
 Pigtail: 66931, 66930, 66932

LED

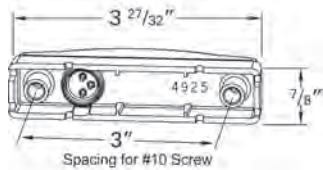

SUPERNOVA® 3" THIN-LINE DUAL INTENSITY LED CLEARANCE/MARKER LAMP

3" mounting center • Multi-function lamp enhances signaling visibility and safety • Compact size for narrow mounting locations • Lamp functions as a marker, clearance, identification and supplemental high mount stop or turn lamp. • Long-life lamp features replaceable lens and a circuit board encapsulated in potting to protect against vibration and water intrusion.

49252	Red
49253	Yellow

Material: Polycarbonate
 FMVSS: P2, PC
 Finish: Red / Yellow
 Volts / Amps: 14V / .02A / .06A
 Pigtail: 66870

Clearance/Marker Lamps

Feux de Gabarit / Position Lámparas de Gálibo / Demarcadora

SUPERNOVA® THIN-LINE LED CLEARANCE/MARKER LAMP

Sealed marker lamp • Encapsulant potting for total circuit board protection
 • Thin-Line design fits narrow rails and channels • Uses UBS double-seal pigtail for maximum protection against corrosion

46902	Red Lens, White Body
46903	Yellow Lens, White Body
46922	Red Lens, Red Body
46933	Yellow Lens, Yellow Body

KITS:

45132	Red Lens, White Body (46902 + 66930)
45133	Yellow Lens, White Body (46903 + 66930)
45102	Red Lens, Red Body (46922 + 66930)
45103	Yellow Lens, Yellow Body (46933 + 66930)

Material: Polycarbonate
 FMVSS: P2
 Finish: Red / Yellow / White
 Volts / Amps: 12V / .07A
 Bracket: 43074
 Pigtail: 66931, 66930, 66932

THIN-LINE SINGLE-BULB CLEARANCE/MARKER LAMP

Narrow rail and channel mounting • Snap-on lens for easy bulb replacement • Attached pigtail

45252	Red	
45252-5	Red	RETAIL
45253	Yellow	
45253-5	Yellow	RETAIL

WITH GROUND WIRE:

45672	Red
45673	Yellow

Material: Lens - Acrylic; Housing - Polycarbonate
 FMVSS: P2
 Finish: Red / Yellow
 Bulb: #193, 2 CP
 Volts / Amps: 12V / .33A
 Lens: Red 90152, Yellow 90153

TURTLEBACK® THIN-LINE SINGLE-BULB CLEARANCE/MARKER LAMP

Turtleback® lens design for maximum durability • Narrow rail and channel mounting • Attached pigtail

45382	Red
45383	Yellow

Material: Lens - Polycarbonate; Housing - Polypropylene
 FMVSS: P2, P3
 Finish: Red / Yellow
 Bulb: #193, 2 CP
 Volts / Amps: 12V / .33A

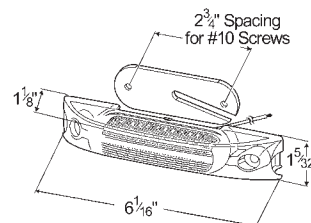
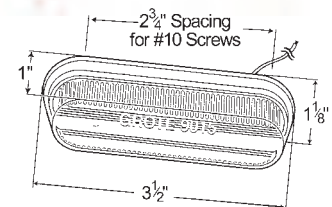
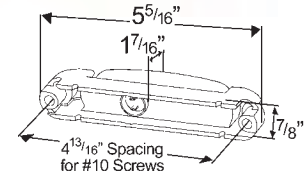

Clearance/Marker Lamps

Feux de Gabarit / Position Lámparas de Gálibo / Demarcadora

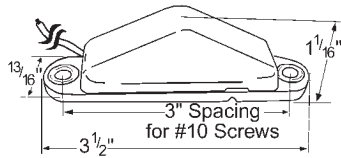

CLEARANCE/MARKER LAMP WITH PEAK LENS

Shock-resistant bulb mount • Snap-on lens for easy bulb replacement
All PC versions meet requirements when mounted at a 45° angle.

BLUNT CUT:

45512	Red	PC
45512-5	Red	PC RETAIL
45513	Yellow	PC
45513-5	Yellow	PC RETAIL

.180 MALE BULLET TERMINATION:

45522	Red	PC
45523	Yellow	PC

Material: Polycarbonate
FMVSS: P2, PC
Finish: Red / Yellow
Bulb: #194, 2 CP
Volts / Amps: 12V / .27A
Lens: Red 93252

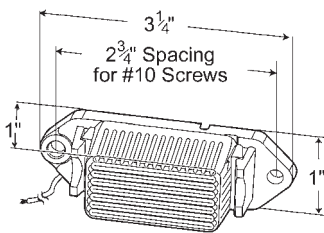

ECONOMY CLEARANCE/MARKER LAMP

Snap-on lens for easy bulb replacement • Brass, ground eyelet
• Compact design

46882	Red	
46882-5	Red	RETAIL
46883	Yellow	
46883-5	Yellow	RETAIL

Material: Lens - Polycarbonate; Housing - Polypropylene
FMVSS: P2
Finish: Red / Yellow
Bulb: #194, 2 CP
Volts / Amps: 12V / .27A
Lens: Red 92432, Yellow 92433

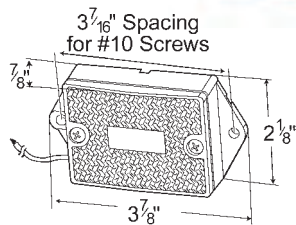

RECTANGULAR SINGLE-BULB CLEARANCE/MARKER LAMP WITH BUILT-IN REFLECTOR

Corrosion-resistant body • Flange mounting • Boat, snowmobile, trailer, and RV applications

46392	Red	
46392-5	Red	RETAIL
46393	Yellow	
46393-5	Yellow	RETAIL

Material: Lens - Acrylic; Housing - Polypropylene
FMVSS: A, P2, P3
Finish: Red/Yellow
Volts / Amps: 12V / .27A
Lens: Red 91112, Yellow 91113

RECTANGULAR SUBMERSIBLE CLEARANCE/MARKER LAMP WITH BUILT-IN REFLECTOR

Used with a large variety of boat, snowmobile and utility trailer lighting kits

REPLACEMENT PARTS:

- 46982-5** Red, Clearance/Marker RETAIL
- 46983-5** Yellow, Clearance/Marker RETAIL

Material: Lens - Acrylic; Housing - ABS
 FMVSS: P2, A
 Finish: Red / Yellow
 Volts / Amps: 12V / .27A
 Lens: Red: 91112, Yellow 91113

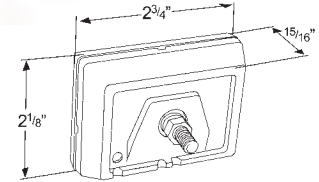

RECTANGULAR CLEARANCE/MARKER LAMP

Chrome-plated, Polycarbonate housing • 2" mounting centers
 • 1 1/8" socket hole required • Universal uses: interior, courtesy or trunk applications

- 47052** Red
- 47053** Yellow

AUXILIARY:

- 47051** Clear

Material: Lens - Acrylic; Housing - Polycarbonate
 FMVSS: P2
 Finish: Chrome/Red/Yellow
 Bulb: #1895, 2 CP
 Volts / Amps: 12V / .27A

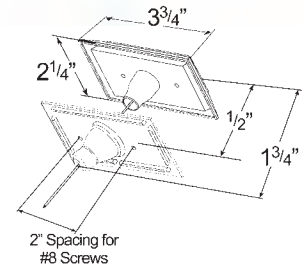

SINGLE-BULB OVAL CLEARANCE/MARKER LAMP

Snap-on lens • Corrosion-resistant contact and ground • Reflex version is a combined side marker, clearance lamp, and reflector

OPTIC LENS:

- 46702** Red
- 46703** Yellow
- 46703-5** Yellow RETAIL

BUILT-IN REFLECTOR:

- 46712** Red
- 46712-5** Red RETAIL
- 46713** Yellow
- 46713-5** Yellow RETAIL

Material: Lens - Acrylic; Housing - Polypropylene
 FMVSS: Optic - P2; Reflex - A, P2
 Finish: Red / Yellow
 Bulb: #193, 2 CP
 Volts / Amps: 12V / .33A
 Bracket: 43144, 43673
 Lens: Optic - Red 90122, Yellow 90123; Reflex - Red 90202, Yellow 90203

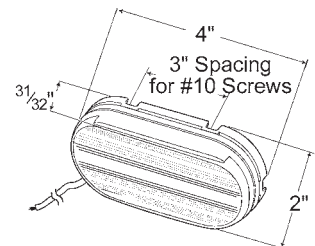

Clearance/Marker Lamps

Feux de Gabarit / Position Lámparas de Gálibo / Demarcadora

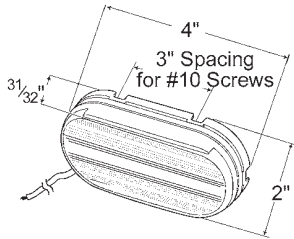

TWO-BULB OVAL PIGTAIL-TYPE CLEARANCE/MARKER LAMP

Standard snap-on lens for easy bulb replacement • Two stainless steel grounds • Exclusive internal armor for additional bulb protection • Corrosion-resistant contacts • Reflex version is a combined side marker, clearance lamp, and reflector • Optic lens version meets PC function only when mounted at a 45° angle

OPTIC LENS:

45262	Red	PC
45262-5	Red	PC RETAIL
45263	Yellow	PC
45263-5	Yellow	PC RETAIL

BUILT-IN CLASS "A" REFLECTOR:

45932	Red	
45932-5	Red	RETAIL
45933	Yellow	
45933-5	Yellow	RETAIL

Material: Lens - Acrylic; Housing - Polypropylene
 FMVSS: Optic - P2, PC; Reflex - A, P2
 Finish: Red / Yellow
 Bulb: (2) #1893, 2 CP
 Volts / Amps: 12V / .66A
 Bracket: 43144, 43673
 Pigtail: 67120
 Lens: Optic - Red 91572, Yellow 91573; Reflex - Red 90202, Yellow 90203

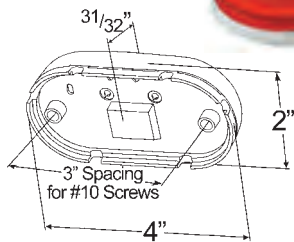

TWO-BULB NO-SPLICE CLEARANCE/MARKER LAMP

Exclusive, no-splice wiring system • Exclusive, internal armor for additional protection • Standard snap-on lens for easy bulb replacement • Meets PC function only when mounted at a 45° angle

45432	Red	PC
45433	Yellow	PC

Material: Lens - Acrylic; Housing - Polypropylene
 FMVSS: P2, P3, PC
 Finish: Red / Yellow
 Bulb: (2) #1893, 2 CP
 Volts / Amps: 12V / .66A
 Bracket: 43144, 43673
 Lens: Red 91572, Yellow 91573

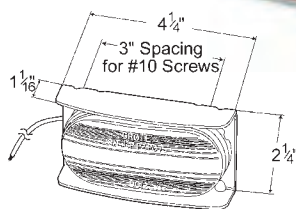

ECONOMY STEEL-ARMORED CLEARANCE/MARKER LAMP

Corrosion-proof, shock-absorbing lamp base • External guard of formed steel for additional lamp protection • Snap-on lens for easy bulb replacement • Flat back; no need for lamp socket hole • Meets PC function only when mounted at a 45° angle

46493-5	Yellow	RETAIL PC
---------	--------	-----------

Material: Lens - Acrylic; Housing - Polypropylene/Steel
 FMVSS: P2, PC
 Finish: Yellow
 Bulb: #193, 2 CP
 Volts / Amps: 12V / .33A
 Bracket: 43144
 Lens: Red 90122, Yellow 90123

FRUEHAUF SPECIAL CLEARANCE/MARKER LAMP

Fluted optics for wide light dispersion • Molded T-terminal wiring connection for easy replacements • Replaces Fruehauf® L-CE8750 and competitive versions • Meets PC function only when mounted at a 45° angle

46772	Red	PC
46773	Yellow	PC

Material: Lens - Acrylic; Housing - Polypropylene
 FMVSS: P2, PC
 Finish: Red / Yellow
 Bulb: (2) #1893, 2 CP
 Volts / Amps: 12V / .66A
 Bracket: 43144, 43673
 Pigtail: 67120
 Lens: Red 91992, Yellow 91993



HI COUNT® SQUARE-CORNER 13-DIODE LED CLEARANCE/MARKER LAMP

Molded snap-ring • Potted for total circuit board protection • Field-replaceable lens

G4602	Red	
G4602-5	Red	RETAIL
G4603	Yellow	
G4603-5	Yellow	RETAIL
G4613	Yellow, Clear Lens/Base	

Material: Lens - Acrylic; Housing - Polycarbonate
 FMVSS: P2
 Finish: Red / Yellow
 Volts / Amps: 12V / .15A
 Bracket: 43144, 43673
 Lens: Red 91962, Yellow 91963, Clear 91961

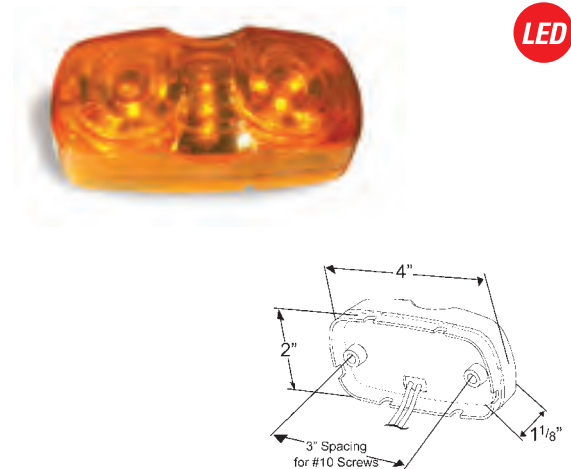

TWO-BULB SQUARE-CORNER CLEARANCE/MARKER LAMP

Corrosion-resistant contacts • Snap-on lens for easy bulb replacement • Attached blunt cut pigtail • Meets PC function only when mounted at a 45° angle

DURAMOLD		
46792	Red	PC
46792-5	Red	PC RETAIL
46793	Yellow	PC
46793-5	Yellow	PC RETAIL

DIE CAST		
46782	Red	PC
46783	Yellow	PC

Materials:
 Duramold - Lens: Polycarbonate; Housing - Polypropylene
 Die Cast - Lens: Acrylic; Housing - Steel
 FMVSS: P2, P3, PC
 Finish: Red / Yellow
 Bulb: (2) #1893, 2 CP; Volts / Amps: 12V / .66A
 Bracket: 43144, 43673
 Pigtail: 67120
 Lens: Red 91962, Yellow 91963, Auxiliary - Clear 91961, Green 91964, Blue 91965

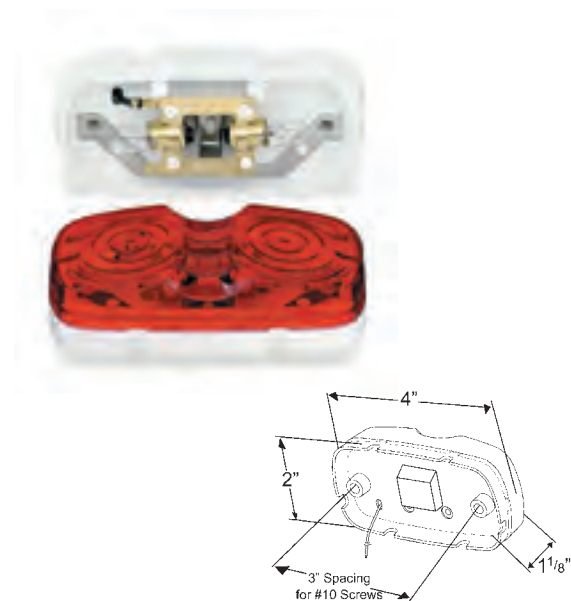

Clearance/Marker Lamps

Feux de Gabarit / Position Lámparas de Gálibo / Demarcadora

LED

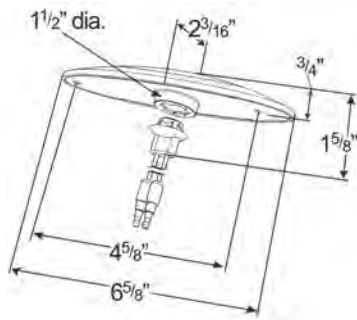
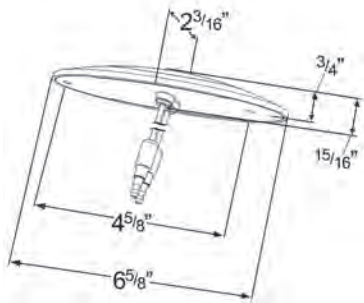

M1 SERIES LED CLEARANCE/ MARKER LAMP

Sleek, aerodynamic styling • Hermetic lens-to-housing seal • Corrosion-resistant, chrome-plated bezels • Molded bullet kits come with two replacement mating connectors • Potted for total circuit board protection

LAMP KITS WITH BEZEL:

45582	Red, .180 Molded Bullet	NEW
45583	Yellow, .180 Molded Bullet	
47772	Red, Clear Lens, .180 Molded Bullet	
47773	Yellow, Clear Lens, .180 Molded Bullet	
45603	Yellow, Metripack® Plug	

LAMP KITS WITHOUT BEZEL:

45623	Yellow, .180 Molded Bullet
45643	Yellow, Metripack® Plug

Material: Lens - Polycarbonate; Housing - Polycarbonate; Bezel - ABS
 FMVSS: P2
 Finish: Chrome / Red / Yellow
 Volts / Amps: 12V / .12A
 Accessory: Bezel Chrome 93453
 Pigtail: 66200

M1 SERIES CLEARANCE/ MARKER LAMP

Sleek, aerodynamic styling • Molded bullet versions are bulb replaceable • Corrosion-resistant, chrome-plated bezels • Metripack® versions have a hermetic lens-to-housing seal

LAMP KITS WITH BEZEL:

45572	Red, .180 Molded Bullet
45573	Yellow, .180 Molded Bullet
45593	Yellow, Metripack® Plug

LAMP KITS WITHOUT BEZEL:

45613	Yellow, .180 Molded Bullet
45633	Yellow, Metripack® Plug

Material: Lens and Housing - Polycarbonate; Bezel - Chrome plated ABS
 FMVSS: P2
 Finish: Chrome / Red / Yellow
 Bulb: #193, 2 CP Volts / Amps: 12V / .33A
 Bulb: #464, 3 CP Volts / Amps: 24V / .17A
 Accessory: Bezel Chrome 93453
 Pigtail: 66200

Clearance/Marker Lamps

Feux de Gabarit / Position Lámparas de Gálibo / Demarcadora

M3 SERIES LED CLEARANCE/ MARKER LAMP

Sleek, aerodynamic styling • Hermetic lens-to-housing seal
• Corrosion-resistant, chrome-plated bezels • Potted for total circuit board protection against vibration and corrosion • Kits contain two replacement mating connectors

LAMP KITS WITH BEZEL:

- 45772** Red, .180 Molded Bullet
- 45773** Yellow, .180 Molded Bullet

LAMP KITS WITHOUT BEZEL:

- 45792** Red, .180 Molded Bullet
- 45793** Yellow, .180 Molded Bullet

Material: Lens and Housing - Polycarbonate; Bezel - Chrome plated ABS
FMVSS: P2
Finish: Red / Yellow
Volts / Amps: 12V / .06A
Accessory: Bezel Chrome 93473
Pigtail: 66200

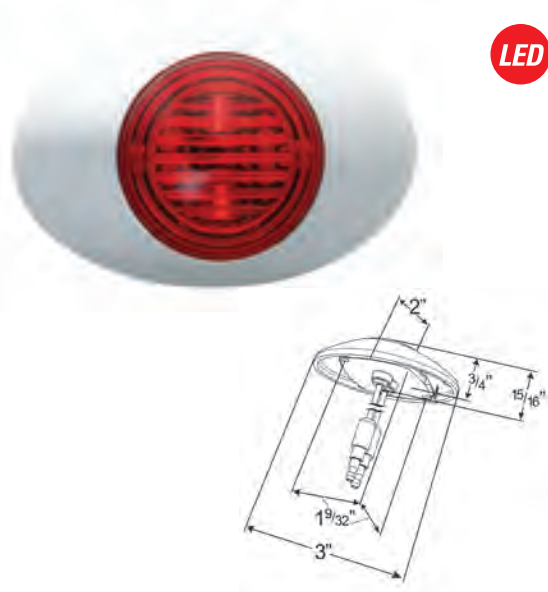

M3 SERIES CLEARANCE/ MARKER LAMP

Sleek, aerodynamic styling • Field replaceable, bulb design • Corrosion-resistant, chrome-plated bezels • No exposed fasteners

LAMP KITS WITH BEZEL:

- 45762** Red, .180 Molded Bullet
- 45763** Yellow, .180 Molded Bullet

LAMP KITS WITHOUT BEZEL:

- 45783** Yellow, .180 Molded Bullet

Material: Lens and Housing - Polycarbonate; Bezel - Chrome plated ABS
FMVSS: P2
Finish: Red / Yellow
Bulb: #193, 2 CP
Volts / Amps: 12V / .33A
Accessory: Bezel: Chrome 93473
Pigtail: 66200

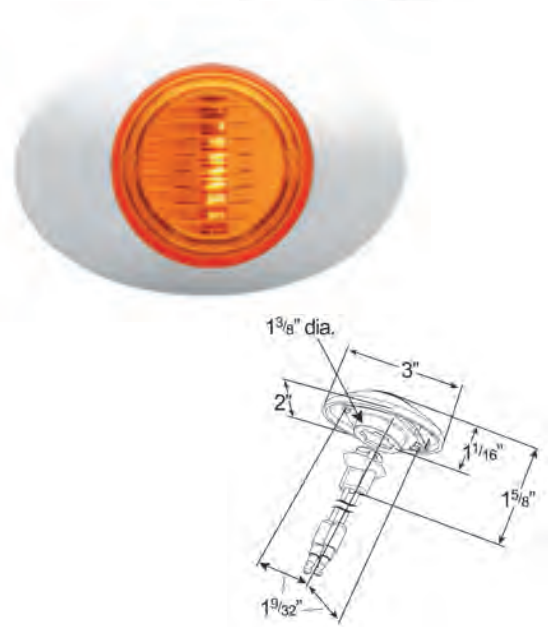

M4 SERIES LED CLEARANCE/ MARKER LAMP

Sleek, aerodynamic styling • Hermetic lens-to-housing seal
• Corrosion-resistant chrome-plated bezels • Kits contain two replacement mating connectors

LAMP KITS WITH BEZEL:

- 45853** Yellow, .180 Molded Bullet

Material: Lens and Housing - Polycarbonate; Bezel - Chrome plated ABS
FMVSS: P2
Finish: Yellow
Volts / Amps: 12V / .12A
Pigtail: 66200

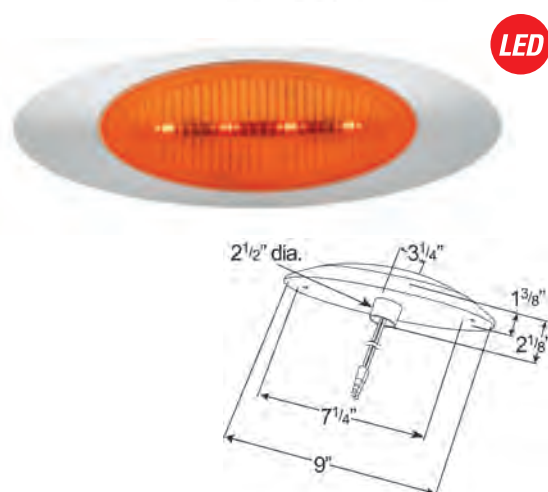

Clearance/Marker Lamps

Feux de Gabarit / Position Lámparas de Gálibo / Demarcadora



M5 SERIES LED CLEARANCE/ MARKER LAMP

Sleek, aerodynamic styling • Hermetic lens-to-housing seal • Corrosion-resistant chrome-plated bezels • Potted for total circuit board protection against vibration and corrosion • Kits contain two replacement mating connectors • Small size fits into narrow applications

LAMP KITS WITH BEZEL:

47912	Red, .180 Molded Bullet
47913	Yellow, .180 Molded Bullet
47922	Red, Clear Lens, .180 Molded Bullet
47923	Yellow, Clear Lens, .180 Molded Bullet

Material: Lens and Housing - Polycarbonate; Bezel - Chrome plated ABS
FMVSS: P2
Finish: Chrome / Clear / Red / Yellow
Pigtail: 66200

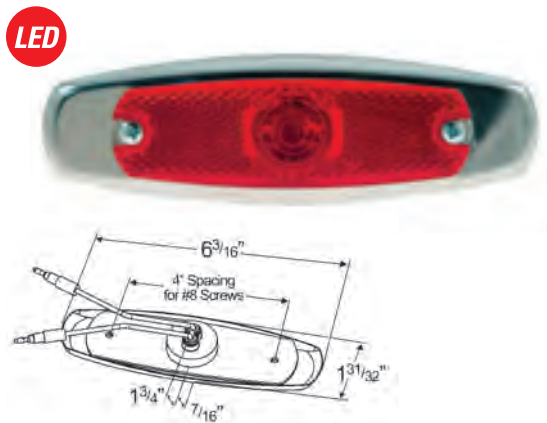

SUPERNOVA® LOW-PROFILE LED CLEARANCE/MARKER LAMP

Potted for total circuit board protection • Sealed hardwire terminations with .180 molded, UBS Slim-Line bullets • Field replaceable lens • Requires 1 1/4" hole for mounting • Popular marker lamp on Peterbilt® trucks • Built-in reflector

WITHOUT BEZEL:

47262	Red
47263	Yellow

WITH BEZEL:

47252	Red
47253	Yellow

Material: Lens - Acrylic; Housing - Polypropylene; Bezel - Stainless Steel
FMVSS: A, P2
Finish: Stainless Steel / Red / Yellow
Volts / Amps: 12V / .06A
Lens: Red 90072, Yellow 90073

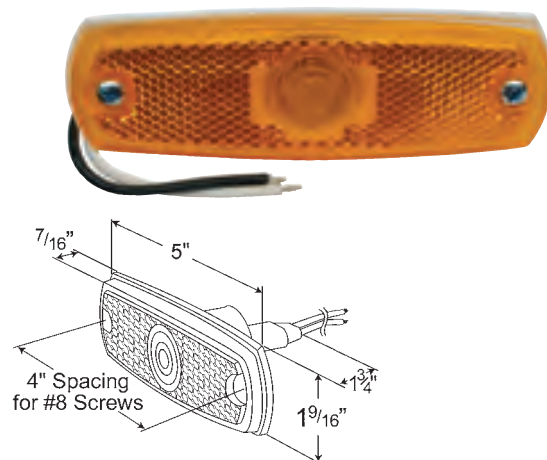

LOW-PROFILE CLEARANCE/ MARKER LAMP

Field-replaceable lens • Requires 1 1/4" socket hole for mounting • Twist-in bulb socket for easy bulb replacement • Built-in reflector

WITHOUT BEZEL:

45712	Red
45713	Yellow

WITH BEZEL:

45662	Red
45663	Yellow

Material: Lens - Acrylic; Housing - Polypropylene; Bezel - Stainless Steel
FMVSS: A, P2
Finish: Stainless Steel / Red / Yellow
Bulb: #194, 2 CP
Volts / Amps: 12V / .27A
Pigtail: 68380
Lens: Red 90072, Yellow 90073

SEALED RECTANGULAR LED CLEARANCE/MARKER LAMP

Potted for total circuit board protection against vibration and corrosion

- Hermetic lens-to-housing seal
- Fits standard mounting holes, no bracket required
- Uses same .180 molded bullet connections as incandescent versions for a quick, easy retrofit
- Replaces Truck-Lite® 18050R (red) or 18050Y (yellow)

- 47732 Red 
- 47733 Yellow 



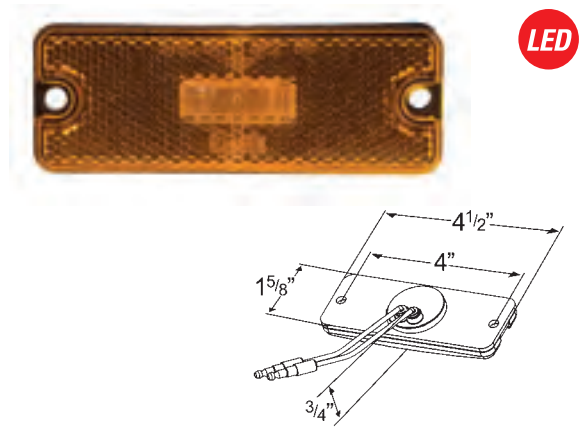





Material: Acrylic
 FMVSS: A, P2
 Finish: Red / Yellow
 Volts / Amps: 12V / .06A, 24V / .06A



SUPERNOVA® SEALED TURTLEBACK® II LED CLEARANCE/MARKER LAMP

Potted for total circuit board protection

- Hermetic lens-to-housing seal
- Tin-plated, solid-brass terminals are sealed to housing to resist corrosion and eliminate failure causing leak paths
- Meets PC function only when mounted at a 45° angle
- Not designed for vertical mount

BUILT-IN REFLECTOR:	
47072	Red, Male Pin
47073	Yellow, Male Pin
47352	Red, Male Pin 
47353	Yellow, Male Pin 
PC RATED OPTIC LENS:	
47162	Red, Male Pin 
47163	Yellow, Male Pin 
49392	Red, Hardwire 
49393	Yellow, Hardwire 
DUAL INTENSITY:	
54003	Yellow, Optic Lens, Male Pin 
ABS LAMP:	
78403	Yellow, Reflex Lens, Male Pin 

Material:
 Reflex - Lens: Acrylic; Housing - Polycarbonate
 Optic - Lens - Polycarbonate
 Duel - Housing - Polycarbonate

FMVSS: Optic - P2, PC; Reflex - A, P2
 Finish: Red / Yellow
 Volts / Amps: P2 - 12V / .06A
 Volts / Amps: PC - 12V / .12A
 Volts / Amps: Red - 24V / .03A
 Volts / Amps: Yellow - 24V / .04A
 Bracket: 43030, 43050
 Pigtail: 66911, 66910, 67070, 67071

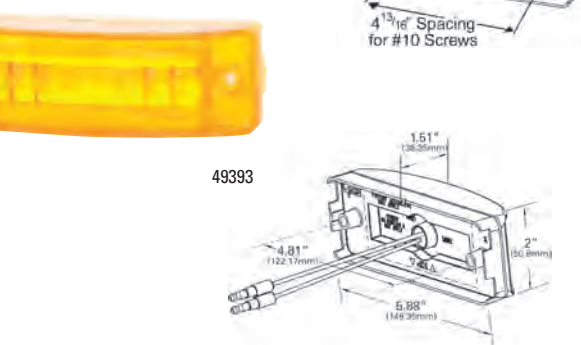
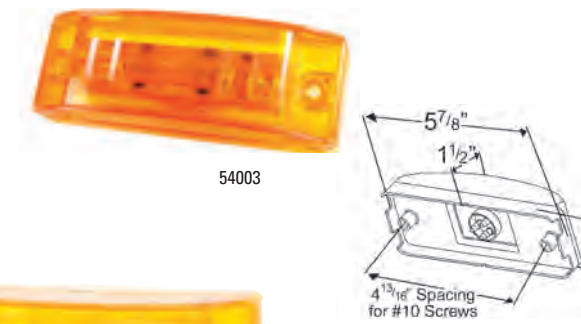
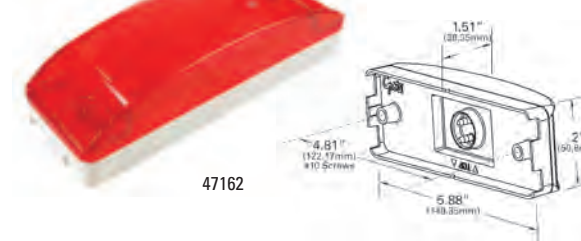
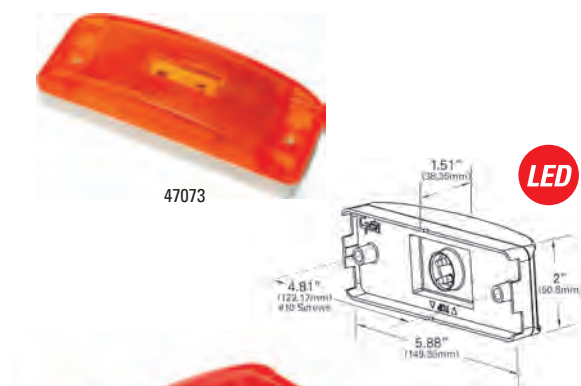

Clearance/Marker Lamps

Feux de Gabarit / Position Lámparas de Gálibo / Demarcadora

LED

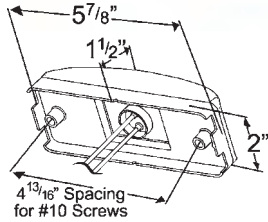

HI COUNT® TURTLEBACK® II LED CLEARANCE/MARKER LAMP

Hermetic lens-to-housing seal • Molded bullet with chassis ground-ring terminal connection • Shock absorbing, heat-resistant lens and lamp base • Red lamp has 8 diodes, yellow lamp has 10 diodes

- G2102 Red
- G2102-5 Red **RETAIL**
- G2103 Yellow
- G2103-5 Yellow **RETAIL**

Material: Lens: Acrylic; Housing - Polycarbonate
 FMVSS: A, P2
 Finish: Red / Yellow
 Volts / Amps: Red - 12V / .12A
 Volts / Amps: Yellow - 12V / .15A
 Bracket: 43030, 43050

LED

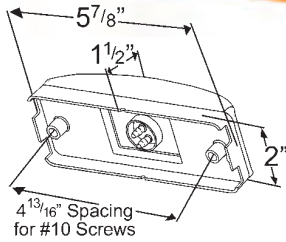

SUPERNOVA® SEALED TURTLEBACK® II LED DUAL INTENSITY CLEARANCE/MARKER LAMP

Potted for total circuit board protection • Hermetic lens-to-housing seal • Tin-plated, solid-brass terminals are sealed to housing, to resist corrosion and eliminate failure-causing leak paths • Meets PC function when mounted at a 45° angle • Not designed for vertical mount

- 54003 Yellow, Male Pin

Material: Polycarbonate
 FMVSS: P2, PC
 Color: Yellow
 Voltage Amp: 12V / .12A

SEALED TURTLEBACK® II CLEARANCE/MARKER LAMP

Shock-absorbing, heat-resistant lens and lamp base • Hermetic lens-to-housing seal • Waterproof male pin connections accept UBS pigtail • Turtleback® lens design for maximum durability • Two 12,000+ hour bulbs • Optic lens version meets PC function only when mounted at a 45° angle

OPTIC LENS:		
46832	Red	PC
46832-5	Red	PC RETAIL
46833	Yellow	PC
46833-5	Yellow	PC RETAIL

REFLEX LENS:		
46872	Red	
46872-5	Red	RETAIL
46873	Yellow	
46873-5	Yellow	RETAIL

ABS LAMP:		
78363	Yellow, Optic Lens	PC

Material:
 Reflex - Lens: Acrylic; Housing - Polycarbonate
 Optic - Lens and Housing - Polycarbonate
 FMVSS: Optic - P2, P3, PC; Reflex - A, P2
 Finish: Red / Yellow
 Bulb: (2) 2 CP
 Volts / Amps: 12V / .66A
 Bracket: 43030, 43050
 Pigtail: 66910, 66911, 67070, 67071

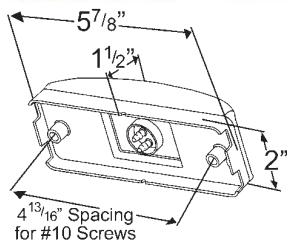

FIELD RESEALABLE LENS TURTLEBACK® II CLEARANCE/ MARKER LAMP

Weather-tight lens gasket seal • Resealable for bulb replacement
 • Impact-resistant bulb contacts • Turtleback® lens design for maximum durability
 • 12-Volt version features two 12,000+ hour bulbs • Optic lens version meets PC function only when mounted at a 45° angle

OPTIC LENS:

46802	Red	PC
46803	Yellow	PC

REFLEX LENS::

46862	Red
46863	Yellow

Material:

Optic Lens and Housing - Polycarbonate
 Reflex Lens: Acrylic; Housing - Polycarbonate

FMVSS: Optic - P2, P3, PC, PC2; Reflex - A, P2

Finish: Red / Yellow

Bulb: (2) #193, 2 CP; Volts / Amps: 12V / .66A

Bracket: 43030, 43050

Pigtail: 66911, 66910, 67070, 67071

Lens: Optic: Red 92162, Yellow 92163; Reflex: Red 92172, Yellow 92173

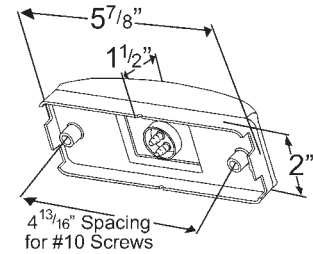

ECONOMY SEALED CLEARANCE/ MARKER LAMP

Hermetic lens to housing seal • 12,000 hour bulb • Self grounding eyelet grounds lamp when attached to a metal plate • Retrofits to competitor lamps easily with hot wire termination • Interchanges to Truck-Lite® 21201R (red) or 21201Y (yellow)

46072	Red
46073	Yellow

KITS:

46082	Red (46072 + 66360)
46083	Yellow (46073 + 66360)

Material: Acrylic

FMVSS: A, P2

Finish: Red / Yellow

Bulb: 2 CP; Volts / Amps: 12V / .33A

Pigtail: 66360

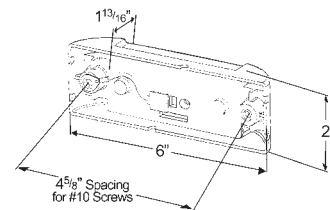
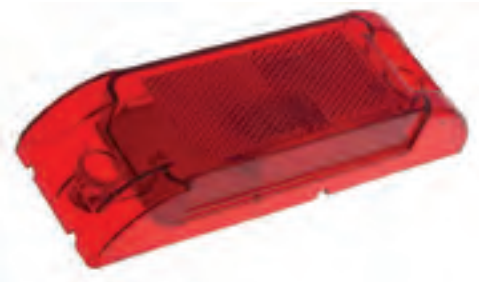

Clearance/Marker Lamps

Feux de Gabarit / Position Lámparas de Gálibo / Demarcadora

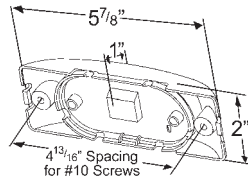

TWO-BULB TURTLEBACK® CLEARANCE/MARKER LAMP

Turtleback® lens design for maximum durability • Two stainless steel grounds

OPTIC LENS:

45462 Red
45463 Yellow

BUILT-IN REFLECTOR:

46302 Red
46303 Yellow

Material:

Optic Lens - Polycarbonate; Housing - Polypropylene
Reflex Lens: Acrylic; Housing - Polypropylene

FMVSS: Optic - P2; Reflex - A, P2

Finish: Red / Yellow

Bulb: (2) #1893, 2 CP Volts / Amps: 12V / .66A

Pigtail: 67120

Lens: Optic - Red 90172, Yellow 90173; Reflex - Red 91042, Yellow 91043

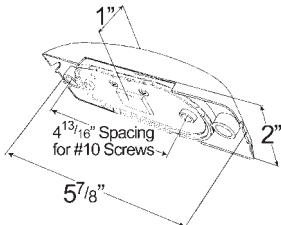

TWO-BULB TURTLEBACK® NO-SPLICE CLEARANCE/MARKER LAMP

Exclusive, no-splice wiring system • Turtleback® lens design for maximum durability • Corrosion-resistant contacts

45442 Red
45443 Yellow

Material: Lens - Polycarbonate; Housing - Polypropylene

FMVSS: P2

Finish: Red / Yellow

Bulb: (2) #1893, 2 CP

Volts / Amps: 12V / .66A

Lens: Red 90172, Yellow 90173

LED

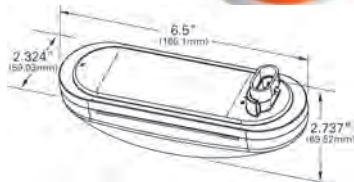

RAZORBACK™ MID-POSITION FLASHING LED MARKER LAMP

Patent pending electronic design meets all FMVSS 108 marker requirements and also flashes in concert with the turn signal circuitry to act as a mid-position flasher • 50 State Legal flashing mid-position marker • Easily visible from the cab during operation • Encapsulant potting for total circuit board protection • Fits current mounting flanges and grommets

54593 Yellow, Hardshell
54663 Yellow, Male Pin

Material: Polycarbonate

Finish: Yellow

FMVSS: P2

Voltage Amp: 13.5V / .18A

Brackets: 43220, 43222, 43223, 43732, 43362,

43952, 43172, 43100, 42152, 42153

Grommet: 92420, 92720, 67151

Pigtails: 66861

SMALL SQUARE PC-RATED CLEARANCE/MARKER LAMP

Direct replacement for Truck-Lite® 12200R • Standard lamps on UPS
 • Comes with gasket • Sonic sealed lens • Service life rated at 15,000 hours

46092 Red **PC**

Material: Polycarbonate
 FMVSS: P2, PC
 Finish: Red
 Bulb: 2 CP
 Volts / Amps: 12V / .33A



DIE-CAST, ALUMINUM CLEARANCE/MARKER LAMP

Mounts without disassembly • Holes interchange with competitive lamps for easy retrofits • Lens replaces comparable competitor models • Meets PC function only when mounted at a 45° angle

FLAT BACK, NO SOCKET HOLE REQUIRED:

46282 Red **PC**

46283 Yellow **PC**

REAR SOCKET:

46292 Red **PC**

46293 Yellow **PC**

Material: Lens - Acrylic; Housing - Aluminum
 FMVSS: P2, PC
 Finish: Red / Yellow
 Bulb: 46292, 46293: #67, 4 CP
 Volts / Amps: 12V / .59A
 Bulb: 46282, 46283 - #193, 2 CP
 Volts / Amps: 12V / .33A
 Lens: Red 90922, Yellow 90923

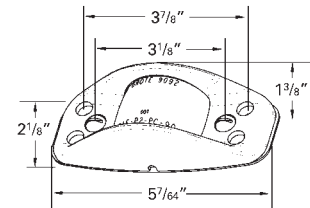

NARROW-RAIL CLEARANCE/MARKER LAMP

Seal-tight expanded rubber gasket • Steel housing for additional lamp protection • Two- or four-hole mounting for easy retrofits • Flat back; no need for lamp socket hole • Meets PC function only when mounted at a 45° angle

45172 Red **PC**

45173 Yellow **PC**

Material: Lens - Acrylic; Housing - Steel
 FMVSS: P2, P3, PC
 Finish: Red / Yellow
 Bulb: #193, 2 CP
 Volts / Amps: 12V / .33A
 Lens: Red 90052, Yellow 90053, Auxiliary - Clear 90051

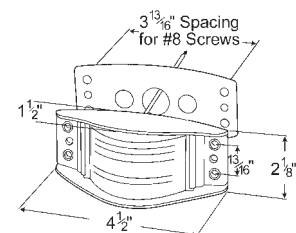

Clearance/Marker Lamps

Feux de Gabarit / Position Lámparas de Gálibo / Demarcadora

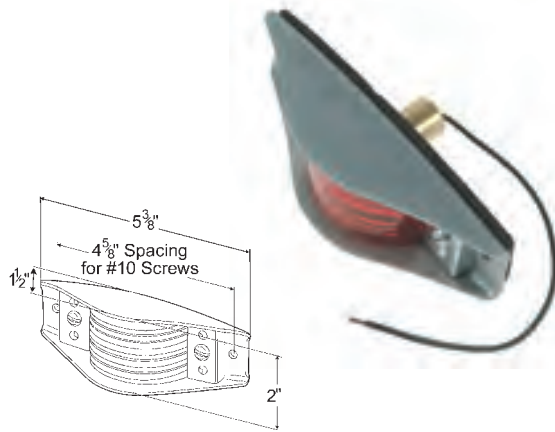

ARMORED CLEARANCE/MARKER LAMP

Seal-tight, expanded rubber gasket • Steel housing for additional lamp protection • Two- or four-hole mounting for easy retrofits • Rear socket hole required • Meets PC function only when mounted at a 45° angle

45012 Red **PC**
45013 Yellow **PC**

Material: Lens - Acrylic; Housing - Steel
 FMVSS: P2, P3, PC
 Finish: Red / Yellow
 Bulb: #67, 4 CP
 Volts / Amps: 12V / .59A
 Pigtail: 68080
 Lens: Red 90052, Yellow 90053; Auxiliary: Clear 90051

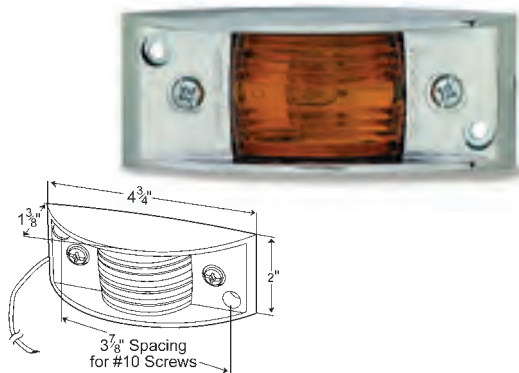

CHROME-ARMORED CLEARANCE/MARKER LAMP

Direct interchange for competitive models • Flat back; no bulb socket hole required • Meets PC function only when mounted at a 45° angle

46892 Red **PC**
46892-5 Red **PC RETAIL**
46893 Yellow **PC**
46893-5 Yellow **PC RETAIL**

Material: Lens - Acrylic; Housing - Chrome Plated ABS
 FMVSS: P2, PC
 Finish: Red / Yellow
 Bulb: #194, 2 CP
 Volts / Amps: 12V / .27A
 Lens: Red 90922, Yellow 90923



SUPERNOVA® LOW-PROFILE LED BAR LAMP

Twist-in, locking feature • Sealed UBS harness • Uses 2.5" round LED replacement lamps

49162 Red

Material: Lens - Polycarbonate; Housing - Steel
 FMVSS: P2
 Finish: Red
 Volts / Amps: 12V / .18A
 Accessory: Lamp: Red 47122; Harness: 67740
 Bracket: 49140

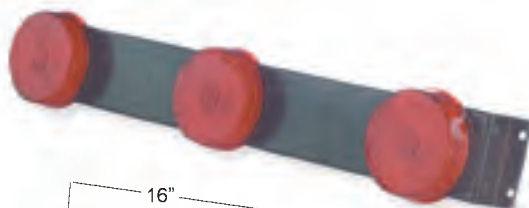

LOW-PROFILE BAR LAMP

Uses 2 1/2" round, replaceable lamps • Twist-in, locking feature • Sealed UBS harness

49142 Red

Material: Lens - Polycarbonate; Housing - Steel
 FMVSS: P2
 Finish: Red
 Bulb: (3) 2 CP
 Volts / Amps: 12V / .99A
 Accessory: Harness: 67740, Lamp: Red 45812
 Bracket: 49140

BEEHIVE TYPE BAR LAMP

Black enamel metal bar • Includes heat-sealed, splice-on pigtail

49002 Red

Material: Lens - Acrylic; Housing - ABS/Steel
 FMVSS: P2
 Finish: Red
 Bulb: (3) #67, 4 CP
 Volts / Amps: 12V / 1.77A

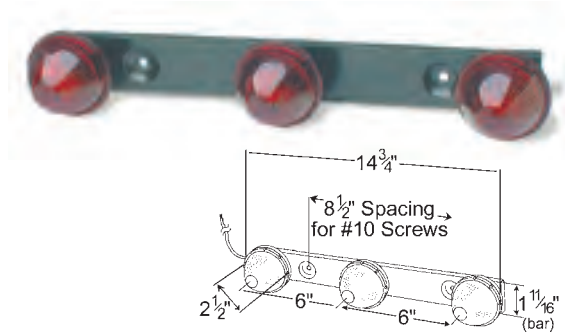

SUPERNOVA® LED BAR LAMP

Snap-on replacement lamps • Sealed flow-through UBS harness • Rugged reinforced polycarbonate bar • Easy to install

49182 Red

Material: Polycarbonate
 FMVSS: P2
 Finish: Red
 Volts / Amps: 12V / .18A
 Accessory: Lamp: Red 47082; Harness: 69710

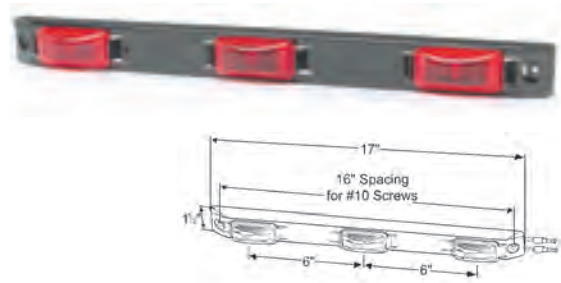

BAR LAMP

Three replaceable snap-on lamps • Sealed flow-through harness • Rugged reinforced polycarbonate bar • Easy to install

49172 Red

49173 Yellow

Material: Polycarbonate
 FMVSS: P2
 Finish: Red
 Bulb: (3) 2 CP
 Volts / Amps: 12V / .99A
 Accessory: Lamp: Red 46412, Yellow 46413; Harness: 69710



ALUMINUM BAR LAMP

Thin-line design fits narrow rails and channels • Three two-bulb replaceable snap-on lamps • Easy installation • UBS wire harness included

49132 Red

Material: Lens - Polycarbonate; Housing - Aluminum
 FMVSS: P2
 Finish: Red
 Bulb: (6) 2 CP
 Volts / Amps: 12V / 1.98A
 Accessory: Lamp: Red 46742

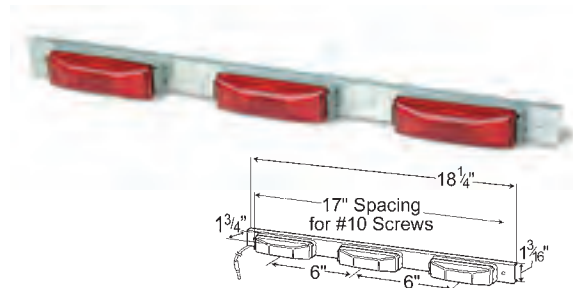

Clearance/Marker Lamps

Feux de Gabarit / Position Lámparas de Gálibo / Demarcadora

LED

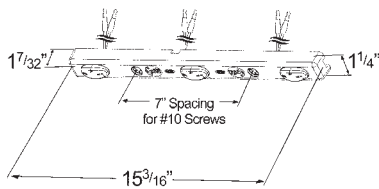

MICRONOVA® LED BAR LAMP

Replaceable sealed lamps • Low-profile design fits narrow rail applications
 • Encapsulant potting for total circuit board protection against vibration and corrosion • Sealed harness • Easy to install • Rugged reinforced polycarbonate bar

49202 Red

Material: Polycarbonate
 FMVSS: P2
 Finish: Red
 Volts / Amps: 12V / .16A
 Accessory: Lamps: Red 47962

LED

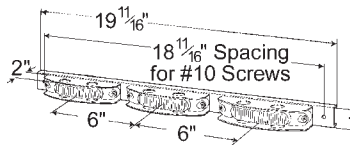

SUPERNOVA® THIN-LINE LED BAR LAMP

Thin-Line design fits narrow rails and channels • Easy installation
 • Sealed UBS harness included • Replaceable external guard made of formed aluminum

49122 Red

Material: Lens - Polycarbonate; Housing - Aluminum
 FMVSS: P2
 Finish: Red
 Volts / Amps: 12V / .18A
 Accessory: Lamp: Red 46902
 Branch Guard: 43074

LED

49243



49242-5

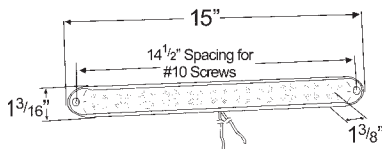

15\"/>

Rated to 100,000 hours of service life • Sealed marker lamps are shock and vibration-resistant • Impact-resistant housing is sealed for moisture protection • 3 LEDs

49192 Red
49223 Yellow
49242-5 Red **NEW**

Material: Polycarbonate
 FMVSS: P2, P3
 Finish: Red / Yellow
 Volts / Amps: 12V / .25A

THIN-LINE BAR LAMP

Three bulb-replaceable 45252 lamps • Black powder-coated, formed steel bar

49062 Red

Material: Lens - Acrylic; Housing - Polycarbonate; Bar - Formed Steel
 FMVSS: P2
 Finish: Red
 Bulb: (3) #193, 2 CP
 Volts / Amps: 12V / .99A
 Replacement Lens: Red 90152

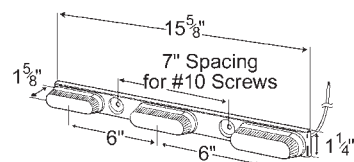

Clearance/Marker Lamps

Feux de Gabarit / Position Lámparas de Gálibo / Demarcadora

ECONOMY BAR LAMP

Three bulb-replaceable 46882 lamps • Formed steel bar with white enamel

49112 Red
49112-5 Red **RETAIL**

Material: Lens - Acrylic; Housing - Polycarbonate; Bar - Formed Steel
 FMVSS: P2
 Finish: Red
 Bulb: (3) #194, 2 CP
 Volts / Amps: 12V / .81A
 Lens: Red 92432

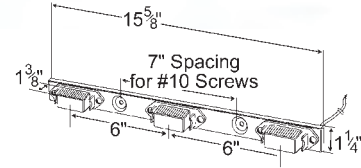

2 1/2" OVAL LED BAR LAMP

Impact resistant housing with sonic sealed, shock and vibration-resistant lamps • Uses three dual-diode LED lamps

49212-5 Red **RETAIL**

Material: Lens and Housing - Polycarbonate; Bar - ABS
 FMVSS: P2
 Finish: Red
 Volts / Amps: 12V / .15A
 Accessory: Lamp: Red 47012

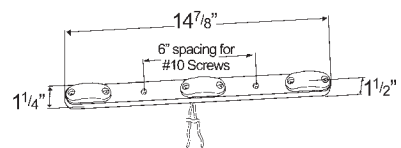

LOW-PROFILE BAR LAMP

Three-bulb, replaceable 45262 or 46792 lamps

OVAL STYLE:
49072 Red

SQUARE CORNER STYLE:
49082 Red

Material: Lens and Housing - Polycarbonate; Housing and Bar - Polypropylene
 FMVSS: P2
 Finish: Red / Yellow
 Bulb: (6) #1893, 2 CP
 Volts / Amps: 12V / 1.98A
 Lens: Oval - Red 90122, Yellow 90123; Square - Red 91962

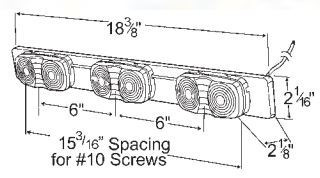

OEM-STYLE, LARGE AERODYNAMIC CAB MARKER LAMP

3/8" thick mounting gasket • Mounting holes interchange with most popular torpedo-type cab marker lamps • Chrome-plated body, long-life bulb • Used on Ford®, Navistar®, and Freightliner® trucks • Meets side marker and front clearance requirements simultaneously

46823 Yellow **PC**

Material: Lens - Polycarbonate; Housing - Chrome Plated ABS
 FMVSS: P2, P3, PC
 Finish: Chrome / Yellow
 Bulb: #904, 4 CP
 Volts / Amps: 12V / .69A
 Lens: Yellow 92193

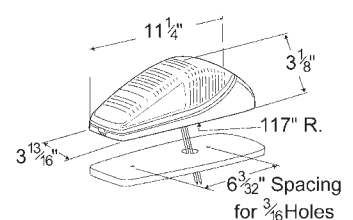

Clearance/Marker Lamps

Feux de Gabarit / Position Lámparas de Gálibo / Demarcadora

LED

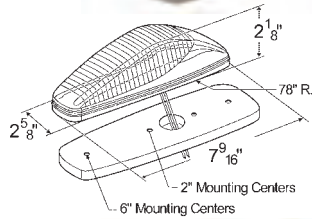

SUPERNOVA® SMALL AERODYNAMIC LED CAB MARKER LAMP

Replaceable lens • Same mounting and lens as incandescent (46813)
 • Encapsulant potting for total circuit board protection • Meets side marker and front clearance requirements simultaneously

47183 Yellow **PC**

Material: Lens - Polycarbonate; Housing - Valox
 FMVSS: P2, PC
 Finish: Yellow
 Volts / Amps: 12V / .12A
 Accessory: Chrome Bezel: 92583
 Lens: Yellow 92183

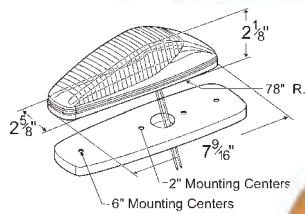

SMALL AERODYNAMIC CAB MARKER LAMP

Easy snap-on lens • Optics illuminate full lens • Used on Mack®, Navistar®, Freightliner®, Ford®, and Peterbilt® trucks • Meets sidemarker and front clearance requirements simultaneously

WITHOUT CHROME BEZEL:

46813 Yellow **PC**

WITH CHROME BEZEL:

46433 Yellow **PC**

Material: Lens - Polycarbonate; Housing - Valox
 FMVSS: P2, P3, PC
 Finish: Yellow
 Bulb: #168, 3 CP
 Volts / Amps: 12V / .35A
 Accessory: Chrome Bezel: 92583
 Lens: Yellow 92183

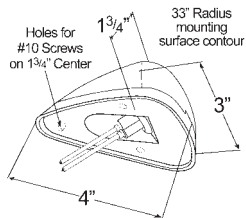

LOW-PROFILE AERODYNAMIC CAB MARKER LAMP

Aerodynamic design • Cab marker replacement for heavy-duty Ford® trucks • Field replaceable lens • Mounting screws included

46003 Yellow

Material: Lens and Housing - Polycarbonate
 FMVSS: P2, PC
 Finish: Yellow
 Bulb: #168, 3 CP
 Volts / Amps: 12V / .27A
 Lens: Yellow 93393

LED

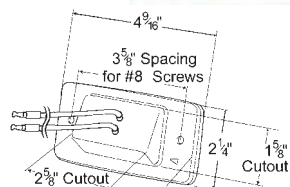

SUPERNOVA® FLUSH-MOUNT LED CAB MARKER LAMP

Hermetic lens-to-housing seal • Potted for total circuit board protection • Sealed hardwire connections with UBS molded .180 bullet terminals • Freightliner®, Sterling, and Navistar® replacement

47063 Yellow

Material: Lens and Housing - Polycarbonate
 FMVSS: P2
 Finish: Yellow
 Volts / Amps: 12V / .12A

FLUSH-MOUNT CAB MARKER LAMP

Application for visors • Hermetic lens-to-housing seal • Used on Freightliner®

46913 Yellow

Material: Polycarbonate
FMVSS: P2
Finish: Yellow
Pigtail: 68380

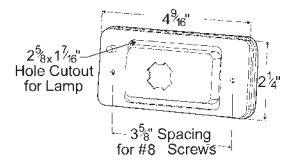

DELUXE DIE-CAST CAB MARKER LAMP

Easy installation • Neoprene mounting pad • Chrome-plated • Meets side marker and front clearance requirements simultaneously

45333 Yellow

Material: Lens - Acrylic; Housing - Chrome Plated Zinc Die-cast
FMVSS: P2, P3
Finish: Chrome / Yellow
Bulb: #67, 4 CP
Volts / Amps: 12V / .59A
Pigtail: 68080
Lens: Yellow 90133

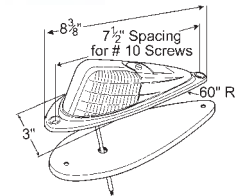

ECONOMY CAB MARKER LAMP

Fits flat or slight contour surfaces • Replaces original equipment on Ford® trucks
• Meets side marker and front clearance requirements simultaneously

46543 Yellow **PC**
46543-5 Yellow **PC RETAIL**

Material: Lens - Acrylic; Housing - ABS
FMVSS: P2, PC
Finish: Yellow
Bulb: #67, 4 CP
Volts / Amps: 12V / .59A
Pigtail: 68170
Lens: Yellow 91683

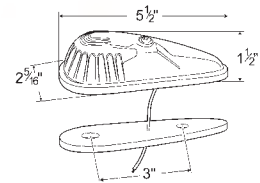
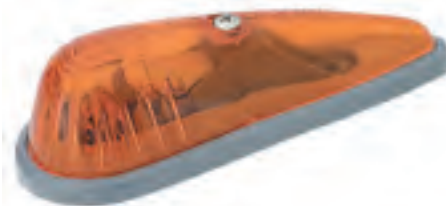

FORD® LIGHT DUTY CAB MARKER LAMP

Replaces surface mount, cab marker on Ford® F-Series trucks • Hermetic lens-to-housing seal • Replaceable bulb design • Mounting pad and screws included

45503 Yellow **PC**

Material: Lens - Polycarbonate; Housing - ABS
FMVSS: P2, PC
Finish: Yellow
Bulb: #194, 2 CP
Volts / Amps: 12V / .27A

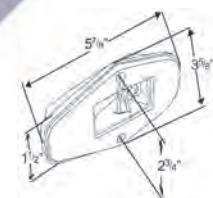

Clearance/Marker Lamps

Feux de Gabarit / Position Lámparas de Gálibo / Demarcadora

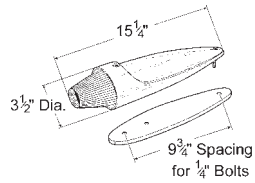

SHOCK-RESISTANT TORPEDO-STYLE CAB MARKER LAMP

Replacement for Mack® and Kenworth® • Includes two 1/4" bolts on 9 3/4" centers for mounting

45993 Yellow **PC**

Material: Lens - Acrylic; Housing - Chrome Plates ABS
 FMVSS: P2, PC
 Finish: Yellow
 Bulb: #67, 4 CP
 Volts / Amps: 12V / .59A
 Lens: Yellow 92773

LED

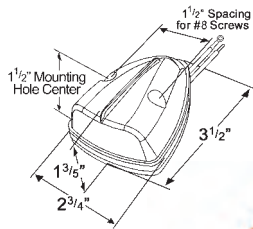

HI COUNT® SCHOOL BUS WEDGE LED MARKER LAMP

Hermetically sealed construction • Potted circuit board • Mounting gasket included • Blunt cut, hardwire termination • 15 Diodes in both red and yellow lamps • Meets PC when mounted at a 45° only

G5052 Red **PC**
G5053 Yellow **PC**
G5053-5 Yellow **PC RETAIL**

Material: Polycarbonate
 FMVSS: P2, PC
 Finish: Red / Yellow
 Volts / Amps: 12V / .1A

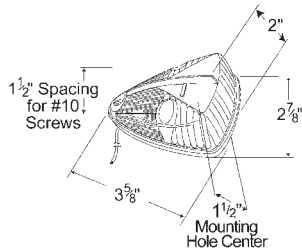

SCHOOL BUS WEDGE MARKER LAMP

Adaptable front/side/rear mount • Galvanized steel housing
 • Fits most school bus applications

46322 Red
46323 Yellow

Material: Lens - Acrylic; Housing - Galvanized Steel
 FMVSS: P2
 Finish: Red / Yellow
 Bulb: #168, 3 CP
 Volts / Amps: 12V / .35A
 Lens: Red 99912, Yellow 99913

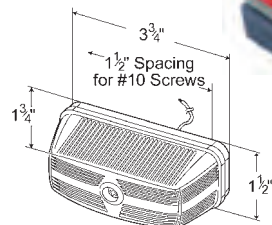

SCHOOL BUS RECTANGULAR MARKER LAMP

OEM-style • Fits most school bus applications • Includes mounting pad

46332 Red
46333 Yellow

Material: Lens - Acrylic; Housing - Zinc
 FMVSS: P2
 Bulb: #168, 3 CP
 Volts / Amps: 12V / .35A
 Lens: Red 99802, Yellow 99803