

## Introduction

This application note aims for users to understand the method of acceleration detection using piezoresistive type 3-axis acceleration sensor (HAAM-326B).

This application note explains using digital value which is converted from analog value of acceleration that piezoresistive type 3-axis acceleration sensor (HAAM-326B) outputs.

Reference: HAAM-326B catalog <http://www.hdk.co.jp/pdf/eng/e137507.pdf>

3-axis acceleration sensor application note (Calibration of sensors' individual difference)

Detection of throw-up, freefall means to detect throwing direction of 3-axis acceleration sensor, followed by detection of drop that the sensor freefalls. By using those detections, application which imitates those movements of 3-axis acceleration sensor can be made as the figure below.

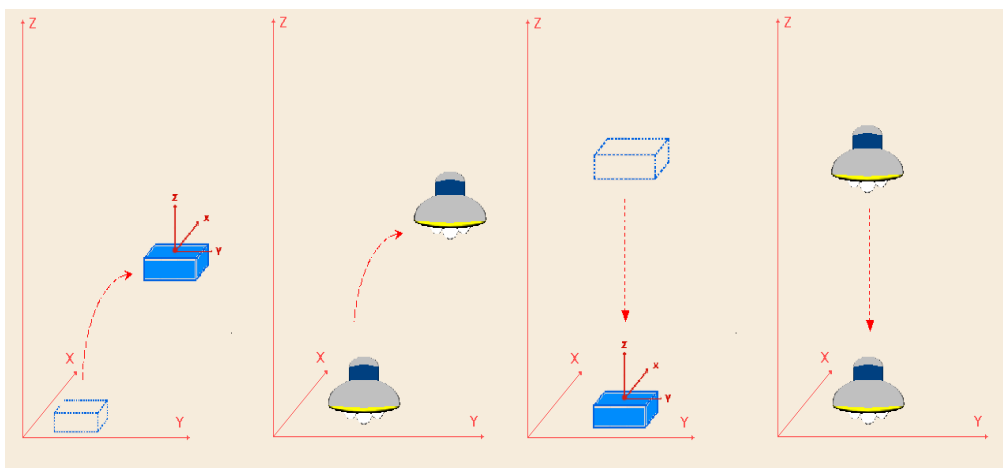


Figure 1 Application image using detection of throw-up and freefall

Piezoresistive type 3-axis acceleration sensor      HAAM-326B

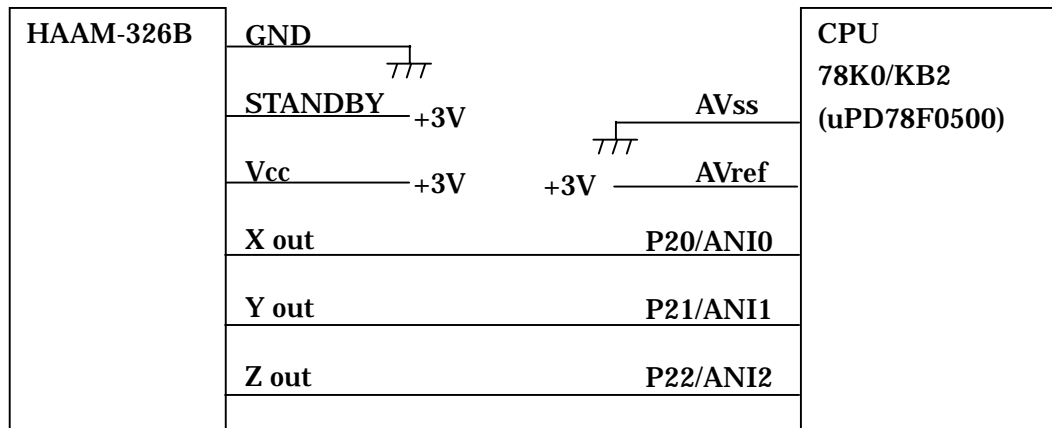
Throw-up, Freefall Detection.

Feb, 2007    1st edition

1 Composition

This application note explains using 78K0/KB2 (uPD78F0500) as an example CPU which connects to HAAM-326B.

Please refer to HAAM-326B catalog for electrical characteristics.



**Figure 2** Connection of HAAM-326B and CPU

■ Input voltage and conversion result

There is a relation between analog input voltage that put into the analog input terminal (ANI0-ANI2) and logical A/D conversion result (10-bit A/D conversion result register) as the figure below.

The 78K0/KB2 used in this application note shows the figure below.

G	Sensor (V)	CPU (Register Digital Value)	Correction 0 = 0G (Digital Value)
2G	2.3V	774	274
1G	1.9V	637	137
0G	1.5V	500	0
-1G	1.1V	363	-137
-2G	0.7V	226	-274

Figure 3 Input voltage and a conversion result

■ About the value which is as a result of conversion and is adopted

With this application note, the digital value at the time of 0G is considered by 0. Offset was added to the A/D conversion result. Figure 3 The value of 0 Correction0=0G (Digital value) is used by future explanation.

■ About a sampling rate

In this application note, XYZ is sampled every 4ms.

## 2 Algorithm of throw-up and freefall detection

In order to detect throw-up and freefall, the followings need to be judged.

1. State of sensor being stopped
2. Start of sensor move
3. Degree of throw-up
4. Existence of throw-up and freefall

### ■ Judgment of sensor being stopped

When sensor is being stopped, digital value does not show major change.

There is no major difference between digital value received lately (this time value) and digital value received last time (last time value).

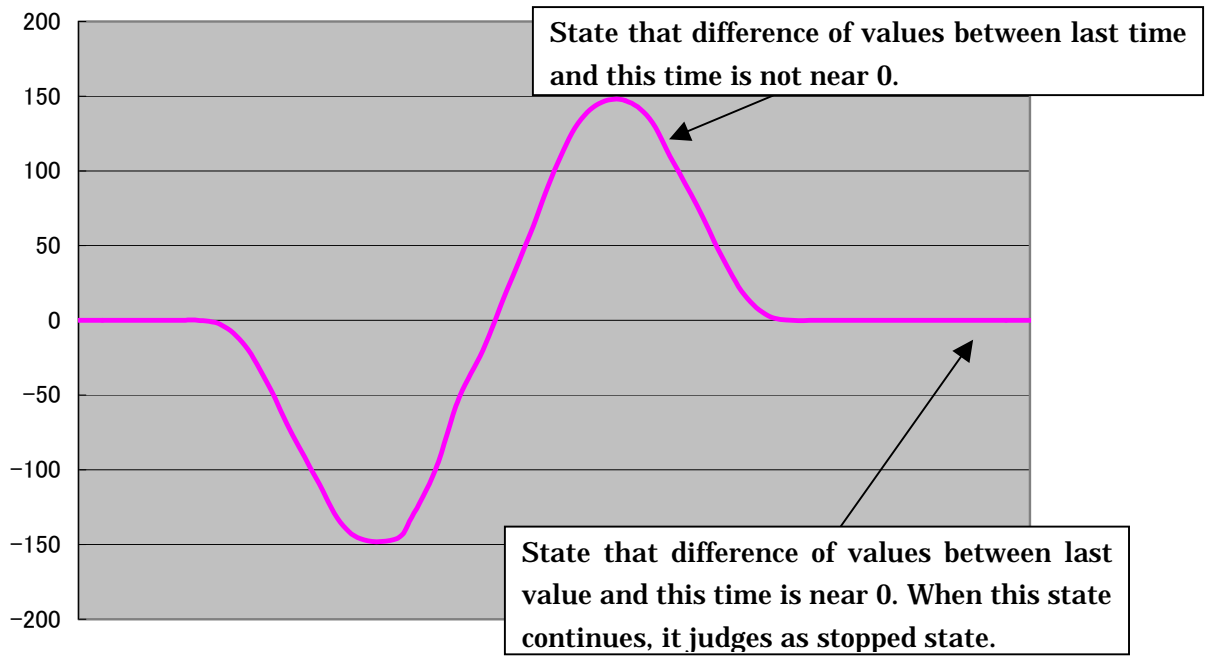
Therefore, when the state that the difference between last time value and this time value (absolute value) is near 0 continued for a moment, it is judged that the sensor is being stopped.

Moreover, the near-0 value which continued for a moment shall be an average of the digital value in stopped state of sensor.

#### • Condition of judgment for the stopped state

Condition 1: The difference of digital value (absolute value) between last time received and this time received becomes near 0. (20 or less recommended)

Condition 2: State of the condition 1 continues for a moment. (120msecs or more recommended)



**Figure 4 Judge a stopped state when moving a sensor rightward (Y-axis only)**

■ **Detection of sensor to start moving**

This judges whether sensor movement started from stopped state.

When sensor is being stopped, digital value does not have major change. That is, when sensor moved, digital value shows major change.

• **CONDITION OF JUDGMENT FOR MOVE START**

**Move condition 1:** When digital value changed significantly from the average of digital value at stopped state (30 or recommended), it is judged as move start.

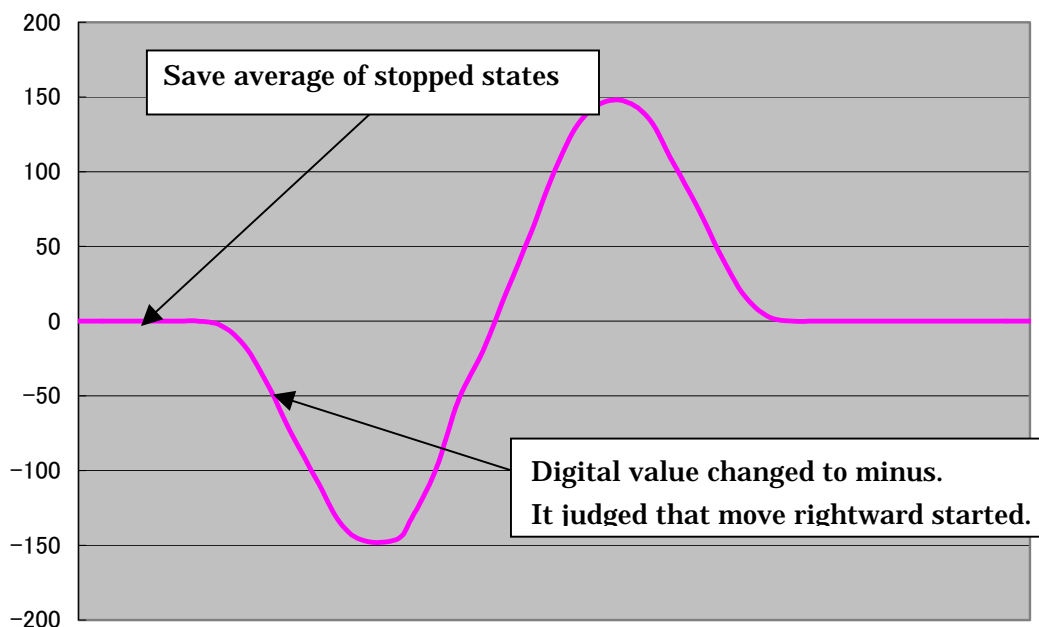
**Judgment of move direction**

When the digital value changed significantly and judged the sensor started movement, the move direction of sensor is judged by the digital value whether it changed to plus or minus.

The move direction by positive/negative in each axis is shown in the following figure.

	X	Y	Z
Positive (plus)	Rear (Near side)	Left	Below
Negative (minus)	Front (Back side)	Right	Above

**Figure 5 Table of direction judgment**



**Figure 6 Judge a stopped state when moving a sensor rightward (Y-axis only)**

- 
- Judgment of throw-up  
When judged as throw-up, detect first wave maximum when judged as move start, which is required to judge how much force sensor is thrown up with.

#### JUDGMENT OF WAVE RISE

The difference (last time comparison value) between received digital value and average calculated at stopped state is to be obtained.

Then, the difference (this time comparison value) between newly received digital value and average is to be obtained.

When move direction is plus,

$1 \times \text{this time comparison value} > 1 \times \text{last time comparison value}$

When move direction is minus,

$-1 \times \text{this time comparison value} > -1 \times \text{last time comparison value}$

When the above conditions become true, it judges that the wave is rising.

Change the “this time comparison value” into last time comparison value, and change the difference between newly-received digital comparison value and average to this time comparison value. This way, repeat comparison again.

- Condition of wave rise

First time wave rise condition 1:

When move direction are plus,

$1 \times \text{this time comparison value} > 1 \times \text{last time comparison value}$

When move direction is minus,

$-1 \times \text{this time comparison value} > -1 \times \text{last time comparison value}$

### JUDGMENT OF WAVE TURN-DOWN

In order to judge wave turn-down, it is thought that wave is beginning to turn down when first time wave rise condition 1 became false.

Since last time comparison value is considered as a basis when becoming false for the first time, keep the last time comparison value saved.

The following conditions become conditions for wave turn-down.

When move direction is plus,

(1)  $1 \times$  this time comparison value  $< 1 \times$  last time comparison value which was set as a basis.

When move direction is minus,

(2)  $-1 \times$  this time comparison value  $< -1 \times$  last time comparison value which was set as a basis.

So as not to judge slight wave turn-down (Fig.4) as "complete turn-down", (1) or (2) state continued for a while and digital value at that time changed significantly from last time comparison value, it can be judged that the wave turned down completely.

And, if it judges that it turned down completely, makes last time comparison value which made as a basis into first time wave maximum.

- Condition of wave turn-down judgment

First time turn-down condition 1:

From the state which wave was rising, the first time wave rise condition 1 becomes false. (Set the last time comparison value at this time as a basis)

The following conditions become true.

When move direction is plus,

(1)  $1 \times$  this time comparison value  $< 1 \times$  last time comparison value which was set as a basis.

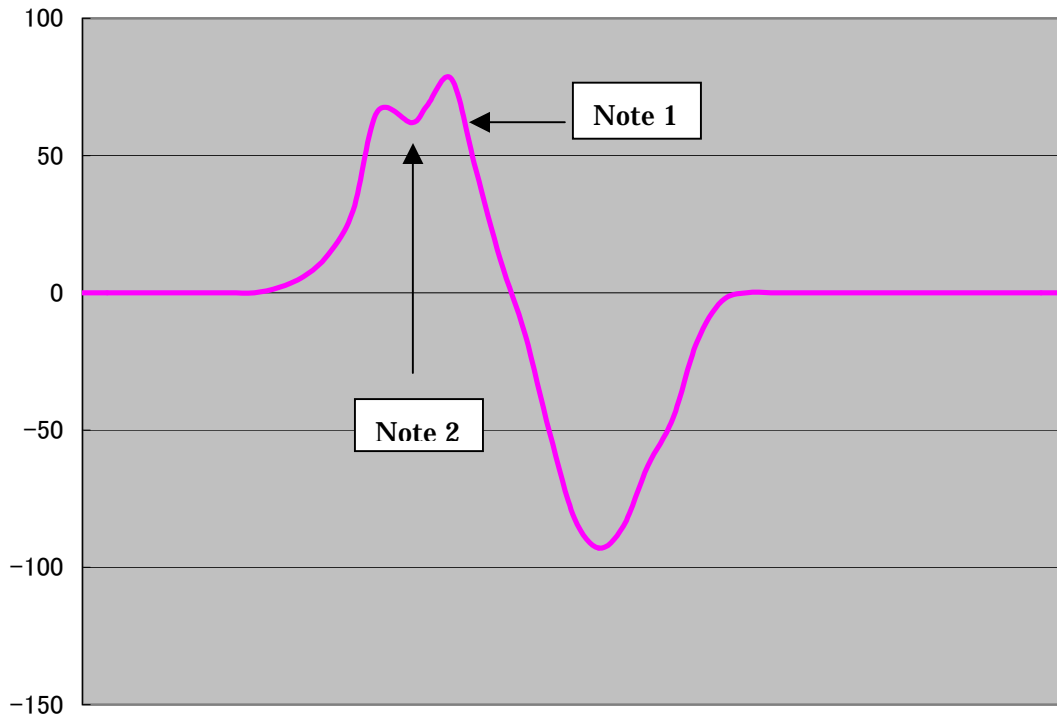
When move direction is minus,

(2)  $-1 \times$  this time comparison value  $< -1 \times$  last time comparison value which was set as a basis.

First time turn-down condition 2: The condition 1 continues for a while. (20msecs or more recommended).

First time turn-down condition 3: This time comparison value when clearing the condition 2 (absolute value) changed significantly from last time comparison value (5 or more recommended). Make the last time comparison value which set basis, into first time wave maximum .





**Figure 7 Detect turn-down (Y axis only)**

(Note 1) Since state of first time turn-down condition 2 (1) continues for a while, and difference between last time comparison value (basis) and this time comparison value appeared major difference, it is judged as a turn-down.

(Note 2) Even if state of first time turn-down conditions 2 (1) continues for a while, but difference between last time comparison value (basis) and this time comparison value did not appear major difference, it is not judged as a turn-down.

**MOVE END JUDGMENT**

**Move end judgment performs the same processing as sensor stop state.**

When sensor is being stopped, digital value does not show major change.

There is no major difference between digital value received lately (this time value) and digital value received last time (last time value).

Therefore, when the state that the difference between last time value and this time value (absolute value) is near 0 continued for a moment, it is judged that the sensor is being stopped.

Moreover, the near-0 value which continued for a moment shall be an average of the digital value in stopped state of sensor.

- **Condition of judgment for the stopped state**

Condition 1: The difference of digital value (absolute value) between last time received and this time received becomes near 0. (20 or less recommended)

Condition 2: State of the condition 1 continues for a moment. (120msecs or more recommended)

---

**■ Judgment of throw-up, free-fall****• Condition of throw-up judgment**

Throw-up condition 1: Since sensor becomes in zero-gravity after throwing up, 3-axis composite value becomes near 0 when judged as move end. (50 or less recommended)

Throw-up condition 2: Since throw-up premises that throwing sensor upward, same digital value as sensor moving upward appears.

That is, wave of Z-axis digital value when judged sensor started to move, changes to minus direction.

**• Condition of free-fall judgment**

Free-fall condition 1: Since gravity added to 3-axis becomes near 0G and weightless in free-fall state, 3-axis composite value when judged as move end, becomes value near 0. (50 or less recommended)

Free-fall condition 2: Since free-fall premises that holding sensor horizontally and letting it go as is, same digital value as sensor moving downward appears.

That is, wave of Z-axis digital value when judged sensor started to move, changes to plus direction.

(Note) 3-axis composite value -> This is x, y, and z axis compounded value. When intense operation is not added to sensor, sum total of 3-axis becomes 1G.

**How to calculate 3 axis composite value**

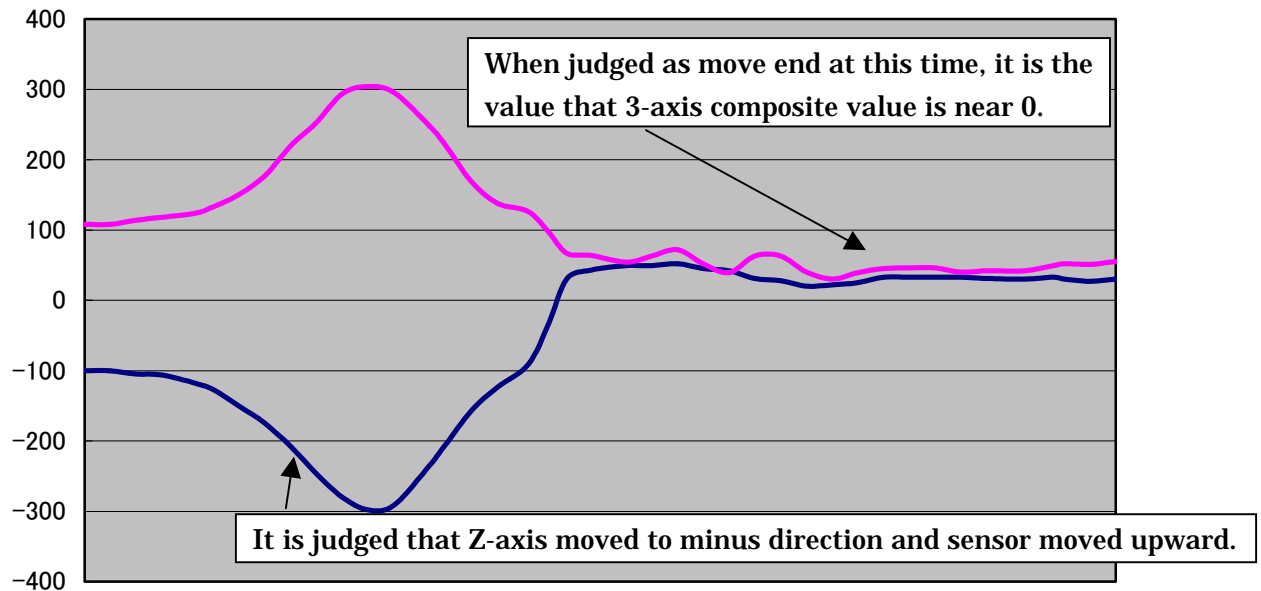
$x = X \text{ digital value} \times X \text{ digital value}$

$y = Y \text{ digital value} \times Y \text{ digital value}$

$z = Z \text{ digital value} \times Z \text{ digital value}$

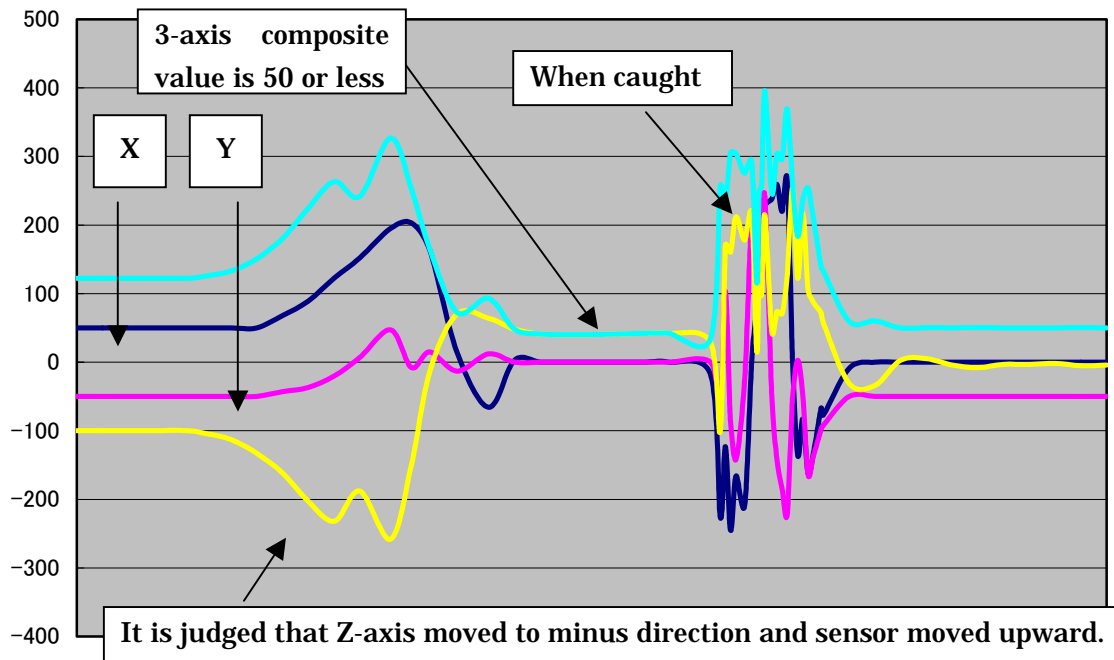
3-axis composite value =  $\text{Root}(x+y+z)$

When throwing sensor right above

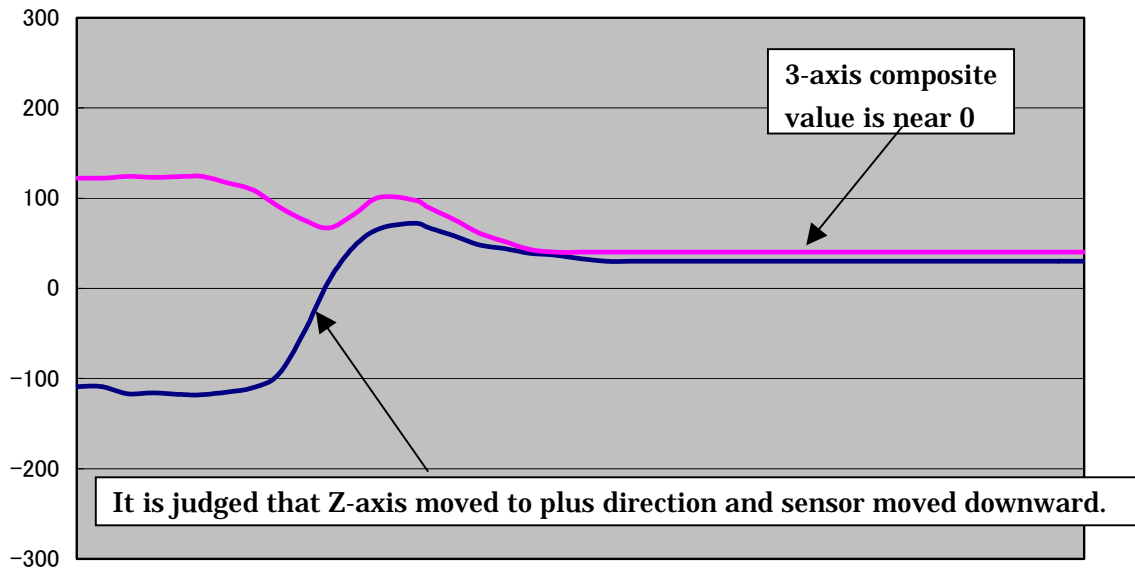


**Figure 8 Judge throw-up (Z-axis)**

- When throwing sensor some direction except right above



- When freefalling sensor



**Figure 9 Judge freefall (Z-axis)**