

Data Sheet

Customer: _____

Product: Wire Wound Chip Inductor – SCI Series _____

Size : 1008/1210/1812 _____

Issued Date: 26-Jul.-2016 _____

Edition: Ver. 3 _____

Record of change

Date	Ver.	Description	Page
30-Sep.-2014	1		
28-Aug-2015	2	Add new size 1008	4-5
26-Jul.-2016	3	Revised operating & storage temperature range	3

HITANO ENTERPRISE CORP.

7F-7, No. 3, Wu Chuan 1st Road, New Taipei Industrial Park,

New Taipei City, TAIWAN, R.O.C.

Tel: +886 2 2299 1331 (Rep.)

Fax: +886 2 2298 2466, 2298 2969

Prepared by	Checked by	Approved by	Accepted by (customer)
30-Sep.-2014	30-Sep.-2014	30-Sep.-2014	
<i>Andy Hsu</i>	<i>Hwa Wu</i>	<i>Hwa Wu</i>	

WIRE WOUND CHIP INDUCTOR

SCI SERIES

■ Introductions

The SCI series are chip inductors widely used in the communication applications and the other electronic devices, such as cellular phones, Television, Video Camera, Radio, Smart Meters and the other devices.

■ Features

- * Excellent solderability and resistance to soldering heat.
- * With metal terminals and resin coated, it offers many superior features, such as highly resistant to mechanical shocks and pressure, reliable in environments of sudden temperature change and humidity and super Q characteristics.
- * Highly accurate dimensions, high reliability, and easy surface mount assembly.
- * 0.01 to 1000 μ H, E-12 Series, wide lineup can be used for applications that need to meet strict tolerance such as filter circuits.

■ Chip Dimension

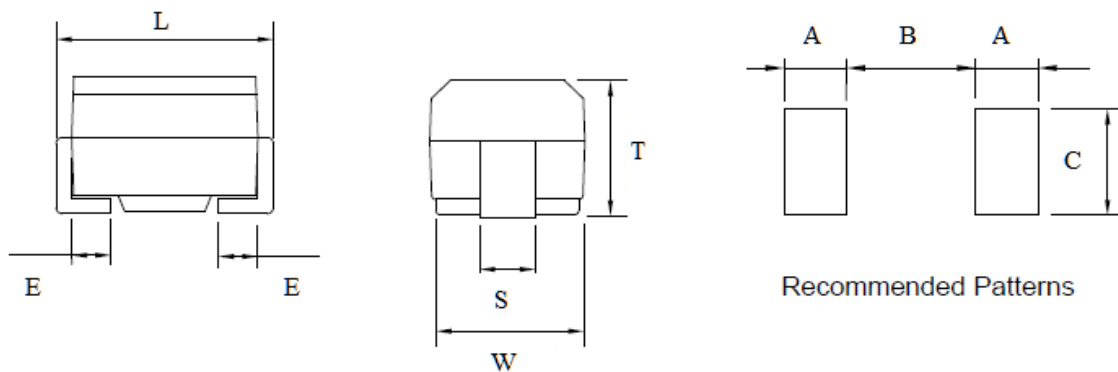

Size	L	W	T	S	E	A	B	C	Unit (mm)
SCI1008	2.50 \pm 0.20	2.00 \pm 0.0	2.20 \pm 0.20	1.80 \pm 0.10	0.40	1.0	1.5	1.0	
SCI1210	3.20 \pm 0.20	2.50 \pm 0.20	2.20 \pm 0.20	1.90 \pm 0.10	0.55	1.20	2.0	2.0	
SCI1812	4.50 \pm 0.30	3.20 \pm 0.30	3.20 \pm 0.30	1.90 \pm 0.10	1.10	1.50	3.0	3.0	

■ Part Numbering

SCI	1210	F	T	1R0	J	□□
SERIES	SIZE	MATERIAL	PACKAGE	INDUCTANCE	TOLERANCE	INTERNAL CODE
Wire Wound	1008	F =Ferrite	T= Tape&Reel	010= 0.01uH	J= \pm 5%	
Molded	1210			R10= 0.1uH	K= \pm 10%	
	1812			1R0= 1.0uH	M= \pm 20%	
				330= 33uH		
				331= 330 uH		
				102= 1000uH		

■ **Construction & Dimension**

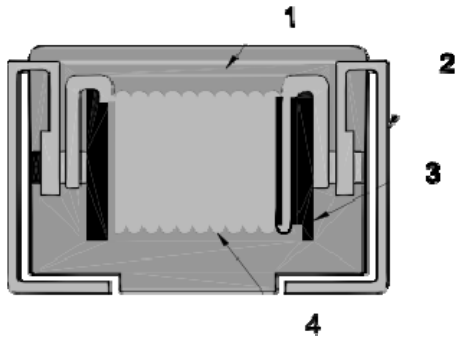

1	Molded resin	3	Ferrite Core
2	Electrode(Ag)	4	Magnet Wire

■ **Operating Temperature Range:**

Operating Temperature Range is the scope of ambient temperature at which the inductors can be operated continuously at rated current includes self-temperature rise.

- * SCI1008 Type: -40 to +105°C
- * SCI1210 Type: -40 to +105°C
- * SCI1812 Type: -40 to +85°C

■ **Storage Temperature Range:**

Storage Temperature Range is the scope of ambient temperature at which the inductors are mounted on the circuit board already.

- * SCI1008 Type: -40 to +85°C
- * SCI1210 Type: -40 to +85°C
- * SCI1812 Type: -40 to +85°C

■ **Characteristics:**

Standard Test Condition:

Unless otherwise specified, the standard range of atmospheric conditions for making measurements and tests are as follows:

- * Ambient Temperature: 25°C ± 2°C
- * Relative Humidity : 60% to 70%
- * AirPressure : 86 Kpa to 106 Kpa

WIRE WOUND CHIP INDUCTOR

SCI SERIES

■ Electrical Specification

Size 1008 Type

Part No.	Inductance	Q	Test Freq.	Tol.	S.R.F.(min)	RDC(max)	IDC(max)
	(μ H)	(min)	(MHz)	(%)	(MHz)	(Ω)	(mA)
SCI 1008 FT 010 □-□□	0.01	15	100	J	2150	0.26	530
SCI 1008 FT 012 □-□□	0.012	15	100	J	2050	0.27	500
SCI 1008 FT 015 □-□□	0.015	15	100	J	2000	0.29	480
SCI 1008 FT 018 □-□□	0.018	15	100	J	1850	0.31	450
SCI 1008 FT 022 □-□□	0.022	15	100	J	1650	0.37	420
SCI 1008 FT 027 □-□□	0.027	15	100	J	1550	0.40	410
SCI 1008 FT 033 □-□□	0.033	20	100	J	1450	0.42	400
SCI 1008 FT 039 □-□□	0.039	20	100	J	1350	0.45	380
SCI 1008 FT 047 □-□□	0.047	20	100	J	1200	0.50	360
SCI 1008 FT 056 □-□□	0.056	20	100	J	1100	0.60	340
SCI 1008 FT 068 □-□□	0.068	20	100	J	1050	0.65	320
SCI 1008 FT 082 □-□□	0.082	20	100	J	900	0.75	300
SCI 1008 FT R10 □-□□	0.1	20	100	J	800	0.80	280
SCI 1008 FT R12 □-□□	0.12	30	25.2	J	700	0.30	550
SCI 1008 FT R15 □-□□	0.15	30	25.2	J	550	0.35	500
SCI 1008 FT R18 □-□□	0.18	30	25.2	J	500	0.40	460
SCI 1008 FT R22 □-□□	0.22	30	25.2	J	450	0.50	430
SCI 1008 FT R27 □-□□	0.27	30	25.2	J	425	0.55	420
SCI 1008 FT R33 □-□□	0.33	30	25.2	J	400	0.60	400
SCI 1008 FT R39 □-□□	0.39	30	25.2	J	375	0.65	375
SCI 1008 FT R47 □-□□	0.47	30	25.2	J	350	0.68	350
SCI 1008 FT R56 □-□□	0.56	30	25.2	J	325	0.75	325
SCI 1008 FT R68 □-□□	0.68	30	25.2	J	300	0.85	300
SCI 1008 FT R82 □-□□	0.82	30	25.2	J	260	1.00	260
SCI 1008 FT 1R0 □-□□	1	30	7.96	J	245	1.10	245
SCI 1008 FT 1R2 □-□□	1.2	30	7.96	J	230	1.20	230
SCI 1008 FT 1R5 □-□□	1.5	30	7.96	J	182	1.30	220
SCI 1008 FT 1R8 □-□□	1.8	30	7.96	J	135	1.45	210
SCI 1008 FT 2R2 □-□□	2.2	30	7.96	J	105	1.55	200
SCI 1008 FT 2R7 □-□□	2.7	30	7.96	J	70	1.75	195
SCI 1008 FT 3R3 □-□□	3.3	30	7.96	J	55	1.90	185
SCI 1008 FT 3R9 □-□□	3.9	30	7.96	J	48	2.10	180
SCI 1008 FT 4R7 □-□□	4.7	30	7.96	J	43	2.30	175
SCI 1008 FT 5R6 □-□□	5.6	25	7.96	J	42	2.50	170
SCI 1008 FT 6R8 □-□□	6.8	25	7.96	J	39	2.70	165
SCI 1008 FT 8R2 □-□□	8.2	25	7.96	J	36	3.05	160
SCI 1008 FT 100 □-□□	10	25	2.52	J	33	3.50	155
SCI 1008 FT 120 □-□□	12	25	2.52	J	30	3.80	150
SCI 1008 FT 150 □-□□	15	25	2.52	J	26	4.40	140
SCI 1008 FT 180 □-□□	18	25	2.52	J	24	4.80	130

WIRE WOUND CHIP INDUCTOR

SCI SERIES

Size 1008 Type

Part No.	Inductance	Q	Test Freq.	Tol.	S.R.F.(min)	RDC(max)	IDC(max)
	(μ H)	(min)	(MHz)	(%)	(MHz)	(Ω)	(mA)
SCI 1008 FT 220 □-□□	22	25	2.52	J	22	5.5	125
SCI 1008 FT 270 □-□□	27	25	2.52	J	21	6.3	115
SCI 1008 FT 330 □-□□	33	25	2.52	J	20	7.1	110
SCI 1008 FT 390 □-□□	39	20	2.52	J	18	9.5	90
SCI 1008 FT 470 □-□□	47	20	2.52	J	17	11.1	80
SCI 1008 FT 560 □-□□	56	20	2.52	J	16	12.1	75
SCI 1008 FT 680 □-□□	68	20	2.52	J	15	16.6	70
SCI 1008 FT 820 □-□□	82	20	2.52	J	13	19	66
SCI 1008 FT 101 □-□□	100	15	0.796	J	12	21	60

- * Tolerance: J=±5%
- * Operating Temperature: -40°C to +105°C
- * Inductance & Q value measured in HP4191A
- * SRF measured in 8753 Agilent
- * DC Resistance RDC measured in VP-2941A Panasonic
- * Unspecified values available on request.

WIRE WOUND CHIP INDUCTOR

SCI SERIES

Size 1210 Type

Part No.	Inductance	Q	Test Freq.	Tol.	S.R.F.(min)	RDC(max)	IDC(max)
	(μ H)	(min)	(MHz)	(%)	(MHz)	(Ω)	(mA)
SCI 1210 FT 010 □-□□	0.01	15	100	J	2500	0.13	450
SCI 1210 FT 012 □-□□	0.012	17	100	J	2300	0.14	450
SCI 1210 FT 015 □-□□	0.015	19	100	J	2100	0.16	450
SCI 1210 FT 018 □-□□	0.018	21	100	J	1900	0.18	450
SCI 1210 FT 022 □-□□	0.022	23	100	J	1700	0.2	450
SCI 1210 FT 027 □-□□	0.027	23	100	J	1500	0.22	450
SCI 1210 FT 033 □-□□	0.033	25	100	J	1400	0.24	450
SCI 1210 FT 039 □-□□	0.039	25	100	J	1300	0.27	450
SCI 1210 FT 047 □-□□	0.047	26	100	J	1200	0.3	450
SCI 1210 FT 056 □-□□	0.056	26	100	J	1100	0.33	450
SCI 1210 FT 068 □-□□	0.068	27	100	J	1000	0.36	450
SCI 1210 FT 082 □-□□	0.082	27	100	J	900	0.4	450
SCI 1210 FT R10 □-□□	0.1	28	100	J	700	0.44	450
SCI 1210 FT R12 □-□□	0.12	30	25.2	J	500	0.22	450
SCI 1210 FT R15 □-□□	0.15	30	25.2	J	450	0.25	450
SCI 1210 FT R18 □-□□	0.18	30	25.2	J	400	0.28	450
SCI 1210 FT R22 □-□□	0.22	30	25.2	J	350	0.32	450
SCI 1210 FT R27 □-□□	0.27	30	25.2	J	320	0.36	450
SCI 1210 FT R33 □-□□	0.33	30	25.2	J	300	0.4	450
SCI 1210 FT R39 □-□□	0.39	30	25.2	J	250	0.45	450
SCI 1210 FT R47 □-□□	0.47	30	25.2	J	220	0.5	450
SCI 1210 FT R56 □-□□	0.56	30	25.2	J	180	0.55	450
SCI 1210 FT R68 □-□□	0.68	30	25.2	J	160	0.6	450
SCI 1210 FT R82 □-□□	0.82	30	25.2	J	140	0.65	450
SCI 1210 FT 1R0 □-□□	1	30	7.96	J	120	0.7	400
SCI 1210 FT 1R2 □-□□	1.2	30	7.96	J	100	0.75	390
SCI 1210 FT 1R5 □-□□	1.5	30	7.96	J	85	0.85	370
SCI 1210 FT 1R8 □-□□	1.8	30	7.96	J	80	0.9	350
SCI 1210 FT 2R2 □-□□	2.2	30	7.96	J	75	1	320
SCI 1210 FT 2R7 □-□□	2.7	30	7.96	J	70	1.1	290
SCI 1210 FT 3R3 □-□□	3.3	30	7.96	J	60	1.2	260
SCI 1210 FT 3R9 □-□□	3.9	30	7.96	J	55	1.3	250
SCI 1210 FT 4R7 □-□□	4.7	30	7.96	J	50	1.5	220
SCI 1210 FT 5R6 □-□□	5.6	30	7.96	J	45	1.6	200
SCI 1210 FT 6R8 □-□□	6.8	30	7.96	J	40	1.8	180
SCI 1210 FT 8R2 □-□□	8.2	30	7.96	J	35	2	170
SCI 1210 FT 100 □-□□	10	30	2.52	J	30	2.1	150
SCI 1210 FT 120 □-□□	12	30	2.52	J	20	2.5	140
SCI 1210 FT 150 □-□□	15	30	2.52	J	20	2.8	130
SCI 1210 FT 180 □-□□	18	30	2.52	J	20	3.3	120

WIRE WOUND CHIP INDUCTOR

SCI SERIES

Size 1210 Type

Part No.	Inductance	Q	Test Freq.	Tol.	S.R.F.(min)	RDC(max)	IDC(max)
	(uH)	(min)	(MHz)	(%)	(MHz)	(Ω)	(mA)
SCI 1210 FT 220 □-□□	22	30	2.52	J	20	3.7	110
SCI 1210 FT 270 □-□□	27	30	2.52	J	20	5	80
SCI 1210 FT 330 □-□□	33	30	2.52	J	17	5.6	70
SCI 1210 FT 390 □-□□	39	30	2.52	J	16	6.4	65
SCI 1210 FT 470 □-□□	47	30	2.52	J	15	7	60
SCI 1210 FT 560 □-□□	56	30	2.52	J	13	8	55
SCI 1210 FT 680 □-□□	68	30	2.52	J	12	9	50
SCI 1210 FT 820 □-□□	82	30	2.52	J	11	10	45
SCI 1210 FT 101 □-□□	100	20	0.796	J	10	10	40
SCI 1210 FT 121 □-□□	120	20	0.796	J	10	11	70
SCI 1210 FT 151 □-□□	150	20	0.796	J	8	15	65
SCI 1210 FT 181 □-□□	180	20	0.796	J	7	17	60
SCI 1210 FT 221 □-□□	220	20	0.796	J	7	21	50
SCI 1210 FT 271 □-□□	270	20	0.796	J	6	28	45
SCI 1210 FT 331 □-□□	330	20	0.796	J	5	34	40
SCI 1210 FT 391 □-□□	390	20	0.796	J	5	36	35
SCI 1210 FT 471 □-□□	470	20	0.796	J	4	40	25

- * Tolerance: J=±5%
- * Operating Temperature: -40°C to +105°C
- * Inductance & Q value measured in HP4191A
- * SRF measured in 8753 Agilent
- * DC Resistance RDC measured in VP-2941A Panasonic
- * Unspecified values available on request.

WIRE WOUND CHIP INDUCTOR

SCI SERIES

Size 1812 Type

Part No.	Inductance	Q	Test Freq.	Tol.	S.R.F.(min)	RDC(max)	IDC(max)
	(μ H)	(min)	(MHz)	(%)	(MHz)	(Ω)	(mA)
SCI 1812 FT R18 □-□□	0.18	30	25.2	M	220	0.24	700
SCI 1812 FT R22 □-□□	0.22	30	25.2	M	200	0.25	665
SCI 1812 FT R27 □-□□	0.27	30	25.2	M	180	0.26	635
SCI 1812 FT R33 □-□□	0.33	30	25.2	M	165	0.28	605
SCI 1812 FT R39 □-□□	0.39	30	25.2	M	150	0.30	575
SCI 1812 FT R47 □-□□	0.47	30	25.2	M	145	0.32	545
SCI 1812 FT R56 □-□□	0.56	30	25.2	M	140	0.36	520
SCI 1812 FT R68 □-□□	0.68	30	25.2	M	135	0.40	500
SCI 1812 FT R82 □-□□	0.82	30	25.2	M	130	0.45	475
SCI 1812 FT 1R0 □-□□	1.0	50	7.96	K	100	0.50	450
SCI 1812 FT 1R2 □-□□	1.2	50	7.96	K	80	0.55	430
SCI 1812 FT 1R5 □-□□	1.5	50	7.96	K	70	0.60	410
SCI 1812 FT 1R8 □-□□	1.8	50	7.96	K	60	0.65	390
SCI 1812 FT 2R2 □-□□	2.2	50	7.96	K	55	0.70	380
SCI 1812 FT 2R7 □-□□	2.7	50	7.96	K	50	0.75	370
SCI 1812 FT 3R3 □-□□	3.3	50	7.96	K	45	0.80	355
SCI 1812 FT 3R9 □-□□	3.9	50	7.96	K	40	0.90	330
SCI 1812 FT 4R7 □-□□	4.7	50	7.96	K	35	1.00	315
SCI 1812 FT 5R6 □-□□	5.6	50	7.96	K	33	1.10	300
SCI 1812 FT 6R8 □-□□	6.8	50	7.96	K	27	1.20	285
SCI 1812 FT 8R2 □-□□	8.2	50	7.96	K	25	1.40	270
SCI 1812 FT 100 □-□□	10	50	2.52	K	20	1.60	250
SCI 1812 FT 120 □-□□	12	50	2.52	K	18	2.00	225
SCI 1812 FT 150 □-□□	15	50	2.52	K	17	2.50	200
SCI 1812 FT 180 □-□□	18	50	2.52	K	15	2.80	190
SCI 1812 FT 220 □-□□	22	50	2.52	K	13	3.20	180
SCI 1812 FT 270 □-□□	27	50	2.52	K	12	3.60	170
SCI 1812 FT 330 □-□□	33	50	2.52	K	11	4.00	160
SCI 1812 FT 390 □-□□	39	50	2.52	K	10	4.50	150
SCI 1812 FT 470 □-□□	47	50	2.52	K	10	5.00	140
SCI 1812 FT 560 □-□□	56	50	2.52	K	9	5.50	135
SCI 1812 FT 680 □-□□	68	50	2.52	K	9	6.00	130
SCI 1812 FT 820 □-□□	82	50	2.52	K	8	7.00	120
SCI 1812 FT 101 □-□□	100	40	0.796	K, J	8	8.00	110
SCI 1812 FT 121 □-□□	120	40	0.796	K, J	6	8.00	110
SCI 1812 FT 151 □-□□	150	40	0.796	K, J	5	9.00	105
SCI 1812 FT 181 □-□□	180	40	0.796	K, J	5	9.50	102
SCI 1812 FT 221 □-□□	220	40	0.796	K, J	4	10.0	100
SCI 1812 FT 271 □-□□	270	30	0.796	K, J	4	15.0	92
SCI 1812 FT 331 □-□□	330	30	0.796	K, J	3.5	15.0	85
SCI 1812 FT 391 □-□□	390	30	0.796	K, J	3	18.0	80
SCI 1812 FT 471 □-□□	470	30	0.796	K, J	3	26.0	62

WIRE WOUND CHIP INDUCTOR

SCI SERIES

Size 1812 Type

Part No.	Inductance	Q	Test Freq.	Tol.	S.R.F.(min)	RDC(max)	IDC(max)
	(uH)	(min)	(MHz)	(%)	(MHz)	(Ω)	(mA)
SCI 1812 FT 561 □-□□	560	30	0.796	K, J	3	30.0	50
SCI 1812 FT 681 □-□□	680	30	0.796	K, J	3	30.0	50
SCI 1812 FT 821 □-□□	820	30	0.796	K, J	2.5	43.0	30
SCI 1812 FT 102 □-□□	1000	20	0.252	K, J	2.5	40.0	30

- * Tolerance: M=±20%, K=±10%, J=±5%
- * Operating Temperature: -40°C to +85°C
- * Inductance & Q value measured in HP4291 or HP4284
- * SRF measured in HP4291
- * DC Resistance RDC measured in Agilent 34401A
- * Unspecified values available on request.

■ **Soldering Profile**

Reflow Soldering

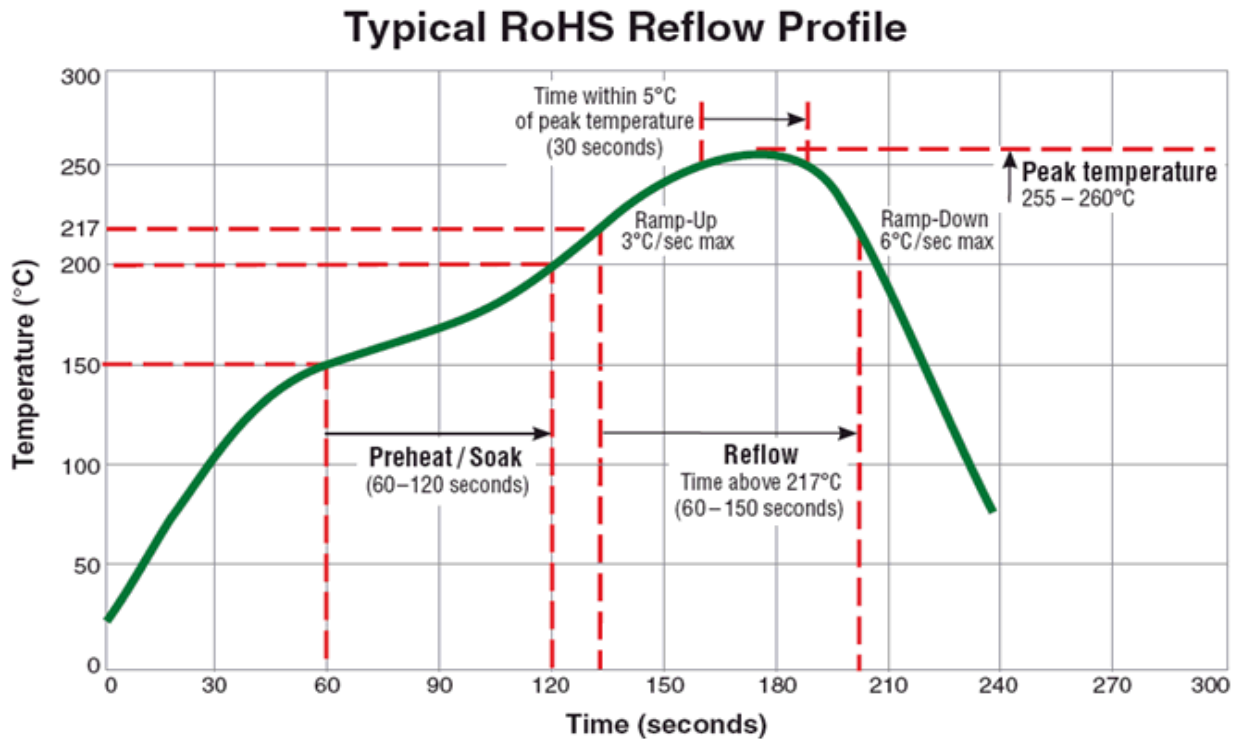

Manual Soldering

Soldering iron tip temperature: 350°C max / within 3 seconds.

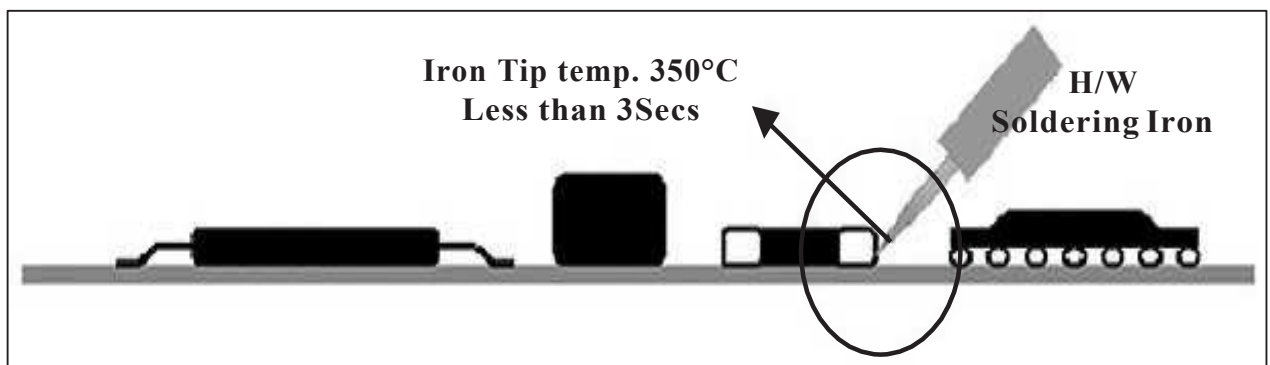

WIRE WOUND CHIP INDUCTOR

SCI SERIES

■ Specification & Test Method

	ITEM	CONDITION	SPECIFICATION															
Mechanical Performance Test	Solderability	The electrodes shall be at least 90% covered with new solder coating	Lead-free inductor: after fluxing(alpha 100 or equiv), inductor shall be dipped in a melted solder bath at 245±5°C, 5±0.5 seconds															
	Resistance to Soldering Heat	Appearance: No damage	Pre-heating: 150°C, 1min. Solder Temperature: 260±5°C Immersion Time: 10±1 seconds															
	Vibration	Appearance: No damage L change: within±10% Q change: within±30% DCR: within specification	Test device shall be soldered on the substrate Oscillation Frequency: 10 to 55 to 10Hz for 1 min. Amplitude: 1.5 mm Time: 2 hrs for each axis (X, Y&Z), total 6 hrs															
Electrical Performance Test	Inductance	Refer to standard electrical characteristic spec	HP4291 or HP4284															
	Q		HP4291 or HP4284															
	SRF		HP4291															
	DC Resistance DCR		Agilent 34401A															
	Rated Current IDC		Applied the current to coils, The inductance change should be less than 10% to initial value															
Climatic Performance Test	Temperature Cycle	Appearance: No damage L change: within±10% Q change: within±30% DCR: within specification	One cycle: <table border="1"> <thead> <tr> <th>Step</th> <th>Temperature (°C)</th> <th>Time (min.)</th> </tr> </thead> <tbody> <tr> <td>1</td> <td>-25±3</td> <td>30</td> </tr> <tr> <td>2</td> <td>25±2</td> <td>3</td> </tr> <tr> <td>3</td> <td>85±3</td> <td>30</td> </tr> <tr> <td>4</td> <td>25±2</td> <td>3</td> </tr> </tbody> </table> Total: 100 cycles Measured after exposure in the room condition for 24 hrs	Step	Temperature (°C)	Time (min.)	1	-25±3	30	2	25±2	3	3	85±3	30	4	25±2	3
	Step		Temperature (°C)	Time (min.)														
	1		-25±3	30														
	2		25±2	3														
3	85±3	30																
4	25±2	3																
Damp Heat with Load	Temperature: 40±2°C Relative Humidity: 90 ~ 95% Time: 1000 hrs Measured after exposure in the room condition for 24 hrs																	
High Temperature Storage	Temperature: 85±3°C Applied Current: Rated Current Time: 1000 hrs Measured after exposure in the room condition for 24 hrs																	
Low Temperature Storage	Temperature: -25±3°C Time: 1000 hrs Measured after exposure in the room condition for 24 hrs																	

WIRE WOUND CHIP INDUCTOR

SCI SERIES

■ Packaging

Packaging Quantity & Reel Specifications

Type	ΦA	ΦB	ΦC	W	T	Q'ty
SCI1008	178±2.0	60±0.5	13±0.3	9±0.3	12±1.0	2000
SCI1210	178±2.0	60±0.5	13±0.3	9±0.3	12±1.0	2000
SCI1812	178±2.0	80±0.5	13±0.3	13.2±0.3	16±1.0	500

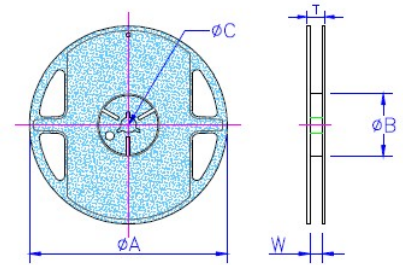

Embossed Plastic Tape Specifications

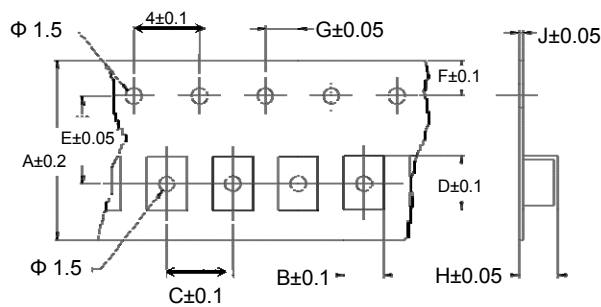

Unit: mm

Type	A	B	C	D	E	F	G	H	J
SCI1008	8	2.70	4	3.60	3.5	1.75	2	2.40	0.23
SCI1210	8	2.96	4	3.60	3.5	1.75	2	2.40	0.23
SCI1812	12	3.30	8	5.00	5.5	1.75	2	3.50	0.30

Leader / Trailer Tape

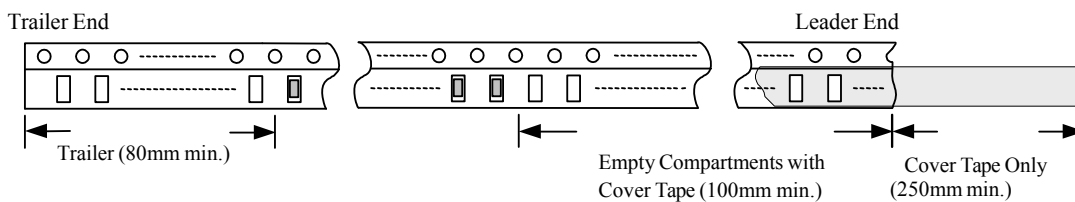

Cover Tape Peel Strength

The force for tearing off cover tape is 0.1~0.6 (N) in the arrow direction at the following conditions: Temperature: 5~35°C

Humidity: 45~85%

Atmospheric Pressure: 860~1060 hpa

