

## Y9120H Sundial RF<sup>2</sup> Pack 1 INSTALLATION INSTRUCTIONS



### Application

This pack provides a wireless control solution for adding a wireless room thermostat to heating systems.

### Pack Contents & Product Descriptions

- 1 x ST9120C1003** Wireless enabled 7 day timer with 1 output control relay for switching boilers, pumps or zone valves in heating systems. It requires permanent mains 230Vac power.
- 1 x DTS92E1020** Wireless digital room thermostat with energy saving ECO function. It operates on 2xAA alkaline batteries, giving a battery life of at least 2 years under typical operating conditions.
- 1 x table stand for DT92E** (optional)

Other Honeywell products, not supplied in this pack, may be required for a complete installation, depending on the application. For example BDR91T1004 relay box. See Schematic System Layouts (below) or refer to [www.honeywelluk.com](http://www.honeywelluk.com) for full details.



*Sundial RF<sup>2</sup> is a registered trademark of Honeywell Inc.*

### System Operation

DT92E and ST9120C both use 2-way communication on an 868MHz radio frequency (RF) band to control the heating system.

ST9120C operates as the control hub of the system, and DT92E is free to be positioned anywhere in the living space.

This functionality is ideal for upgrading existing systems without a room thermostat to ensure compliance with Building Regulations. It is also ideal for refurbished systems, where running mains cable from the timer to the thermostat and back to the boiler is difficult or impractical.

There are various options for how to connect to the boiler. The simplest is a direct 230Vac or potential-free connection. If the boiler is located remotely, it is possible to send the switching signal from the ST9120C to a remote located BDR91T relay box.

50047644-005 A

**This document is to be left with the user**

### Schematic System Layouts

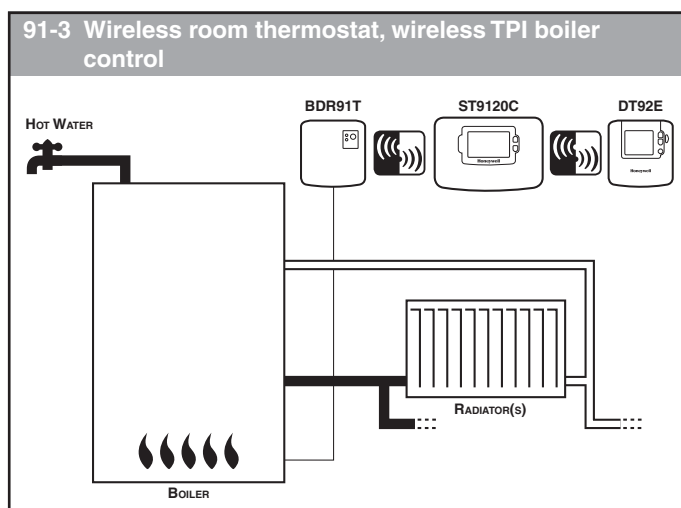
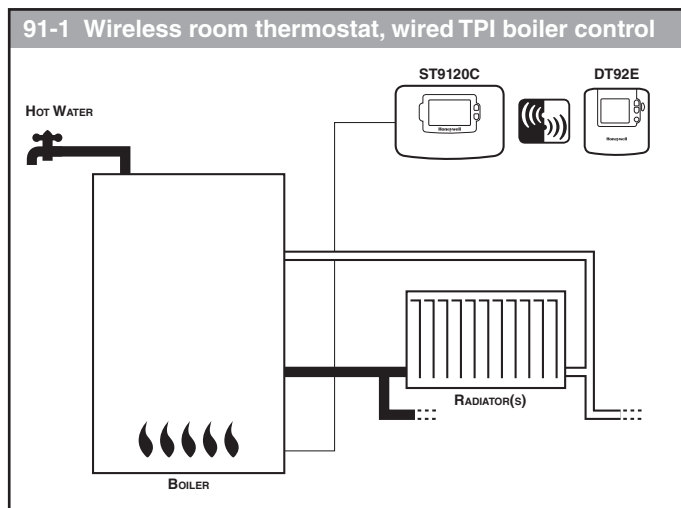

## Installation Notes

The RF link between the Room Thermostat (DT92E) and the Timer (ST9120C) in Honeywell system packs is pre-configured at the factory and therefore both units should be installed at the same site.

- If products from individual system packs are separated, or mixed with other pre-configured system packs during installation, or a faulty unit is being replaced, the desired units must be specially configured to allow them to communicate with each other. This process is called Binding. Please refer to section **6 Binding / Re-binding Procedure**.
- DT92E or ST9120C will not communicate with other RF products that use different frequencies or communications protocols.
- The DT92E room thermostat requires no power source other than the batteries provided.
- **The ST9120C Timer requires a permanent 230V~ supply.**
- The Timer should be installed and powered up before commencing the Room Thermostat installation.
- If the boiler is being switched using a remote relay box (BDR91T) the relay box is not supplied in this pack and will require to be bound to ST9120C (see Section 6 Binding / Re-binding Procedure)

## RF Signal Propagation

Within a typical house two RF products should communicate reliably within a 30m range. It is important to take into consideration that walls and ceilings will reduce the RF signal. The strength of the RF signal reaching the Timer depends on the number of walls and ceilings separating it from the room thermostat, as well as the building construction - the diagram below illustrates an example of typical signal strength reduction. Walls and ceilings reinforced with steel or plasterboard walls lined with metal foil reduce the RF signal significantly more.

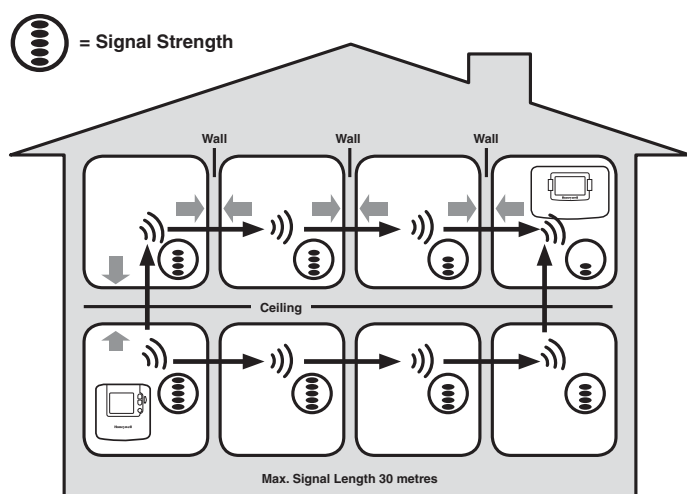

Typical example of Building Fabric Signal losses

## Installation Sequence: Step by Step

Section	Page
<b>1 INSTALLING THE ST9120C TIMER .....</b>	<b>3</b>
1.1 Mounting ST9120C .....	3
1.2 ST9120C Mounting options .....	3
1.3 Wiring ST9120C .....	3
1.4 ST9120C Final Assembly.....	3
1.5 ST9120C Internal Wiring.....	4
1.6 System Wiring Diagrams .....	4
1.7 Replacement Wiring .....	5
1.8 Replacing Other Manufacturers' Time Controls .....	5
1.9 Powering Up ST9120C .....	5
<b>2 INSTALLING THE DT92E ROOM THERMOSTAT .....</b>	<b>6</b>
2.1 Locating DT92E .....	6
2.2 Powering Up DT92E .....	6
2.3 DT92E Signal Strength Test .....	6
2.4 Mounting DT92E .....	7
2.5 Separating DT92E From Its Mounting Plate.....	7
<b>3 INSTALLING THE BDR91T WIRELESS RELAY BOX</b>	<b>8</b>
3.1 Locating the BDR91T.....	8
3.2 BDR91T Mounting Options.....	8
3.3 Wiring BDR91T .....	8
3.4 BDR91T Final Assembly .....	8
<b>4 SYSTEM CONFIGURATION: ST9120C .....</b>	<b>9</b>
4.1 ST9120C Installer Modes.....	9
4.2 Boiler Service Reminder / Shut-down Feature.....	9
4.3 Installer Setup .....	10
4.4 Installer Setup Flowchart .....	11
4.5 Set Service.....	11
4.6 Change PIN .....	13
4.7 What the User Will See When a Service is Due.....	13
4.8 Resetting the Service Timer Function.....	13
<b>5 SYSTEM CONFIGURATION: DT92E .....</b>	<b>14</b>
5.1 DT92E Installer Mode .....	14
<b>6 BINDING / RE-BINDING PROCEDURE .....</b>	<b>15</b>
6.1 Binding.....	15
6.2 ST9120C Guided Binding Menu.....	15
6.3 Guidance for Replacing Devices or Changing the Application ...	15
6.4 Binding Menu Display.....	16
6.5 How to Bind DT92E to ST9120C.....	16
6.6 How to Bind BDR91T to ST9120C .....	17
6.7 How to Test BDR91T Signal Strength .....	17
<b>7 COMMISSIONING THE SYSTEM .....</b>	<b>20</b>
7.1 System Test Checklist.....	20
7.2 Completion Checklist.....	20

# 1 INSTALLING THE ST9120C TIMER

## 1.1 Mounting ST9120C

For best performance, install in an open space. Leave at least 30cm distance from any metal objects including pipes and the boiler housing.

If the ST9120C is replacing an existing ST9100 or ST6100 then the existing wall-plate and wiring may be used, subject to any required electrical checks.

**If the existing wall-plate is mounted on a metal wall-box, the RF signal performance may be impaired. After locating the DT92E room thermostat, use the Signal Strength Test shown on Page 6 to determine if there is a reception problem. If problems persist, it is recommended that this metal wallbox is replaced by an equivalent plastic wallbox.**

The Timer should be mounted at a level where the display can be seen clearly, (compliance with Building Regulations part M requires a height of 1.2m from the floor) and the ambient temperature is within the range of 0 to 40°C. The ST9120C is for use in normal domestic environments.

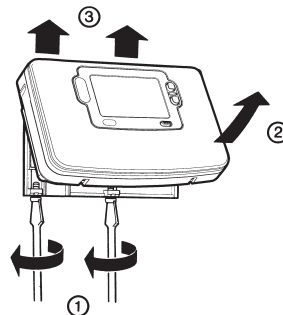

To remove the unit from the wall-plate, slacken the two securing screws at the bottom of ST9120C and hinge the unit up to separate the two halves.

### CAUTION

Isolate power supply and make safe before wiring the unit to prevent electric shock and equipment damage. Installation should be carried out by a qualified electrician or competent heating engineer.

## 1.2 ST9120C Mounting Options

### Recommended clearance distances:

Above wallplate:	110mm
Below wallplate:	100mm
Left/right of wallplate:	10mm

Ensure the mounting surface is supporting and fully covers the wiring wall-plate.

a. Surface mounting concealed wiring

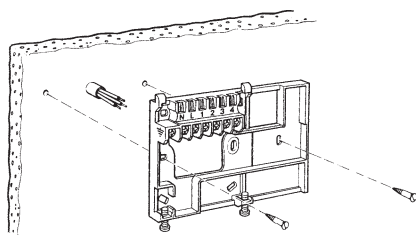

b. Flush switchbox

Fixing holes are spaced to suit BS4662 requirements

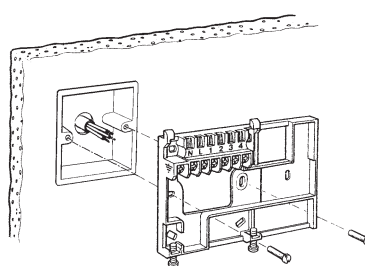

c. Surface mounting with surface wiring in mini trunking

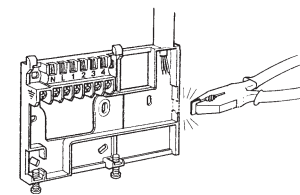

## 1.3 Wiring ST9120C

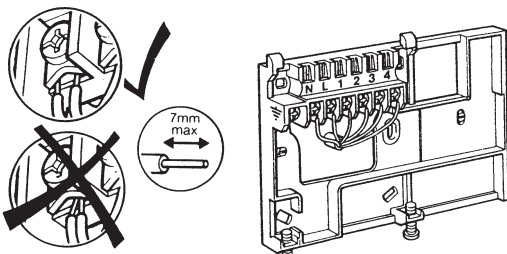

### EMC compliance considerations

Keep AC mains supply/load cables separate from signal wiring.  
Refer to Code of Practice standards EN61000-5-1 and -2 for guidance.

### ALL WIRING MUST BE IN ACCORDANCE WITH IEE REGULATIONS. THIS UNIT IS FOR FIXED WIRING ONLY.

A switch, having contact separation of at least 3mm in all poles must be incorporated in the fixed wiring as a means of disconnecting the supply.

The unit is a Class II (double insulated) device. A parking terminal is provided for external earth continuity.

The system must be appropriately fused. A fuse rated at no more than 3 Amps should be installed.

The unit has 4 knockouts for surface wiring. Care must be taken to ensure that the cable or mini-trunking completely fills the knockout hole without leaving any gaps.

## 1.4 ST9120C Final Assembly

Clip the unit onto the hinges on the top of the wallplate and hinge down into position. Tighten the two securing screws using a screwdriver.

Switch on the power – the unit will now be operating according to the built-in programme.

**Note:** the ST9120C is supplied with a factory set clock for faster installation.

Refer to Y9120H User Guide for programming details.

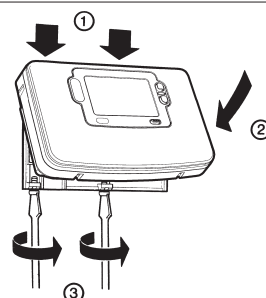

## 1.5 ST9120C Internal Wiring

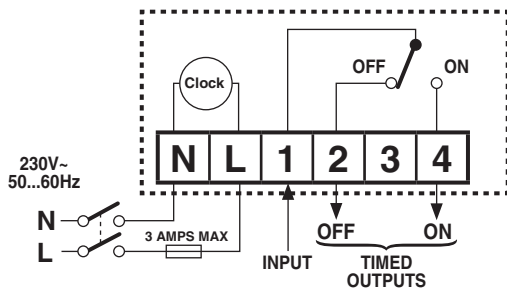

### Notes

1. DT92E is completely wireless and so is not shown connected on these wiring diagrams.
2. The ST9120C is a Class II (double insulated) device. A parking terminal is provided for earth wiring continuity, if required.
3. ST9120C is suitable for contact-closure potential free or mains voltage switching.
4. The BDR91T Relay Box (diagram 91-3) requires a permanent 230V~ supply.

## 1.6 System Wiring Diagrams

91-1 Wireless room thermostat, wired TPI boiler control

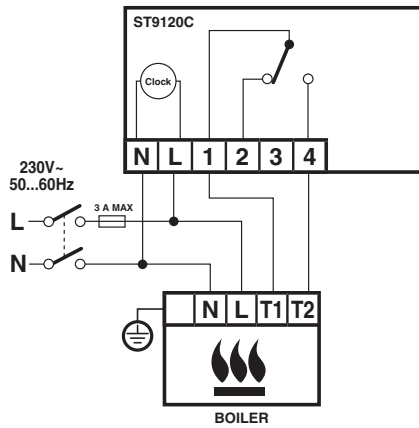

91-3 Wireless room thermostat, wireless TPI boiler control

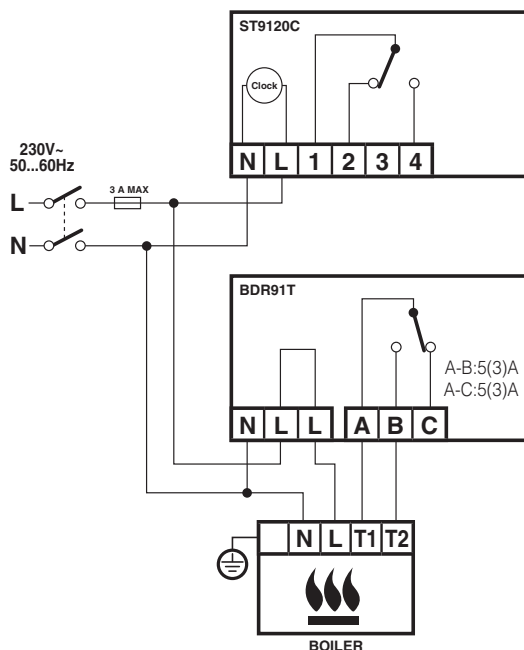

---

## 1.7 Replacement Wiring

---

If using ST9120C to replace other Honeywell Timers, the equivalent wiring terminations are shown in the tables below.

ST6100, ST9100	N	L	1	2	4
* ST9120C	N	L	1	2	4
<b>* Note:</b> If replacing ST6100S or ST9100S, please refer to Honeywell for wiring details as the wiring for the Service Timeout feature may have to change, depending on the application.					

ST7000B	-	L	-	2	3
** ST9120C	N	L	1 Link to terminal L	2	4
<b>** Note:</b> A permanent mains supply must be provided for the ST9120C Timer.					

When converting a fully wired system, remove the wired room thermostat and its associated electrical wiring. Some minor changes are required to make the appropriate wiring connections to the boiler.

---

## 1.8 Replacing Other Manufacturers' Time Controls

---

ST9120C Timers will mount directly onto many existing manufacturers' back-plates, with a minimal need for re-wiring. They are also supplied complete with a wiring back-plate, should this not be the case.

Refer to Honeywell Technical Help Desk for wiring conversion diagrams.

---

## 1.9 Powering Up ST9120C

---

Check the unit powers up correctly and that the display does not remain blank.

ST9120C must be powered up before DT92E is installed, so that the signal strength tests can be conducted.

The initial signal strength test will verify that both units have each others addresses in their memory, and can therefore communicate. The process of writing respective addresses into memory is called BINDING.

## 2 INSTALLING THE DT92E ROOM THERMOSTAT

### 2.1 Locating DT92E

For best performance, install DT92E in an open space where it can sense the room temperature, and where the signal strength is high.

The Room Thermostat can be mounted on a wall or on the optional table stand. Do not mount on metal wall-boxes.

Leave at least 30cm distance from any metal objects and at least 1 metre from any other electrical equipment.

Select the preferred location and test the Signal Strength before installation.

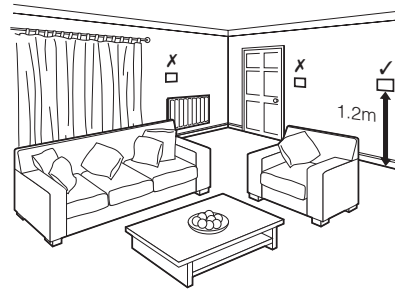

### 2.2 Powering Up DT92E

DT92E is supplied in the pack with the mounting plate separated from the rest of the unit for ease of installation. The next sequence of operations should be done before mounting DT92E onto its mounting plate.

First hold DT92E between 1 and 2 meters away from ST9120C. To power it up, unclip the battery cover and then remove the paper tab that isolates the batteries from their contacts. When the display powers up the battery cover should be clipped back on.

Immediately on power up, DT92E will try to communicate and synchronise with ST9120C. This process may take up to 4 minutes, and will be indicated by the word **'Sync'** on the DT92E display.

When **'Sync'** disappears from the display, DT92E is ready for a test of the RF signal strength between it and the ST9120C Timer.

Now go to section 2.3 to conduct the **Signal Strength Test**.

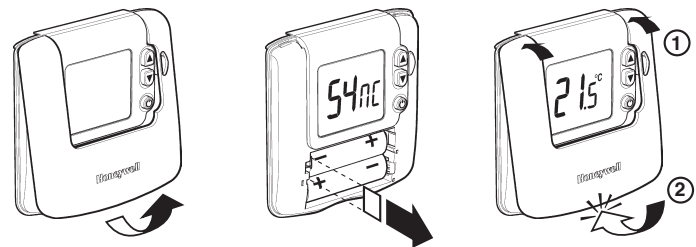

### 2.3 DT92E Signal Strength Test

Honeywell 2-way RF communications allows signal strength testing to ensure DT92E can be positioned in the best possible location.

To enter **Signal Strength Test**:

- Hold down the button for 2 seconds until the symbol is displayed.
- Hold down the and buttons together for 3 seconds until **'Inst'** appears in the display.
- Press the button (**'Cont'** is now displayed)
- Hold the button for 3 seconds to enter **Test** mode.
- Signal Strength Test** is entered from **Test** mode by holding the button for 3 seconds, until the display shows **'SS'**.

ST9120C measures the strength of the DT92E signal every 5-10 seconds and will communicate this to DT92E as a number between 0 and 5. The value drops to 0 briefly as each new signal strength measurement is made.

A signal strength of 3 or more is recommended to ensure reliable communications.

#### Step 1

Hold DT92E between 1 and 2 meters away from ST9120C and check the signal strength is high (> 2). This confirms the two units are in the condition they left the factory and are bound together, and you can move to Step 2.

If the signal strength is shown as 0, the units are possibly not bound together. Go to the section **6 Binding / Re-binding**, follow the procedure there, and then repeat the complete Signal Strength Test sequence.

#### Step 2

Whilst staying in Signal Strength Test mode, take the DT92E to the preferred location. Wait for 10 seconds and check the signal strength > 2. If so, the DT92E is ready to mount.

If the signal strength is less than 2, re-position the room thermostat within the local area +/- 1 or 2m to see if the signal strength improves. If this fails, try to reduce the range/distance between the room thermostat and the ST9120C.

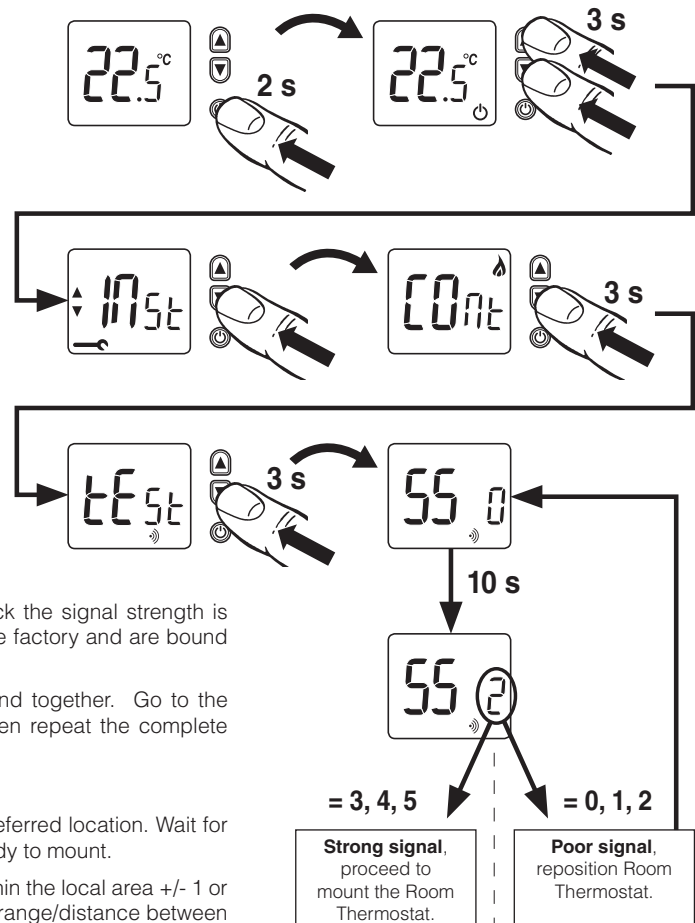

**Exit Signal Strength Test by holding the button for 5 seconds. The DT92E will timeout of this mode after 10 minutes.**

## 2.4 Mounting DT92E

DT92E can be mounted (a) directly on a wall, or (b) on the optional table stand provided.

Wall mounting is recommended as it ensures a position of high signal strength can be maintained.

- a. For wall mounting, install the mounting plate first, then follow steps 1, 2 and 3 to hinge the front piece on, as shown in the diagrams.

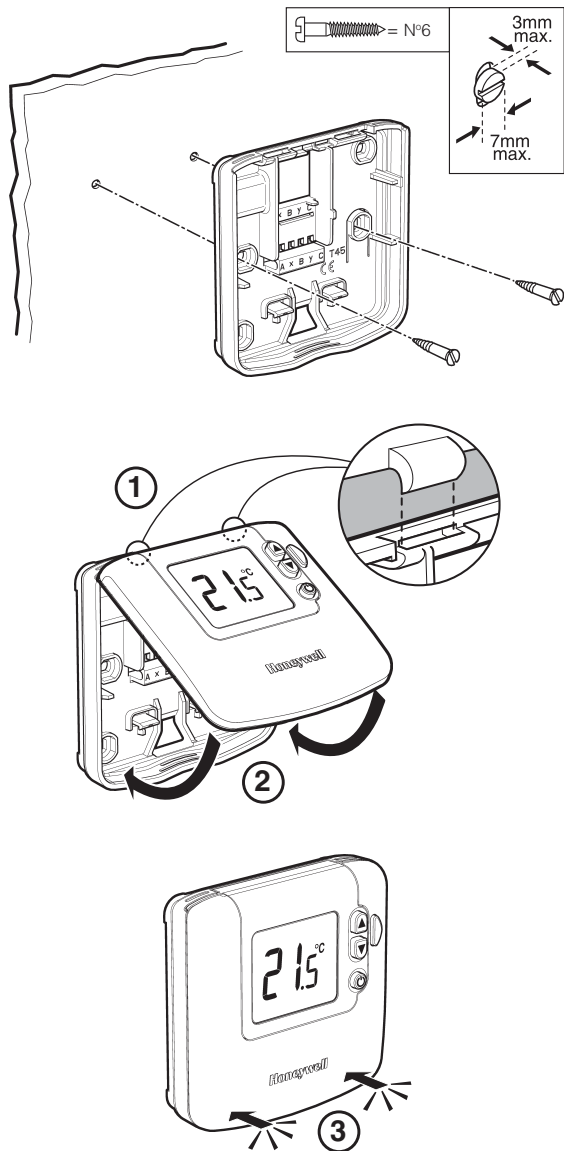

- b. If the optional table stand is to be used, first assemble the two pieces together as shown. Next follow steps 1, 2 and 3 to hinge the DT92E front piece onto its mounting plate, and mount the unit onto the table stand.

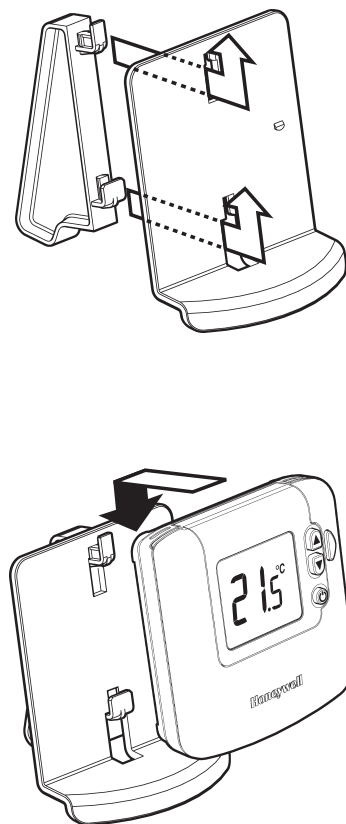

## 2.5 Separating DT92E from its Mounting Plate (if required)

If the DT92E requires to be separated from its mounting plate, follow the simple steps shown below.

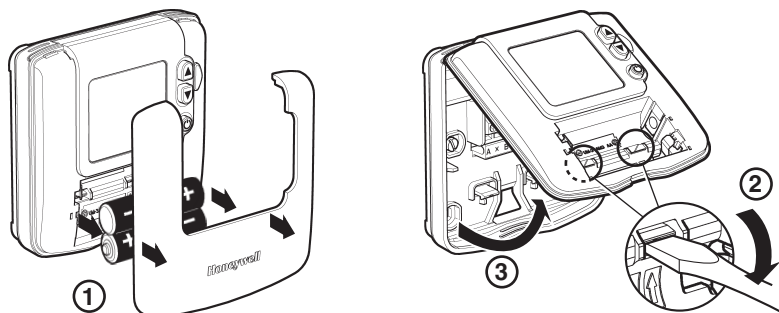



### 3 INSTALLING THE BDR91T WIRELESS RELAY BOX (IF REQUIRED)

If the heating boiler is located remotely it is possible to control it using a wireless relay box BDR91T1004. This is not supplied in this pack and must be purchased separately. After installation it must be bound (paired) to the ST9120C timer and then the signal strength should be verified to ensure the location chosen is suitable.

#### 3.1 Locating the BDR91T

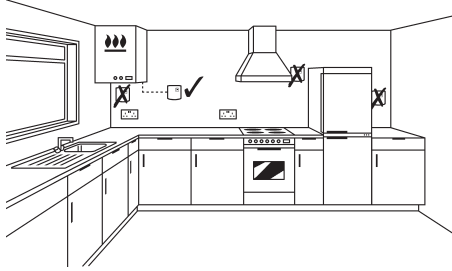

For best performance install in an open space. Leave at least 30cm distance from any metal objects including wall boxes and boiler housing. **Do not mount on metal wall boxes.**

The BDR91T needs to be positioned in a location where the RF signal strength from ST9120C is high. The simplest way to identify such a location in advance is to use the signal strength feature on DT92E, because DT92E can be moved around freely.

- Remove DT92E from its mounting plate (section 2.5)
- Enter signal strength test (section 2.3)
- Identify a location close to the boiler where the signal strength is 3 or more.
- After BDR91T is mounted and wired in this location, the signal strength it is receiving can be verified using its own signal test (section 6.7)
- Remember to re-attach DT92E to its mounting plate.

#### 3.2 BDR91T Mounting Options

Ensure the mounting surface is supporting and fully covers the backplate and mount to the surface using the screw holes provided. An alternative pair of mounting holes is also available.

**NOTE:** The BDR91T contains no user serviceable parts. It should be opened and installed by a qualified installer only.

**WARNING:** Electrostatic sensitive device! Do not touch the circuit board.

##### Removing the BDR91T cover

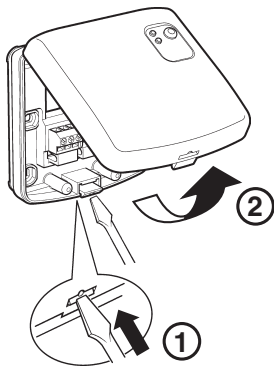

Unclip the front cover and hinge it away to reveal the wiring backplate.

##### a. Mounting on a wall box

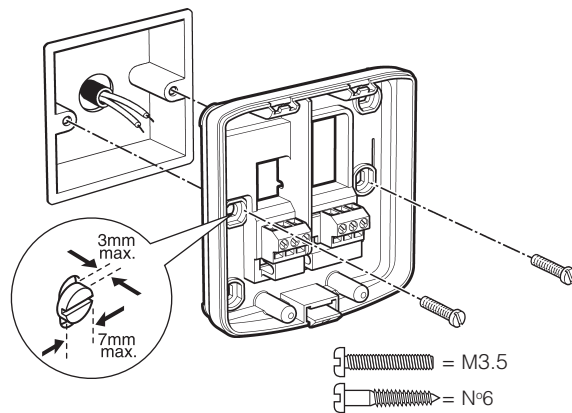

##### b. Surface mounting

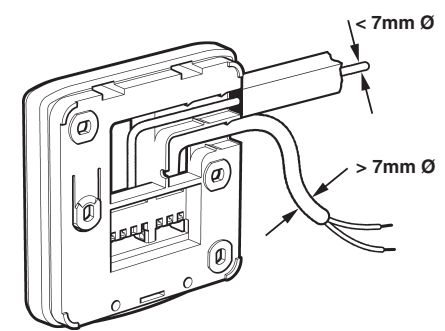

#### 3.3 Wiring BDR91T

The BDR91T Relay Box requires a permanent 230V~ supply.

For wiring schematics please refer to diagram 91-3 on page 4.



Isolate power supply and make safe before wiring the unit to prevent electric shock and equipment damage. Installation should be carried out by a qualified electrician or competent heating engineer.

##### EMC compliance considerations

Keep AC mains supply/load cables separate from signal wiring.

Refer to Code of Practice standards EN61000-5-1 and -2 for guidance.

#### 3.4 BDR91T Final Assembly

##### Wire preparation

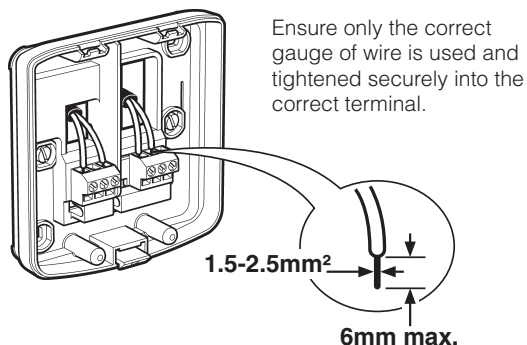

##### Replacing the BDR91T cover

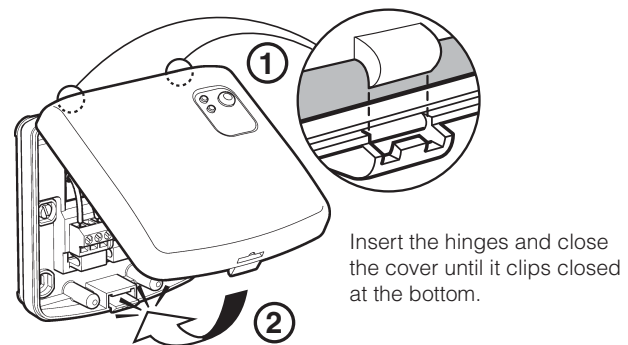



---

## 4 SYSTEM CONFIGURATION: ST9120C

---

### 4.1 ST9120C Installer Modes

---

ST9120C has 3 Installer Modes that enable the product to be customized for the application and for the needs of the User. Each adjustable feature is called a Parameter, and is represented by a number or letter ID and a value. The Modes are:-

- **Installer Setup**

Installer Setup allows features to be adjusted to suit user lifestyles or preferences, for example; backlight operation, automatic time-change, and selection of the default time programme. It is entered by a combination of button presses.





- **Set Service**

This is where the ST9120C Boiler Service Reminder and Shut-down Features can be set. This mode can only be entered by using a 4 digit PIN code. The factory supplied default PIN code is **0000**

- **Change PIN**

This mode allows the 4-digit PIN code to be adjusted. It is itself protected by the PIN code. When the code is changed this new code is used to enter both SET SERVICE and CHANGE PIN modes.

#### To Enter & Navigate Around the Installer Modes:

- a. Ensure the slider is in the **RUN** position, then press and hold  and  buttons together for 8 seconds. Ignore the 'NOT VALID' that is displayed for a few seconds. The message '**SET UP MENU**' will show briefly, to indicate you have entered the Setup menu. The *LoT™ Display* will continue to show messages indicating which Installer Mode is possible to select, for example '**SET INSTALLER OK ?**'
- b. Use the  or  buttons to navigate to the correct Installer Mode.
- c. Use the  button to confirm you wish to enter that particular mode.

Installer Mode	LoT™ Display Message
Installer Setup	'SET INSTALLER OK ?'
Set Service	'SET SERVICE OK ?'
Change PIN	'CHANGE PIN OK ?'

#### To Exit Installer Modes:

You can exit the Installer Modes at any time by moving the slider to the next position and then back again to **RUN**. Any changes that have been confirmed will be saved and used.

**Note:** The Installer Modes and the Setup Menu will exit automatically after 10 minutes if the slider is not moved and no adjustments have been made in this time.

---

### 4.2 Boiler Service Reminder / Shut-down Feature

---

The ST9120C Timer has a Service feature that can assist Social Housing Landlords to comply with the requirements of Regulation 36 of the Gas Safety (Installation & Use) Regulations 1998. It is intended as an aid to compliance but should not be used to replace the Landlord's existing Servicing procedures.

The ST9120C performs like a standard timer. In addition it can automatically provide a Service Reminder and can be set to Shut-down the heating / hot water system once the gas Boiler Service becomes overdue. This helps to eliminate the potential for an incident to occur after the Landlord's Safety Certificate has expired.

The operation of the Service Feature is flexible. The landlord or installer can set the following:

- The service interval, in days
- An advance reminder for the tenant, by counting down days until service is due
- A contact telephone number to call to arrange the service – displayed on the LCD screen
- How the timer will operate when the service interval has expired.

#### The options include:

1. Continued normal operation with a Reminder message
2. Total system shutdown
3. "Prompt" mode – shutdown that will allow repetitive manual over-ride for one hour at a time.

The Service feature is configured from a special Installer Mode called '**SET SERVICE**'. Entry into this mode is only possible by entering a unique 4 digit PIN code.

**Note:** The ST9120C is supplied from the factory with the Service features **DISABLED**. They need to be enabled from the Installer Modes. See section **4.6 Set Service** for details.

## 4.3 Installer Setup

The system can be set up to operate in a variety of different ways to suit the application, or the user lifestyle or preferences.

This setup is done via the ST9120C Installer Setup. The features that can be adjusted are called Installer Parameters, and are listed in the table below, along with a description of the options that are possible.

INSTALLER PARAMETER	Parameter Number	LoT™ Display Description	Default Value	Range of Values	Description [LoT™ Display Description]
24hr or am/pm clock display.	1	CLOCK MODE	12	12, 24	12 = am/pm display, [AM PM] 24 = 24hr display [24 HOUR]
Configure backlight operation.	2	BACKLIGHT	2	0, 1, 2	0 = off, [NO B-LIGHT] 1 = on if button pressed, [B-L DELAY] 2 = on continuously [B-LIGHT ON]
Enable/disable auto time change.	3	AUTO TIME	1	0, 1	0 = disabled, [NO CHANGE] 1 = enabled [TIME CHANGE]
1-day or 5/2-day or 7-day operation.	4	UNIT TYPE	7	1, 5, 7	1 = 1-day operation, [1-DAY] 5 = 5/2-day operation, [5-2 DAY] 7 = 7-day operation [7-DAY]
Number of ON/OFFs per day.	5	ON PERIODS	3	2, 3	2 = 2 on/off per day, [2 PER DAY] 3 = 3 on/off per day [3 PER DAY]
Select default time programme.	6	DEF PROFILE	A	A, b, C	A = standard, [PROFILE A] b = at home, [PROFILE B] C = economy [PROFILE C]
* Set Hot Water Temperature	8	WATER TEMP	60	40 ... 85°C	Hot Water Temperature [SET WATER TEMP]
Optimum start	9	OP START	0	0, 1, 2	0 = no optimum start [NO OP-STRT] 1 = delayed start [DELAY-STRT] 2 = optimum start on [OP-STRT ON]
Optimum start limit (Only available if OP START set to 2)	10	STRT LIMIT	1	1, 2, 3	1 = 1 hour [1 HOUR] 2 = 2 hours [2 HOURS] 3 = 3 hours [3 HOURS]
Optimum stop	11	OP STOP	0	0, 1	0 = disabled, [NO OP-STOP] 1 = enabled [OP-STOP ON]
Frost protection temperature	12	FROST TEMP	5	5 to 16°C	Frost protection temperature [SET FROST TEMP]
Minimum ON/OFF time	13	MIN ON-OFF	1	1, 2, 3, 4, 5 minutes	Minimum ON/OFF time [SET MIN ON-OFF]
Cycle rate	14	CYCLE RATE	6	3, 6, 9, 12	Number of boiler cycles [SET CYCLE RATE]
Proportional band width	15	PROP BAND	15 (=1.5°C)	15 ... 30 (=1.5 ... 3.0°C)	Control proportional band [SET PROP BAND]
Failsafe mode (loss of RF communications)	16	COMMS LOSS	0	0, 1	0 = off [HEAT OFF] 1 = on 20% [20 PERCENT]
** Reset all parameters	20	PROG RESET	1	0, 1	0 = do not reset [RESET OFF] 1 = default parameters [RESET ON]

\* Only used if CS92A wireless cylinder sensor is connected.

\*\* This parameter by default has a value of 1, unless you change any other parameter, when it will change to 0. Set it to 1 to reset all parameters back to defaults. Some parameters may not be displayed, depending on the settings made for prior parameters.

### Recommendations for Specific Boiler Applications

Application	Cycles per hour	Minimum on/off time	What to change:
Gas boiler	6	1	No changes required, leave at default values
Oil boiler	3	4	Set parameter 13: 1 to 13: 4 Set parameter 14: 6 to 14: 3

#### To Enter Installer Setup:

- Ensure the slider is in the **RUN** position, then press and hold the **OK** and **DOWN** buttons together for 8 seconds. Ignore the **'NOT VALID'** that is displayed for a few seconds. The message **'SET UP MENU'** will show briefly, followed by **'SET INSTALLER OK ?'**
- Press the **OK** button to take you into the Installer Setup Parameter Menu.
- Parameter 1 is now available to change. This is to allow you to change the clock format from 12 hour AM/PM to 24 hour. At every step, the *LoT™ Display* will inform you what the parameter means and what option you have selected. The parameter number is shown on the display separated by a colon from the parameter value.
- You can change the parameter value by pressing the **DOWN** or **UP** buttons. At this point the description in the *LoT™ Display* will change and the parameter value will flash. If you press **OK** the value will stop flashing and will be saved for use.
- Press **OK** to move to the next parameter available for editing. The parameter number will change accordingly.
- Keep pressing **OK** to step around the list of parameters, and use **DOWN** or **UP** buttons to change the parameter value.
- Any parameter changes that have been confirmed with the **OK** button will be saved and used.

#### To Exit Installer Setup:

You can exit any Installer Mode at any time by moving the slider to the next position and then back again to **RUN**.

**Note:** *Installer Modes will exit automatically after 10 minutes if the slider is not moved.*

## 4.4 Installer Setup Flowchart

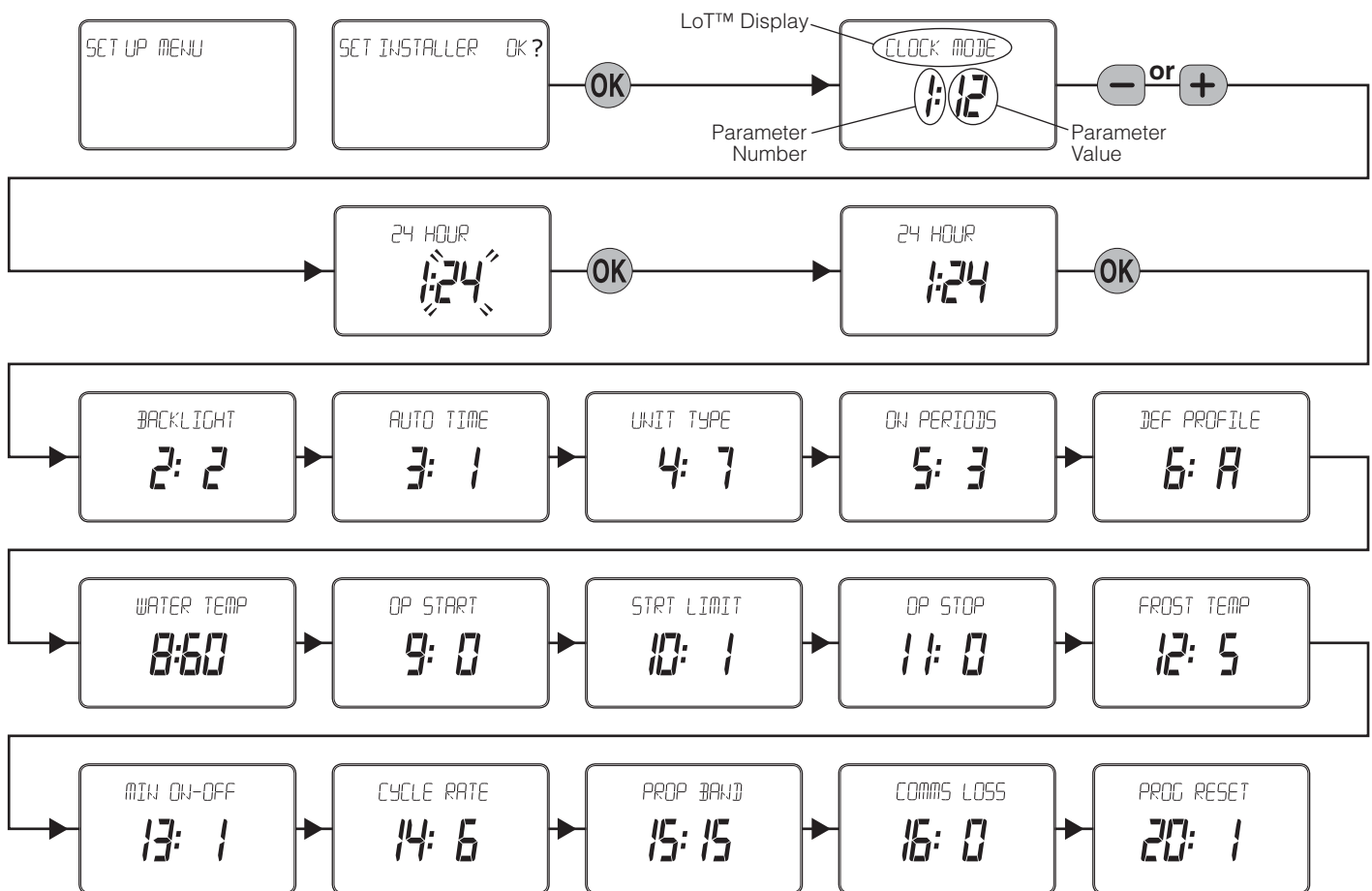

## 4.5 Set Service

Set Service parameters are listed in the table below, along with a description of the options that are possible. Most are only displayed if Service is enabled i.e. parameter AL is set = 1.

'SET SERVICE' PARAMETER	Parameter ID	LoT™ Display Description	Default Value	Range of Values	Description [LoT™ Display Description]
Enable or disable service alarm feature	AL	SERV MODE	0	0, 1	0 = disabled 1 = enabled [DISABLED] [ENABLED]
Number of days till next Service	d	SERV DAYS	364	001 to 400	001...400 000 = service is overdue [SET DAY COUNT]
Number of days for advance warning	Ad	DAYS NOTICE	28	0 to 28	0 ...28 [SET DAYS NOTICE]
Action taken at time-out	to	ACTION TYPE	2	0, 1, 2	0 = no action, 1 = switch off, 2 = 'prompt' mode [NO ACTION] [SWITCH OFF] [PROMPT MODE]
Number of EXTRA HOUR button presses allowed in 'Prompt' mode	bP	1HR BOOSTS	uL	uL, 1 to 99	uL = unlimited number, 1...99 = specified number of button presses, after which unit switches off [NUM BOOSTS]
Enable telephone call number display	tC	SHOW PHONE	0	0, 1	0 = disabled 1 = enabled [DISABLED] [ENABLED]
Enter contact telephone STD code	St	STD CODE	-----	1	When a ⊖ ⊖ or ⊕ ⊕ button is first pressed the LoT™ Display shows a row of dashes which can be adjusted using ⊖ ⊖ or ⊕ ⊕ buttons, then verified using the OK button.
Enter contact telephone number	nu	NUMBER	-----	1	When a ⊖ ⊖ or ⊕ ⊕ button is first pressed the LoT™ Display shows a row of dashes which can be adjusted using ⊖ ⊖ or ⊕ ⊕ buttons, then verified using the OK button.
* Reset 'SET SERVICE' parameters to default values	rS	ALRM RESET	1	0,1	0 = do not reset 1 = default parameters [NO RESET] [RESET]

\* This parameter by default has a value of 1, unless any other parameter is adjusted, when it will change to 0. Set it to 1 to reset all parameters back to defaults

## 4.5 Set Service (cont.)

### To Enter Set Service Mode:

- Enter **Installer Modes** (as described on Page 9) and navigate to **SET SERVICE** mode. In response to the query **'SET SERVICE OK ?'** press the **OK** button to enter SET SERVICE.
- The message **'ENTER PIN'** will now be displayed, along with the 4-digit entry code format 0---. The first digit will be flashing, to indicate it can be changed. Use the **⊖** or **⊕** buttons to set the first digit, and press **OK** to confirm the digit.
- At this point the first digit will stop flashing and the second digit will begin to flash, indicating it can be changed.
- Proceed in this way to enter the 4 digits of the PIN code. Upon confirming the last digit, if the PIN was incorrect, the message **'INVALID'** will be displayed, and then the whole process will start again from step **b.** above.
- If the PIN was correct, the first SET SERVICE parameter **'AL'** will be available to change. This allows you to enable or disable all the service alarm features. At every step, the *LoT™ Display* will inform you what the parameter means and what option you have selected. The parameter ID is usually shown on the display separated by a colon from the parameter value.
- You can change the parameter value by pressing the **⊖** or **⊕** buttons. At this point the description in the *LoT™ Display* will change and the parameter value will flash. If you press **OK** the value will stop flashing and will be saved for use.
- Press **OK** to move to the next parameter available for editing. The parameter ID will change accordingly.
- Keep pressing **OK** to step around the list of parameters, and use **⊖** or **⊕** buttons to change the parameter value.
- Any parameter changes that have been confirmed with the **OK** button will be saved and used. Some parameters may be made invalid by a previous parameter setting, and these will be skipped over in the setting process.

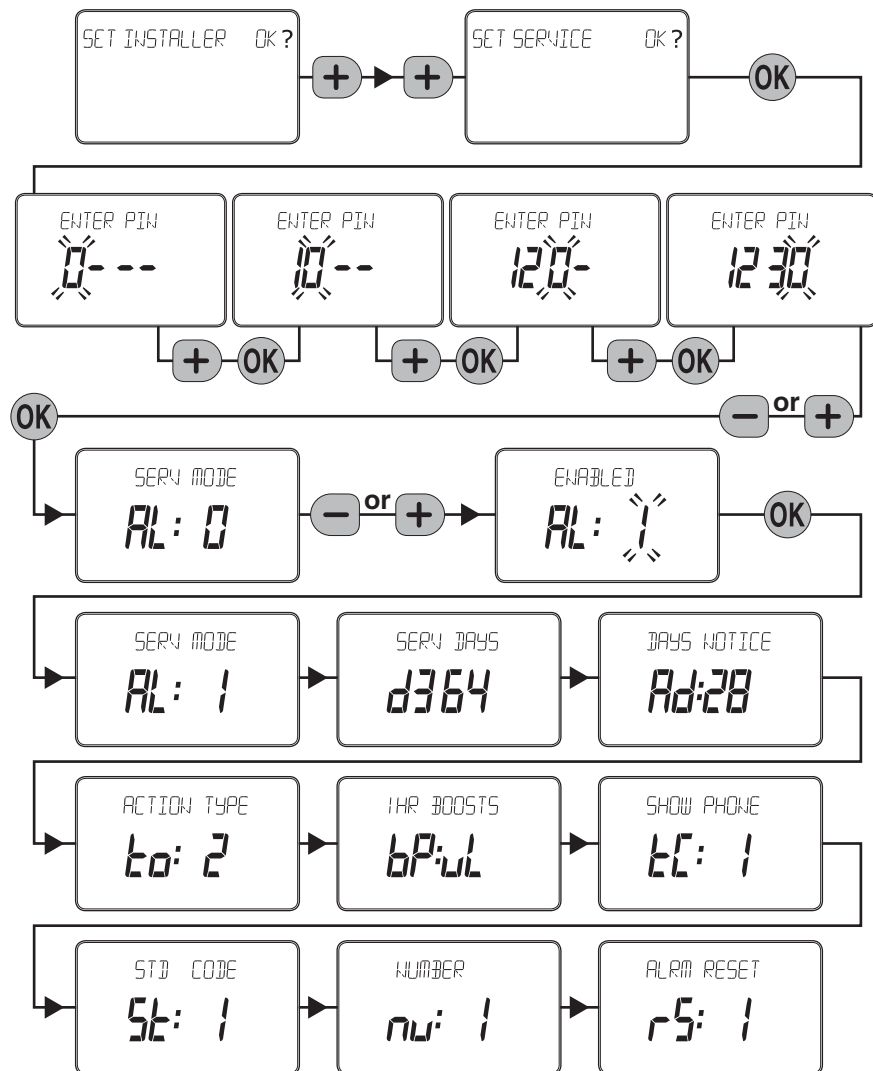

### To Exit Set Service Mode:

You can exit Set Service Mode at any time by moving the slider to the next position and then back again to **RUN**.

---

## 4.6 Change PIN

---

If you intend to change the PIN code, please ensure you take a note of the new code that you are setting.

The process for changing the current PIN code is as follows:

- Enter **Installer Modes** (as described on Page 9) and navigate to **CHANGE PIN** mode. In response to the query '**CHANGE PIN OK ?**' press the **OK** button to enter **CHANGE PIN** mode.
- The message '**ENTER PIN**' will now be displayed, along with the 4-digit entry code format **0---**. The first digit will be flashing, to indicate it can be changed. Use the **⊖** or **⊕** buttons to set the first digit, and press **OK** to confirm the digit.
- At this point the first digit will stop flashing and the second digit will proceed to flash, indicating it can be changed.
- Proceed in this way to enter the 4 digits of the old PIN code. Upon confirming the last digit, if the PIN was incorrect, the message '**INVALID**' will be displayed, and then the whole process will start again from step **b.** above.
- If the PIN was correct the message '**SET NEW PIN OK ?**' will appear. As before, use the **⊖** or **⊕** buttons to set the digits, and the **OK** button to confirm. Upon confirming the final digit, the message '**PIN SET**' will be displayed, and the new PIN code will be held on the screen for 5 seconds, to give you time to note it down.
- After setting the new PIN code, you will be taken back to the **SETUP MENU**.

---

## 4.7 What the User Will See When a Service is Due

---



If the advance warning has been configured, the screen will flash this message every few seconds, and the User should telephone to arrange a service call before the final date when the service is due.

If a telephone number has been entered using the 'SHOW PHONE' feature, this will be displayed when the advanced warning period commences.



When the boiler service is overdue the screen will keep flashing the words '**SERVICE DUE**' every second.

If the **NO ACTION** option has been selected, the unit will continue to operate as normal and the real time will continue to be shown.



If the **SWITCH OFF** or **PROMPT** Actions have been selected, the '**SERVICE DUE**' message will flash and the word "**OFF**" will appear on the display. The boiler has been switched off to ensure the safety of the User. A service appointment should be arranged immediately.



In **PROMPT** operation, the User can obtain limited use of the boiler by pressing the **EXTRA HOUR** button. Each button press will allow operation of the boiler for 1 hour at a time, and the screen will display the message '**On 1h**', as shown. A service appointment should be arranged immediately.

If a contact telephone number has been programmed into the ST9120C, a message will appear on the *LoT™ Display* indicating the number that should be called.

---

## 4.8 Resetting the Service Timer Function

---

If the Service Timer function is enabled you will be required to reset it after the boiler service has been carried out.

The process for resetting the Service Timer is as follows:

- Enter **Installer Modes** (as described on page 9) and navigate to **SET SERVICE** mode. In response to the query '**SET SERVICE OK ?**' press the **OK** button to enter **SET SERVICE** mode.
- If you no longer require the Service Timer, disable it by setting parameter **AL** to **0** and confirm with the **OK** button.
- If you still require the Service Timer, set the number of days until the next service is due using parameter **d** and confirm with the **OK** button.
- Whilst in **SET SERVICE** mode, use the opportunity to change any other service parameters if required.
- Exit by moving the slider to the next position and back again to **RUN**.

# 5 SYSTEM CONFIGURATION: DT92E

## 5.1 DT92E Installer Mode

Like ST9120C, DT92E also has an Installer Mode to enable it to be customized for the application. Each adjustable feature is called a Parameter, and is represented by a letter ID and a value on the display, as shown.

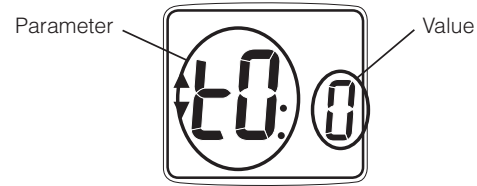

The Parameters are listed in the table below:-

INSTALLER PARAMETER	Parameter	Default Value	Range of Values	Description
Temperature measurement offset	t0	0	-3 to 3°C	Offset to measured temperature
Upper setpoint limit	uL	35	21 to 35°C	Upper set temperature limit in °C
Lower setpoint limit	LL	5	5 to 21°C	Lower set temperature limit in °C
Energy saving ECO setpoint	ES	18	5 to 35°C	Energy saving ECO set temperature in °C
Reset parameters to factory settings	FS	1	0, 1	Parameter will be set to 0 if any of the other parameter values have been changed. Set to 1 to get back to factory settings.

### To Enter Installer Mode:

- Hold the button for 2 seconds until DT92E is in standby mode
- Hold and buttons for 3 seconds until the word 'Inst' appears on the display
- Press the button

The first parameter is now ready to be changed

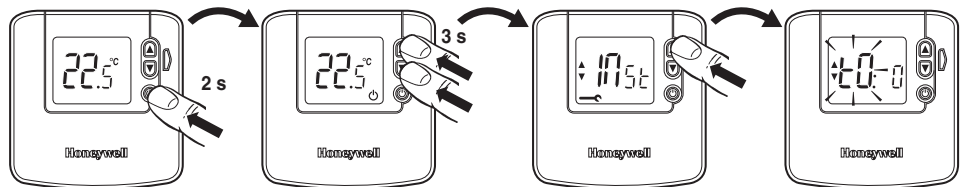

### To Select a Parameter:

Use the and buttons to move from one parameter to the next. Stop at the Parameter you wish to change.

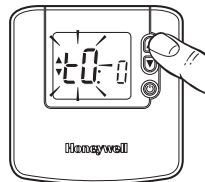

### To Change a Parameter:

Use the button to select the parameter value, then the and buttons to change the value. Confirm the change by pressing the button again to take you back to the parameter.

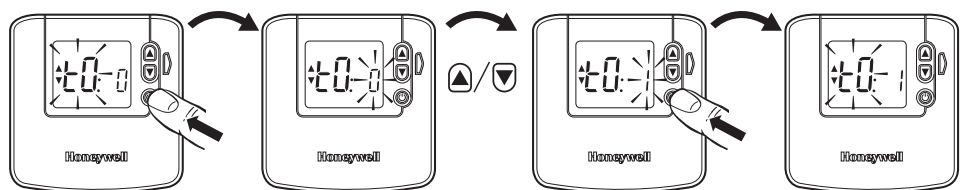

### To Exit Installer Mode:

Hold the button for 3 seconds to exit Installer Mode.

**Note:** The Installer Mode will exit automatically after 10 minutes if no adjustments have been made in this time.

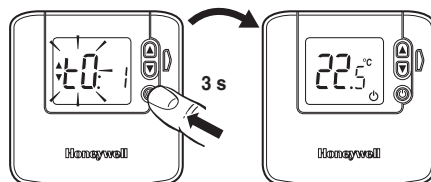

## 6 BINDING / RE-BINDING PROCEDURE



### 6.1 Binding

2-way RF devices that communicate with each other achieve this through having each others unique addresses written in their memories. This allows each device to know which other device to communicate with. The process of writing these addresses is known as Binding.

**All devices in the pack are pre-bound at the factory. The binding operation is only required if:**



- any of the system components are replaced
- pre-bound system pack components have been mismatched
- additional components are required for the application, e.g. BDR91T relay box for remote boiler application 91-3. In this case the BDR91T must be bound to the ST9120C (see section 6.6).

### 6.2 ST9120C Guided Binding Menu

The ST9120C is the communications 'hub' of the entire system, so other RF devices are bound to it and not to each other. ST9120C has a special 'Guided Binding Menu' that allows you to bind other devices to it in a logical way. Devices are bound into special 'slots' and there are rules governing what can be bound into which slot. This ensures binding errors are minimised and applications are correctly set up. When in 'Guided Binding Menu' the  and  buttons are used to navigate around.

#### Sensor binding (refer to section 6.5 for sequence of steps)

It is only possible to bind one sensor to ST9120C, in a single binding slot, but this can be either a DT92E room thermostat or a CS92A cylinder sensor.

If the display shows dashes it means there is nothing already bound in the slot. If the display shows **'bnd'** it means there is something already bound, and the icon helps identify what – a  for the DT92E and a  for the CS92A.

#### Boiler binding (refer to section 6.6 for sequence of steps)

Once a valid sensor is bound, it is then possible to bind an output device, such as a BDR91T relay box to control a boiler, typically. When this is bound, the Guided Binding Menu then allows a signal strength test to be initiated (refer to section 6.7 for sequence of steps).

#### Binding table by application

Application	Sensor Binding slot	Boiler Binding slot	Binding Required
91-1	DT92E thermostat	-- --	Supplied pre-bound
91-3	DT92E thermostat	BDR91T relay box	Bind in BDR91T

#### General Binding Notes

- To bind 2 devices together, BOTH must be put into Binding Mode.
- With both devices in binding mode, you must send the binding signal from one device to the other:
  - To bind a sensor, the signal is sent from the sensor.
  - To bind an output device, the signal is sent from the ST9120C.

### 6.3 Guidance for Replacing Devices or Changing the Application

Situation	Binding Action
1. Replacing faulty sensor	<ul style="list-style-type: none"><li>• Bind new sensor over previous binding in SENSOR slot.</li></ul>
2. Reconfiguring system by changing type of sensor (e.g. replacing DT92E with CS92A).	<ul style="list-style-type: none"><li>• Cancel existing SENSOR binding in timer.</li><li>• Cancel binding in sensor that has been removed.</li><li>• Cancel binding on BDR91T before reconfiguration.</li><li>• Reconfigure binding, starting with new sensor first.</li></ul>
3. Replacing faulty BDR91T	<ul style="list-style-type: none"><li>• Bind new BDR91T over previous BDR91T in BOILER slot and remove faulty BDR91T from system.</li></ul>
4. Reconfiguring system by adding or removing BDR91T	<ul style="list-style-type: none"><li>• If removing BDR91T, cancel binding in that BOILER slot.</li><li>• If adding BDR91T, bind into vacant BOILER slot.</li></ul>



## 6.4 Binding Menu Display

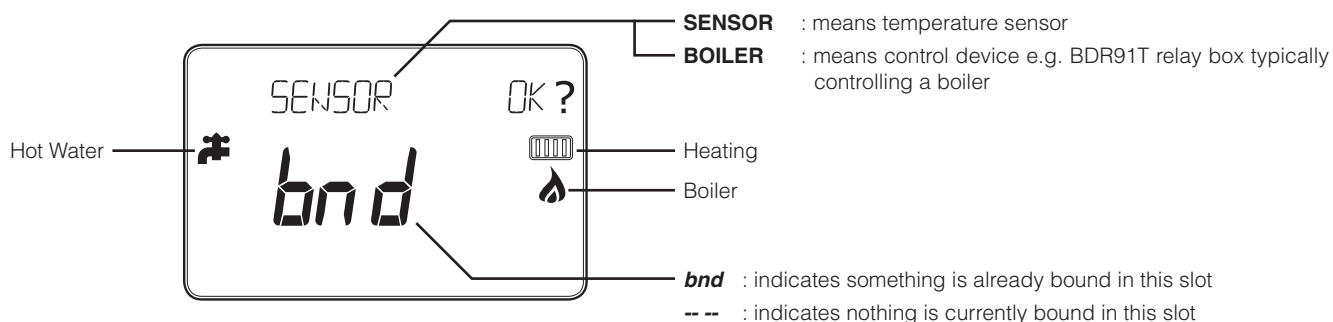

## 6.5 How to Bind DT92E to ST9120C

- Ensure the ST9120C slider is in the **RUN** position, then press and hold  $\ominus$ ,  $\omin�$ ,  $\oplus$  and **MODE** buttons for 8 seconds to access the Guided Binding Menu. The message **'BIND MENU'** will show briefly, followed by the binding display.
- Refer to the table in Section 6.3 to determine whether you require to cancel any binding. If the display shows dashes it means there is nothing already bound in the slot. If the display shows **'bnd'** it means there is something already bound. When in 'Guided Binding Menu' the  $\omin�$  and  $\oplus$  buttons are used to navigate around.
- Any existing binding can be cancelled by holding the  $\oplus$  button for 8 seconds and the *LoT™ Display* will say **'RESET'** for a few seconds.
- Press the  $\oplus$  button on ST9120C to put it into binding mode, ready to receive the binding message from the sensor. The display will flash and the message **'BINDING'** will be shown to indicate ST9120C is waiting for this message.
- Now bring DT92E (or its front section, minus mounting plate) to approximately 1 metre from ST9120C.
- Put DT92E into binding mode as shown.
  - Press and hold the  $\oplus$  button for 2 seconds
  - Hold the  $\uparrow$  and  $\downarrow$  buttons for 3 seconds until display shows **'Inst'**
  - Press the  $\downarrow$  button and the display shows **'Cont'**

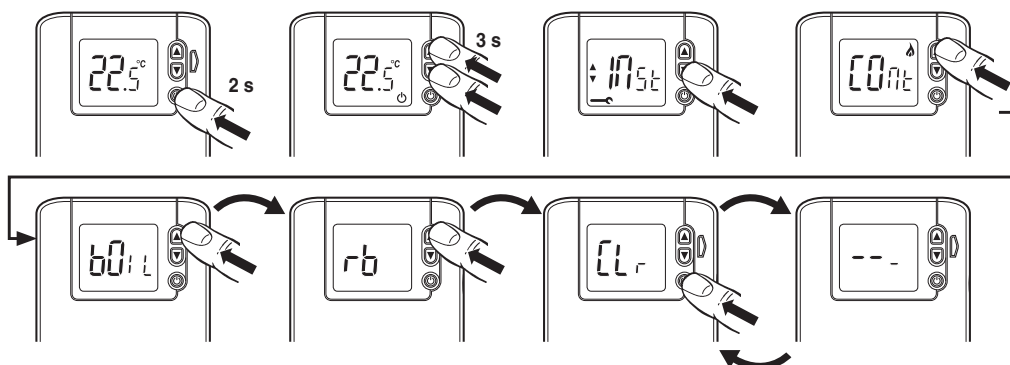

- If you do not need to cancel existing binding in DT92E (see section 6.3) skip this step and go straight to step h.
  - Keep pressing the  $\uparrow$  button until the display shows **'CLR'**
  - Press the  $\oplus$  button to clear existing binding data
  - Now put DT92E into binding mode by pressing the  $\uparrow$  button again. The display will show **'Cont'**.

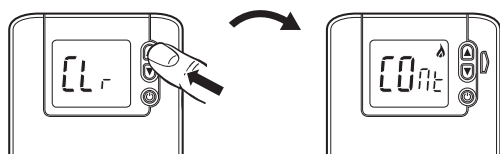

- Press the  $\oplus$  button on DT92E to send the binding message to ST9120C. If binding was successful DT92E will exit binding mode, and will show **'SYnc'** on its display for up to 4 minutes, as communication and synchronisation are established. The ST9120C display will stop flashing, **'bnd'** will be shown, and the *LoT™ Display* will say **'COMPLETE'** for a few seconds.
- If binding was unsuccessful, repeat step h. If this fails, repeat steps e. to h. again. If binding was successful, proceed to step j.
- Exit Guided Binding Menu by moving the ST9120C slider to the next position and then back again to **RUN** (it will exit automatically after 10 minutes if the slider is not moved).
- Now go to section 2.3 to verify communication by using the Signal Strength check.

## 6.6 How to Bind BDR91T to ST9120C

**NOTE:** It is only possible to bind a BDR91T if a sensor (DT92E or CS92A) has already been bound to the SENSOR slot in ST9120C.

- Ensure the ST9120C slider is in the **RUN** position, then press and hold  $\ominus$ ,  $\oplus$  and **MODE** buttons for 8 seconds to access the Guided Binding Menu. The message **'BIND MENU'** will show briefly, followed by the binding display.
- Refer to the table in Section 6.3 to determine whether you require to cancel any binding. The SENSOR binding slot will be displayed first. Use the  $\ominus$  and  $\oplus$  buttons to navigate to the BOILER binding slot, where **'BOILER'** will appear on the display. If the display shows dashes it means there is nothing already bound in the slot. If the display shows 'bnd' it means there is something already bound.
- Any existing binding can be cancelled by holding the  $\text{OK}$  button for 8 seconds and the *LoT™ Display* will say **'RESET'** for a few seconds.
- Now go to the BDR91T. If you need to cancel any previous binding in BDR91T, hold the button down for 15 seconds. The red light will give a quick flash every second. Otherwise go to step f.

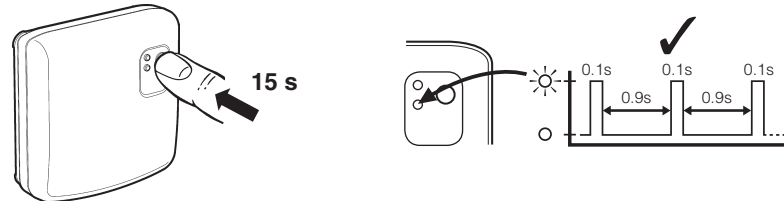

- Hold the BDR91T button for 5 seconds until the red light flashes on for 0.5s, off for 0.5s. The BDR91T is now in binding mode awaiting the binding message from ST9120C.

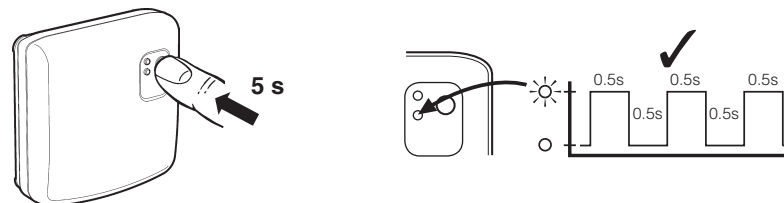

- Now press the  $\text{OK}$  button on ST9120C to send the binding signal to the BDR91T. If binding was successful the ST9120C display will stop flashing, **'bnd'** will be shown, and the *LoT™ Display* will say **'COMPLETE'** for a few seconds. The flashing red light on BDR91T will also go off.

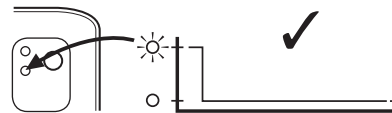

- If binding was unsuccessful, repeat step f again. If binding was successful, proceed to step h.
- Exit Guided Binding Menu by moving the ST9120C slider to the next position and then back again to **RUN** (it will exit automatically after 10 minutes if the slider is not moved).
- Now go to section 6.7 to verify communication by using the Signal Strength check.

## 6.7 How to Test BDR91T Signal Strength

Honeywell 2-way RF  $\text{LoT}^{\text{TM}}$  communications allows signal strength testing to verify BDR91T is positioned in the best possible location.

- Enter ST9120C Guided Binding Menu (ensure the slider is in the **RUN** position, then press and hold  $\ominus$ ,  $\oplus$  and **MODE** buttons for 8 seconds. The message **'BIND MENU'** will show briefly, followed by the binding display).
- Navigate to the Signal Strength Test screen by pressing the  $\oplus$  button until the message **'SIGNAL TST OK?'** appears on the display.
- Press the  $\text{OK}$  button to activate the test. The ST9120C will show **'SIGNAL TST'** and flash **'SS'** on the display.

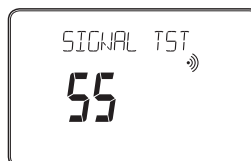

- Go to the BDR91T where the red light will flash several times quickly in succession, repeating every 5 seconds. The number of flashes in each burst will be between 0 and 5, with 5 representing a strong signal and 0 a weak one.
- If the signal strength is less than 3, re-position the BDR91T within the local area +/- 1 or 2m to see if the signal strength improves.
- Signal Strength Test is cancelled by pressing the  $\ominus$  or  $\oplus$  buttons on ST9120C or by moving the slider to exit the Guided Binding Menu.



---

---

# 7 COMMISSIONING THE SYSTEM

## 7.1 System Test Checklist

1	Check ST9120C has powered up correctly and the display is not blank. Now set the operating mode to <b>AUTO</b> .	<input type="checkbox"/>
2	Check DT92E has powered up correctly and the display is not blank.	<input type="checkbox"/>
3	Configure DT92E as required (see Section 5 for how to do this). Remember to make a note of any changes in the Configuration Data section of the User Guide.	<input type="checkbox"/>
4	Change the temperature setpoint on DT92E to 35°C by pressing the ▲ button. (If DT92E is currently off, hold the Ⓞ button for 2 seconds to take it back to run mode).	<input type="checkbox"/>
5	Now go to ST9120C. With the operating mode set to <b>AUTO</b> , switch on and off using the <b>OVERRIDE</b> button, to ensure the system is operating correctly.	<input type="checkbox"/>
6	If a BDR91T relay box has been installed (application 91-3), verify it is switching the relay on and off in response to manual operation of the ST9120C <b>OVERRIDE</b> button. The relay status is indicated by the green light on the BDR91T.	<input type="checkbox"/>
7	Check the factory-set day, date, and time are correct and adjust if necessary. Refer to User Guide for details.	<input type="checkbox"/>
8	If required, enter Installer Setup Mode (page 10) and adjust Installer Parameters to match the application, as well as the lifestyle and needs of the User. Remember to make a note of these parameter changes in the Configuration Data section of the User Guide.	<input type="checkbox"/>
9	If required, enter Set Service Mode and enable the Boiler Service Reminder, and set the appropriate Service parameters.	<input type="checkbox"/>
10	Set the DT92E to the temperature required by the User (20°C is recommended).	<input type="checkbox"/>

## 7.2 Completion Checklist

1	Explain the operation of the products to the User, and help them to set their programme. ST9120C has 3 built-in profiles that can be used as a basis for typical User programmes.	<input type="checkbox"/>
2	Explain when the User should contact someone to arrange a Service Visit, and what you have programmed to happen when the Service is overdue.	<input type="checkbox"/>
3	If required, attach the self-adhesive programme guide label to the underside of the ST9120C cover flap. The label is supplied in the box.	<input type="checkbox"/>
4	Write the date of installation, your name and telephone number in the space provided in the User Guide, in the section 'Boiler & System Service Log'.	<input type="checkbox"/>
5	Remember to leave the User Guide and Installation Instructions with the User and remind them to keep them in a safe place. This forms part of a Home Information Pack.	<input type="checkbox"/>

This product and its associated documentation and packaging are protected by various intellectual property rights belonging to Honeywell Inc and its subsidiaries and existing under the laws of the UK and other countries. These intellectual and property rights may include patent applications, registered designs, unregistered designs, registered trade marks, unregistered trade marks and copyrights.

Honeywell reserves the right to modify this document, product and functionality without notice. This document replaces any previously issued instructions and is only applicable to the product(s) described.

This product has been designed for applications as described within this document. For use outside of the scope as described herein, refer to Honeywell for guidance. Honeywell cannot be held responsible for misapplication of the product(s) described within this document.

Manufactured for and on behalf of the Environmental and Combustion Controls Division of Honeywell Technologies Sàrl, ACS-ECC EMEA, Z.A. La Pièce 16, 1180 Rolle, Switzerland, by its Authorised Representative Honeywell Inc.

### Honeywell Control Systems Ltd.

Arlington Business Park,

Bracknell, Berkshire

RG12 1EB

Technical Help Desk: 08457 678999

www.honeywelluk.com



50047644-005 A  
© 2011 Honeywell International Inc.

# Honeywell