



Point of Purchase Extrusions

Retail Displays
Sign & Literature Holders
Data Strips & Label Holders
Shelf Edging, Shelf Caps & Shelf Talkers
Ceiling Displays & Banner Hangers
Display & Product Merchandising Profiles
Custom Shapes
Lighting Lenses





... have an idea???

Email, fax, courier, snail mail or call us! Let us take a look and we can respond quickly with an experienced team that knows the POP industry. Intek Plastics can provide Idea's that will bring your project to market faster and with the most cost effective solution. Push your cart through any retail store and Intek's parts are everywhere. From apples to appliances, batteries to bubbly, cosmetics to cameras and beyond, we support the display companies that create these environments.

Who we are

Intek is a plastic extrusion company established in 1961 with over 22 years experience serving the POP industry. In addition, we also serve OEM's in: building and construction, refrigeration, recreation, telecommunications, lighting and transportation. This broad range of experience gives us the unique ability to provide design assistance for parts within the context and goals of your project. Simply put, we can become an extension of your design team.



Capabilities

- Custom Profiles
- Thousands of Stock Dies
- Co & Tri Extrusion Capability
- In-House Manufacturing
- Design Expertise
- Huge Material Selection
- Color Matching
- Fabrication
- Quick Turn
- Heart of P.O.P. Hub (NYC Area)

Intek POP Idea Book shows *CAPABILITIES* and a limited representation of common parts available. If you need a little tweak here or there, no problem, just let us know! Please call for availability, a competitive quote and lead time. Minimum orders starting at \$1500.00. **Drawings are not to scale.**

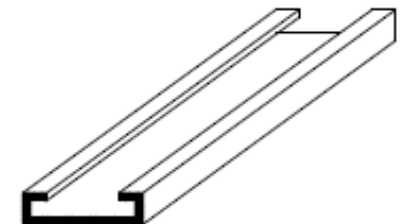
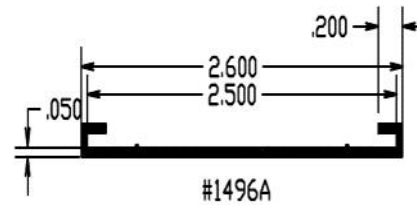
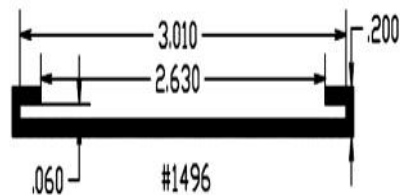
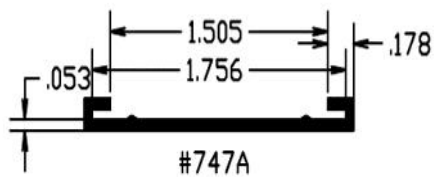
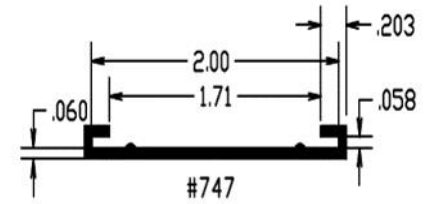
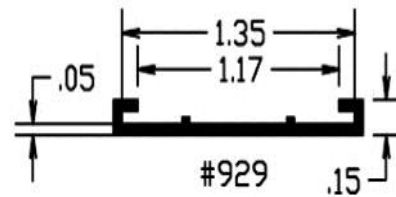
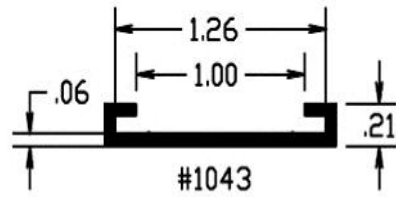
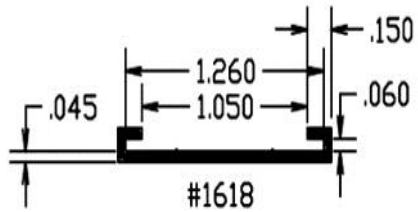
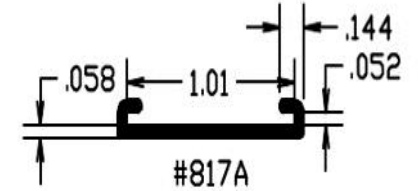
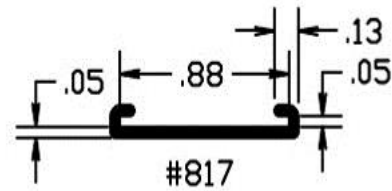
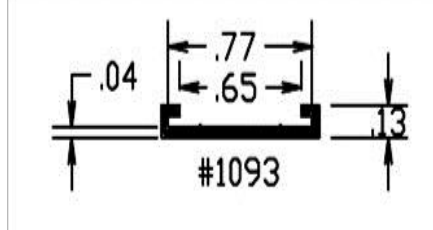
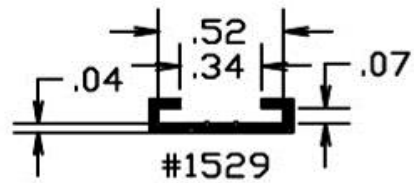

Table of Contents

<u>C Channels</u>	1-3
<u>H Channels</u>	4
<u>J Channels</u>	5-6
<u>L Channels</u>	7-8
<u>U Channels</u>	9-11
<u>Specialty Channels</u>	12-13
<u>S Clips / Corrugated</u>	14
<u>Snap Frames</u>	15
<u>Ticket Channel / Data Strips</u>	16-17
<u>Tubes</u>	18
<u>Slatwall</u>	19



C-Channels



C Channels

C Channels easily attach to shelving, fixtures and displays to create changeable custom signing. When viewed from the side, resembles the letter "C". These can be designed to meet your specific needs, including pre-assembled with a foam tape for easy attachment.

P.O.P. Division
150 5th Ave.
Hawthorne, NJ 07507
973.427.7331

HQ
1000 Spiral Blvd
Hastings, MN 55033
800.451.4544
intekplastics.com



C-Channels

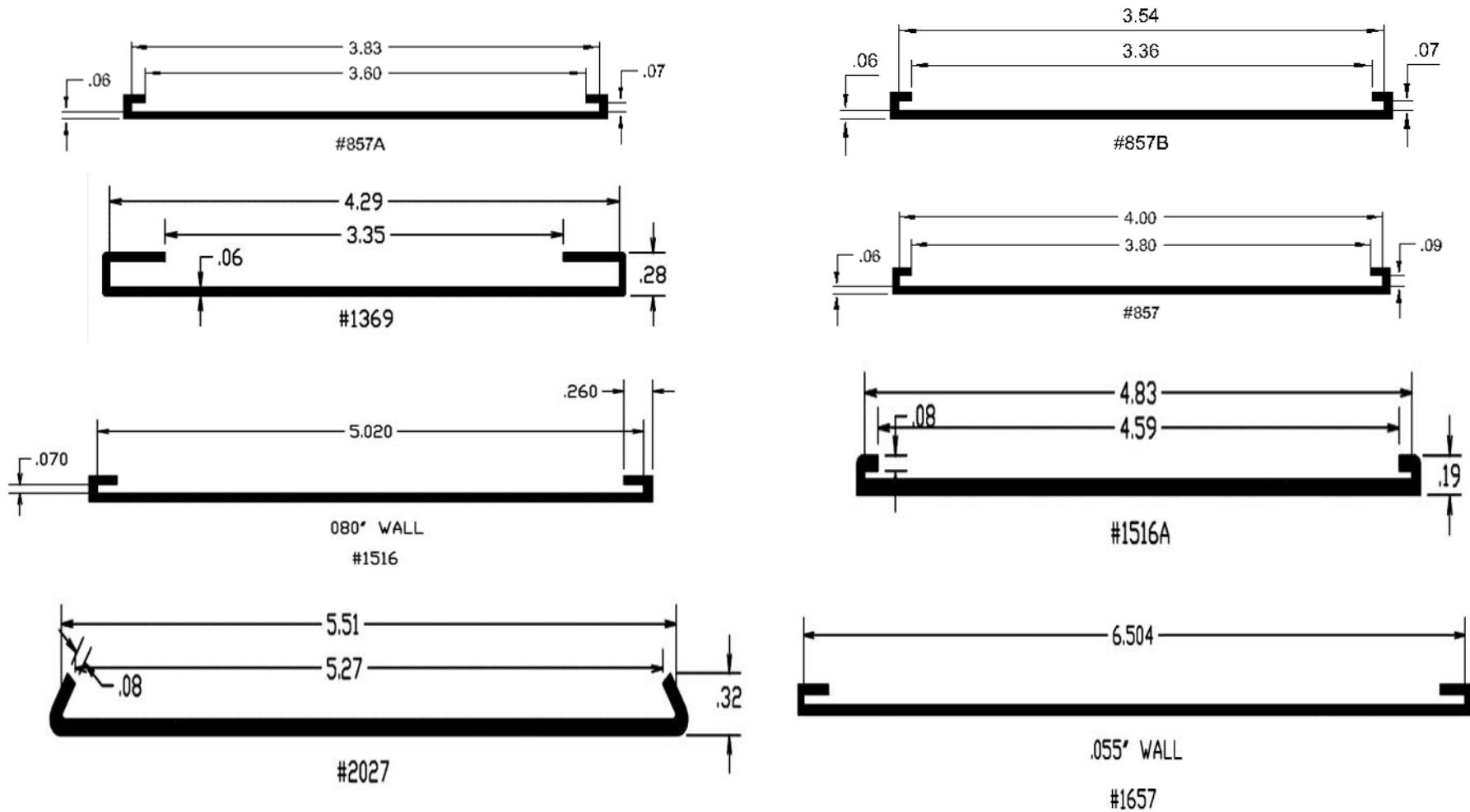

C Channels

C Channels easily attach to shelving, fixtures and displays to create changeable custom signing. When viewed from the side, resembles the letter "C". These can be designed to meet your specific needs, including pre-assembled with a foam tape for easy attachment.

P.O.P. Division
 150 5th Ave.
 Hawthorne, NJ 07507
 973.427.7331

HQ
 1000 Spiral Blvd
 Hastings, MN 55033
 800.451.4544
 intekplastics.com



C-Channels

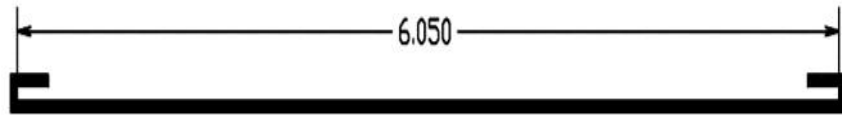

.050" WALL
#1657A

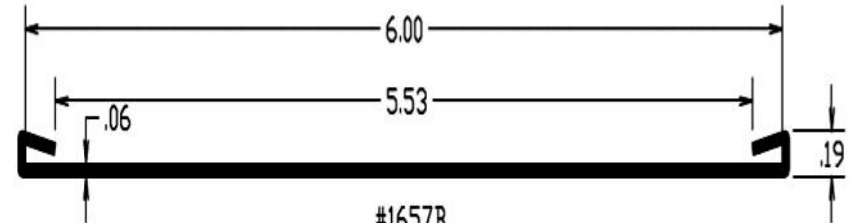

#1657B

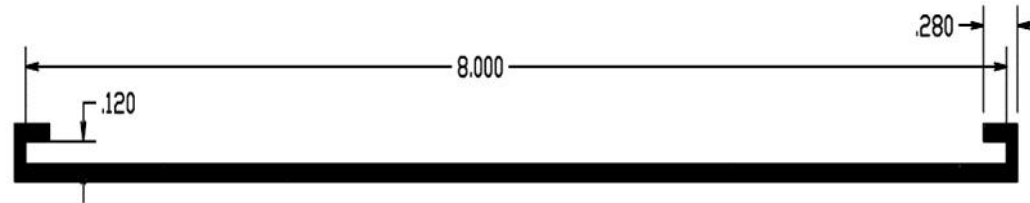

.090" WALL
#113

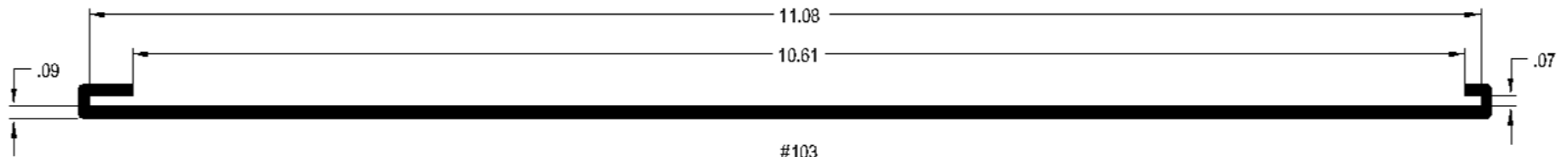

#103

C Channels

C Channels easily attach to shelving, fixtures and displays to create changeable custom signing. When viewed from the side, resembles the letter "C". These can be designed to meet your specific needs, including pre-assembled with a foam tape for easy attachment.

P.O.P. Division
150 5th Ave.
Hawthorne, NJ 07507
973.427.7331

HQ
1000 Spiral Blvd
Hastings, MN 55033
800.451.4544
intekplastics.com



H-Channels

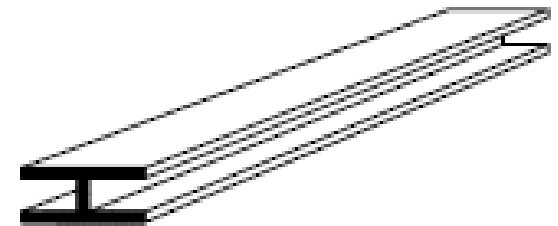
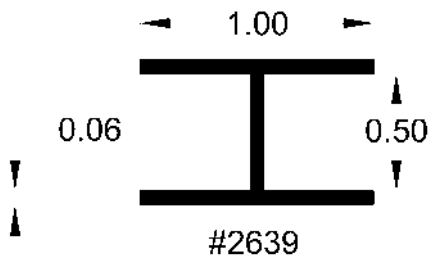
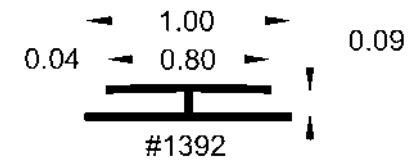
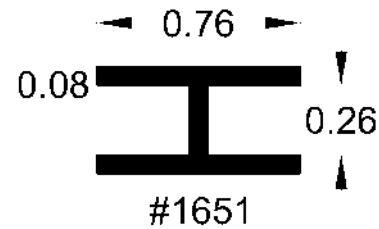
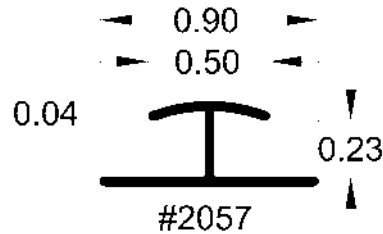
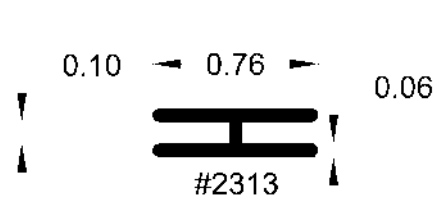
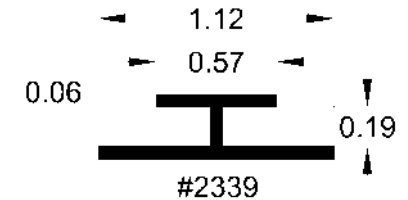
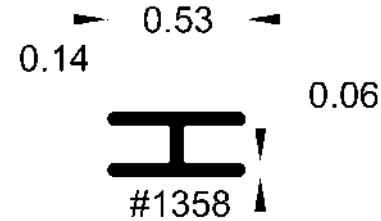
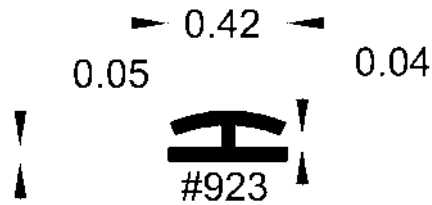
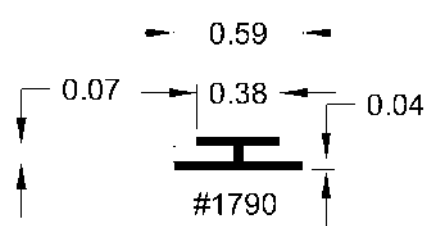

H Channels

H Channels are used as a joining strip to attach other extrusions or sign inserts to create custom signage. H channels can be used to separate, connect or mate two parts together. H Channels can also be used in conjunction with J channels to mount signs. Intek can create the right combination of H and J Channels to meet your specific needs.

P.O.P. Division
150 5th Ave.
Hawthorne, NJ 07507
973.427.7331

HQ
1000 Spiral Blvd
Hastings, MN 55033
800.451.4544
intekplastics.com



J-Channels

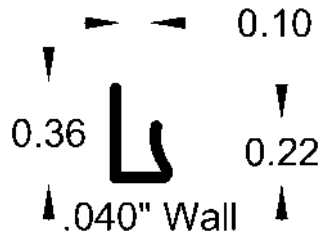

#1029

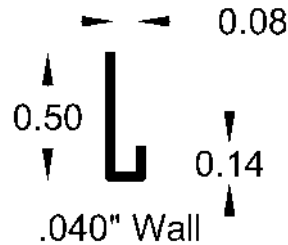

#2384

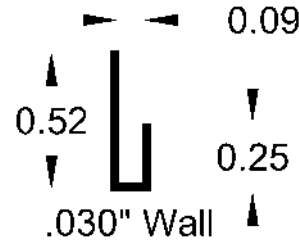

#812

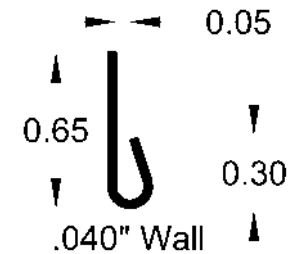

#920

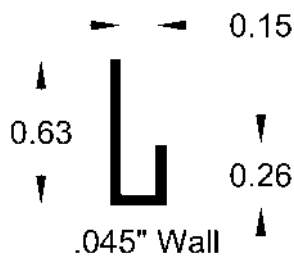

#684

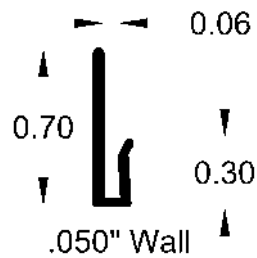

#2176

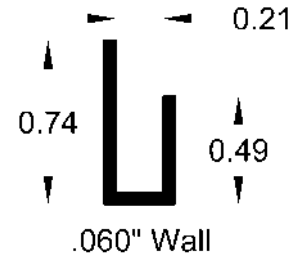

#1063A

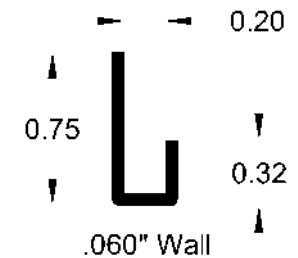

#2340

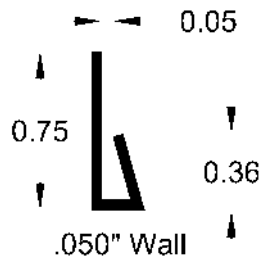

#724

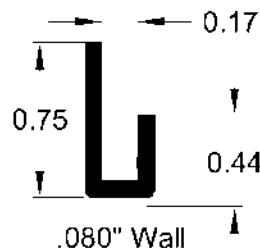

#2446

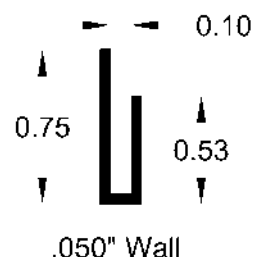

#1154

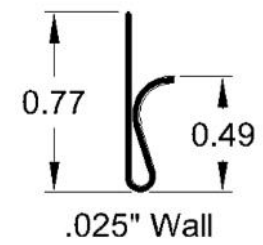

#1398

J Channels

J Channels present a “finished” edge in combination with other extruded elements to create custom POP signage. J Channels have many uses including holding displays, used as edging, and creating custom sized channels for repeat use. They can also be used in conjunction with H-Channels to create multiple signs.

P.O.P. Division
150 5th Ave.
Hawthorne, NJ 07507
973.427.7331

HQ
1000 Spiral Blvd
Hastings, MN 55033
800.451.4544
intekplastics.com



J-Channels

6

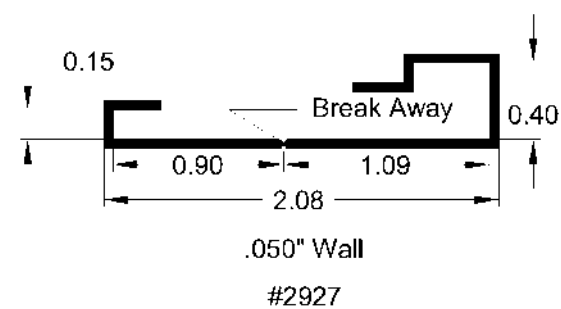
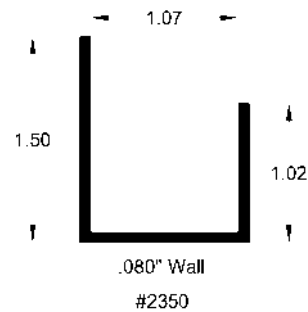
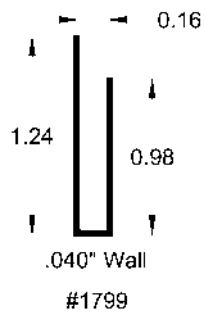
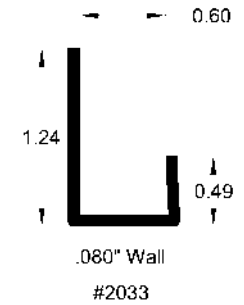
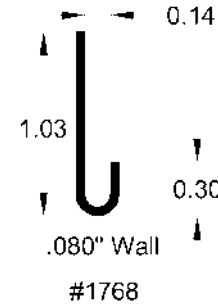
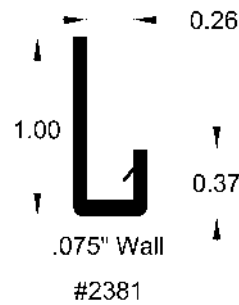
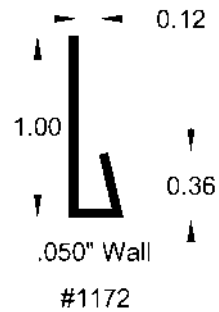
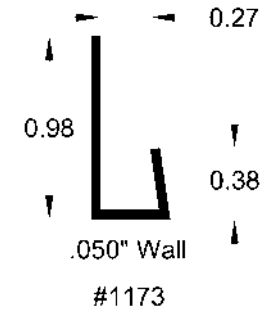
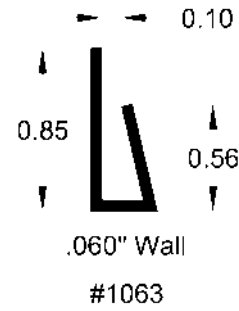
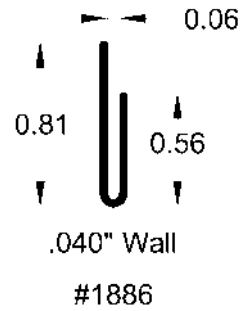
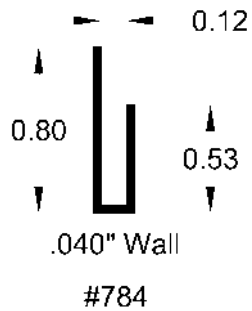

J Channels

J Channels present a "finished" edge in combination with other extruded elements to create custom POP signage. J Channels have many uses including holding displays, used as edging, and creating custom sized channels for repeat use. They can also be used in conjunction with H-Channels to create multiple signs.

P.O.P. Division
150 5th Ave.
Hawthorne, NJ 07507
973.427.7331

HQ
1000 Spiral Blvd
Hastings, MN 55033
800.451.4544
intekplastics.com



L-Channels

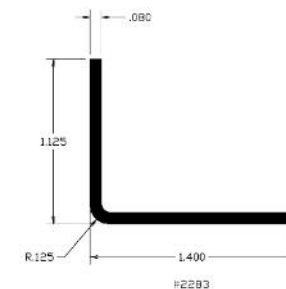
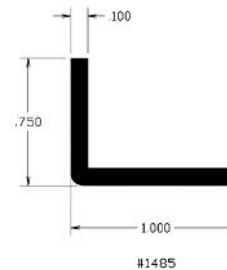
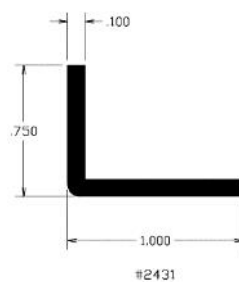
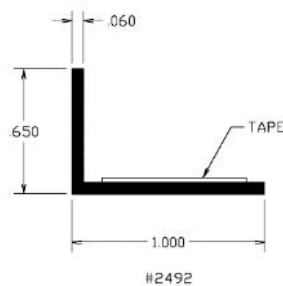
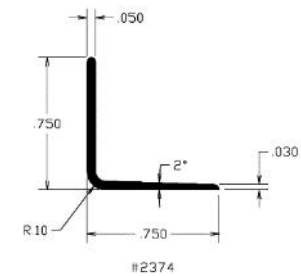
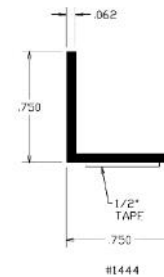
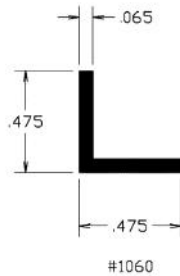
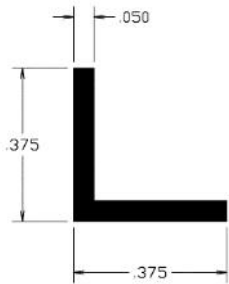

L Channels

L Channels can be mounted to shelves to keep parts and product from falling off store shelves. They can also be used to protect corners or for other protection purposes. These can be designed to meet your specific needs including pre-assembled with adhesive tape for easy attachment or with holes drilled for easy mounting.

P.O.P. Division
150 5th Ave.
Hawthorne, NJ 07507
973.427.7331

HQ
1000 Spiral Blvd
Hastings, MN 55033
800.451.4544
intekplastics.com



L-Channels

8

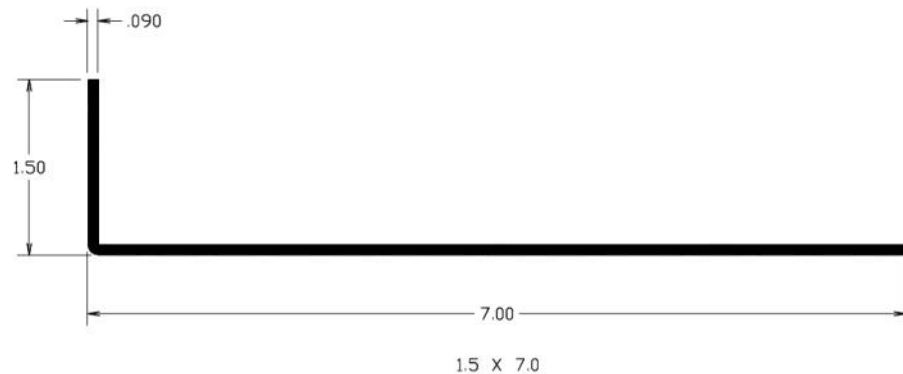
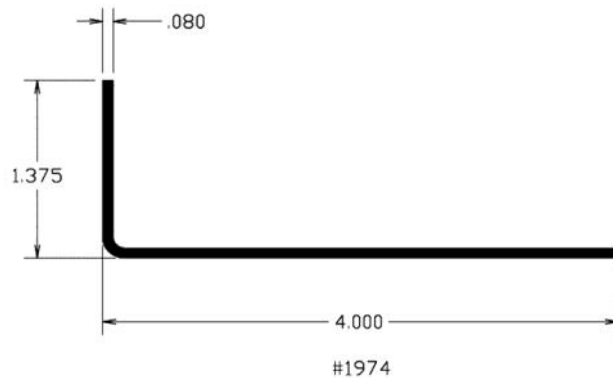
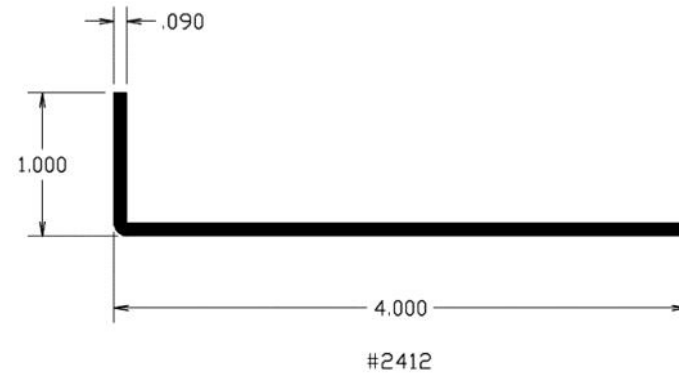
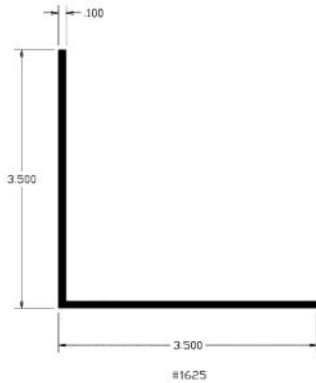

L Channels

L Channels can be mounted to shelves to keep parts and product from falling off store shelves. They can also be used to protect corners or for other protection purposes. These can be designed to meet your specific needs including pre-assembled with adhesive tape for easy attachment or with holes drilled for easy mounting.

P.O.P. Division
150 5th Ave.
Hawthorne, NJ 07507
973.427.7331

HQ
1000 Spiral Blvd
Hastings, MN 55033
800.451.4544
intekplastics.com



U-Channels

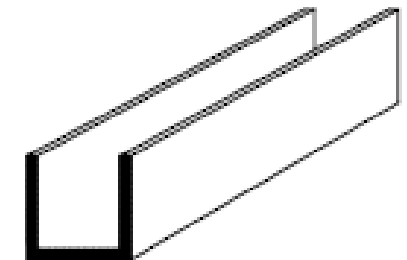
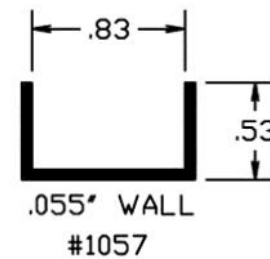
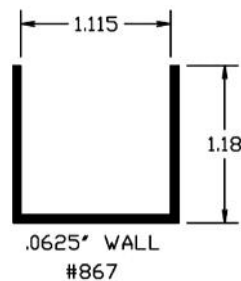
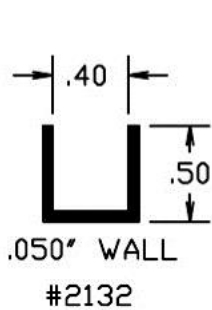
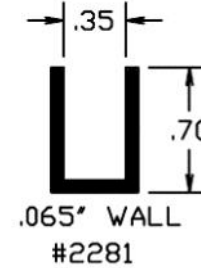
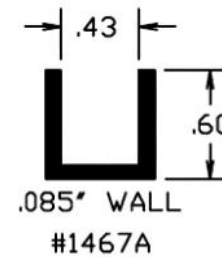
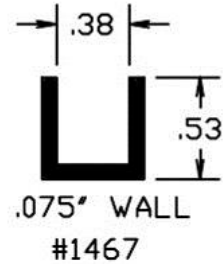
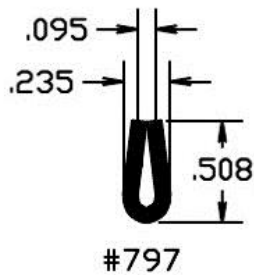
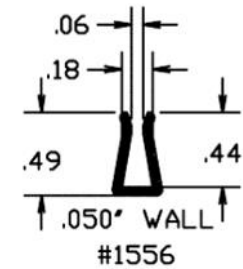
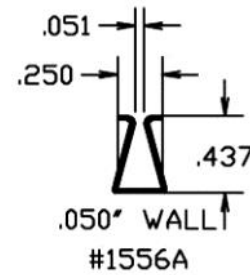
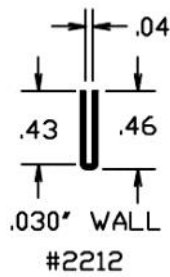
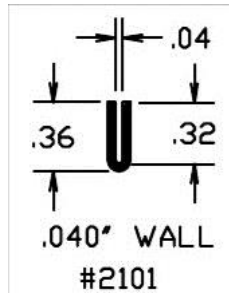

U Channels

U Channels are used for quick and easy fabrication of custom signage, edge protectors, and are often combined with other extruded elements for POP signage. They can be used to attach display signs to shelves or walls, as a protective border around signs, or to mate mirrored parts. These can be designed to meet your specific needs including pre-assembled with a foam tape for easy attachment.

P.O.P. Division
150 5th Ave.
Hawthorne, NJ 07507
973.427.7331

HQ
1000 Spiral Blvd
Hastings, MN 55033
800.451.4544
intekplastics.com



U-Channels

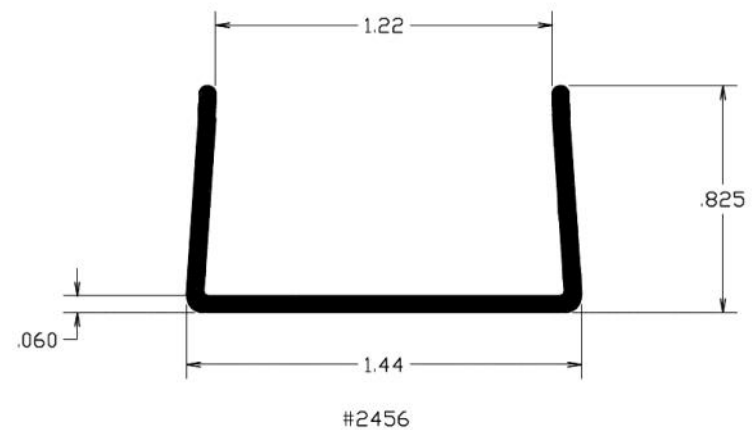
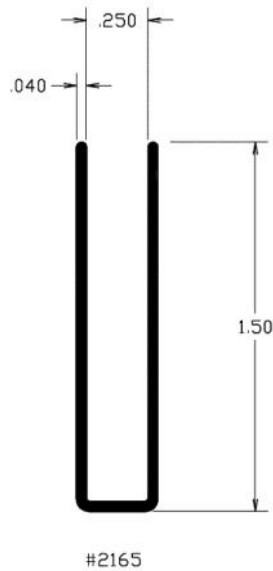
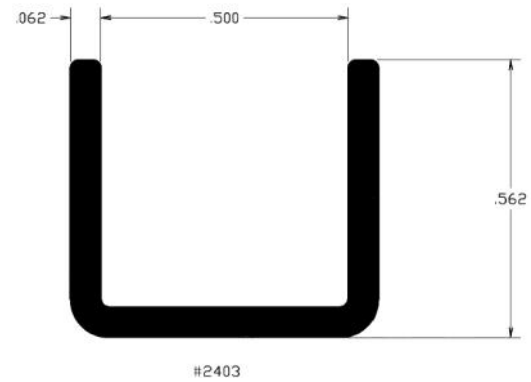
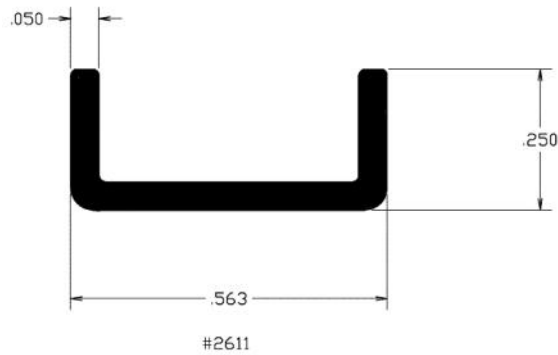

U Channels

U Channels are used for quick and easy fabrication of custom signage, edge protectors, and are often combined with other extruded elements for POP signage. U channels can be used to attach display signs to shelves or walls, as a protective border around signs, or to mate mirrored parts. These can be designed to meet your specific needs including pre-assembled with a foam tape for easy attachment.

P.O.P. Division
150 5th Ave.
Hawthorne, NJ 07507
973.427.7331

HQ
1000 Spiral Blvd
Hastings, MN 55033
800.451.4544
intekplastics.com



U-Channels

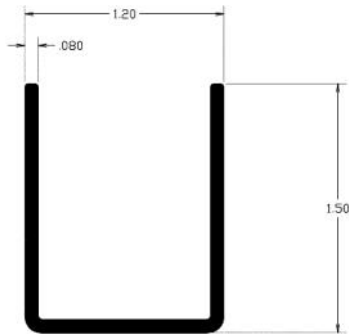

1.2 X 1.5

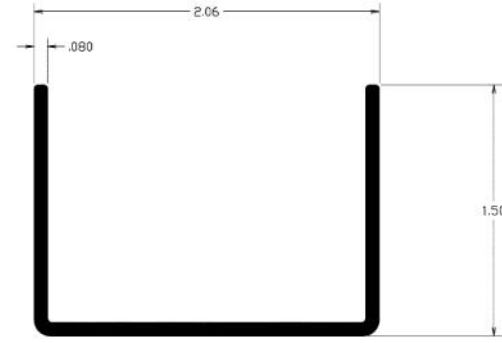

#2559

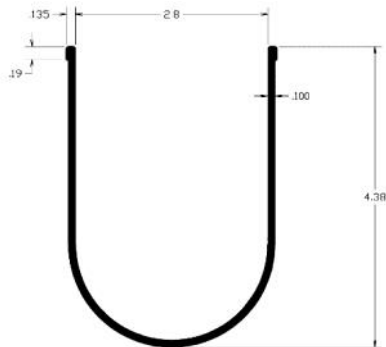

#2727

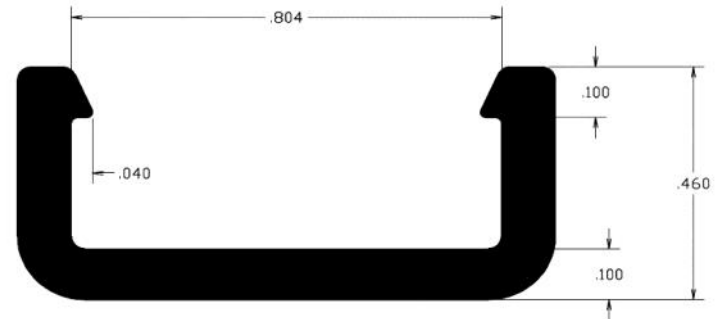

#1931

U Channels

U Channels are used for quick and easy fabrication of custom signage, edge protectors, and are often combined with other extruded elements for POP signage. U channels can be used to attach display signs to shelves or walls, as a protective border around signs, or to mate mirrored parts. These can be designed to meet your specific needs including pre-assembled with a foam tape for easy attachment.

P.O.P. Division
150 5th Ave.
Hawthorne, NJ 07507
973.427.7331

HQ
1000 Spiral Blvd
Hastings, MN 55033
800.451.4544
intekplastics.com



Specialty Channels

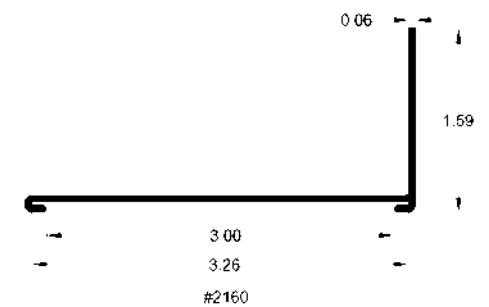
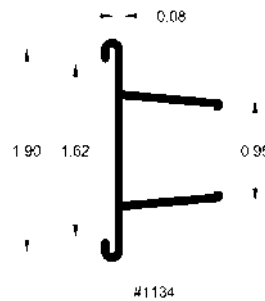
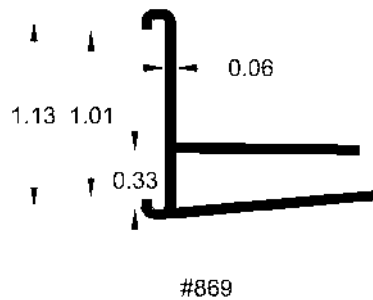
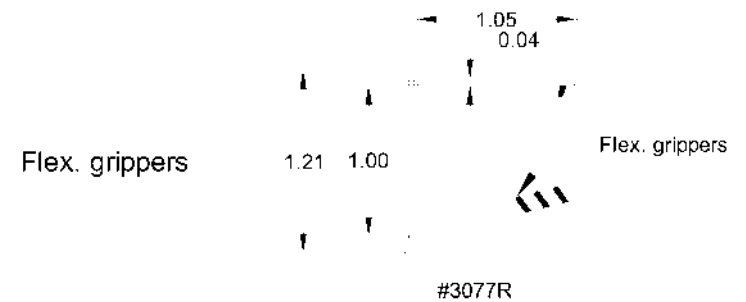
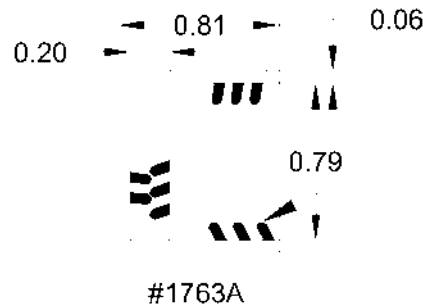
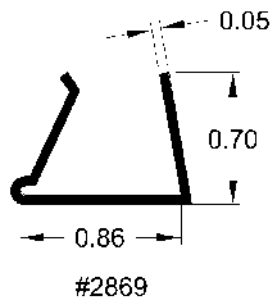
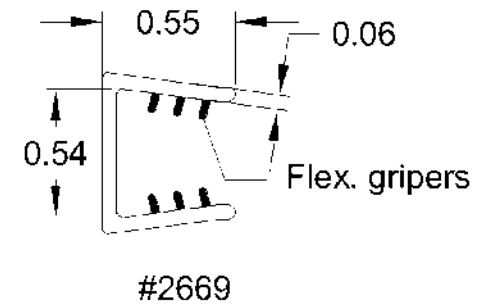
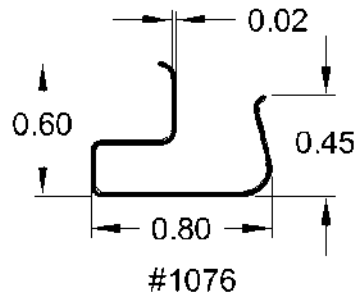
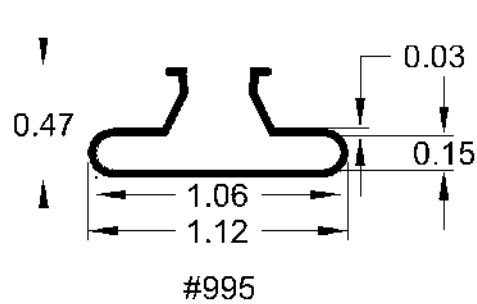

Specialty Channels

Specialty channels are your design or ours. These channels are designed for custom applications most time using co-extrusion or tri-extrusion dies. These channels are usually used where the application calls out for using various materials that need to be held by one profile. Remember, your design or ours, we will extrude a profile that is perfect for your application.

P.O.P. Division
150 5th Ave.
Hawthorne, NJ 07507
973.427.7331

HQ
1000 Spiral Blvd
Hastings, MN 55033
800.451.4544
intekplastics.com



Specialty Channels

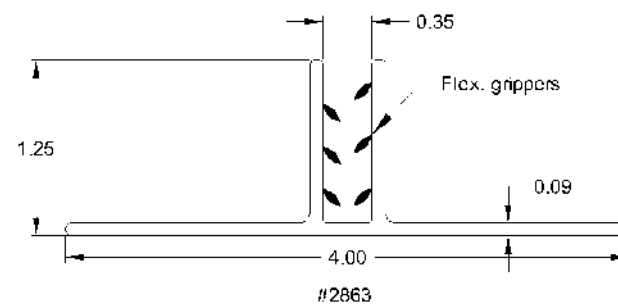
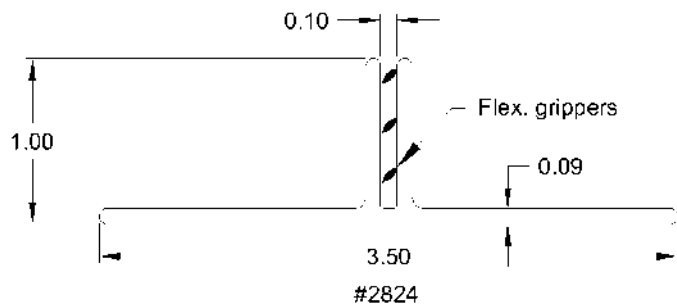
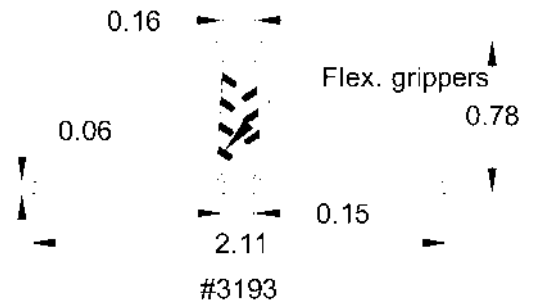
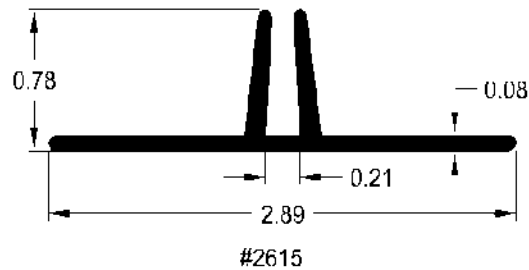
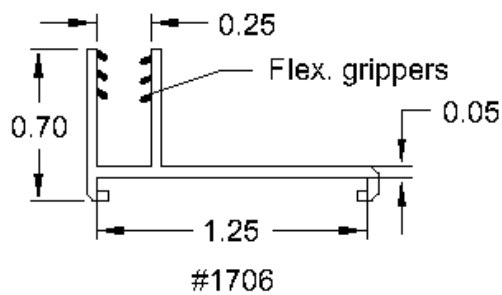
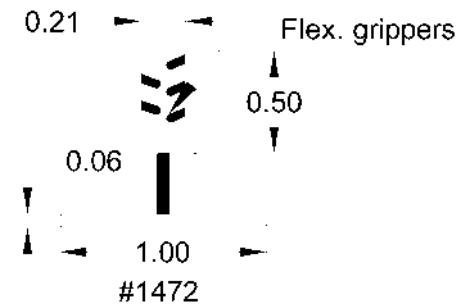
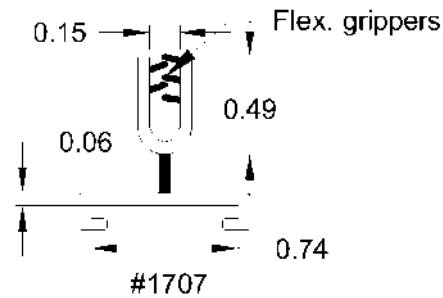
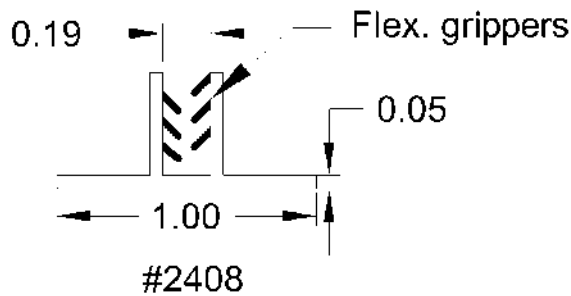

Specialty Channels

Specialty channels are your design or ours. These channels are designed for custom applications most time using co-extrusion or tri-extrusion dies. These channels are usually used where the application calls out for using various materials that need to be held by one profile. Remember, your design or ours, we will extrude a profile that is perfect for your application.

P.O.P. Division
150 5th Ave.
Hawthorne, NJ 07507
973.427.7331

HQ
1000 Spiral Blvd
Hastings, MN 55033
800.451.4544
intekplastics.com



S-Clips/Corrugated

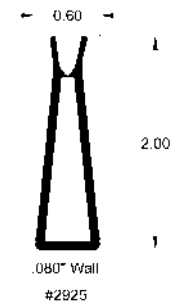
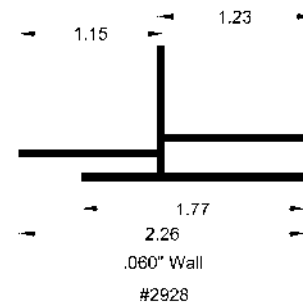
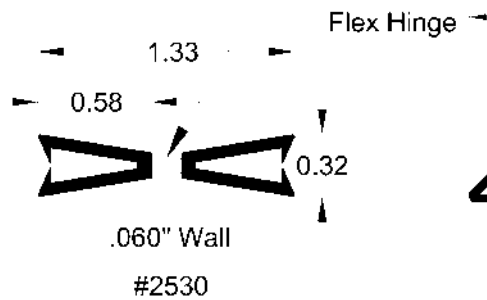
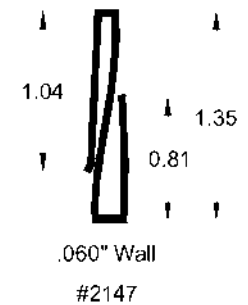
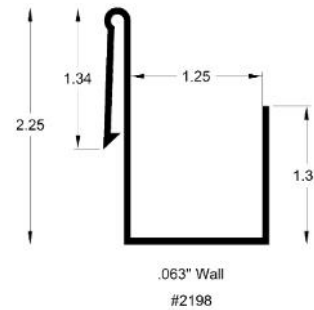
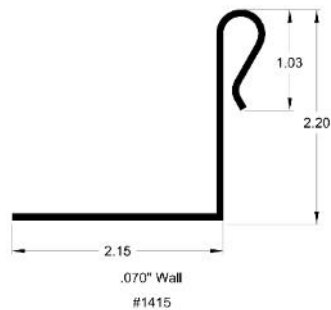
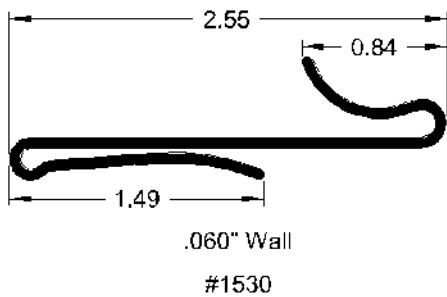
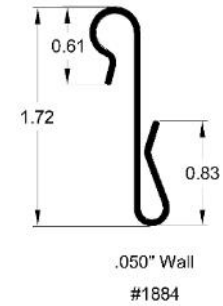
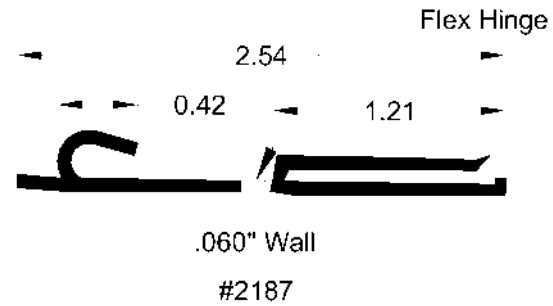
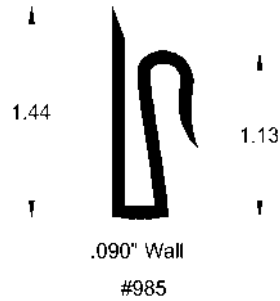
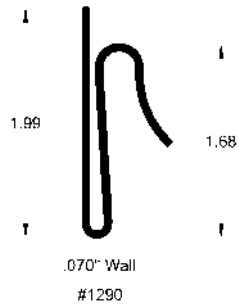

S-Clips / Corrugated

S Clips come in many shapes and sizes to meet various needs including corrugated sidekicks, power panels or power bars to wire wings. Intek can design an S Clip to meet your specific needs.

P.O.P. Division
 150 5th Ave.
 Hawthorne, NJ 07507
 973.427.7331

HQ
 1000 Spiral Blvd
 Hastings, MN 55033
 800.451.4544
 intekplastics.com



Snap Frames

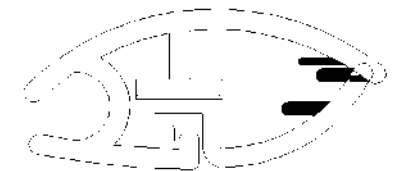
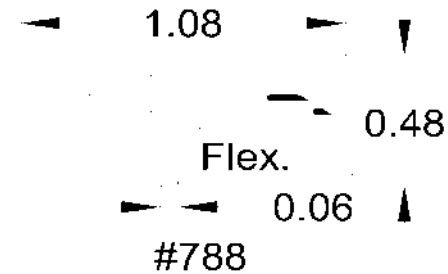
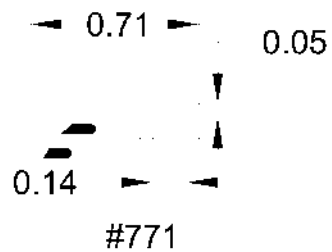
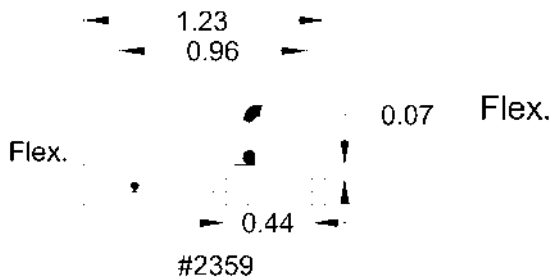
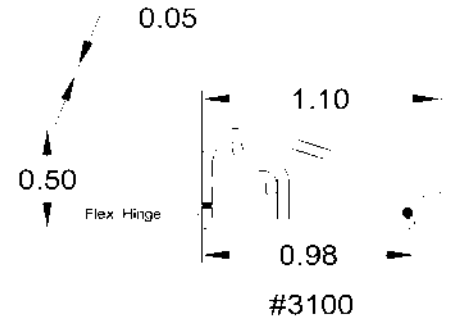
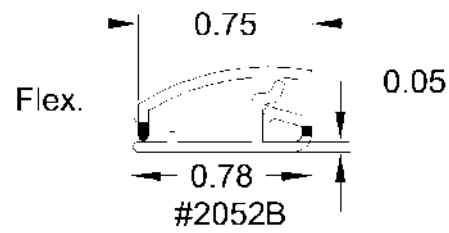
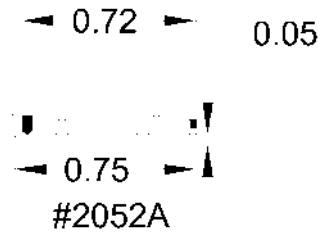
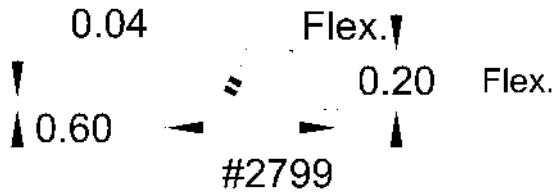

#771 with #788

Snap Frames

Our Snap Frames are the perfect solution for hanging banners, aisle ID signs, in-store posters or framing your brand identity signs, store hours and policies. These handsome snap frames are available in most any PMS color and are co-extruded with grippers to give you the most positive grip on your graphic. We will also apply tape in line for flat surface mounting. Please call us for custom snap designs.

P.O.P. Division
150 5th Ave.
Hawthorne, NJ 07507
973.427.7331

HQ
1000 Spiral Blvd
Hastings, MN 55033
800.451.4544
intekplastics.com



Ticket Channels/Data Strips

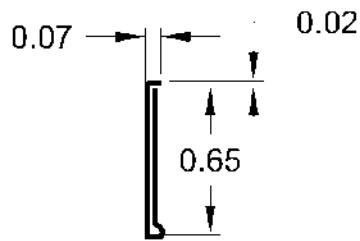

#1859

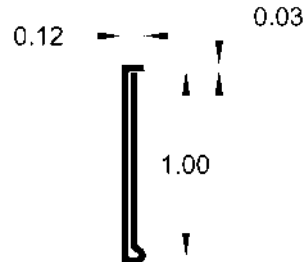

#1859

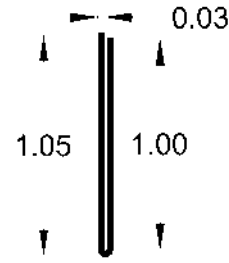

#2102

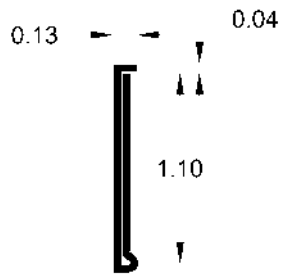

#1859

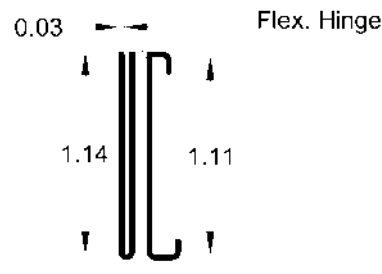

#2362

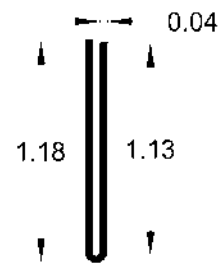

#2102

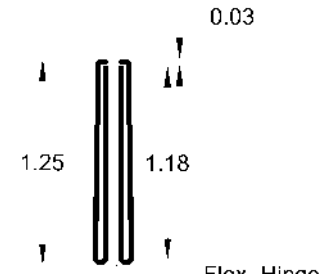

#2857

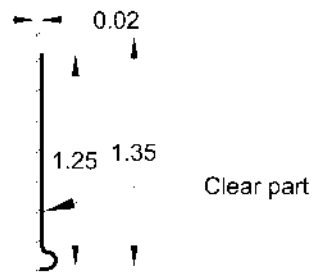

#3033M

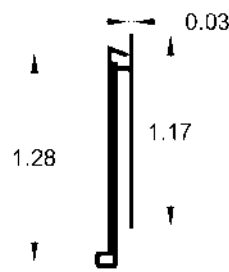

#2365

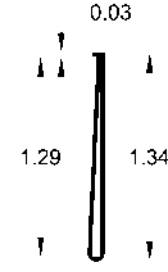

#1898A

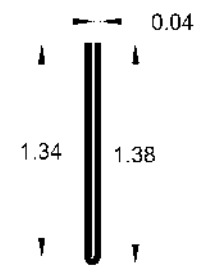

#1514

Ticket Channels / Data Strips

Without a doubt one of the most important profiles in our line. The profile that the customer looks at first before they make that important decision of which product to purchase. These profiles shown here represent a fraction of the ticket channels and data strips we manufacture, however these seem to be the most popular sizes. We make data strips and ticket channels from 3/8" to 6" high, so please call us for an RFQ for your special needs.

P.O.P. Division
150 5th Ave.
Hawthorne, NJ 07507
973.427.7331

HQ
1000 Spiral Blvd
Hastings, MN 55033
800.451.4544
intekplastics.com



Ticket Channels/Data Strips

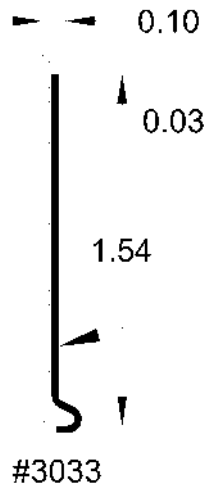

Clear part

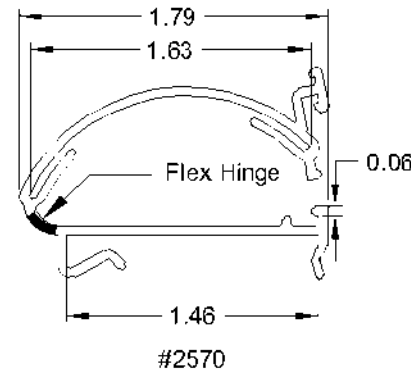
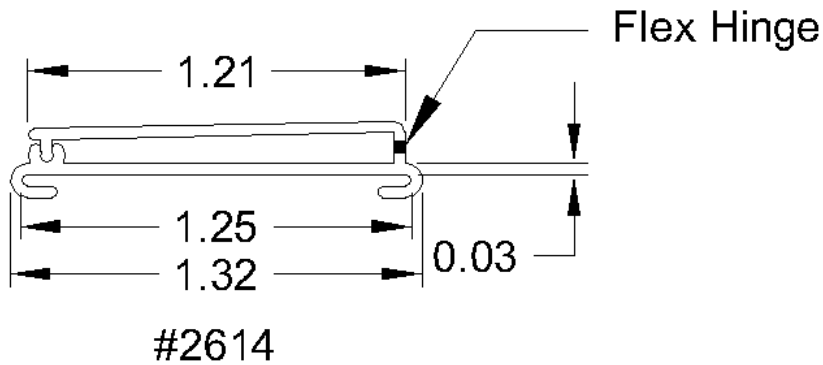
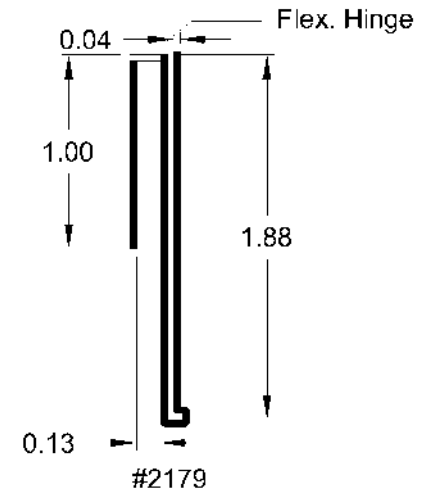
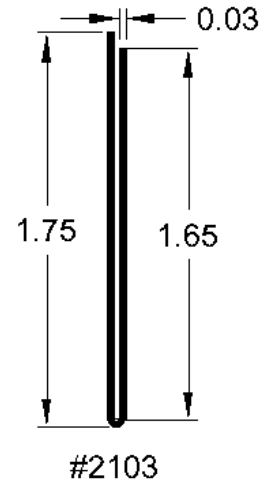
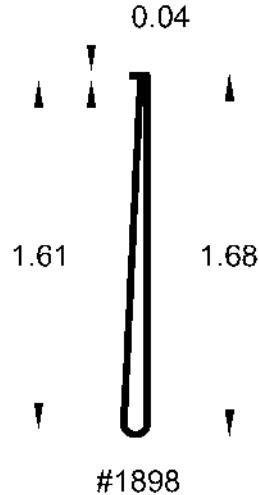

Ticket Channels / Data Strips

Without a doubt one of the most important profiles in our line. The profile that the customer looks at first before they make that important decision of which product to purchase. These profiles shown here represent a fraction of the ticket channels and data strips we manufacture, however these seem to be the most popular sizes. We make data strips and ticket channels from 3/8" to 6" high, so please call us for an RFQ for your special needs.

P.O.P. Division
150 5th Ave.
Hawthorne, NJ 07507
973.427.7331

HQ
1000 Spiral Blvd
Hastings, MN 55033
800.451.4544
intekplastics.com



Tubes

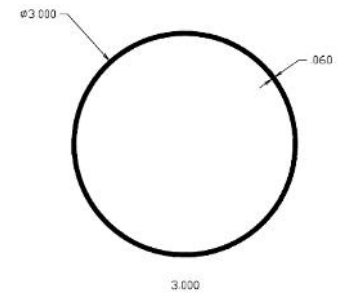
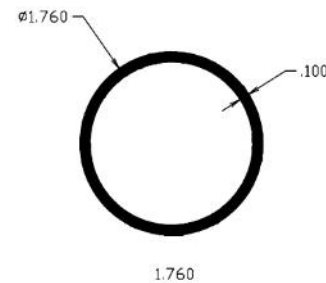
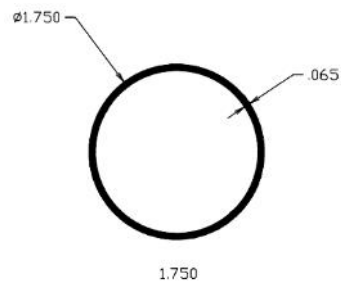
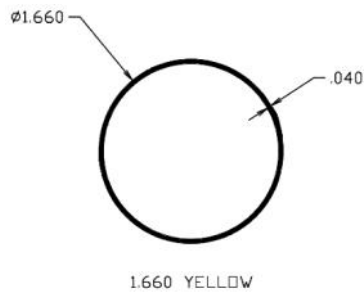
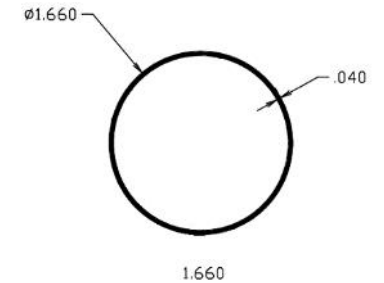
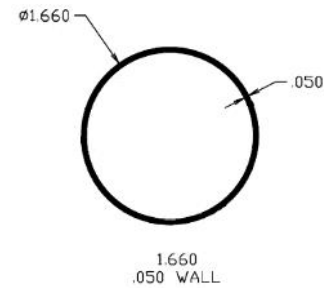
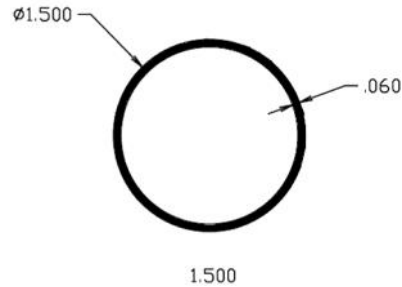
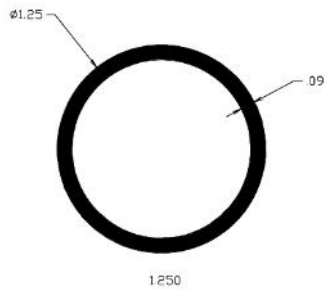
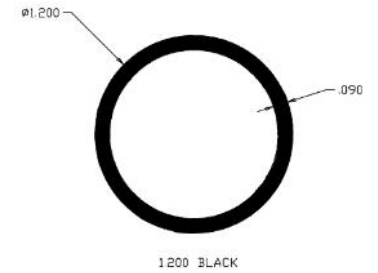
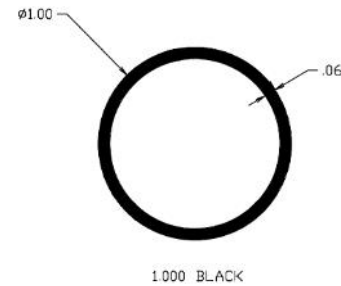
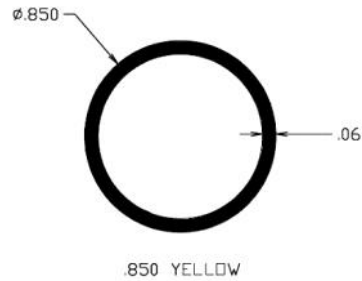
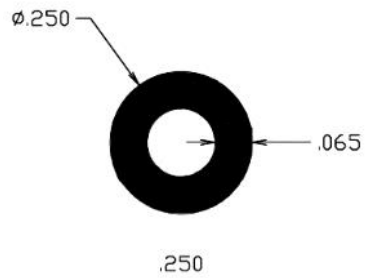

Tubes

Tubes can be used in a variety of ways in POP displays but are most commonly used as legs or supports. Tubes can be rigid or flexible depending on your needs. Both square and rectangular tubing are available upon request.

P.O.P. Division
 150 5th Ave.
 Hawthorne, NJ 07507
 973.427.7331

HQ
 1000 Spiral Blvd
 Hastings, MN 55033
 800.451.4544
 intekplastics.com



Slatwall

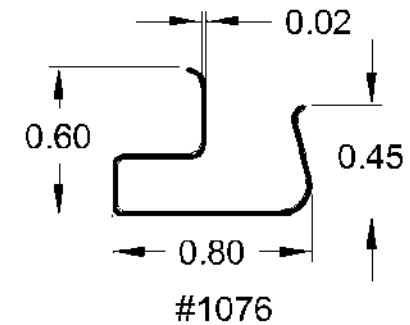
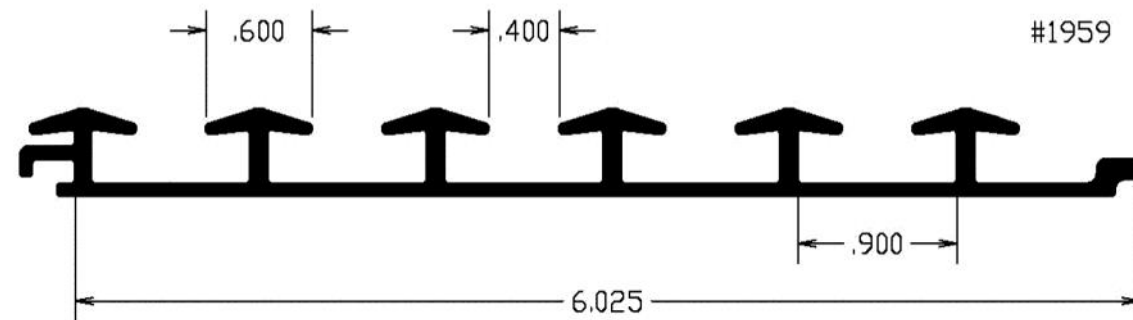
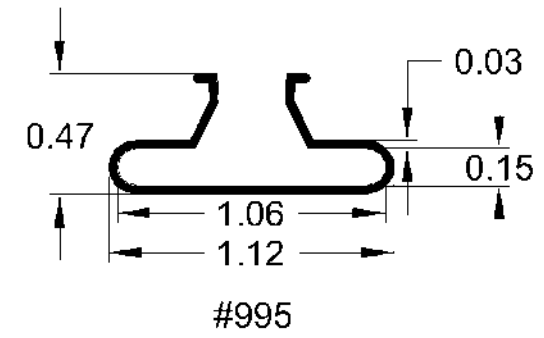
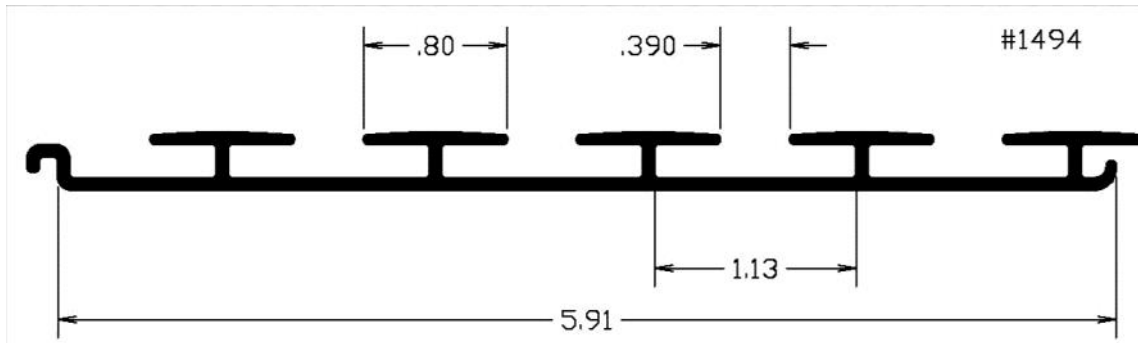

Slatwall

Plastic slatwall has been used in retail application for many years. They are virtually indestructible and incredibly lightweight. They're designed to accept all standard pegboard and slatwall hardware. Slatwall components can create freestanding applications, floor fixtures, tradeshow booths & others. You can join several together and they are easy to install and virtually maintenance free. We also have stock dies for wood and MDF panel inserts.

P.O.P. Division
150 5th Ave.
Hawthorne, NJ 07507
973.427.7331

HQ
1000 Spiral Blvd
Hastings, MN 55033
800.451.4544
intekplastics.com



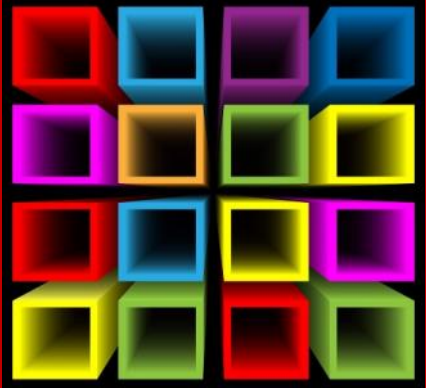

Notes

MADE IN
USA



**MADE IN
USA**



P.O.P. Division

150 5th Ave.
Hawthorne, NJ 07507
973.427.7331

HQ

1000 Spiral Blvd
Hastings, MN 55033
800.451.4544

Extruding the way to higher standards