

Working Draft Project American National Standard

T13/1699-D

Revision 6a
September 6, 2008

Information technology - AT Attachment 8 - ATA/ATAPI Command Set (ATA8-ACS)

This is a draft proposed American National Standard of Accredited Standards Committee INCITS. As such this is not a completed standard. The T13 Technical Committee may modify this document as a result of comments received during public review and its approval as a standard. Use of the information contained here in is at your own risk.

Permission is granted to members of INCITS, its technical committees, and their associated task groups to reproduce this document for the purposes of INCITS standardization activities without further permission, provided this notice is included. All other rights are reserved. Any commercial or for-profit replication or republication is prohibited.

T13 Technical Editor:

Curtis E. Stevens
Western Digital Technologies, Inc.
20511 Lake Forest Dr.
Lake Forest, Ca. 92630
USA

Telephone:949-672-7933
Email: Curtis.Stevens@wdc.com

Reference number
ISO/IEC xxxx-xxx:200x
ANSI INCITS 452-2008

Points of Contact

T13 Chair
Dan Colgrove
Hitachi Global Storage Technologies
2903 Carmelo Dr
Henderson, NV 89502
Tel: 702-614-6119
Fax: 702-614-7955

T13 Vice-Chair
Jim Hatfield
Seagate Technology
389 Disc Drive
Longmont CO 80503
Tel: 720-684-2120
Fax: 720-684-2766

INCITS Secretariat

INCITS Secretariat
1250 Eye Street, NW Suite 200
Washington, DC 20005
Email: INCITS@ITIC.ORG
Tel: 202-737-8888
Fax: 202-638-4922

T13 Reflector

See the T13 Web Site at <http://www.t13.org> for reflector information.

T13 Web Site

<http://www.t13.org>

T13 FTP Site

<ftp.t13.org> (see www.t13.org for login information)

Document Distribution

INCITS Online Store
managed by Techstreet
1327 Jones Drive
Ann Arbor, MI 48105
<http://www.techstreet.com/incits.html>
Telephone: 1-734-302-7801
or 1-800-699-9277
Facsimile: 1-734-302-7811

or

Global Engineering
15 Inverness Way East
Englewood, CO 80112-5704
<http://global.ihs.com/H>
Telephone: 1-303-792-2181
or 1-800-854-7179
Facsimile: 1-303-792-2192

American National Standard
for Information Technology

Draft

Secretariat
Information Technology Industry Council

Approved mm.dd.yy
American National Standards Institute, Inc.

ABSTRACT

This standard specifies the AT Attachment command set used to communicate between host systems and storage devices. This provides a common command set for systems manufacturers, system integrators, software suppliers, and suppliers of storage devices. The AT Attachment command set includes the PACKET feature set implemented by devices commonly known as ATAPI devices. This standard maintains a high degree of compatibility with the AT Attachment Interface with Packet Interface - 7 (ATA/ATAPI-7) volume 1 (see ANSI INCITS 397-2004).

Draft

American National Standard

Approval of an American National Standard requires verification by ANSI that the requirements for due process, consensus, and other criteria for approval have been met by the standards developer. Consensus is established when, in the judgment of the ANSI Board of Standards Review, substantial agreement has been reached by directly and materially affected interests. Substantial agreement means much more than a simple majority, but not necessarily unanimity. Consensus requires that all views and objections be considered, and that effort be made towards their resolution.

The use of American National Standards is completely voluntary; their existence does not in any respect preclude anyone, whether he has approved the standards or not, from manufacturing, marketing, purchasing, or using products, processes, or procedures not conforming to the standards.

The American National Standards Institute does not develop standards and will in no circumstances give interpretation on any American National Standard. Moreover, no person shall have the right or authority to issue an interpretation of an American National Standard in the name of the American National Standards Institute. Requests for interpretations should be addressed to the secretariat or sponsor whose name appears on the title page of this standard.

CAUTION NOTICE: This American National Standard may be revised or withdrawn at any time. The procedures of the American National Standards Institute require that action be taken periodically to reaffirm, revise, or withdraw this standard. Purchasers of American National Standards may receive current information on all standards by calling or writing the American National Standards Institute.

[The patent statement goes here.](#)

[If no patents have been disclosed place the statement in 5.5.2 shall be used.](#)

[If any patents have been disclosed place the statement in 5.5.3 shall be used.](#)

Published by

American National Standards Institute
11 W. 42nd Street, New York, New York 10036

Copyright © 2007 by Information Technology Industry Council (ITI).
All rights reserved.

No part of this publication may be reproduced in any form, in an electronic retrieval system or otherwise, without prior written permission of ITI, 1250 Eye Street NW, Suite 200, Washington, DC 20005.

Printed in the United States of America

Document Status

Document e06122 is the issues list for this draft. e06122 contains a list of the issues associated with the document, an issue number that remains assigned to the issue for the life of document development, a resolution to the issue, an owner for the issue, and a disposition for the issue. All major changes associated with this draft starting with Rev 3b are first documented in e06122 and given a number. This includes proposals which are targeted for inclusion into this draft. This text which is highlighted in green may affect backward compatibility.

Revision History (part 1 of 21)		
Rev	Date	Description
0	August 17, 2004	<ol style="list-style-type: none"> 1) Initial revision created from ATA/ATAPI-7 Volume 1 (1532D Rev 4b). 2) Removed 3 volume structure and changed abstract to reflect a command set document 3) Removed sections on signal, bit, and timing conventions 4) Removed clause 5, I/O register descriptions 5) Kept informative annex's A-C
1	September 7, 2004	<ol style="list-style-type: none"> 1) Restructured all commands to conform to format agreed to in e04139r4. 2) Added a section defining status bits 3) Added a section defining error bits 4) Added a section describing protocols 5) Added a section describing interrupt reason 6) Incorporated single log table e04143r0 table. Did not add wording to status that host VS pages are common between SMART and GPL. 7) Removed prohibited statements from command definitions. These reside in the feature set definitions.
1a	October 6, 2004	<ol style="list-style-type: none"> 1) Replaced duplicate Normal Outputs tables with a see clause to the first usage. 2) Replaced many Error Outputs with a see clause.
1b	February 17, 2005	<ol style="list-style-type: none"> 1) Stripped unused informative references 2) Changed the definition of ordered and unordered lists to make the numeric form ordered. 3) Changed all the lists to conform to the changes in #2 4) Reserved 5Ch-5Fh for TCG. This was done by added command headers and a reserved statement in the command section. Also marked the commands with T in the command matrix table. 5) Moved Normal and Error Outputs to their own section. Commands now have a hotlink to the tables. 6) Moved IDENTIFY (PACKET) DATA to its own section (Input Data) 7) Changed more of the titles to be consistent with the front cover. 8) Deleted unused definitions 9) Changed the General feature set to only apply to non-packet devices 10) Changed the packet feature set to include all the commands in the packet feature set. 11) The command prohibitions are now found in the feature set description and not with each command. 12) Integrated e04127r0 – This makes SATA signatures reserved with no description.

Revision History (part 2 of 21)		
Rev	Date	Description
1c	April 15, 2005	<ol style="list-style-type: none"> 1) Added proposal e04143r1 – Notes that the Host Vendor Specific pages are common to both SMART READ LOG and READ LOG EXTENDED 2) Added e04130r2 – Tightens the definition of SMART first polling time. Also adds a field that enables longer times. 3) Added proposal e05103r0 – Changes the features register to log page specific for read and write log commands 4) Added e04153r1 – Historical annex of command documentation to Annex B 5) Added e05102r1 as amended – Reserves some set features and DCO fields as vendor specific 6) Added back in FEATURE SET Clause in front of the description
1d	June 20, 2005	<ol style="list-style-type: none"> 1) Added code 1Dh to IDENTIFY DEVICE for ATA/ATAPI-7 Table 14. 2) Added placeholder for reporting alignment. 3) Updated SET FEATURES table 41 to include reserved entries instead of just saying all other entries are reserved. 4) Partially Incorporated e04129r5. Assigned Set Features 0Bh and 8Bh for the enable and disable capability. Had to make several modifications to the proposal to fill in missing pieces. Unable to fill in IDENTIFY DEVICE info, data is incomplete. Stopped incorporation
1e	June 21, 2005	<ol style="list-style-type: none"> 1) Modified Selective self-test description last sentence to be more clear. 2) Updated definition based on WG review. 3) Integrated e05133r3. This conflicts with the definition of IDENTIFY DEVICE which is defined to not return an error. 4) Incorporated e04129r6. Assigned IDENTIFY DEVICE words 210-213 and DCO word 7 bit 14.
1f	July 5, 2005	<ol style="list-style-type: none"> 1) Added several technical reports to the approved references. They need to be there since they are mentioned in the body of the document. 2) Updated DCO to refer to TR37 (TLC) for word 7 bit 10. 3) Updated the Scope to match ATA8-AAM 4) Replaced sector with logical sector in many places 5) Replaced all references to the Features register with features field. 6) Replaced all references to the Sector Count register with Count field. There are some places that use the count field in calculations. These places refer to the register. I have chosen to keep the word field although I think it may read better just saying count. 7) Replaced archaic references to sector number register with references to the LBA field. 8) Replaced references to LBA Low, LBA Mid, and LBA high to LBA field. 9) Replaced all references to device/head or device register 10) Deleted references to the device control register. 11) Updated overview in clause 7. 12) Updated security commands to have an output data structure where appropriate 13) Updated SETMAX commands to have an output data structure where appropriate. 14) Removed remaining hardware references from commands. Transport documents will have to reference 1e for notes on information that needs to move. This includes most references to BSY, RDY, DRQ, and bus. 15) Implemented e04161r0 (obsoleted ATAPI overlap and queue) 16) Moved host vendor specific log description into its own clause. 17) Integrated e05130r0 18) Integrated e05131r1 19) Integrated e05120r2 – Needed to add text to 4.21 to support the examples.

Revision History (part 3 of 21)		
Rev	Date	Description
2	August 22, 2005	<ol style="list-style-type: none"> 1) Updated SET MAX ADDRESS to indicate that on drives with a capacity that is greater than 28 bits, that issues SET MAX ADDRESS to the NATIVE MAX address clears the HPA and returns the full capacity of the drive, not just 137GB. 2) Added e04132r1 – Defines sub-command 03 for download microcode 3) Incorporated e04162r0 – Obsolete Download Microcode 4) Incorporated e05151r1 – Reserve opcodes for e05106. The following resources were assigned: <ol style="list-style-type: none"> 1) CHECK POWER MODE normal returns 40h and 41h 2) IDENTIFY DEVICE data words 214-221 3) New opcode B6h – NV CACHE (Sorry, B8h is reserved for CFA) 4) DCO data structure Word 21 bits 14 and 15 5) Incorporated e02126r6 – WRITE UNCORRECTABLE. The following resources were assigned: <ol style="list-style-type: none"> 1) Opcode 45h 2) IDENTIFY DEVICE data words 119/120 bit 2 3) DCO Data word 21 bit 13 6) Modified DCO to indicate that the data is not an overlay, it is just data that can be used to enable or disable reporting of features as well as responding to features. 7) Incorporated e05127r2 – Updated the definition of the DF bit. 8) Incorporated e05129r1 – READ/WRITE LOG DMA EXT. The following resources were assigned: <ol style="list-style-type: none"> 1) Opcodes 47h and 57h 2) IDENTIFY DEVICE data words 119/120 bit 2 9) Incorporated e05132r1 – Report transport standard. IDENTIFY DEVICE words 222 and 223 were assigned for this purpose. 10) Incorporated e05140r0 – Media Serial Number Endianess 11) Performed a major re-work of the IDENTIFY DEVICE table data. Added a column to indicate applicable transport. 12) Received side-band E-Mail comments from yamini@medusalabs.com resulting in the following changes: <ol style="list-style-type: none"> 1) CFA Translate Sector Features and Count fields S/B N/A as in ATA7 2) Page number was deleted from the clause reference in 4.4.1 13) Marked bits 15:13 obsolete. This was accidentally left out when e04161 was incorporated. 14) Reformatted Table 117, Table 118, Table 119, Table 120. The command code table serves as the master. All of the command codes are now listed. I believe this will cause the table to be maintained better. I also discovered some inconsistencies in the table during the reformat. 15) Performed consistency pass on command tables, several links have been corrupted.

Revision History (part 4 of 21)		
Rev	Date	Description
2a	December 10, 2005	<ol style="list-style-type: none"> 1) Added cross reference to tables. This is required since several commands point to the same tables. 2) Fixed command tables to match ATA7. 3) e05141r2 was voted in however, no document has been posted. 4) Incorporated e05162r0 5) Incorporated e05161r0 6) Incorporated e05167r0. 7) Incorporated e05109r3 as modified by Mark Evans 8) Addressed ATA/ATAPI-7 public review comment by inserting the statement "If write cache is enabled unrecoverable errors may not be reliably reported as they may occur after the completion of the command. "after the statement that says the first error block is returned in the response fields. 9) Replaced Master password with Master password as per E-Mail review comment. 10) Replaced is specified with is specified as per E-Mail review comment
2b	January 10, 2006	<ol style="list-style-type: none"> 1) Made READ and WRITE LOG EXT optional for ATAPI devices 2) Reincorporated SCT using e05109r4 3) Changed Long Segment Access to Write Same 4) Incorporated e05170r1 5) Incorporated e05154r4 6) Incorporated e05150r2

Revision History (part 5 of 21)		
Rev	Date	Description
2c	February 7, 2006	<ol style="list-style-type: none"> 1) Changed IDENTIFY DEVICE description that involve different behavior for serial and parallel to have separate paragraphs. 2) Added change to support e04132r1. This proposal uses word 86 bit 15 to indicate support. Word 86 bit 15 has been used to indicate that words 119/120 have valid data. Support for segmented download microcode shall be indicated by words 119/120 bit 4. 3) Removed unreferenced references. I checked AAM and the referenced were duplicated there... 4) Made editorial changes based on working group review 5) Reworded all statements that included the word "will". 6) Reworded all statements that included the word "can" 7) Was asked to reword statements with the word presently. I found none of these in the document. 8) Removed the word clause from references that were actually subclauses. Fixed the case of the word clause, there were random Clause/clause in the text. 9) Replaced all occurrences of space space with space. Then replaced all occurrences of period space with period space space. This will have the effect of making the document use the same convention for sentence completion. This was done with change bars off. 10) Removed inappropriate references to LBA Low, Mid, and High in annex D. 11) Scrubbed the word register... Most of this was just changing the word register to field. There were some usages where more extensive wording changes were required. 12) Fixed cut and paste error in WRITE STREAM DMA EXT during the incorporation of e05154. Added the description of WC and removed the description of CCTL in favor of a reference to the same description in the READ STREAM DMA EXT command. 13) Normalized Not Applicable to N/A. Replaced all na with N/A. 14) Changed "Host Shall" statements to "Host Should". The device can not enforce a requirement on the host. The device can only respond to what it receives.

Revision History (part 6 of 21)		
Rev	Date	Description
2d	February 9, 2006	<ol style="list-style-type: none"> 1) Changed "Hosts" the "A Host". A drive only converses with a single host. 2) Reformatted the IDENTIFY PACKET DEVICE table and added notes regarding some of the inconsistencies. 3) Added an overview subclause to clause 4. The overview includes a table which lists all the feature sets and if each feature set is option mandatory or not a part of this standard. 4) Changed the name of clause 4 to Feature set definitions 5) Merged 4.1 command delivery with the overview 6) Removed the see 4.2 in ID words 60,61 because 4.2 has been removed from the document. 7) Updated Table 6 to include READ/WRITE LOG DMA EXT. Also reformatted table to match other table formatting 8) Added MMCA and CE-ATA references 9) Reformatted approved references and references under development to use tables instead of text and tabs 10) Updated Figure 3 to include Qword. 11) Replaced occurrences of logical sector and sector with 512-byte block of data. This introduces the concept of data block which is a 512 byte fixed unit. There was a previous pass through the document that replaced sector with logical sector. However, new proposals reintroduced the ambiguity. At this point, the doc should have consistent usage of Logical sector for a unit of measure that is reflected in IDENTIFY DEVICE words (118:117). 512-byte block of data refers to transfer units that are fixed at 512 bytes regardless of logical sector size. The phrase data blocks refers to 512 byte units. Modified Table 25 - Extended Self-test log data structure. The byte numbering indicates that there can be 19 log entries, but the description indicates 18 entries 12) Modified Table 26 - Extended Self-test log descriptor entry. The vendors specific values were obviously mis numbered. The Extended Self-test log data structure indicates that there should be 26 bytes. However, the descriptor entry is only 24 bytes long. It looks like the VS bytes were added later and the ending value was not properly updated. 13) Modified the text description of ID words 83 & 86 to read Removable Media Status Notification feature set. Previously they read Removable Media Feature Set. The correct entry was in the table. Words 82 and 85 bit 2 document the removable media feature set. 14) Made minor corrections to Annex C as requested in E-Mail by Rob Elliott <ol style="list-style-type: none"> 1) Modified C.1 to reference ATA standards prior to ATA/ATAPI-7. The previous statement was a bit strong 2) Softened C.2 to reference Logical Sectors instead of 512-byte sectors. 3) Changed C.3 to reference the logical sector size instead of 512-byte sectors 4) Corrected an inaccuracy in C.3 figure which skipped LBA7... 15) Implemented responses to Rob Elliot comments for e06105. 16) Changed IDENTIFY DEIVCE words 85-87 to read supported instead of enabled for features that can not be disabled 17) Updated the definition of N/A 18) In 7.17.6 removed the statement that an ICRC error can occur in IDENTIFY DEVICE. ICRC for SATA has no provision to report a CRC error on one block commands or the last block of the command. 19) Made changes requested at meeting held 21-24 Feb. 20) Added minor revision for ATA8-ACSR2d.
3a	March 20, 2006	<ol style="list-style-type: none"> 1) Converted document from Word to Frame

Revision History (part 7 of 21)		
Rev	Date	Description
3b	March 21, 2006	<ol style="list-style-type: none"> 1) Restored N/A designations to the Normal and Error Outputs. This had the effect of changing WRITE UNCORRECTABLE Sector and LBA field return values from Reserved to N/A 2) Added a table with a list of all the documents incorporated into ATA8-ACS. The purpose of this is to provide a summary of changes and to provide an easy way for the reader to identify new features. 3) Obsoleted DMA Ready as an addition to e04161. This bit is only used for ATAPI overlap and queueing 4) Moved most of the editors notes into e06122 (ATA8-ACS open issues list) 5) Merged the Overlap and Queue feature sets to be the Tagged Command Queuing feature set. This now means that a drive can not implement just overlap 6) Changed Feature Set to feature set everywhere except in table headings and in the command headings 7) Updated 7.1.1 (Introduction to command structure) to indicate that a mapping shall be supplied by transport documents that reference ATA8-ACS 8) Marked the Tag field obsolete to support e04161 in 7.26.3 PACKET command inputs 9) Added the Device field to all the commands and their associated outputs 10) Modified clause 8 so that all the READ/WRITE LOG EXT command reference also include READ/WRITE LOG DMA EXT 11) Changed log pages E0 and E1 to indicate SCT in table 30 Log address definition 12) Modified 7.56.6 Off-line data collection capabilities to have the bit definitions in a table instead of a list. 13) Modified 7.70.3 WRITE LOG EXT Inputs so the Log Address definition is in a subclause. 14) Modified 7.17.7 IDENTIFY DEVICE data word descriptions to have the form For PATA devices... followed by For SATA devices... for fields that are set differently between PATA and SATA 15) Modified Table 82 Absolute HDA Temperature to reference a circular buffer instead of a queue 16) Incorporated e05178r0. This makes WWN Mandatory 17) Incorporated e05160r0. This clarifies that a flush cache is always successful when write cache is disabled. 18) Incorporated e05162r2. This enhanced DM Mode 3 by allowing the drive to report minimum and maximum transfer sizes. Assigned IDENTIFY DEVICE data words 234 & 235 to this capability 19) Incorporated e05139r7. This adds 4 commands to be used by the Trusted Computing Group. Assigned ID Device word 48 and DCO word 21 bit 12. Added entries to table 6 block size by command and table and table 4 security protocol command actions. The proposal did not provide guidance on these tables. Also updated tables in Annex A Command Set History 20) Incorporated e05109r7. This adds the ability to manipulate non-volatile cache. Assigned IDENTIFY DEVICE data words 214-219, DCO IDENTIFY word 21 bits 15:14, DCO SET word 21 bits 15:14, and opcode B6h. 21) Spell checked the document. Found sooo many spelling errors going back all the way to ATA4.

Revision History (part 8 of 21)		
Rev	Date	Description
3c	June 14, 2006	<ol style="list-style-type: none"> 1) In Rev 3b most of the editors notes were removed from the doc and placed in the ATA8-ACS Open Issues List, doc #e06122. This document will be used from now on to track the work items remaining on ATA8-ACS. From this point forward, the revision history will reference a work item # when ever possible. 1) Fixed a variety of line issues with the tables. 2) Closed open issue #62 by deleting the sentences that contained the TBDs in TRUSTED RECEIVE 3) Closed open issue #63, the entry for ISO/IEC FDIS 9594-8 in references under development is correct. 4) Marked TRUSTED SEND PROTOCOL EFh as reserved for T10. This is required to keep the assignment values synchronized. 5) Did a substitute to replace Times New Roman font with Arial font. There were over 180 replacements. 6) Did a replacement to remove "body" paragraph type. This may have some formatting effects on the doc, but I did not see any on my first glance. I believe that this change removed all of the strange formatting that was brought across as a result of the import from word. 7) Changed several references to overlap to be TCQ. This also caused a slight rework of the Tag field definition. 8) Deleted the definition of overlap since overlap is not used. 9) Fixed opcode for WRITE LOG DMA EXT. It was listed in 7.71 as 47h when it should have been 57h 10) Implemented open issue #1 to make HPA prohibited for PACKET devices. The prohibition was inserted into clause 4.11.1. Also modified table 39 (IPD Data) to indicate that word 82 bit 10 shall be cleared to zero. 11) Implemented open issue #3 to clarify resets. e06133r0.pdf contains the comments that are the basis for changes. e06133r1 marks comments as completed if the suggested change was made. 12) Implemented issue #8: what constitutes all error logs in 4.21.8. Removed last paragraph which required firmware to clear all error logs. 13) Implemented issue #18: the diagnostics results field should be reserved for DEVICE RESET. see table 104 for changes. 14) Implemented issue #20. In 7.12.2 changed "and all previously downloaded microcode is discarded" to "and all previously downloaded microcode may be discarded" 15) Implemented issue #23. In IPD (table 39) word 2 (table only), the word is titled unique configuration. This was changed to specific configuration to match the ATA version. 16) Implemented issue #24. In IPD (table 39) words 83 & 86 bit 0, the device was allowed to report support for DOWNLOAD MICROCODE. This has been change to "Shall be cleared to zero to indicate ..." 17) Implemented issue #26. In 7.22.5 and 7.22.6.2, changed the lists from ordered to unordered. 18) Implemented issue #27. In 7.23.2 removed the host requirement to send WRITE BUFFER before READ BUFFER. Replaced the requirements with the consequences of such an action. 19) Implemented issue #30. In table 52 SET FEATUREs subcommands 09 and 89 were only listed for TR37. CFA also uses this capability. Changed the definition to allow for the CFA usage as well.

Revision History (part 9 of 21)		
Rev	Date	Description
3c	June 14, 2006	<p>20) Implemented issue #31. In table 52 SET FEATUREs subcommands 69 was marked reserved. This has a definition in CFA that has not been ported to ATA8</p> <p>21) Implemented issue #32. In 7.48.20 there is a statement that says see subcommands for normal outputs. Since there are no normal outputs in the subcommands, this statement was deleted.</p> <p>22) Implemented issue #33. Added subclause 4.11.4 to explain how IDENTIFY DEVICE data words are set after SETMAX is issued. Updated 7.49.2.2 and 7.49.5.2 to reference the new text.</p> <p>23) Implemented issue #39. Removed the title from word 0 in 7.78.3.</p> <p>24) Implemented issue #42. The CHK bit was removed from normal and error outputs in Rev 3b when the tables were reorganized. This issue was created after the fact. As a result of this activity, the CHK bit is no longer used. The definition of CHK was deleted from clause 6.</p> <p>25) Implemented issue #45. This issue was created because a fix was implemented in table B.2 where opcodes 87 and C0 were missing, the opcodes were in the VS area.</p> <p>26) Implemented issue #46. Each SMART operation is listed in table B.2 although they have the same opcode. SMART now has a single entry. This change will be spawned in table B.3 before publication.</p> <p>27) Implemented issue #47. Each DCO operation is listed in table B.2 although they have the same opcode. DCO now has a single entry. This change will be spawned in table B.3 before publication.</p> <p>28) Implemented issue #74. In subclause 8.1 paragraphs 4 and 5 created host requirements. Since the relevant material is already covered in clause 7, paragraphs 4 and 5 were deleted.</p> <p>29) Implemented issue #73. Deleted the definition of LBA Range Entry since this is only used in one place. Modified 7.20.3.2 where the only reference to LBA Range Entry exists to have a see 7.20.3.6 where the LBA Range Entry is defined.</p> <p>30) Implemented issue #71. Deleted the list of devices from 7.17.6.2. but kept the reference to SPC. The list of devices changes with time and should be maintained in SPC.</p> <p>31) Implemented issue #68. Added kept the abort bit added to table 155.</p> <p>32) Implemented issue #78. There was an error made when implementing e05170r1, in subclause 8.3.3 function codes 0003h and 0004h were used when 0101h and 0102h should have been used...</p> <p>33) Implemented issue #79. In table 75 the definition of error code 13h was unclear. Changed the definition to reference SCT data.</p> <p>34) Implemented issue #67. Change title of table 155 to Generic NV Cache Abort. This reflects the fact that several of the NV Cache Commands use this error output. Retained the changes made to e05106r7 during its incorporation.</p> <p>35) Implemented issue #65. Added abort bit to table 153. This keeps the NV Cache add lba(s) command consistent with other commands.</p>

Revision History (part 10 of 21)		
Rev	Date	Description
3c	June 14, 2006	<p>36) Implemented issue #66. Added abort bit to table 154. This keeping the NC Cache remove lba(s) command consistent with other commands. Also clarified bit 0 by referencing the pinned set. During the implementation of this issue, in 7.20.9.5 a cut and paste error was corrected. The statement “added to pinned set” was changed to removed from pinned set.</p> <p>37) Implemented issue #77. Modified 4.8 paragraph #5 to more clearly state the operation of DCO Freeze Lock.</p> <p>38) Implemented issue #89. This incorporates e06127r0 which assigns a security protocol to IEEE P1667.</p> <p>39) Implemented issue #81. This incorporates e06125r0 which updates IDENTIFY PACKET DEVICE (IPD).</p> <p>40) Marked IPD word 82 bits 7 and 8 obsolete. These should have been marked obsolete when ATAPI overlap and queue (e04161) were obsoleted.</p> <p>41) Implemented issue #80. This incorporates e06116r0 which obsoleted both the removable media and media status notification feature sets. This had the effect of obsoleting 3 status bits (MC,MCR,and NM) in all of the read/write commands.</p> <p>42) Implemented issue #90. This incorporates e06128r1 which deals with issues surrounding resets.</p> <p>43) Implemented issue #91. This incorporates e06121r1 which clarifies operation of Write-Read-Verify. Although there is 1 mention of IPD in the Write-Read-Verify feature set description, there are no ATAPI commands listed in the affected commands. Assigned word 200 bits 7:0 to the current mode.</p> <p>44) Implemented issue #86. This incorporates e06123r0 which allows READ LOG EXT to succeed when the device is security locked.</p> <p>45) Implemented issue #82. Alphabetized the feature sets in clause 4. This will have the effect of causing all current proposals that reference 4.xx to need an update.</p> <p>46) Implemented issue #83. Added description of how SETMAX affects IDENTIFY DEVICE data to the description of the HPA feature set in 4.11.4</p> <p>47) Changed “Note: “paragraphs to conform with the rest of the document and say “Note ## - “with indented text. Also changed punctuation on ICRC notes for better english grammar.</p> <p>48) Updated Trusted Send/Receive Security Protocol assignments to show that T10 has assigned protocol 20h</p> <p>49) Assigned minor revision code 0027h to rev 3c. This code was assigned due to the number of new proposals integrated in this rev.</p>
3d	July 10, 2006	<p>1) Alphabetized DCO, NV Cache, SETMAX subcommands in clause 7</p> <p>2) Moved log pages into a normative annex and added a reference in the description of READ LOG EXT and SMART READ LOG to table A.2 and Annex A.</p> <p>3) Previous Annex A, B, and C have been bumped to B, C, and D</p>

Revision History (part 11 of 21)		
Rev	Date	Description
3e	July 10, 2006	<ol style="list-style-type: none"> 1) Implemented issue #19, Added the e.g., statement to paragraph 6 of 7.12.2 2) Implemented issue #22. Modified 7.16.7.39 word 85 bit 10 to have a more clear definition of how the HPA bit works. 3) The text in IDENTIFY PACKET DEVICE did not show words 71-72 which should have been marked obsolete in e05161. 4) Implemented issue #70. Modified text in IDENTIFY DEVICE and IDENTIFY PACKET DEVICE to use x-y instead of (x:y) for word offset ranges. 5) Implemented issue #75. Added a definition of BIOS to the definition of terms. 6) Implemented issue #87. Inserted text into 4.1 and 7.16.2 to require that commands reported as not supported be aborted. 7) Implemented issue #94. Added note back in from ATA/ATAPI-7 in table A.9 and table A.10 8) The footnote in table A.10 is only relevant to the parallel transport, so it was deleted. The same is true of table A.9. This was caught during a pass to remove the word register. This is why the footnotes were originally removed from the tables. 9) Added the Device field back into table A.24, table A.9, table A.10, and table A.25. This was overlooked when the device field was reintroduced. 10) Implemented issue #86. Once again scrubbed the word register. 11) Implemented issue #100. Modified 7.10.3 and 7.10.5 to redefine the term is allowed. 12) Implemented issue #101. Modified trusted send/receive commands (7.57.3, 7.58.3, 7.59.3, and 7.60.3) to properly use LBA (7:0) as transfer length (15:8). 13) Implemented issue #102. In A.7.3 the number of pages was listed instead of the last page number. 14) Implemented issue #104. In 6.2.10 changed lba (7:0) to properly read (47:0) 15) Implemented issue #105. Added a description of SCT extended status code 0015h to table 75 and 8.3.4. 16) Implemented issue #106. Added WRITE LOG DMA EXT to table 9. 17) Implemented issue #108. Marked NV Cache commands in table 5 prohibited. Also marked Media Card pass-through as prohibited. 18) Implemented issue #115. Updated the definition of command released in 3.1.23. 19) Implemented issue #112. Removed other reference in 2.4 to PC-Card. 20) Implemented issue #117. Modified A.11 (Read Stream Error Log) and A.16 (Write Stream Error Log) to use value range notation (x through y) instead of bit field notation (y:x). Also fixed the range in A.16 to properly be 1 through 31 instead of 0 through 31. 21) Implemented issue #121. Made a global change on the word offset range 101-103 to 100-103. This is the 48-bit device capacity range. Only the significant 48 bits were included when the range was inserted. 22) Implemented issue #114. Added a definition of TCQ to 3.1. Globally changed all references from "command queuing" to "the TCQ feature set".

Revision History (part 12 of 21)		
Rev	Date	Description
3e	July 10, 2006	<p>23) Implemented issue #109. Globally changes references from packet devices to ATAPI devices.</p> <p>24) Implemented issue #113. Globally changed PACKET command feature set to PACKET feature set. This removed an inconsistency in referencing the feature set.</p> <p>25) Implemented issue #118. Globally removed the phased "Changed to:". This was found in only one place, A.11. It looks like the change to was left over from a cut and paste error.</p> <p>26) Implemented issue #123. Globally changed Volatile Value to Volatile_Value and globally changed the abbreviation VV to V_V.</p> <p>27) Implemented issue #111. Provided hotlink to subclauses referenced by table 52.</p> <p>28) Implemented issue #124. Globally changed comply with subclause x.y.z to comply with x.y.z.</p> <p>29) Implemented issue #126. Fixed a typo in 7.78.3. In the Features field change 5:8 to 15:8.</p> <p>30) Implemented issue #129. Modified the description column of table 86 (write same command description) to only capitalize the first word of each sentence.</p> <p>31) Implemented issue #130. In 8.3.4 changed "LBA might" to "LBA may".</p> <p>32) Implemented issue #135. Added an editors note before table B.3 to warn people that the table is not being maintained. This table is a duplicate of table B.2 with the exception that it is sorted in alphabetical order.</p> <p>33) Implemented issue #133. Modified the Error field in table 104 to be more clear in stating that DEVICE RESET does not provide diagnostic results and all other commands do.</p> <p>34) Implemented issue #107. It turns out that e05162r0 was already implemented in a previous revision, but a not was not made in the revision history. This proposal added wording to 7.43.2 (SECURITY ERASE UNIT) to explicitly state that a password could be set prior to issuing the command if a password had not been previously set.</p> <p>35) Implemented issue #119. Created a definition of log address for read log and placed it in READ LOG EXT. Modified READ LOG EXT and SMART READ LOG to point to this definition. Created a subclause definition of Host Vendor Specific logs in READ LOG EXT and referenced this from the READ LOG EXT/SMART READ LOG address definition and WRITE LOG EXT/SMART WRITE LOG address definition. Placed a definition of write log address is SMART WRITE LOG and referenced this from SMART WRITE LOG and WRITE LOG EXT.</p> <p>36) Implemented issue #132. Added the bit positions to the bit descriptions in clause 6.</p> <p>37) Implemented issue #131. Normal output tables generic normal outputs w/LBA and Normal output tables generic normal outputs wo/LBA were identical. Changed clause 7 to reference only 1 normal outputs table. Deleted the redundant table from clause 9.</p> <p>38) The error outputs for SMART WRITE LOG and WRITE LOG EXT were listed incorrectly. Split SET MAX and write log error outputs so they use different tables. Everything now reads the same as ATA/ATAPI-7 for these commands</p> <p>39) After this revision was archived, clause 7 was split into 2 files. This was kept locally as rev 3e so change bars could be more easily generated</p>

Revision History (part 13 of 21)		
Rev	Date	Description
3f	December 11, 2006	<ol style="list-style-type: none"> 1) Assigned minor revision 0033h to ATA8-ACS rev 3e 2) Implemented issue #9. Removed Allocation Unit from the glossary, changed the field in configure stream to reference a subclause that describes allocation unit. Change the description of the flush cache bit to reference the new Allocation Unit subclause. 3) Implemented issue #28. Modified 7.26.5 and 7.27.5, the error outputs for the read DMA queued commands to remove the reference to Overlapped interrupt. The overlapped interrupt is not defined anywhere. Also remove the redundant statement about the command being aborted if it is not support. This material is contained in the definition of the abort bit. 4) Implemented issue #43. The definitions of DF and DRQ should be N/A for normal outputs (table 108 and table 112) and defined for error outputs (table 135 and table 149). 5) Implemented issue #44. Updated the definition of the DCO SET Error, table 141, to be more clear. 6) Implemented issue #95. Changed the definition of words 100-103 in the IDENTIFY DEVICE table (table 29) to read "Total Number of User Addressable Sectors for the 48-bit Address feature set". Also changed to heading in the text to match. 7) Implemented issue #97. Changed TF Data in 8.3.3 paragraph 6 to input data structure. 8) Implemented issue #98. Inserted a statement requiring the device to abort commands which are reported as not supported by IDENTIFY PACKET DEVICE. Also removed "(See 0)" statement that were left over from a conversion from word. 9) Implemented issue #103. Added verbiage to indicate that a block count of zero is illegal to the Inputs and Error Outputs for WRITE LOG EXT (DMA), READ LOG EXT (DMA), SMART READ LOG and SMART WRITE LOG. 10) Implemented issue #120. Modified the unordered list in 4.11.4 to make it more clear. 11) Implemented issue #128. Changed SCT Long Sector Access to SCT Read/Write Long. 12) Revisited issue #22. Word 85 bit 10 in the IDENTIFY DEVICE data table had not been updated as described in the issue. 13) Implemented issue #127. Inserted the fact that SMART DISABLE OPERATIONS does not disable SCT. 14) Implemented issue #138. The definition of ASCII string from ATA/ATAPI-7 did not seem appropriate for inclusion into IDENTIFY DEVICE. Reworked the definition of ASCII string and included it into 7.16.2. Also move the field data type descriptions from 7.17.2 to 7.16.2 and added a reference in 7.17.2 to 7.16.2. 15) Implemented issue #139. Clarified the definition of uncorrectable options. 16) Implemented issue #140. Changed IDENTIFY DEVICE data word 86 bit 8 from fixed to variable. 17) Implemented issue #141. Clarified SET MAX ADDRESS (7.49.2.2) to remove the requirement on the host that READ NATIVE MAX shall precede SET MAX ADDRESS. Instead the consequences of not issuing the READ NATIVE MAX are listed. 18) Implemented issue #142. Documented Optional/Mandatory, Fixed/Variable, and Serial/Parallel for IDENTIFY DEVICE data words 219 and 220.

Revision History (part 14 of 21)		
Rev	Date	Description
3f	December 11, 2006	<p>19) Implemented issue #143. Globally changed ID Field was not found to sector was not found. This only affected the error outputs of several SMART commands.</p> <p>20) Implemented issue #144. Changed maximum values in A.7.1, A.7.3 and A.8.1.</p> <p>21) Implemented issue #145. Globally changed vendor unique to vendor specific. Several of these had crept in during proposal integration to the Annexes.</p> <p>22) Implemented issue #149. Fixed DOWNLOAD MICROCODE Normal Outputs (7.12.4) to reference the correct IDENTIFY DEVICE data words.</p> <p>23) Implemented issue #150. In DOWNLOAD MICROCODE Inputs, labelled mode 3 as optional.</p> <p>24) Implemented issue #152. Wordsmithed the option byte in DOWNLOAD MICROCODE inputs.</p> <p>25) Implemented issue #153. Fixed a typo in HPA Security Extensions (4.11.2).</p> <p>26) Implemented issue #163. The Count Field in IDLE IMMEDIATE UNLOAD (7.19.4) was incorrectly documented as 44h when it should have been reserved.</p> <p>27) Implemented issue #159. Added WWN to IDENTIFY PACKET DEVICE and made it mandatory. Also ported the reserved words for the extension to 128 bits.</p> <p>28) Implemented issue #136. Moved Host and Device vendor specific log page descriptions along with table A.2 to Annex A</p> <p>29) Implemented issue #134. Changed table 109 (Normal Output for SMART Offline Immediate), table 110 (Normal Output for SMART Return Status), and table 138 (Error Output for SMART Execute Offline Immediate) to remove the N/A's that were indistinguishable from the key values supplied</p> <p>30) Integrated e06153r1. This reserves SCT Action Code 0007h, Extended Status Codes BF00h-BFFFh, SCT Feature Control feature codes 0004h-0005h, and SCT Data Table ID's 0003h-0004h for use by SATA-IO.</p> <p>31) Integrated e06152r3. This adds session and lifetime temperature reporting to SCT status in table 80. Also adds interval count since last over and under temperature conditions</p> <p>32) Changed byte offsets throughout clause 8 from ":" notation to "-" notation. This brings the clause in line with the rest of the document. Unfortunately, some of the tables have formulas in the offset column. It may be difficult to tell the range from the formula.</p> <p>33) Integrated e06102r2. Added a new log page at the end of Annex A called device statistics. Modified the proposal during incorporation to allow for definitions by page.</p> <p>34) Bit 4 of words 119 and 120 (Segmented feature of download Microcode) was documented in the table, but not in the text. Added the description to the text.</p> <p>35) Implement issue #146. Marked SET Features subcommands 41h, 83h, and C1h, DCO SET/IDENTIFY Word 21 bit 11, IDENTIFY DEVICE data words 119/120 bit 5, and IDENTIFY DEVICE data word 53 bits 8-15 as reserved for e06144.</p> <p>36) Integrated e05179r8. This removes some of the vagueness from the Security feature set. One Editors Note needs resolution in 4.20.10.</p>

Revision History (part 15 of 21)		
Rev	Date	Description
3f	December 11, 2006	<p>37) Added a paragraph at the beginning of this subclause to describe the issues list. (added based on line-by-line review)</p> <p>38) Changed formatting of IDENTIFY DEVICE data word 222. (added based on line-byline review)</p> <p>39) Added (i.e., HPA enabled/disabled) to IDENTIFY DEVICE data word 85 bit 10. (added based on line-by-line review)</p> <p>40) Assigned minor revision code 0042h to this rev (3f)</p>
3g	April 17, 2007	<p>1) Changed SET FEATURES subcommand 83 to be reserved for e06162 instead of e06144. e06162 is for simulating a free fall event.</p> <p>2) Fixed the byte count at offset 214 in table 80 to properly read 265 instead of 275.</p> <p>3) Fixed documentation error in revision history. The TCG proposal was e05139r7 but was documented as e05137r7.</p> <p>4) Fixed integration error for IDENTIFY DEVICE data word 48-bit 14 which should be 1 instead of 0.</p> <p>5) Implemented issue #165. Integrated e06150r5 NCQ commands from SATA IO.</p> <p>6) Implemented issue #166. Integrated e06144r6 (Free Fall feature set). Although this proposal was integrated, several modifications were required to make the information fit the form and style of ATA8. The feature set description needs work, I have opened issue #177 to address this issue</p> <p>7) Added missing entries to historical SET FEATURES table</p> <p>8) Implemented issue #158, Integrated e06126r3 (NOP Clarifications)</p> <p>9) Implemented issue #155. Added definition of read and write command.</p> <p>10) Implemented issue #156. Defined standardized error logs for WRITE UNCORRECTABLE. The term standardized error logs was defined or removed in previous revisions for other feature sets and commands.</p> <p>11) Implemented issue #64 & 161. Added the output data description to 7.20.3 (ADD LBA(S) TO NV Cache Pinned Set) and called the data Pin Request Data. Changed the text in PI to refer to this data.</p> <p>12) Implemented issue #164. Removed the host requirement from the SET MAX EXT description.</p> <p>13) Implemented issue #171. Changed Data Block Offset to Page #.</p> <p>14) Implemented issue #172. Changed IDENTIFY DEVICE to refer to the Security feature set instead of Security Mode feature set. Also changed other instances in the text that refer to Security Mode feature set.</p> <p>15) Implemented issue #175. Added READ LOG DMA EXT to table 9 (Security Command Actions)</p> <p>16) Implemented issue #172. Removed the host requirement to issue SET MULTIPLE prior to CFA WRITE MULTIPLE WITHOUT ERASE, READ MULTIPLE, READ MULTIPLE EXT, WRITE MULTIPLE and WRITE MULTIPLE EXT.</p> <p>17) Implemented issue #170. Alphabetized the log addresses in Annex A. Also normalized capitalization and names between the Log Address table and the subclause headers. Placed the log directory definitions at the beginning. Also added cross-links to the log addresses defined in the table.</p> <p>18) Corrected WRITE UNCORRECTABLE to WRITE UNCORRECTABLE EXT in IDENTIFY DEVICE words 119 and 120</p> <p>19) Removed several erroneous references to bits 15:8 in the status field.</p>

Revision History (part 16 of 21)		
Rev	Date	Description
3g	April 17, 2007	<p>20) Fixed transition in the Power Management State transition diagram (figure 14). The arrow from PM1 to PM3 had the arrowhead on the wrong side.</p> <p>21) Implemented issue #154. This adds a statement to WRITE UNCORRECTABLE which states that the effect on SMART tests is vendor specific.</p> <p>22) Implemented issue #167. Integrated e06190r3 to clarify the interaction of NV Cache with media. This proposal attempts to modify the wording in the TCQ feature set regarding the operation of NOP Poll. The text mentioned in e06190r3 was turned into a note and changed. The note was changed to match the intention of e06190r3. Editors note 3 was intended to add word 21 bits 14 & 15 to DCO Set, but the description was incomplete. Additional words were taken from the same definition in DCO Identify.</p> <p>23) Integrated e05122r6. This is an annex that provides some guidelines for implementing 1K/4K sectors. The February 2007 minutes listed this a e05122r6 as revised. It really meant e05122r5 as revised.</p> <p>24) Integrated e07122r0. This changes the reference for IEEE P1667 to IEEE 1667 in TRUSTED SEND and TRUSTED RECEIVE.</p> <p>25) Integrated e07112r1. This removed some of the WRITE UNCORRECTABLE options.</p> <p>26) Implemented issue #180. Added SATA 2.6 to the IDENTIFY DEVICE data transport standard reporting mechanism.</p> <p>27) Incorporated e07130r1. This added documentation on the various bit/field interactions to IDENTIFY DEVICE data.</p> <p>28) Main system was upgraded to Vista Ultimate and Office 2007. as a result, frame maker 7.2 would not allow Visio 2007 drawing to be inserted directly, they now need to be inserted as Windows Meta Files. All figures were reinserted using this format. Some figures had not been converted to Visio, these figures were also converted and then reinserted. The Long logical long physical example figure was changed to use 1K physical sectors instead of 2K. The original drawing was inconsistent in the size of its boxes and the 2K example did not look good in the conversion.</p>

Revision History (part 17 of 21)		
Rev	Date	Description
4	May 15, 2007	<ol style="list-style-type: none"> 1) Implemented issue #183. Changed both the word 85 bit 3 of both IDENTIFY DEVICE data table and the description. 2) Implemented issue #185. Broke the error outputs paragraph for READ FPDMA and WRITE FPDMA into 2 pieces. 3) Implemented issue #186. If the host attempts to change the Master Password Identifier to an invalid value, the drive was required to report command aborted. This issue changes the text to allow the drive to successfully complete the command without changing the Identifier. 4) Implemented issue #187. Added WRITE UNCORRECTABLE to table 9 which describes the interaction of the Security feature set with all ATA commands. 5) Implemented issue #184. The statement that was voted in needed some wordsmithing to make sense in the command description of NV CACHE DISABLE. 6) Incorporated e07131r3. This incorporates the remainder of the material from SATA 2.5. This complements e06150. 7) Incorporated e07155r1. Assigned IDENTIFY DEVICE data word 217 to report the RPM of the media. This is a mandatory field. However, the device may return 0000h to indicate that it is not telling. 8) Incorporated e07139r3. This was a line-by-line review performed by Seagate and ten reviewed by T13. The changes that were accepted by the group are marked accepted. The changes were marked Migration Complete as they were incorporated. 9) Scrubbed the doc for can, cannot, will, could, would and won't. 10) scanned the document for all references to "remov", found several references to removable media capability that should have been taken out earlier. This included the footnote in the IDENTIFY (PACKET) DEVICE data table for the definition of "F". Also found several references to media status notification. The WP bit was removed and the references were marked obsolete as a result of e07139. 11) Updated the command codes sorted by command name table (table B.3). This table should remain correct since no new commands are expected to be added beyond this point. 12) Scanned the entire document for usage for the word "log". Changed usages of log, log address, log page, and 512-byte data block to be self consisted. Added definitions of log, log address, log page, and log command to the definition of terms. Also added an explanation of the terms to annex A (second paragraph). 13) Changed references in SCT (Clause 8 and Annex D) from key sector to key page. This matches the changes made in #12 above. 14) Implemented issue #53. This incorporates e03124r12. This proposal has been under development for almost 4 years. I integrated all the state transition diagrams and associated text. I only integrated the blue text into the feature set description. I was concerned that wordings have been updated over the course of the years and did not want to break things again. 15) performed a full spell-check. Found and normalized inconsistent usage of the terms "read lookahead", "read ahead", "look ahead", etc. 16) Wordsmithed out the word comprise.
4a	May 22, 2007	<ol style="list-style-type: none"> 1) Inserted re-worked HPA state transition diagrams. 2) Implemented issue #177. Added text which better describes the Free-fall Control feature set.

Revision History (part 18 of 21)		
Rev	Date	Description
4b	July 4, 2007	<ol style="list-style-type: none"> 1) Converted all references from 1K, 4K, and 32K to 1,024 byte, 4,096 byte, and 32,768 byte. This included modifying 2 of the figures in Annex E. 2) Removed the word "proposed" from the examples in the Long Physical Sector feature set. 3) Scanned the document for feature set names and made sure that they were all mixed case. 4) Although the title of the DM Mode 3 proposal included the word Segmented, the name of the feature was changed before it was incorporated. Changed the IDENTIFY DEVICE data words to reference the actual name of the feature. 5) Scanned the document for ".", ",", and ";" to make sure that spacing is consistent. 6) Normalized ie and eg references to "i.e.," and "e.g.," 7) Normalized references to WRITE UNCORRECTABLE to always be WRITE UNCORRECTABLE EXT in all caps. 8) Change the log address table (A.1) to show SCT for the feature set associated with log addresses E0 and E1. 9) Fixed the inputs for READ LOG EXT and WRITE LOG EXT 10) Fixed reference in DEVICE CONFIGURATION FREEZE LOCK which was not hot 11) Change DCO state transition diagram. DCO2 was called "Reduced_Config" in ATA/ATAPI-7 but had been accidentally changed to DCO_reduced_config. I restored the original name. 12) Changed the DRQ bit to read status bit 3 instead of status bit 4. 13) Added command protocol to headers that were missing them. This included all the TRUSTED commands. 14) Normalized all SCT commands so they are referred to as "SCT ... command". 15) Implemented issue #188. Changed the text for IDENTIFY DEVICE data word 219 to read "amount of time in seconds" 16) Implemented issue #189. Changed the description of SECURITY ERASE UNIT to allow normal erase to clear the entire LBA space, even if the device was made smaller through DCO SET. Also remove the term "user data area" and replaced it with explicit LBA ranges. 17) Implemented issue #196. Added Set Maximum Host Interface Sector Times to feature set description for streaming. 18) Implemented issue #198. Clarified in READ/WRITE LOG EXT that the first page is numbered zero. Created a subclause for page #. 19) Implemented issue #199. Added transport major and minor numbers to IDENTIFY PACKET DEVICE data. This was a fairly large change because the Packet table had a different number of columns than the IDENTIFY DEVICE data table. I added 2 columns to the packet table to make data manipulation easier in the future. 20) Implemented issue #200. Added APM to IDENTIFY PACKET DEVICE data table words 83 & 86 bit 3. The text already refers to IDENTIFY DEVICE data. 21) Implemented issue #201. Fixed the description for DCO FREEZE LOCK to properly state that you only exit the DCO_Locked state on a power cycle. 22) Implemented issue #202. Changed DCO IDENTIFY to use the term "is changeable" in place of the term "is allowed" This required some wordsmithing of the text.

Revision History (part 19 of 21)		
Rev	Date	Description
4b	July 4, 2007	<p>23) Implemented issue #203. Change IDENTIFY PACKET DEVICE data text to indicate that the serial number either conforms to ATA String Requirements or is zero.</p> <p>24) Implemented issue #204. Changed transfer length of zero to be an error instead of no data transfer. This differs from the SCSI implementation.</p> <p>25) Implemented issue #205. Removed transition H1b:HS5 from the HPA not set state transition diagram.</p> <p>26) Incorporated e07158r1. This proposal doubles the number of vendor specific log addresses</p> <p>27) Incorporated e07129r2. This added several defined terms and created the new data type ATA String. All these changes are intended to be editorial.</p> <p>28) Incorporated e07163r1. This is a set of comment resolutions from HP and June plenary meeting review. All these changes are intended to be editorial.</p> <p>29) Normalized usage of the word address. Acceptable terms are Log Address, LBA, LBAs, and Logical Sector. Changed "Logical Sector Address", "Address of Logical Sector", and ... address to refer to one of the previously listed terms.</p> <p>30) Performed a global scan on the word mode and replaced it with state wherever it references a state in a state machine. Did not change references to Active mode, standby mode, idle mode, and sleep mode because these terms are defined in the associated command descriptions. At some point we may want to change these to proper state references.</p> <p>31) Performed a global scan for the word must.</p> <p>32) Added 28-bit and 48-bit designations in the feature sets for all the commands. Also added 28-bit command and 48-bit command to the definition of terms.</p> <p>33) Removed the bits 15:8 and bits 47:28 shall be cleared to zero from 28-bit commands.</p> <p>34) Added the feature set subclause to all the NV Cache commands to make the consistent with all the other commands.</p> <p>35) Added regiser and FIS mappings for ATA/ATAPI-7.</p>

Revision History (part 20 of 21)		
Rev	Date	Description
4c	November 26, 2007	<ol style="list-style-type: none"> 1) Incorporated e07170r7. This is the results of the first round letter ballot comment resolutions. Approx 2500 comments were incorporated as a part of these resolutions. <ol style="list-style-type: none"> 1) Since the definitions of Security is Enabled/Disabled/... have been removed, several comments that changed the case of these terms have been changed from accepted to rejected. 2) The text for SEC1 lists SEC1:SEC1 as SECURITY SET (master) PASSWORD. This was not in ATA/ATAPI-7, nor was it in the state transition diagram. The text is correct and the self transition was added to the diagram. 3) The text for SEC4 lists SEC4:SEC4 as SECURITY UNLOCK with varoius conditions as well as SECURITY ERASE PREPARE, but there is no transition listed in the state transition diagram. The text is correct and the self transition was added to the diagram. 4) Removed prohibited statements from clause 4 since they are all in the table. 5) Fixed and error in table 47. The table lists the Abort bit set to one and the error bit cleared to zero. This is an invalid ATA condition. The error bit should also be set to one. This fits the definition of commands aborted. 6) Added a trademark statement in the introduction. Also changed WIndows to Windows[®]. Used the microsoft site http://www.microsoft.com/about/legal/intellectualproperty/trademarks/usage/general.aspx for guidelines. 7) Integrated e07173r4 <ol style="list-style-type: none"> 1) Converted Queued Normal Output table 117 and found that SActive was not listed in clause 6. Also, had to create SATA Status field to cover the additional status data returned as a part of the SDB FIS. 8) Integrated e07161r2. This adds nominal form factor reporting. Assigned IDENTIFY DEVICE data word 168 bits (3:0) 9) Updated GPL commands in clause 8 and annex D to properly show the page # field as split in half. These were not updated with clause 7 was updated. 10) Updated command examples in Annex D to include the device field. 11) Removed the this bit is valid if... statement from IDENTIFY DEVICE data word 83 bit 6 12) Changed IDENTIFY DEVICE data word 86 bit 6 to be a copy of word 83 bit 6. 13) Modified SMART READ DATA command to have an Input From the Device to the Host Data Structure subclause and moved the description of the data to this new subclause. 14) Observation: NV Cache is the only set of non-media access commands which transfer their data in DMA. 15) Changed Security Erase Unit to allow Normal mode erase with 0's or 1's. Motion to incorporate passed 6-2-5

Revision History (part 21 of 21)		
Rev	Date	Description
5	April 24, 2008	1) Integrated e08110r4 - First round letter ballot comments. <ol style="list-style-type: none"> 1) While change the phrase "shall make a transition to" to "shall transition to", found that the Power Management state machine had been missed. Incorporated these changes as a part of a global replace. 2) Deleted HEL1:HES4 from the HES transition description. This was already in the HEL transition descriptions. 3) Resolution to comment on PM2: Standby was ambiguous. Added list element G which included resets from PM3 as suggested by the comment. 4) In E.4.3, fixed error which recommended 4006h for windows XP instead of 4001h. 5) Integrated command on 4.11.3 because that was the voted resolution. However, the last sentence of 4.11.3 no longer says anything.
6	June 25, 2008	1) Incorporated e08125r0 <ol style="list-style-type: none"> 1) Added Minor version 0028h for this version 2) Changed 3.25" nominal form factor in table 36 to 3.5"
6a	September 16, 2008	1) Added editorial changes from Harvey Rosenfield <ol style="list-style-type: none"> 1) Updated the forward to add text that was lost in ATA/ATAPI-7 2) In subclause 3.2.8, there are several reference of the form (see table x in w.y.z). This is an inconsistent reference form and was changed to say (see table x) 3) In subclause 3.2.8 ("exceptions to this conventions include, b)there is a reference to 7.16.7.52. This should have been 7.16.7.56. 4) Deleted parenthetical in 4.16.3.3. The references were incorrect and the paranthetical did not really add to the text. 5) In the 4th paragraph of C.3 there is a reference to figure 10. This reference is not hotlinked. Changed reference to Figure C.1. 6) Changed key in table B.1 to show that "*" means changed from ATA/ATAPI-7. ATA8-ACS has no previous versions. 7) Changed key in table B.5 to add "*Indicates this definition is new to ATA8" 2) Added approved changes from Seagate public review comments <ol style="list-style-type: none"> 1) In 7.16.7.39 bit 1 of word 85, the cross references were incorrect. The parenthetical was deleted. 2) In table 110, changed the definition of LBA bits 28:3 to indicate that all other values are undefined. 3) In A.15.1 first sentence, changed "make" to "makes". 4) In table B.2 and table B.3, opcode 91 is listed as reserved instead of obsolete. This was INITIALIZE DEVICE PARAMETERS and was obsoleted when CHS was removed from ATA/ATAPI-6.

New Capabilities added to ATA8-ACS

Integrated Proposal List		
#	Doc	Description
1	e04139r4	Restructured all commands to conform to this format
2	e04143r0	Incorporated single log table
3	e04127r0	Makes SATA signatures reserved with no description.
4	e04143r1	Changes text to clarify that the Host Vendor Specific pages are common to both SMART READ LOG and READ LOG EXTENDED
5	e04130r2	Clarifies the definition of SMART first polling time. Also adds a field that enables longer times.
6	e05103r0	Changes the features register to log page specific for read and write log commands
7	e04153r1	Historical annex of command documentation
8	e05102r1	Reserves some set features and DCO fields as vendor specific
9	e04129r6	New Feature: Write-Read-Verify
10	e04161r0	obsoleted ATAPI overlap and queue
11	e05130r0	Extended support and enabled bits to IDENTIFY DEVICE data words 119 & 120
12	e05131r1	Clarifies that drive behavior is indeterminate if IDENTIFY DEVICE data indicates that the feature is not supported
13	e05120r2	New Feature: Allows the drive to report a logical sector alignment requirements within a physical sector
14	e04132r1	New Feature: Defines subcommand 03 (segmented download) for download microcode
15	e04162r0	Obsoleted DOWNLOAD MICROCODE subcommand 01- temporary use
16	e05151r1	Reserved opcodes for e05106
17	e02126r6	New Feature: WRITE UNCORRECTABLE EXT
18	e05127r2	Updated the definition of the DF bit
19	e05129r1	New Feature: READ/WRITE LOG DMA EXT
20	e05132r1	New Feature: Report transport standard
21	e05140r0	Clarifies Media Serial Number Endianness
22	e05162r0	Clarifies SECURITY ERASE UNIT to require an abort if no passwords have been set in the drive
23	e05161r0	New Feature: Adds GPL support and reporting in ATAPI PACKET IDENTIFY DEVICE
24	e05167r0	Updated the block size by command table to include missing elements
25	e05109r4	New Feature: SCT
26	e05170r1	New Feature: Add capability to SCT so write same can be performed as a foreground process
27	e05154r4	Update streaming
28	e05150r2	Reserve resources for CE-ATA
29	e05178r0	New Feature: WWN is Mandatory
30	e05160r0	Clarifies flush cache operation when write cache is disabled
31	e05162r2	New Feature: Adds to the Download Microcode Mode 3 capability by allowing the drive to report minimum and maximum transfer sizes. Also provides a mechanism for the drive to indicate when the microcode has been applied.
32	e05139r7	New Feature: Adds commands to support the Trusted Computing Group
33	e05106r7	New Feature: Adds commands to manipulate NV cache in hybrid devices
34	e06127r0	New Feature: Assigns a Security Protocol to IEEE P1667
35	e06125r0	Updates IDENTIFY PACKET DEVICE to better match ATAPI operation
36	e06116r0	Obsoleted the Removable Media and Media Status Notification feature sets
37	e06128r1	Clarifies a variety of issues surrounding resets
38	e06121r1	New Feature: Adds an IDENTIFY DEVICE data field to report the current Write-Read-Verify mode.

Integrated Proposal List		
#	Doc	Description
39	e06123r0	New Feature: Allows READ LOG EXT to succeed even when the drive is locked.
40	e05162r0	Clarifies SECURITY ERASE UNIT to add the explicit statement that a password can be set prior to issuing SECURITY ERASE UNIT if a password had not been previously set
41	e06153r1	Reserves SCT resources for use by SATA-IO
42	e06152r3	New Feature: Adds session and lifetime min and max temperature reporting to SCT Status. Also provides some concept of time since last temperature beyond operating limits.
43	e06102r2	New Feature: Creates a Device Statistics Log for documenting counters. The first counter defined documents lifetime power-on resets.
44	e05179r8	Clarifies the operation of the Security feature set without changing operation relative to ATA/ATAPI-7. There is a second proposal that will be integrated into ACS-2 to close some of the security holes.
45	e06150r5	Adds the definition of FPDMA Read and Write commands as defined in Serial ATA Rev 2.5
46	e06144r6	New Feature: Adds the ability to control a Free Fall sensor in the device.
47	e06126r3	Clarifies the operation of NOP and makes a variety of unrelated small changes.
48	e06190r3	Clarifies the interaction of Cache, NV Cache, and Media.
49	e05122r6	Adds annex E which contains guidelines for implementing 1K and 4K physical sector drives
50	e07122r0	Changed reference from IEEE P1667 to IEEE 1667
51	e07112r1	Reduces the number of options available in WRITE UNCORRECTABLE EXT
52	e07130r1	Adds documentation to IDENTIFY DEVICE data which shows the interaction of the various bits and fields.
53	e07131r3	Adds SATA 2.5 material which was not addressed by e06150. This includes SSP, Phy Counter log pages, and SET FEATURES.
54	e07155r1	New Feature: Requires a device with rotating media to populate IDENTIFY DEVICE word 217.
55	e03124r12	Updates the HPA feature set to better clarify the interaction of the 28-bit and 48-bit versions on the HPA commands.
56	e07158r1	Doubles the number of Vendor Specific log addresses
57	e07129r2	Reworks the byte, word, DWord, and QWord conventions and adds the ATA string convention.
58	e07161r2	Adds Form Factor reporting
59	e07173r4	Reworks the overview, command inputs and command output table formats.
60	e07170r7	First round letter ballot comments.
61	e08125r0	Corrections to letter ballot comment resolution incorporation

Contents

	Page
Points of Contact.....	ii
Document Status	v
New Capabilities added to ATA8-ACS.....	xxvi
Contents.....	xxix
Tables	xxxvii
Figures	xli
Foreword.....	xliii
Introduction	xliii
1 Scope	1
2 Normative references	2
2.1 General	2
2.2 Approved references	2
2.3 References under development	3
2.4 Other references	3
3 Definitions, abbreviations, and conventions	4
3.1 Definitions and abbreviations	4
3.2 Conventions	7
3.2.1 Overview	7
3.2.2 Precedence	7
3.2.3 Lists	7
3.2.4 Keywords	8
3.2.5 Numbering	9
3.2.6 Bit conventions	9
3.2.7 State diagram conventions	10
3.2.8 Byte, word, DWord, and QWord Relationships	11
3.2.9 ATA string convention	13
4 Feature set definitions	14
4.1 Overview	14
4.2 General feature set	14
4.3 The PACKET feature set	15
4.3.1 Overview	15
4.3.2 Identification of PACKET feature set devices	16
4.3.3 Signature for ATAPI devices	16
4.3.4 The PACKET command	16
4.4 48-bit Address feature set	16
4.5 Advanced Power Management (APM) feature set	17
4.6 Automatic Acoustic Management (AAM) feature set	17
4.7 CompactFlash Association (CFA) feature set	17
4.8 Device Configuration Overlay (DCO) feature set	18
4.9 Free-fall Control feature set	20
4.10 General Purpose Logging (GPL) feature set	20
4.11 Host Protected Area (HPA) feature set	21
4.11.1 HPA overview	21

4.11.2 HPA security extensions	21
4.11.3 28-bit and 48-bit HPA commands interactions	21
4.11.4 IDENTIFY DEVICE data	23
4.11.5 Determination of SET MAX security extension status	23
4.11.6 HPA State Transition Diagrams	23
4.12 Long Logical Sector (LLS) feature set	39
4.13 Long Physical Sector (LPS) feature set	40
4.14 Media Card Pass Through Command feature set	42
4.15 Native Command Queuing (NCQ) feature set	42
4.15.1 Overview	42
4.15.2 Command Phases	43
4.16 NV Cache feature set	43
4.17 NV Cache Power Management feature set	45
4.18 Power Management feature set	45
4.18.1 Overview	45
4.18.2 Power management commands	46
4.18.3 Standby timer	46
4.18.4 Power modes	47
4.19 Power-Up In Standby (PUIS) feature set	48
4.20 Security feature set	49
4.20.1 Overview	49
4.20.2 Passwords	49
4.20.3 Master Password Capability	49
4.20.4 Frozen Mode	50
4.20.5 Commands	50
4.20.6 IDENTIFY DEVICE data	50
4.20.7 Security initial setting	50
4.20.8 Password Rules	50
4.20.9 Password attempt counter	50
4.20.10 Security states	52
4.20.11 Master Password Identifier feature	62
4.21 Self-Monitoring, Analysis, and Reporting Technology (SMART) feature set	63
4.21.1 Overview	63
4.21.2 Device SMART data structure	63
4.21.3 Background data collection	63
4.21.4 Off-line/Captive mode data collection	63
4.21.5 Threshold exceeded condition	63
4.21.6 SMART feature set commands	63
4.21.7 SMART operation with power management modes	63
4.21.8 SMART device error log reporting	64
4.22 Software Settings Preservation (SSP) feature set	64
4.23 Streaming feature set	64
4.23.1 Streaming feature set overview	64
4.23.2 Streaming commands	65
4.24 Tagged Command Queuing (TCQ) feature set	66
4.24.1 Overview	66
4.24.2 Queueing	67
4.25 Trusted Computing feature set	67
4.26 Write-Read-Verify feature set	67
5 ATA protocols	69
6 Normal and Error Output field descriptions	70
6.1 Overview	70
6.2 Status field	70
6.2.1 Overview	70
6.2.2 Busy bit	70

6.2.3 Check Condition bit	70
6.2.4 Data Request bit	70
6.2.5 Deferred Write Error bit	70
6.2.6 Device Fault bit	71
6.2.7 Device Ready bit	71
6.2.8 Error bit	71
6.2.9 Service bit	71
6.2.10 Stream Error bit	71
6.2.11 Transport Dependent (TD)	71
6.3 Error field	72
6.3.1 Overview	72
6.3.2 Abort bit	72
6.3.3 Attempted Partial Range Removal bit	72
6.3.4 Command Completion Time Out bit	72
6.3.5 End of Media bit	72
6.3.6 ID Not Found bit	72
6.3.7 Illegal Length Indicator bit	72
6.3.8 Insufficient LBA Range Entries Remaining bit	73
6.3.9 Insufficient NV Cache Space bit	73
6.3.10 Interface CRC bit	73
6.3.11 Media Error bit	73
6.3.12 Sense Key field	73
6.3.13 Uncorrectable Error bit	73
6.4 Interrupt Reason field	73
6.4.1 Overview	73
6.4.2 Command/Data bit	73
6.4.3 Input/Output (I/O) bit	73
6.4.4 Release bit	73
6.4.5 Tag field	73
6.5 Count field	74
6.5.1 overview	74
6.5.2 NCQ Tag field	74
6.6 SActive field	74
6.7 SATA Status	74
7 Command descriptions	75
7.1 Command descripton introduction	75
7.1.1 Overview	75
7.2 CFA ERASE SECTORS - C0h, Non-Data	79
7.3 CFA REQUEST EXTENDED ERROR CODE - 03h, Non-Data	80
7.4 CFA TRANSLATE SECTOR - 87h, PIO Data-In	82
7.5 CFA WRITE MULTIPLE WITHOUT ERASE - CDh, PIO Data-Out	84
7.6 CFA WRITE SECTORS WITHOUT ERASE - 38h, PIO Data-Out	85
7.7 CHECK MEDIA CARD TYPE - D1h, Non-Data	86
7.8 CHECK POWER MODE - E5h, Non-Data	87
7.9 CONFIGURE STREAM - 51h, Non-Data	88
7.10 Device Configuration Overlay (DCO)	90
7.10.1 DCO Overview	90
7.10.2 DEVICE CONFIGURATION FREEZE LOCK - B1h/C1h, Non-Data	91
7.10.3 DEVICE CONFIGURATION IDENTIFY - B1h/C2h, PIO Data-In	92
7.10.4 DEVICE CONFIGURATION RESTORE - B1h/C0h, Non-Data	96
7.10.5 DEVICE CONFIGURATION SET - B1h/C3h, PIO Data-Out	97
7.11 DEVICE RESET - 08h, Device Reset	106
7.12 DOWNLOAD MICROCODE - 92h, PIO Data-Out/Non-Data	107
7.13 EXECUTE DEVICE DIAGNOSTIC - 90h, Execute Device Diagnostic	110
7.14 FLUSH CACHE - E7h, Non-Data	112
7.15 FLUSH CACHE EXT - EAh, Non-Data	113

7.16 IDENTIFY DEVICE - ECh, PIO Data-In	114
7.17 IDENTIFY PACKET DEVICE - A1h, PIO Data-In	153
7.18 IDLE - E3h, Non-Data	171
7.19 IDLE IMMEDIATE - E1h, Non-Data	172
7.20 Non-Volatile Cache	174
7.20.1 NV Cache Overview	174
7.20.2 NV Cache Power Management Overview	174
7.20.3 ADD LBA(S) TO NV CACHE PINNED SET - B6h/10h, DMA	176
7.20.4 FLUSH NV CACHE - B6h/14h, Non-Data	178
7.20.5 NV CACHE DISABLE- B6h/16h, Non-Data	179
7.20.6 NV CACHE ENABLE - B6h/15h, Non-Data	180
7.20.7 QUERY NV CACHE MISSES - B6h/13h, DMA.....	181
7.20.8 QUERY NV CACHE PINNED SET - B6h/12h, DMA.....	183
7.20.9 REMOVE LBA(S) FROM NV CACHE PINNED SET - B6h/11h, DMA/Non-Data	184
7.20.10 RETURN FROM NV CACHE POWER MODE - B6h/01h, Non-Data.....	186
7.20.11 SET NV CACHE POWER MODE - B6h/00h, Non-Data	187
7.21 NOP - 00h, Non-Data	188
7.22 PACKET - A0h, Packet	189
7.23 READ BUFFER - E4h, PIO Data-In	192
7.24 READ DMA - C8h, DMA	193
7.25 READ DMA EXT - 25h, DMA	194
7.26 READ DMA QUEUED - C7h, DMA Queued	195
7.27 READ DMA QUEUED EXT- 26h, DMA Queued	197
7.28 READ FPDMA QUEUED - 60h, DMA Queued	199
7.29 READ LOG EXT - 2Fh, PIO Data-In	200
7.30 READ LOG DMA EXT - 47h, DMA	202
7.31 READ MULTIPLE - C4h, PIO Data-In	203
7.32 READ MULTIPLE EXT - 29h, PIO Data-In	204
7.33 READ NATIVE MAX ADDRESS - F8h, Non-Data	205
7.34 READ NATIVE MAX ADDRESS EXT - 27h, Non-Data	206
7.35 READ SECTOR(S) - 20h, PIO Data-In	207
7.36 READ SECTOR(S) EXT - 24h, PIO Data-In	208
7.37 READ STREAM DMA EXT - 2Ah, DMA	209
7.38 READ STREAM EXT - 2Bh, PIO Data-In	212
7.39 READ VERIFY SECTOR(S) - 40h, Non-Data	213
7.40 READ VERIFY SECTOR(S) EXT - 42h, Non-Data	214
7.41 SECURITY DISABLE PASSWORD - F6h, PIO Data-Out	215
7.42 SECURITY ERASE PREPARE - F3h, Non-Data	217
7.43 SECURITY ERASE UNIT - F4h, PIO Data-Out	218
7.44 SECURITY FREEZE LOCK - F5h, Non-Data	220
7.45 SECURITY SET PASSWORD - F1h, PIO Data-Out	221
7.46 SECURITY UNLOCK - F2h, PIO Data-Out	223
7.47 SERVICE - A2h, DMA Queued	225
7.48 SET FEATURES - EFh, Non-Data	226
7.48.3 Enable/disable 8-bit PIO data transfer	228
7.48.4 Enable/disable volatile write cache	228
7.48.5 Set transfer mode	228
7.48.6 Enable/disable the APM feature set	229
7.48.7 Enable/disable the PUIS feature set	230
7.48.8 PUIS feature set device spin-up	230
7.48.9 Enable/disable CFA power mode 1	230
7.48.10 Enable/Disable Write-Read-Verify feature set	230
7.48.11 Enable/disable the AAM feature set	231
7.48.12 Set Maximum Host Interface Sector Times	232
7.48.13 Enable/disable read look-ahead	232
7.48.14 Enable/disable release interrupt	232
7.48.15 Enable/disable SERVICE interrupt	232

7.48.16 Enable/disable reverting to defaults	232
7.48.17 Enable/Disable the Free-fall Control feature set	233
7.48.18 Enable/Disable SATA feature	233
7.49 SET MAX	235
7.49.2 SET MAX ADDRESS - F9h, Non-Data	236
7.49.3 SET MAX FREEZE LOCK – F9h/04h, Non-Data	238
7.49.4 SET MAX LOCK - F9h/02h, Non-Data	239
7.49.5 SET MAX SET PASSWORD - F9h/01h, PIO Data-Out	240
7.49.6 SET MAX UNLOCK - F9h/03h, PIO Data-Out	241
7.50 SET MAX ADDRESS EXT - 37h, Non-Data	242
7.51 SET MULTIPLE MODE - C6h, Non-Data	244
7.52 SLEEP - E6h, Non-Data	246
7.53 SMART	247
7.53.2 SMART DISABLE OPERATIONS - B0h/D9h, Non-Data	248
7.53.3 SMART ENABLE/DISABLE ATTRIBUTE AUTOSAVE - B0h/D2h, Non-Data	249
7.53.4 SMART ENABLE OPERATIONS - B0h/D8h, Non-Data	251
7.53.5 SMART EXECUTE OFF-LINE IMMEDIATE - B0h/D4h, Non-Data	252
7.53.6 SMART READ DATA - B0h/D0h, PIO Data-In	256
7.53.7 SMART READ LOG - B0h/D5h, PIO Data-In	261
7.53.8 SMART RETURN STATUS - B0h/DAh, Non-Data	262
7.53.9 SMART WRITE LOG - B0h/D6h, PIO Data-Out	263
7.54 STANDBY - E2h, Non-Data	264
7.55 STANDBY IMMEDIATE - E0h, Non-Data	265
7.56 TRUSTED NON-DATA - 5Bh, Non-Data	266
7.57 TRUSTED RECEIVE - 5Ch, PIO Data-In	267
7.58 TRUSTED RECEIVE DMA - 5Dh, DMA	272
7.59 TRUSTED SEND - 5Eh, PIO Data-Out	273
7.60 TRUSTED SEND DMA - 5Fh, DMA	276
7.61 WRITE BUFFER - E8h, PIO Data-Out	277
7.62 WRITE DMA - CAh, DMA	278
7.63 WRITE DMA EXT - 35h, DMA	279
7.64 WRITE DMA FUA EXT - 3Dh, DMA	280
7.65 WRITE DMA QUEUED - CCh, DMA Queued	281
7.66 WRITE DMA QUEUED EXT - 36h, DMA Queued	283
7.67 WRITE DMA QUEUED FUA EXT - 3Eh, DMA Queued	285
7.68 WRITE FPDMA QUEUED - 61h, DMA Queued	286
7.69 WRITE LOG EXT - 3Fh, PIO Data-Out	287
7.70 WRITE LOG DMA EXT - 57h, DMA	289
7.71 WRITE MULTIPLE - C5h, PIO Data-Out	290
7.72 WRITE MULTIPLE EXT - 39h, PIO Data-Out	291
7.73 WRITE MULTIPLE FUA EXT - CEh, PIO Data-Out	292
7.74 WRITE SECTOR(S) - 30h, PIO Data-Out	293
7.75 WRITE SECTOR(S) EXT - 34h, PIO Data-Out	294
7.76 WRITE STREAM DMA EXT - 3Ah, DMA	295
7.77 WRITE STREAM EXT - 3Bh, PIO Data-Out	298
7.78 WRITE UNCORRECTABLE EXT - 45h, Non-Data	299
8 SCT Command Transport	301
8.1 Introduction	301
8.1.1 Overview	301
8.1.2 SCT command nesting and interspersing with standard commands	301
8.1.3 Resets	301
8.2 Processing SCT commands	302
8.2.1 Processing SCT commands overview	302
8.2.2 SCT capability identification	302
8.2.3 SCT command transfer	302
8.2.4 SCT data transfer	306

8.2.5 SCT status	308
8.3 SCT Command Set	312
8.3.1 Overview	312
8.3.2 SCT Read/Write Long command	313
8.3.3 SCT Write Same command	316
8.3.4 SCT Error Recovery Control command	319
8.3.5 SCT Feature Control command	321
8.3.6 SCT Data Table command.....	324
9 Normal and Error Outputs	328
9.1 Overview	328
9.2 Normal Outputs	328
9.3 Error Outputs	348
Annex A (Normative) Log Definitions	391
A.1 Overview	391
A.2 General Purpose Log Directory (GPL Log Address 00h)	393
A.3 SMART Log Directory (SMART Logging Log Address 00h)	393
A.4 Comprehensive SMART Error Log (Log Address 02h)	393
A.5 Device Statistics (Log Address 04h)	395
A.6 Device Vendor Specific Logs (Log Addresses A0h-DFh)	396
A.7 Extended Comprehensive SMART Error log (Log Address 03h)	396
A.8 Extended SMART Self-Test Log (Log Address 07h)	400
A.9 Host Vendor Specific Logs (Log Addresses 80h-9Fh)	401
A.10 NCQ Command Error (Log Address 10h)	402
A.11 Read Stream Error Log (Log Address 22h)	403
A.12 SATA Phy Event Counters (Log Address 11h)	404
A.13 Selective Self-Test Log (Log Address 09h)	406
A.14 SMART Self-Test Log (Log Address 06h)	408
A.15 Summary SMART Error Log (Log Address 01h)	409
A.16 Write Stream Error Log (Log Address 21h)	412
Annex B (Informative) Command Set summary.....	415
Annex C (Informative) Design and programming considerations for large physical sector devices	441
C.1 Introduction	441
C.2 Physical sectors	441
C.3 Unaligned write	441
C.4 SET MAX	442
C.5 Software compatibility	442
Annex D (Informative) How to use SCT commands	443
D.1 How to use SCT commands overview	443
D.2 Examples of Log page command sequences	445
D.3 Issuing an SCT command to a device	449
D.3.1 Step 1 - Build a Key Page	449
D.3.2 Step 2 - Issue the SCT command	450
D.3.3 Step 3 - Transfer Data if Required	451
D.3.4 Step 4 - Final Status/SCT Command Completion	452
Annex E (Informative) Implementation Guidelines For 1,024/4,096 Byte Sector Sizes	453
E.1 Introduction	453
E.2 Scope	453
E.3 Overview	453
E.4 Implementation	455
E.4.1 1,024 Byte Sector Size Implementation	455
E.4.2 4,096 Byte Sector Size Implementation	455

E.4.3 Reporting Alignment (512 Byte LBA Only) 455
E.4.4 Read-Modify-Write (RMW) (512-Byte LBA Only) 456
E.5 Implementation Issues (512-Byte LBA Only) 456
E.5.1 Overview 456
E.5.2 Drive Partitioning 457
E.5.3 File System Formatting 458
E.5.4 Virtual Memory accessing 458
E.5.5 Booting 458

Tables

	Page
Table 1 - Approved ANSI References.....	2
Table 2 - References Under Development	3
Table 3 - ATA string byte swapping	13
Table 4 - ATA firmware revision example	13
Table 5 - Feature Set Summary.....	14
Table 6 - Block Size By Command	39
Table 7 - Media Card type references	42
Table 8 - Summary of Security States and Characteristics.....	52
Table 9 - Security Command Actions	53
Table 10 - IDENTIFY settings for Security state SEC1.....	58
Table 11 - IDENTIFY settings for Security state SEC2.....	59
Table 12 - IDENTIFY settings for Security state SEC4.....	60
Table 13 - IDENTIFY settings for Security state SEC5.....	61
Table 14 - IDENTIFY settings for Security state SEC6.....	62
Table 15 - Preserved Feature Sets and Settings.....	64
Table 16 - Status field	70
Table 17 - Error field	72
Table 18 - Interrupt Reason Field	73
Table 19 - Count field.....	74
Table 20 - Example Normal Output	76
Table 21 - Example Error Output	77
Table 22 - Extended error codes	80
Table 23 - CFA TRANSLATE SECTOR data.....	82
Table 24 - Device Configuration Overlay Feature field values.....	90
Table 25 - Device Configuration Identify data structure.....	93
Table 26 - Device Configuration Overlay (DCO) data structure.....	99
Table 27 - Count field output for DOWNLOAD MICROCODE requesting the offset transfer method	108
Table 28 - Diagnostic codes	111
Table 29 - IDENTIFY DEVICE data	115
Table 30 - Specific Configuration.....	133
Table 31 - Minor version number	139
Table 32 - Normal Erase Mode Time.....	145
Table 33 - Enhanced Erase Mode Time	145
Table 34 - IDENTIFY DEVICE data World Wide Name field (word-based view).....	148
Table 35 - IDENTIFY DEVICE data World Wide Name field (byte-based view).....	148
Table 36 - Device Nominal Form Factor	150
Table 37 - Nominal Media Rotation Rate.....	151
Table 38 - Transport minor version number.....	152
Table 39 - IDENTIFY PACKET DEVICE data.....	154
Table 40 - Standby timer periods.....	171
Table 41 - NV Cache Commands	174
Table 42 - NV Cache Power Management Commands.....	175
Table 43 - Request Pin Data.....	177
Table 44 - Cache Miss Data	182
Table 45 - Pin Set Data.....	183
Table 46 - Remove Pin Data.....	185
Table 47 - NOP Subcommand Code	188
Table 48 - SECURITY DISABLE PASSWORD data content.....	216
Table 49 - SECURITY ERASE UNIT data content	219
Table 50 - SECURITY SET PASSWORD data content.....	222
Table 51 - SECURITY UNLOCK data content.....	224
Table 52 - SET FEATURES Feature field definitions.....	226
Table 53 - Transfer modes.....	229
Table 54 - APM levels.....	229
Table 55 - Write-Read-Verify Modes	231

Table 56 - AAM levels	231
Table 57 - SATA Features	233
Table 58 - SET MAX Feature field values	235
Table 59 - SET MAX SET PASSWORD data content	240
Table 60 - SMART Feature field values	247
Table 61 - SMART EXECUTE OFF-LINE IMMEDIATE Subcommands	252
Table 62 - Device SMART data structure	257
Table 63 - Off-line data collection status byte values	258
Table 64 - Self-test execution status values	258
Table 65 - Offline Data Collection Capabilities	259
Table 66 - TRUSTED RECEIVE Security Protocol field description	268
Table 67 - Security Protocol 00h - SP Specific field descriptions for Protocol 00h	269
Table 68 - TRUSTED RECEIVE parameter data for SP Specific=0000h	270
Table 69 - TRUSTED RECEIVE parameter data for SP Specific=0001h	270
Table 70 - TRUSTED SEND - Security Protocol field description	274
Table 71 - Fields to issue an SCT command using SMART WRITE LOG	302
Table 72 - Fields to issue an SCT command using WRITE LOG (DMA) EXT	303
Table 73 - Successful SCT command response	304
Table 74 - SCT command error response	305
Table 75 - Extended Status codes	306
Table 76 - SCT data transfer using SMART READ LOG or SMART WRITE LOG	307
Table 77 - SCT data transfer using the GPL feature set	308
Table 78 - SCT status request using SMART READ LOG	309
Table 79 - SCT status request using the GPL feature set	310
Table 80 - Format of SCT status response	310
Table 81 - SCT command format	312
Table 82 - SCT Action Codes	312
Table 83 - SCT Read/Write Long command	313
Table 84 - SCT Read/Write Long command status response	314
Table 85 - SCT Read/Write Long command Format	315
Table 86 - SCT Write Same command	317
Table 87 - SCT Write Same command status response	318
Table 88 - SCT Error Recovery Control command	319
Table 89 - SCT Error Recovery Control command status response	320
Table 90 - SCT Feature Control command	321
Table 91 - Feature Code List	322
Table 92 - SCT Feature Control command status response	323
Table 93 - SCT Data Table command	324
Table 94 - SCT Data Tables (by Table Identifier)	324
Table 95 - Absolute HDA Temperature	325
Table 96 - SCT Data Table command status response	327
Table 97 - Error Bit Defined For Normal Output	328
Table 98 - Extended Error Code for Normal Output	329
Table 99 - Generic Normal Output (No LBA Return Value) for Normal Output	330
Table 100 - CFA Normal Output	331
Table 101 - Media Card Type Normal Output	332
Table 102 - Check Power Mode Normal Output	333
Table 103 - Stream Normal Output	334
Table 104 - Device Signatures for Normal Output	335
Table 105 - IDLE Unload Normal Output	336
Table 106 - ATAPI Normal Output	337
Table 107 - Queued Normal Output	338
Table 108 - HPA Normal Output	339
Table 109 - SMART Off-Line Immediate Normal Output	340
Table 110 - SMART Return Status Normal Output	341
Table 111 - Generic Extended Normal Output	342
Table 112 - SETMAX Extended Normal Output	343

Table 113 - Queued Extended Normal Output	344
Table 114 - NV Cache Normal Output	345
Table 115 - NV Cache Flush Normal Output	346
Table 116 - NCQ Command Acceptance Normal Output	347
Table 117 - NCQ Normal Outputs	347
Table 118 - Unsupported Command Error	348
Table 119 - CFA Erase Error	349
Table 120 - CFA Write Error	350
Table 121 - CFA & Check Power Mode Abort Error	351
Table 122 - Generic Abort wo/ICRC Error	352
Table 123 - Generic Abort Error	353
Table 124 - Trusted Abort Error	354
Table 125 - Generic SET MAX Error	355
Table 126 - SET MAX Unlock Error	356
Table 127 - Configure Stream Error	357
Table 128 - Flush Cache Error	358
Table 129 - Flush Cache Ext Error	359
Table 130 - Read DMA Error	360
Table 131 - Read DMA Ext Error	361
Table 132 - Read Log Ext Error	362
Table 133 - Read PIO Error	363
Table 134 - Read Stream Error	364
Table 135 - HPA Error	365
Table 136 - Write Log Error	366
Table 137 - Write Log Ext Error	367
Table 138 - SMART Error	368
Table 139 - Write Extended Error	369
Table 140 - Write Stream Error	370
Table 141 - DCO Set Error	371
Table 142 - NOP Error	372
Table 143 - PACKET command Error	373
Table 144 - Read DMA Queued Error	374
Table 145 - Read DMA Queued Extended Error	375
Table 146 - SMART Read Log/SMART Read Data Error	376
Table 147 - Read PIO Extended Error	377
Table 148 - Read Native Max Extended Error	378
Table 149 - SETMAX Extended Error	379
Table 150 - Write Error	380
Table 151 - Write DMA Error	381
Table 152 - Write DMA Queued Error	382
Table 153 - NV Cache Add Abort Error	383
Table 154 - NV Cache Remove Abort Error	384
Table 155 - NV Cache Abort Error	385
Table 156 - NV Cache Abort with Data Transfer Error	386
Table 157 - NCQ Command Acceptance Error	387
Table 158 - NCQ Write Command Aborted Error	388
Table 159 - NCQ Read Command Aborted Error	389
Table A.1 - Example Log Structure	391
Table A.2 - Log address definition	392
Table A.3 - General Purpose Log Directory	393
Table A.4 - SMART Log Directory	393
Table A.5 - Comprehensive error log	394
Table A.6 - General Statistics	395
Table A.7 - Extended Comprehensive SMART error log	396
Table A.8 - Extended Error log data structure	397
Table A.9 - Command data structure	398
Table A.10 - Error data structure	399

Table A.11 - State field values 399

Table A.12 - Extended Self-test log data structure 400

Table A.13 - Extended Self-test log descriptor entry 401

Table A.14 - NCQ Command Error Log 402

Table A.15 - Read Stream Error Log 403

Table A.16 - Stream Error Log Entry 404

Table A.17 - SATA Phy Event Counters Format 405

Table A.18 - Selective self-test log 406

Table A.19 - Selective self-test feature flags 407

Table A.20 - Self-test log data structure 408

Table A.21 - Self-test log descriptor entry 408

Table A.22 - Summary SMART Error log 409

Table A.23 - Error log data structure 410

Table A.24 - Command data structure 411

Table A.25 - Error data structure 411

Table A.26 - State field values 412

Table A.27 - Write Stream Error Log 413

Table B.1 - Command Matrix 415

Table B.2 - Command codes (sorted by command code) 416

Table B.3 - Command codes (sorted by command name) 420

Table B.4 - Historical Command Assignments 423

Table B.5 - Historical SET FEATURE Code Assignments 431

Table D.1 - SCT command using SMART WRITE LOG command 450

Table D.2 - SCT command using WRITE LOG EXT command 451

Figures

	Page
Figure 1 - ATA document relationships.....	1
Figure 2 - State diagram convention.....	10
Figure 3 - Byte, word, DWord and QWord relationships.....	11
Figure 4 - Device Configuration Overlay state diagram.....	19
Figure 5 - HPA Not Set.....	24
Figure 6 - HPA Set (28).....	25
Figure 7 - HPA Set (48).....	26
Figure 8 - HPA Locked (28).....	27
Figure 9 - HPA Locked (48).....	28
Figure 10 - LLS and LPS Example.....	41
Figure 11 - Alignment 0.....	41
Figure 12 - Alignment 1.....	41
Figure 13 - Alignment 3.....	42
Figure 14 - Power management state diagram.....	47
Figure 15 - Security state diagram.....	57
Figure 16 - Selective self-test span example.....	254
Figure C.1 - Unaligned Write Example.....	442
Figure D.1 - Example flowchart for SCT commands.....	444
Figure D.2 - Example sequence for foreground write same with a repeating pattern.....	445
Figure D.3 - Example sequence for foreground write same with a repeating sector.....	445
Figure D.4 - Example sequence for writing data using an SCT command with no background activity.....	446
Figure D.5 - Example sequence for reading data using an SCT command with no background activity.....	446
Figure D.6 - Example Sequence for a Non-Data SCT command with no background activity.....	447
Figure D.7 - Example sequence for writing data using an SCT command with background activity.....	448
Figure D.8 - Example sequence for a Non-Data SCT command with background activity.....	449
Figure E.1 - System Dependency Chain.....	453
Figure E.2 - Mapping Proposals.....	454
Figure E.3 - Logical to Physical Mapping.....	454
Figure E.4 - Uncorrectable Error Handling.....	456
Figure E.5 - Typical HDD Layout Using A Master Boot Record.....	457

Foreword

(This foreword is not part of this standard.)

This AT Attachment 8 - ATA/ATAPI Command Set (ATA8-ACS) standard is designed to maintain a high degree of compatibility with the AT Attachment with Packet Interface - 7 (ATA/ATAPI-7) standard.

Requests for interpretation, suggestions for improvement and addenda, or defect reports are welcome. They should be sent to the INCITS Secretariat, ITI, 1250 Eye Street, NW, Suite 200, Washington, DC 20005-3922.

This standard was processed and approved for submittal to ANSI by InterNational Committee for Information Technology Standards (INCITS). Committee approval of this standard does not necessarily imply that all committee members voted for approval. At the time it approved this standard, INCITS had the following members:

Karen Higginbottom, Chair

David Michael, Vice-Chair

Monica Vago, Secretary

Technical Committee T13 on ATA Interfaces, that reviewed this standard, had the following members and additional participants:

Dan Colegrove, Chair

Jim Hatfield, Vice-Chair

Mark Overby, Secretary

[Editors Note: Insert T13 Membership List Here]

Introduction

This standard encompasses the following:

Clause 1 describes the scope.

Clause 2 provides normative references for the entire standard.

Clause 3 provides definitions, abbreviations, and conventions used within the entire standard.

Clause 4 describes the general operating requirements of the command layer.

Clause 5 describes the ATA protocols used by the commands in this standard.

Clause 6 describes Normal and Error Output fields.

Clause 7 describes commands.

Clause 8 describes the SCT Command Transport.

Clause 9 describes command normal and error outputs.

Annex A describes logs.

Annex B provides command summaries.

Annex C describes considerations for using devices with non-512 byte sectors.

Annex D provides a tutorial on how to use SCT.

Annex E provides implementation guidelines for 1,024/4,096 byte sectors.

Windows is a registered trademark of Microsoft Corporation in the United States and/or other countries.

AT Attachment 8 - ATA/ATAPI Command Set (ATA8-ACS)

1 Scope

The set of AT Attachment standards consists of this standard and the ATA implementation standards described in AT Attachment - 8 ATA/ATAPI Architecture Model (ATA8-AAM). The AT Attachment ATA Command Set (ATA8-ACS) specifies the command set host systems use to access storage devices. It provides a common command set for systems manufacturers, system integrators, software suppliers, and suppliers of intelligent storage devices. Figure 1 shows the relationship of this standard to the other standards and related projects in the ATA and SCSI families of standards and specifications.

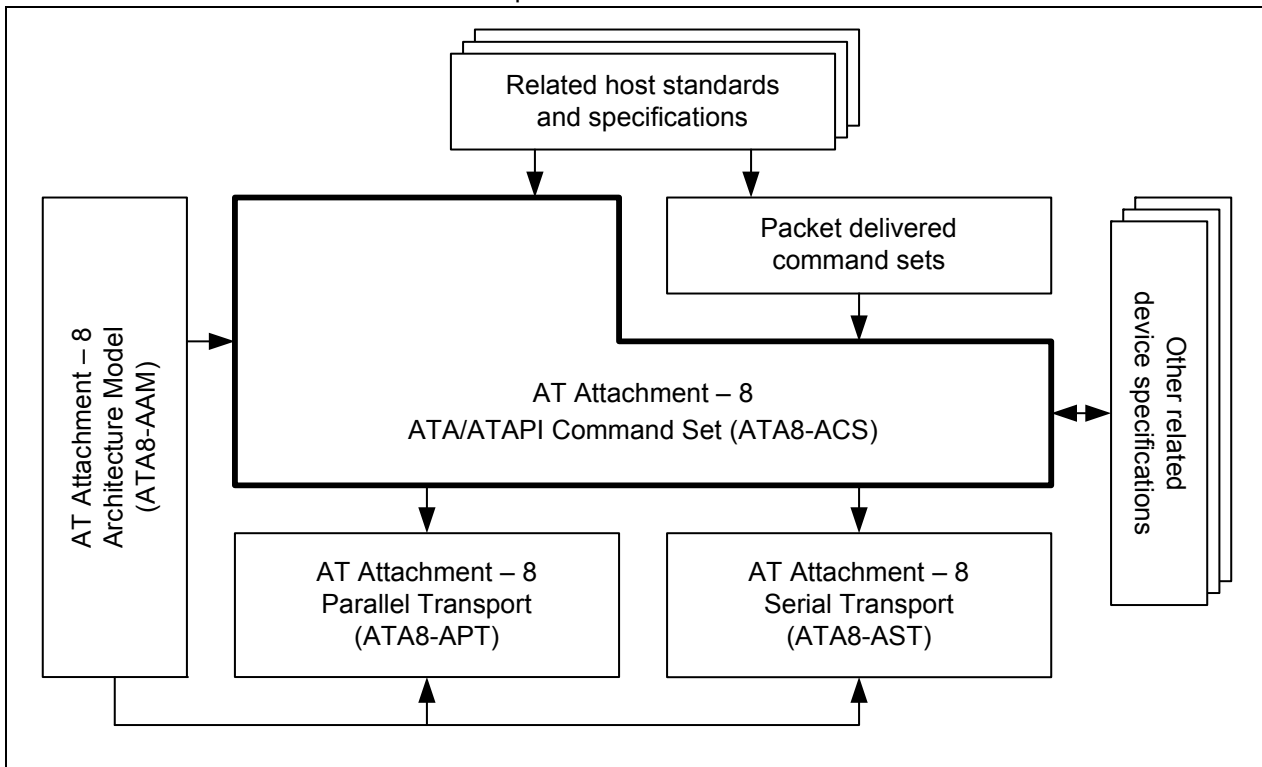

Figure 1 — ATA document relationships

ATA8-ACS maintains compatibility with the AT Attachment with Packet Interface - 7 standard (ATA/ATAPI-7), INCITS 397-2005 volume 1, while providing additional functions.

2 Normative references

2.1 General

The standards list in 2.2, 2.3, and 2.4 contain provisions that, through reference in the text, constitute provisions of this standard. At the time of publication, the editions indicated were valid. All standards are subject to revision, and parties to agreements based on this standard are encouraged to investigate the possibility of applying the most recent editions of the standards listed in 2.2, 2.3, and 2.4.

Copies of these standards may be obtained from ANSI: Approved ANSI standards, approved and draft international and regional standards (ISO, IEC, CEN/CENELEC, ITUT), and approved and draft foreign standards (including BSI, JIS, and DIN). For further information, contact ANSI Customer Service Department at 212-642-4900 (phone), 212-302-1286 (fax), or via the World Wide Web at <http://www.ansi.org>.

Additional availability contact information is provided as needed.

2.2 Approved references

Copies of the following documents may be obtained from ANSI, an ISO member organization:

- a) Approved ANSI standards;
- b) approved international and regional standards (ISO and IEC); and
- c) approved foreign standards (including JIS and DIN).

For further information, contact the ANSI Customer Service Department:

Phone +1 212-642-4900
 Fax: +1 212-302-1286
 Web: <http://www.ansi.org>
 E-mail: ansionline@ansi.org

or the InterNational Committee for Information Technology Standards (INCITS):

Phone +1 202-626-5738
 Web: <http://www.incits.org>
 E-mail: incits@itic.org

Table 1 lists approved ANSI standards, approved international and regional standards (ISO, IEC, CEN/CENELEC, ITUT). Additional information may be available at <http://www.t10.org> and <http://www.t13.org>.

Table 1 — Approved ANSI References

Name	Reference
Protected Area Run Time Interface Extensions (PARTIES)	ANSI INCITS 346-2001
AT Attachment with Packet Interface Extension (ATA/ATAPI-4)	ANSI INCITS 317-1998
AT Attachment with Packet Interface Extension (ATA/ATAPI-5)	ANSI INCITS 340-2000
AT Attachment with Packet Interface Extension (ATA/ATAPI-6)	ANSI INCITS 361-2002
AT Attachment with Packet Interface Extension (ATA/ATAPI-7)	ANSI INCITS 397-2005 ISO/IEC 14776-971
ATA/ATAPI-7 Amendment 1	ANSI INCITS.397-2005/AM 1-2006
Time Limited Commands (TLC)	ANSI INCITS TR37-2004
SMART Command Transport (SCT)	ANSI INCITS TR38-2005
Address Offset Reserved Area Boot Method	ANSI INCITS TR27-2001
Acoustics - Measurement of airborne noise emitted by information technology and telecommunications equipment	ISO/IEC 7779:1999(E)
SCSI Primary Commands - 3 (SPC-3)	ANSI INCITS 408-2005 ISO/IEC 14776-453
Information Systems - Coded Character Sets - 7-Bit American National Standard Code for Information Interchange (7-Bit ASCII)	ANSI INCITS 4-1986 (R2002)

2.3 References under development

At the time of publication, the referenced standards were still under development. For information on the current status of the document, or regarding availability, contact the relevant standards body or other organization as indicated in table 2.

Table 2 — References Under Development

Name	Project Number
AT Attachment-8 - Parallel Transport (ATA8-APT)	INCITS 1698D ISO/IEC 14776-881
AT Attachment-8 - ATA/ATAPI Architecture Model (ATA8-AAM)	INCITS 1700D ISO/IEC 14776-861
Method to Disable Data Transfer after Error Technical Report (DDT)	INCITS 1825DT INCITS/TR-43
AT Attachment-8 - ATA Serial Transport (ATA8-AST)	INCITS 1697D
Host Bus Adapter - 2 (HBA-2)	INCITS 2014D

2.4 Other references

These standards and specifications are also referenced.

The CE-ATA Digital Protocol Specification.

For the CE-ATA Storage Interface Specification published by CE-ATA, contact them at <http://www.ce-ata.org>

CompactFlash Association Specification, Revision 4.1

For the CompactFlash Association Specification published by the CompactFlash Association, contact the CompactFlash Association at <http://www.compactflash.org>.

The MultiMedia Card System Specification

For the MultiMedia Card System Specification published by the MultiMedia Card Association, Inc, contact them at 925-417-0127 or <http://www.mmca.org>

RFC 3280, Internet X.509 Public Key Infrastructure: Certificate and Certificate Revocation List (CRL) Profile, IETF, 2002.

For RFC 3280 contact the Internet Engineering Task Force at <http://www.ietf.org>.

RFC 3281, An Internet Attribute Certificate: Profile for Authorization, IETF, 2002

For RFC 3281 contact the Internet Engineering Task Force at <http://www.ietf.org>

SD-ATA Interface Specification (Part H2)

For the SD-ATA Interface Specification (Part H2), contact them at <http://www.sdcard.org>

Serial ATA revision 2.6 (SATA 2.6)

For the SATA 2.6 specification published by SATA-IO, contact them at <http://www.sata-io.org>

3 Definitions, abbreviations, and conventions

3.1 Definitions and abbreviations

- 3.1.1 **28-bit command:** A command that uses Feature (7:0), Count (7:0), LBA (27:0), Device (15:8) and Command (7:0) to specify its arguments.
- 3.1.2 **48-bit command:** A command that uses Feature (15:0), Count (15:0), LBA (47:0), Device (15:8) and Command (7:0) to specify its arguments.
- 3.1.3 **application client:** An object in the host that is the source of commands and device management functions (see ATA8-AAM).
- 3.1.4 **ASCII:** American Standard Code for Information Interchange.
- 3.1.5 **ASCII character:** A byte containing a 7-bit ASCII pattern in bits (6:0) with bit 7 cleared to zero.
- 3.1.6 **acoustics:** Measurement of airborne noise emitted by information technology and telecommunications equipment (see ISO 7779:1999(E)).
- 3.1.7 **ATA (AT Attachment) device:** A device implementing the General feature set (see 4.2).
- 3.1.8 **ATA string:** A set of ASCII characters (see 3.1.5) in the format specified in 3.2.9.
- 3.1.9 **ATAPI (AT Attachment Packet Interface) device:** A device implementing the PACKET feature set (see 4.3).
- 3.1.10 **AV (Audio-Video):** Audio-Video applications use data that is related to video images and/or audio. The distinguishing characteristic of this type of data is that accuracy is of lower priority than timely transfer of the data.
- 3.1.11 **Background Activities:** Activities initiated by a command that occur after command completion has been reported.
- 3.1.12 **BIOS (Basic Input/Output System):** An initial application client run by a computer when power is applied. The primary function of BIOS is initialize various components of the system, including storage devices.
- 3.1.13 **Block Data:** Block Data is the data transferred to or from the device using SCT read/write log capabilities.
- 3.1.14 **byte:** A sequence of eight contiguous bits considered as a unit. See 3.2.8.
- 3.1.15 **cache:** A data storage area outside the area accessible by application clients that may contain a subset of the data stored in the non-volatile data storage area.
- 3.1.16 **CFA Device:** A device implementing the CFA feature set (see 4.7).
- 3.1.17 **check condition:** For ATAPI devices, this indicates an error or exception condition has occurred.
- 3.1.18 **CHS (cylinder-head-sector):** An obsolete method of addressing the data on the device by cylinder number, head number, and sector number.
- 3.1.19 **command aborted:** Command completion with the Error bit set to one in the Status field and Abort bit set to one in the Error field.
- 3.1.20 **command acceptance:** Positive acknowledgement of a command being received by a device. See the appropriate transport standard for a definition of positive acknowledgement.
- 3.1.21 **command completion:** The completion by the device of the action requested by the command or the termination of the command with an error, the setting of the appropriate bits in the Error field, and the setting of the appropriate bits in the Status field.
- 3.1.22 **command packet:** A data structure transmitted to the device during the processing of a PACKET command that includes the command and command parameters.
- 3.1.23 **command released:** When a device supports the TCQ feature set (see 4.24), a command is considered released when a release occurs before command completion.
- 3.1.24 **COMRESET:** COMRESET is a commanded hardware reset in the Serial ATA transport (See SATA 2.6).

- 3.1.25 device:** A data storage peripheral (e.g., a disk drive) (see 3.1.7 and 3.1.9).
- 3.1.26 DMA (direct memory access) data transfer:** A means of data transfer between device and host memory without host processor intervention.
- 3.1.27 DRQ (Data Request) data block:** A unit of data words associated with available status when using either the PIO Data-In command protocol or the PIO Data-Out command protocol.
- 3.1.28 DWord:** A sequence of four contiguous bytes considered as a unit. See 3.2.8.
- 3.1.29 FIS:** The Frame Information Structure for the serial ATA interface (see ATA8-AST).
- 3.1.30 hardware reset:** the routine performed by a device after a hardware reset event as defined in ATA8-AAM. The hardware reset routine performed by the device includes the actions performed by the device for a software reset, and the actions defined in ATA8-AAM, this standard, and the applicable transport standards.
- 3.1.31 HPA Locked:** A device is HPA Locked when it is in the H2, HL1-HL6 or HEL1-HEL6 state.
- 3.1.32 HPA Unlocked:** A device is HPA Unlocked when it is in the H0, H1, H3, HS1-HS6, or HES1-HES6 state. This includes states when the password may or may not be set.
- 3.1.33 host:** An object that originates commands and device management functions (see ATA8-AAM).
- 3.1.34 host adapter:** The implementation of the host transport, link, and physical layers.
- 3.1.35 LBA (logical block address):** The value used to reference a logical sector.
- 3.1.36 logical sector:** A set of logical words accessed and referenced as a unit (see IDENTIFY DEVICE data words 118:117). These units are referenced by LBA (see 3.1.35).
- 3.1.37 log:** Logs have names, addresses and pages (see Annex A).
- 3.1.38 log address:** A numeric value that a log command uses to identify a specific log.
- 3.1.39 log command:** A SMART READ LOG command (see 7.53.7), SMART WRITE LOG command (see 7.53.9), or GPL feature set (see 4.10) command.
- 3.1.40 log page:** A unit of measure for determining the size of a log. Each log page is a 512-byte block of data. A log consists of one or more pages.
- 3.1.41 LSB (least significant bit):** In a binary code, the bit or bit position with the smallest numerical weighting in a group of bits that, when taken as a whole, represent a numerical value (e.g., in the number 0001b, the bit that is set to one).
- 3.1.42 Master Password Capability:** The Master Password Capability indicates whether or not the Master password may be used to unlock the device. This was formerly known as "Security Level".
- 3.1.43 Media:** The material on which data is stored.
- 3.1.44 Media Access Command:** Any command that causes the device to access non-volatile media.
- 3.1.45 MSB (most significant bit):** In a binary code, the bit or bit position with the largest numerical weighting in a group of bits that, when taken as a whole, represent a numerical value (e.g., in the number 1000b, the bit that is set to one).
- 3.1.46 native max address:** The highest LBA that a device accepts as reported by DEVICE CONFIGURATION IDENTIFY data or as reduced by the DEVICE CONFIGURATION SET command (i.e., the highest LBA that is accepted by a device using the SET MAX ADDRESS command (see 7.49.2) or, if the 48-bit Address feature set is supported, then the highest value accepted by a device using the SET MAX ADDRESS EXT command (see 7.50)).
- 3.1.47 Non-Volatile cache:** Cache that retains data through all power and reset events. Non-volatile cache shall be a subset of the non-volatile media.
- 3.1.48 Non-Volatile Media:** Physical storage media that retains data written to it for subsequent read operations through all power and reset events (e.g., magnetic media, optical media, flash media).
- 3.1.49 NV Cache Pinned Set:** The set of logical blocks specified by the application client for which all accesses shall be serviced by the non-volatile cache.

- 3.1.50 **NV Cache Set:** The set of logical blocks currently represented in the device's entire NV Cache.
- 3.1.51 **NV Cache Set Data:** A data structure representing the standard format of transmitting logical blocks in the form of a list of LBA Range Entries.
- 3.1.52 **NV Cache Unpinned Set:** The set of logical blocks that are represented in the NV Cache Set but not represented in the NV Cache Pinned Set. The NV Cache Pinned Set and the NV Cache Unpinned Set are mutually exclusive. NV Cache Unpinned Set is managed by the device and logical blocks represented in the NV Cache Unpinned Set may be added or removed from the NV Cache Set at any time.
- 3.1.53 **Password Attempt Counter Exceeded:** This is a name associated with IDENTIFY DEVICE, word 128, bit 4 (see 7.16.7.64).
- 3.1.54 **PATA (Parallel ATA) device:** A device implementing the parallel ATA transport (see ATA8-APT).
- 3.1.55 **physical sector:** One or more contiguous logical sectors that are read from or written to the device media in a single operation.
- 3.1.56 **PIO (programmed input/output) data transfer:** PIO data transfers are performed using PIO commands and protocol.
- 3.1.57 **power cycle:** the period from when power is removed from a host or device until the subsequent power-on event (see ATA8-AAM).
- 3.1.58 **power-on reset:** the host specific routine performed by the host or the routine performed by a device after detecting a power-on event. The power-on reset routine performed by a device includes the actions performed by the device for a hardware reset and a software reset, and the actions defined in ATA8-AAM, this standard, and the applicable transport standards.
- 3.1.59 **Queued Command:** A TCQ or NCQ command that has reported command acceptance but not command completion.
- 3.1.60 **QWord:** A sequence of eight contiguous bytes considered as a unit. See 3.2.8.
- 3.1.61 **read command:** A command that causes the device to transfer data from the device to the host. The following commands are read commands: READ DMA, READ DMA EXT, READ DMA QUEUED, READ DMA QUEUED EXT, READ FPDMA QUEUED, READ MULTIPLE, READ MULTIPLE EXT, READ SECTOR(S), READ SECTOR(S) EXT, READ STREAM EXT, READ STREAM DMA EXT, READ VERIFY SECTOR(S), or READ VERIFY SECTOR(S) EXT.
- 3.1.62 **release:** The action by a device implementing the TCQ feature set (see 4.24) that allows a host to select an alternate device or deliver another TCQ command (see 4.24).
- 3.1.63 **SATA (Serial ATA) device:** A device implementing the serial ATA transport (see ATA8-AST).
- 3.1.64 **SCT Command:** A command that writes to the SCT command/status log (see clause 8).
- 3.1.65 **SCT Status:** A command that reads from the SCT command/status log (see clause 8).
- 3.1.66 **sector:** See logical sector (see 3.1.36).
- 3.1.67 **Security Level:** See Master Password Capability (see 3.1.42).
- 3.1.68 **Serial ATAPI device:** A device implementing the serial ATA transport (see ATA8-AST) and the PACKET feature set.
- 3.1.69 **signature:** A unique set of values placed in the return parameters used to distinguish device types (e.g., General, ATAPI device, Port Multiplier) (see table 104).
- 3.1.70 **software reset:** the routine performed by a device after a software reset event as defined in ATA8-AAM. The software reset routine includes the actions defined in ATA8-AAM, this standard, and the applicable transport standards.
- 3.1.71 **spin-down:** the process of bringing a rotating media device's media to a stop.
- 3.1.72 **spin-up:** the process of bringing a rotating media device's media to operational speed.
- 3.1.73 **Stream:** a set of operating parameters specified by a host using the CONFIGURE STREAM command (see 7.9) to be used for subsequent READ STREAM commands and WRITE STREAM commands.

- 3.1.74 TCG:** Trusted Computing Group: An organization that develops and promotes open standards for hardware-enabled trusted computing and security technologies. See <https://www.trustedcomputinggroup.org> for more information.
- 3.1.75 transport:** The mechanism used to communicate with a device. See ATA8-APT and ATA8-AST.
- 3.1.76 unaligned write:** A write command that does not start at the first logical sector of a physical sector or does not end at the last logical sector of a physical sector.
- 3.1.77 unrecoverable error:** When the device sets either the Error bit or the Device Fault bit to one in the Status field at command completion.
- 3.1.78 Volatile Cache:** Cache that does not retain data through power cycles.
- 3.1.79 vendor specific:** Bits, bytes, fields, and code values that are reserved for vendor specific purposes. These bits, bytes, fields, and code values are not described in this standard, and implementations may vary among vendors. This term is also applied to levels of functionality whose definition is left to the vendor.
- 3.1.80 word:** A sequence of two contiguous bytes considered as a unit. See 3.2.8.
- 3.1.81 write command:** A command that causes the device to transfer data from the host to the device. The following commands are write commands: SCT Write Same, SCT Write Long, WRITE DMA, WRITE DMA EXT, WRITE DMA FUA EXT, WRITE DMA QUEUED, WRITE DMA QUEUED EXT, WRITE DMA QUEUED FUA EXT, WRITE FPDMA QUEUED, WRITE MULTIPLE, WRITE MULTIPLE EXT, WRITE MULTIPLE FUA EXT, WRITE SECTOR(S), WRITE SECTOR(S) EXT, WRITE STREAM DMA EXT, or WRITE STREAM EXT.
- 3.1.82 WWN (world wide name):** A 64-bit worldwide unique name based upon a company's IEEE organizationally unique identifier (OUI), reported in IDENTIFY DEVICE data words 108-111 (see 7.16.7.56) and IDENTIFY PACKET DEVICE data words 108-111 (see 7.17.6.44)

3.2 Conventions

3.2.1 Overview

Lowercase is used for words having the normal English language meaning. Certain words and terms used in this standard have a specific meaning beyond the normal English language meaning. These words and terms are defined either in clause 3 or in the text where they first appear.

The names of abbreviations, commands, fields, and acronyms used as signal names are in all uppercase (e.g., IDENTIFY DEVICE). Fields containing only one bit are usually referred to as the "name" bit instead of the "name" field. (See 3.2.6 for the naming convention used for naming bits.)

Names of device fields begin with a capital letter (e.g., Count).

The expression "word n" or "bit n" shall be interpreted as indicating the content of word n or bit n.

3.2.2 Precedence

If there is a conflict between text, figures, and tables, the precedence shall be tables, figures, then text.

3.2.3 Lists

3.2.3.1 Lists overview

Lists shall be introduced by a complete grammatical proposition followed by a colon and completed by the items in the list.

Each item in a list shall be preceded by an identification with the style of the identification being determined by whether the list is intended to be an ordered list or an unordered list.

If the item in a list is not a complete sentence, then the first word in the item shall not be capitalized. If the item in a list is a complete sentence, then the first word in the item shall be capitalized,

Each item in a list shall end with a semicolon, except the last item, which shall end in a period. The next to the last entry in the list shall end with a semicolon followed by an "and" or an "or" (i.e., "...; and", or "...; or"). The

“and” is used if all the items in the list are required. The “or” is used if only one or more items in the list are required.

3.2.3.2 Unordered lists

An unordered list is one in which the order of the listed items is unimportant (i.e., it does not matter where in the list an item occurs as all items have equal importance). Each list item shall start with a lower case letter followed by a close parenthesis. If it is necessary to subdivide a list item further with an additional unordered list (i.e., have a nested unordered list), then the nested unordered list shall be indented and each item in the nested unordered list shall start with an upper case letter followed by a close parenthesis.

The following is an example of an unordered list with a nested unordered list:

The following are the items for the assembly:

- a) a box containing:
 - A) a bolt;
 - B) a nut; and
 - C) a washer;
- b) a screwdriver; and
- c) a wrench.

3.2.3.3 Ordered lists

An ordered list is one in which the order of the listed items is important (i.e., item n is required before item n+1). Each listed item starts with an Western-Arabic numeral followed by a close parenthesis. If it is necessary to subdivide a list item further with an additional unordered list (i.e., have a nested unordered list), then the nested unordered list shall be indented and each item in the nested unordered list shall start with an upper case letter followed by a close parenthesis.

The following is an example of an ordered list with a nested unordered list:

The following are the instructions for the assembly:

- 1) Remove the contents from the box;
- 2) Assemble the item;
 - A) Use a screwdriver to tighten the screws; and
 - B) Use a wrench to tighten the bolts;
 - and
- 3) Take a break.

3.2.4 Keywords

Several keywords are used to differentiate between different levels of requirements and options.

3.2.4.1 expected: A keyword used to describe the behavior of the hardware or software in the design models assumed by this standard. Other hardware and software design models may also be implemented.

3.2.4.2 mandatory: A keyword indicating items to be implemented as defined by this standard.

3.2.4.3 may: A keyword that indicates flexibility of choice with no implied preference.

3.2.4.4 N/A: A keyword that indicates a field is not applicable and has no defined value and should not be checked by the host or device.

3.2.4.5 obsolete: A keyword indicating that the designated bits, bytes, words, fields, and code values that may have been defined in previous standards are not defined in this standard and shall not be reclaimed for other uses in future standards. However, some degree of functionality may be required for items designated as “obsolete” to provide for backward compatibility.

Obsolete commands should not be used by the host. Commands defined as obsolete may be command aborted by devices conforming to this standard. However, if a device does not return command aborted for an obsolete command, then the device shall return command completion for the command.

3.2.4.6 optional: A keyword that describes features that are not required by this standard. However, if any optional feature defined by the standard is implemented, the feature shall be implemented in the way defined by the standard.

3.2.4.7 prohibited: A keyword indicating that an item shall not be implemented by an implementation.

3.2.4.8 reserved: A keyword indicating reserved bits, bytes, words, fields, and code values that are set aside for future standardization. Their use and interpretation may be specified by future extensions to this or other standards. A reserved bit, byte, word, or field shall be cleared to zero, or in accordance with a future extension to this standard. The recipient shall not check reserved bits, bytes, words, or fields. Receipt of reserved code values in defined fields shall be treated as a command parameter error and reported by returning command aborted.

3.2.4.9 retired: A keyword indicating that the designated bits, bytes, words, fields, and code values that had been defined in previous standards are not defined in this standard and may be reclaimed for other uses in future standards. If retired bits, bytes, words, fields, or code values are used before they are reclaimed, they shall have the meaning or functionality as described in previous standards.

3.2.4.10 shall: A keyword indicating a mandatory requirement. Designers are required to implement all such mandatory requirements to ensure interoperability with other products that conform to this standard.

3.2.4.11 should: A keyword indicating flexibility of choice with a strongly preferred alternative. Equivalent to the phrase "it is recommended".

3.2.5 Numbering

Numbers that are not immediately followed by a lowercase "b" or "h" are decimal values. Numbers that are immediately followed by a lowercase "b" (e.g., 01b) are binary values. Numbers that are immediately followed by a lowercase "h" (e.g., 3Ah) are hexadecimal values.

Underscores or spaces may be included in number representations to increase readability or delineate field boundaries (e.g., FFFF_FFFFh, FFFF FFFFh, and FFFFFFFFh represent the same number).

3.2.6 Bit conventions

Name (n:m), where n shall be greater than m, denotes a set of bits (e.g., Feature (7:0)). n:m where n shall be greater than m denotes a bit range in a table.

3.2.7 State diagram conventions

State diagrams shall be as shown in Figure 2.

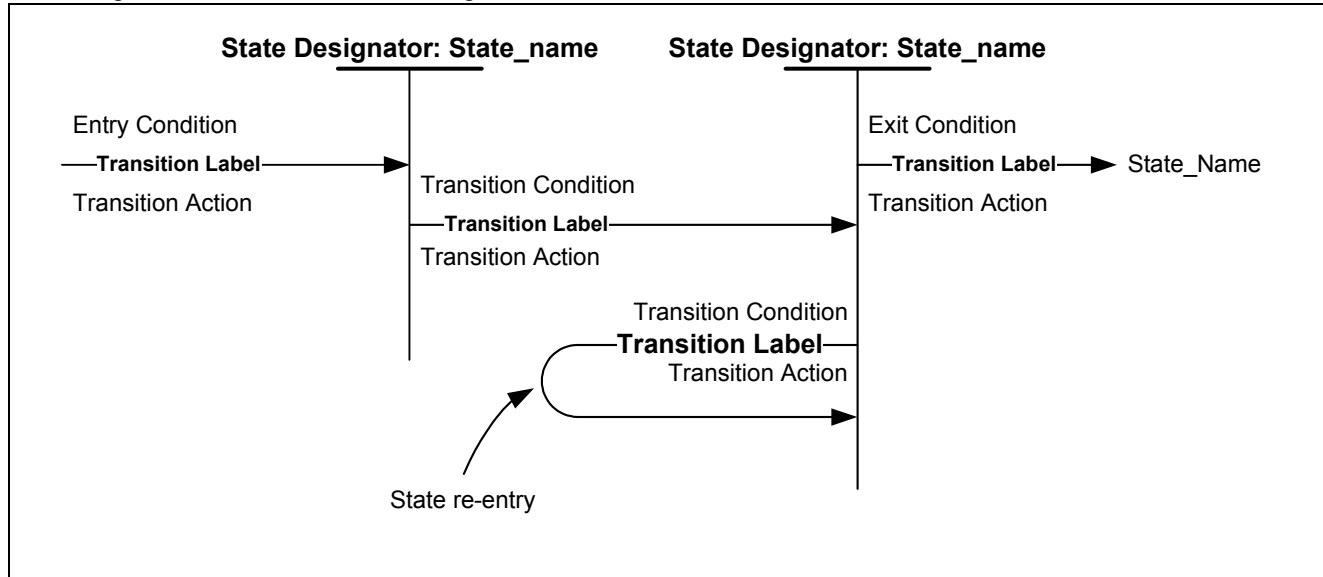

Figure 2 — State diagram convention

Each state is identified by a state designator and a state name. The state designator is unique among all states in all state diagrams in this document. The state designator consists of a set of letters that are capitalized in the title of the figure containing the state diagram followed by a unique number. The state name is a brief description of the primary action taken during the state, and the same state name may appear in other state diagrams. If the same primary function occurs in other states in the same state diagram, they are designated with a unique letter at the end of the name. Additional actions may be taken while in a state and these actions are described in the state description text.

Each transition is identified by a transition label and a transition condition. The transition label consists of the state designator of the state from which the transition is being made followed by the state designator of the state to which the transition is being made. In some cases, the transition to enter or exit a state diagram may come from or go to a number of state diagrams, depending on the command being processed. In this case, the state designator is labeled State_name. The transition condition is a brief description of the event or condition that causes the transition to occur and may include a transition action, indicated in italics, that is taken when the transition occurs. This action is described in the transition description text.

Upon entry to a state, all actions to be processed in that state are processed. If a state is re-entered from itself, all actions to be processed in the state are processed again.

Transitions from state to state shall be instantaneous.

3.2.8 Byte, word, DWord, and QWord Relationships

Figure 3 illustrates the relationship between bytes, words, DWords, and QWords.

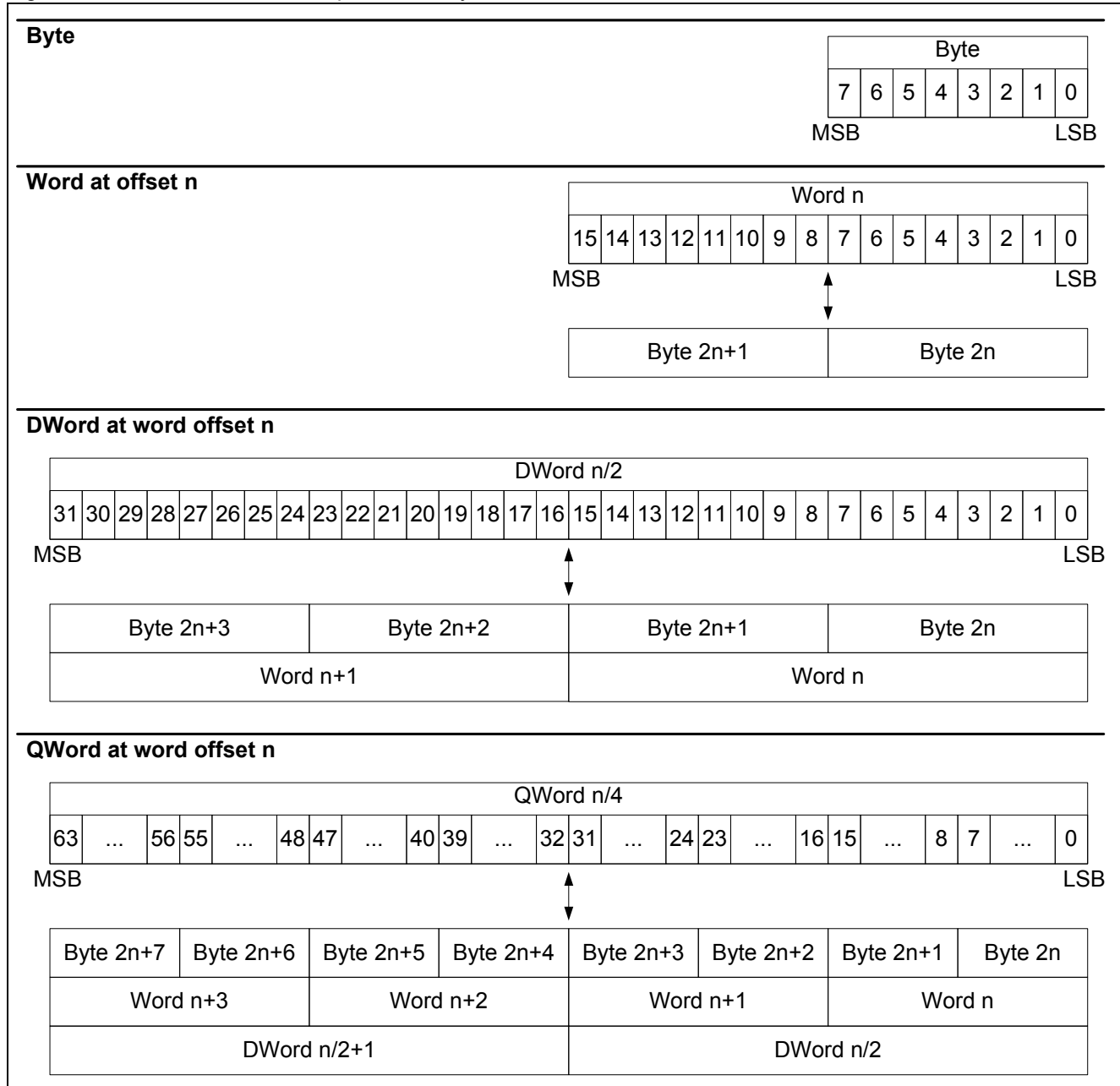

Figure 3 — Byte, word, DWord and QWord relationships

Unless stated or defined otherwise, in a field containing a multi-byte value (e.g., a word, DWord, or QWord), the byte containing the LSB is stored at the lowest offset and the byte containing the MSB is stored at the highest offset. Examples following this convention include:

- a) Device Configuration Identify data (see table 25) and Device Configuration Overlay data (see table 26 in 7.10.5.6);
- b) IDENTIFY DEVICE data (see table 29);
- c) IDENTIFY PACKET DEVICE data (see table 39);
- d) Request Pin data (see table 43), Cache Miss Data (see table 44), Pin Set Data (see table 45), and Remove Pin Data (see table 46) used by Non-Volatile Cache commands (see 7.20);
- e) Device SMART data (see table 62);
- f) SCT status response (see table 80) and SCT command (see table 81); and

- g) Logs defined in Annex A.

For example:

- a) if the two-byte field (i.e., word) in SCT command (see table 81) word 0 contains 0007h, then:
 - A) byte 0 contains 07h; and
 - B) byte 1 contains 00h;
- b) if the four-byte field (i.e., DWord) at IDENTIFY DEVICE data words 60-61 (see table 29) contains 8001_0203h (i.e., 2,147,549,699), then:
 - A) byte 120 contains 03h;
 - B) byte 121 contains 02h;
 - C) byte 122 contains 01h; and
 - D) byte 123 contains 80h;

and
- c) if an eight-byte field (i.e., QWord) in the WRITE SAME command words 2-5 (see table 86) contains 0000_0504_0302_0100h), then:
 - A) byte 4 contains 00h;
 - B) byte 5 contains 01h;
 - C) byte 6 contains 02h;
 - D) byte 7 contains 03h;
 - E) byte 8 contains 04h;
 - F) byte 9 contains 05h;
 - G) byte 10 contains 00h; and
 - H) byte 11 contains 00h.

Exceptions to this convention include:

- a) each field containing an ATA string (e.g., the IDENTIFY DEVICE data and IDENTIFY PACKET DEVICE data Serial number, Firmware revision, and Model number fields) is considered to be an array of bytes, not a multi-byte value, and is handled as described in 3.2.9;
- b) the IDENTIFY DEVICE data and IDENTIFY PACKET DEVICE data World Wide Name field is treated as four word fields rather than one QWord field and is handled as described in 7.16.7.56; and
- c) the CFA TRANSLATE SECTOR data LBA and logical sector write cycles count fields (see table 23);
- d) the command packet in the PACKET command (see 7.22) is formatted as defined by the applicable command standard); and
- e) parameter data in the TRUSTED RECEIVE (see 7.57), TRUSTED RECEIVE DMA (see 7.58), TRUSTED SEND (see 7.59), and TRUSTED SEND DMA commands (see 7.60) is formatted as defined in those sections or in the standard defining the security protocol.

For example:

- a) if the two-byte field (i.e., a word) in TRUSTED RECEIVE parameter data for SP Specific=0000h (see table 68) contains 01FFh, then:
 - A) byte 6 contains 01h; and
 - B) byte 7 contains FFh;

and
- b) if a command packet in the PACKET command contains a SCSI INQUIRY command (see SPC-4) requesting the standard INQUIRY data with the allocation length field set to 01FFh, then:
 - A) byte 0 (i.e., the operation code field) contains 12h;
 - B) byte 1 (i.e., the byte containing the evpd bit) contains 00h;
 - C) byte 2 (i.e., the page code field) contains 00h;
 - D) byte 3 (i.e., the byte containing the MSB of the allocation length field) contains 01h;
 - E) byte 4 (i.e., the byte containing the LSB of the allocation length field) contains FFh;
 - F) byte 5 (i.e., the control field) contains 00h;
 - G) if IDENTIFY PACKET DEVICE data word 0 bits (1:0) are set to 00b (i.e., 12 byte command packet), bytes 6 through 11 each contain 00h; and
 - H) if IDENTIFY PACKET DEVICE data word 0 bits (1:0) are set to 01b (i.e., 16 byte command packet), bytes 6 through 15 each contain 00h.

3.2.9 ATA string convention

ATA strings are sequences of bytes containing ASCII graphic characters in the range of 20h-7Eh. ATA strings shall not contain values in the range of 00h-1Fh or 7Fh-FFh.

The following fields in IDENTIFY DEVICE data (see 7.16.7) and IDENTIFY PACKET DEVICE data (see 7.17.6) contain ATA strings:

- a) Serial number (words 10-19) (see 7.16.7.10);
- b) Firmware revision (words 23-26) (see 7.16.7.13);
- c) Model number (words 27-46) (see 7.16.7.14); and
- d) Current media serial number (words 176-205) (see 7.16.7.70).

Each pair of bytes in an ATA string is swapped as shown in table 3.

Table 3 — ATA string byte swapping

Word	Byte	Character in string
0	0	Second character
	1	First character
1	2	Fourth character
	3	Third character
...
n	2n	Last character
	2n+1	Second-to-last character

If the Firmware revision field (i.e., words 23-26) contains the string “abcdefg”, including one padding space character at the end, then the word and byte representations for the field are shown in table 4.

Table 4 — ATA firmware revision example

Word	Value	Byte	Value
23	6162h (i.e., “ba”)	36	62h (i.e., ‘b’)
		37	61h (i.e., ‘a’)
24	6364h (i.e., “dc”)	38	64h (i.e., ‘d’)
		39	63h (i.e., ‘c’)
25	6566h (i.e., “fe”)	40	66h (i.e., ‘f’)
		41	65h (i.e., ‘e’)
26	6720h (i.e., “g”)	42	20h (i.e., ‘ ’, the space character)
		43	67h (i.e., ‘g’)

4 Feature set definitions

4.1 Overview

Table 5 lists the feature sets in alphabetical order and shows whether a feature set is mandatory, optional, prohibited, or not defined for ATA devices and ATAPI devices.

Table 5 — Feature Set Summary

Feature Set	ATA Devices	ATAPI Devices
48-Bit Address feature set (see 4.4)	O	P
Advanced Power Management (APM) feature set (see 4.5)	O	O
Automatic Acoustic Management (AAM) feature set (see 4.6)	O	O
CompactFlash Association (CFA) feature set (see 4.7)	N	N
Device Configuration Overlay (DCO) feature set (see 4.8)	O	O
Free-fall Control feature set (see 4.9)	O	P
General feature set (see 4.2)	M	P
General Purpose Logging (GPL) feature set (see 4.10)	O	O
Host Protected Area (HPA) feature set (see 4.11)	O	O
Long Logical Sector (LLS) feature set (see 4.12)	O	P
Long Physical Sector (LPS) feature set (see 4.13)	O	P
Media Card Pass Through Command feature set (see 4.14)	N	P
Native Command Queuing (NCQ) feature set (see 4.15)	O	P
NV Cache feature set (see 4.16)	O	P
NV Cache Power Management feature set (see 4.17)	O	P
PACKET feature set (see 4.3)	P	M
Power Management feature set (see 4.18)	M	O
Power-Up In Standby (PUIS) feature set (see 4.19)	O	O
Security feature set (see 4.20)	O	O
Self-Monitoring, Analysis, and Reporting Technology (SMART) feature set (see 4.21)	O	P
Software Settings Preservation (SSP) feature set (see 4.22)	O	P
Streaming feature set (see 4.23)	O	P
Tagged Command Queuing (TCQ) feature set (see 4.24)	O	P
Trusted Computing feature set (see 4.25)	O	P
Write-Read-Verify feature set (see 4.26)	O	P
Key: M – Mandatory, O – Optional, P – Prohibited, N – Not defined		

4.2 General feature set

The following General feature set commands are mandatory for all devices that are capable of both reading and writing their media:

- a) EXECUTE DEVICE DIAGNOSTIC
- b) FLUSH CACHE
- c) IDENTIFY DEVICE
- d) READ DMA
- e) READ MULTIPLE
- f) READ SECTOR(S)

- g) READ VERIFY SECTOR(S)
- h) SET FEATURES
- i) SET MULTIPLE MODE
- j) WRITE DMA
- k) WRITE MULTIPLE
- l) WRITE SECTOR(S)

The following General feature set commands are mandatory for all devices that are capable of only reading their media:

- a) EXECUTE DEVICE DIAGNOSTIC
- b) IDENTIFY DEVICE
- c) READ DMA
- d) READ MULTIPLE
- e) READ SECTOR(S)
- f) READ VERIFY SECTOR(S)
- g) SET FEATURES
- h) SET MULTIPLE MODE

The following General feature set commands are optional:

- a) DOWNLOAD MICROCODE
- b) NOP
- c) READ BUFFER
- d) WRITE BUFFER
- e) WRITE UNCORRECTABLE EXT

All other commands that are contained in the PACKET feature set shall not be implemented.

4.3 The PACKET feature set

4.3.1 Overview

ATAPI devices use DEVICE RESET and PACKET commands as well as a subset of the General feature set to control the device.

The content of command packets delivered during execution of the PACKET command are defined in the standard indicated by IDENTIFY PACKET DEVICE data word 0 bits (12:8) (see 7.17.6.2) and are not described in this standard.

The optional PACKET feature set provides for ATAPI devices that require command parameters that are too extensive to be expressed in the return data structure. Devices implementing the PACKET feature set exhibit responses different from those exhibited by devices not implementing this feature set.

The following commands are mandatory for all devices implementing the PACKET feature set:

- a) PACKET
- b) DEVICE RESET
- c) EXECUTE DEVICE DIAGNOSTIC
- d) IDENTIFY DEVICE
- e) IDENTIFY PACKET DEVICE
- f) NOP
- g) READ SECTOR(S)
- h) SET FEATURES

NOTE 1 — For ATAPI devices, the IDENTIFY DEVICE command (see 7.16) and the READ SECTOR(S) command (see 7.35) are command aborted and return the ATAPI device signature (see table 104)

The following commands are optional for all devices implementing the PACKET feature set:

- a) FLUSH CACHE
- b) READ LOG EXT

- c) WRITE LOG EXT
- d) READ LOG DMA EXT
- e) WRITE LOG DMA EXT

All other commands that are contained in the General feature set shall not be implemented

4.3.2 Identification of PACKET feature set devices

The IDENTIFY PACKET DEVICE command is used by the host to get identifying parameter information for a device implementing the PACKET feature set (see 7.16.5 and 7.17).

4.3.3 Signature for ATAPI devices

ATAPI devices return a signature that differentiate them from other device types (see table 104).

4.3.4 The PACKET command

The PACKET command allows a host to send a command to the device via a command packet. The command packet contains the command and command parameters that the device is to process (see clause 1).

The protocol for handling the transmission of the PACKET command and associated data is transport specific.

4.4 48-bit Address feature set

The optional 48-bit Address feature set allows devices with capacities up to 281,474,976,710,655 logical sectors. This allows device capacity up to 144,115,188,075,855,360 bytes for a 512-byte logical block device. In addition, the number of logical sectors that may be transferred by a single command are increased to 65,536.

The following commands are mandatory for devices that implement the 48-bit address feature set:

- a) FLUSH CACHE EXT
- b) READ DMA EXT
- c) READ MULTIPLE EXT
- d) READ SECTOR(S) EXT
- e) READ VERIFY SECTOR(S) EXT
- f) WRITE DMA EXT
- g) WRITE DMA FUA EXT
- h) WRITE MULTIPLE EXT
- i) WRITE MULTIPLE FUA EXT
- j) WRITE SECTOR(S) EXT

Devices implementing the 48-bit Address feature set shall also implement commands that use 28-bit addressing. 28-bit and 48-bit commands may be intermixed (see 7.1.3).

The device shall indicate support of the 48-bit Address feature set in the IDENTIFY DEVICE data. In addition, IDENTIFY DEVICE data words 100-103 contain the maximum user LBA + 1 that is accessible by 48-bit addressable commands.

See 4.11.4 for a description of how to set IDENTIFY DEVICE data words 60-61 and 100-103.

When the 48-bit Address feature set is implemented, the native max address is the highest LBA accepted by the device in the factory default condition using a 48-bit Address feature set command. The native max address is the value returned by a READ NATIVE MAX ADDRESS EXT command. If the native max address of a device is equal to or less than 268,435,454, a READ NATIVE MAX ADDRESS shall return the native max address. If the native max address is greater than 268,435,454, a READ NATIVE MAX ADDRESS command shall cause the device to return a maximum value of 268,435,454.

When the 48-bit Address feature set is implemented, the device shall process the SET MAX ADDRESS command as described in 7.49.2. However, in addition to modifying the content of IDENTIFY DEVICE data words 60-61, the new content of IDENTIFY DEVICE data words 60-61 shall also be placed in IDENTIFY DEVICE data words 100-103. When a SET MAX ADDRESS EXT command is issued and the LBA requested is greater than 268,435,455, IDENTIFY DEVICE data words 100-103 shall be modified to reflect the requested value but IDENTIFY DEVICE data words 60-61 shall not be modified. When a SET MAX ADDRESS EXT command is issued and the LBA requested is equal to or less than 268,435,455, IDENTIFY DEVICE data words

100-103 shall be modified to reflect the requested value and IDENTIFY DEVICE data words 60-61 shall be modified as described in 7.49.2.1.

4.5 Advanced Power Management (APM) feature set

The Advanced Power Management feature set is an optional feature set that allows the host to select a power management level in a device. The power management level is specified using a scale from the lowest power consumption setting of 01h to the maximum performance level of FEh, see table 54 in 7.48.6. Device performance may increase with increasing power management levels. Device power consumption may increase as the power management setting numerically increases. A device may implement one power management method for two or more contiguous power management levels (e.g., a device may implement one power management method from level 80h to A0h and a higher performance, higher power consumption method from level A1h to FEh). APM levels 80h and higher do not permit a device with rotating media to spin down to save power.

The APM feature set uses the following functions:

- a) A SET FEATURES subcommand to enable APM; and
- b) An optional SET FEATURES subcommand to disable APM.

APM is independent of the Standby timer (see 4.18.3). If both APM and the Standby timer are set, the device shall go to the Standby state when the timer times out or the device's APM algorithm indicates that the Standby state should be entered.

The IDENTIFY DEVICE and IDENTIFY PACKET DEVICE data indicate whether the feature is supported, whether the feature is enabled, and the current settings.

The NV Cache Power management feature set may change the operation of the APM feature set (see 7.20.11).

4.6 Automatic Acoustic Management (AAM) feature set

The Automatic Acoustic Management feature set is an optional feature set that allows the host to select an acoustic management level. The acoustic management level ranges from the setting of 00h to FFh, although many levels are retired (see table 56). Device performance and acoustic emanation may increase with increasing acoustic management levels. The acoustic management levels may contain discrete bands (e.g., a device may implement one acoustic management method from level 80h to A0h, and a higher performance, higher acoustic emanation method from level A1h to FEh).

The Automatic Acoustic Management feature set uses the following functions:

- a) A SET FEATURES subcommand to enable the AAM feature set; and
- b) A SET FEATURES subcommand to disable the AAM feature set.

The IDENTIFY DEVICE or IDENTIFY PACKET DEVICE data indicates if the AAM feature set is supported, if the AAM feature set is enabled, and the current AAM level if the AAM feature set is enabled.

The AAM setting may impact word 97 in IDENTIFY DEVICE data (see 7.16.7.49).

4.7 CompactFlash Association (CFA) feature set

The optional CompactFlash Association (CFA) feature set provides support for devices that implement the CFA specifications. A device that implements the CFA feature set shall implement the following minimum set of commands:

- a) CFA REQUEST EXTENDED ERROR CODE
- b) CFA WRITE SECTORS WITHOUT ERASE
- c) CFA ERASE SECTORS
- d) CFA WRITE MULTIPLE WITHOUT ERASE
- e) CFA TRANSLATE SECTOR
- f) SET FEATURES Enable/Disable 8-bit transfer

Devices reporting the value 848Ah in IDENTIFY DEVICE data word 0 or devices having bit 2 of IDENTIFY DEVICE data word 83 set to one shall support the CFA feature set. If the CFA feature set is implemented, all the CFA commands and the Enable/Disable 8-Bit transfers shall be implemented.

Support of DMA commands is optional for devices that support the CFA feature set.

The CFA ERASE SECTORS command preconditions the logical sector for a subsequent CFA WRITE SECTORS WITHOUT ERASE or CFA WRITE MULTIPLE WITHOUT ERASE command to achieve higher performance during the write operation. The CFA TRANSLATE SECTOR command provides information about a logical sector (e.g., the number of write cycles performed on that sector and an indication of the logical sector's erased precondition). The CFA REQUEST EXTENDED ERROR CODE command provides more detailed error information.

4.8 Device Configuration Overlay (DCO) feature set

The optional DCO feature set allows a utility program to reduce the capability of the device by modifying some of the optional commands, modes, and feature sets that a device reports as supported in the IDENTIFY DEVICE or IDENTIFY PACKET DEVICE data as well as the capacity reported.

Commands unique to the DCO feature set use a single command code and are differentiated from one another by the value placed in the Feature field. These commands are:

- a) DEVICE CONFIGURATION FREEZE LOCK
- b) DEVICE CONFIGURATION IDENTIFY
- c) DEVICE CONFIGURATION RESTORE
- d) DEVICE CONFIGURATION SET

The DCO feature set may affect words in IDENTIFY DEVICE data, IDENTIFY PACKET DEVICE data, and other commands. Certain bits in these words that indicate that a command, mode, capacity, or feature set is supported and enabled may be cleared by a DEVICE CONFIGURATION SET command. For a particular command, mode, capacity, or feature set, when a bit is changed from one to zero requesting that the device shall not indicate support for the feature, the device shall not provide the feature.

The DEVICE CONFIGURATION SET command may be used to reduce the maximum capacity of the device. Since a Host Protected Area may be lost if the capacity of the device is reduced, when a Host Protected Area is set the DEVICE CONFIGURATION SET command shall cause the device to return command aborted. The LBA value returned by a READ NATIVE MAX ADDRESS or READ NATIVE MAX ADDRESS EXT command is modified by the DEVICE CONFIGURATION SET command modifying the maximum capacity of the device.

After processing of a power-on reset or hardware reset, a device shall not change the settings made by a DEVICE CONFIGURATION SET command.

The DEVICE CONFIGURATION IDENTIFY data indicates the selectable commands, modes, capacity, and feature sets that may be disabled in the device. After the execution of a DEVICE CONFIGURATION SET command this information is no longer available from an IDENTIFY DEVICE or IDENTIFY PACKET DEVICE command but the data that the DEVICE CONFIGURATION IDENTIFY command returns is not changed by the DEVICE CONFIGURATION SET or DEVICE CONFIGURATION RESTORE commands.

A DEVICE CONFIGURATION RESTORE command enables all capabilities that have been disabled by DEVICE CONFIGURATION SET command and returns the IDENTIFY DEVICE or IDENTIFY PACKET DEVICE data to that indicated by the DEVICE CONFIGURATION IDENTIFY command. If the value returned in IDENTIFY DEVICE data words 100-103 is less than the native max address for a device (i.e., a host protected area has been established), then the device shall return command aborted for a DEVICE CONFIGURATION RESTORE command.

If a device has not completed a DEVICE CONFIGURATION SET command without error, then a device shall be in the DCO Factory_config state after processing a power-on reset. If a device has completed a DEVICE CONFIGURATION SET command without error, then a device shall be in the DCO Reduced_config state after processing a power-on reset.

After completing a DEVICE CONFIGURATION FREEZE LOCK command without error, a device shall abort all DEVICE CONFIGURATION SET, DEVICE CONFIGURATION IDENTIFY, and DEVICE CONFIGURATION

RESTORE commands until after completing the subsequent power-on reset. If a device is in the DCO_locked state, then processing a hardware reset or software reset does not cause the device to change state.

Figure 4 and the text in this subclause describe the operation of the DCO feature set.

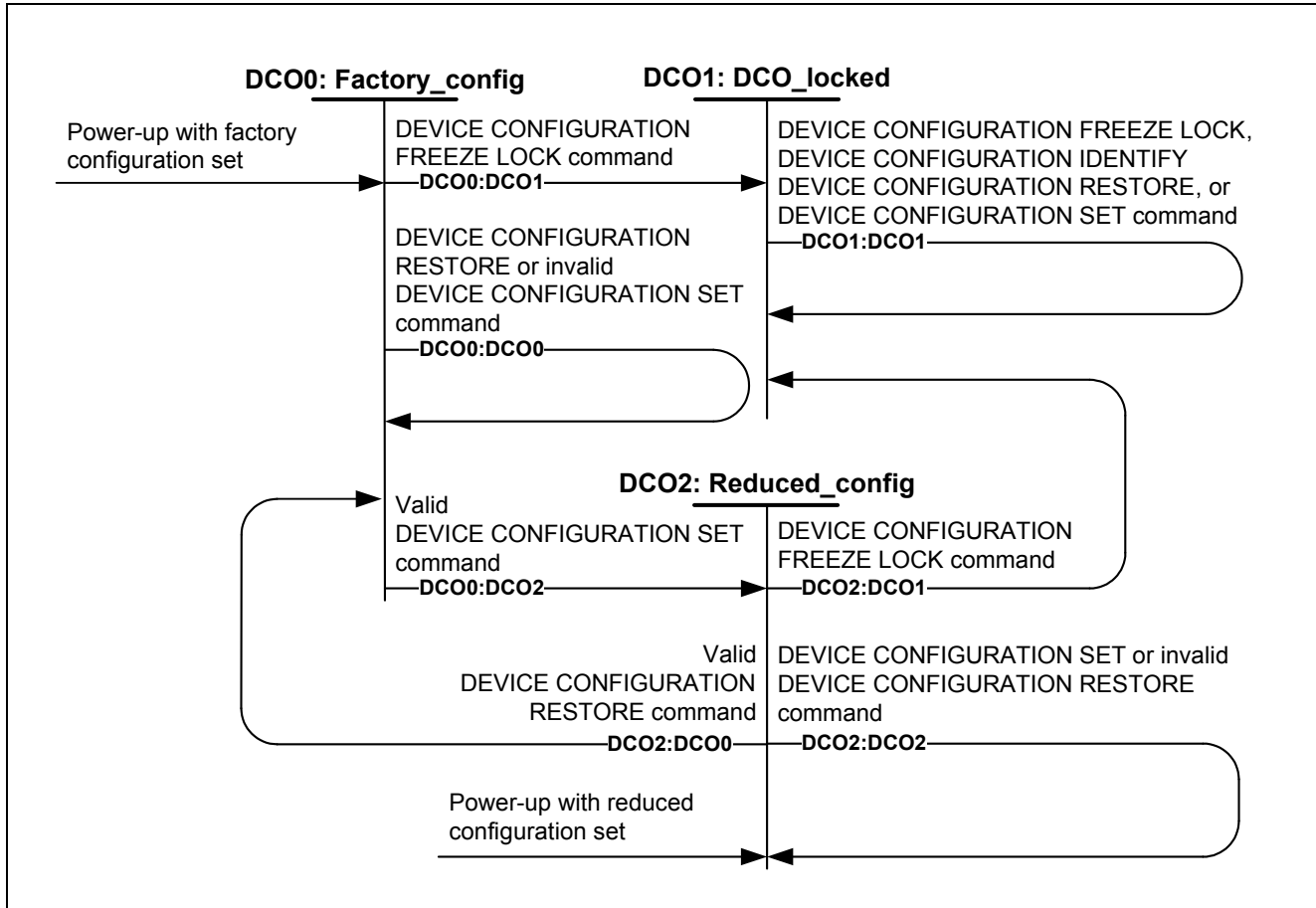

Figure 4 — Device Configuration Overlay state diagram

DCO0: Factory_config State: This state is entered when the device powers-up with the factory configuration set or a valid DEVICE CONFIGURATION RESTORE command is received.

When in this state, the device shall support all commands, modes, feature sets, and the capacity indicated by the response to a DEVICE CONFIGURATION IDENTIFY command.

Transition DCO0:DCO1: When a DEVICE CONFIGURATION FREEZE LOCK command is received, the device shall return successful command completion and transition to the DCO1: DCO_locked state.

Transition DCO0:DCO2: When a valid DEVICE CONFIGURATION SET command is received, the device shall return successful command completion and transition to the DCO2: Reduced_config state. See Transition DCO0:DCO0 for the definition of conditions that make a DEVICE CONFIGURATION SET command invalid. This transition is made even if the configuration described by the DEVICE CONFIGURATION SET command is the same as the factory configuration.

Transition DCO0:DCO0: When a DEVICE CONFIGURATION RESTORE command is received, the device shall return command aborted and transition to the DCO0: Factory_config state. When an invalid DEVICE CONFIGURATION SET command is received, the device shall return command aborted and transition to the DCO0: Factory_config state. A device shall return command aborted if the DEVICE CONFIGURATION SET command requests that a device remove support for:

- a) the HPA feature set (see 4.11) if a HPA has been established;
- b) a Multiword or Ultra DMA mode if that mode or a higher numbered mode is currently selected;

- c) the PUIS feature set (see 4.19) if the PUIS feature set has been enabled by a jumper;
- d) the Security feature set (see 4.20) if the Security feature set has been enabled;
- e) the SMART feature set (see 4.21) if the DEVICE CONFIGURATION SET output data word 7 bits (2:1) are not cleared to zero; or
- f) the SMART feature set (see 4.21) if the SMART feature set is enabled.

DCO1: DCO_locked State: This state is entered when a DEVICE CONFIGURATION FREEZE LOCK command is received.

When in this state, all DEVICE CONFIGURATION FREEZE LOCK, DEVICE CONFIGURATION IDENTIFY, DEVICE CONFIGURATION SET, or DEVICE CONFIGURATION RESTORE commands shall return command aborted and shall remain in the same state.

Transition DCO1:DCO1: When a DEVICE CONFIGURATION FREEZE LOCK, DEVICE CONFIGURATION IDENTIFY, DEVICE CONFIGURATION SET, or DEVICE CONFIGURATION RESTORE command is received, the device shall return command aborted and shall remain in the same state.

DCO2: Reduced_config State: This state is entered when the device powers-up with a reduced configuration set or a valid DEVICE CONFIGURATION SET command is received.

When in this state, the device shall support all commands, modes, feature sets, and the capacity specified by the DEVICE CONFIGURATION SET command that caused this state to be entered.

Transition DCO2:DCO1: When a DEVICE CONFIGURATION FREEZE LOCK command is received, the device shall return successful command completion and transition to the DCO1: DCO_locked state.

Transition DCO2:DCO0: When a valid DEVICE CONFIGURATION RESTORE command is received, the device shall return successful command completion and transition to the DCO0: Factory_config state. See Transition DCO2:DCO2 for the definition of conditions that make a DEVICE CONFIGURATION RESTORE command invalid.

Transition DCO2:DCO2: When a DEVICE CONFIGURATION SET command is received, the device shall return command aborted and transition to the DCO2: Reduced_config state. When an invalid DEVICE CONFIGURATION RESTORE command is received, the device shall return command aborted and transition to the DCO2: Reduced_config state. A DEVICE CONFIGURATION RESTORE command is invalid if a Host Protected Area has been established using the SET MAX ADDRESS command.

4.9 Free-fall Control feature set

The Free-fall Control feature allows the device to attempt to protect itself in the event of free-fall detection. When this feature is enabled, upon detecting a free-fall event the device should protect its data from the mechanical contact that may damage data on the device. The implementation of free-fall detection and protection is vendor specific.

The Free-fall Control feature set is enabled and disabled using the following SET FEATURES subcommands:

- a) SET FEATURES subcommand 41h - enable the Free-fall Control feature set; and
- b) SET FEATURES subcommand C1h - disable the Free-fall Control feature set.

The Enable/Disable Free-fall Control subcommands shall be non-volatile. After the feature is enabled, the device shall keep this feature enabled until changed by the Enable/Disable Free-fall Control subcommands.

IDENTIFY DEVICE data word 120 bit 5 or IDENTIFY PACKET DEVICE data word 120 bit 5 indicates when the Free-fall Control feature set is enabled.

4.10 General Purpose Logging (GPL) feature set

The General Purpose Logging (GPL) feature set provides a mechanism for accessing logs in a device. These logs are associated with specific feature sets (e.g., SMART (see 4.21) and Streaming (see 4.23)). Support of the individual logs (see table A.2) is determined by support of the associated feature set. If the device supports a particular feature set, support for any associated log(s) is mandatory.

Support for the GPL feature set shall not be disabled by disabling SMART. If the feature set associated with a requested log is disabled, the device shall return command aborted.

If the GPL feature set is implemented, the following commands shall be supported:

- a) READ LOG EXT
- b) WRITE LOG EXT

The following commands are optional:

- a) READ LOG DMA EXT
- b) WRITE LOG DMA EXT

If the GPL feature set is supported, all Host Vendor Specific logs shall be supported (see A.9).

4.11 Host Protected Area (HPA) feature set

4.11.1 HPA overview

The optional Host Protected Area (HPA) feature set provides a method for an application client to reduce the number of user accessible LBAs on a device. This method results in providing a data storage area on the device that may be used by that application client but may temporarily be inaccessible to other application clients. A device that implements the HPA feature set shall implement the following minimum set of commands:

- a) READ NATIVE MAX ADDRESS
- b) SET MAX ADDRESS

A device that implements the HPA feature set and supports the 48-bit Address feature set (see 4.4) shall implement the following additional set of commands:

- a) READ NATIVE MAX ADDRESS EXT
- b) SET MAX ADDRESS EXT

Devices supporting this feature set shall set IDENTIFY DEVICE data word 82 bit 10 to one.

NOTE 2 — The PARTIES standard specifies a method for managing the HPA.

4.11.2 HPA security extensions

A device supporting the HPA feature set may optionally include the HPA security extensions. The Host Protected Area security commands use a single command code and are differentiated from one another by the value placed in the Feature field:

- a) SET MAX SET PASSWORD
- b) SET MAX LOCK
- c) SET MAX FREEZE LOCK
- d) SET MAX UNLOCK

Devices supporting these extensions shall set IDENTIFY DEVICE data word 82 bit 10 or IDENTIFY PACKET DEVICE data word 82 bit 10 to one, and shall set IDENTIFY DEVICE data word 83 bit 8 or IDENTIFY PACKET DEVICE data word 83 bit 8 to one.

Upon successful completion of a power-on reset, the HPA security extensions are disabled and IDENTIFY DEVICE data word 86 bit 8 or IDENTIFY PACKET DEVICE data word 86 bit 8 is cleared to zero. There is no valid HPA password after the device processes a power-on reset and IDENTIFY DEVICE data word 86 bit 8 or IDENTIFY PACKET DEVICE data word 86 bit 8 is cleared to zero.

When a SET MAX SET PASSWORD command is completed without error, the HPA security extensions are enabled. In addition IDENTIFY DEVICE data word 86 bit 8 or IDENTIFY PACKET DEVICE data word 86 bit 8 shall be set to one.

4.11.3 28-bit and 48-bit HPA commands interactions

The READ NATIVE MAX ADDRESS or READ NATIVE MAX ADDRESS EXT command allows the host to determine the maximum native address space of the device even when a protected area has been allocated.

The SET MAX ADDRESS or SET MAX ADDRESS EXT command allows the host to redefine the maximum LBA of the user accessible LBA space. That is, when the SET MAX ADDRESS or SET MAX ADDRESS EXT command is issued with a maximum LBA less than the native max address, the device reduces the user

accessible LBA space to the maximum specified by the command, providing a protected area above that maximum LBA. See 4.11.4 for a description of how to set IDENTIFY DEVICE data after issuing a SET MAX ADDRESS or SET MAX ADDRESS EXT command.

Any read or write that attempts to access an LBA above the maximum LBA specified by the SET MAX ADDRESS or SET MAX ADDRESS EXT command shall cause command completion with the ID Not Found bit set to one and the Error bit set to one, or command aborted.

A Volatility bit in the Count field allows the host to specify if the SET MAX ADDRESS LBA field is preserved after a power-on reset or a hardware reset. After processing a power-on reset or hardware reset, the device sets the maximum LBA to the last non-volatile LBA setting regardless of subsequent volatile SET MAX ADDRESS or SET MAX ADDRESS EXT commands. If the SET MAX ADDRESS or SET MAX ADDRESS EXT command is issued with a value that exceeds the native max address, then the device shall return command aborted.

Software reset shall not:

- a) affect the HPA feature set settings in the device;
- b) change the maximum accessible LBA for the device; or
- c) change the HPA state of the device.

When the device is HPA Unlocked and has not processed a SET MAX FREEZE LOCK command, then multiple SET MAX SET PASSWORD commands may be processed. The device only keeps the password set by the last SET MAX SET PASSWORD command; previously received passwords are overwritten by the new password. There is no limit to the number of times the password may be set.

Typical use of these commands is:

After a power-on reset or a hardware reset is processed:

- 1) BIOS receives control after the reset;
- 2) BIOS issues a READ NATIVE MAX ADDRESS or READ NATIVE MAX ADDRESS EXT command to find the max capacity of the device;
- 3) BIOS issues a volatile SET MAX ADDRESS or SET MAX ADDRESS EXT command to the values returned by READ NATIVE MAX ADDRESS or READ NATIVE MAX ADDRESS EXT;
- 4) BIOS reads configuration data from the highest area on the disk;
- 5) BIOS restores the protected area by issuing a non-volatile SET MAX ADDRESS or SET MAX ADDRESS EXT using the original LBA.

On save to disk

- 1) BIOS receives control prior to shut down;
- 2) BIOS issues a READ NATIVE MAX ADDRESS or READ NATIVE MAX ADDRESS EXT command to find the max capacity of the device;
- 3) BIOS issues a volatile SET MAX ADDRESS or SET MAX ADDRESS EXT command to the values returned by READ NATIVE MAX ADDRESS or READ NATIVE MAX ADDRESS EXT;
- 4) Memory is copied to the reserved area;
- 5) Shut down completes;
- 6) After processing a power-on reset or hardware reset, the device sets the maximum LBA to the last non-volatile LBA setting regardless of subsequent volatile SET MAX ADDRESS or SET MAX ADDRESS EXT commands.

These commands are intended for use only by system BIOS or other low-level boot time processes. Using these commands outside BIOS controlled boot or shutdown may result in damage to file systems on the device.

The SET MAX SET PASSWORD command allows the host to define the password to be used during the current power cycle. The password does not persist after a power-on reset has been processed but does persist after a hardware reset or a software reset has been processed. This password is not related to the password used for the Security feature set (see 4.20). When the password is set the device is HPA Unlocked.

The SET MAX LOCK command provides a method for the host to disable the SET MAX commands, except SET MAX UNLOCK, until after the device has processed the next power-on reset or command completion of a SET MAX UNLOCK command. When the SET MAX LOCK command is completed the device is HPA Locked.

The SET MAX UNLOCK command changes the device from HPA Locked to HPA Unlocked.

The SET MAX FREEZE LOCK command provides a method for the host to disable the SET MAX commands, including SET MAX UNLOCK, until after the device has processed the next power-on reset.

4.11.4 IDENTIFY DEVICE data

When the host issues a SETMAX ADDRESS command or SETMAX ADDRESS EXT command, several IDENTIFY DEVICE data words may be affected. The following guidelines are used for setting IDENTIFY DEVICE data:

- a) if the 48-bit Address feature set is not supported then words 60-61 shall contain the total number of user addressable sectors and words 100-103 shall be reserved;
- b) if the 48-bit Address feature set is supported and the total number of user addressable sectors is less than or equal to 0FFF_FFFFh then Words 60-61 and 100-103 shall contain the total number of user addressable sectors; and
- c) if the 48-bit Address feature set is supported and the total number of user addressable sectors is greater than 0FFF_FFFFh then words 60-61 shall contain 0FFF_FFFFh and words 100-103 shall contain the total number of user addressable sectors.

4.11.5 Determination of SET MAX security extension status

When the device is HPA Locked IDENTIFY DEVICE data word 86 bit 8 or IDENTIFY PACKET DEVICE data word 86 bit 8 shall be set to one.

4.11.6 HPA State Transition Diagrams

4.11.6.1 State Transition Figures

The HPA state transition diagrams are in five parts: figure 5, figure 6, figure 7, figure 8, and figure 9.

In the following state transition diagrams, the notation COMMAND (value) refers to the device receiving the command with a specific value or values. For example:

- a) SET MAX ADDRESS (Non-Volatile) means the device successfully processes a SET MAX ADDRESS command with the V_V field set to one; or
- b) SET MAX ADDRESS (Native Max) means the device successfully processes a SET MAX ADDRESS command with the LBA field set to the native max address.

If a state has a transition condition that specifies native max, then any other set max conditions imply a value less than the native max value. If a state has a transition condition that specifies neither volatile nor non-volatile, then both are implied.

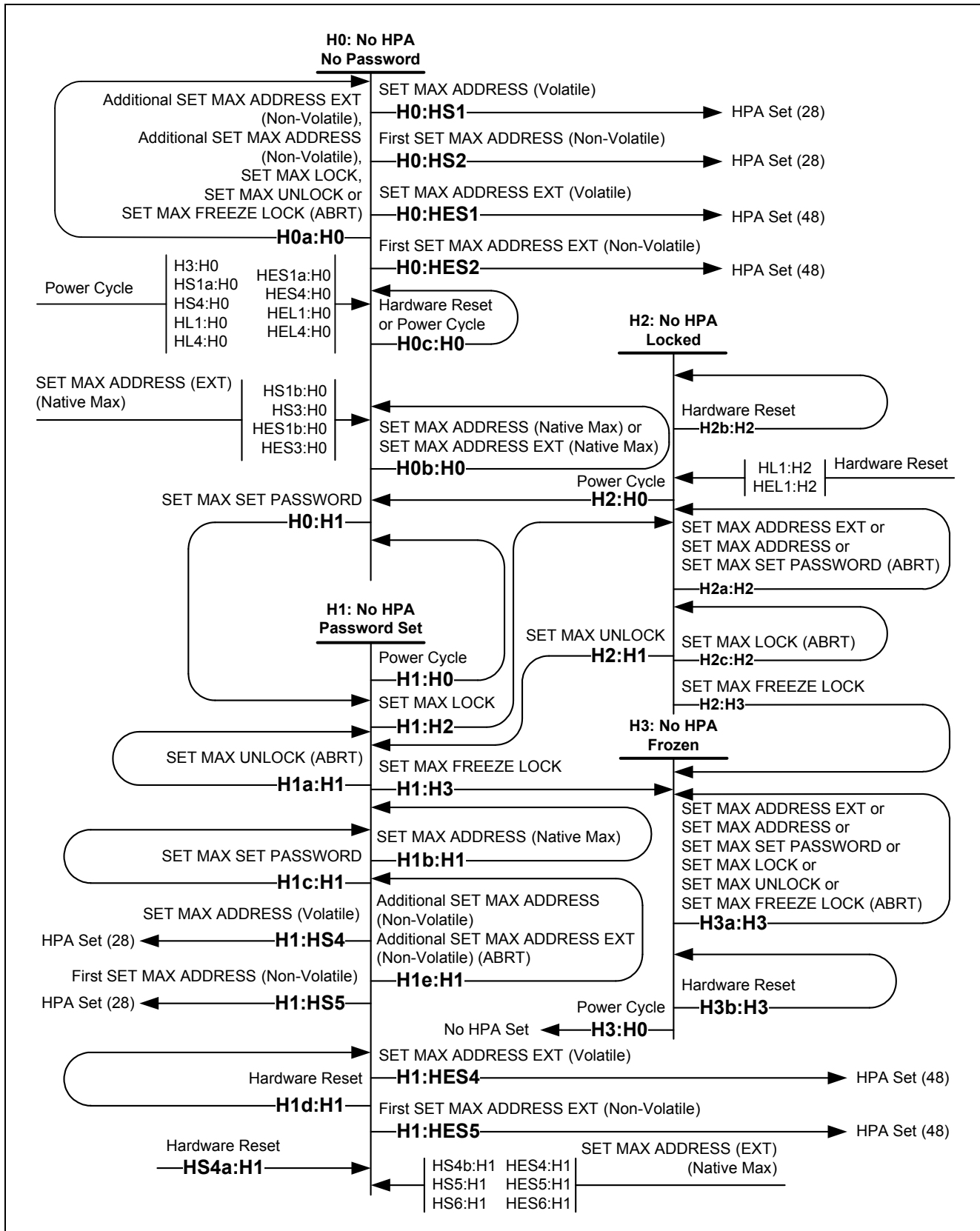

Figure 5 — HPA Not Set

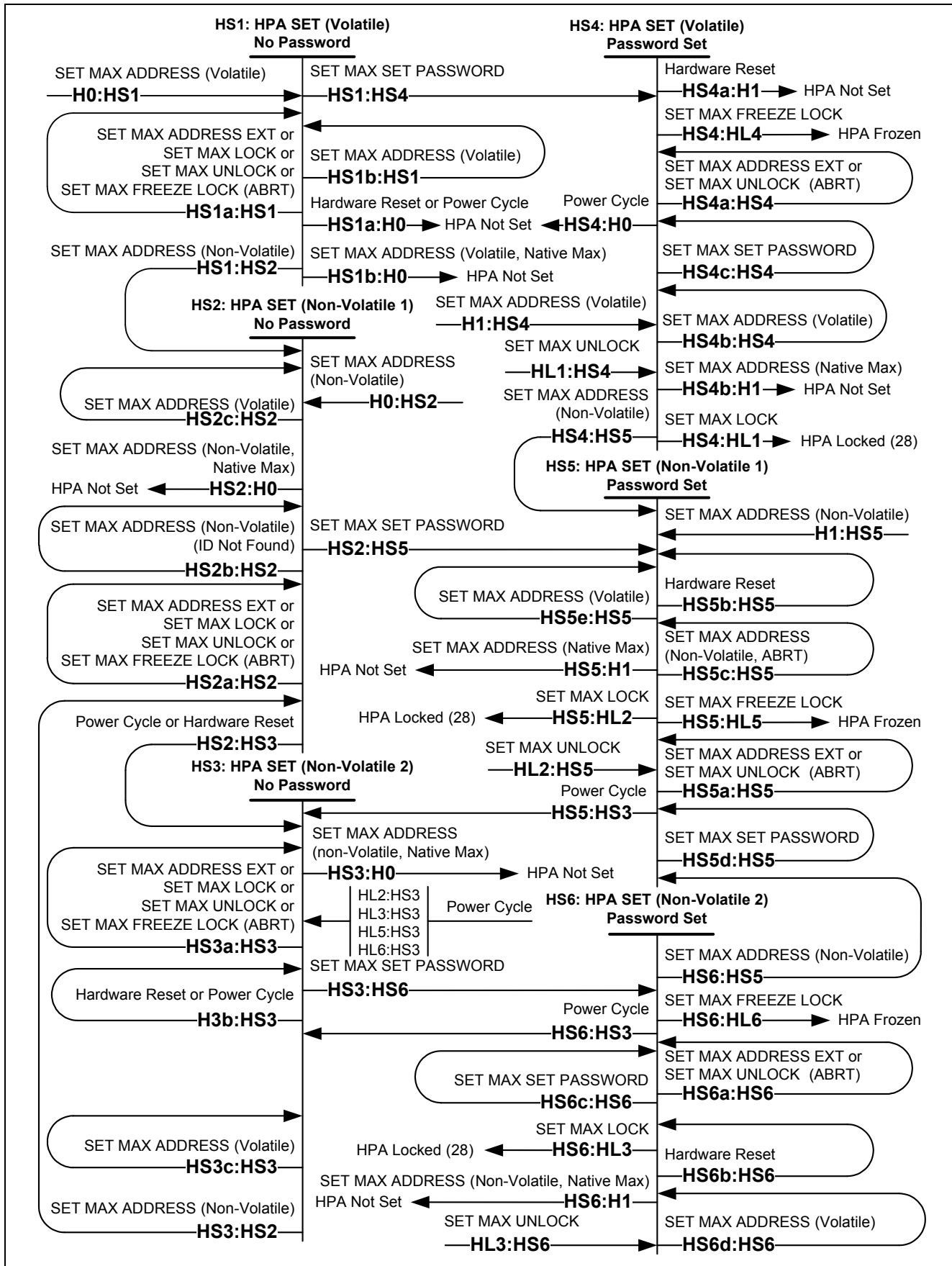

Figure 6 — HPA Set (28)

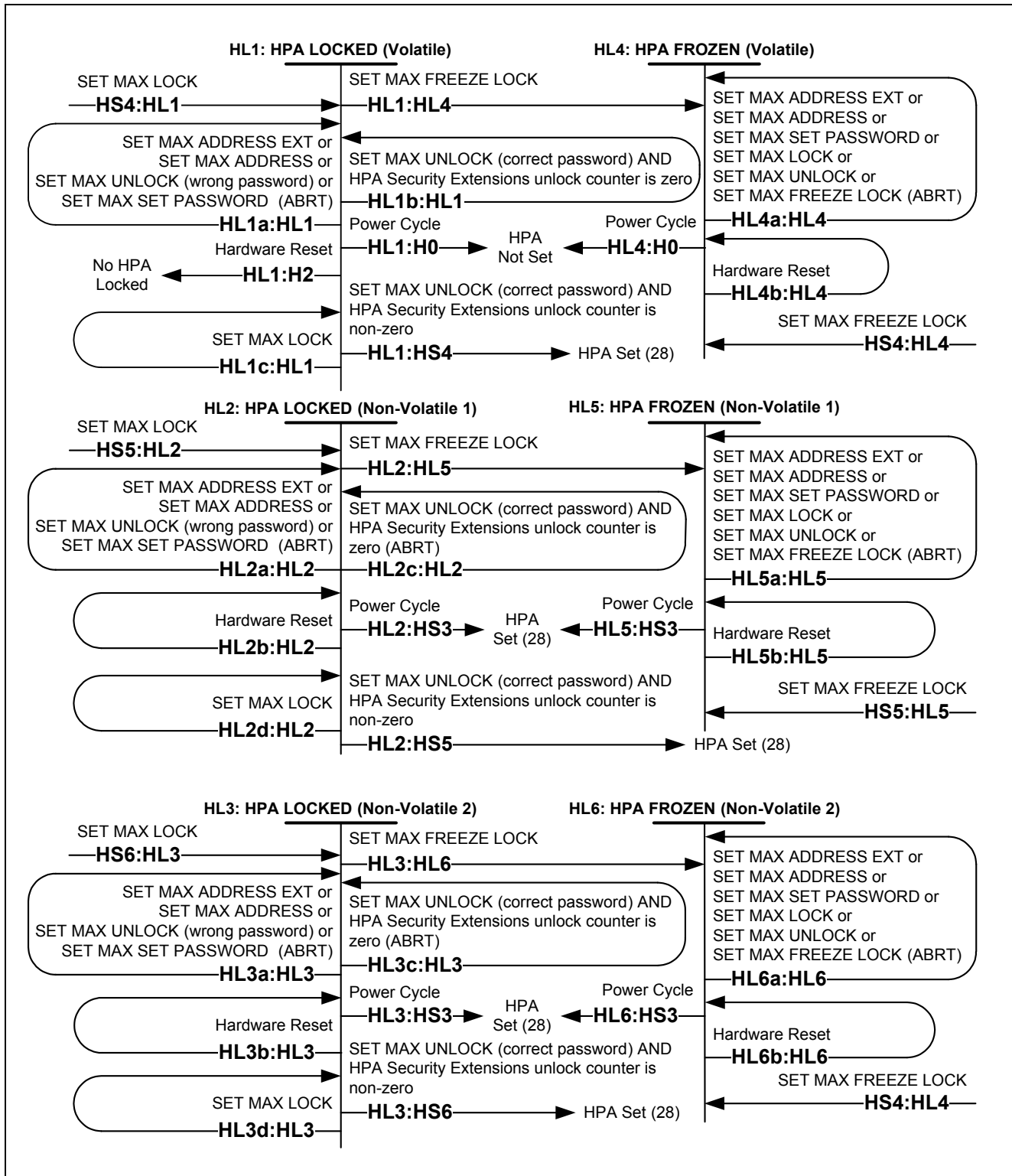

Figure 8 — HPA Locked (28)

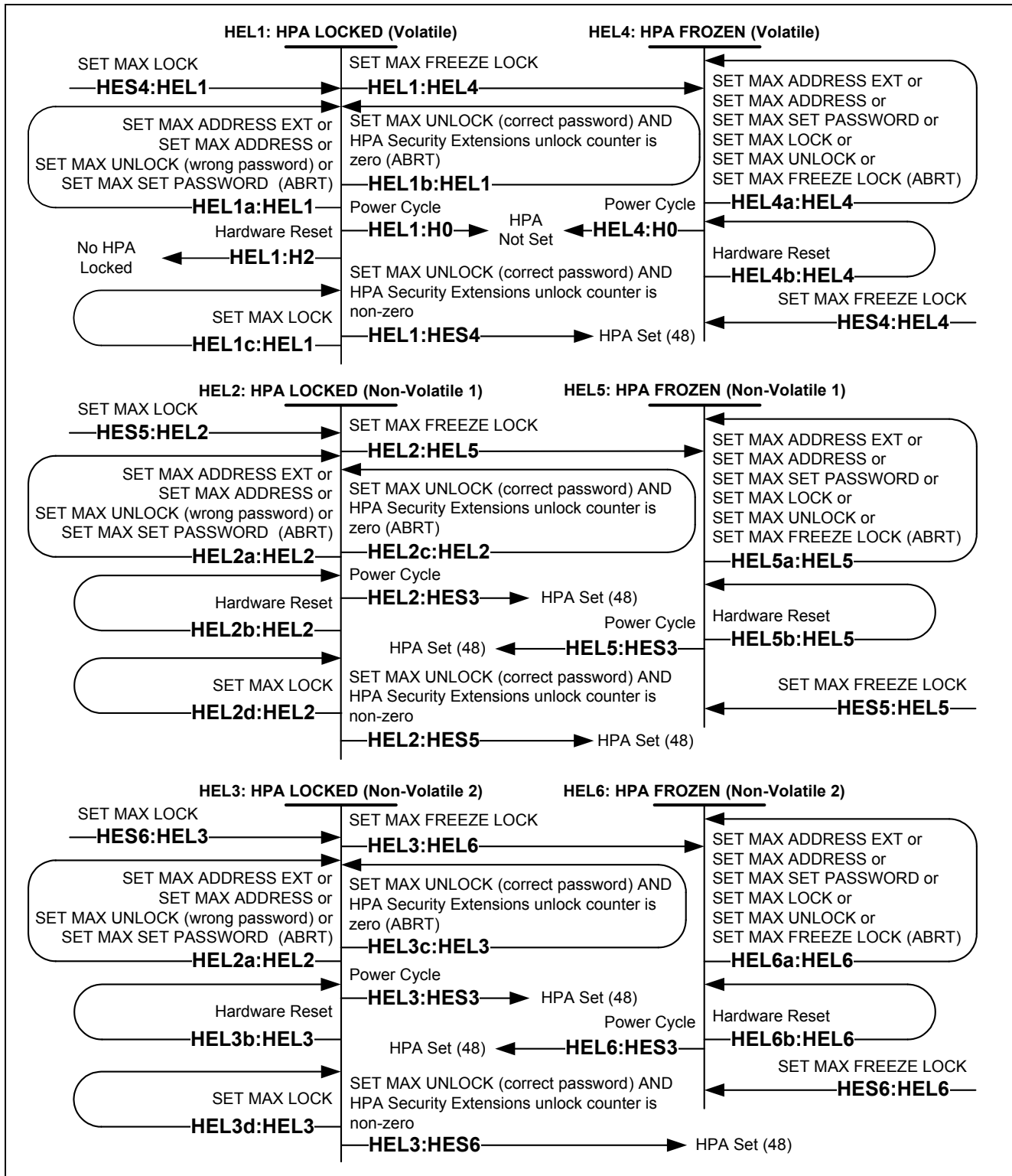

Figure 9 — HPA Locked (48)

4.11.6.2 HPA Not Set

State H0: No HPA/No Password: This state shall be entered when the device is powered on and does not have a non-volatile max address set. In this state the device has not established the HPA and the password has not been set.

Transition H0:H1: When the device successfully processes a SET MAX SET PASSWORD command without error, the device shall transition to the H1 state.

Transition H0:HS1: When the device successfully processes a SET MAX ADDRESS (Volatile) command without error, the device shall process the command and transition to the HS1 state.

Transition H0:HS2: When the device successfully processes a First SET MAX ADDRESS (non-volatile) command without error, the device shall process the command and transition to the HS2 state. A "First SET MAX ADDRESS (non-volatile) command" is the first SET MAX ADDRESS (non-volatile) command processed by the device after a Power-on reset.

Transition H0:HES1: When the device successfully processes a SET MAX ADDRESS EXT (Volatile) command without error, the device shall process the command and transition to the HES1 state.

Transition H0:HES2: When the device successfully processes a SET MAX ADDRESS EXT (Non-Volatile) command without error, the device shall process the command and transition to the HES2 state.

Transition H0a:H0: When the device successfully processes a SET MAX LOCK, SET MAX UNLOCK, SET MAX FREEZE LOCK, additional SET MAX ADDRESS EXT (non-volatile), or an additional SET MAX ADDRESS (non-volatile) command without error, the device shall return command aborted and remain in the same state. An "additional SET MAX ADDRESS (non-volatile) command" is a SET MAX ADDRESS (non-volatile) command that is processed by the device after a previous SET MAX ADDRESS (non-volatile) command has been successfully processed by the device with no intervening Power-on reset.

Transition H0b:H0: When the device successfully processes a SET MAX ADDRESS (Native Max) command or SET MAX ADDRESS EXT (Native Max) command without error, the device shall remain in the same state.

Transition H0c:H0: When the device successfully processes a hardware reset or a power-on reset, the device shall remain in the same state.

State H1: No HPA/Password Set: In this state the device has not established the HPA and the password has been set.

Transition H1:H0: When the device successfully processes a power-on reset, the device shall transition to the H0 state.

Transition H1:H2: When the device successfully processes a SET MAX LOCK command, the device shall transition to the H2 state.

Transition H1:H3: When the device successfully processes a SET MAX FREEZE LOCK command without error, the device shall transition to the H3 state.

Transition H1:HS4: When the device successfully processes a SET MAX ADDRESS (Volatile), the device shall transition to the HS4 state.

Transition H1:HES4: When the device successfully processes a SET MAX ADDRESS EXT (Volatile), the device shall transition to the HES4 state.

Transition H1:HES5: When the device successfully processes a First SET MAX ADDRESS EXT (Non-Volatile), the device shall transition to the HES5 state. A "First SET MAX ADDRESS EXT (non-volatile) command" is the first SET MAX ADDRESS (non-volatile) command processed by the device after a Power-on reset

Transition H1:HS5: When the device successfully processes a First SET MAX ADDRESS (Non-Volatile), the device shall transition to the HS5 state. A "First SET MAX ADDRESS (non-volatile) command" is the first SET MAX ADDRESS (non-volatile) command processed by the device after a Power-on reset.

Transition H1a:H1: When the device successfully processes a SET MAX UNLOCK command, the device shall report command aborted and remain in the same state.

Transition H1b:H1: When the device successfully processes a SET MAX ADDRESS (Native Max) command without error, the device shall remain in the same state.

Transition H1c:H1: When the device successfully processes a SET MAX SET PASSWORD command without error, the device shall remain in the same state.

Transition H1d:H1: If the device processes a hardware reset, the device shall remain in the same state.

Transition H1e:H1: When the device successfully processes an additional SET MAX ADDRESS EXT (non-volatile) or an additional SET MAX ADDRESS (non-volatile) command, the device shall return command aborted and remain in the same state. An "additional SET MAX ADDRESS (non-volatile) command" is a SET MAX ADDRESS (non-volatile) command that is processed by the device after a previous SET MAX ADDRESS (non-volatile) command has been successfully processed by the device with no intervening Power-on reset.

State H2: No HPA/Locked: In this state the device is HPA Locked and only the power cycle transits the state to the H0 state.

Transition H2:H0: When the device successfully processes a power-on reset, the device shall transition to the H0 state.

Transition H2:H1: When the device successfully processes a SET MAX UNLOCK command with the correct password, the device shall transition to the H1 state.

Transition H2:H3: When the device successfully processes a SET MAX FREEZE LOCK command with the correct password, the device shall transition to the H3 state.

Transition H2a:H2: When the device successfully processes a SET MAX ADDRESS EXT, SET MAX ADDRESS, or SET MAX SET PASSWORD command, the device shall return command aborted and remain in the same state.

Transition H2b:H2: If the device processes a hardware reset, then the device shall remain in the same state.

Transition H2c:H2: If the device successfully processes a SET MAX LOCK command, the device shall remain in the same state and the device may return command aborted.

State H3: No HPA FROZEN: In this state no HPA is established and the device is locked from all HPA commands. Only a power-cycle shall cause the device to change to another state.

Transition H3:H0: When the device successfully processes a power-on reset, the device shall transition to the H0 state.

Transition H3a:H3: When the device successfully processes a SET MAX ADDRESS EXT, SET MAX ADDRESS, SET MAX LOCK, SET MAX UNLOCK, SET MAX FREEZE LOCK or SET MAX SET PASSWORD command, the device shall return command aborted and remain in the same state.

Transition H3b:H3: When the device processes a hardware reset, the device shall remain in the same state.

4.11.6.3 28-bit HPA Set

State HS1: HPA SET (Volatile)/No Password: In this state the volatile 28-bit HPA is established and the password is not set.

Transition HS1:HS2: When the device successfully processes a SET MAX ADDRESS command without error in non-volatile state, the device shall transition to the HS2 state.

Transition HS1:HS4: When the device successfully processes a SET MAX SET PASSWORD command without error, the device shall transition to the HS4 state.

Transition HS1a:H0: When the device successfully processes a hardware reset or if device processes a power-on reset, the device shall transition to the H0 state.

Transition HS1b:H0: When the device successfully processes a SET MAX ADDRESS (Native Max) command without error, the device shall transition to the H0 state.

Transition HS1a:HS1: When the device successfully processes a SET MAX ADDRESS EXT, SET MAX LOCK, SET MAX UNLOCK or SET MAX FREEZE LOCK command, the device shall return command aborted and remain in the same state.

Transition HS1b:HS1: When the device successfully processes a SET MAX ADDRESS (Volatile) command, the device shall remain in the same state.

State HS2: HPA SET (Non-Volatile 1)/No Password: In this state the non-volatile 28-bit HPA is established and the password is not set.

Transition HS2:H0: When the device successfully processes a SET MAX ADDRESS (Non-Volatile, Native Max) command, the device shall transition to the H0 state.

Transition HS2:HS5: When the device successfully processes a SET MAX SET PASSWORD command, the device shall transition to the HS5 state.

Transition HS2a:HS2: When the device successfully processes a SET MAX ADDRESS EXT, SET MAX LOCK, SET MAX UNLOCK or SET MAX FREEZE LOCK command, the device shall return command aborted and remain in the same state.

Transition HS2b:HS2: When the device successfully processes a SET MAX ADDRESS (Non-Volatile) command, the device shall return ID Not Found and remain in the same state.

Transition HS2c:HS2: When the device successfully processes a SET MAX ADDRESS (Volatile) command, the device shall remain in the same state.

Transition HS2:HS3: When the device successfully processes a power-on reset or a hardware reset, the device shall make transition to the HS3 state.

State HS3: HPA SET (Non-Volatile 2)/No Password: In this state the non-volatile 28-bit HPA is established and the password is not set.

Transition HS3:H0: When the device successfully processes a SET MAX ADDRESS (Non-Volatile, Native Max) command, the device shall transition to the H0 state.

Transition HS3:HS2: When the device successfully processes a SET MAX ADDRESS (Non-Volatile) command without error, the device shall transition to the HS2 state.

Transition HS3:HS6: When the device successfully processes a SET MAX SET PASSWORD command without error, the device shall transition to the HS6 state.

Transition HS3a:HS3: When the device successfully processes a SET MAX ADDRESS EXT, SET MAX LOCK, SET MAX UNLOCK or SET MAX FREEZE LOCK command, the device shall return command aborted and remain in the same state.

Transition HS3b:HS3: When the device successfully processes a hardware reset or when the device successfully processes a power-on reset, the device shall remain in the same state.

Transition HS3c:HS3: When the device successfully processes a SET MAX ADDRESS (Volatile) command without error, the device shall remain in the same state.

State HS4: HPA SET (Volatile)/Password Set: In this state the volatile 28-bit HPA is established and the password is set.

Transition HS4:HL1: When the device successfully processes a SET MAX LOCK command, the device shall transition to the HL1 state.

Transition HS4:HL4: When the device successfully processes a SET MAX FREEZE LOCK command, the device shall transition to the HL4 state.

Transition HS4:H0: When the device successfully processes a power-on reset, the device shall transition to the H0 state.

Transition HS4:HS5: When the device successfully processes a SET MAX ADDRESS (Non-Volatile) command, the device shall process the command and transition to the HS5 state.

Transition HS4a:H1: When the device processes a hardware reset, the device shall transition to the H1 state.

Transition HS4b:H1: When the device successfully processes a SET MAX ADDRESS (Native Max) command without error, the device shall transition to the H1 state.

Transition HS4a:HS4: When the device successfully processes a SET MAX ADDRESS EXT or SET MAX UNLOCK command, the device shall return command aborted and remain in the same state.

Transition HS4b:HS4: When the device successfully processes a SET MAX ADDRESS (Volatile), the device shall remain in the same state.

Transition HS4c:HS4: When the device successfully processes a SET MAX SET PASSWORD command, the device shall remain in the same state.

State HS5: HPA SET (Non-Volatile 1)/Password Set: In this state the non-volatile 28-bit HPA is established and the password is set.

Transition H1:HS5: When the device successfully processes a SET MAX ADDRESS (Non-Volatile), the device shall transition to the HS5 state.

Transition HS5:H1: When the device successfully processes a SET MAX ADDRESS (Native Max) command, the device shall transition to the H1 state.

Transition HS5:HL2: When the device successfully processes a SET MAX LOCK command, the device shall transition to the HL2 state.

Transition HS5:HL5: When the device successfully processes a SET MAX FREEZE LOCK command, the device shall transition to the HL5 state.

Transition HS5:HS3: When the device successfully processes a power-on reset, the device shall transition to the HS3 state.

Transition HS5a:HS5: When the device successfully processes a SET MAX ADDRESS EXT or SET MAX UNLOCK command, the device shall return command aborted and remain in the same state.

Transition HS5b:HS5: When the device successfully processes a hardware reset, the device shall remain in the same state.

Transition HS5c:HS5: When the device successfully processes a SET MAX ADDRESS (Non-Volatile), the device shall return command aborted and remain in the same state.

Transition HS5d:HS5: When the device successfully processes a SET MAX SET PASSWORD command, the device shall remain in the same state.

Transition HS5e:HS5: When the device successfully processes a SET MAX ADDRESS (Volatile) command, the device shall remain in the same state.

State HS6: HPA SET (Non-Volatile 2)/Password Set: In this state the non-volatile 28-bit HPA is established and the password is set.

Transition HS6:HS5: When the device successfully processes a SET MAX ADDRESS (Non-Volatile), the device shall transition to the HS5 state.

Transition HS6:H1: When the device successfully processes a SET MAX ADDRESS (Non-Volatile, Native Max) command, the device shall transition to the H1 state.

Transition HS6:HL3: When the device successfully processes a SET MAX LOCK command, the device shall transition to the HL3 state.

Transition HS6:HL6: When the device successfully processes a SET MAX FREEZE LOCK command, the device shall transition to the HL6 state.

Transition HS6:HS3: When the device successfully processes a power-on reset, the device shall transition to the HS3 state.

Transition HS6a:HS6: When the device successfully processes a SET MAX ADDRESS EXT or SET MAX UNLOCK command, the device shall return command aborted and remain in the same state.

Transition HS6b:HS6: When the device successfully processes a hardware reset, the device shall remain in the same state.

Transition HS6c:HS6: When the device successfully processes a SET MAX SET PASSWORD command, the device shall remain in the same state.

Transition HS6d:HS6: When the device successfully processes a SET MAX ADDRESS (Volatile) command, the device shall remain in the same state.

4.11.6.4 48-Bit HPA Set

State HES1: HPA SET (Volatile)/No Password: In this state the volatile 48-bit HPA is established and the password is not set.

Transition HES1:HES2: When the device successfully processes a SET MAX ADDRESS EXT (Non-Volatile), the device shall transition to the HES2 state.

Transition HES1:HES4: When the device successfully processes a SET MAX SET PASSWORD command, the device shall transition to the HES4 state.

Transition HES1a:H0: When the device successfully processes a hardware reset or if the device successfully processes a power-on reset, the device shall transition to the H0 state.

Transition HES1b:H0: When the device successfully processes a SET MAX ADDRESS (Native Max) command, the device shall transition to the H0 state.

Transition HES1:HES1: When the device successfully processes a SET MAX ADDRESS, SET MAX LOCK, SET MAX UNLOCK or SET MAX FREEZE LOCK command, the device shall return command aborted and remain in the same state.

State HES2: HPA SET (Non-Volatile 1)/No Password: In this state the non-volatile 48-bit HPA is established and the password is not set.

Transition HES2:H0: When the device successfully processes a SET MAX ADDRESS EXT (Non-Volatile, Native Max) command, the device shall transition to the H0 state.

Transition HES2:HES3: When the device successfully processes a power-on reset or a hardware reset, the device shall transition to the HES3 state.

Transition HES2:HES5: When the device successfully processes a SET MAX SET PASSWORD command, the device shall transition to the HES5 state.

Transition HES2a:HES2: When the device successfully processes a SET MAX ADDRESS, SET MAX LOCK, SET MAX UNLOCK or SET MAX FREEZE LOCK command, the device shall return command aborted and remain in the same state.

Transition HES2b:HES2: When the device successfully processes a SET MAX ADDRESS EXT (Non-Volatile), the device shall return command aborted and remain in the same state.

Transition HES2c:HES2: When the device successfully processes a SET MAX ADDRESS EXT (Volatile) command, the device shall remain in the same state.

State HES3: HPA SET (Non-Volatile 2)/No Password: In this state the non-volatile 48-bit HPA is established and the password is not set.

Transition HES3:H0: When the device successfully processes a SET MAX ADDRESS EXT (Non-Volatile, Native Max) command, the device shall transition to the H0 state.

Transition HES3:HES2: When the device successfully processes a SET MAX ADDRESS EXT (Non-Volatile) command, the device shall transition to the HES2 state.

Transition HES3:HES6: When the device successfully processes a SET MAX SET PASSWORD command, the device shall transition to the HES6 state.

Transition HES3a:HES3: When the device successfully processes a SET MAX ADDRESS EXT, SET MAX LOCK, SET MAX UNLOCK or SET MAX FREEZE LOCK command, the device shall return command aborted and remain in the same state.

Transition HES3b:HES3: When the device successfully processes a hardware reset or when the device successfully processes a power-on reset, the device shall remain in the same state.

Transition HES3c:HES3: When the device processes a SET MAX ADDRESS EXT (Volatile) command without error, the device shall remain in the same state..

State HES4: HPA SET (Volatile)/Password Set: In this state the volatile 48-bit HPA is established and the password is set.

Transition HES4:H0: When the device successfully processes a power-on reset, the device shall transition to the H0 state.

Transition HES4:HES5: When the device successfully processes a SET MAX ADDRESS EXT (Non-Volatile) command, the device shall transition to the HES5 state.

Transition HES4:HEL1: When the device successfully processes a SET MAX LOCK command, the device shall transition to the HEL1 state.

Transition HES4a:H1: When the device processes a hardware reset, the device shall transition to the H1 state.

Transition HES4b:H1: When the device successfully processes a SET MAX ADDRESS (Native Max) command, the device shall transition to the H1 state.

Transition HES4:HEL4: When the device successfully processes a SET MAX FREEZE LOCK command, the device shall transition to the HEL4 state.

Transition HES4a:HES4: When the device successfully processes a SET MAX ADDRESS or SET MAX UNLOCK command, the device shall return command aborted and remain in the same state.

Transition HES4b:HES4: When the device successfully processes a SET MAX ADDRESS EXT (Volatile) command, the device shall remain in the same state.

Transition HES4c:HES4: When the device successfully processes a SET MAX SET PASSWORD command, the device shall remain in the same state.

State HES5: HPA SET (Non-Volatile 1)/Password Set: In this state the non-volatile 48-bit HPA is established and the password is set.

Transition HES5:H1: When the device successfully processes a SET MAX ADDRESS EXT (Non-volatile, Native Max) command, the device shall transition to the H1 state.

Transition HES5:HEL2: When the device successfully processes a SET MAX LOCK command, the device shall transition to the HEL2 state.

Transition HES5:HES3: When the device successfully processes a power-on reset, the device shall transition to the HES3 state.

Transition HES5:HEL5: When the device successfully processes a SET MAX FREEZE LOCK command, the device shall transition to the HEL5 state.

Transition HES5a:HES5: When the device successfully processes a SET MAX ADDRESS or SET MAX UNLOCK command, the device shall return command aborted and remain in the same state.

Transition HES5b:HES5: When the device successfully processes a hardware reset, the device shall remain in the same state.

Transition HES5c:HES5: When the device successfully processes a SET MAX ADDRESS EXT (Non-Volatile) command, the device shall return command aborted and remain in the same state.

Transition HES5d:HES5: When the device successfully processes a SET MAX SET PASSWORD command, the device shall remain in the same state.

Transition HES5e:HES5: When the device successfully processes a SET MAX ADDRESS EXT (Volatile) command, the device shall remain in the same state.

State HES6: HPA SET (Non-Volatile 2)/Password Set: In this state the non-volatile 48-bit HPA is established and the password is set.

Transition HES6:HES5: When the device successfully processes a SET MAX ADDRESS EXT (Non-Volatile) command, the device shall transition to the HES5 state.

Transition HES6:H1: When the device successfully processes a SET MAX ADDRESS EXT (Non-Volatile, Native Max) command, the device shall transition to the H1 state.

Transition HES6:HEL3: When the device successfully processes a SET MAX LOCK command, the device shall transition to the HEL3 state.

Transition HES6:HES3: When the device successfully processes a power-on reset, the device shall transition to the HES3 state.

Transition HES6:HEL6: When the device successfully processes a SET MAX FREEZE LOCK command, the device shall transition to the HEL6 state.

Transition HES6a:HES6: When the device successfully processes a SET MAX ADDRESS or SET MAX UNLOCK command, the device shall return command aborted and remain in the same state.

Transition HES6b:HES6: When the device successfully processes a hardware reset, the device shall remain in the same state.

Transition HES6c:HES6: When the device successfully processes a SET MAX SET PASSWORD command, the device shall remain in the same state.

Transition HES6d:HES6: When the device successfully processes a SET MAX ADDRESS EXT (Volatile) command, the device shall remain in the same state.

4.11.6.5 28-Bit HPA Locked

State HL1: HPA LOCKED (Volatile): In this state the volatile 28-bit HPA is established, and the device is locked from HPA commands, except the SET MAX UNLOCK command, with a proper password or the SET MAX FREEZE LOCK command.

Transition HL1:H0: When the device successfully processes a power-on reset, the device shall transition to the H0 state.

Transition HL1:HL4: When the device successfully processes a SET MAX FREEZE LOCK command, the device shall transition to the HL4 state.

Transition HL1:HS4: When the device successfully processes a SET MAX UNLOCK (correct password) command, and the HPA Security Extensions unlock counter is non-zero, the device shall transition to the HS4 state.

Transition HL1:H2: When the device successfully processes a hardware reset, the device shall transition to the H2 state.

Transition HL1a:HL1: When the device successfully processes a SET MAX ADDRESS EXT, SET MAX ADDRESS, SET MAX UNLOCK (wrong password) or SET MAX SET PASSWORD command, the device shall return command aborted and remain in the same state.

Transition HL1b:HL1: When the device successfully processes a SET MAX UNLOCK (correct password) and the HPA Security Extensions unlock counter is zero, the device shall return command aborted and remain in the same state.

Transition HL1c:HL1: If the device successfully processes a SET MAX LOCK command, the device shall remain in the same state and the device may return command aborted.

State HL2: HPA LOCKED (Non-volatile 1): In this state the non-volatile 28-bit HPA is established, and the device is locked from HPA commands except the SET MAX UNLOCK command with a proper password or the SET MAX FREEZE LOCK command.

Transition HL2:HL5: When the device successfully processes a SET MAX FREEZE LOCK command, the device shall transition to the HL5 state.

Transition HL2:HS3: When the device successfully processes a power-on reset, the device shall transition to the HS3 state.

Transition HL2:HS5: When the device successfully processes a SET MAX UNLOCK (correct password) command and the HPA Security Extensions unlock counter is non-zero, the device shall transition to the HS5 state.

Transition HL2a:HL2: When the device successfully processes a SET MAX ADDRESS EXT, SET MAX ADDRESS, SET MAX UNLOCK (wrong password) or SET MAX SET PASSWORD command, the device shall return command aborted and remain in the same state.

Transition HL2b:HL2: When the device successfully processes a hardware reset, the device shall remain in the same state.

Transition HL2c:HL2: When the device successfully processes a SET MAX UNLOCK (correct password) command and the HPA Security Extensions unlock counter is zero, the device shall return command aborted and remain in the same state..

Transition HL2d:HL2: If the device successfully processes a SET MAX LOCK command, the device shall remain in the same state and the device may return command aborted.

State HL3: HPA LOCKED (Non-volatile 2): In this state a non-volatile 28-bit HPA is established, and the device is locked from HPA commands except the SET MAX UNLOCK command with a proper password or the SET MAX FREEZE LOCK command.

Transition HL3:HL6: When the device successfully processes a SET MAX FREEZE LOCK command, the device shall transition to the HL6 state.

Transition HL3:HS3: When the device successfully processes a power-on reset, the device shall transition to the HS3 state.

Transition HL3:HS6: When the device successfully processes a SET MAX UNLOCK command without error with the correct password and the HPA Security Extensions unlock counter is non-zero, the device shall transition to the HS6 state.

Transition HL3a:HL3: When the device successfully processes a SET MAX ADDRESS EXT, SET MAX ADDRESS, SET MAX UNLOCK (wrong password) or SET MAX SET PASSWORD command, the device shall return command aborted and remain in the same state. If a SET MAX UNLOCK (wrong password) is successfully processed the HPA Security Extensions unlock counter shall be decremented by 1.

Transition HL3b:HL3: When the device successfully processes a hardware reset, the device shall remain in the same state.

Transition HL3c:HL3: When the device successfully processes a SET MAX UNLOCK (correct password) command and the HPA Security Extensions unlock counter is zero, the device shall return command aborted and remain in the same state.

Transition HL3d:HL3: If the device successfully processes a SET MAX LOCK command, the device shall remain in the same state and the device may return command aborted.

State HL4: HPA FROZEN (Volatile): In this state a volatile 28-bit HPA is established and the device is locked from all HPA commands.

Transition HL4:H0: When the device successfully processes a power-on reset, the device shall transition to the H0 state.

Transition HL4a:HL4: When the device successfully processes a SET MAX ADDRESS EXT, SET MAX ADDRESS, SET MAX LOCK, SET MAX UNLOCK, SET MAX FREEZE LOCK or SET MAX SET PASSWORD command, the device shall return command aborted and remain in the same state.

Transition HL4b:HL4: When the device processes a hardware reset, the device shall remain in the same state.

State HL5: HPA FROZEN (Non-Volatile 1): In this state the non-volatile 28-bit HPA is established and the device is locked from all HPA commands.

Transition HL5a:HL5: When the device successfully processes a SET MAX ADDRESS EXT, SET MAX ADDRESS, SET MAX LOCK, SET MAX UNLOCK, SET MAX FREEZE LOCK or SET MAX SET PASSWORD command, the device shall return command aborted and remain in the same state.

Transition HL5b:HL5: When the device successfully processes a hardware reset, the device shall remain in the same state.

Transition HL5:HS3: When the device successfully processes a power-on reset, the device shall transition to the HS3 state.

State HL6: HPA FROZEN (Non-Volatile 2): In this state the non-volatile 28-bit HPA is established and the device is locked from all HPA commands.

Transition HL6:HS3: When the device successfully processes a power-on reset, the device shall transition to the HS3 state.

Transition HL6a:HL6: When the device successfully processes a SET MAX ADDRESS EXT, SET MAX ADDRESS, SET MAX LOCK, SET MAX UNLOCK, SET MAX FREEZE LOCK or SET MAX SET PASSWORD command, the device shall return command aborted and remain in the same state.

Transition HL6b:HL6: When the device successfully processes a hardware reset, the device shall remain in the same state.

4.11.6.6 48-Bit HPA Locked

State HEL1: HPA LOCKED (Volatile): In this state a volatile 48-bit HPA is established, and the device is locked from HPA commands, except the SET MAX UNLOCK command, with a proper password or the SET MAX FREEZE LOCK command.

Transition HEL1:H0: When the device processes a power-on reset, the device shall transition to the H0 state.

Transition HEL1:H2: When the device successfully processes a hardware reset, the device shall transition to the H2 state.

Transition HEL1:HEL4: When the device successfully processes a SET MAX FREEZE LOCK command, the device shall transition to the HEL4 state.

Transition HEL1:HES4: When the device successfully processes a SET MAX UNLOCK (correct password) command and the HPA Security Extensions unlock counter is non-zero; the device shall transition to the HES4 state.

Transition HEL1a:HEL1: When the device successfully processes a SET MAX ADDRESS, SET MAX ADDRESS EXT, SET MAX UNLOCK (wrong password) or SET MAX SET PASSWORD command, the device shall return command aborted and remain in the same state.

Transition HEL1b:HEL1: When the device successfully processes a SET MAX UNLOCK (correct password) and the HPA Security Extensions unlock counter is zero, the device shall return command aborted and remain in the same state.

Transition HEL1c:HEL1: If the device successfully processes a SET MAX LOCK command, the device shall remain in the same state and the device may return command aborted.

State HEL2: HPA LOCKED (Non-volatile 1): In this state a non-volatile 48-bit HPA is established, and the device is locked from HPA commands, except the SET MAX UNLOCK command, with a proper password or the SET MAX FREEZE LOCK command.

Transition HES5:HEL2: When the device successfully processes a SET MAX LOCK command, the device shall transition to the HEL2 state.

Transition HEL2:HEL5: When the device successfully processes a SET MAX FREEZE LOCK command, the device shall transition to the HEL5 state.

Transition HEL2:HES3: When the device successfully processes a power-on reset, the device shall transition to the HES3 state.

Transition HEL2:HES5: When the device successfully processes a SET MAX UNLOCK (correct password) command and the HPA Security Extensions unlock counter is non-zero, the device shall transition to the HES5 state.

Transition HEL2a:HEL2: When the device successfully processes a SET MAX ADDRESS, SET MAX ADDRESS EXT, SET MAX UNLOCK (wrong password) or SET MAX SET PASSWORD command, the device shall return command aborted and remain in the same state.

Transition HEL2b:HEL2: When the device successfully processes a hardware reset, the device shall transition to the HEL2 state.

Transition HEL2c:HEL2: When the device successfully processes a SET MAX UNLOCK (correct password) command and the HPA Security Extensions unlock counter is zero, the device shall return command aborted and remain in the same state.

Transition HEL2d:HEL2: If the device successfully processes a SET MAX LOCK command, the device shall remain in the same state and the device may return command aborted.

State HEL3: HPA LOCKED (Non-volatile 2): In this state a non-volatile 48-bit HPA is established, and the device is locked from HPA commands, except the SET MAX UNLOCK command, with a proper password or the SET MAX FREEZE LOCK command.

Transition HEL3:HEL6: When the device successfully processes a SET MAX FREEZE LOCK command, the device shall transition to the HEL6 state.

Transition HEL3:HES3: When the device successfully processes a power-on reset, the device shall transition to the HES3 state.

Transition HEL3:HES6: When the device successfully processes a SET MAX UNLOCK command with the correct password and the HPA Security Extensions unlock counter is non-zero, the device shall transition to the HES6 state.

Transition HEL3a:HEL3: When the device successfully processes a SET MAX ADDRESS, SET MAX ADDRESS EXT, SET MAX UNLOCK (wrong password) or SET MAX SET PASSWORD command, the device shall return command aborted and remain in the same state. If a SET MAX UNLOCK (wrong password) is received the HPA Security Extensions unlock counter shall be decremented by 1.

Transition HEL3b:HEL3: When the device successfully processes a Hardware reset, the device shall remain in the same state.

Transition HEL3c:HEL3: When the device successfully processes a SET MAX UNLOCK (correct password) command and the HPA Security Extensions unlock counter is zero, the device shall return command aborted and remain in the same state.

Transition HEL3d:HEL3: If the device successfully processes a SET MAX LOCK command, the device shall remain in the same state and the device may return command aborted.

State HEL4: HPA FROZEN (Volatile): In this state the volatile 48-bit HPA is established and the device is locked from all HPA commands.

Transition HEL4:H0: When the device successfully processes a power-on reset, the device shall transition to the H0 state.

Transition HEL4a:HEL4: When the device successfully processes a SET MAX ADDRESS, SET MAX ADDRESS EXT, SET MAX LOCK, SET MAX UNLOCK, SET MAX FREEZE LOCK or SET MAX SET PASSWORD command, the device shall return command aborted and remain in the same state.

Transition HEL4b:HEL4: When the device successfully processes a hardware reset, the device shall remain in the same state.

HEL5: HPA FROZEN (Non-Volatile 1): In this state the non-volatile 48-bit HPA is established, and the device is locked from all HPA commands.

Transition HEL5a:HEL5: When the device successfully processes a SET MAX ADDRESS, SET MAX ADDRESS EXT, SET MAX LOCK, SET MAX UNLOCK, SET MAX FREEZE LOCK or SET MAX SET PASSWORD command, the device shall return command aborted and remain in the same state.

Transition HEL5b:HEL5: When the device successfully processes a hardware reset, the device shall remain in the same state.

Transition HEL5:HES3: When the device successfully processes a power-on reset, the device shall transition to the HES3 state.

State HEL6: HPA FROZEN (Non-Volatile 2): In this state a non-volatile 48-bit HPA is established, and the device is locked from all HPA commands.

Transition HEL6:HES3: When the device successfully processes a power-on reset, the device shall transition to the HES3 state.

Transition HEL6a:HEL6: When the device successfully processes a SET MAX ADDRESS, SET MAX ADDRESS EXT, SET MAX LOCK, SET MAX UNLOCK, SET MAX FREEZE LOCK or SET MAX SET PASSWORD command, the device shall return command aborted and remain in the same state.

Transition HEL6b:HEL6: When the device successfully processes a hardware reset, the device shall remain in the same state.

4.12 Long Logical Sector (LLS) feature set

The Long Logical Sector (LLS) feature set provides a method for a device to indicate that it has more than 256 words per logical sector. Sectors with 520 or 528 bytes are typical. Devices with logical sectors longer than 256 words shall set IDENTIFY DEVICE data word 106 bit 12 to 1. The logical sector size is described by IDENTIFY DEVICE data words 117-118.

Table 6 describes the command behavior of ATA devices that have been manufactured with the LLS feature set. Data transfer commands transfer either the long logical sector length or 256 words depending on the command (e.g., READ DMA EXT and WRITE DMA EXT commands transfer data in long logical sectors while READ LOG EXT and WRITE LOG EXT commands transfer 256 word blocks of data, regardless of the logical sector length). Figure 10 example 2 shows a diagram of a device formatted with long logical sectors.

The Long Physical Sector (LPS) feature set (see 4.13) and the LLS feature set are not mutually exclusive. Figure 10 example 4 illustrates a device implementing both the LPS and LLS feature sets.

Table 6 — Block Size By Command (part 1 of 2)

Command	Words Transferred per Block
ADD LBA(S) TO NV CACHE PINNED SET	256
CFA TRANSLATE SECTOR	IDENTIFY DEVICE data words (118:117)
CFA WRITE MULTIPLE WITHOUT ERASE	IDENTIFY DEVICE data words (118:117)
CFA WRITE SECTORS WITHOUT ERASE	IDENTIFY DEVICE data words (118:117)
DEVICE CONFIGURATION IDENTIFY	256
DEVICE CONFIGURATION SET	256
DOWNLOAD MICROCODE	256
IDENTIFY DEVICE	256
IDENTIFY PACKET DEVICE	256
QUERY NV CACHE MISSES	256
QUERY NV CACHE PINNED SET	256
REMOVE LBA(S) FROM NV CACHE PINNED SET	256
READ BUFFER	256
READ DMA	IDENTIFY DEVICE data words (118:117)
READ DMA EXT	IDENTIFY DEVICE data words (118:117)
READ DMA QUEUED	IDENTIFY DEVICE data words (118:117)
READ DMA QUEUED EXT	IDENTIFY DEVICE data words (118:117)
READ FPDMA QUEUED	IDENTIFY DEVICE data words (118:117)
READ LOG EXT	256
READ LOG DMA EXT	256
READ MULTIPLE	IDENTIFY DEVICE data words (118:117)
READ MULTIPLE EXT	IDENTIFY DEVICE data words (118:117)

Table 6 — Block Size By Command (part 2 of 2)

Command	Words Transferred per Block
READ SECTOR(S)	IDENTIFY DEVICE data words (118:117)
READ SECTOR(S) EXT	IDENTIFY DEVICE data words (118:117)
READ STREAM DMA EXT	IDENTIFY DEVICE data words (118:117)
READ STREAM EXT	IDENTIFY DEVICE data words (118:117)
READ VERIFY SECTOR(S)	IDENTIFY DEVICE data words (118:117)
SECURITY DISABLE PASSWORD	256
SECURITY ERASE UNIT	256
SECURITY SET PASSWORD	256
SECURITY UNLOCK	256
SET MAX SET PASSWORD	256
SET MAX UNLOCK	256
SMART READ DATA	256
SMART READ LOG	256
SMART WRITE LOG	256
TRUSTED RECEIVE	256
TRUSTED RECEIVE DMA	256
TRUSTED SEND	256
TRUSTED SEND DMA	256
WRITE BUFFER	256
WRITE DMA	IDENTIFY DEVICE data words (118:117)
WRITE DMA EXT	IDENTIFY DEVICE data words (118:117)
WRITE DMA FUA EXT	IDENTIFY DEVICE data words (118:117)
WRITE DMA QUEUED	IDENTIFY DEVICE data words (118:117)
WRITE DMA QUEUED EXT	IDENTIFY DEVICE data words (118:117)
WRITE DMA QUEUED FUA EXT	IDENTIFY DEVICE data words (118:117)
WRITE FPDMA QUEUED	IDENTIFY DEVICE data words (118:117)
WRITE LOG EXT	256
WRITE LOG DMA EXT	256
WRITE MULTIPLE	IDENTIFY DEVICE data words (118:117)
WRITE MULTIPLE EXT	IDENTIFY DEVICE data words (118:117)
WRITE MULTIPLE FUA EXT	IDENTIFY DEVICE data words (118:117)
WRITE SECTOR(S)	IDENTIFY DEVICE data words (118:117)
WRITE SECTOR(S) EXT	IDENTIFY DEVICE data words (118:117)
WRITE STREAM DMA EXT	IDENTIFY DEVICE data words (118:117)
WRITE STREAM EXT	IDENTIFY DEVICE data words (118:117)

4.13 Long Physical Sector (LPS) feature set

The Long Physical Sector (LPS) feature set allows a device to indicate that there are multiple logical sectors per physical sector. See figure 10.

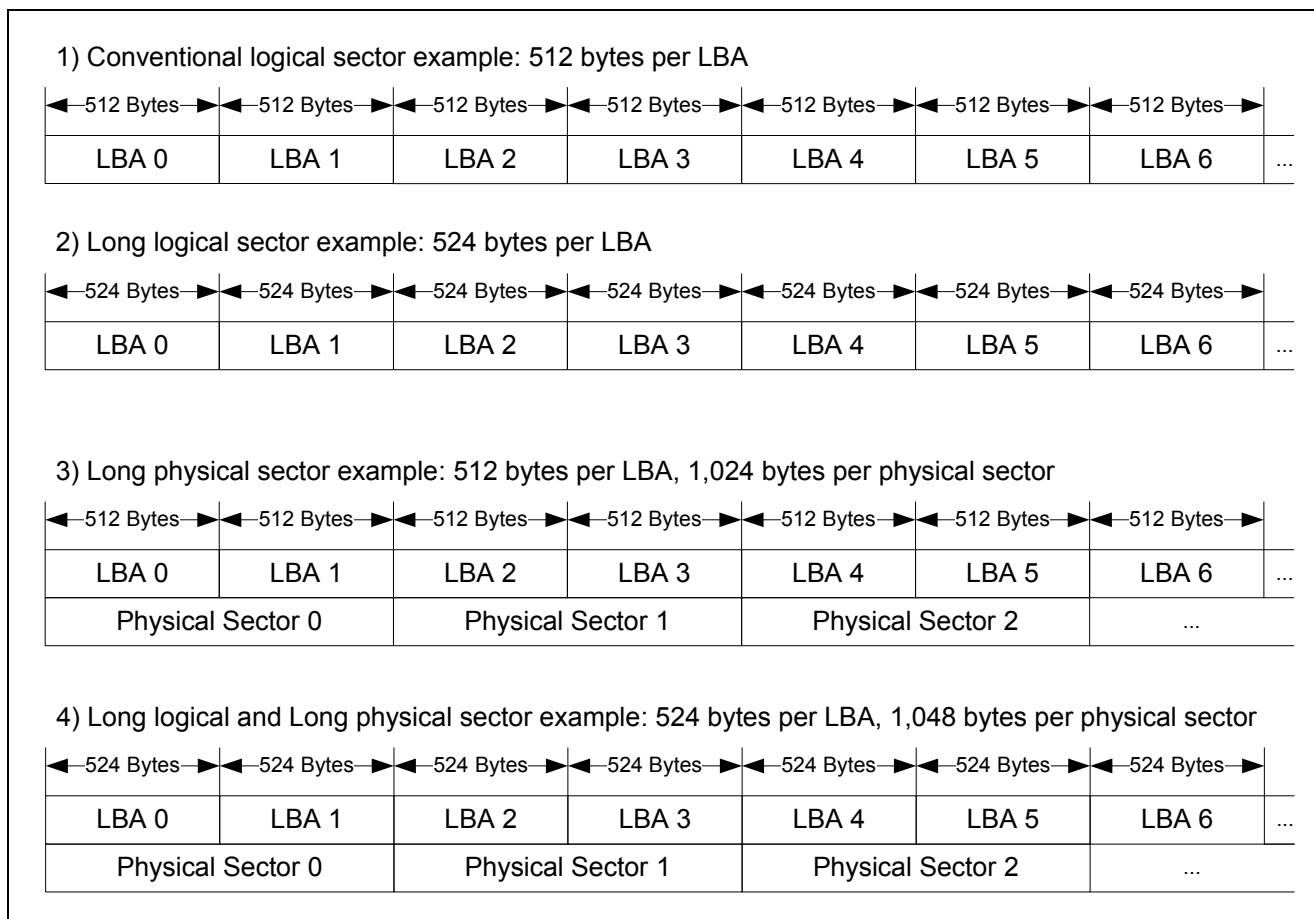

Figure 10 — LLS and LPS Example

If the device reports a LPS and a smaller logical sector, the device may report the alignment of the first logical sector (LBA 0) within the first physical sector. Example 1, 2, and 3 give examples of logical/physical sector alignments.

Example 1:

In Figure 11 there are 2 logical sectors within one physical sector, and the first logical sector is in the first half. The offset is: 0, and the value in IDENTIFY DEVICE data word 209 is 4000h.

physical sector 0		physical sector 1	
logical sector 0	logical sector 1	logical sector 2	logical sector 3

Figure 11 — Alignment 0

Example 2:

In Figure 12 there are 2 logical sectors within one physical sector, and the first logical sector is in the second half. The offset is: 1, and the value in word 209 is 4001h.

physical sector 0		physical sector 1	
(inaccessible)	logical sector 0	logical sector 1	logical sector 2

Figure 12 — Alignment 1

Example 3:

In Figure 13 there are 4 logical sectors within one physical sector, and the first logical sector is in the second half. The offset is: 3, and the value in word 209 is 4003h.

physical sector 0				physical sector 1			
(inaccessible)	(inaccessible)	(inaccessible)	logical 0	logical 1	logical 2	logical 3	logical 4

Figure 13 — Alignment 3

4.14 Media Card Pass Through Command feature set

The Media Card Pass Through commands are implemented by a Media Pass Through device. A device implementing the Media Card Pass Through Command feature set is a bridge to one or more types of media card storage devices. The bridge device responds to the same command set as described in 4.2 and to the commands included in this feature set.

The Media Card Pass Through Command feature set uses the command codes D1h, D2h, D3h, and D4h and bits in IDENTIFY DEVICE data word 84 and IDENTIFY DEVICE data word 87. The command codes D2h through D4h are reserved for the Media Card Pass Through Command feature set if this feature set is enabled by the CHECK MEDIA CARD TYPE command. This feature set embeds small-format flash memory card commands inside the ATA commands. The host adapter's firmware passes the embedded memory card's command to the memory card unmodified from the ATA command. The Media Card Pass Through Command feature set reduces the number of commands required for this feature set regardless of the number or type of memory card commands.

The commands unique to the Media Card Pass Through Command feature set are:

- a) CHECK MEDIA CARD TYPE
- b) Command codes D2h through D4h

The CHECK MEDIA CARD TYPE command returns the supporting status of the device to this feature set. The CHECK MEDIA CARD TYPE command also enables and disables the device from running the Media Card Pass Through Command feature set. A device shall disable the Media Card Pass Through Command feature set during the processing of a power-on reset, a hardware reset, or a software reset.

The definitions of the commands D2h-D4h are media card type dependent. Table 7 lists the Media card types and their associated reference document.

Table 7 — Media Card type references

Media Card Type	Reference Document
SD Card	SD Card ATA Command Extension (SDA 3C)

4.15 Native Command Queuing (NCQ) feature set

4.15.1 Overview

The optional NCQ feature set provides support for devices that implement the Serial Transport (see ATA8-AST). The NCQ feature set allows commands within this feature set to be accepted even though the device has not reported command completion for one or more previously accepted commands in the NCQ feature set. A device reports command completion for commands in the NCQ feature set by returning a transport dependent indicator (see ATA8-AST). The following commands are mandatory for devices implementing the NCQ feature set:

- a) READ FPDMA QUEUED
- b) WRITE FPDMA QUEUED

Devices that report support for the NCQ feature set shall also report support for the GPL feature set (see 4.10), the General Purpose Log Directory log and the NCQ Command Error log.

If the device receives a command that is not an NCQ command while NCQ commands are in the queue, then the device shall return command aborted for the new command and for all of the NCQ commands that are in the queue.

All the commands in the NCQ feature set shall include a NCQ Tag. If the value of the NCQ Tag exceeds the value returned in IDENTIFY DEVICE data word 75 (see 7.16.7.31), then the device shall return command aborted for the new command and for all NCQ commands that are in the queue. If the device receives an NCQ command with a NCQ Tag value that is identical to the NCQ Tag value for another NCQ command in the queue, then the device shall return command aborted for the new command and for all the NCQ commands that are in the queue.

NOTE 3 — The NCQ Tag identifies return information (i.e., error status, data transfer and command completion).

If an error occurs while the device is processing an NCQ command, then the device shall return command aborted for all NCQ commands that are in the queue and shall return command aborted for any new commands, except a READ LOG EXT command requesting log address 10h, until the device completes a READ LOG EXT command requesting log address 10h (i.e., reading the NCQ Command Error log) without error.

NOTE 4 — The NCQ feature set uses 48-bit addresses and is intentionally not included in the 48-bit address feature set.

4.15.2 Command Phases

4.15.2.1 Command Acceptance

The device receives a command in the NCQ feature set and returns command acceptance. Once the device reports command acceptance, it may then accept additional commands in the NCQ feature set.

4.15.2.2 Data transmission

Data transfer should occur after acceptance of the command.

4.15.2.3 Command completion

When the transfer of all of the data requested by one or more NCQ commands occurred without error, the device returns a transport dependent indicator (see ATA8-AST) that informs the host of completion for one or more NCQ commands.

If an error occurs while processing an NCQ command, then the device shall return command aborted for the command in error and for all other NCQ commands that are in the queue. The condition of the data for any NCQ command for which a device reports command aborted is indeterminate.

4.16 NV Cache feature set

4.16.1 Overview

The NV Cache is managed as two distinct areas, the NV Cache Pinned Set and the NV Cache Unpinned Set. Each LBA stored in the NV Cache Set has an attribute called the pinned attribute that determines if the device may remove the sector from the NV Cache. The pinned attribute also indicates whether the LBA belongs to the NV Cache Pinned Set or the NV Cache Unpinned Set.

The host manages the NV Cache Pinned Set, that is the set of logical blocks that the host requires the device to keep in the NV Cache. The remaining NV Cache Set is the NV Cache Unpinned Set.

4.16.2 Pinning

4.16.2.1 Overview

Adding or Removing an LBA from the NV Cache Pinned Set is accomplished by setting or clearing the pinned attribute on a mapped sector. If a device's NV Cache Unpinned Set is too full to satisfy an Add request, then the device shall remove some or all of the NV Cache Unpinned Set in order to complete the Add request.

When an LBA is pinned, the sector data that is placed into the NV Cache may come from one of two sources:

- a) the device's media; or
- b) the host in the form of a write.

The source is determined by the Populate Immediately (PI) bit in the ADD LBA(S) TO NV CACHE PINNED SET command. If PI is set to one, then the command is not complete until the disk has transferred all of the logical blocks from the device's media into the NV Cache.

If PI is cleared to zero, then the logical blocks are added to the NV Cache Pinned Set but are marked as containing invalid (i.e., stale) data. No sector data shall be transferred to the NV Cache before the ADD LBA(S) TO NV CACHE PINNED SET command completes.

4.16.2.2 Examples

There are two common scenarios where a host may pin an LBA:

- a) the host may pin an LBA for subsequent read operations; and
- b) the host may pin an LBA that is about to be written.

When the host knows that logical blocks are to be accessed frequently (i.e., for preloading frequent randomly accessed operation system files or preloading boot files in preparation for a system reboot), the host may add the logical blocks to the pinned set with the ADD LBA(S) TO NV CACHE PINNED SET command.

When the host knows that logical blocks are about to be written (e.g., writing of the hibernate file in preparation for system hibernation), the host may add the logical blocks to the pinned set first with the PI bit cleared to zero. This causes the device to store the data in its non-volatile cache.

4.16.3 NV Cache Management

4.16.3.1 Overview

The NV Cache management refers to the use of ATA commands to query or take action on the contents of the NV Cache Pinned Set. It involves transmitting lists of logical blocks that need to be used in an NV Cache management action. Some NV Cache management actions take lists of logical blocks as inputs and some NV Cache management actions give lists of logical blocks as outputs.

4.16.3.2 LBA Range Entry

An individual LBA range is called an LBA Range Entry and is represented by 8 bytes. The LBA is expressed by the LBA Range Entry's first 6 bytes and the Range Length is a zero based number (e.g., 0=0 and 1=1) represented by the remaining 2 bytes. If the 2 byte range length is 0 then the LBA Range Entry is not valid and should be discarded as padding.

The following are two examples:

- a) If logical blocks 11, 12, 13, 14, 15, 16, 17, and 18 were in the NV Cache Pinned Set and logical blocks 10 and 19 were not, then logical blocks 11 through 18 make one LBA Range Entry that has LBA 11 as its first 48 bits and the value of 8 as its next 16 bits (i.e., 0000_0000_000B_0008h).
- b) If only LBA 20 was represented in an LBA Range Entry, then the range value is 1 (i.e., 0000_0000_0014_0001h).

The largest range that may be specified in a LBA Range Entry is 65535. Multiple LBA Range Entries shall be used to specify larger range values.

4.16.3.3 NV Cache Remaining for Pinned logical blocks

The NV Cache may run out of space to hold any more pinned logical block data. The number of the remaining available spaces shall be returned to the host during the completion of NV Cache Commands. This is referred to as Logical Blocks Remaining.

Logical Blocks Remaining is a 6 byte number that always represents the number of logical blocks in the total NV Cache size minus the number of logical blocks in the NV Cache Pinned Set.

4.16.4 Rotating media state after power-on event

If the NV Cache power mode is set in a device, then the device should not spin up its rotating media after a power-on event until the device receives a command that requires media access.

4.17 NV Cache Power Management feature set

4.17.1 Overview

The optional NV Cache Power Management feature set permits a host to modify the behavior of a device in a manner that allows the device to improve response times to read and write commands while reducing the device's power consumption.

Commands unique to the NV Cache Power Management feature set use a single command code and are differentiated from one another by the value placed in the Feature field. A device that implements the NV Cache Power Management feature set shall implement the following commands:

- a) SET NV CACHE POWER MODE
- b) RETURN FROM NV CACHE POWER MODE

When the NV Cache power mode is set, the device implements an aggressive policy to remove power from its rotational media and satisfy all reads and writes from the device's NV Cache. If a device is not capable of satisfying a read or write from its NV Cache it shall service the read or write request through other means.

The only aspect of the NV Cache feature that affects the Power Management feature set (see 4.18) is the NV Cache power mode input. The purpose of the NV Cache power mode input is to enable and disable the aggressive spinning down of the device while it is in the PM0:Active state. However, the Power Management state diagram does not reflect spindle state and the NV Cache power mode does not affect any Power Management state transitions. The effects are as follows:

- a) when the device is powered up, it should satisfy requests from NV Cache regardless of its current NV Cache power mode setting so that BIOSes are not required to be NV Cache sensitive;
- b) when the NV Cache power mode is disabled, and the device is in PM0:Active state (see 4.18), the device shall spin up its rotating media;
- c) When the NV Cache power mode is enabled, and the device is in PM0:Active state, the device shall use its aggressive policy to reduce power to any rotating media; however, the only requirement for this policy is that, when the device is spun up, it remains spun up for at least the amount of time specified in the SET NV CACHE POWER MODE command; and
- d) A Device Configuration Overlay command that disables the NV Cache power mode support in the device causes the NV Cache power mode to be disabled.

4.18 Power Management feature set

4.18.1 Overview

An ATA device shall implement the Power Management feature set. An ATAPI device may implement power management as defined by the PACKET command set implemented by the device. Otherwise, an ATAPI device shall implement the Power Management feature set as defined in this standard.

The Power Management feature set permits a host to modify the behavior of a device in a manner that reduces the power required to operate. The Power Management feature set provides a set of commands and a timer that enable a device to implement low power consumption modes. An ATA device that implements the Power Management feature set shall implement the following minimum set of functions (see also 4.5 and 4.19):

- a) A Standby timer
- b) CHECK POWER MODE command
- c) IDLE command
- d) IDLE IMMEDIATE command
- e) SLEEP command
- f) STANDBY command
- g) STANDBY IMMEDIATE command

An ATAPI device that implements the Power Management feature set shall implement the following minimum set of functions:

- a) CHECK POWER MODE command
- b) IDLE IMMEDIATE command
- c) SLEEP command

d) STANDBY IMMEDIATE command

4.18.2 Power management commands

The CHECK POWER MODE command allows a host to determine if a device is in, going to or leaving Standby or Idle mode. The CHECK POWER MODE command shall not change the power mode or affect the operation of the Standby timer.

The IDLE and IDLE IMMEDIATE commands move a device to Idle mode immediately from the Active or Standby modes. The IDLE command also sets the Standby timer count and enables or disables the Standby timer.

The STANDBY and STANDBY IMMEDIATE commands move a device to Standby mode immediately from the Active or Idle modes. The STANDBY command also sets the Standby timer count and enables or disables the Standby timer.

The SLEEP command moves a device to Sleep mode. The device's interface becomes inactive after the device reports command completion for the SLEEP command. A device only transitions from Sleep mode after processing a hardware reset, a software reset, or a DEVICE RESET command.

4.18.3 Standby timer

The Standby timer provides a method for the device to enter Standby mode from either Active or Idle mode following a host programmed period of inactivity. If the Standby timer is enabled, and the device is in the Active mode or the Idle mode, then the device waits for the specified time period and, if no command is received, the device enters the Standby mode.

If the Standby timer is disabled, the device may automatically enter Standby mode.

See 7.20.11 for interactions with the NV Cache feature set.

4.18.4 Power modes

Figure 14 shows the set of state transitions that shall be implemented.

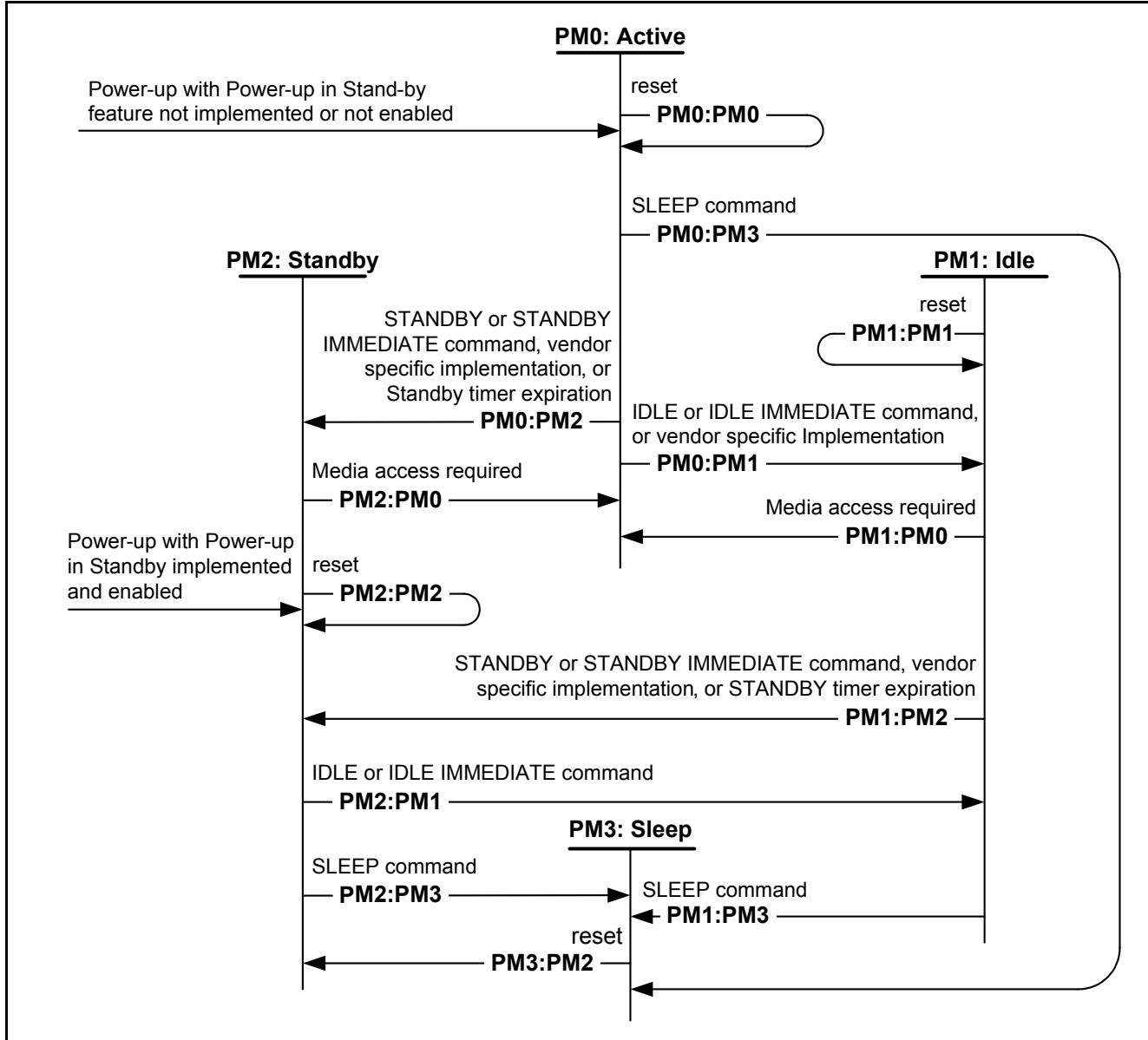

Figure 14 — Power management state diagram

PM0: Active: This state shall be entered when the device receives a media access command while in Idle or Standby mode. This state shall also be entered when the device is powered-up with the Power-Up In Standby feature not implemented or not enabled (see 4.19).

In Active mode the device is capable of responding to commands. During the execution of a media access command a device shall be in the Active state. Power consumption is greatest in this state.

Transition PM0:PM0: The device shall transition to the PM0:Active state after processing a hardware reset, software reset, or DEVICE RESET command.

Transition PM0:PM1: If an IDLE or IDLE IMMEDIATE command is received or a vendor specific implementation determines a transition is required, then the device shall transition to the PM1:Idle state.

Transition PM0:PM2: If a STANDBY or STANDBY IMMEDIATE command is received, then the Standby timer expires, or a vendor specific implementation determines a transition is required, then the device shall transition to the PM2:Standby state.

Transition PM0:PM3: If a SLEEP command is received, then the device shall transition to the PM3:Sleep state.

PM1: Idle: This state shall be entered when the device receives an IDLE or IDLE IMMEDIATE command. Some devices may perform vendor specific internal power management and transition to the Idle mode without host intervention.

In Idle mode the device is capable of responding to commands but the device may take longer to complete commands than when in the Active mode. Power consumption may be reduced from that of Active mode.

Transition PM1:PM0: If a media access is required, then the device shall transition to the PM0:Active state.

Transition PM1:PM1: The device shall transition to the PM1:Idle state after processing a hardware reset, software reset, or DEVICE RESET command.

Transition PM1:PM2: If a STANDBY or STANDBY IMMEDIATE command is received, then the Standby timer expires, or a vendor specific implementation determines a transition is required, then the device shall transition to the PM2:Standby state.

Transition PM1:PM3: If a SLEEP command is received, then the device shall transition to the PM3:Sleep state.

PM2: Standby: This state shall be entered when:

- a) the device successfully processes a STANDBY command;
- b) the device successfully processes a STANDBY IMMEDIATE command;
- c) the Standby timer expires;
- d) the NV Cache power mode timer expires;
- e) a device performs an optional vendor specific internal power management function;
- f) the device is powered-up with the Power-Up In Standby feature implemented and enabled; or
- g) the device successfully processes a hardware reset, a software reset, or a DEVICE RESET command while in PM2:Standby or PM3:Sleep.

In Standby mode the device is capable of responding to commands but the device may take longer to complete commands than in the Idle mode. The time to respond may be as long as 30 seconds. Power consumption may be reduced from that of Idle mode.

Transition PM2:PM0: If a media access is required, then the device shall transition to the PM0:Active state.

Transition PM2:PM1: If an IDLE or IDLE IMMEDIATE command is received, or a vendor specific implementation determines a transition is required, then the device shall transition to the PM1:Idle state.

Transition PM2:PM2: The device shall transition to the PM2:Standby state after processing a hardware reset, software reset, or DEVICE RESET command.

Transition PM2:PM3: If a SLEEP command is received, then the device shall transition to the PM3:Sleep state.

PM3: Sleep: This state shall be entered when the device receives a SLEEP command.

A device transitions from Sleep mode only after processing a hardware reset, a software reset, or a DEVICE RESET command. The time to respond may be as long as 30 s. Sleep state provides the lowest power consumption of any state.

In Sleep state, the device interface behavior is defined in the applicable transport standard.

Transition PM3:PM2: A device shall transition to the PM2:Standby state after processing a hardware reset, software reset, or DEVICE RESET command.

4.19 Power-Up In Standby (PUIS) feature set

The optional Power-Up In Standby (PUIS) feature set allows devices to be powered-up into the Standby power management state to minimize inrush current at power-up and to allow the host to sequence the spin-up of devices. This optional feature set may be enabled or disabled via the SET FEATURES command; may be enabled by use of a jumper or similar means, or both. When enabled by a jumper, this feature set shall not be disabled via the SET FEATURES command. The IDENTIFY DEVICE or IDENTIFY PACKET DEVICE data indicates whether this feature set is implemented and/or enabled.

Once this feature is enabled in a device, the device shall not disable the feature as a result of processing a power-on reset, a hardware reset, or a software reset.

A device may implement a SET FEATURES subcommand (see 7.48.8) that notifies the device to spin-up to the Active state when the device has powered-up into Standby. If the device implements this SET FEATURES subcommand and power-up into Standby is enabled, the device shall remain in Standby until the SET FEATURES subcommand is received. If the device implements this SET FEATURES subcommand, the fact that the feature is implemented is reported in the IDENTIFY DEVICE or IDENTIFY PACKET DEVICE data.

If the device:

- a) implements the Enable/disable Power-up in Standby subcommand;
- b) has the PUIS feature set enabled; and
- c) receives an IDENTIFY DEVICE or IDENTIFY PACKET DEVICE while the device is in the Standby power mode as a result of powering up in that mode,

then the device shall respond to the IDENTIFY DEVICE or IDENTIFY PACKET DEVICE command without spinning up the media. If the device is unable to return a complete response without accessing the media, then the device shall set word 0 bit 2 to one to indicate that the response is incomplete. At a minimum, word 0 and word 2 shall be correctly reported. Those fields that are not provided shall be filled with zeros. Once a device is able to return all data for an IDENTIFY DEVICE command or IDENTIFY PACKET DEVICE command, the device shall return all data for those commands until after processing the next power-on reset.

If the device does not implement the SET FEATURES subcommand to spin-up the device after power-up and PUIS is enabled, the device shall spin-up upon receipt of the first command that requires the device to access the media, except the IDENTIFY DEVICE command or the IDENTIFY PACKET DEVICE command.

4.20 Security feature set

4.20.1 Overview

The optional Security feature set is a password system that restricts access to user data stored on a device. In addition, access to some configuration capabilities are restricted.

See also the Master Password Identifier feature (see 4.20.11) which is an optional enhancement to the Security feature set.

4.20.2 Passwords

4.20.2.1 Overview

The system has two types of passwords: User and Master.

4.20.2.2 User Password

The User password creates a lock to block execution of some commands, including preventing access to all user data on the device. The User password may be used to unlock the device to allow access.

Security is enabled by setting a User password with the SECURITY SET PASSWORD command. When security is enabled, the device is Locked (i.e., access to user data on the device is denied) after a power-on reset is processed until a SECURITY UNLOCK command completes without error.

4.20.2.3 Master Password

The Master password is a password that may be used to unlock the device if the User password is lost or if an administrator requires access (e.g., to repurpose a device).

A factory-installed Master password may be valid before an initial SECURITY SET PASSWORD command has been completed without error. A device may contain both a valid Master and a valid User password. Setting the Master password does not enable Security (i.e., does not Lock the device after the next power-on reset has been processed).

4.20.3 Master Password Capability

A device with Security enabled has two ways of using the Master password. This capability has values of High or Maximum. The capability value is set when the User password is set (see 7.45).

When the Master Password Capability is set to High, either the User or Master password may be used interchangeably.

When the Master Password Capability is set to Maximum, the Master password is not used with the SECURITY DISABLE PASSWORD and SECURITY UNLOCK commands. The SECURITY ERASE UNIT command, however, does accept either a valid User or Master password.

4.20.4 Frozen Mode

The SECURITY FREEZE LOCK command prevents changes to all Security states until a following power-on reset or hardware reset. The purpose of the SECURITY FREEZE LOCK command is to prevent password setting attacks on the security system.

4.20.5 Commands

A device that implements the Security feature set shall implement the following set of commands:

- a) SECURITY SET PASSWORD
- b) SECURITY UNLOCK (requires a password)
- c) SECURITY ERASE PREPARE
- d) SECURITY ERASE UNIT (requires a password)
- e) SECURITY FREEZE LOCK
- f) SECURITY DISABLE PASSWORD (requires a password)

4.20.6 IDENTIFY DEVICE data

Support of the Security feature set is indicated in IDENTIFY DEVICE and IDENTIFY PACKET DEVICE data word 82 and data word 128.

Security information in words 82, 89 and 90 is fixed until the next power-on reset and shall not change unless DEVICE CONFIGURATION OVERLAY removes support for the Security feature set.

Security information in words 85, 92 and 128 are variable and may change.

If the Security feature set is not supported, then words 89, 90, 92 and 128 are N/A.

4.20.7 Security initial setting

When the device is shipped by the manufacturer, Security shall be disabled (e.g., is not Locked). The initial Master password value is not defined by this standard.

4.20.8 Password Rules

This subclause applies to any Security command that accepts a password, and for which there exists a valid password. This subclause does not apply after the drive has processed a SECURITY FREEZE LOCK command without error.

The SECURITY ERASE UNIT command ignores the Master Password Capability value when comparing passwords, and shall accept either a valid Master or User password.

If the User password sent to the device does not match the User password previously set with the SECURITY SET PASSWORD command, then the device shall return command aborted.

If the Master Password Capability was set to High during the last SECURITY SET PASSWORD command setting the User password, then the device shall accept the Master password and complete the command without error.

If the Master Password Capability was set to Maximum during the last SECURITY SET PASSWORD command setting the User password, then the device shall return command aborted for a SECURITY UNLOCK command or a SECURITY DISABLE PASSWORD command if the Master password is supplied.

4.20.9 Password attempt counter

The device shall have a password attempt counter. The purpose of this counter is to defeat repeated trial attacks. The counter shall be decremented while in state SEC4, whenever the SECURITY UNLOCK command fails because of an invalid User or Master password.

When the password attempt counter reaches zero, the device shall:

- a) not decrement the counter;
- b) set the Password Attempt Counter Exceeded bit (i.e., bit 4 of word 128 in the IDENTIFY DEVICE data) to one; and
- c) return command aborted for all SECURITY UNLOCK commands and SECURITY ERASE UNIT commands until after the device processes a power-on or hardware reset.

The Password Attempt Counter Exceeded bit shall be cleared to zero after processing a power-on or a hardware reset.

The password attempt counter shall be set to five after a power-on or hardware reset.

4.20.10 Security states

Figure 15 describes security states and state transitions, table 8 is a summary of the security states, and table 9 describes the effect of security on commands. When the power is off, the Security characteristics are as in table 8, but are not reportable.

Table 8 — Summary of Security States and Characteristics

Security State	Security Characteristics				
	Power	Enabled ^a	Locked ^b	Frozen ^c	Password Attempts Exceeded ^d
SEC0	off	0	N/A	N/A	N/A
SEC1	on	0	0	0	0
SEC2	on	0	0	1	Varies
SEC3	off	1	N/A	N/A	N/A
SEC4	on	1	1	0	Varies
SEC5	on	1	0	0	Varies
SEC6	on	1	0	1	Varies

^a IDENTIFY DEVICE data word 85 bit 1
^b IDENTIFY DEVICE data word 128 bit 2
^c IDENTIFY DEVICE data word 128 bit 3
^d IDENTIFY DEVICE data word 128 bit 4

Table 9 — Security Command Actions (part 1 of 4)

Command	Locked ^a	Unlocked or Disabled ^b	Frozen ^c
ADD LBA(S) TO NV CACHE PINNED SET	Command aborted	Executable	Executable
CFA ERASE SECTORS	Command aborted	Executable	Executable
CFA REQUEST EXTENDED ERROR CODE	Executable	Executable	Executable
CFA TRANSLATE SECTOR	Executable	Executable	Executable
CFA WRITE MULTIPLE WITHOUT ERASE	Command aborted	Executable	Executable
CFA WRITE SECTORS WITHOUT ERASE	Command aborted	Executable	Executable
CHECK MEDIA CARD TYPE	Command aborted	Executable	Executable
CHECK POWER MODE	Executable	Executable	Executable
CONFIGURE STREAM	Command aborted	Executable	Executable
DEVICE CONFIGURATION	Command aborted	Executable	Executable
DEVICE RESET	Executable	Executable	Executable
DOWNLOAD MICROCODE	Vendor Specific	Vendor Specific	Vendor Specific
EXECUTE DEVICE DIAGNOSTIC	Executable	Executable	Executable
FLUSH CACHE	Command aborted	Executable	Executable
FLUSH CACHE EXT	Command aborted	Executable	Executable
FLUSH NV CACHE	Command aborted	Executable	Executable
GET MEDIA STATUS	Command aborted	Executable	Executable
IDENTIFY DEVICE	Executable	Executable	Executable
IDENTIFY PACKET DEVICE	Executable	Executable	Executable
IDLE	Executable	Executable	Executable
IDLE IMMEDIATE	Executable	Executable	Executable
MEDIA EJECT	Command aborted	Executable	Executable
MEDIA LOCK	Command aborted	Executable	Executable
MEDIA UNLOCK	Command aborted	Executable	Executable
NOP	Executable	Executable	Executable
PACKET	Command aborted	Executable	Executable
QUERY NV CACHE MISSES	Command aborted	Executable	Executable
QUERY NV CACHE PINNED SET	Command aborted	Executable	Executable
READ BUFFER	Executable	Executable	Executable
READ DMA	Command aborted	Executable	Executable
READ DMA EXT	Command aborted	Executable	Executable
READ FPDMA QUEUED	Command aborted	Executable	Executable
READ DMA QUEUED	Command aborted	Executable	Executable
<p>^a State SEC4 ^b States SEC1 or SEC5 ^c States SEC2 or SEC6 Note 1 - all commands not listed in this table are not addressed by the Security feature set.</p>			

Table 9 — Security Command Actions (part 2 of 4)

Command	Locked ^a	Unlocked or Disabled ^b	Frozen ^c
READ DMA QUEUED EXT	Command aborted	Executable	Executable
READ LOG DMA EXT	Executable	Executable	Executable
READ LOG EXT	Executable	Executable	Executable
READ MULTIPLE	Command aborted	Executable	Executable
READ MULTIPLE EXT	Command aborted	Executable	Executable
READ NATIVE MAX ADDRESS	Executable	Executable	Executable
READ NATIVE MAX ADDRESS EXT	Executable	Executable	Executable
READ SECTOR(S)	Command aborted	Executable	Executable
READ SECTOR(S) EXT	Command aborted	Executable	Executable
READ STREAM DMA EXT	Command aborted	Executable	Executable
READ STREAM EXT	Command aborted	Executable	Executable
READ VERIFY SECTOR(S)	Command aborted	Executable	Executable
READ VERIFY SECTOR(S) EXT	Command aborted	Executable	Executable
REMOVE LBA(S) FROM NV CACHE PINNED SET	Command aborted	Executable	Executable
RETURN FROM NV CACHE POWER MODE	Command aborted	Executable	Executable
SCT READ/WRITE LONG	Command aborted	Executable	Executable
SCT WRITE SAME	Command aborted	Executable	Executable
SCT ERROR RECOVERY CONTROL	Command aborted	Executable	Executable
SCT FEATURE CONTROL	Command aborted	Executable	Executable
SCT DATA TABLES	Command aborted	Executable	Executable
SCT READ STATUS	Executable	Executable	Executable
SECURITY DISABLE PASSWORD	Command aborted	Executable	Command aborted
SECURITY ERASE PREPARE	Executable	Executable	Command aborted
SECURITY ERASE UNIT	Executable	Executable	Command aborted
SECURITY FREEZE LOCK	Command aborted	Executable	Executable
SECURITY SET PASSWORD	Command aborted	Executable	Command aborted
SECURITY UNLOCK	Executable	Executable	Command aborted
SERVICE	Command aborted	Executable	Executable
SET FEATURES	Executable	Executable	Executable
SET MAX ADDRESS	Command aborted	Executable	Executable
SET MAX ADDRESS EXT	Command aborted	Executable	Executable
SET MAX SET PASSWORD	Command aborted	Executable	Executable
SET MAX LOCK	Command aborted	Executable	Executable
SET MAX FREEZE LOCK	Command aborted	Executable	Executable

^a State SEC4

^b States SEC1 or SEC5

^c States SEC2 or SEC6

Note 1 - all commands not listed in this table are not addressed by the Security feature set.

Table 9 — Security Command Actions (part 3 of 4)

Command	Locked ^a	Unlocked or Disabled ^b	Frozen ^c
SET MAX UNLOCK	Command aborted	Executable	Executable
SET MULTIPLE MODE	Executable	Executable	Executable
SET NV CACHE POWER MODE	Command aborted	Executable	Executable
SLEEP	Executable	Executable	Executable
SMART DISABLE OPERATIONS	Executable	Executable	Executable
SMART ENABLE/DISABLE AUTOSAVE	Executable	Executable	Executable
SMART ENABLE OPERATIONS	Executable	Executable	Executable
SMART EXECUTE OFF-LINE IMMEDIATE	Executable	Executable	Executable
SMART READ DATA	Executable	Executable	Executable
SMART READ LOG	Executable	Executable	Executable
SMART RETURN STATUS	Executable	Executable	Executable
SMART WRITE LOG	Executable	Executable	Executable
STANDBY	Executable	Executable	Executable
STANDBY IMMEDIATE	Executable	Executable	Executable
TRUSTED RECEIVE	Command aborted	Executable	Executable
TRUSTED RECEIVE DMA	Command aborted	Executable	Executable
<p>^a State SEC4 ^b States SEC1 or SEC5 ^c States SEC2 or SEC6 Note 1 - all commands not listed in this table are not addressed by the Security feature set.</p>			

Table 9 — Security Command Actions (part 4 of 4)

Command	Locked ^a	Unlocked or Disabled ^b	Frozen ^c
TRUSTED SEND	Command aborted	Executable	Executable
TRUSTED SEND DMA	Command aborted	Executable	Executable
WRITE BUFFER	Executable	Executable	Executable
WRITE DMA	Command aborted	Executable	Executable
WRITE DMA EXT	Command aborted	Executable	Executable
WRITE DMA FUA EXT	Command aborted	Executable	Executable
WRITE DMA QUEUED	Command aborted	Executable	Executable
WRITE DMA QUEUED EXT	Command aborted	Executable	Executable
WRITE DMA QUEUED FUA EXT	Command aborted	Executable	Executable
WRITE FPDMA QUEUED	Command aborted	Executable	Executable
WRITE LOG DMA EXT	Command aborted	Executable	Executable
WRITE LOG EXT	Command aborted	Executable	Executable
WRITE MULTIPLE	Command aborted	Executable	Executable
WRITE MULTIPLE EXT	Command aborted	Executable	Executable
WRITE MULTIPLE FUA EXT	Command aborted	Executable	Executable
WRITE SECTOR(S)	Command aborted	Executable	Executable
WRITE SECTOR(S) EXT	Command aborted	Executable	Executable
WRITE STREAM DMA EXT	Command aborted	Executable	Executable
WRITE STREAM EXT	Command aborted	Executable	Executable
WRITE UNCORRECTABLE EXT	Command aborted	Executable	Executable

^a State SEC4
^b States SEC1 or SEC5
^c States SEC2 or SEC6
 Note 1 - all commands not listed in this table are not addressed by the Security feature set.

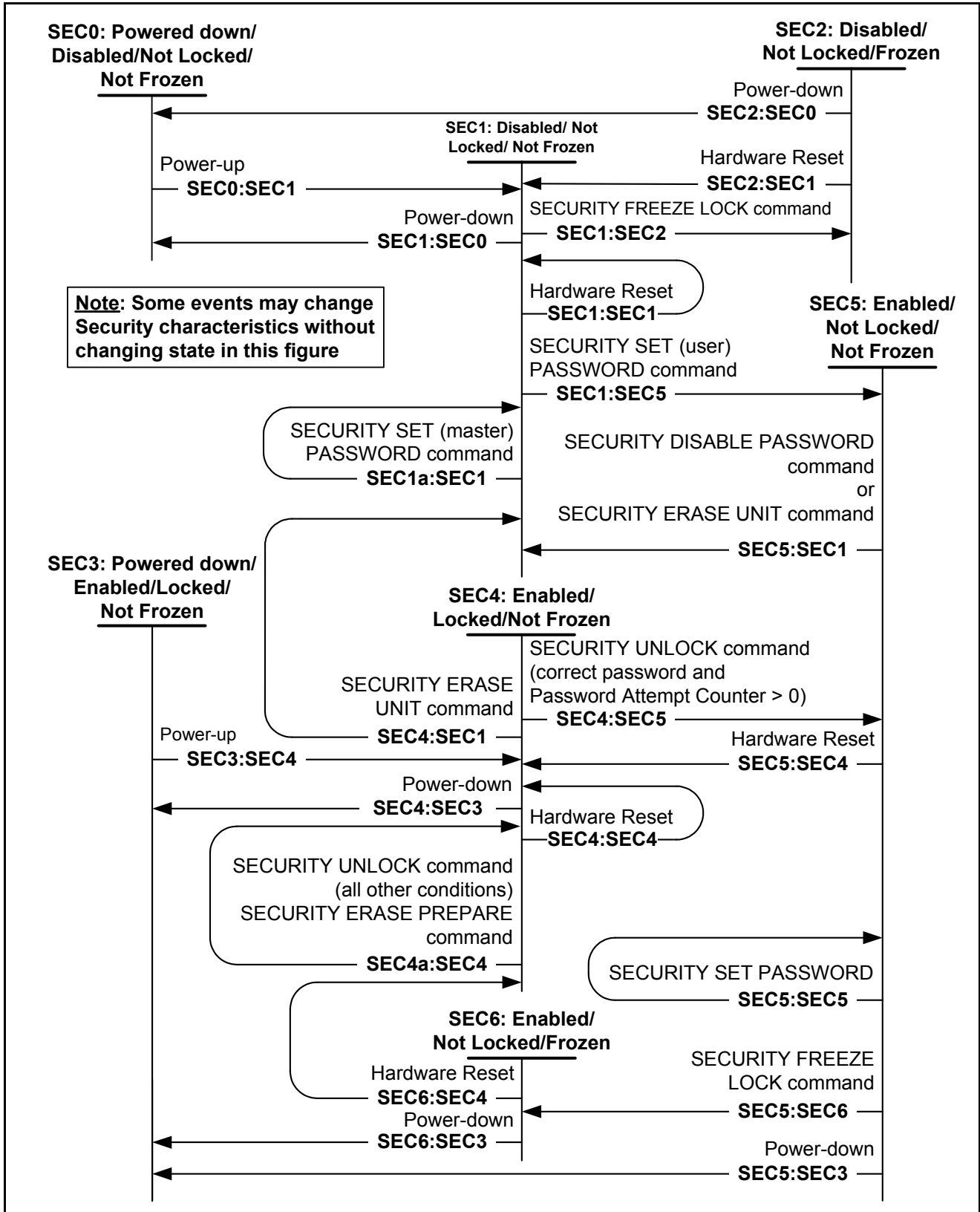

Figure 15 — Security state diagram

State SEC0: Powered down/Security Disabled/Not Locked/ Not Frozen: This state shall be entered when the device is powered-down with the Security feature set disabled.

Transition SEC0:SEC1: When the device is powered-up, the device shall transition to the SEC1 state.

State SEC1: Security Disabled/Not Locked/ Not Frozen: This state shall be entered when the device is powered-up or a hardware reset is received with the Security feature set disabled or when the Security feature set is disabled by a SECURITY DISABLE PASSWORD or SECURITY ERASE UNIT command.

When entering this state after processing a power-on or hardware reset, the device shall set the password attempt counter to a value of 5 and clear the Password Attempt Counter Exceeded flag

In this state, the device shall respond to all commands as specified in the “Disabled” column of table 9. With the exception of the SECURITY commands, execution of these commands shall not cause a transition from state SEC1.

In this state, IDENTIFY DEVICE and IDENTIFY PACKET DEVICE shall report values as described in table 10.

Table 10 — IDENTIFY settings for Security state SEC1

Word	Bit Position	Value	Description
82	1	1	Security feature set is supported
85	1	0	There is no active User password
128	0	copy of word 82 bit 1	Security feature set is supported
128	1	copy of word 85 bit 1	Security feature set is disabled
128	2	0	device is not locked
128	3	0	device is not frozen
128	4	Varies	Password Attempt Counter Exceeded 1= counter exceeded 0= counter not exceeded
128	8	0	Master Password Capability is not maximum

Transition SEC1:SEC0: When the device is powered-down, the device shall transition to the SEC0 state.

Transition SEC1:SEC1: When the device receives a hardware reset, the device shall remain in the same state.

Transition SEC1a:SEC1: When a SECURITY SET (master) PASSWORD command completes without error, the device shall:

- a) save the Master password and the optional Master Password Identifier;
- b) remain in the same state; and
- c) not change the Master Password Capability.

Transition SEC1:SEC2: When a SECURITY FREEZE LOCK command completes without error, the device shall transition to the SEC2 state.

Transition SEC1:SEC5: When a SECURITY SET (user) PASSWORD command completes without error, the device shall:

- a) save the User password;
- b) update the Master Password Capability; and
- c) transition to the SEC5 state.

State SEC2: Security Disabled/ Not Locked/ Frozen: This state shall be entered when the device receives a SECURITY FREEZE LOCK command while in state SEC1.

In this state, the device shall respond to all commands as specified in the “Frozen” column of table 9. Execution of any of these commands shall not cause a transition from state SEC2.

The device shall report IDENTIFY DEVICE or IDENTIFY PACKET DEVICE field values in accordance with table 11.

Table 11 — IDENTIFY settings for Security state SEC2

Word	Bit Position	Value	Description
82	1	1	Security feature set is supported
85	1	0	There is no active User password
128	0	copy of word 82 bit 1	Security feature set is supported
128	1	copy of word 85 bit 1	Security feature set is disabled
128	2	0	device is not locked
128	3	1	device is frozen
128	4	Varies	Password Attempt Counter Exceeded 1= counter exceeded 0= counter not exceeded
128	8	Varies	Master Password Capability 0=high/User password disabled 1=Maximum/User password disabled

Transition SEC2:SEC0: When the device is powered-down, the device shall transition to the SEC0 state.

Transition SEC2:SEC1: When the device receives a hardware reset, the device shall transition to the SEC1 state.

State SEC3: Powered down/Security Enabled/ Locked/ Not Frozen: This state shall be entered when the device is powered-down with the Security feature set enabled.

Transition SEC3:SEC4: When the device is powered-up, the device shall transition to the SEC4 state.

State SEC4: Security Enabled/ Locked/ Not Frozen: This state shall be entered when the device is powered-up or a hardware reset is received with the Security feature set enabled.

In this state, the device shall respond to all commands as specified in the “Locked” column of table 9. With the exception of the SECURITY commands, execution of these commands shall not cause a transition from state SEC4.

When entering this state from power-on or hardware reset, the device shall set the password attempt counter to a value of 5 and clear the Password Attempt Counter Exceeded flag

The device shall report IDENTIFY DEVICE or IDENTIFY PACKET DEVICE field values in accordance with table 12.

Table 12 — IDENTIFY settings for Security state SEC4

Word	Bit Position	Value	Description
82	1	1	Security feature set is supported
85	1	1	There is an active User password
128	0	copy of word 82 bit 1	Security feature set is supported
128	1	copy of word 85 bit 1	Security feature set is enabled
128	2	1	device is locked
128	3	0	device is not frozen
128	4	Varies	Password Attempt Counter Exceeded 1= counter exceeded 0= counter not exceeded
128	8	Varies	Master Password Capability 0=high 1=Maximum

Transition SEC4:SEC1: When a SECURITY ERASE UNIT command completes without error, then the device shall transition to the SEC1 state.

Transition SEC4:SEC3: When the device is powered-down, the device shall transition to the SEC3 state.

Transition SEC4:SEC4: When the device receives a hardware reset, the device shall remain in the same state.

Transition SEC4a:SEC4: When a SECURITY UNLOCK command is received with an incorrect password, the password attempt counter shall be decremented by 1, and remain in the same state.

If the password attempt counter reaches zero, then the Password Attempt Counter Exceeded bit shall be set to one.

After execution of the SECURITY ERASE PREPARE command, the device remains in the same state.

Transition SEC4:SEC5: When a SECURITY UNLOCK command is successful, the device shall transition to the SEC5 state.

State SEC5: Security Enabled/ Not Locked/ Not Frozen: This state shall be entered when either a SECURITY SET (user) PASSWORD command or a SECURITY UNLOCK command completes without error.

In this state, the device shall respond to all commands as specified in the Unlocked column of table 9. With the exception of the SECURITY commands, execution of these commands shall not cause a transition from state SEC5.

The device shall report IDENTIFY DEVICE or IDENTIFY PACKET DEVICE field values in accordance with table 13.

Table 13 — IDENTIFY settings for Security state SEC5

Word	Bit Position	Value	Description
82	1	1	Security feature set is supported
85	1	1	There is an active User password
128	0	copy of word 82 bit 1	Security feature set is supported
128	1	copy of word 85 bit 1	Security feature set is enabled
128	2	0	device is not locked
128	3	0	device is not frozen
128	4	Varies	Password Attempt Counter Exceeded 1= counter exceeded 0= counter not exceeded
128	8	Varies	Master Password Capability 0=high 1=Maximum

Transition SEC5:SEC1: When a SECURITY DISABLE PASSWORD or a SECURITY ERASE UNIT command is successful, the device shall transition to the SEC1 state.

Transition SEC5:SEC3: When the device is powered-down, the device shall transition to the SEC3 state.

Transition SEC5:SEC4: When the device receives a hardware reset, the device shall transition to the SEC4 state.

Transition SEC5:SEC5: When a SECURITY SET (master) PASSWORD command completes without error, the device shall:

- a) save the Master password and the optional Master Password Identifier;
- b) not change the Master Password Capability; and
- c) remain in the same state.

When a SECURITY SET (user) PASSWORD command completes without error, the device shall:

- a) save the User password;
- b) update the Master Password Capability; and
- c) remain in the same state.

When a SECURITY ERASE PREPARE command completes without error, the device shall remain in the same state.

Transition SEC5:SEC6: When a SECURITY FREEZE LOCK command is successful, the device shall transition to the SEC6 state.

State SEC6: Security Enabled/ Not Locked/ Frozen: This state shall be entered when the device receives a SECURITY FREEZE LOCK command while in the SEC5 state.

In this state, the device shall respond to all commands as specified in the “Frozen” column of table 9. With the exception of the SECURITY commands, execution of these commands shall not cause a transition from state SEC6.

The device shall report IDENTIFY DEVICE or IDENTIFY PACKET DEVICE field values in accordance with table 14.

Table 14 — IDENTIFY settings for Security state SEC6

Word	Bit Position	Value	Description
82	1	1	Security feature set is supported
85	1	1	There is an active User password
128	0	copy of word 82 bit 1	Security feature set is supported
128	1	copy of word 85 bit 1	Security feature set is enabled
128	2	0	device is not locked
128	3	1	device is frozen
128	4	Varies	Password Attempt Counter Exceeded 1= counter exceeded 0= counter not exceeded
128	8	Varies	Master Password Capability 0=high 1=Maximum

Transition SEC6:SEC4: When the device receives a hardware reset, the device shall transition to the SEC4 state.

Transition SEC6:SEC3: When the device is powered-down, the device shall transition to the SEC3 state.

4.20.11 Master Password Identifier feature

4.20.11.1 Overview

The Master Password Identifier is an optional feature in the Security feature set.

4.20.11.2 Example use case

The intended purpose of this feature is to assist an administrator that uses several sets of Master passwords (e.g., for use in different deployments of devices). The administrator may maintain a mapping of actual Master passwords and a corresponding Identifier. When an administrator sets a Master password, the corresponding Master Password Identifier may also be set.

When the time comes to redeploy a device for which a User password had been set and lost, the administrator needs to know which Master password is valid for this individual device. Since the device never reveals the Master password but does reveal the Identifier, the administrator may obtain a hint as to which Master password was previously set.

4.20.11.3 Requirements

The device shall maintain a 2-byte value associated with the Master Password that may be specified by the host.

The Master Password Identifier does not indicate whether a Master Password exists or is valid.

Support for this feature is reported in the IDENTIFY DEVICE or IDENTIFY PACKET DEVICE data in word 92. Valid identifiers are 0001h through FFFEh. A value of 0000h or FFFFh indicates that this feature is not supported.

If the device supports the Security feature set, then:

- the device shall store a non-volatile identifier field with the stored Master password;
- the identifier is maintained for the benefit of the host and shall not be modified by the device; and
- prior to first use, the Master Password Identifier shall be set to FFFEh by the manufacturer.

4.21 Self-Monitoring, Analysis, and Reporting Technology (SMART) feature set

4.21.1 Overview

The intent of the Self-Monitoring, Analysis, and Reporting Technology (SMART) feature set is to protect user data and minimize the likelihood of unscheduled system downtime that may be caused by predictable degradation and/or fault of the device. By monitoring and storing critical performance and calibration parameters, SMART feature set devices attempt to predict the likelihood of near-term degradation or fault condition. Providing the host system the knowledge of a negative reliability condition allows the host system to warn the user of the impending risk of a data loss and advise the user of appropriate action. Support of this feature set is indicated in the IDENTIFY DEVICE data.

4.21.2 Device SMART data structure

SMART feature set capability and status information for the device are stored in the device SMART data structure. The off-line data collection capability and status data stored herein may be useful to the host if the SMART EXECUTE OFF-LINE IMMEDIATE command is implemented (see 7.53.5).

4.21.3 Background data collection

Collection of SMART data in the background shall have no impact on device performance. The SMART data that is collected or the methods by which data is collected in this mode may be different than those in the off-line data collection mode for any particular device and may vary from one device to another.

4.21.4 Off-line/Captive mode data collection

If the device is required to respond to commands from the host while performing data collection, then the device shall use the off-line or captive mode for data collection and self-test routines that have an impact on performance. This impact on performance may vary from device to device. The data that is collected or the methods by which the data is collected in this mode may be different than those in the background data collection mode for any particular device and may vary from one device to another.

4.21.5 Threshold exceeded condition

This condition occurs when the device's SMART reliability status indicates an impending degrading or fault condition (see 7.53.8).

4.21.6 SMART feature set commands

These commands use a single command code and are differentiated from one another by the value placed in the Feature field (see 7.53).

If the SMART feature set is implemented, the following commands shall be implemented:

- a) SMART DISABLE OPERATIONS
- b) SMART ENABLE/DISABLE ATTRIBUTE AUTOSAVE
- c) SMART ENABLE OPERATIONS
- d) SMART RETURN STATUS

If the SMART feature set is implemented, the following commands are optional:

- a) SMART EXECUTE OFF-LINE IMMEDIATE
- b) SMART READ DATA
- c) SMART READ LOG
- d) SMART WRITE LOG

4.21.7 SMART operation with power management modes

When the SMART feature set is enabled a device should save the device accumulated SMART data upon receipt of an IDLE IMMEDIATE, STANDBY IMMEDIATE, or SLEEP command or upon return to an Active or Idle state from a Standby state (see 7.53.6).

If a SMART feature set enabled device has been set to use the Standby timer (see 4.18.3), the device should save the device accumulated SMART data prior to going from an Idle mode to the Standby state or upon return to an Active or Idle state from a Standby state.

A device shall not process any routine to save the device accumulated SMART data while the device is in a Standby or Sleep state.

4.21.8 SMART device error log reporting

Logging of reported errors is an optional SMART feature. If error logging is supported by a device, it is indicated in byte 370 of the SMART READ DATA command response and IDENTIFY DEVICE DATA word 84 bit 0. If error logging is supported, the device shall provide information on the last five errors that the device reported as described in the SMART READ LOG command (see 7.53.7). The device may also provide additional vendor specific information on these reported errors.

If error logging is supported, it shall not be disabled when SMART is disabled. Error log information shall be gathered when the device is powered-on except that logging of errors when in a reduced power mode is optional. If errors are logged when in a reduced power mode, the reduced power mode shall not change. Disabling SMART shall disable the delivering of error log information via the SMART READ LOG command.

The SMART error logs are: the Summary Error Log, the Comprehensive Error Log and the Extended Comprehensive Error Log.

4.22 Software Settings Preservation (SSP) feature set

The Software Settings Preservation (SSP) feature set provides a method for an application client to cause a SATA device to retain the settings of some features that are enabled or disabled using a SET FEATURES command after the device has received a COMRESET. If a device supports the SSP feature set, then the feature shall be enabled by default. See SATA 2.6.

The software settings that shall be preserved across COMRESET are listed in table 15. The device is only required to preserve the indicated software setting if it supports the particular feature/command with which the setting is associated.

Table 15 — Preserved Feature Sets and Settings

Capability	Preserved Setting
INITIALIZE DEVICE PARAMETERS	- Obsolete Command -
Security Mode	Preserve the Current Security State as defined in the security state transition diagram (see 4.20.10)
Standby Timer	Preserve the setting for the Standby timer (see 4.18.3)
Read/Write Stream Error Logs	Preserve the contents of these logs (see A.11 and A.16)
Password Attempt Counter	Preserve the value of the Password Attempt Counter (see 4.20.9)
SET MAX ADDRESS (EXT)	Current maximum LBA (see 7.49.2 and 7.50)
Write Cache enable/disable	Enabled or disabled (see 7.48.4)
Transfer Mode	Preserve the PIO, DMA and UDMA transfer mode settings (see 7.48.5)
Advanced Power Mode	Enabled or disabled (see 7.48.6)
Read look-ahead	Enabled or disabled (see 7.48.13)
Release Interrupt	Enabled or disabled (see 7.48.14)
Service Interrupt	Enabled or disabled (see 7.48.15)
Reverting to Power-On Defaults	Enabled or disabled (see 7.48.16)
Multiple Mode	Preserve the block size from the last set multiple mode (see 7.51)

4.23 Streaming feature set

4.23.1 Streaming feature set overview

The Streaming feature set is an optional feature set that allows a host to request delivery of data within an allotted time, placing a priority on the time to transfer the data rather than the integrity of the data. This feature set is defined to satisfy the requirements for AV type applications. While processing commands in the Streaming

feature set, devices may process background tasks if the specified command processing time limits for the commands are met. The Streaming feature set only defines commands that use 48-bit addressing.

Devices that implement the Streaming feature set shall implement the GPL feature set and the following commands:

- a) CONFIGURE STREAM
- b) READ STREAM EXT
- c) WRITE STREAM EXT
- d) READ STREAM DMA EXT
- e) WRITE STREAM DMA EXT

SET FEATURES Set Maximum Host Interface Sector Times (see 7.48.12) is an optional feature of the Streaming feature set.

The AAM setting may impact word 97 in IDENTIFY DEVICE data (see 7.16.7.49).

Support of the Streaming feature set is indicated in IDENTIFY DEVICE data word 84 bit 4.

4.23.2 Streaming commands

4.23.2.1 Streaming command overview

The CONFIGURE STREAM command (see 7.9) is used by a host to define the properties of a stream to assist the device in configuring its caching for best performance. The Stream Identifier (Stream ID) in the CONFIGURE STREAM command is used by the host to specify the number of the stream to which the operating parameters in the command apply. Up to a total of eight streams may be configured. The Stream ID may be used by the device to configure its resources to support the streaming requirements of the AV content.

A host may use both READ STREAM and WRITE STREAM commands to access any stream.

The CONFIGURE STREAM command Default Command Completion Time Limit (Default CCTL) (see 7.9.3.4) provides a method for a host to set the time limit for a device to process READ STREAM and WRITE STREAM commands. If the host does not use a CONFIGURE STREAM command to set Default CCTL, the host may specify the time limit for command processing with the Command Completion Time Limit (CCTL) in each READ STREAM or WRITE STREAM command, where the time limit is effective for that command only (see 7.37.3.2). Each stream may be configured with different command completion time limits.

The READ STREAM and WRITE STREAM commands may access any user LBA on a device. These commands may be interspersed with commands not in the Streaming feature set, but, if commands not in the Streaming feature set are interspersed with READ STREAM or WRITE STREAM commands, there may be an impact on performance due to the unknown time required to complete the commands not in the Streaming feature set.

The host should send READ STREAM and WRITE STREAM commands specifying a transfer length that is a multiple of the Stream Minimum Request Size indicated in IDENTIFY DEVICE data word 95 (see 7.16.7.47).

4.23.2.2 Flush bit

The Flush bit (Flush) in the WRITE STREAM commands (see 7.76.3.3) specifies that the device flushes all volatile cache data for the specified stream to the media before command completion. If a host requests flushes at times other than the end of each Allocation Unit (see 7.9.3.5), streaming performance may be degraded. The SET FEATURES command to enable and disable caching (see 7.48.4) may affect caching for commands in the Streaming feature set.

4.23.2.3 Not Sequential bit

The Not Sequential bit (NS) in the READ STREAM commands (see 7.37.3.4) specifies that the next READ STREAM command with the same Stream ID may not be sequential in LBA space. This information helps the device with pre-fetching decisions.

4.23.2.4 Read Continuous bit

The Read Continuous bit (RC) in the READ STREAM commands (see 7.37.3.3) specifies that the device shall transfer the requested amount of data to the host within the time specified by Default CCTL or CCTL even if an error occurs. The data sent to the host by the device in an error condition is vendor specific.

4.23.2.5 Write Continuous bit

The Write Continuous bit (WC) in the WRITE STREAM commands (see 7.76.3.2) specifies that the device shall transfer the requested amount of data from the host within the time specified by Default CCTL or CCTL even if an error occurs. If the device is unable to resolve an error within the time specified by Default CCTL or CCTL, the erroneous section on the media may be unchanged or may contain undefined data. A future read of this area may not report an error, even though the data is erroneous.

4.23.2.6 Streaming Logs

A device implementing the Streaming feature set shall implement the Read Stream Error Log (see A.11) and the Write Stream Error Log (see A.16). These logs are accessed by a host via the READ LOG EXT command (see 7.29).

4.24 Tagged Command Queuing (TCQ) feature set

4.24.1 Overview

The optional Tagged Command Queuing (TCQ) feature set allows devices that require extended command time to perform a release so that the other device on the bus may be used. See the appropriate transport standard for the transport specific elements of service and release.

When the TCQ feature set is supported, the following commands shall be implemented:

- a) NOP
- b) READ DMA QUEUED
- c) SERVICE
- d) WRITE DMA QUEUED

When the TCQ feature set and the 48-bit Address feature set (see 4.4) are both supported, the following commands shall be implemented:

- a) READ DMA QUEUED EXT
- b) WRITE DMA QUEUED EXT
- c) WRITE DMA QUEUED FUA EXT

For the READ DMA QUEUED, READ DMA QUEUED EXT, WRITE DMA QUEUED, WRITE DMA QUEUED EXT, and WRITE DMA QUEUED FUA EXT commands, the device may perform a release. If the device is ready to complete processing of one of these commands, the device may complete the command without performing a release. If the device is not ready to complete processing of the command, then the device may perform a release and complete the command via a service request.

If a device has an outstanding TCQ command and has performed a release, then the device indicates that service is required only when the device is selected. If there is more than one device in a domain that has an outstanding TCQ command and has performed a release, then the host polls each device to determine if it is requesting service. To minimize host processor overhead, an application client may initiate hardware polling in a host adapter that supports it by issuing the NOP command with the NOP Auto Poll subcommand (see 7.21).

An application client may test whether or not the host adapter supports hardware polling by issuing the NOP command with the NOP Auto Poll subcommand and checking the response as follows:

- a) If the host adapter does not support hardware polling, then the host adapter transmits the NOP command with the NOP Auto Poll subcommand to the device and returns the response from the device. The device completes the command with the Abort bit set to one and the Error bit set to one (see 7.21); and

NOTE 5 — This flushes the volatile write cache to the non-volatile media, but does not report command aborted for TCQ commands (see 7.21).

- b) If the host adapter does support hardware polling, then the host adapter does not transmit the command to the device. Instead, the host adapter initiates hardware polling and generates a response with the Abort bit set to one and the Error bit cleared to zero (see 7.21).

4.24.2 Queueing

The queueing allows the host to issue concurrent commands to the same device. The queue contains all TCQ commands for which command acceptance has occurred but command completion has not occurred. If a queue exists, and the device receives a command that is not a TCQ command, except a NOP Auto Poll command, then the device shall return command aborted for the command, and all queued commands shall be discarded. The ending status shall be command aborted and the results are indeterminate.

The maximum queue depth supported by a device shall be indicated in IDENTIFY DEVICE data word 75 or IDENTIFY PACKET DEVICE data word 75.

A TCQ command shall have a Tag provided by the host in the Interrupt Reason field to uniquely identify the command. When the device restores command parameters during the execution of the SERVICE command, this Tag shall be restored so that the host may identify the command for which status is being presented. A Tag value may be any value between 0 and 31, regardless of the queue depth supported. If the device receives a TCQ command with a Tag value that is identical to the Tag value for another TCQ command that is in the queue, then the device shall return command aborted for the new command. If any error occurs, the device shall stop processing commands in the queue and remove them from the queue. The ending status shall be command aborted and the results are indeterminate.

When the device is ready to continue the processing of a released TCQ command, the device requests service by setting the Service bit (see 6.2.9) to one. The Service bit shall remain set to one until all TCQ commands ready for service have been serviced.

When the device receives a new command while TCQ commands are ready for service, the device shall process the new command per the protocol for the new command. If the TCQ commands ready for service still exist at command completion of this command, the Service bit remains set to one.

When reading status at command completion of a command, the host should check the Service bit since the Service bit may be set because the device is ready for service associated with another command.

4.25 Trusted Computing feature set

The Trusted Computing feature set provides an interface between a horizontal security product embedded in devices whose behavior may be authorized via interaction with a trusted host system.

The following commands are mandatory for devices implementing the Trusted Computing feature set:

- a) TRUSTED SEND;
- b) TRUSTED SEND DMA;
- c) TRUSTED RECEIVE; and
- d) TRUSTED RECEIVE DMA.

The following command is optional for devices implementing the Trusted Computing feature set:

- a) TRUSTED NON-DATA.

TRUSTED SEND and TRUSTED SEND DMA may be used interchangeably. The two commands only differ by the type of data transport protocol used (i.e., PIO Data-Out Command or DMA Command). Similarly, TRUSTED RECEIVE and TRUSTED RECEIVE DMA are interchangeable (i.e., PIO Data-In Command or DMA Command).

IDENTIFY DEVICE data word 48 bit 0 indicates whether or not this feature set is supported.

The DEVICE CONFIGURATION OVERLAY SET command provides a mechanism to remove support for this feature set.

The data streams and subsequent actions resulting from these commands are defined by the security protocol identified in the command parameters. These protocols may be defined by groups outside of this standard. The intent is to standardize the data content so it is identical across both ATA and SCSI interfaces.

4.26 Write-Read-Verify feature set

The optional Write-Read-Verify feature set allows a host to control Read After Write behavior in a device.

To enable or disable the feature of Write/Read/Verify, the host may issue a SET FEATURES command with one of two subcommand codes.

It is possible that the device may experience a performance degradation when the Write-Read-Verify feature set is enabled.

These commands are affected by this feature:

- a) WRITE DMA
- b) WRITE DMA EXT
- c) WRITE DMA FUA EXT
- d) WRITE DMA QUEUED
- e) WRITE DMA QUEUED EXT
- f) WRITE DMA QUEUED FUA EXT
- g) WRITE FPDMA QUEUED
- h) WRITE MULTIPLE
- i) WRITE MULTIPLE EXT
- j) WRITE MULTIPLE FUA EXT
- k) WRITE SECTOR(S)
- l) WRITE SECTOR(S) EXT

See 7.48.10 for a description of device behavior when this feature set is supported and enabled.

The IDENTIFY DEVICE or IDENTIFY PACKET DEVICE command shall reflect the supported and enabled or disabled state of this feature set.

When the device's volatile write cache is enabled, the device may report command completion with no error to the host even if the data is in the device volatile write cache and not written and verified to the non-volatile media. This is important to reduce the performance degradation when the Write-Read-Verify feature set is enabled.

If:

- a) a) the volatile write cache is disabled and any write command is processed by the device;
- b) b) a forced unit access write command is processed by the device; or
- c) c) a flush cache command is processed by the device,

then the device shall only report command completion after the data has been verified.

If the Write-Read-Verify feature set is enabled and the device has not already verified the maximum number of logical sectors configured for this feature set, then after the device has written the sectors to the non-volatile media, the device shall read the data from the non-volatile media and verify that there are no errors. A read from the non-volatile media shall be performed before verification. The verification of sectors is defined as vendor specific.

If the Write-Read-Verify feature set is disabled, or if the device has already verified the maximum number of logical sectors configured for this feature set, then no verification by this feature set shall be performed after the device has written the sectors to the non-volatile media.

If an unrecoverable error condition is encountered by the device during the write, read, or verify operation, the device shall set the Device Fault bit (see 6.2.6) to one.

5 ATA protocols

ATA Protocols are described in the transport documents. The protocols listed here shall be implemented by all transports that use ATA8-ACS commands. The following list of protocols are described in ATA8-AAM and the implementation of each protocol is described in the transport standards:

- a) Non-Data Command Protocol;
- b) PIO Data-In Command Protocol;
- c) PIO Data-Out Command Protocol;
- d) DMA Command Protocol;
- e) PACKET command Protocol;
- f) DMA Queued Command Protocol;
- g) Execute Device Diagnostic Command Protocol; and
- h) Device Reset Command Protocol.

6 Normal and Error Output field descriptions

6.1 Overview

Clause 6 describes requirements for all commands. Individual commands may describe additional requirements. The normal outputs (see 9.2) and error outputs (see 9.3) for each command shall include:

- a) a 1-byte Status field (see 6.2);
- b) a 1-byte Error field (see 6.3);
- c) for certain commands (e.g., PACKET, READ DMA QUEUED, READ DMA QUEUED EXT, WRITE DMA QUEUED, and WRITE DMA QUEUED EXT), a 1-byte Interrupt Reason field (see 6.4); and
- d) for certain commands (e.g., the READ FPDMA QUEUED command and WRITE FPDMA QUEUED command), the Count (see 6.5), SATA Status (see 6.7), and SActive (see 6.6) fields.

6.2 Status field

6.2.1 Overview

The Status field is one byte, is conveyed as an output from the device to the host, and is defined in table 16.

Table 16 — Status field

Bit	Description
7	Busy (see 6.2.2)
6	Device Ready (see 6.2.7)
5	Device Fault (see 6.2.6)
5	Stream Error (see 6.2.10)
4	Deferred Write Error (see 6.2.5) or Service (see 6.2.9)
3	Data Request (see 6.2.4)
2	Obsolete
1	Obsolete
0	Check Condition (see 6.2.3) or Error (see 6.2.8)

6.2.2 Busy bit

The Busy bit is transport dependent (see 6.2.11). Refer to the applicable transport standard for the usage of the Busy bit. In ATA/ATAPI-7 this bit was documented as the BSY bit.

6.2.3 Check Condition bit

The Check Condition bit shall be set to one if an Error sense key is greater than zero or any Error bit is set to one (see 6.3). In ATA/ATAPI-7 this bit was documented as the CHK bit.

6.2.4 Data Request bit

The Data Request bit is transport dependent (see 6.2.11). Refer to the appropriate transport standard for the usage of the Data Request bit. In ATA/ATAPI-7 this bit was documented as the DRQ bit.

6.2.5 Deferred Write Error bit

The Deferred Write Error bit shall be set to one if an error was detected in a deferred write to the media for a previous WRITE STREAM DMA EXT command (see 7.76) or WRITE STREAM EXT command (see 7.77). If the Deferred Write Error bit is set to one, the location of the deferred error is only reported in the Write Stream Error Log (see A.16). In ATA/ATAPI-7 this bit was documented as the DWE bit.

6.2.6 Device Fault bit

If the device enters a condition where continued operation may affect user data integrity (e.g., failure to spin-up without error, or no spares remaining for reallocation.), then the device shall set the Device Fault bit to one and no longer accept commands. This condition is only cleared by power cycling the device. Once the Device Fault bit has been cleared to zero it may remain clear until a command that affects user data integrity is received by the device. In ATA/ATAPI-7 this bit was documented as the DF bit.

6.2.7 Device Ready bit

The Device Ready bit is transport dependent (see 6.2.11). Refer to the applicable transport standard for the usage of the Device Ready bit. In ATA/ATAPI-7 this bit was documented as the DRDY bit.

6.2.8 Error bit

The Error bit shall be set to one if any bit in the Error field (see 6.3) is set to one. In ATA/ATAPI-7 this bit was documented as the ERR bit.

6.2.9 Service bit

The Service bit shall be cleared to zero in the Status field for a TCQ command when no other TCQ command is ready for service (see 4.24). The Service bit shall be set to one in the Status field for a TCQ command when another TCQ command is ready for service (i.e., the Service bit shall be set to one when the device has prepared the other TCQ command for service). In ATA/ATAPI-7 this bit was documented as the SERV bit.

6.2.10 Stream Error bit

The Stream Error bit shall be set to one if an error occurred during the processing of a command in the Streaming feature set (see 4.23) and either the Read Continuous (RC) bit is set to one in a READ STREAM command (see 7.37.3.3) or the Write Continuous (WC) bit is set to one in a WRITE STREAM command (see 7.76.3.2). When the Stream Error bit is set to one, the value returned in the LBA bits (47:0) contains the address of the first logical sector in error, and the Count field contains the number of consecutive logical sectors that may contain errors. If the RC bit is set to one in a READ STREAM command or the WC bit is set to one in a WRITE STREAM command, and the Interface CRC bit, the Uncorrectable Error bit, the ID Not Found bit, the Abort bit, or the Command Completion Time Out bit is set to one in the Error field (see 6.3), then:

- a) a) the Stream Error bit shall be set to one;
- b) b) the Error bit shall be cleared to zero;
- c) c) and the error information (e.g., bits set in the Error field) shall be saved in the appropriate Read Stream Error Log (see A.11) or Write Stream Error log (see A.16).

In ATA/ATAPI-7 this bit was documented as the SE bit.

6.2.11 Transport Dependent (TD)

All bits and fields that are labelled transport dependent are defined in the transport standards.

6.3 Error field

6.3.1 Overview

The Error field is one byte, is conveyed as an output from the device to the host, and is defined in table 17.

Table 17 — Error field

Bit	Description
7:4	Sense Key (see 6.3.12)
7	Interface CRC (see 6.3.10)
6	Uncorrectable Error (see 6.3.13)
5	Obsolete
4	ID Not Found (see 6.3.6)
3	Obsolete
2	Abort (see 6.3.2)
1	End of Media (see 6.3.5)
0	Illegal Length Indicator (see 6.3.7) or Command Completion Time Out (see 6.3.4) or Media Error (see 6.3.11) or Attempted Partial Range Removal (see 6.3.3) or Insufficient NV Cache space (see 6.3.9) or Insufficient LBA Range Entries Remaining (see 6.3.8)

6.3.2 Abort bit

The Abort bit shall be set to one if the device aborted the command. The Abort bit shall be cleared to zero if the device did not abort the command. In ATA/ATAPI-7 this bit was documented as the ABRT bit.

The Abort bit is set to one when the device does not set the ID Not Found bit to one when a user addressable address was not found or the host request an address outside of the range of user addressable addresses (see 4.11.4 and 6.3.6).

6.3.3 Attempted Partial Range Removal bit

The Attempted Partial Range Removal bit shall be set to one if the REMOVE LBA(S) FROM NV CACHE PINNED SET command (see 7.20.9) attempted to unpin part of a previously defined NV Cache command range.

6.3.4 Command Completion Time Out bit

The Command Completion Time Out bit shall be set to one if a Command Completion Time Out error has occurred (see 4.23). In ATA/ATAPI-7 this bit was documented as the CCTO bit.

6.3.5 End of Media bit

The operation of the End of Media bit is specific to the SCSI command set implemented by ATAPI devices. In ATA/ATAPI-7 this bit was documented as the EOM bit.

6.3.6 ID Not Found bit

The ID Not Found bit shall be set to one if:

- a) a user-addressable address was not found; or
- b) an address outside of the range of user-addressable addresses is requested, and the Abort bit is not set to one (see 4.11.4 and 6.3.2).

6.3.7 Illegal Length Indicator bit

The operation of the Illegal Length Indicator bit is specific to the SCSI command set implemented by ATAPI devices. In ATA/ATAPI-7 this bit was documented as the ILI bit.

6.3.8 Insufficient LBA Range Entries Remaining bit

The Insufficient LBA Range Entries Remaining bit shall be set to one if the device has run out of space to store LBA ranges for ADD LBA(S) TO NV CACHE PINNED SET command (see 7.20.3).

6.3.9 Insufficient NV Cache Space bit

The Insufficient NV Cache Space bit shall be set to one if there is not enough NV Cache to satisfy the ADD LBA(S) TO NV CACHE PINNED SET command (see 7.20.3).

6.3.10 Interface CRC bit

The Interface CRC bit shall be set to one if an interface CRC error has occurred during an Ultra DMA data transfer. The content of the Interface CRC bit may be applicable to Multiword DMA and PIO data transfers. If the Interface CRC is set to one, the Abort bit shall be set to one. In ATA/ATAPI-7 this bit was documented as the ICRC bit.

6.3.11 Media Error bit

The Media Error bit shall be set to one if a media error is detected. In ATA/ATAPI-7 this bit was documented as the MED bit.

6.3.12 Sense Key field

The operation of this four bit field is specific to the SCSI command set implemented by ATAPI devices.

6.3.13 Uncorrectable Error bit

The Uncorrectable Error bit shall be set to one if the data contains an uncorrectable error. In ATA/ATAPI-7 this bit was documented as the UNC bit.

6.4 Interrupt Reason field

6.4.1 Overview

The Interrupt Reason field is one byte, is conveyed as an output from the device to the host for commands in the PACKET command feature set, commands in the TCQ feature set, and commands in the NCQ feature set, and is defined in table 18.

Table 18 — Interrupt Reason Field

Bit	Description
7:3	Tag (see 6.4.5)
2	Release (see 6.4.4)
1	Input/Output (see 6.4.3)
0	Command/Data (see 6.4.2)

6.4.2 Command/Data bit

The Command/Data bit shall be cleared to zero if the transfer is data, otherwise the Command/Data bit shall be set to one. In ATA/ATAPI-7 this bit was documented as the C/D bit.

6.4.3 Input/Output (I/O) bit

The Input/Output bit shall be cleared to zero if the transfer is to the device. The Input/Output bit shall be set to one if the transfer is to the host. In ATA/ATAPI-7 this bit was documented as the I/O bit.

6.4.4 Release bit

The Release bit shall be set to one if a command has been accepted but not completed and the device is ready to accept another command. In ATA/ATAPI-7 this bit was documented as the REL bit.

6.4.5 Tag field

The Tag field shall contain the Tag value for a TCQ command. A Tag value may be any value between 0 and 31 regardless of the queue depth supported.

6.5 Count field

6.5.1 overview

The Count field is one byte, is conveyed as an output from the device to the host, and is defined in table 19.

Table 19 — Count field

Bit	Description
7:3	NCQ Tag (see 6.5.2)
2:0	Reserved

6.5.2 NCQ Tag field

The NCQ Tag field shall contain the NCQ Tag value for an NCQ command. An NCQ Tag value may be any value that does not exceed the value in word 75 in the IDENTIFY DEVICE data (see 7.16.7.31).

6.6 SActive field

See SATA Rev 2.6 for a description of the SActive field.

6.7 SATA Status

See SATA Rev 2.6 for a description of word 0 of the Set Device Bits FIS.

7 Command descriptions

7.1 Command description introduction

7.1.1 Overview

ATA commands are delivered using the following fields: Feature, Count, LBA, Device and Command. Field lengths change based on the type of command (see 7.1.3)

This standard describes the ATA command set in a transport independent fashion. Each command is defined by a series of subclauses as described in 7.1.2 through 7.1.8.

7.1.2 Command Name - Command Code [Subcommand Code], Command Protocol

The heading for each command starts with the name of the command. The name is followed by “-” and then the command code, subcommand code if applicable, and protocol used to execute the command.

An example heading reads:

READ SECTOR(S) - 20h, PIO Data-In

In this example heading the name of the command is “READ SECTOR(S)”. The command code is 20h. The protocol used to transfer the data is PIO Data-In.

Protocols are defined in ATA8-AAM. The transport protocol standards define the implementation of each protocol.

7.1.3 Feature Set

The feature set subclause for each command lists the feature set (see clause 4) along with a statement that indicates if the command uses 28-bit field formatting or 48-bit field formatting. If a command uses 28-bit formatting then:

- a) the Feature field, Count field, Device field, Error field, Status field and Command field are 8 bits in length; and
- b) the LBA field is 28-bits in length.

If a command uses 48-bit formatting then:

- a) the Device field, Error field, Status field and Command field is 8 bits in length;
- b) the Feature field and Count field is 16 bits in length; and
- c) the LBA field is 48-bits in length.

An example feature set subclause reads:

Feature Set

This 28-bit command is mandatory for all devices implementing the General feature set.

7.1.4 Inputs

7.1.4.1 Overview

The Inputs subclause contains a table showing the inputs for the command. An example command structure is listed below.

Name	Description
Feature	Each transport standard shows how the Feature field is mapped for proper functionality. Each transport standard also shows how 28-bit commands are mapped differently from 48-bit commands.
Count	Each transport standard shows how the Count field is mapped for proper functionality. Each transport standard also shows how 28-bit commands are mapped differently from 48-bit commands.
LBA	For many commands this is the LBA of the first logical sector to be transferred. Each transport standard defines how these bits are mapped to the appropriate fields or registers.
Device	Each transport standard shows how the Device field bits (7:4) are mapped. Bits (3:0) are marked reserved in every reference to the Device field.
Command	The command number goes here.

7.1.5 Normal Outputs

This is an example Normal Output. A command with Normal Outputs does not return an error. Therefore, the Error field in the Normal Outputs is reserved in every command. Count and LBA may be reserved. In some commands these fields have return parameters on successful command completion. The Status field shows the Device Fault bit and the Error bit. Bits 7, 6, and 3 are marked Transport Dependent in many of the Normal Outputs. In ATA/ATAPI-7 these bits were documented as the BSY bit, the DRDY bit, and the DRQ bit, respectively.

Table 20 — Example Normal Output

Name	Description
Error	Reserved
Count	Reserved
LBA	Reserved
Device	<p>Bit Description</p> <ul style="list-style-type: none"> 7 Obsolete 6 N/A 5 Obsolete 4 Transport Dependent - See 6.2.11 3:0 Reserved
Status	<p>Bit Description</p> <ul style="list-style-type: none"> 7:6 Transport Dependent - See 6.2.11. 5 Device Fault - See 6.2.6 4 N/A 3:0 Reserved

7.1.6 Error Outputs

The Error Outputs subclause shows the Error, Count, LBA and Status fields. An Error Output occurs when a bit in the Status field (e.g., the Error bit, the Device Fault bit, or the Stream Error bit) is set to one, indicating that an error occurred. If the Error bit is set to one, the Error field indicates the type of Error that occurred.

Table 21 — Example Error Output

Name	Description
Error	<p>Bit Description</p> <ul style="list-style-type: none"> 7 Interface CRC - See 6.3.10 6 Uncorrectable Error - See 6.3.13 5 Obsolete 4 ID Not Found - See 6.3.6 3 Obsolete 2 Abort - See 6.3.2 1 Obsolete 0 Obsolete
Count	Reserved
LBA	LBA of first unrecoverable error
Device	<p>Bit Description</p> <ul style="list-style-type: none"> 7 Obsolete 6 N/A 5 Obsolete 4 Transport Dependent - See 6.2.11 3:0 Reserved
Status	<p>Bit Description</p> <ul style="list-style-type: none"> 7:6 Transport Dependent - See 6.2.11. 5 Device Fault - See 6.2.6 4 N/A 3 Transport Dependent - See 6.2.11. 2:1 N/A 0 Error - See 6.2.8

7.1.7 Input From the Device to the Host Data Structure

Some commands (e.g., IDENTIFY DEVICE or DEVICE CONFIGURATION IDENTIFY) return a data structure to the host. This data structure is referred to as an input data structure and is documented following the Error Outputs subclause.

7.1.8 Output From the Host to the Device Data Structure

Some commands, (e.g., DEVICE CONFIGURATION SET or SECURITY SET PASSWORD) accept a data structure from the host. This data structure is referred to as an Output Data Structure and is documented following the Error Outputs subclause.

7.1.9 Unsupported commands

The host should not issue commands that are indicated as not supported. If the device receives an unsupported command, then the device shall respond with command aborted as described in table 118.

7.2 CFA ERASE SECTORS - C0h, Non-Data

7.2.1 Feature Set

This 28-bit command is mandatory for devices implementing the CFA feature set. This command code is Vendor Specific for devices not implementing the CFA feature set.

7.2.2 Description

This command causes the device to pre-erase and condition from 1 to 256 logical sectors as specified in the Count field. This command should be issued in advance of a CFA WRITE SECTORS WITHOUT ERASE or a CFA WRITE MULTIPLE WITHOUT ERASE command to increase the execution speed of the write operation.

7.2.3 Inputs

Name	Description
Feature	N/A
Count	Number of logical sectors to be erased. A value of 00h specifies that 256 logical sectors are to be erased
LBA	LBA of first logical sector to be erased
Device	<p>Bit Description</p> <ul style="list-style-type: none"> 7 Obsolete 6 Shall be set to one 5 Obsolete 4 Transport Dependent - See 6.2.11 3:0 Reserved
Command	7:0 C0h

7.2.4 Normal Outputs

See table 97.

7.2.5 Error Outputs

See table 119.

7.3 CFA REQUEST EXTENDED ERROR CODE - 03h, Non-Data

7.3.1 Feature Set

This 28-bit command is mandatory for devices implementing the CFA feature set.

7.3.2 Description

This command provides a mechanism for the device to return an extended error code in the Error field that identifies the cause of an error condition in more detail than is available with Status and Error field values. The CFA REQUEST EXTENDED ERROR CODE command shall return an extended error code (see table 22) if the previous command completed with an error or a No error detected extended error code if the previous command completed without error.

7.3.3 Inputs

Name	Description
Feature	N/A
Count	N/A
LBA	N/A
Device	<p>Bit Description</p> <p>7 Obsolete</p> <p>6 N/A</p> <p>5 Obsolete</p> <p>4 Transport Dependent - See 6.2.11</p> <p>3:0 Reserved</p>
Command	7:0 03h

7.3.4 Normal Outputs

See table 98.

Table 22 — Extended error codes (part 1 of 2)

Extended error code	Description
00h	No error detected / no additional information
01h	Self-test passed
02h	Reserved
03h	Write / Erase failed
04h	Reserved
05h	Self-test or diagnostic failed
06h-08h	Reserved
09h	Miscellaneous error
0Ah	Reserved
0Bh	Vendor specific
0Ch	Corrupted media format
0Dh-0Fh	Vendor specific
10h	ID Not Found / ID Error
11h	Uncorrectable ECC error

Table 22 — Extended error codes (part 2 of 2)

Extended error code	Description
12h-13h	Reserved
14h	ID Not Found
15h-17h	Reserved
18h	Corrected ECC error
19h-1Ch	Reserved
1Dh-1Eh	Vendor specific
1Fh	Data transfer error / command aborted
20h	Invalid command
21h	Invalid LBA
22h-23h	Vendor specific
24h-26h	Reserved
27h	Write protect violation
28h-2Eh	Reserved
2Fh	LBA overflow (i.e., address too large)
30h-34h	Self-test or diagnostic failed
35h-36h	Supply or generated voltage out of tolerance
37h	Self-test or diagnostic failed
38h	Corrupted media format
39h	Vendor specific
3Ah	Spare sectors exhausted
3Bh-3Ch	Corrupted media format
3Dh	Vendor specific
3Eh	Self-test or diagnostic failed
3Fh	Corrupted media format
40h-FFh	Reserved

7.3.5 Error Outputs

See table 121.

7.4 CFA TRANSLATE SECTOR - 87h, PIO Data-In

7.4.1 Feature Set

This 28-bit command is mandatory for devices implementing the CFA feature set. This command code is Vendor Specific for devices not implementing the CFA feature set.

7.4.2 Description

This command provides a mechanism for a device to return information related to a specific logical sector. The data indicates the erased or not erased status of the logical sector, and the number of erase and write cycles performed on that sector. Devices may return zero in fields that do not apply or that are not supported by the device.

7.4.3 Inputs

Name	Description
Feature	N/A
Count	N/A
LBA	LBA of Logical Sector
Device	<p>Bit Description</p> <ul style="list-style-type: none"> 7 Obsolete 6 Shall be set to one 5 Obsolete 4 Transport Dependent - See 6.2.11 3:0 Reserved
Command	7:0 87h

7.4.4 Normal Outputs

See table 100.

7.4.5 Input From the Device to the Host Data Structure

512 bytes of data are transferred to the host (see table 23).

Table 23 — CFA TRANSLATE SECTOR data

Bytes	Description
0-3	Obsolete
4	LBA (23:16)
5	LBA (15:8)
6	LBA (7:0)
7-18	Reserved
19	Logical sector erased flag (FFh = erased; 00h = not erased)
20-23	Reserved
24	Logical sector write cycles count (23:16)
25	Logical sector write cycles count (15:8)
26	Logical sector write cycles count (7:0)
27-511	Reserved

7.4.6 Error Outputs

See table 121.

7.5 CFA WRITE MULTIPLE WITHOUT ERASE - CDh, PIO Data-Out

7.5.1 Feature Set

This 28-bit command is mandatory for devices implementing the CFA feature set.

7.5.2 Description

This command is similar to the WRITE MULTIPLE command (see 7.71). Interrupts are not generated on every logical sector, but on the transfer of a block that contains the number of logical sectors defined by the SET MULTIPLE MODE command (see 7.51).

Command execution is identical to the WRITE MULTIPLE operation except that the logical sectors are written without an implied erase operation. The logical sectors should be pre-erased by a preceding CFA ERASE SECTORS command.

If bit 8 of IDENTIFY DEVICE data word 59 is cleared to zero, and a CFA WRITE MULTIPLE WITHOUT ERASE command is received by the device, and no successful SET MULTIPLE MODE command has been processed by the device, then the device shall return command aborted. A successful SET MULTIPLE MODE command should precede a CFA WRITE MULTIPLE WITHOUT ERASE command.

7.5.3 Inputs

Name	Description
Feature	N/A
Count	Number of logical sectors to be transferred. A value of 00h specifies that 256 logical sectors are to be transferred
LBA	Starting LBA
Device	<p>Bit Description</p> <ul style="list-style-type: none"> 7 Obsolete 6 Shall be set to one 5 Obsolete 4 Transport Dependent - See 6.2.11 3:0 Reserved
Command	7:0 CDh

7.5.4 Normal Outputs

See table 100.

7.5.5 Error Outputs

An unrecoverable error encountered during processing of this command results in command completion with the device returning the LBA of the logical sector where the first unrecovered error occurred. The amount of data transferred is indeterminate. See table 120.

7.6 CFA WRITE SECTORS WITHOUT ERASE - 38h, PIO Data-Out

7.6.1 Feature Set

This 28-bit command is mandatory for devices implementing the CFA feature set.

7.6.2 Description

Command processing is identical to the WRITE SECTOR(S) command (see 7.74) operation except that the logical sectors are written without an implied erase operation. The logical sectors should be pre-erased by a preceding CFA ERASE SECTORS command (see 7.2). If the sector is not pre-erased with the CFA ERASE SECTORS command, then a normal write sector operation occurs.

7.6.3 Inputs

Name	Description
Feature	N/A
Count	Number of logical sectors to be transferred. A value of 00h specifies that 256 logical sectors are to be transferred
LBA	Starting LBA
Device	<p>Bit Description</p> <ul style="list-style-type: none"> 7 Obsolete 6 Shall be set to one 5 Obsolete 4 Transport Dependent - See 6.2.11 3:0 Reserved
Command	7:0 38h

7.6.4 Normal Outputs

See table 100.

7.6.5 Error Outputs

An unrecoverable error encountered during processing of this command results in command completion with the device returning the LBA of the logical sector where the first unrecovered error occurred. The amount of data transferred is indeterminate. See table 120.

7.7 CHECK MEDIA CARD TYPE - D1h, Non-Data

7.7.1 Feature Set

This 28-bit command is mandatory for devices implementing the Media Card Pass Through Command feature set.

7.7.2 Description

The CHECK MEDIA CARD TYPE command allows the host to determine if the device supports the Media Card Pass Through Command feature set. If the Enable bit in the Feature field is set to one, IDENTIFY DEVICE data word 87 bit 3 shall be set to one upon successful command completion.

If the adapter supports the Media Card Pass Through Command feature set and the Enable bit of the Feature field is set to one, the adapter shall process any further Media Card Pass Through Command feature set commands. If the Enable bit is cleared to zero, the adapter shall not interpret the command codes D2 through D4 as the Media Card Pass Through Command feature set commands.

If the adapter does not support the Media Card Pass Through Command feature set, or the host has disabled the Media Card Pass Through Command feature set mode by clearing the Enable bit to zero, the host should not send any further Media Card Pass Through Command feature set commands to the adapter.

7.7.3 Inputs

Name	Description
Feature	<p>Bit Description</p> <p>15:1 N/A</p> <p>0 Enable - Shall be set to one to enable the Media Card Pass Through Command feature set. Enable shall be cleared to zero to disable the Media Card Pass Through Command feature set.</p>
Count	N/A
LBA	N/A
Device	<p>Bit Description</p> <p>7 Obsolete</p> <p>6 N/A</p> <p>5 Obsolete</p> <p>4 Transport Dependent - See 6.2.11</p> <p>3:0 Reserved</p>
Command	7:0 D1h

7.7.4 Normal Outputs

See table 101.

7.7.5 Error Outputs

See table 122.

7.8 CHECK POWER MODE - E5h, Non-Data

7.8.1 Feature Set

This 28-bit command is mandatory for ATA devices. This command is mandatory for ATAPI devices when the Power Management feature set is not implemented in the command set transmitted via the PACKET command.

7.8.2 Description

The CHECK POWER MODE command allows the host to determine the current power mode of the device. The CHECK POWER MODE command shall not cause the device to change its power management state or affect the operation of the Standby timer.

NOTE 6 — Elements of the device may be in transition to the reported state.

7.8.3 Inputs

Name	Description
Feature	N/A
Count	N/A
LBA	N/A
Device	<p>Bit Description</p> <p>7 Obsolete</p> <p>6 N/A</p> <p>5 Obsolete</p> <p>4 Transport Dependent - See 6.2.11</p> <p>3:0 Reserved</p>
Command	7:0 E5h

7.8.4 Normal Outputs

See table 102.

7.8.5 Error Outputs

See table 121.

7.9 CONFIGURE STREAM - 51h, Non-Data

7.9.1 Feature Set

This 48-bit command is mandatory for devices that implement the Streaming feature set.

7.9.2 Description

The CONFIGURE STREAM command specifies the operating parameters for a stream. A CONFIGURE STREAM command may be issued for each stream that is to be added or removed from the current operating configuration.

7.9.3 Inputs

7.9.3.1 Overview

Name	Description
Feature	<p>Bit Description</p> <p>15:8 Default Command Completion Time Limit (Default CCTL) - See 7.9.3.4.</p> <p>7 Add/Remove Stream (A/R) – See 7.9.3.2.</p> <p>6 Obsolete</p> <p>5:3 Reserved</p> <p>2:0 Stream ID - See 7.9.3.3.</p>
Count	Allocation Unit – See 7.9.3.5
LBA	Reserved
Device	<p>Bit Description</p> <p>7 Obsolete</p> <p>6 Shall be set to one</p> <p>5 Obsolete</p> <p>4 Transport Dependent - See 6.2.11</p> <p>3:0 Reserved</p>
Command	7:0 51h

7.9.3.2 Add/Remove Stream (A/R)

If A/R is set to one (i.e., the application client is adding a stream), then the device shall set the operating parameters for the stream as specified by this command. If the Stream ID was specified by a previous CONFIGURE STREAM command, and the current CONFIGURE STREAM command completes without error, then the operating parameters specified by the current CONFIGURE STREAM command shall replace the operating parameters specified by the previous CONFIGURE STREAM command for the stream.

If A/R is cleared to zero (i.e., the application client is removing a stream), then the device shall clear the operating characteristics for the Stream ID specified by this command and the Default Command Completion Time Limit field is Reserved..

7.9.3.3 Stream Identifier (Stream ID)

Stream ID specifies the stream to which the operating parameters in the command apply. There are eight possible streams total.

7.9.3.4 Default Command Completion Time Limit (Default CCTL)

The Default CCTL field indicates the time in which the device shall report command completion for a READ STREAM or a WRITE STREAM command for this stream with the CCTL field cleared to zero (see 7.37.3.2) according to the following formula:

$$(\text{Default CCTL} * (\text{IDENTIFY DEVICE data words (99:98)})) \text{ microseconds}$$

The device shall measure the time from command acceptance to command completion.

7.9.3.5 Allocation Unit

The Allocation Unit specifies the number of logical blocks that the device should use for read look-ahead and write cache operations for the stream being configured.

NOTE 7 — Setting the Allocation Unit does not restrict or change command behavior.

7.9.4 Normal Outputs

See table 103.

7.9.5 Error Outputs

The Abort bit shall be set to one if any of the following are true:

- a) The device does not support the requested stream configuration;
- b) A/R is cleared to zero and the Feature field contains a Stream ID that has not been sent in a previous CONFIGURE STREAM command; or
- c) The device does not support the requested Default CCTL.

If the Abort bit is set to one, then the last parameters specified for the Stream ID shall remain in effect. See table 127 for the definition of Error Outputs.

7.10 Device Configuration Overlay (DCO)

7.10.1 DCO Overview

Individual DCO feature set (see 4.8) commands are identified by the value placed in the Feature field. Table 24 shows these Feature field values.

Table 24 — Device Configuration Overlay Feature field values

Value	Commands
00h-BFh	Reserved
C0h	DEVICE CONFIGURATION RESTORE
C1h	DEVICE CONFIGURATION FREEZE LOCK
C2h	DEVICE CONFIGURATION IDENTIFY
C3h	DEVICE CONFIGURATION SET
C4h-FFh	Reserved

7.10.2 DEVICE CONFIGURATION FREEZE LOCK - B1h/C1h, Non-Data

7.10.2.1 Feature Set

This 28-bit command is mandatory for devices implementing the DCO feature set.

7.10.2.2 Description

The DEVICE CONFIGURATION FREEZE LOCK command provides a method for the host to prevent accidental modification of a device's DCO settings. After a device has completed a DEVICE CONFIGURATION FREEZE LOCK command without error, the device shall return command aborted for all DEVICE CONFIGURATION SET, DEVICE CONFIGURATION FREEZE LOCK, DEVICE CONFIGURATION IDENTIFY, and DEVICE CONFIGURATION RESTORE commands until after the device processes a power-on reset. A device shall be in the factory_config state or the reduced_config state (see figure 4) after processing a power-on reset. A device shall not exit the DCO_Locked state as the result of processing a hardware reset or a software reset.

7.10.2.3 Inputs

Name	Description
Feature	C1h
Count	N/A
LBA	N/A
Device	<p>Bit Description</p> <p>7:5 N/A</p> <p>4 Transport Dependent - See 6.2.11</p> <p>3:0 Reserved</p>
Command	7:0 B1h

7.10.2.4 Normal Outputs

See table 99.

7.10.2.5 Error Outputs

The Abort bit shall be set to one if the device has completed a previous DEVICE CONFIGURATION FREEZE LOCK command without error since processing the most recent power-on reset. See table 122.

7.10.3 DEVICE CONFIGURATION IDENTIFY - B1h/C2h, PIO Data-In

7.10.3.1 Feature Set

This 28-bit command is mandatory for devices implementing the DCO feature set.

7.10.3.2 Description

The DEVICE CONFIGURATION IDENTIFY command causes a device to return a 512-byte data structure. The content of this data structure indicates the selectable commands, modes, and feature sets that the device is capable of disabling or modifying through processing of a DEVICE CONFIGURATION SET command. If a DEVICE CONFIGURATION SET command reducing a device's capabilities has completed without error, then:

- a) the response by a device to an IDENTIFY DEVICE, IDENTIFY PACKET DEVICE, and other commands, except the DEVICE CONFIGURATION IDENTIFY command, shall reflect the reduced set of capabilities; and
- b) the response by a device to a DEVICE CONFIGURATION IDENTIFY command shall reflect the entire set of selectable capabilities.

The phrase "is changeable" used in 7.10.3 indicates that the feature may be disabled by the host using a DEVICE CONFIGURATION SET command (see 7.10.5).

If the feature is not changeable then the device may support the feature but the DEVICE CONFIGURATION SET command shall not affect support of the feature.

The format of the Device Configuration Overlay data structure is shown in table 25.

7.10.3.3 Inputs

Name	Description
Feature	C2h
Count	N/A
LBA	N/A
Device	<p>Bit Description</p> <p>7:5 N/A</p> <p>4 Transport Dependent - See 6.2.11</p> <p>3:0 Reserved</p>
Command	7:0 B1h

7.10.3.4 Normal Outputs

See table 99.

7.10.3.5 Error Outputs

A device shall return command aborted if the device has completed a DEVICE CONFIGURATION FREEZE LOCK command without error since processing the most recent power-on reset. A device may return command completion with the Error bit set to one if an Interface CRC error has occurred. See table 123.

NOTE 8 — There is no defined mechanism for a device to return an Interface CRC error status that may have occurred during the last data block of a PIO-in data transfer; there may be other mechanisms in which a host may verify that an Interface CRC error occurred in these cases.

7.10.3.6 Input From the Device to the Host Data Structure

Table 25 — Device Configuration Identify data structure (part 1 of 2)

Word	Content
0	Data structure revision
1	Multiword DMA modes supported 15:3 Reserved 2 1 = Reporting support for Multiword DMA mode 2 and below is changeable 1 1 = Reporting support for Multiword DMA mode 1 and below is changeable 0 1 = Reporting support for Multiword DMA mode 0 is changeable
2	Ultra DMA modes supported 15:7 Reserved 6 1 = Reporting support for Ultra DMA mode 6 and below is changeable 5 1 = Reporting support for Ultra DMA mode 5 and below is changeable 4 1 = Reporting support for Ultra DMA mode 4 and below is changeable 3 1 = Reporting support for Ultra DMA mode 3 and below is changeable 2 1 = Reporting support for Ultra DMA mode 2 and below is changeable 1 1 = Reporting support for Ultra DMA mode 1 and below is changeable 0 1 = Reporting support for Ultra DMA mode 0 is changeable
3-6	Maximum LBA (QWord) 63:48 Reserved 47:0 Maximum LBA
7	Command set/feature set supported part 1 15 Reserved 14 1 = Reporting support for the Write-Read-Verify feature set is changeable 13 1 = Reporting support for the SMART Conveyance self-test is changeable 12 1 = Reporting support for the SMART Selective self-test is changeable 11 1 = Reporting support for the Forced Unit Access is changeable 10 Reserved for TLC 9 1 = Reporting support for the Streaming feature set is changeable 8 1 = Reporting support for the 48-bit Addressing feature set is changeable 7 1 = Reporting support for the HPA feature set is changeable 6 1 = Reporting support for the AAM feature set is changeable 5 1 = Reporting support for the TCQ feature set is changeable 4 1 = Reporting support for the PUIS feature set is changeable 3 1 = Reporting support for the Security feature set is changeable 2 1 = Reporting support for the SMART error log is changeable 1 1 = Reporting support for the SMART self-test is changeable 0 1 = Reporting support for the SMART feature set is changeable
8	Serial ATA Command set/feature set supported 15:5 Reserved for Serial ATA 4 1 = Reporting support for the SSP feature set is changeable

Table 25 — Device Configuration Identify data structure (part 2 of 2)

Word	Content
	3 1 = Reporting support for asynchronous notification is changeable 2 1 = Reporting support for interface power management is changeable 1 1 = Reporting support for non-zero buffer offsets is changeable 0 1 = Reporting support for the NCQ feature set is changeable
9	Reserved for Serial ATA
10-20	Reserved
21	Command set/feature set supported part 2 15 1 = Reporting support for the NV Cache feature set is changeable 14 1 = Reporting support for the NV Cache Power Management feature set is changeable 13 1 = Reporting support for WRITE UNCORRECTABLE EXT is changeable 12 1 = Reporting of support for the Trusted Computing feature set is changeable 11 1 = Reporting support for the Free-fall Control feature set is changeable 10:0 Reserved
22	Command set/feature set supported part 3 15:0 Reserved
23-207	Reserved
208-254	Vendor Specific
255	Integrity word 15:8 Checksum 7:0 A5h

7.10.3.6.1 Word 0: Data structure revision

Word 0 shall contain the value 0002h.

7.10.3.6.2 Word 1: Multiword DMA modes supported

Word 1 bits (2:0) contain the same information as contained in IDENTIFY DEVICE data word 63 or IDENTIFY PACKET DEVICE data word 63 (see 7.16.7.24). Bits (15:3) of word 1 are reserved.

7.10.3.6.3 Word 2: Ultra DMA modes supported

Word 2 bits (6:0) contain the same information as contained in IDENTIFY DEVICE data word 88 or IDENTIFY PACKET DEVICE data word 88 (see 7.16.7.40). Bits (15:7) of word 2 are reserved.

7.10.3.6.4 Words 3-6: Maximum LBA

Words 3-6 define the maximum LBA. This is the highest LBA accepted by the device in the factory default condition. If the device has not completed a DEVICE CONFIGURATION SET command without error that modifies its factory default condition, then the device returns the same value in this field as would be returned for a READ NATIVE MAX ADDRESS or READ NATIVE MAX ADDRESS EXT command.

7.10.3.6.5 Word 7: Command/features set supported part 1

If bit 0 of Word 7 is set to one, then support for the SMART feature set is changeable.

If bit 1 of Word 7 is set to one, then support for SMART self-test including the self-test log is changeable.

If bit 2 of Word 7 is set to one, then support for SMART error logging is changeable.

If bit 3 of Word 7 is set to one, then support for the Security feature set is changeable.

If bit 4 of Word 7 is set to one, then support for the PUIS feature set is changeable.

If bit 5 of Word 7 is set to one, then support for the TCQ feature set is changeable.

If bit 6 of Word 7 is set to one, then support for the AAM feature set is changeable.

If bit 7 of Word 7 is set to one, then support for the HPA feature set is changeable.

If bit 8 of Word 7 is set to one, then support for the 48-bit Addressing feature set is changeable.

If bit 9 of Word 7 is set to one, then support for the Streaming feature set is changeable.

Bit 10 of Word 7 is reserved for technical report TLC.

If bit 11 of Word 7 is set to one, then support for Force Unit Access commands is changeable.

If bit 12 of Word 7 is set to one, then support for SMART Selective self-test (see 7.53.6.10) is changeable.

If bit 13 of Word 7 is set to one, then support for SMART Conveyance self-test (see 7.53.6.10) is changeable.

If bit 14 of Word 7 is set to one, then support for the Write-Read-Verify feature set is changeable.

7.10.3.6.6 Word 8: Serial ATA Command set/feature set supported

Bits (15:5) Reserved for Serial ATA

If bit 4 of Word 8 is set to one, then support for software settings preservation is changeable.

If bit 3 of Word 8 is set to one, then support for asynchronous notification by an ATAPI device is changeable. See SATA 2.6 for more information.

If bit 2 of Word 8 is set to one, then support for interface power management requests is changeable. See SATA 2.6 for more information.

If bit 1 of Word 8 is set to one, then support for non-zero buffer offsets for commands in the NCQ feature set is changeable.

If bit 0 of Word 8 is set to one, then support for the NCQ feature set is changeable.

7.10.3.6.7 Word 9: Reserved for Serial ATA

This word is reserved for Serial ATA.

7.10.3.6.8 Words 10-20: Reserved

7.10.3.6.9 Word 21: Command/features set supported part 2

If bit 15 of Word 21 is set to one, then support for the NV Cache feature set is changeable.

If bit 14 of Word 21 is set to one, then support for the NV Cache Power Management feature set is changeable.

If bit 13 of Word 21 is set to one, then support for the WRITE UNCORRECTABLE EXT command is changeable.

If bit 12 of Word 21 is set to one, then support for the Trusted Computing feature set is changeable.

If bit 11 of Word 21 is set to one, then support for the Free-fall Control feature set is changeable.

Bits 10:0 of Word 21 are reserved.

7.10.3.6.10 Word 22: Command/features set supported part 3

Bits (15:0) are reserved.

7.10.3.6.11 Words 23-207: Reserved

7.10.3.6.12 Words 208-254: Vendor Specific

7.10.3.6.13 Word 255: Integrity word

Bits (7:0) of this word shall contain the value A5h. Bits (15:8) of this word shall contain the data structure checksum. The data structure checksum shall be the two's complement of the sum of all bytes in words 0-254 and the byte consisting of bits (7:0) of word 255. Each byte shall be added with unsigned arithmetic, and overflow shall be ignored. The sum of all bytes is zero when the checksum is correct.

7.10.4 DEVICE CONFIGURATION RESTORE - B1h/C0h, Non-Data

7.10.4.1 Feature Set

This 28-bit command is mandatory for devices implementing the DCO feature set.

7.10.4.2 Description

The DEVICE CONFIGURATION RESTORE command provides a method for a host to restore any setting previously changed by a DEVICE CONFIGURATION SET command and to restore the content of the IDENTIFY DEVICE data, IDENTIFY PACKET DEVICE data, and other feature settings in a device to their factory default settings. The results of this action are indicated by the data returned from the Input Data of a DEVICE CONFIGURATION IDENTIFY command.

If a DEVICE CONFIGURATION RESTORE command changes reporting of support for the Security feature set from not allowed to allowed, and if the DEVICE CONFIGURATION IDENTIFY command indicates that reporting of that support is allowed, then the device shall set the Security feature set state to SEC1, shall set IDENTIFY DEVICE data to the values described in table 10, and shall restore the saved Master password and Master Password Identifier; otherwise, the Security state shall not change.

7.10.4.3 Inputs

Name	Description
Feature	C0h
Count	N/A
LBA	N/A
Device	<p>Bit Description</p> <p>7:5 N/A</p> <p>4 Transport Dependent - See 6.2.11</p> <p>3:0 Reserved</p>
Command	7:0 B1h

7.10.4.4 Normal Outputs

See table 99.

7.10.4.5 Error Outputs

The Abort bit shall be set to one if a HPA has been set by a non-volatile SET MAX ADDRESS or SET MAX ADDRESS EXT command, or if DEVICE CONFIGURATION FREEZE LOCK command has been completed without error since a power-on reset has been processed. See table 122.

7.10.5 DEVICE CONFIGURATION SET - B1h/C3h, PIO Data-Out

7.10.5.1 Feature Set

This 28-bit command is mandatory for devices implementing the DCO feature set.

7.10.5.2 Description

The DEVICE CONFIGURATION SET command allows a host to reduce the set of optional commands, modes, or feature sets supported by a device as indicated by a DEVICE CONFIGURATION IDENTIFY command. The DEVICE CONFIGURATION SET command may modify the data returned by IDENTIFY DEVICE or IDENTIFY PACKET DEVICE. When the IDENTIFY DEVICE data or IDENTIFY PACKET DEVICE data is changed, the device shall respond in a manner consistent with the new data.

If a bit is set to one in the DEVICE CONFIGURATION SET data transmitted to the device (see table 26) that is not set in the DCO data received from a DEVICE CONFIGURATION IDENTIFY command (see table 25), no action is taken for that bit.

Modifying the maximum LBA of the device also modifies the LBA value returned by a READ NATIVE MAX ADDRESS or READ NATIVE MAX ADDRESS EXT command.

The format of the DEVICE CONFIGURATION SET data transmitted by the device is described in table 26. The restrictions on changing these bits are also described in 7.10.5.6. If any of the bit modification restrictions described are violated, the device shall return command aborted.

The phrase 'is allowed' in table 26 specifies that the device may report that a feature is supported.

If the device is configured to not support a feature, then the device shall:

- a) report that the feature is not supported;
- b) as required, report that the feature is not enabled; and
- c) not support the feature.

7.10.5.3 Inputs

Name	Description
Feature	C3h
Count	N/A
LBA	N/A
Device	<p>Bit Description</p> <p>7:5 N/A</p> <p>4 Transport Dependent - See 6.2.11</p> <p>3:0 Reserved</p>
Command	7:0 B1h

7.10.5.4 Normal Outputs

See table 99.

7.10.5.5 Error Outputs

The Abort bit shall be set to one if:

- a) a DEVICE CONFIGURATION SET command has already modified the original settings as reported by a DEVICE CONFIGURATION IDENTIFY command;
- b) a DEVICE CONFIGURATION FREEZE LOCK command has completed without error;
- c) any of the bit modification restrictions described in 7.10.5.2 are violated;
- d) a Host Protected Area has been established by the processing of a SET MAX ADDRESS or SET MAX ADDRESS EXT command; or

- e) an attempt was made to modify a mode or feature that shall not be modified with the device in its current state.

See table 141.

7.10.5.6 Output From the Host to the Device Data Structure

Table 26 — Device Configuration Overlay (DCO) data structure (part 1 of 2)

Word	Content
0	Data structure revision
1	Multiword DMA modes supported 15:3 Reserved 2 1 = Reporting support for Multiword DMA mode 2 and below is allowed 1 1 = Reporting support for Multiword DMA mode 1 and below is allowed 0 1 = Reporting support for Multiword DMA mode 0 is allowed
2	Ultra DMA modes supported 15:7 Reserved 6 1 = Reporting support for Ultra DMA mode 6 and below is allowed 5 1 = Reporting support for Ultra DMA mode 5 and below is allowed 4 1 = Reporting support for Ultra DMA mode 4 and below is allowed 3 1 = Reporting support for Ultra DMA mode 3 and below is allowed 2 1 = Reporting support for Ultra DMA mode 2 and below is allowed 1 1 = Reporting support for Ultra DMA mode 1 and below is allowed 0 1 = Reporting support for Ultra DMA mode 0 is allowed
3-6	Maximum LBA (QWord) 63:48 Reserved 47:0 Maximum LBA
7	Command set/feature set supported part 1 15 Reserved 14 1 = Reporting support for the Write-Read-Verify feature set is allowed 13 1 = Reporting support for the SMART Conveyance self-test is allowed 12 1 = Reporting support for the SMART Selective self-test is allowed 11 1 = Reporting support for Forced Unit Access is allowed 10 Reserved for TLC 9 1 = Reporting support for the Streaming feature set is allowed 8 1 = Reporting support for the 48-bit Addressing feature set is allowed 7 1 = Reporting support for HPA feature set is allowed 6 1 = Reporting support for the AAM feature set is allowed 5 1 = Reporting support for the TCQ feature set is allowed 4 1 = Reporting support for the PUIS feature set is allowed 3 1 = Reporting support for the Security feature set is allowed 2 1 = Reporting support for the SMART error log is allowed 1 1 = Reporting support for the SMART self-test is allowed 0 1 = Reporting support for the SMART feature set is allowed
8	Serial ATA Command set/feature set supported 15:5 Reserved for Serial ATA 4 1 = Reporting support for the SSP feature set is allowed

Table 26 — Device Configuration Overlay (DCO) data structure (part 2 of 2)

Word	Content
	3 1 = Reporting support for asynchronous notification is allowed 2 1 = Reporting support for interface power management is allowed 1 1 = Reporting support for non-zero buffer offsets is allowed 0 1 = Reporting support for the NCQ feature set is allowed
9	Reserved for Serial ATA
10-20	Reserved
21	Command set/feature set supported part 2 15 Reporting support for the NV Cache feature set is allowed 14 Reporting support for the NV Cache Power Management feature set is allowed 13 1= Reporting support for the WRITE UNCORRECTABLE EXT command is allowed 12 1= reporting of support for the Trusted Computing feature set is allowed 11 1 = Reporting support for the Free-fall Control feature set is allowed 10:0 Reserved
22	Command set/feature set supported part 3 15:0 Reserved
23-207	Reserved
208-254	Vendor Specific
255	Integrity word 15:8 Checksum 7:0 A5h

7.10.5.6.1 Word 0: Data structure revision

Word 0 shall contain the value 0002h.

7.10.5.6.2 Word 1: Multiword DMA modes supported

Bits (15:3) of word 1 are reserved.

If Multiword DMA mode 2 is not currently selected and bit 2 of word 1 is cleared to zero, then the device shall:

- a) disable support for Multiword DMA mode 2; and
- b) clear bit 2 of word 63 in IDENTIFY DEVICE data or IDENTIFY PACKET DEVICE data to zero.

If Multiword DMA mode 2 is currently selected and bit 2 of word 1 is cleared to zero, then the device shall not clear bit 2 of word 63 in IDENTIFY DEVICE data or IDENTIFY PACKET DEVICE data to zero.

If Multiword DMA mode 1 is not currently selected and bit 1 of word 1 is cleared to zero, then the device shall:

- a) disable support for Multiword DMA mode 1; and
- b) clear bit 1 of word 63 in IDENTIFY DEVICE data or IDENTIFY PACKET DEVICE data to zero.

If Multiword DMA mode 2 is supported or Multiword DMA mode 1 or 2 is currently selected and bit 1 of word 1 is cleared to zero, then the device shall not clear bit 1 of word 63 in IDENTIFY DEVICE data or IDENTIFY PACKET DEVICE data to zero.

Bit 0 of word 1 shall be set to one.

7.10.5.6.3 Word 2: Ultra DMA modes supported

Bits (15:7) of word 2 are reserved.

If Ultra DMA mode 6 is not currently selected and bit 6 of word 2 is cleared to zero, then the device shall:

- a) disable support for Ultra DMA mode 6; and
- b) clear bit 6 of word 88 in IDENTIFY DEVICE data or IDENTIFY PACKET DEVICE data to zero.

If Ultra DMA mode 6 is currently selected, then the device shall not clear bit 6 of word 88 in IDENTIFY DEVICE data or IDENTIFY PACKET DEVICE data to zero.

If bit 5 of word 2 is cleared to zero and:

- a) Ultra DMA mode 6 and 5 are not currently selected; and
- b) Ultra DMA mode 6 is not supported,

then the device shall clear bit 5 of word 88 in IDENTIFY DEVICE data or IDENTIFY PACKET DEVICE data to zero.

If bit 4 of word 2 is cleared to zero and:

- a) Ultra DMA mode 6, 5 and 4 are not currently selected; and
- b) Ultra DMA mode 6 and 5 are not supported,

then the device shall clear bit 4 of word 88 in IDENTIFY DEVICE data or IDENTIFY PACKET DEVICE data to zero.

If bit 3 of word 2 is cleared to zero and:

- a) Ultra DMA mode 6, 5, 4 and 3 are not currently selected; and
- b) Ultra DMA mode 6, 5 and 4 are not supported,

then the device shall clear bit 3 of word 88 in IDENTIFY DEVICE data or IDENTIFY PACKET DEVICE data to zero.

If bit 2 of word 2 is cleared to zero and:

- a) Ultra DMA mode 6, 5, 4, 3 and 2 are not currently selected; and
- b) Ultra DMA mode 6, 5, 4 and 3 are not supported,

then the device shall clear bit 2 of word 88 in IDENTIFY DEVICE data or IDENTIFY PACKET DEVICE data to zero.

If bit 1 of word 2 is cleared to zero and:

- a) Ultra DMA mode 6, 5, 4, 3, 2 and 1 are not currently selected; and
- b) Ultra DMA mode 6, 5, 4, 3 and 2 are not supported,

then the device shall clear bit 1 of word 88 in IDENTIFY DEVICE data or IDENTIFY PACKET DEVICE data to zero.

If bit 0 of word 2 is cleared to zero and:

- a) Ultra DMA mode 6, 5, 4, 3, 2, 1 and 0 are not currently selected; and
- b) Ultra DMA mode 6, 5, 4, 3, 2 and 1 are not supported,

then the device shall clear bit 0 of word 88 in IDENTIFY DEVICE data or IDENTIFY PACKET DEVICE data to zero.

7.10.5.6.4 Words 3-6: Maximum LBA

Words 3-6 define the maximum LBA. This shall be the highest LBA accepted by the device after execution of the command. When this value is changed, the content of IDENTIFY DEVICE data words 60-61 and 100-103 shall be changed as described in the SET MAX ADDRESS and SET MAX ADDRESS EXT command descriptions to reflect the maximum LBA set with this command. If the device has established an HPA as the result of processing a SET MAX ADDRESS or SET MAX ADDRESS EXT command with an LBA value less than that returned by a READ NATIVE MAX ADDRESS or READ NATIVE MAX ADDRESS EXT command, then the device shall return command aborted for this command and not change any data in the HPA.

7.10.5.6.5 Word 7: Command/features set supported part 1

Bit 15 of word 7 is reserved.

If bit 14 of word 7 is cleared to zero, then the device shall:

- a) disable support for the Write-Read-Verify feature set;
- b) clear bit 1 of word 119 in IDENTIFY DEVICE or IDENTIFY PACKET DEVICE data to zero; and
- c) clear bit 1 of word 120 in IDENTIFY DEVICE or IDENTIFY PACKET DEVICE data to zero.

If bit 13 of word 7 is cleared to zero, then the device shall:

- a) disable support for the SMART Conveyance self-test;
- b) return command aborted for subsequent SMART EXECUTE OFF-LINE IMMEDIATE commands with an Execute SMART Conveyance self-test routine subcommand; and
- c) clear bit 5 to zero in the Offline Data Collection Capabilities field in the Device SMART data structure.

If bit 12 of word 7 is cleared to zero, then the device shall:

- a) disable support for the SMART Selective self-test;
- b) return command aborted for subsequent SMART EXECUTE OFF-LINE IMMEDIATE commands with an Execute SMART Selective self-test routine subcommand; and
- c) clear bit 6 to zero in the Offline Data Collection Capabilities field in the Device SMART data structure.

If bit 11 of word 7 is cleared to zero, then the device shall:

- a) disable support for the WRITE DMA FUA EXT command, the WRITE MULTIPLE FUA EXT command, and the WRITE DMA QUEUED FUA EXT command; and
- b) clear bits (7:6) of word 84 in IDENTIFY DEVICE or IDENTIFY PACKET DEVICE data to zero.

Bit 10 of Word 7 is reserved for TLC.

If bit 9 of word 7 is cleared to zero, then the device shall:

- a) disable support for the Streaming feature set;
- b) clear bits 4, 9, and 10 of word 84 in IDENTIFY DEVICE or IDENTIFY PACKET DEVICE data to zero;
- c) clear words 95-99 in IDENTIFY DEVICE or IDENTIFY PACKET DEVICE data to zero; and
- d) clear word 104 in IDENTIFY DEVICE or IDENTIFY PACKET DEVICE data to zero.

If bit 8 of word 7 is cleared to zero, then the device shall:

- a) disable support for the 48-bit Addressing feature set;
- b) clear bit 10 of word 83 in IDENTIFY DEVICE or IDENTIFY PACKET DEVICE data to zero; and
- c) clear words 100-103 in IDENTIFY DEVICE or IDENTIFY PACKET DEVICE data to zero.

If bit 7 of word 7 is cleared to zero, and a HPA has not been established by use of a SET MAX ADDRESS or SET MAX ADDRESS EXT command, then the device shall:

- a) disable support for the HPA feature set;
- b) clear bit 10 of word 82 in IDENTIFY DEVICE or IDENTIFY PACKET DEVICE data to zero;
- c) clear bit 8 of word 83 in IDENTIFY DEVICE or IDENTIFY PACKET DEVICE data to zero;
- d) clear bit 10 of word 85 in IDENTIFY DEVICE or IDENTIFY PACKET DEVICE data to zero; and
- e) clear bit 8 of word 86 in IDENTIFY DEVICE or IDENTIFY PACKET DEVICE data to zero.

If bit 7 of word 7 is cleared to zero, and a HPA has been established by use of a SET MAX ADDRESS or SET MAX ADDRESS EXT command, then the device shall return command aborted for the DEVICE CONFIGURATION SET command.

If bit 6 of word 7 is cleared to zero, then the device shall:

- a) disable support for the AAM feature set;
- b) clear bit 9 of word 83 in IDENTIFY DEVICE or IDENTIFY PACKET DEVICE data to zero; and
- c) clear word 94 in IDENTIFY DEVICE or IDENTIFY PACKET DEVICE data to zero.

If bit 5 of word 7 is cleared to zero, then the device shall:

- a) disable support for the READ DMA QUEUED command and the WRITE DMA QUEUED command;
- b) clear bit 1 of word 83 in IDENTIFY DEVICE or IDENTIFY PACKET DEVICE data to zero; and
- c) clear bit 1 of word 86 in IDENTIFY DEVICE or IDENTIFY PACKET DEVICE data to zero.

If bit 4 of word 7 is cleared to zero, and the PUIS feature set has not been enabled by a jumper, then the device shall:

- a) disable support for the Power-Up In Standby feature set;
- b) clear bits (6:5) of word 83 in IDENTIFY DEVICE or IDENTIFY PACKET DEVICE data to zero; and
- c) clear bits (6:5) of word 86 in IDENTIFY DEVICE or IDENTIFY PACKET DEVICE data to zero.

If bit 4 of word 7 is cleared to zero, and PUIS has been enabled by jumper, then the DEVICE CONFIGURATION SET command shall return command aborted and the IDENTIFY DEVICE and IDENTIFY PACKET DEVICE data words shall remain unchanged.

If bit 3 of word 7 is cleared to zero, and security is disabled, then the device shall:

- a) save any Master Password and Master Password Identifier;
- b) disable support for the Security feature set;
- c) not change its Security state;
- d) clear bit 1 of word 82 in IDENTIFY DEVICE or IDENTIFY PACKET DEVICE data to zero;
- e) clear bit 1 of word 85 in IDENTIFY DEVICE or IDENTIFY PACKET DEVICE data to zero; and
- f) clear words 89, 90, 92, and 128 in IDENTIFY DEVICE or IDENTIFY PACKET DEVICE data to zero.

If bit 3 of word 7 is cleared to zero, and security is enabled, then the device shall return command aborted for the DEVICE CONFIGURATION SET command.

If bit 2 of word 7 is cleared to zero, then the device shall:

- a) disable support for SMART error logging;
- b) clear bit 0 of word 84 in IDENTIFY DEVICE or IDENTIFY PACKET DEVICE data to zero; and
- c) clear bit 0 of word 87 in IDENTIFY DEVICE or IDENTIFY PACKET DEVICE data to zero.

If bit 1 of word 7 is cleared to zero, then the device shall:

- a) disable support for the SMART Off-line, Short, and Extended self-tests;
- b) return command aborted for subsequent SMART EXECUTE OFF-LINE IMMEDIATE commands with an Execute SMART Off-line, Short, or Extended self-test routine subcommand;
- c) clear bit 4 and 3 to zero in the Offline Data Collection Capabilities field in the Device SMART data structure;
- d) clear bit 1 of word 84 in IDENTIFY DEVICE or IDENTIFY PACKET DEVICE data to zero; and
- e) clear bit 1 of word 87 in IDENTIFY DEVICE or IDENTIFY PACKET DEVICE data to zero.

If bit 1 of word 7 is cleared to zero, and bits 12 and 13 of word 7 are not supported, then the device may:

- a) disable support for the SMART Conveyance self-test;
- b) return command aborted for subsequent SMART EXECUTE OFF-LINE IMMEDIATE commands with an Execute SMART Conveyance self-test routine subcommand;
- c) clear bit 5 to zero in the Offline Data Collection Capabilities field in the Device SMART data structure.
- d) disable support for the SMART Selective self-test;
- e) return command aborted subsequent SMART EXECUTE OFF-LINE IMMEDIATE commands with an Execute SMART Selective self-test routine subcommand; and
- f) clear bit 6 to zero in the Offline Data Collection Capabilities field in the Device SMART data structure.

If bit 0 of word 7 is cleared to zero, and bits (2:1) of word 7 are cleared to zero, then the device shall:

- a) disable support for the SMART feature set;
- b) clear bit 0 of word 82 in IDENTIFY DEVICE or IDENTIFY PACKET DEVICE data to zero; and
- c) clear bit 0 of word 85 in IDENTIFY DEVICE or IDENTIFY PACKET DEVICE data to zero.

If bit 0 of word 7 is cleared to zero, and bits (2:1) of word 7 are not both cleared to zero, then the device shall return command aborted for the DEVICE CONFIGURATION SET command.

7.10.5.6.6 Word 8: Serial ATA Command set/feature set supported

This word enables configuration of command sets and feature sets.

Bits (15:5) of word 8 are reserved for Serial ATA. If bit 4 of word 8 is cleared to zero, then the device shall:

- a) disable support for the SSP feature set;

- b) clear bit 6 of word 78 in IDENTIFY DEVICE or IDENTIFY PACKET DEVICE data to zero;
- c) clear bit 6 of word 79 in IDENTIFY DEVICE or IDENTIFY PACKET DEVICE data to zero; and
- d) clear any software settings that would be cleared when the SSP feature set is disabled.

If bit 3 of word 8 is cleared to zero, then the device shall:

- a) disable support for asynchronous notification (see the Serial ATA specification);
- b) clear bit 5 of word 78 in IDENTIFY DEVICE or IDENTIFY PACKET DEVICE data to zero; and
- c) clear bit 5 of word 79 in IDENTIFY DEVICE or IDENTIFY PACKET DEVICE data to zero.

If bit 2 of word 8 is cleared to zero, then the device shall:

- a) disable support for interface power management requests (see the Serial ATA specification);
- b) clear bit 9 of word 76 in IDENTIFY DEVICE or IDENTIFY PACKET DEVICE data to zero;
- c) clear bit 3 of word 78 in IDENTIFY DEVICE or IDENTIFY PACKET DEVICE data to zero; and
- d) clear bit 3 of word 79 in IDENTIFY DEVICE or IDENTIFY PACKET DEVICE data to zero.

If bit 1 of word 8 is cleared to zero, then the device shall:

- a) disable support for non-zero buffer offsets for NCQ commands (also see the Serial ATA specification);
- b) clear bit 1 of word 78 in IDENTIFY DEVICE or IDENTIFY PACKET DEVICE data to zero;
- c) clear bit 4 of word 78 in IDENTIFY DEVICE or IDENTIFY PACKET DEVICE data to zero;
- d) clear bit 1 of word 79 in IDENTIFY DEVICE or IDENTIFY PACKET DEVICE data to zero; and
- e) clear bit 4 of word 79 in IDENTIFY DEVICE or IDENTIFY PACKET DEVICE data to zero.

If bit 0 of word 8 is cleared to zero, then the device shall:

- a) disable support for the NCQ feature set;
- b) clear bit 8 of word 76 in IDENTIFY DEVICE or IDENTIFY PACKET DEVICE data to zero;
- c) clear bit 1 of word 78 in IDENTIFY DEVICE or IDENTIFY PACKET DEVICE data to zero;
- d) clear bit 2 of word 78 in IDENTIFY DEVICE or IDENTIFY PACKET DEVICE data to zero;
- e) clear bit 4 of word 78 in IDENTIFY DEVICE or IDENTIFY PACKET DEVICE data to zero;
- f) clear bit 1 of word 79 in IDENTIFY DEVICE or IDENTIFY PACKET DEVICE data to zero;
- g) clear bit 2 of word 79 in IDENTIFY DEVICE or IDENTIFY PACKET DEVICE data to zero; and
- h) clear bit 4 of word 79 in IDENTIFY DEVICE or IDENTIFY PACKET DEVICE data to zero.

7.10.5.6.7 Word 9: Reserved for Serial ATA

Word 9 is reserved for use by Serial ATA.

7.10.5.6.8 Words 10-20: Reserved

7.10.5.6.9 Word 21: Command/features set supported part 2

If bit 15 of word 21 is set to one, then the device may support the NV Cache feature set. If bit 15 of word 21 is cleared to zero, and bit 14 of word 21 is set to one, then the device shall return command aborted for the DEVICE CONFIGURATION SET command. If bit 15 of word 21 is cleared to zero, and there is pinned data or the NV Cache has not been flushed, then the device shall return command aborted for the DEVICE CONFIGURATION SET command.

If bits 15 and 14 of word 21 is set to one, then the device may support the NV Cache Power Management feature set.

If bit 13 of word 21 is set to one, then the device may support the WRITE UNCORRECTABLE EXT command.

If bit 12 of word 21 is cleared to zero, and security is disabled, then the device shall:

- a) disable support for the Trusted Computing feature set; and
- b) clear bit 0 of word 48 in IDENTIFY DEVICE or IDENTIFY PACKET DEVICE data to zero.

If bit 12 of word 21 is cleared to zero, and security is enabled, then the device shall return command aborted for the DEVICE CONFIGURATION SET command.

If bit 11 of word 21 is set to one, then the device may support the Free-fall Control feature set.

Bits (10:0) of word 21 are reserved.

7.10.5.6.10 Word 22: Command/features set supported part 3

Bit (15:0) of word 22 are reserved.

7.10.5.6.11 Words 23-207: Reserved

7.10.5.6.12 Words 208-254: Vendor Specific

7.10.5.6.13 Word 255: Integrity word

Bits (7:0) of word 255 shall contain the value A5h. Bits (15:8) of word 255 shall contain the data structure checksum. The data structure checksum shall be the two's complement of the sum of all bytes in words 0-254 and the byte consisting of bits (7:0) of word 255. Each byte shall be added with unsigned arithmetic, and overflow shall be ignored. The sum of all bytes is zero when the checksum is correct.

7.11 DEVICE RESET - 08h, Device Reset

7.11.1 Feature Set

This 28-bit command is mandatory for ATAPI devices.

7.11.2 Description

The DEVICE RESET command resets the device.

7.11.3 Inputs

Name	Description
Feature	N/A
Count	N/A
LBA	N/A
Device	<p style="text-align: center;">Bit Description</p> <p style="text-align: center;">7 Obsolete</p> <p style="text-align: center;">6 N/A</p> <p style="text-align: center;">5 Obsolete</p> <p style="text-align: center;">4 Transport Dependent - See 6.2.11</p> <p style="text-align: center;">3:0 Reserved</p>
Command	7:0 08h

7.11.4 Normal Outputs

See table 104.

7.11.5 Error Outputs

If DEVICE RESET is supported, it should not complete with an error. If the device is able to complete the DEVICE RESET and maintain the device setting then DEVICE RESET shall complete with Check Condition cleared to zero. If the device reverts to its default state, the device shall report an exception by setting the Check Condition bit in the Status field.

7.12 DOWNLOAD MICROCODE - 92h, PIO Data-Out/Non-Data

7.12.1 Feature Set

This 28-bit command is optional for devices implementing the General feature set.

7.12.2 Description

This command enables the host to alter the device's microcode. The data transferred using the DOWNLOAD MICROCODE command is vendor specific.

All transfers shall be zero length or an integer multiple of 512-byte data blocks. The size of the data transfer is determined by the contents of the LBA and Count fields. If a value of zero is in both fields, then the Non-Data transfer protocol shall be used. This allows transfer sizes from 0 bytes to 33,553,920 bytes, in 512-byte increments.

The Feature field indicates the mode of the DOWNLOAD MICROCODE command as described in 7.12.3.

The optional Download with offsets and save microcode for immediate and future use allows the application client to transfer microcode in two or more DOWNLOAD MICROCODE commands.

The download block count value in the Count and LBA fields shall specify how many 512-byte blocks of data are being transferred in one command.

The Buffer Offset value is defined by the value in the LBA (23:8). The buffer offset value is the starting location in the data relative to the last successful DOWNLOAD MICROCODE command received by the device with a Buffer Offset of zero. The Buffer Offset value shall be between 0 and 65,535. The buffer offset value is the byte count divided by 512 (e.g., if a microcode file is to be transferred to the device in 32,768 byte segments the first command should be issued with buffer offset value of zero, the second command should be issued with a buffer offset value of 64, the third command should be issued with a buffer offset value of 128 and so on until the complete microcode is transferred).

If the current buffer offset is not equal to the sum of the previous DOWNLOAD MICROCODE command buffer offset and the previous sector count, then the device shall report command aborted for the DOWNLOAD MICROCODE command and discard all previously downloaded microcode. The first DOWNLOAD MICROCODE command shall have a buffer offset of zero.

When the device detects the last download microcode command for the firmware download the device shall perform any device required verification and save the complete set of downloaded microcode. Device feature configuration (e.g., SET FEATURES settings) may be affected by the download microcode command.

The new microcode should become effective immediately after the transfer of the last data segment has completed.

If the device receives a command other than DOWNLOAD MICROCODE prior to the receipt of the last segment, then the device shall process the new command and may discard previously downloaded microcode.

During the processing of a power-on reset, a hardware reset, or a software reset prior to applying the new microcode, the device shall discard any received microcode segments.

7.12.3 Inputs

Name	Description
Feature	<p>Sub command Description</p> <p>00h Reserved</p> <p>01h Obsolete</p> <p>02h Reserved</p> <p>03h Download with offsets and save microcode for immediate and future use.</p> <p>04h-06h Reserved</p> <p>07h Download and save microcode for immediate and future use.</p> <p>08-FFh Reserved</p>
Count	Block count (7:0)
LBA	<p>Bit Description</p> <p>27:24 Reserved</p> <p>23:8 Buffer offset (only used for Feature = 03h, otherwise this field shall be reserved)</p> <p>7:0 Block count (15:8)</p>
Device	<p>Bit Description</p> <p>7 Obsolete</p> <p>6 N/A</p> <p>5 Obsolete</p> <p>4 Transport Dependent - See 6.2.11</p> <p>3:0 Reserved</p>
Command	7:0 92h

7.12.4 Normal Outputs

If IDENTIFY DEVICE data word 234 or IDENTIFY DEVICE data word 235 have a value other than 0000h or FFFFh then table 27 describes the indicator returned in the Count field.

Table 27 — Count field output for DOWNLOAD MICROCODE requesting the offset transfer method

Value	Description
00h	No indication of download microcode status.
01h	Indicates the ATA device is expecting more download microcode commands to follow.
02h	Indicates that the ATA device has applied the new microcode.
03h-FFh	Reserved

For additional returns see table 99.

7.12.5 Error Outputs

The device shall return command aborted if the device did not accept the microcode data. The device shall return command aborted if the subcommand code is not a supported value. See table 123.

7.13 EXECUTE DEVICE DIAGNOSTIC - 90h, Execute Device Diagnostic

7.13.1 Feature Set

This 28-bit command is mandatory for all devices.

7.13.2 Description

This command shall cause the device to perform internal diagnostic tests.

NOTE 9 — There are transport and Host Adapter implications for this command (i.e., see ATA8-APT and HBA2).

If the host issues an EXECUTE DEVICE DIAGNOSTIC command while a device is in or going to a power management mode except Sleep, then the device shall process the diagnostic sequence.

7.13.3 Inputs

Name	Description
Feature	N/A
Count	N/A
LBA	N/A
Device	<p style="text-align: center;">Bit Description</p> <p style="text-align: center;">7 Obsolete</p> <p style="text-align: center;">6 N/A</p> <p style="text-align: center;">5 Obsolete</p> <p style="text-align: center;">4 Transport Dependent - See 6.2.11</p> <p style="text-align: center;">3:0 Reserved</p>
Command	7:0 90h

7.13.4 Normal Outputs

See table 104. The diagnostic code written into the Error field is an 8-bit code. Table 28 defines these values.

Table 28 — Diagnostic codes

Code ^a	Description
When this code is in the Device 0 ^c Error field	
01h	Device 0 ^c passed, Device 1 ^c passed or not present
00h, 02h-7Fh	Device 0 ^c failed, Device 1 ^c passed or not present
81h	Device 0 ^c passed, Device 1 ^c failed
80h, 82h-FFh	Device 0 ^c failed, Device 1 ^c failed
When this code is in the Device 1 ^c Error field	
01h	Device 1 ^c passed ^b
00h, 02h-7Fh	Device 1 ^c failed ^b
80h-FFh	Reserved
^a Codes other than 01h and 81h may indicate additional information about the failure(s). ^b If Device 1 is not present, the host may see the information from Device 0 even though Device 1 is selected. ^c See the appropriate transport standard for the definition of device 0 and device 1.	

7.13.5 Error Outputs

This command shall complete without setting the Error bit to one (see 7.13.4).

7.14 FLUSH CACHE - E7h, Non-Data

7.14.1 Feature Set

This 28-bit command is mandatory for devices not implementing the PACKET feature set. This command is optional for devices implementing the PACKET feature set.

7.14.2 Description

This command requests the device to flush the volatile write cache. If there is data in the volatile write cache, that data shall be written to the non-volatile media. This command shall not indicate completion until the data is flushed to the non-volatile media or an error occurs. If the device supports more than 28 bits of addressing this command shall attempt to flush all the data in the volatile cache. If the volatile write cache is disabled or no volatile write cache is present, the device shall indicate command completion without error.

NOTE 10 — This command may take longer than 30 seconds to complete.

7.14.3 Inputs

Name	Description
Feature	N/A
Count	N/A
LBA	N/A
Device	<p>Bit Description</p> <p>7 Obsolete</p> <p>6 N/A</p> <p>5 Obsolete</p> <p>4 Transport Dependent - See 6.2.11</p> <p>3:0 Reserved</p>
Command	7:0 E7h

7.14.4 Normal Outputs

See table 99.

7.14.5 Error Outputs

If an unrecoverable error occurs while the device is writing data to its media, then the device shall terminate processing the command and report the error, including the LBA of the first sector where an unrecoverable error occurred. Subsequent FLUSH CACHE commands continue the process of flushing the cache. See table 128.

If an error occurs during the flush process and the LBA of the data in error is outside the 28-bit address range then the LBA of the logical sector in error is incorrectly reported. For correct error reporting in a device that has more than a 28-bit address range, use FLUSH CACHE EXT (see 7.15).

7.15 FLUSH CACHE EXT - EAh, Non-Data

7.15.1 Feature Set

This 48-bit command is mandatory for devices implementing the 48-bit Address feature set

7.15.2 Description

This command requests the device to flush the volatile write cache. If there is data in the volatile write cache, that data shall be written to the non-volatile media. This command shall not indicate completion until the data is flushed to the non-volatile media or an error occurs. If the volatile write cache is disabled or no volatile write cache is present, the device shall indicate command completion without error.

NOTE 11 — This command may take longer than 30 seconds to complete.

7.15.3 Inputs

Name	Description
Feature	Reserved
Count	Reserved
LBA	Reserved
Device	<p>Bit Description</p> <p>7 Obsolete</p> <p>6 N/A</p> <p>5 Obsolete</p> <p>4 Transport Dependent - See 6.2.11</p> <p>3:0 Reserved</p>
Command	7:0 EAh

7.15.4 Normal Outputs

See table 111.

7.15.5 Error Outputs

If an unrecoverable error occurs while the device is writing data to its media, then the device shall terminate processing the command and report the error, including the LBA of the first sector where an unrecoverable error occurred. If a device receives a subsequent FLUSH CACHE EXT command, then the device shall continue the process of flushing its cache. See table 129.

7.16 IDENTIFY DEVICE - ECh, PIO Data-In

7.16.1 Feature Set

This 28-bit command is mandatory for all devices.

7.16.2 Description

The IDENTIFY DEVICE command specifies that the device shall send a 512-byte block of data to the host. See 7.16.7 for a description of the return data.

Some devices may have to read the media in order for all applicable IDENTIFY DEVICE data fields to be valid.

The IDENTIFY DEVICE data contains information regarding optional feature or command support. If the host issues a command that is indicated as not supported in the IDENTIFY DEVICE data, the device shall return command aborted for the command.

7.16.3 Inputs

Name	Description
Feature	N/A
Count	N/A
LBA	N/A
Device	<p>Bit Description</p> <p>7 Obsolete</p> <p>6 N/A</p> <p>5 Obsolete</p> <p>4 Transport Dependent - See 6.2.11</p> <p>3:0 Reserved</p>
Command	7:0 ECh

7.16.4 Normal Outputs for ATA devices

See table 99.

7.16.5 Normal Outputs for ATAPI devices

In response to this command, ATAPI devices shall return command aborted and place the PACKET feature set signature in the appropriate fields (see table 104).

7.16.6 Error Outputs

ATA devices shall not report an error.

7.16.7 Input From the Device to the Host Data Structure

7.16.7.1 Overview

Table 29 specifies the format of the IDENTIFY DEVICE data.

Table 29 — IDENTIFY DEVICE data (part 1 of 18)

Word	O M	S P	F V	Description
0	M	B	F X X X V X	General configuration 15 0 = ATA device 14:8 Retired 7:6 Obsolete 5:3 Retired 2 Response incomplete 1 Retired 0 Reserved
1			X	Obsolete
2	O	B	V	Specific configuration
3			X	Obsolete
4-5			X	Retired
6			X	Obsolete
7-8		N		Reserved for the CompactFlash Association
9			X	Retired
10-19	M	B	F	Serial number (ATA string)
20-21			X	Retired
22			X	Obsolete
23-26	M	B	F	Firmware revision (ATA string)
27-46	M	B	F	Model number (ATA string)
47	M	B B	F F	15:8 80h 7:0 00h = Reserved 01h-FFh = Maximum number of logical sectors that shall be transferred per DRQ data block on READ/WRITE MULTIPLE commands
Key:				O/M – Mandatory/optional requirement.
F/V – Fixed/variable content				M – Support of the word is mandatory.
F – The content of the field is fixed and does not change. The DCO command may change the value of a fixed field.				O – Support of the word is optional.
V – The contents of the field is variable and may change depending on the state of the device or the commands processed by the device.				S/P – Content applies to Serial or Parallel transport
X – The fixed or variable type of this field is not defined in this standard.				S – Serial Transport
				P – Parallel Transport
				B – Both Serial and Parallel Transports
				N – Belongs to a transport other than Serial or Parallel

Table 29 — IDENTIFY DEVICE data (part 2 of 18)

Word	O M	S P	F V	Description
48	O	B	F F F F	Trusted Computing feature set options 15 Shall be cleared to zero 14 Shall be set to one 13:1 Reserved for the Trusted Computing Group 0 1=Trusted Computing feature set is supported
49	M	B P P B P	F F F F F X	Capabilities 15:14 Reserved for the IDENTIFY PACKET DEVICE command. 13 1 = Standby timer values as specified in this standard are supported 0 = Standby timer values shall be managed by the device 12 Reserved for the IDENTIFY PACKET DEVICE command. 11 1 = IORDY supported 0 = IORDY may be supported 10 1 = IORDY may be disabled 9 Shall be set to one to indicate that LBA is supported. 8 1 = DMA supported 7:0 Retired
50	M	B B X B	F F X F	Capabilities 15 Shall be cleared to zero 14 Shall be set to one 13:2 Reserved 1 Obsolete 0 Shall be set to one to indicate a vendor specific Standby timer value minimum
51-52			X	Obsolete
<p>Key:</p> <p>F/V – Fixed/variable content</p> <p>F – The content of the field is fixed and does not change. The DCO command may change the value of a fixed field.</p> <p>V – The contents of the field is variable and may change depending on the state of the device or the commands processed by the device.</p> <p>X – The fixed or variable type of this field is not defined in this standard.</p> <p>O/M – Mandatory/optional requirement.</p> <p>M – Support of the word is mandatory.</p> <p>O – Support of the word is optional.</p> <p>S/P – Content applies to Serial or Parallel transport</p> <p>S – Serial Transport</p> <p>P – Parallel Transport</p> <p>B – Both Serial and Parallel Transports</p> <p>N – Belongs to a transport other than Serial or Parallel</p>				

Table 29 — IDENTIFY DEVICE data (part 3 of 18)

Word	O M	S P	F V	Description
53	M	B	F	15:8 Free-fall Control Sensitivity 00h = Vendor's recommended setting 01h-FFh = Sensitivity level. A larger number is a more sensitive setting. 7:3 Reserved 2 1 = the fields reported in word 88 are valid 0 = the fields reported in word 88 are not valid 1 1 = the fields reported in words (70:64) are valid 0 = the fields reported in words (70:64) are not valid X 0 Obsolete
54-58			X	Obsolete
59	M	B	V	15:9 Reserved 8 1 = Multiple logical sector setting is valid 7:0 Current setting for number of logical sectors that shall be transferred per DRQ data block on READ/WRITE Multiple commands
60-61	M	B	F	Total number of user addressable logical sectors for 28-bit commands (DWord)
62			X	Obsolete
63	M	P	V	15:11 Reserved 10 1 = Multiword DMA mode 2 is selected 0 = Multiword DMA mode 2 is not selected 9 1 = Multiword DMA mode 1 is selected 0 = Multiword DMA mode 1 is not selected 8 1 = Multiword DMA mode 0 is selected 0 = Multiword DMA mode 0 is not selected 7:3 Reserved 2 1 = Multiword DMA mode 2 and below are supported 1 1 = Multiword DMA mode 1 and below are supported 0 1 = Multiword DMA mode 0 is supported
64	M	P	F	15:8 Reserved 7:0 PIO modes supported
65	M	P	F	Minimum Multiword DMA transfer cycle time per word 15:0 Cycle time in nanoseconds
Key:				O/M – Mandatory/optional requirement.
F/V – Fixed/variable content				M – Support of the word is mandatory.
F – The content of the field is fixed and does not change. The DCO command may change the value of a fixed field.				O – Support of the word is optional.
V – The contents of the field is variable and may change depending on the state of the device or the commands processed by the device.				S/P – Content applies to Serial or Parallel transport
X – The fixed or variable type of this field is not defined in this standard.				S – Serial Transport
				P – Parallel Transport
				B – Both Serial and Parallel Transports
				N – Belongs to a transport other than Serial or Parallel

Table 29 — IDENTIFY DEVICE data (part 4 of 18)

Word	O M	S P	F V	Description
66	M	P	F	Manufacturer's recommended Multiword DMA transfer cycle time 15:0 Cycle time in nanoseconds
67	M	P	F	Minimum PIO transfer cycle time without flow control 15:0 Cycle time in nanoseconds
68	M	P	F	Minimum PIO transfer cycle time with IORDY flow control 15:0 Cycle time in nanoseconds
69-70				Reserved
71-74				Reserved for the IDENTIFY PACKET DEVICE command.
75	O	B	F	Queue depth 15:5 Reserved 4:0 Maximum queue depth - 1
76	O	S	F	Serial ATA Capabilities 15:11 Reserved for Serial ATA 10 1 = Supports Phy Event Counters 9 1 = Supports receipt of host initiated power management requests 8 1 = Supports the NCQ feature set 7:3 Reserved for Serial ATA 2 1 = Supports SATA Gen2 Signaling Speed (3.0Gb/s) 1 1 = Supports SATA Gen1 Signaling Speed (1.5Gb/s) 0 Shall be cleared to zero
77		S		Reserved for Serial ATA
78	O	S	F	Serial ATA features supported 15:7 Reserved for Serial ATA 6 1 = Device supports Software Settings Preservation 5 Reserved for Serial ATA 4 1 = Device supports in-order data delivery 3 1 = Device supports initiating power management 2 1 = Device supports DMA Setup auto-activation 1 1 = Device supports non-zero buffer offsets 0 Shall be cleared to zero
Key:				O/M – Mandatory/optional requirement.
F/V – Fixed/variable content				M – Support of the word is mandatory.
F – The content of the field is fixed and does not change. The DCO command may change the value of a fixed field.				O – Support of the word is optional.
V – The contents of the field is variable and may change depending on the state of the device or the commands processed by the device.				S/P – Content applies to Serial or Parallel transport
X – The fixed or variable type of this field is not defined in this standard.				S – Serial Transport
				P – Parallel Transport
				B – Both Serial and Parallel Transports
				N – Belongs to a transport other than Serial or Parallel

Table 29 — IDENTIFY DEVICE data (part 5 of 18)

Word	O M	S P	F V	Description
79	O	S	V	Serial ATA features enabled 15:7 Reserved for Serial ATA 6 1 = Software Settings Preservation enabled 5 Reserved for Serial ATA 4 1 = In-order data delivery enabled 3 1 = Device initiated power management enabled 2 1 = DMA Setup auto-activation enabled 1 1 = Non-zero buffer offsets enabled 0 Shall be cleared to zero
80	M	B	F	Major version number 15:9 Reserved 8 1 = supports ATA8-ACS 7 1 = supports ATA/ATAPI-7 6 1 = supports ATA/ATAPI-6 5 1 = supports ATA/ATAPI-5 4 1 = supports ATA/ATAPI-4 3 Obsolete 2 Obsolete 1 Obsolete 0 Reserved
81	M	B	F	Minor version number
<p>Key:</p> <p>F/V – Fixed/variable content</p> <p>F – The content of the field is fixed and does not change. The DCO command may change the value of a fixed field.</p> <p>V – The contents of the field is variable and may change depending on the state of the device or the commands processed by the device.</p> <p>X – The fixed or variable type of this field is not defined in this standard.</p> <p>O/M – Mandatory/optional requirement.</p> <p>M – Support of the word is mandatory.</p> <p>O – Support of the word is optional.</p> <p>S/P – Content applies to Serial or Parallel transport</p> <p>S – Serial Transport</p> <p>P – Parallel Transport</p> <p>B – Both Serial and Parallel Transports</p> <p>N – Belongs to a transport other than Serial or Parallel</p>				

Table 29 — IDENTIFY DEVICE data (part 6 of 18)

Word	O M	S P	F V	Description
82	M			Commands and feature sets supported
			X	15 Obsolete
		B	F	14 1 = The NOP command is supported
		B	F	13 1 = The READ BUFFER command is supported
		B	F	12 1 = The WRITE BUFFER command is supported
			X	11 Obsolete
		B	F	10 1 = The HPA feature set is supported
		B	F	9 Shall be cleared to zero to indicate that the DEVICE RESET command is not supported
		B	F	8 1 = The SERVICE interrupt is supported
		B	F	7 1 = The release interrupt is supported
		B	F	6 1 = Read look-ahead is supported
		B	F	5 1 = The volatile write cache is supported
		B	F	4 Shall be cleared to zero to indicate that the PACKET feature set is not supported
		B	F	3 Shall be set to one to indicate that the mandatory Power Management feature set is supported
			X	2 Obsolete
		B	F	1 1 = The Security feature set is supported
		B	F	0 1 = The SMART feature set is supported
<p>Key:</p> <p>F/V – Fixed/variable content</p> <p>F – The content of the field is fixed and does not change. The DCO command may change the value of a fixed field.</p> <p>V – The contents of the field is variable and may change depending on the state of the device or the commands processed by the device.</p> <p>X – The fixed or variable type of this field is not defined in this standard.</p> <p>O/M – Mandatory/optional requirement.</p> <p>M – Support of the word is mandatory.</p> <p>O – Support of the word is optional.</p> <p>S/P – Content applies to Serial or Parallel transport</p> <p>S – Serial Transport</p> <p>P – Parallel Transport</p> <p>B – Both Serial and Parallel Transports</p> <p>N – Belongs to a transport other than Serial or Parallel</p>				

Table 29 — IDENTIFY DEVICE data (part 7 of 18)

Word	O M	S P	F V	Description
83	M			Commands and feature sets supported
			F	15 Shall be cleared to zero
			F	14 Shall be set to one
		B	F	13 1 = The FLUSH CACHE EXT command is supported
		B	F	12 Shall be set to one to indicate that the mandatory FLUSH CACHE command is supported
		B	F	11 1 = The DCO feature set is supported
		B	F	10 1 = The 48-bit Address feature set is supported
		B	F	9 1 = The AAM feature set is supported
		B	F	8 1 = The SET MAX security extension is supported
				7 Reserved for the Address Offset Reserved Area Boot Method
		B	F	6 1 = SET FEATURES subcommand is required to spin-up after power-up
		B	F	5 1 = The PUIS feature set is supported
			X	4 Obsolete
		B	F	3 1 = The APM feature set is supported
		N	F	2 1 = The CFA feature set is supported
		B	F	1 1 = The TCQ feature set is supported
		B	F	0 1 = The DOWNLOAD MICROCODE command is supported
<p>Key:</p> <p>F/V – Fixed/variable content</p> <p>F – The content of the field is fixed and does not change. The DCO command may change the value of a fixed field.</p> <p>V – The contents of the field is variable and may change depending on the state of the device or the commands processed by the device.</p> <p>X – The fixed or variable type of this field is not defined in this standard.</p> <p>O/M – Mandatory/optional requirement.</p> <p>M – Support of the word is mandatory.</p> <p>O – Support of the word is optional.</p> <p>S/P – Content applies to Serial or Parallel transport</p> <p>S – Serial Transport</p> <p>P – Parallel Transport</p> <p>B – Both Serial and Parallel Transports</p> <p>N – Belongs to a transport other than Serial or Parallel</p>				

Table 29 — IDENTIFY DEVICE data (part 8 of 18)

Word	O M	S P	F V	Description
84	M			Commands and feature sets supported
			F	15 Shall be cleared to zero
			F	14 Shall be set to one
		B	F	13 1 = The IDLE IMMEDIATE command with UNLOAD feature is supported
				12 Reserved for TLC
				11 Reserved for TLC
			X	10:9 Obsolete
		B	F	8 1 = The 64-bit World wide name is supported
		B	F	7 1 = The WRITE DMA QUEUED FUA EXT command is supported
		B	F	6 1 = The WRITE DMA FUA EXT and WRITE MULTIPLE FUA EXT commands are supported
		B	F	5 1 = The GPL feature set is supported
		B	F	4 1 = The Streaming feature set is supported
		N	F	3 1 = The Media Card Pass Through Command feature set is supported
		B	F	2 1 = Media serial number is supported
		B	F	1 1 = The SMART self-test is supported
		B	F	0 1 = SMART error logging is supported
Key:				O/M – Mandatory/optional requirement.
F/V – Fixed/variable content				M – Support of the word is mandatory.
F – The content of the field is fixed and does not change. The DCO command may change the value of a fixed field.				O – Support of the word is optional.
V – The contents of the field is variable and may change depending on the state of the device or the commands processed by the device.				S/P – Content applies to Serial or Parallel transport
X – The fixed or variable type of this field is not defined in this standard.				S – Serial Transport
				P – Parallel Transport
				B – Both Serial and Parallel Transports
				N – Belongs to a transport other than Serial or Parallel

Table 29 — IDENTIFY DEVICE data (part 9 of 18)

Word	O M	S P	F V	Description
85	M			Commands and feature sets supported or enabled
			X	15 Obsolete
		B	F	14 1 = The NOP command is supported
		B	F	13 1 = The READ BUFFER command is supported
		B	F	12 1 = The WRITE BUFFER command is supported
			X	11 Obsolete
		B	V	10 1 = HPA feature set is supported
		B	F	9 Shall be cleared to zero to indicate that the DEVICE RESET command is not supported
		B	V	8 1 = The SERVICE interrupt is enabled
		B	V	7 1 = The release interrupt is enabled
		B	V	6 1 = Read look-ahead is enabled
		B	V	5 1 = The volatile write cache is enabled
		B	F	4 Shall be cleared to zero to indicate that the PACKET feature set is not supported
		B	F	3 Shall be set to one to indicate that the mandatory Power Management feature set is supported
			X	2 Obsolete
		B	V	1 1 = The Security feature set is enabled
		B	V	0 1 = The SMART feature set is enabled
<p>Key:</p> <p>F/V – Fixed/variable content</p> <p>F – The content of the field is fixed and does not change. The DCO command may change the value of a fixed field.</p> <p>V – The contents of the field is variable and may change depending on the state of the device or the commands processed by the device.</p> <p>X – The fixed or variable type of this field is not defined in this standard.</p> <p>O/M – Mandatory/optional requirement.</p> <p>M – Support of the word is mandatory.</p> <p>O – Support of the word is optional.</p> <p>S/P – Content applies to Serial or Parallel transport</p> <p>S – Serial Transport</p> <p>P – Parallel Transport</p> <p>B – Both Serial and Parallel Transports</p> <p>N – Belongs to a transport other than Serial or Parallel</p>				

Table 29 — IDENTIFY DEVICE data (part 10 of 18)

Word	O M	S P	F V	Description
86	M			Commands and feature sets supported or enabled
		B	F	15 1 = Words 119-120 are valid
				14 Reserved
		B	F	13 1 = FLUSH CACHE EXT command supported
		B	F	12 1 = FLUSH CACHE command supported
		B	F	11 1 = The DCO feature set is supported
		B	F	10 1 = The 48-bit Address features set is supported
		B	V	9 1 = The AAM feature set is enabled
		B	V	8 1 = the SET MAX security extension is enabled by SET MAX SET PASSWORD
				7 Reserved for Address Offset Reserved Area Boot Method
		B	F	6 1 = SET FEATURES subcommand is required to spin-up after power-up
		B	V	5 1 = The PUIS feature set is enabled
			X	4 Obsolete
		B	V	3 1 = The APM feature set is enabled
		N	F	2 1 = The CFA feature set is supported
		B	F	1 1 = The TCQ feature set is supported
		B	F	0 1 = The DOWNLOAD MICROCODE command is supported
<p>Key:</p> <p>F/V – Fixed/variable content</p> <p>F – The content of the field is fixed and does not change. The DCO command may change the value of a fixed field.</p> <p>V – The contents of the field is variable and may change depending on the state of the device or the commands processed by the device.</p> <p>X – The fixed or variable type of this field is not defined in this standard.</p> <p>O/M – Mandatory/optional requirement.</p> <p>M – Support of the word is mandatory.</p> <p>O – Support of the word is optional.</p> <p>S/P – Content applies to Serial or Parallel transport</p> <p>S – Serial Transport</p> <p>P – Parallel Transport</p> <p>B – Both Serial and Parallel Transports</p> <p>N – Belongs to a transport other than Serial or Parallel</p>				

Table 29 — IDENTIFY DEVICE data (part 11 of 18)

Word	O M	S P	F V	Description
87	M			Commands and feature sets supported or enabled
			F	15 Shall be cleared to zero
			F	14 Shall be set to one
		B	F	13 1 = The IDLE IMMEDIATE command with UNLOAD FEATURE is supported
				12 Reserved for TLC
				11 Reserved for TLC
			X	10:9 Obsolete
		B	F	8 1 = The 64-bit World wide name is supported
		B	F	7 1 = The WRITE DMA QUEUED FUA EXT command is supported
		B	F	6 1 = The WRITE DMA FUA EXT and WRITE MULTIPLE FUA EXT commands are supported
		B	F	5 1 = The GPL feature set is supported
			X	4 Obsolete
		N	V	3 1 = The Media Card Pass Through Command feature set is supported
		B	V	2 1 = Media serial number is valid
		B	F	1 1 = SMART self-test supported
		B	F	0 1 = SMART error logging is supported
<p>Key:</p> <p>F/V – Fixed/variable content</p> <p>F – The content of the field is fixed and does not change. The DCO command may change the value of a fixed field.</p> <p>V – The contents of the field is variable and may change depending on the state of the device or the commands processed by the device.</p> <p>X – The fixed or variable type of this field is not defined in this standard.</p> <p>O/M – Mandatory/optional requirement.</p> <p>M – Support of the word is mandatory.</p> <p>O – Support of the word is optional.</p> <p>S/P – Content applies to Serial or Parallel transport</p> <p>S – Serial Transport</p> <p>P – Parallel Transport</p> <p>B – Both Serial and Parallel Transports</p> <p>N – Belongs to a transport other than Serial or Parallel</p>				

Table 29 — IDENTIFY DEVICE data (part 12 of 18)

Word	O M	S P	F V	Description
88	O			Ultra DMA modes 15 Reserved 14 1 = Ultra DMA mode 6 is selected 0 = Ultra DMA mode 6 is not selected 13 1 = Ultra DMA mode 5 is selected 0 = Ultra DMA mode 5 is not selected 12 1 = Ultra DMA mode 4 is selected 0 = Ultra DMA mode 4 is not selected 11 1 = Ultra DMA mode 3 is selected 0 = Ultra DMA mode 3 is not selected 10 1 = Ultra DMA mode 2 is selected 0 = Ultra DMA mode 2 is not selected 9 1 = Ultra DMA mode 1 is selected 0 = Ultra DMA mode 1 is not selected 8 1 = Ultra DMA mode 0 is selected 0 = Ultra DMA mode 0 is not selected 7 Reserved 6 1 = Ultra DMA mode 6 and below are supported 5 1 = Ultra DMA mode 5 and below are supported 4 1 = Ultra DMA mode 4 and below are supported 3 1 = Ultra DMA mode 3 and below are supported 2 1 = Ultra DMA mode 2 and below are supported 1 1 = Ultra DMA mode 1 and below are supported 0 1 = Ultra DMA mode 0 is supported
89	O	B	F	15:8 Reserved 7:0 Time required for Normal Erase mode SECURITY ERASE UNIT command
90	O	B	F	15:8 Reserved 7:0 Time required for an Enhanced Erase mode SECURITY ERASE UNIT command
Key:				O/M – Mandatory/optional requirement.
F/V – Fixed/variable content				M – Support of the word is mandatory.
F – The content of the field is fixed and does not change. The DCO command may change the value of a fixed field.				O – Support of the word is optional.
V – The contents of the field is variable and may change depending on the state of the device or the commands processed by the device.				S/P – Content applies to Serial or Parallel transport
X – The fixed or variable type of this field is not defined in this standard.				S – Serial Transport
				P – Parallel Transport
				B – Both Serial and Parallel Transports
				N – Belongs to a transport other than Serial or Parallel

Table 29 — IDENTIFY DEVICE data (part 13 of 18)

Word	O M	S P	F V	Description
91	O	B	V	Current APM level value
92	O	B	V	Master Password Identifier
93	M			<p>Hardware reset result. The contents of bits (12:0) of this word shall change only during the execution of a hardware reset. See 7.16.7.45 for more information.</p> <p>15 Shall be cleared to zero.</p> <p>14 Shall be set to one.</p> <p>13 1 = device detected CBLID- above V_{iHB} 0 = device detected CBLID- below V_{iL}.</p> <p>12:8 Device 1 hardware reset result. Device 0 shall clear these bits to zero. Device 1 shall set these bits as follows:</p> <p>12 Reserved.</p> <p>11 0 = Device 1 did not assert PDIAG-. 1 = Device 1 asserted PDIAG-.</p> <p>10:9 These bits indicate how Device 1 determined the device number:</p> <p>00 = Reserved. 01 = a jumper was used. 10 = the CSEL signal was used. 11 = some other method was used or the method is unknown.</p> <p>8 Shall be set to one.</p> <p>7:0 Device 0 hardware reset result. Device 1 shall clear these bits to zero. Device 0 shall set these bits as follows:</p> <p>7 Reserved.</p> <p>6 0 = Device 0 does not respond when Device 1 is selected. 1 = Device 0 responds when Device 1 is selected.</p> <p>5 0 = Device 0 did not detect the assertion of DASP-. 1 = Device 0 detected the assertion of DASP-.</p> <p>4 0 = Device 0 did not detect the assertion of PDIAG-. 1 = Device 0 detected the assertion of PDIAG-.</p> <p>3 0 = Device 0 failed diagnostics. 1 = Device 0 passed diagnostics.</p>
Key:				<p>O/M – Mandatory/optional requirement. M – Support of the word is mandatory. O – Support of the word is optional. S/P – Content applies to Serial or Parallel transport S – Serial Transport P – Parallel Transport B – Both Serial and Parallel Transports N – Belongs to a transport other than Serial or Parallel</p>
F/V – Fixed/variable content				
F – The content of the field is fixed and does not change. The DCO command may change the value of a fixed field.				
V – The contents of the field is variable and may change depending on the state of the device or the commands processed by the device.				
X – The fixed or variable type of this field is not defined in this standard.				

Table 29 — IDENTIFY DEVICE data (part 14 of 18)

Word	O M	S P	F V	Description
93			V F	2:1 These bits indicate how Device 0 determined the device number: 00 = Reserved. 01 = a jumper was used. 10 = the CSEL signal was used. 11 = some other method was used or the method is unknown. 0 Shall be set to one.
94	O	B B	F V	Current AAM value 15:8 Vendor's recommended AAM value. 7:0 Current AAM value.
95	O	B	F	Stream Minimum Request Size
96	O	B	V	Streaming Transfer Time - DMA
97	O	B	V	Streaming Access Latency - DMA and PIO
98-99	O	B	F	Streaming Performance Granularity (DWord)
100-103	O	B	V	Total Number of User Addressable Logical Sectors for 48-bit commands (QWord)
104	O	B	V	Streaming Transfer Time - PIO
105				Reserved
106	O	B B B B B	F F F F F	Physical sector size / logical sector size 15 Shall be cleared to zero 14 Shall be set to one 13 1 = Device has multiple logical sectors per physical sector. 12 1 = Device Logical Sector longer than 256 Words 11:4 Reserved 3:0 2 ^X logical sectors per physical sector
107	O	B	F	Inter-seek delay for ISO 7779 standard acoustic testing
108-111	M	B	F	World wide name
112-115				Reserved
116				Reserved for TLC
117-118	O	B	F	Logical sector size (DWord)
Key:				O/M – Mandatory/optional requirement.
F/V – Fixed/variable content				M – Support of the word is mandatory.
F – The content of the field is fixed and does not change. The DCO command may change the value of a fixed field.				O – Support of the word is optional.
V – The contents of the field is variable and may change depending on the state of the device or the commands processed by the device.				S/P – Content applies to Serial or Parallel transport
X – The fixed or variable type of this field is not defined in this standard.				S – Serial Transport
				P – Parallel Transport
				B – Both Serial and Parallel Transports
				N – Belongs to a transport other than Serial or Parallel

Table 29 — IDENTIFY DEVICE data (part 15 of 18)

Word	O M	S P	F V	Description
119	M			Commands and feature sets supported (Continued from words 84:82) F 15 Shall be cleared to zero F 14 Shall be set to one 13:6 Reserved B F 5 1 = The Free-fall Control feature set is supported B F 4 1 = The DOWNLOAD MICROCODE command with mode 3 is supported B F 3 1 = The READ LOG DMA EXT and WRITE LOG DMA EXT commands are supported B F 2 1 = The WRITE UNCORRECTABLE EXT command is supported B F 1 1 = The Write-Read-Verify feature set is supported 0 Reserved for DDT
120	M			Commands and feature sets supported or enabled (Continued from words 87:85) F 15 Shall be cleared to zero F 14 Shall be set to one 13:6 Reserved B V 5 1 = The Free-fall Control feature set is enabled B F 4 1 = The DOWNLOAD MICROCODE command with mode 3 is supported B F 3 1 = The READ LOG DMA EXT and WRITE LOG DMA EXT commands are supported B F 2 1 = The WRITE UNCORRECTABLE EXT command is supported B V 1 1 = The Write-Read-Verify feature set is enabled 0 Reserved for DDT
121-126				Reserved for expanded supported and enabled settings
127			X	Obsolete
Key: F/V – Fixed/variable content F – The content of the field is fixed and does not change. The DCO command may change the value of a fixed field. V – The contents of the field is variable and may change depending on the state of the device or the commands processed by the device. X – The fixed or variable type of this field is not defined in this standard. O/M – Mandatory/optional requirement. M – Support of the word is mandatory. O – Support of the word is optional. S/P – Content applies to Serial or Parallel transport S – Serial Transport P – Parallel Transport B – Both Serial and Parallel Transports N – Belongs to a transport other than Serial or Parallel				

Table 29 — IDENTIFY DEVICE data (part 16 of 18)

Word	O M	S P	F V	Description
128	O			Security status 15:9 Reserved 8 Mater Password Capability: 0 = High, 1 = Maximum 7:6 Reserved 5 1 = Enhanced security erase supported 4 1 = Security count expired 3 1 = Security frozen 2 1 = Security locked 1 1 = Security enabled 0 1 = Security supported
129-159			X	Vendor specific
160	O	N		CFA power mode 15 Word 160 supported 14 Reserved 13 CFA power mode 1 is required for one or more commands implemented by the device 12 CFA power mode 1 disabled 11:0 Maximum current in ma
161-167				Reserved for the CompactFlash Association
168	O	B	F	15:4 Reserved 3:0 Device Nominal Form Factor
169-175				Reserved
176-205	O	B	V	Current media serial number (ATA string)
Key: F/V – Fixed/variable content F – The content of the field is fixed and does not change. The DCO command may change the value of a fixed field. V – The contents of the field is variable and may change depending on the state of the device or the commands processed by the device. X – The fixed or variable type of this field is not defined in this standard. O/M – Mandatory/optional requirement. M – Support of the word is mandatory. O – Support of the word is optional. S/P – Content applies to Serial or Parallel transport S – Serial Transport P – Parallel Transport B – Both Serial and Parallel Transports N – Belongs to a transport other than Serial or Parallel				

Table 29 — IDENTIFY DEVICE data (part 17 of 18)

Word	O M	S P	F V	Description
206	O	B	X F F F F F F	SCT Command Transport 15:12 Vendor Specific 11:6 Reserved 5 The SCT Data Tables command is supported 4 The SCT Feature Control command is supported 3 The SCT Error Recovery Control command is supported 2 The SCT Write Same command is supported 1 The SCT Read/Write Long command is supported 0 The SCT Command Transport is supported
207-208		N		Reserved for CE-ATA.
209	O	B	F	Alignment of logical blocks within a physical block 15 Shall be cleared to zero 14 Shall be set to one 13:0 Logical sector offset within the first physical sector where the first logical sector is placed
210-211	O	B	V	Write-Read-Verify Sector Count Mode 3 (DWord)
212-213	O	B	F	Write-Read-Verify Sector Count Mode 2 (DWord)
214	O	B	F F V V F	NV Cache Capabilities 15:12 NV Cache feature set version 11:8 NV Cache Power Mode feature set version 7:5 Reserved 4 1 = NV Cache feature set enabled 3:2 Reserved 1 1 = NV Cache Power Mode feature set enabled 0 1 = NV Cache Power Mode feature set supported
215-216	O	B	V	NV Cache Size in Logical Blocks (DWord)
217	M	B	F	Nominal media rotation rate
218				Reserved
219	O	B	F	NV Cache Options 15:8 Reserved 7:0 Device Estimated Time to Spin Up in Seconds
Key:				O/M – Mandatory/optional requirement.
F/V – Fixed/variable content				M – Support of the word is mandatory.
F – The content of the field is fixed and does not change. The DCO command may change the value of a fixed field.				O – Support of the word is optional.
V – The contents of the field is variable and may change depending on the state of the device or the commands processed by the device.				S/P – Content applies to Serial or Parallel transport
X – The fixed or variable type of this field is not defined in this standard.				S – Serial Transport
				P – Parallel Transport
				B – Both Serial and Parallel Transports
				N – Belongs to a transport other than Serial or Parallel

Table 29 — IDENTIFY DEVICE data (part 18 of 18)

Word	O M	S P	F V	Description
220	O	B	V	15:8 Reserved 7:0 Write-Read-Verify feature set current mode
221				Reserved
222	M	B	F	Transport major version number. 0000h or FFFFh = device does not report version 15:12 Transport Type 0h = Parallel 1h = Serial 2h-Fh = Reserved Parallel 11:5 Reserved 4 Reserved 3 Reserved 2 Reserved 1 ATA/ATAPI-7 0 ATA8-APT Serial Reserved SATA Rev 2.6 SATA Rev 2.5 SATA II: Extensions SATA 1.0a ATA8-AST
223	M	B	F	Transport minor version number
224-233		N		Reserved for CE-ATA
234	O	B	F	Minimum number of 512-byte data blocks per DOWNLOAD MICROCODE command for mode 03h
235	O	B	F	Maximum number of 512-byte data blocks per DOWNLOAD MICROCODE command for mode 03h
236-254				Reserved
255	M	B	V	Integrity word 15:8 Checksum 7:0 Checksum Validity Indicator
<p>Key:</p> <p>F/V – Fixed/variable content</p> <p>F – The content of the field is fixed and does not change. The DCO command may change the value of a fixed field.</p> <p>V – The contents of the field is variable and may change depending on the state of the device or the commands processed by the device.</p> <p>X – The fixed or variable type of this field is not defined in this standard.</p> <p>O/M – Mandatory/optional requirement.</p> <p>M – Support of the word is mandatory.</p> <p>O – Support of the word is optional.</p> <p>S/P – Content applies to Serial or Parallel transport</p> <p>S – Serial Transport</p> <p>P – Parallel Transport</p> <p>B – Both Serial and Parallel Transports</p> <p>N – Belongs to a transport other than Serial or Parallel</p>				

7.16.7.2 Word 0: General configuration

If the device is an ATA device, then bit 15 shall be cleared to zero.

Bits (7:6) are obsolete.

If bit 2 of word 0 is set to one, then the content of the IDENTIFY DEVICE data is incomplete. This may occur if the device supports the Power-up in Standby feature set and required data is contained on the device media. The content of IDENTIFY DEVICE data word 0 and word 2 shall be valid.

Devices supporting the CFA feature set shall place the value 848Ah in word 0. In this case, the above definitions for the bits in word 0 are not valid.

7.16.7.3 Word 1: Obsolete

7.16.7.4 Word 2: Specific configuration

Word 2 shall be set as defined in table 30.

Table 30 — Specific Configuration

Value	Description
37C8h	Device requires SET FEATURES subcommand to spin-up after power-up and IDENTIFY DEVICE data is incomplete (see 4.19).
738Ch	Device requires SET FEATURES subcommand to spin-up after power-up and IDENTIFY DEVICE data is complete (see 4.19).
8C73h	Device does not require SET FEATURES subcommand to spin-up after power-up and IDENTIFY DEVICE data is incomplete (see 4.19).
C837h	Device does not require SET FEATURES subcommand to spin-up after power-up and IDENTIFY DEVICE data is complete (see 4.19).
All other values	Reserved.

7.16.7.5 Word 3: Obsolete

7.16.7.6 Words 4-5: Retired

7.16.7.7 Word 6: Obsolete

7.16.7.8 Words 7-8: Reserved for assignment by the CompactFlash Association

7.16.7.9 Word 9: Retired

7.16.7.10 Words 10-19: Serial number

This field contains the serial number of the device. The contents of this field is an ATA string of twenty bytes in the format defined by 3.2.9. The device shall pad the string with spaces (i.e., 20h), if necessary, to ensure that the string is the proper length. The combination of Serial number (i.e., words 10-19) and Model number (i.e., words 27-46) shall be unique for a given manufacturer.

7.16.7.11 Words 20-21: Retired

7.16.7.12 Word 22: Obsolete

7.16.7.13 Words 23-26: Firmware revision

This field contains the firmware revision of the device. The contents of this field is an ATA string of eight bytes in the format defined by 3.2.9. The device shall pad the string with spaces (20h), if necessary, to ensure that the string is the proper length.

7.16.7.14 Words 27-46: Model number

This field contains the model number of the device. The contents of this field is an ATA string of forty bytes in the format defined by 3.2.9. The device shall pad the string with spaces (i.e., 20h), if necessary, to ensure that the string is the proper length. The combination of Serial number (i.e., words 10-19) and Model number (i.e., words 27-46) shall be unique for a given manufacturer.

7.16.7.15 Word 47

Bits (7:0) of this word define the maximum number of logical sectors per DRQ data block that the device supports for READ/WRITE MULTIPLE commands.

For SATA devices, bits (7:0) shall be set to 16 or less.

7.16.7.16 Word 48: Trusted Computing feature set options

If bit 0 of word 48 is set to one, then the Trusted Computing feature set is supported.

7.16.7.17 Words 49-50: Capabilities

Bits (15:14) of word 49 are reserved for use in the IDENTIFY PACKET DEVICE data.

If bit 13 of word 49 is set to one, then table 40 shall define the Standby timer values used by the device. If bit 13 of word 49 is cleared to zero, then the timer values used by the device shall be vendor specific.

Bit 12 of word 49 is reserved for use in the IDENTIFY PACKET DEVICE data.

For PATA devices, if bit 11 of word 49 is set to one, then the device supports the IORDY signal (see ATA8-APT). All PATA devices, except CFA devices, shall set bit 11 of word 49 to one.

For SATA devices, bit 11 of word 49 shall be set to one.

For PATA devices, if bit 10 of word 49 is set to one, then the device supports the disabling of IORDY via the SET FEATURES command.

For SATA devices, bit 10 of word 49 shall be set to one.

Bit 9 of word 49 shall be set to one to indicate that LBA is supported.

If bit 8 of word 49 is set to one, then the device supports the DMA data transfer protocols. All devices, except CFA devices, shall set this bit to one.

Bits (7:0) of word 49 are retired.

Bit 15 of word 50 shall be cleared to zero.

Bit 14 of word 50 shall be set to one.

Bits (13:2) of word 50 are reserved.

Bit 1 of word 50 is obsolete.

If bit 0 of word 50 is set to one, then the device has a minimum Standby timer value that is vendor specific.

7.16.7.18 Words 51-52: Obsolete

7.16.7.19 Word 53

Bit 0 of word 53 is obsolete.

For PATA devices when bit 1 of word 53 is set to one, the values reported in words 64-70 are valid. If this bit is cleared to zero, the values reported in words 64-70 are not valid. All devices except CFA devices shall support PIO mode 3 or above and shall set bit 1 of word 53 to one and support the fields contained in words 64-70.

For SATA devices, bit 1 of word 53 shall be set to one.

For PATA devices, if the device supports Ultra DMA and the values reported in word 88 are valid, then bit 2 of word 53 shall be set to one. If the device does not support Ultra DMA and the values reported in word 88 are not valid, then this bit shall be cleared to zero.

For SATA devices, bit 2 of word 53 shall be set to one.

7.16.7.20 Words 54-58: Obsolete

7.16.7.21 Word 59

If bit 8 is set to one, then bits (7:0) indicate the number of logical sectors that shall be transferred per DRQ data block for a READ MULTIPLE command or a WRITE MULTIPLE command. This default setting of this field is the optimum value for the device (see 7.51).

7.16.7.22 Words 60-61: Total number of user addressable logical sectors for 28-bit commands

This field contains a value that is one greater than the maximum user addressable LBA. The maximum value that shall be placed in this field is 0FFF_FFFFh. If this field contains 0FFF_FFFFh and the device has user

addressable LBAs greater than or equal to 0FFF_FFFFh then words 100-103 contain the total number of user addressable LBAs (see 4.11.4).

7.16.7.23 Word 62: Obsolete

7.16.7.24 Word 63

Word 63 identifies the Multiword DMA transfer modes supported by the device and indicates the mode that is currently selected. Only one DMA mode shall be selected at any given time. If an Ultra DMA mode is enabled, then no Multiword DMA mode shall be enabled. If a Multiword DMA mode is enabled then no Ultra DMA mode shall be enabled.

Bits (15:11) of word 63 are reserved.

If bit 10 of word 63 is set to one, then Multiword DMA mode 2 is selected. If this bit is cleared to zero, then Multiword DMA mode 2 is not selected. If bit 9 is set to one or if bit 8 is set to one, then this bit shall be cleared to zero.

If bit 9 of word 63 is set to one, then Multiword DMA mode 1 is selected. If this bit is cleared to zero then Multiword DMA mode 1 is not selected. If bit 10 is set to one or if bit 8 is set to one, then this bit shall be cleared to zero.

If bit 8 of word 63 is set to one, then Multiword DMA mode 0 is selected. If this bit is cleared to zero then Multiword DMA mode 0 is not selected. If bit 10 is set to one or if bit 9 is set to one, then this bit shall be cleared to zero.

Bits (7:3) of word 63 are reserved.

For PATA devices, if bit 2 of word 63 is:

- a) set to one, then Multiword DMA modes 2 and below are supported (i.e., if Multiword DMA mode 2 is supported, then Multiword DMA modes 1 and 0 shall be supported);
- b) cleared to zero, then Multiword DMA mode 2 is not supported; and
- c) set to one, then bit 0 and bit 1 of word 63 shall be set to one.

For SATA devices, bit 2 of word 63 shall be set to one.

For PATA devices, if bit 1 of word 63 is:

- a) set to one, then Multiword DMA modes 1 and below are supported (i.e., if Multiword DMA mode 1 is supported, then Multiword DMA mode 0 shall also be supported);
- b) cleared to zero, then Multiword DMA mode 1 is not supported; and
- c) set to one, then bit 0 shall be set to one.

For SATA devices, bit 1 of word 63 shall be set to one.

For PATA devices, if bit 0 of word 63 is set to one, then Multiword DMA mode 0 is supported.

For SATA devices, bit 0 of word 63 shall be set to one.

7.16.7.25 Word 64

For PATA devices bits (7:0) of word 64 is defined as the PIO data and register transfer supported field. If word 64 is supported, bit 1 of word 53 shall be set to one. This field is bit significant. Any number of bits may be set to one in this field by the device to indicate the PIO modes the device is capable of supporting.

Of these bits, bits (7:2) are reserved for future PIO modes. Bit 0, if set to one, indicates that the device supports PIO mode 3. All devices except CFA devices shall support PIO mode 3 and shall set bit 0 to one. Bit 1, if set to one, indicates that the device supports PIO mode 4. See ATA8-APT for more information.

For SATA devices bits (1:0) shall be set to one.

7.16.7.26 Word 65: Minimum Multiword DMA transfer cycle time per word

For PATA devices word 65 is defined as the minimum Multiword DMA transfer cycle time per word. This field defines, in nanoseconds, the minimum cycle time that the device supports when performing Multiword DMA transfers on a per word basis.

For SATA devices word 65 shall be set to indicate 120ns.

If word 65 is supported, bit 1 of word 53 shall be set to one. Any device that supports Multiword DMA mode 1 or above shall support this field, and the value in word 65 shall not be less than the minimum cycle time for the fastest DMA mode supported by the device.

If bit 1 of word 53 is set to one because a device supports a field in words 64-70 other than this field and the device does not support this field, the device shall return a value of zero in this field.

7.16.7.27 Word 66: Device recommended Multiword DMA transfer cycle time

For PATA devices:

- a) word 66 contains the Multiword DMA transfer cycle time recommended by the device in ns (i.e., the minimum cycle time per word during a single logical sector host transfer while performing a multiple logical sector READ DMA or WRITE DMA command for any location on the media under nominal conditions);
- b) if this field is supported, then bit 1 of word 53 shall be set to one;
- c) any device that supports Multiword DMA mode 1 or above shall support this field;
- d) the value in word 66 shall not be less than the value in word 65;
- e) if bit 1 of word 53 is set to one because a device supports a field in words 64-70 other than this field, and the device does not support word 66, then the device shall return a value of zero in word 66; and
- f) if a host runs at a faster cycle rate by operating at a cycle time of less than this value, then the device may negate DMARQ for flow control. The rate at which DMARQ is negated may result in reduced throughput despite the faster cycle rate. Transfer at this rate does not ensure that flow control is not used, but implies that higher performance may result (see ATA8-APT).

For SATA devices, word 66 shall be set to 78h to indicate 120 ns.

7.16.7.28 Word 67: Minimum PIO transfer cycle time without IORDY flow control

For PATA devices word 67 is defined as the minimum PIO transfer without IORDY flow control cycle time. This field defines, in nanoseconds, the minimum cycle time that, if used by the host, the device guarantees data integrity during the transfer without utilization of IORDY flow control.

For SATA devices word 67 shall be set to indicate 120ns.

If word 67 is supported, bit 1 of word 53 shall be set to one.

Any device that supports PIO mode 3 or above shall support this field, and the value in word 67 shall not be less than the value reported in word 68.

If bit 1 of word 53 is set to one because a device supports a field in words 64-70 other than this field and the device does not support this field, the device shall return a value of zero in this field.

7.16.7.29 Word 68: Minimum PIO transfer cycle time with IORDY flow control

For PATA devices word 68 is defined as the minimum PIO transfer with IORDY flow control cycle time. This field defines, in nanoseconds, the minimum cycle time that the device supports while performing data transfers while utilizing IORDY flow control.

For SATA devices word 68 shall be set to indicate 120ns.

If word 68 is supported, bit 1 of word 53 shall be set to one.

All devices except CFA devices shall support PIO mode 3 and shall support this field, and the value in word 68 shall be the fastest defined PIO mode supported by the device. The maximum value reported in this field shall be 180 to indicate support for PIO mode 3 or above.

If bit 1 of word 53 is set to one because a device supports a field in words 64-70 other than this field and the device does not support this field, the device shall return a value of zero in this field.

7.16.7.30 Words 69-74: Reserved**7.16.7.31 Word 75: Queue depth**

Bits (4:0) of word 75 indicate the maximum queue depth supported by the device. The queue depth includes all commands for which command acceptance has occurred and command completion has not occurred. The value in this field equals (maximum queue depth - 1) (e.g., a value of zero indicates a queue depth of one, and a value of 31 indicates a queue depth of 32). If bit 1 of word 83 is cleared to zero indicating that the device does not support TCQ feature set commands, or if bit 6 of word 76 is cleared to zero indicating that the device does not support NCQ feature set commands, the value in this field shall be zero. Support of this word is mandatory if the TCQ or NCQ feature sets are supported.

7.16.7.32 Word 76: Serial ATA Capabilities

Word 76 indicates the capabilities of a SATA device. A PATA device shall set word 76 to 0000h or FFFFh. If word 76 is set to 0000h or FFFFh, then the device does not claim compliance with the Serial ATA specification and words 76 through 79 are not valid and shall be ignored.

If word 76 is not set to 0000h or FFFFh, then the device claims compliance with the Serial ATA specification, and words 77 through 79 shall be valid.

Bits (15:11) of word 76 are reserved for Serial ATA.

If bit 10 of word 76 is set to one, then the device supports the SATA Phy Event Counters log (see A.12).

If bit 9 of word 76 is set to one, then the device supports Partial and Slumber interface power management states when initiated by the host (see SATA 2.6).

If bit 8 of word 76 is set to one, then the device supports the NCQ feature set.

Bits (7:3) of word 76 are reserved for Serial ATA.

If bit 2 of word 76 is set to one, then the device supports the Gen2 signaling rate of 3.0 Gb/s (see SATA 2.6).

If bit 1 of word 76 is set to one, then the device supports the Gen1 signaling rate of 1.5 Gb/s (see SATA 2.6).

Bit 0 of word 76 shall be cleared to zero.

7.16.7.33 Word 77: Reserved for Serial ATA

Word 77 is reserved for future Serial ATA definition and shall be cleared to zero.

7.16.7.34 Word 78: Serial ATA features supported

If Word 76 is not 0000h or FFFFh, Word 78 reports the optional features supported by the device. Support for this word is optional and if not supported the word shall be zero.

Bits (15:7) are reserved for Serial ATA.

If bit 6 is set to one, then the device supports the SSP feature set (see 4.22).

Bit 5 is reserved for Serial ATA.

If bit 4 is set to one the device supports guaranteed in-order data delivery when non-zero buffer offsets are used for commands in the NCQ feature set. See SATA 2.6 for more information.

If bit 3 is set to one the device supports device initiated power management requests. If bit 3 is cleared to zero the device does not support device initiated power management requests. A device may support reception of power management requests initiated by the host as described in the definition of bit 9 of Word 76 without supporting initiating such power management requests as indicated by this bit.

If bit 2 is set to one the device supports the use of the DMA Setup FIS Auto-Activate optimization. See SATA 2.6 for more information.

If bit 1 is set to one the device supports the use of non-zero buffer offsets for commands in the NCQ feature set. See SATA 2.6 for more information.

Bit 0 shall be cleared to zero.

7.16.7.35 Word 79: Serial ATA features enabled

If Word 76 is not 0000h or FFFFh, Word 79 reports which optional features supported by the device are enabled. This word shall be supported if optional Word 78 is supported and shall not be supported if optional Word 78 is not supported.

Bits (15:7) are reserved for Serial ATA.

If bit 6 is set to one then the SSP feature set is enabled. If the device supports the SSP feature set, then this field shall be one after a power on reset has been processed. If the device does not support the SSP feature set, then this field shall be zero by default.

Bit 5 is reserved for Serial ATA.

If bit 4 is set to one then device support for guaranteed in-order data delivery when non-zero buffer offsets are used for commands in the NCQ feature set is enabled. See SATA 2.6 for more information.

If bit 3 is set to one then device support for initiating power management requests to the host is enabled. When set to one the device may initiate power management transition requests. When cleared to zero the device shall not initiate interface power management requests to the host. This field shall be zero by default.

If bit 2 is set to one then the device support for use of the DMA Setup FIS Auto-Activate optimization is enabled. See SATA 2.6 for more information.

If bit 1 is set to one then device support for the use of non-zero buffer offsets for commands in the NCQ feature set is enabled. See SATA 2.6 for more information.

Bit 0 shall be cleared to zero.

7.16.7.36 Word 80: Major version number

If word 80 is not set to 0000h or FFFFh, then the device claims compliance with the major version(s) as indicated by bits (8:4) being set to one. Values other than 0000h and FFFFh are bit significant. Since ATA standards maintain downward compatibility, a device may set more than one bit.

7.16.7.37 Word 81: Minor version number

Table 31 defines the value that shall be reported in word 81 to indicate the version of the standard that guided the implementation.

Table 31 — Minor version number (part 1 of 2)

Value	Minor Version
0000h	Minor version is not reported
0001h	Obsolete
0002h	Obsolete
0003h	Obsolete
0004h	Obsolete
0005h	Obsolete
0006h	Obsolete
0007h	Obsolete
0008h	Obsolete
0009h	Obsolete
000Ah	Obsolete
000Bh	Obsolete
000Ch	Obsolete
000Dh	ATA/ATAPI-4 X3T13 1153D version 6
000Eh	ATA/ATAPI-4 T13 1153D version 13
000Fh	ATA/ATAPI-4 X3T13 1153D version 7
0010h	ATA/ATAPI-4 T13 1153D version 18
0011h	ATA/ATAPI-4 T13 1153D version 15
0012h	ATA/ATAPI-4 published, ANSI INCITS 317-1998
0013h	ATA/ATAPI-5 T13 1321D version 3
0014h	ATA/ATAPI-4 T13 1153D version 14
0015h	ATA/ATAPI-5 T13 1321D version 1
0016h	ATA/ATAPI-5 published, ANSI INCITS 340-2000
0017h	ATA/ATAPI-4 T13 1153D version 17
0018h	ATA/ATAPI-6 T13 1410D version 0
0019h	ATA/ATAPI-6 T13 1410D version 3a
001Ah	ATA/ATAPI-7 T13 1532D version 1
001Bh	ATA/ATAPI-6 T13 1410D version 2
001Ch	ATA/ATAPI-6 T13 1410D version 1
001Dh	ATA/ATAPI-7 published ANSI INCITS 397-2005.
001Eh	ATA/ATAPI-7 T13 1532D version 0

Table 31 — Minor version number (part 2 of 2)

Value	Minor Version
001Fh	Reserved
0020h	Reserved
0021h	ATA/ATAPI-7 T13 1532D version 4a
0022h	ATA/ATAPI-6 published, ANSI INCITS 361-2002
0023h-0026h	Reserved
0027h	ATA8-ACS version 3c
0028h	ATA8-ACS version 6
0029h	ATA8-ACS version 4
30h-32h	Reserved
0033h	ATA8-ACS version 3e
0034h-0038h	Reserved
0039h	ATA8-ACS version 4c
0040h-0041h	Reserved
0042h	ATA8-ACS version 3f
0043h-0051h	Reserved
0052h	ATA8-ACS version 3b
0053h-0106h	Reserved
0107h	ATA8-ACS version 2d
0108h-FFFEh	Reserved
FFFFh	Minor version is not reported

7.16.7.38 Words 82-84, 119: Commands and feature sets supported

Words 82-84 and 119 shall indicate features/command sets supported. If a defined bit is cleared to zero, the indicated features/command set is not supported. If bit 14 of word 83 is set to one and bit 15 of word 83 is cleared to zero, the contents of words 82-83 contain valid support information. If not, support information is not valid in these words. If bit 14 of word 84 is set to one and bit 15 of word 84 is cleared to zero, the contents of word 84 contains valid support information. If not, support information is not valid in this word. If bit 14 of word 119 is set to one and bit 15 of word 119 is cleared to zero, the contents of word 119 contains valid support information. If not, support information is not valid in word 119.

Bit 15 of word 82 is obsolete.

If bit 14 of word 82 is set to one, then the NOP command (see 7.21) is supported.

If bit 13 of word 82 is set to one, then the READ BUFFER command is supported.

If bit 12 of word 82 is set to one, then the WRITE BUFFER command is supported.

Bit 11 of word 82 is obsolete.

If bit 10 of word 82 is set to one, then the HPA feature set is supported.

Bit 9 shall be cleared to zero to indicate that the DEVICE RESET command is not supported.

If bit 8 of word 82 is set to one, then the SERVICE interrupt is supported (see 7.48.15).

If bit 7 of word 82 is set to one, then the release interrupt is supported.

If bit 6 of word 82 is set to one, then read look-ahead is supported.

If bit 5 of word 82 is set to one, then volatile write cache is supported.

Bit 4 of word 82 shall be cleared to zero to indicate that this is not an ATAPI device.

If bit 3 of word 82 is set to one, then the Power Management feature set is supported.

Bit 2 of word 82 is obsolete.

If bit 1 of word 82 is set to one, then the Security feature set is supported.

If bit 0 of word 82 is set to one, then the SMART feature set is supported.

If bit 13 of word 83 is set to one, then the FLUSH CACHE EXT command is supported.

Bit 12 of word 83 shall be set to one indicating the device supports the mandatory FLUSH CACHE command.

If bit 11 of word 83 is set to one, then the DCO feature set is supported.

If bit 10 of word 83 is set to one, then the 48-bit Address feature set is supported.

If bit 9 of word 83 is set to one, then the AAM feature set is supported.

If bit 8 of word 83 is set to one, then the HPA Security Extensions (see 4.11.2) are supported.

Bit 7 of word 83 is reserved for Address Offset Reserved Area Boot Method

If bit 6 of word 83 is set to one, then the device requires the SET FEATURES subcommand to spin-up after power-up if the PUIS feature set is enabled (see 7.48.8).

If bit 5 of word 83 is set to one, then the PUIS feature set is supported.

Bit 4 of word 83 is obsolete.

If bit 3 of word 83 is set to one, then the APM feature set is supported.

If bit 2 of word 83 is set to one, then the CFA feature set is supported.

If bit 1 of word 83 is set to one, then the TCQ feature set is supported.

If bit 0 of word 83 is set to one, then the DOWNLOAD MICROCODE command is supported.

If bit 13 of word 84 is set to one, then the IDLE IMMEDIATE command with unload feature is supported.

Bit 12 of word 84 is reserved for TLC.

Bit 11 of word 84 is reserved for TLC.

Bits (10:9) are Obsolete

Bit 8 of word 84 shall be set to one indicating the mandatory World Wide Name in words 108-111 is supported.

If bit 7 of word 84 is set to one, then the WRITE DMA QUEUED FUA EXT command is supported.

If bit 10 of word 83 is set to one, then bit 6 of word 84 shall be set to one to indicate that the WRITE DMA FUA EXT command and WRITE MULTIPLE FUA EXT command are supported. If bit 10 of word 83 is cleared to zero, then bit 6 of word 84 shall be cleared to zero.

If bit 5 of word 84 is set to one, then the GPL feature set is supported.

If bit 4 of word 84 is set to one, then the Streaming feature set is supported.

If bit 3 of word 84 is set to one, then the Media Card Pass Through Command feature set is supported.

If bit 2 of word 84 is set to one, then the media serial number field in words 176-205 is supported.

If bit 1 of word 84 is set to one, SMART self-test is supported. This bit is valid if bit 0 of word 82 is set to one indicating that the SMART feature set is supported.

If bit 0 of word 84 is set to one, SMART error logging is supported. This bit is valid if bit 0 of word 82 is set to one indicating that the SMART feature set is supported.

Bits (13:6) of word 119 are reserved.

If bit 5 of word 119 is set to one, then the Free-fall Control feature set is supported.

If bit 4 of word 119 is set to one, then the DOWNLOAD MICROCODE command requesting the offset transfer method is supported.

If bit 3 of word 119 is set to one, then the READ LOG DMA EXT and WRITE LOG DMA EXT commands are supported. This bit shall only be set to one if word 84 bit 5 is set to one.

If bit 2 of word 119 is set to one, then the WRITE UNCORRECTABLE EXT command is supported.

If bit 1 of word 119 is set to one, then the Write-Read-Verify feature set is supported.

Bit 0 of word 119 is reserved for DDT.

7.16.7.39 Words 85-87, 120: Commands and feature sets supported or enabled

Words 85-87 and 120 shall indicate features/command sets enabled. If a defined bit is cleared to zero, the indicated features/command set is not enabled. If a supported feature or feature set is supported and there is no defined method to disable the feature or feature set, it is defined as supported and the bit shall be set to one. If bit 14 of word 87 is set to one and bit 15 of word 87 is cleared to zero, the contents of words 85-87 contain valid information. If bit 14 of word 120 is set to one and bit 15 of word 120 is cleared to zero, the contents of word 120 contain valid information. If not, information is not valid in these words.

NOTE 12 — Some features do not have a method to be disabled. These features are marked as “supported” in this subclause for symmetry.

Bit 14 of word 85 is a copy of bit 14 of word 82.

Bit 13 of word 85 is a copy of bit 13 of word 82.

Bit 12 of word 85 is a copy of bit 12 of word 82.

Bit 10 of word 85 is a copy of bit 10 of word 82.

Bit 9 of word 85 shall be cleared to zero to indicate that the DEVICE RESET command is not supported.

If bit 8 of word 85 is set to one, then the SERVICE interrupt is enabled (see 7.48.15). If bit 8 of word 85 is cleared to zero, then the SERVICE interrupt is disabled. This bit is valid if bit 8 of word 82 is set to one indicating that the service interrupt is supported.

If bit 7 of word 85 is set to one, then the release interrupt is enabled (see 7.48.14). If bit 7 of word 85 is cleared to zero, then the release interrupt is disabled. This bit is valid if bit 7 of word 82 is set to one indicating that the release interrupt is supported.

If bit 6 of word 85 is set to one, then read look-ahead is enabled (see 7.48.13). If bit 6 of word 85 is cleared to zero, then read look-ahead is disabled. This bit is valid if bit 6 of word 82 is set to one indicating read look-ahead is supported.

If bit 5 of word 85 is set to one, then volatile write cache is enabled (see 7.48.4). If bit 5 of word 85 is cleared to zero, then volatile write cache is disabled. This bit is valid if bit 5 of word 82 is set to one indicating write cache is supported.

Bit 4 of word 85 is a copy of bit 4 of word 82.

Bit 3 of word 85 is a copy of bit 3 of word 82.

If bit 1 of word 85 is set to one, then Security has been enabled by setting a User password via the SECURITY SET PASSWORD command. If bit 1 of word 85 is cleared to zero, then there is no valid User password. If the Security feature set is not supported, this bit shall be cleared to zero. This bit is valid if bit 1 of word 82 is set to one indicating Security Mode feature set is supported.

If bit 0 of word 85 is set to one, then the SMART feature set is enabled (see 7.53.4). If bit 0 of word 85 is cleared to zero, then the SMART feature set is disabled (see 7.53.2). This bit is valid if bit 0 of word 82 is set to one indicating SMART feature set is supported.

If bit 15 of word 86 is set to one, then words 119 and 120 are valid.

Bit 14 of word 86 is reserved.

Bit 13 of word 86 is a copy of bit 13 of word 83.

Bit 12 of word 86 is a copy of bit 12 of word 83.

Bit 11 of word 86 is a copy of bit 11 of word 83.

Bit 10 of word 86 is a copy of bit 10 of word 83.

If bit 9 of word 86 is set to one, then the Automatic Acoustic Management feature set is enabled (see 7.48.11) and the value in word 94 is valid. This bit is valid if bit 9 of word 83 is set to one indicating that the AAM feature set is supported.

If bit 8 of word 86 is set to one, then the HPA Security Extensions are enabled (see 7.49.5). This bit is valid if bit 8 of word 83 is set to one indicating the HPA Security Extensions are supported.

Bit 7 of word 86 is reserved for Address Offset Reserved Area Boot Method.

Bit 6 of word 86 is a copy of bit 6 of word 83.

If bit 5 of word 86 is set to one, then the PUIS feature set is enabled (see 7.48.7). If bit 5 of word 86 is cleared to zero, then the PUIS feature set is disabled. This bit is valid if bit 5 of word 83 is set to one indicating PUIS feature set is supported.

If bit 3 of word 86 is set to one, then the APM feature set is enabled (see 7.48.6). If bit 3 of word 86 is cleared to zero, the APM feature set is disabled.

Bit 2 of word 86 is a copy of bit 2 of word 83.

Bit 1 of word 86 is a copy of bit 1 of word 83.

Bit 0 of word 86 is a copy of bit 0 of word 83.

Bit 13 of word 87 is a copy of bit 13 of word 84.

Bit 12 of word 87 is reserved for TLC.

Bit 11 of word 87 is reserved for TLC.

Bit 8 of word 87 is a copy of word 84 bit 8.

Bit 7 of word 87 is a copy of bit 7 of word 84.

Bit 6 of word 87 is a copy of bit 6 of word 84.

Bit 5 of word 87 is a copy of bit 1 of word 84.

If bit 3 of word 87 is set to one, then the Media Card Pass Through feature set is enabled. If bit 3 of word 87 is cleared to zero, then the Media Card Pass Through feature set is disabled.

If bit 2 of word 87 is set to one, then the media serial number field in words 176-205 is valid. This bit shall be cleared to zero if the media does not contain a valid serial number or if no media is present. This bit is valid if bit 2 of word 84 is set to one indicating Media serial number is supported.

Bit 1 of word 87 is a copy of bit 1 of word 84.

Bit 0 of word 87 is a copy of bit 0 of word 84.

Bits (13:6) of word 120 are reserved.

If bit 5 of word 120 is set to one, then the Free-fall Control feature set is enabled. If bit 5 of word 120 is cleared to zero, then the Free-fall Control feature set is disabled.

Bit 4 of word 120 is a copy of bit 4 of word 119.

Bit 3 of word 120 is a copy of bit 3 of word 119.

Bit 2 of word 120 is a copy of bit 2 of word 119.

If bit 1 of word 120 is set to one then the Write-Read-Verify feature set is enabled. If bit 1 of word 120 is cleared to zero, then the Write-Read-Verify feature set is disabled.

Bit 0 of word 120 is reserved for DDT.

7.16.7.40 Word 88: Ultra DMA modes

Word 88 identifies the Ultra DMA transfer modes supported by the device and indicates the mode that is currently selected. Only one DMA mode shall be selected at any given time. If an Ultra DMA mode is selected, then no Multiword DMA mode shall be selected. If a Multiword DMA mode is selected, then no Ultra DMA mode shall be selected. Support of this word is mandatory if any Ultra DMA mode is supported.

Bit 15 of word 88 is reserved.

If bit 14 of word 88 is set to one, then Ultra DMA mode 6 is selected. If this bit is cleared to zero, then Ultra DMA mode 6 is not selected. If bit 13 or bit 12 or bit 11 or bit 10 or bit 9 or bit 8 is set to one, then this bit shall be cleared to zero.

If bit 13 of word 88 is set to one, then Ultra DMA mode 5 is selected. If this bit is cleared to zero, then Ultra DMA mode 5 is not selected. If bit 14 or bit 12 or bit 11 or bit 10 or bit 9 or bit 8 is set to one, then this bit shall be cleared to zero.

If bit 12 of word 88 is set to one, then Ultra DMA mode 4 is selected. If this bit is cleared to zero, then Ultra DMA mode 4 is not selected. If bit 14 or bit 13 or bit 11 or bit 10 or bit 9 or bit 8 is set to one, then this bit shall be cleared to zero.

If bit 11 of word 88 is set to one, then Ultra DMA mode 3 is selected. If this bit is cleared to zero, then Ultra DMA mode 3 is not selected. If bit 14 or bit 13 or bit 12 or bit 10 or bit 9 or bit 8 is set to one, then this bit shall be cleared to zero.

If bit 10 of word 88 is set to one, then Ultra DMA mode 2 is selected. If this bit is cleared to zero, then Ultra DMA mode 2 is not selected. If bit 14 or bit 13 or bit 12 or bit 11 or bit 9 or bit 8 is set to one, then this bit shall be cleared to zero.

If bit 9 of word 88 is set to one, then Ultra DMA mode 1 is selected. If this bit is cleared to zero then Ultra DMA mode 1 is not selected. If bit 14 or bit 13 or bit 12 or bit 11 or bit 10 or bit 8 is set to one, then this bit shall be cleared to zero.

If bit 8 of word 88 is set to one, then Ultra DMA mode 0 is selected. If this bit is cleared to zero then Ultra DMA mode 0 is not selected. If bit 14 or bit 13 or bit 12 or bit 11 or bit 10 or bit 9 is set to one, then this bit shall be cleared to zero.

Bit 7 of word 88 is reserved.

For PATA devices when bit 6 of word 88 is set to one Ultra DMA modes 6 and below are supported. If this bit is cleared to zero, then Ultra DMA mode 6 is not supported. If Ultra DMA mode 6 is supported, then Ultra DMA modes 5, 4, 3, 2, 1 and 0 shall also be supported. If this bit is set to one, then bits (5:0) shall be set to one.

For SATA devices bit 6 of word 88 shall be set to one.

For PATA devices when bit 5 of word 88 is set to one Ultra DMA modes 5 and below are supported. If this bit is cleared to zero, then Ultra DMA mode 5 is not supported. If Ultra DMA mode 5 is supported, then Ultra DMA modes 4, 3, 2, 1 and 0 shall also be supported. If this bit is set to one, then bits (4:0) shall be set to one.

For SATA devices bit 5 of word 88 shall be set to one.

For PATA devices when bit 4 of word 88 is set to one Ultra DMA modes 4 and below are supported. If this bit is cleared to zero, then Ultra DMA mode 4 is not supported. If Ultra DMA mode 4 is supported, then Ultra DMA modes 3, 2, 1 and 0 shall also be supported. If this bit is set to one, then bits (3:0) shall be set to one.

For SATA devices bit 4 of word 88 shall be set to one.

For PATA devices when bit 3 of word 88 is set to one Ultra DMA modes 3 and below are supported. If this bit is cleared to zero, then Ultra DMA mode 3 is not supported. If Ultra DMA mode 3 is supported, then Ultra DMA modes 2, 1 and 0 shall also be supported. If this bit is set to one, then bits (2:0) shall be set to one.

For SATA devices bit 3 of word 88 shall be set to one.

For PATA devices when bit 2 of word 88 is set to one Ultra DMA modes 2 and below are supported. If this bit is cleared to zero, then Ultra DMA mode 2 is not supported. If Ultra DMA mode 2 is supported, then Ultra DMA modes 1 and 0 shall also be supported. If this bit is set to one, bits (1:0) shall be set to one.

For SATA devices bit 2 of word 88 shall be set to one.

For PATA devices when bit 1 of word 88 is set to one Ultra DMA modes 1 and below are supported. If this bit is cleared to zero, then Ultra DMA mode 1 is not supported. If Ultra DMA mode 1 is supported, then Ultra DMA mode 0 shall also be supported. If this bit is set to one, bit 0 shall be set to one.

For SATA devices bit 1 of word 88 shall be set to one.

For PATA devices when bit 0 of word 88 is set to one Ultra DMA mode 0 is supported. If this bit is cleared to zero, then Ultra DMA is not supported.

For SATA devices bit 0 of word 88 shall be set to one.

7.16.7.41 Word 89

Word 89 specifies the estimated time required for the SECURITY ERASE UNIT command to complete its normal mode erasure as defined in table 32. Support of this word is mandatory if the Security feature set is supported. If the Security feature set is not supported, this word shall be cleared to zero.

Table 32 — Normal Erase Mode Time

Value	Time
0	Value not specified
1-254	(Value*2) minutes
255	>508 minutes

7.16.7.42 Word 90

Word 90 specifies the estimated time required for the SECURITY ERASE UNIT command to complete its enhanced mode erasure as defined in table 33. Support of this word is mandatory if support of the Security feature set is supported. If the Security feature set is not supported, this word shall be cleared to zero.

Table 33 — Enhanced Erase Mode Time

Value	Time
0	Value not specified
1-254	(Value*2) minutes
255	>508 minutes

7.16.7.43 Word 91: Current advanced power management level value

Bits (7:0) of word 91 contain the current APM level setting (see table 54). Support of this word is mandatory if the APM feature set is supported. This word is valid if bit 3 of word 83 and bit 3 of word 86 are set to one indicating the APM feature set is supported.

7.16.7.44 Word 92: Master Password Identifier

If the Security feature set is not supported (i.e., bit 1 of word 82 is cleared to zero) or the Master Password Identifier feature is not supported, then word 92 shall contain 0000h or FFFFh.

If the Security feature set and the Master Password Identifier feature are supported, then word 92 contains the value of the Master Password Identifier set when the Master Password was last changed.

7.16.7.45 Word 93: Hardware reset results

For PATA devices, when bit 14 of word 93 is set to one and bit 15 of word 93 is cleared to zero the content of word 93 contains valid information. During processing of a hardware reset, Device 0 shall set bits (12:8) of this word to zero and shall set bits (7:0) of this word to show the result of the hardware reset. During processing of a hardware reset, Device 1 shall clear bits (7:0) of this word to zero and shall set bits (12:8) of the word to show the result of the hardware reset. Support of bits (15:13) is mandatory. Support of bits (12:0) is optional.

Bit 13 shall be set or cleared by the selected device to indicate whether the device detected CBLID- above V_{IH} or below V_{IL} at any time during execution of each IDENTIFY DEVICE command after receiving the command from the host but before returning data to the host. This test may be repeated as desired by the device during command execution (see ATA8-APT).

For SATA devices, word 93 shall be set to the value 0000h.

7.16.7.46 Word 94: Current AAM value

Bits (15:8) contain the device vendor's recommended AAM level (see table 56 for an enumeration of all of the possible acoustic management levels). If the host requires the device to perform with highest performance, then the host should set the AAM level to FEh (see 7.48.11). If the host requires the device vendor's recommended AAM level, then the host should set the AAM level to the value returned in these bits. The use of this setting may not provide the lowest acoustics, or the best trade-off of acoustics and performance, in all configurations. Support of this word is mandatory if the AAM feature set is supported.

Bits (7:0) contain the current AAM level. If the AAM feature set is supported by the device, but the level has not been set by the host, this byte shall contain the device's default setting. If the AAM feature set is not supported by the device, the value of this byte shall be zero.

This word is valid if bit 9 of word 83 is set to one indicating that the AAM feature set is supported.

7.16.7.47 Word 95: Stream Minimum Request Size

Word 95 contains the number of logical sectors that provides optimum performance in a streaming environment. This number shall be a power of two, with a minimum of eight logical sectors. The starting LBA value for each streaming command should be evenly divisible by this request size. This word is valid if bit 4 of word 84 is set to one, indicating that the Streaming feature set is supported. If the Streaming feature set is not supported by the device, the content of word 95 shall be zero.

7.16.7.48 Word 96: Streaming Transfer Time - DMA

Word 96 defines the Streaming Transfer Time for DMA mode. The worst-case sustainable transfer time per logical sector for the device is calculated as follows:

$$\text{Streaming Transfer Time} = (\text{word 96}) * (\text{Streaming Performance Granularity} / 65536)$$

The content of word 96 may be affected by the host issuing a Set Maximum Host Interface Sector Times (see 7.48.12). Because of this effect, the host should issue an IDENTIFY DEVICE command after issuing a SET FEATURES command that may affect this word. If the Streaming feature set is not supported by the device, the content of word 96 shall be zero.

This word is valid if bit 4 of word 84 is set to one indicating that the Streaming feature set is supported.

7.16.7.49 Word 97: Streaming Access Latency - DMA and PIO

Word 97 defines the Streaming Access Latency for DMA and PIO mode. The worst-case access latency of the device for a streaming command is calculated as follows:

$$\text{Access Latency} = (\text{word 97}) * (\text{Streaming Performance Granularity} / 256)$$

The content of word 97 may be affected by the host issuing a SET FEATURES subcommand 42h or C2h (i.e., enabling or disabling AAM). Because of this effect, the host should issue an IDENTIFY DEVICE command after issuing a SET FEATURES command that may affect this word. If the Streaming feature set is not supported by the device, the content of word 97 shall be zero.

This word is valid if bit 4 of word 84 is set to one indicating that the Streaming feature set is supported.

7.16.7.50 Words 98-99: Streaming Performance Granularity

These words define the fixed unit of time that is used in IDENTIFY DEVICE data word 96, word 97 and word 104, SET FEATURES subcommand Set Maximum Host Interface Sector Times (see 7.48.12), and in the Command Completion Time Limit that is passed in streaming commands. The unit of time for this parameter shall be in

microseconds (e.g., a value of 10000 indicates 10 milliseconds). If yy was returned by the ATA device for this parameter, then:

- a) the Command Completion Time Limit in the Feature field for a streaming command shall be yy microseconds;
- b) the Streaming Transfer Time shall be:
 - A) ((word 96) * (yy / 65,536)) microseconds; or
 - B) ((word 104) * (yy / 65,536)) microseconds;
- c) the Streaming Access Latency shall be ((word 97) * (yy / 256)) microseconds; and
- d) taking these units into account, the host may calculate the estimated time for a streaming command of size S logical sectors as:
 - A) for PIO ((word 104 * S / 65536) + (word 97 / 256)) * yy microseconds; or
 - B) for DMA ((word 96 * S / 65536) + (word 97 / 256)) * yy microseconds.

The value of the Streaming Performance Granularity is vendor specific and fixed for a device.

This word is valid if bit 4 of word 84 is set to one indicating that the Streaming feature set is supported.

7.16.7.51 Words 100-103: Total Number of User Addressable Sectors for the 48-bit Address feature set

Words 100-103 contain a value that is one greater than the maximum LBA in user accessible space when the 48-bit Addressing feature set is supported. The maximum value that shall be placed in this field is 0000_FFFF_FFFF_FFFFh. Support of these words is mandatory if the 48-bit Address feature set is supported.

7.16.7.52 Word 104: Streaming Transfer Time - PIO

Word 104 defines the Streaming Transfer Time for PIO mode. The worst-case sustainable transfer time per logical sector for the device is calculated as follows:

$$\text{Streaming Transfer Time} = (\text{word 104}) * (\text{Streaming Performance Granularity} / 65536)$$

The content of word 104 may be affected by the host issuing a Set Maximum Host Interface Sector Times (see 7.48.12). Because of this effect, the host should issue an IDENTIFY DEVICE command after issuing a SET FEATURES command that may affect this word. If the Streaming feature set is not supported by the device, the content of word 104 shall be zero.

This word is valid if bit 4 of word 84 is set to one indicating that the Streaming feature set is supported.

7.16.7.53 Word 105: Reserved

7.16.7.54 Word 106: Physical sector size / logical sector size

If bit 14 of word 106 is set to one and bit 15 of word 106 is cleared to zero, the contents of word 106 contain valid information. If not, information is not valid in this word.

If bit 13 of word 106 is set to one, then the device has more than one logical sector per physical sector and bits (3:0) of word 106 are valid. See 7.16.7.72 for information on the alignment of logical sectors within a physical sector.

If bit 12 of word 106 is set to one, then the device has been formatted with a logical sector size larger than 256 words and words 117-118 (see 7.16.7.59) are valid. If bit 12 of word 106 is cleared to zero, then words 117-118 are invalid and the logical sector size is 256 words.

Bits (11:4) of word 106 are reserved.

Bits (3:0) of word 106 indicate the size of the device physical sectors in power of two logical sectors.

Examples:

- Bits (3:0): 0 = 2^0 = 1 logical sector per physical sector
- Bits (3:0): 1 = 2^1 = 2 logical sectors per physical sector
- Bits (3:0): 2 = 2^2 = 4 logical sectors per physical sector
- Bits (3:0): 3 = 2^3 = 8 logical sectors per physical sector

7.16.7.55 Word 107: Inter-seek delay for ISO 7779 standard acoustic testing

Word 107 is the manufacturer’s recommended time delay between seeks in microseconds during ISO 7779 standard acoustic testing (i.e., ISO 7779 value t_D (see ISO 7779:1999 (E), subclause C.9 Equipment Category: Disk units and storage subsystems)).

7.16.7.56 Words 108-111: World wide name

Words 108-111 contain a mandatory World Wide Name (WWN) in the NAA IEEE Registered identifier format.

Word 108 bits (15:12) shall contain 5h, indicating that the naming authority is IEEE. All other values are reserved.

Word 108 bits (11:0) and word 109 bits (15:4) shall contain the Organization Unique Identifier (OUI) (i.e., company ID) for the device manufacturer assigned by the IEEE.

The identifier may be obtained from:

Institute of Electrical and Electronic Engineers, Inc.
 Registration Authority Committee
 445 Hoes Lane
 Piscataway, NJ 08855-1331
<http://standards.ieee.org>

Word 109 bits (3:0), word 110, and word 111 shall contain a value assigned by the vendor that is unique for the device in the OUI domain.

The IDENTIFY DEVICE data World Wide Name field is shown by word number in table 34.

Table 34 — IDENTIFY DEVICE data World Wide Name field (word-based view)

Word	Bit number within each word															
	15	14	13	12	11	10	9	8	7	6	5	4	3	2	1	0
108	NAA (5h)				IEEE OUI				bit 12							
109	bit 11				(LSB) bit 0				bit 35 (MSB)				bit 32			
110	bit 31				Unique ID				bit 16							
111	bit 15				(LSB) bit 0											

The World Wide Name field is shown by byte number in table 35.

Table 35 — IDENTIFY DEVICE data World Wide Name field (byte-based view)

Word	Byte	Bit number within each byte									
		7	6	5	4	3	2	1	0		
108	216	IEEE OUI				bit 12					
	217	NAA (5h)				bit 23 (MSB)				bit 20	
109	218	(LSB) bit 0				bit 35 (MSB)				Unique ID	bit 32
	219	IEEE OUI				bit 4					
110	220	bit 23				bit 16					
	221	bit 31				bit 24					
111	222	Unique ID				(LSB) bit 0					
	223	bit 15				bit 8					

7.16.7.57 Words 112-115: Reserved for a 128-bit world wide name**7.16.7.58 Word 116: Reserved for TLC****7.16.7.59 Words 117-118: Logical sector size**

Words 117-118 are a DWord field that indicates the size of device logical sectors in words. The value of logical sector size shall be equal to or greater than 256. The value of logical sector size shall be valid when bit 12 of word 106 is set to one. All logical sectors on a device shall be this length. When bit 12 of word 106 is cleared to zero words 117-118 shall be cleared to zero.

7.16.7.60 Word 119: See 7.16.7.38**7.16.7.61 Word 120: See 7.16.7.39****7.16.7.62 Words 121-126: Reserved for expanded supported and enabled settings****7.16.7.63 Word 127: Obsolete****7.16.7.64 Word 128: Security status**

Support of this word is mandatory if the Security feature set is supported. If the Security feature set is not supported, this word shall be cleared to zero.

Bit 8 of word 128 indicates the Master Password Capability. If security is enabled and the Master Password Capability is high, bit 8 shall be cleared to zero. If security is enabled and the Master Password Capability is maximum, bit 8 shall be set to one. When security is disabled, bit 8 shall be cleared to zero.

Bit 5 of word 128 set to one indicates that the enhanced mode of the SECURITY ERASE UNIT command is supported.

Bit 4 of word 128 set to one indicates that the password attempt counter has decremented to zero. This is also known as the Password Attempt Counter Exceeded bit.

Bit 3 of word 128 set to one indicates that security is frozen.

Bit 2 of word 128 set to one indicates that security is locked.

Bit 1 of word 128 set to one indicates that security is enabled. This is a copy of word 85, bit 1.

Bit 0 of word 128 set to one indicates that the Security feature set is supported. This is a copy of word 82, bit 1.

7.16.7.65 Words 129-159: Vendor specific**7.16.7.66 Word 160: CFA power mode**

Word 160 indicates the presence and status of a CFA feature set device that supports CFA Power Mode 1. Support of this word is mandatory if CFA Power Mode 1 is supported.

If bit 13 of word 160 is set to one then the device is in CFA Power Mode 1 to perform one or more commands implemented by the device.

If bit 12 of word 160 is set to one the device is in CFA Power Mode 0 (see 7.48.9).

Bits (11:0) indicate the maximum average RMS current in Milliampere required during 3.3V or 5V device operation in CFA Power Mode 1.

7.16.7.67 Words 161-167: Reserved for assignment by the CompactFlash Association**7.16.7.68 Word 168: Device Nominal Form Factor**

Bits (3:0) of Word 168 indicate the nominal form factor of the device and is defined in table 36.

Table 36 — Device Nominal Form Factor

Value	Description
0h	Nominal form factor not reported
1h	5.25 inch nominal form factor
2h	3.5 inch nominal form factor
3h	2.5 inch nominal form factor
4h	1.8 inch nominal form factor
5h	Less than 1.8 inch nominal form factor
6h-Fh	Reserved

7.16.7.69 Words 169-175: Reserved**7.16.7.70 Words 176-205: Current media serial number**

Words 176-205 contain the current media serial number. Media serial numbers shall be an ATA string of sixty bytes in the format defined by 3.2.9. The first forty bytes shall indicate the media serial number and the remaining twenty bytes shall indicate the media manufacturer.

7.16.7.71 Word 206: SCT Command Transport

Bits (15:12) indicate support for vendor specific action codes.

Bits (11:6) of word 206 are reserved.

If bit 5 of word 206 is set to one, then the device supports SCT Data Tables (see 8.3.6).

If bit 4 of word 206 is set to one, then the device supports SCT Feature Control (see 8.3.5).

If bit 3 of word 206 is set to one, then the device supports SCT Error Recovery Control (see 8.3.4).

If bit 2 of word 206 is set to one, then the device supports SCT Write Same (see 8.3.3).

If bit 1 of word 206 is set to one, then the device supports SCT Read/Write Long (see 8.3.2).

If bit 0 of word 206 is set to one, then the device supports the SCT Command Transport including SCT Read Status (see clause 8).

7.16.7.72 Word 209: Alignment of logical blocks within a physical block

Word 209 shall report the location of logical sector zero within the first physical sector of the media. See Annex E for more information. This word is valid if bit 13 of word 106 is set to one.

Bit 15 of word 209 shall be cleared to zero.

Bit 14 of word 209 shall be set to one.

Bits 13:0 of word 209 indicate the Logical sector offset within the first physical sector where the first logical sector is placed.

7.16.7.73 Words 210-211: Write-Read-Verify Sector Count Mode 3

Words 210-211 shall indicate the number of logical sectors to be verified after every spin-up, when Write-Read-Verify feature set mode 3 is selected (i.e., word 220 bits 7:0 are 03h). This field is valid when word 120 bit 1 is set to one and word 220 bits 7:0 are 03h.

7.16.7.74 Words 212-213: Write-Read-Verify Sector Count Mode 2

Words 212-213 shall indicate the number of logical sectors to be verified after every spin-up, when Write-Read-Verify feature set mode 2 is selected (i.e., word 220 bits 7:0 are 02h). These words are valid when word 119 bit 1 is set to one.

7.16.7.75 Word 214: NV Cache Capabilities

Both the NV Cache Power Mode feature set version (word 214 bits (11:8)) and the NV Cache feature set version (word 214 bits (15:12)) shall be set to zero.

If bit 4 of word 214 is set to one, the NV Cache feature set is enabled.

If bit 1 of word 214 is set to one, the NV Cache Power Management feature is enabled. This capability is enabled by issuing a SET NV CACHE POWER MODE and disabled by issuing a RETURN FROM NV CACHE POWER MODE.

If bit 0 of word 214 is set to one, the NV Cache Power Management feature set is supported.

7.16.7.76 Words 215-216: NV Cache Size in Logical Blocks

Words 215-216 indicate the maximum number of logical sectors that the device's NV Cache Set contains for the host to pin. This field is valid if word 214 bit 0 or bit 4 is set to one indicating NV Cache feature set is supported.

7.16.7.77 Word 217: Nominal media rotation rate

Word 217 indicates the nominal media rotation rate of the device and is defined in table 37.

Table 37 — Nominal Media Rotation Rate

Value	Description
0000h	Rate not reported
0001h	Non-rotating media (e.g., solid state device)
0002h-0400h	Reserved
0401h-FFFEh	Nominal media rotation rate in rotations per minute (rpm) (e.g., 7200 rpm = 1C20h)
FFFFh	Reserved

7.16.7.78 Word 218: Reserved**7.16.7.79 Word 219: NV Cache Options**

Word 219 bits (7:0) contains the device's estimate of the amount of time in seconds it takes for the device to satisfy a read or write request from its rotational media when the read or write request is received while the rotational media is not spinning. This field is valid if bit 4 of word 214 is set to one.

7.16.7.80 Word 220

Word 220 contains the current mode of the Write-Read-Verify feature set, as set by the SET FEATURES Enable/Disable Write-Read-Verify subcommand. See 7.48.10 for more information on setting Write-Read-Verify mode.

Bits (15:8) of word 220 are reserved.

Bits (7:0) of word 220 indicate the current mode of the Write-Read-Verify feature set.

7.16.7.81 Word 221: Reserved**7.16.7.82 Word 222: Transport major version number**

If word 222 is not set to FFFFh or 0000h, then the device claims compliance with one or more of the ATA transport standard major versions as indicated by bits (11:0). Values other than 0000h and FFFFh are bit significant. A device may set more than one bit to one.

7.16.7.83 Word 223: Transport minor version number

Table 38 defines the value that shall be reported in word 223 to indicate the version of the standard that guided the implementation.

Table 38 — Transport minor version number

Value	Minor Version
0000h	Minor version not reported
0001h-0020h	Reserved
0021h	ATA8-AST T13 Project D1697 Version 0b
0022h-0050h	Reserved
0051h	ATA-AST T13 Project D1697 Version 1
0052h-FFFEh	Reserved
FFFFh	Minor version not reported

7.16.7.84 Words 224-233: Reserved for CE-ATA**7.16.7.85 Word 234: Minimum number of 512-byte data blocks per DOWNLOAD MICROCODE command mode 03h**

Word 234 contains the minimum number of 512-byte data blocks per DOWNLOAD MICROCODE command that the ATA device accepts when using the offset transfer method (see 7.12). This word is valid if bit 0 of word 83, bit 0 of word 86, and bit 4 of word 120 are set to one, indicating that the DOWNLOAD MICROCODE command using the offset transfer method is supported. The values 0000h and FFFFh indicate no minimum is specified (i.e., that there is no minimum number of blocks).

7.16.7.86 Word 235: Maximum number of 512-byte data blocks per DOWNLOAD MICROCODE command mode 03h

Word 234 contains the maximum number of 512-byte data blocks per DOWNLOAD MICROCODE command that the ATA device shall accept when using the offset transfer method (see 7.12). This word is valid if bit 0 of word 83, bit 0 of word 86, and bit 4 of word 120 are set to one, indicating that the DOWNLOAD MICROCODE command using the offset transfer method is supported. The values 0000h and FFFFh indicate no maximum is specified (i.e., that there is no maximum number of blocks).

7.16.7.87 Words 236-254: Reserved**7.16.7.88 Word 255: Integrity word**

The use of this word is optional. If bits (7:0) of this word contain the Checksum Validity Indicator A5h then bits (15:8) contain the data structure checksum. The data structure checksum is the two's complement of the sum of all bytes in words 0-254 and the byte consisting of bits (7:0) in word 255. Each byte shall be added with unsigned arithmetic, and overflow shall be ignored. The sum of all 512 bytes is zero when the checksum is correct.

7.17 IDENTIFY PACKET DEVICE - A1h, PIO Data-In

7.17.1 Feature Set

This 28-bit command is mandatory for devices implementing the PACKET feature set.

7.17.2 Description

The IDENTIFY PACKET DEVICE command enables the host to receive parameter information from a device that implements the PACKET feature set. See table 39 for a description of the return data.

Some devices may have to read the media in order to complete this command.

The IDENTIFY PACKET DEVICE data contains information regarding optional feature or command support. If the host issues a command that is indicated as not supported in the IDENTIFY PACKET DEVICE data, the device shall return command aborted for the command.

7.17.3 Inputs

Name	Description
Feature	N/A
Count	N/A
LBA	N/A
Device	<p>Bit Description</p> <p>7 Obsolete</p> <p>6 N/A</p> <p>5 Obsolete</p> <p>4 Transport Dependent - See 6.2.11</p> <p>3:0 Reserved</p>
Command	7:0 A1h

7.17.4 Normal Outputs

See table 99.

7.17.5 Error Outputs

The device shall return command aborted if the device does not implement this command, otherwise, the device shall not report an error. See table 123. The device may return command completion with the Error bit set to one if an Interface CRC error has occurred.

NOTE 13 — There is no defined mechanism for a device to return an Interface CRC error status that may have occurred during the last data block of a PIO-in data transfer; there may be other mechanisms in which a host may verify that an Interface CRC error occurred in these cases.

7.17.6 Input From the Device to the Host Data Structure

7.17.6.1 Overview

Table 39 specifies the format of IDENTIFY PACKET DEVICE data.

Table 39 — IDENTIFY PACKET DEVICE data (part 1 of 13)

Word	O M	S P	F V	Description
0	M	B	F	General configuration
			F	15:14 10b = ATAPI device
			F	11b = Reserved
			F	13 Reserved
			F	12:8 Indicates command set used by the device
			X	7 Obsolete
			F	6:5 00b = Device shall set DRQ to one within 3 ms of receiving PACKET command.
			F	01b = Obsolete.
			F	10b = Device shall set DRQ to one within 50 μs of receiving PACKET command.
			F	11b = Reserved
			F	4:3 Reserved
			V	2 Incomplete response
			F	1:0 00b = 12 byte command packet
			F	01b = 16 byte command packet
			F	1xb = Reserved
1				Reserved
2		B	V	Specific configuration
3-9				Reserved
10-19	M	B	F	Serial number (ATA String)
20-22				Reserved
23-26	M	B	F	Firmware revision (ATA String)
27-46	M	B	F	Model number (ATA String)
47-48				Reserved
Key:				O/M – Mandatory/optional requirement.
F/V – Fixed/variable content				M – Support of the word is mandatory.
F – The content of the field is fixed and does not change. The DCO command may change the value of a fixed field.				O – Support of the word is optional.
V – The contents of the field is variable and may change depending on the state of the device or the commands processed by the device.				S/P – Content applies to Serial or Parallel transport
X – The fixed or variable type of this field is not defined in this standard.				S – Serial Transport
				P – Parallel Transport
				B – Both Serial and Parallel Transports
				N – Belongs to a transport other than Serial or Parallel

Table 39 — IDENTIFY PACKET DEVICE data (part 2 of 13)

Word	O M	S P	F V	Description
49	M			Capabilities X 15:12 Obsolete P F 11 1 = IORDY supported P F 10 1 = IORDY may be disabled F 9 Shall be set to one. P F 8 1 = DMA supported. Devices that require the DMADIR bit in the PACKET command shall clear this bit to 0 X 7:0 Vendor specific
50	O			Capabilities F 15 Shall be cleared to zero. F 14 Shall be set to one. 13:2 Reserved X 1 Obsolete B F 0 Shall be set to one to indicate a device specific Standby timer value minimum.
51-52			X	Obsolete
53	M			15:3 Reserved B F 2 1 = the fields reported in word 88 are valid B F 1 1 = the fields reported in words 64-70 are valid X 0 Obsolete
54-61				Reserved
Key:				O/M – Mandatory/optional requirement. M – Support of the word is mandatory. O – Support of the word is optional. S/P – Content applies to Serial or Parallel transport S – Serial Transport P – Parallel Transport B – Both Serial and Parallel Transports N – Belongs to a transport other than Serial or Parallel
F/V – Fixed/variable content F – The content of the field is fixed and does not change. The DCO command may change the value of a fixed field. V – The contents of the field is variable and may change depending on the state of the device or the commands processed by the device. X – The fixed or variable type of this field is not defined in this standard.				

Table 39 — IDENTIFY PACKET DEVICE data (part 3 of 13)

Word	O M	S P	F V	Description
62	M			<p>DMADIR</p> <p>15 1 = DMADIR bit in the PACKET command is required for DMA transfers 0 = DMADIR bit in PACKET command is not required for DMA transfers.</p> <p>14:11 Reserved</p> <p>10 1 = DMA is supported</p> <p>9 1 = Multiword DMA mode 2 is supported</p> <p>8 1 = Multiword DMA mode 1 is supported</p> <p>7 1 = Multiword DMA mode 0 is supported</p> <p>6 1 = Ultra DMA mode 6 and below are supported</p> <p>5 1 = Ultra DMA mode 5 and below are supported</p> <p>4 1 = Ultra DMA mode 4 and below are supported</p> <p>3 1 = Ultra DMA mode 3 and below are supported</p> <p>2 1 = Ultra DMA mode 2 and below are supported</p> <p>1 1 = Ultra DMA mode 1 and below are supported</p> <p>0 1 = Ultra DMA mode 0 is supported</p>
63	M			<p>15:11 Reserved</p> <p>10 1 = Multiword DMA mode 2 is selected</p> <p>9 1 = Multiword DMA mode 1 is selected</p> <p>8 1 = Multiword DMA mode 0 is selected</p> <p>7:3 Reserved</p> <p>2 1 = Multiword DMA mode 2 and below are supported.</p> <p>1 1 = Multiword DMA mode 1 and below are supported.</p> <p>0 1 = Multiword DMA mode 0 is supported Multiword DMA mode selected.</p>
64	M			<p>15:8 Reserved</p> <p>7:0 PIO transfer modes supported</p>
65	M			<p>Minimum Multiword DMA transfer cycle time per word</p> <p>15:0 Cycle time in nanoseconds</p>
66	M			<p>Manufacturer's recommended Multiword DMA transfer cycle time</p> <p>15:0 Cycle time in nanoseconds</p>
67	M			<p>Minimum PIO transfer cycle time without flow control</p> <p>15:0 Cycle time in nanoseconds</p>
<p>Key:</p> <p>F/V – Fixed/variable content</p> <p>F – The content of the field is fixed and does not change. The DCO command may change the value of a fixed field.</p> <p>V – The contents of the field is variable and may change depending on the state of the device or the commands processed by the device.</p> <p>X – The fixed or variable type of this field is not defined in this standard.</p>				<p>O/M – Mandatory/optional requirement.</p> <p>M – Support of the word is mandatory.</p> <p>O – Support of the word is optional.</p> <p>S/P – Content applies to Serial or Parallel transport</p> <p>S – Serial Transport</p> <p>P – Parallel Transport</p> <p>B – Both Serial and Parallel Transports</p> <p>N – Belongs to a transport other than Serial or Parallel</p>

Table 39 — IDENTIFY PACKET DEVICE data (part 4 of 13)

Word	O M	S P	F V	Description
68	M	P	F	Minimum PIO transfer cycle time with IORDY flow control 15:0 Cycle time in nanoseconds
69-70				Reserved
71-72			X	Obsolete
73-74				Reserved
75			X	Obsolete
76	O	S	F	Serial ATA Capabilities 15:11 Reserved for Serial ATA 10 1 = The Phy Event Counters are supported 9 1 = Receipt of host initiated power management requests are supported 8 1 = The NCQ feature set is supported 7:3 Reserved for future Serial ATA 2 1 = The SATA Gen2 Signaling Speed (3.0Gb/s) is supported 1 1 = The SATA Gen1 Signaling Speed (1.5Gb/s) is supported 0 Shall be cleared to zero
77				Reserved for Serial ATA
78	O	S	F	Serial ATA features supported 15:7 Reserved for Serial ATA 6 1 = The SSP feature set is supported 5 Reserved for Serial ATA 4 1 = In-order data delivery is supported 3 1 = Device initiated power management is supported 2 1 = DMA Setup auto-activation is supported 1 1 = non-zero buffer offsets is supported 0 Shall be cleared to zero
Key:				O/M – Mandatory/optional requirement. M – Support of the word is mandatory. O – Support of the word is optional. S/P – Content applies to Serial or Parallel transport S – Serial Transport P – Parallel Transport B – Both Serial and Parallel Transports N – Belongs to a transport other than Serial or Parallel
F/V – Fixed/variable content F – The content of the field is fixed and does not change. The DCO command may change the value of a fixed field. V – The contents of the field is variable and may change depending on the state of the device or the commands processed by the device. X – The fixed or variable type of this field is not defined in this standard.				

Table 39 — IDENTIFY PACKET DEVICE data (part 5 of 13)

Word	O M	S P	F V	Description
79	O	S	V	Serial ATA features enabled 15:7 Reserved for Serial ATA 6 1 = The SSP feature set is enabled 5 Reserved for Serial ATA 4 1 = In-order data delivery is enabled 3 1 = Device initiated power management is enabled 2 1 = DMA Setup auto-activation is enabled 1 1 = Non-zero buffer offsets is enabled 0 Shall be cleared to zero
80	M	B	F	Major version number 0000h or FFFFh = device does not report version 15:9 Reserved 8 1 = ATA8-ACS is supported 7 1 = ATA/ATAPI-7 is supported 6 1 = ATA/ATAPI-6 is supported 5 1 = ATA/ATAPI-5 is supported 4 1 = ATA/ATAPI-4 is supported 3 Obsolete 2 Obsolete 1 Obsolete 0 Reserved
81	M	B	F	Minor version number
Key: F/V – Fixed/variable content F – The content of the field is fixed and does not change. The DCO command may change the value of a fixed field. V – The contents of the field is variable and may change depending on the state of the device or the commands processed by the device. X – The fixed or variable type of this field is not defined in this standard.				O/M – Mandatory/optional requirement. M – Support of the word is mandatory. O – Support of the word is optional. S/P – Content applies to Serial or Parallel transport S – Serial Transport P – Parallel Transport B – Both Serial and Parallel Transports N – Belongs to a transport other than Serial or Parallel

Table 39 — IDENTIFY PACKET DEVICE data (part 6 of 13)

Word	O M	S P	F V	Description
82	M	B		Commands and feature sets supported
			X	15 Obsolete
			F	14 Shall be set to one to indicate that the NOP command is supported
			F	13 Shall be cleared to zero to indicate that the READ BUFFER command is not supported
			F	12 Shall be cleared to zero to indicate that the WRITE BUFFER command is not supported
			X	11 Obsolete
			F	10 Shall be cleared to zero to indicate that the HPA set is not supported
			F	9 Shall be set to one to indicate that the DEVICE RESET command is supported
			X	8 Obsolete
			X	7 Obsolete
			F	6 1 = Read look-ahead supported
			F	5 1 = The volatile write cache is supported
			F	4 Shall be set to one indicating the PACKET feature set is supported.
			F	3 1 = The Power Management feature set supported
			X	2 Obsolete
			F	1 1 = The Security feature set is supported
			F	0 Shall be cleared to zero to indicate that the SMART feature set is not supported
Key:				O/M – Mandatory/optional requirement.
F/V – Fixed/variable content				M – Support of the word is mandatory.
F – The content of the field is fixed and does not change. The DCO command may change the value of a fixed field.				O – Support of the word is optional.
V – The contents of the field is variable and may change depending on the state of the device or the commands processed by the device.				S/P – Content applies to Serial or Parallel transport
X – The fixed or variable type of this field is not defined in this standard.				S – Serial Transport
				P – Parallel Transport
				B – Both Serial and Parallel Transports
				N – Belongs to a transport other than Serial or Parallel

Table 39 — IDENTIFY PACKET DEVICE data (part 7 of 13)

Word	O M	S P	F V	Description
83	M	B		Commands and feature sets supported F 15 Shall be cleared to zero F 14 Shall be set to one 13 Reserved F 12 1 = The FLUSH CACHE command is supported F 11 1 = The DCO feature set is supported 10 Reserved F 9 1 = The AAM feature set is supported F 8 1 = The SET MAX security extension is supported 7 Reserved for Address Offset Reserved Area Boot Method F 6 1 = The SET FEATURES subcommand is required to spin-up after power-up F 5 1 = The PUIS feature set is supported X 4 Obsolete F 3 1 = The APM feature set is supported 2:1 Reserved F 0 Shall be cleared to zero to indicate that the DOWNLOAD MICROCODE command is not supported
84	M	B		Commands and feature sets supported F 15 Shall be cleared to zero F 14 Shall be set to one 13:9 Reserved F 8 shall be set to one to indicate that the mandotry WWN is supported 7:6 Reserved F 5 1 = The GPL feature set is supported 4:0 Reserved
Key: F/V – Fixed/variable content F – The content of the field is fixed and does not change. The DCO command may change the value of a fixed field. V – The contents of the field is variable and may change depending on the state of the device or the commands processed by the device. X – The fixed or variable type of this field is not defined in this standard.				O/M – Mandatory/optional requirement. M – Support of the word is mandatory. O – Support of the word is optional. S/P – Content applies to Serial or Parallel transport S – Serial Transport P – Parallel Transport B – Both Serial and Parallel Transports N – Belongs to a transport other than Serial or Parallel

Table 39 — IDENTIFY PACKET DEVICE data (part 8 of 13)

Word	O M	S P	F V	Description
85	M	B		Commands and feature sets supported or enabled
			X	15 Obsolete
			F	14 Shall be set to one to indicate that the NOP command is supported
			F	13 Shall be cleared to zero to indicate that the READ BUFFER command is not supported
			F	12 Shall be cleared to zero to indicate that the WRITE BUFFER command is not supported
			X	11 Obsolete
			V	10 Shall be cleared to zero to indicate that the HPA feature set is not supported
			F	9 Shall be set to one to indicate that the DEVICE RESET command is supported
			X	8 Obsolete
			X	7 Obsolete
			V	6 1 = Read look-ahead is enabled
			V	5 1 = The volatile write cache is enabled
			F	4 Shall be set to one indicating the PACKET feature set is supported.
			F	3 1 = Power Management feature set is enabled
			X	2 Obsolete
			V	1 1 = The Security feature set is enabled
			F	0 Shall be cleared to zero to indicate that the SMART feature set is not supported
Key:				O/M – Mandatory/optional requirement.
F/V – Fixed/variable content				M – Support of the word is mandatory.
F – The content of the field is fixed and does not change. The DCO command may change the value of a fixed field.				O – Support of the word is optional.
V – The contents of the field is variable and may change depending on the state of the device or the commands processed by the device.				S/P – Content applies to Serial or Parallel transport
X – The fixed or variable type of this field is not defined in this standard.				S – Serial Transport
				P – Parallel Transport
				B – Both Serial and Parallel Transports
				N – Belongs to a transport other than Serial or Parallel

Table 39 — IDENTIFY PACKET DEVICE data (part 9 of 13)

Word	O M	S P	F V	Description
86	M	B		Commands and feature sets supported or enabled 15:13 Reserved V 12 1 = The FLUSH CACHE command is supported F 11 1 = The DCO feature set is supported 10 Reserved V 9 1 = The AAM feature set enabled V 8 1 = SET MAX security extension enabled by a SET MAX SET PASSWORD 7 Reserved for Address Offset Reserved Area Boot Method F 6 1 = SET FEATURES subcommand required to spin-up after power-up V 5 1 = The PUIS feature set is enabled X 4 Obsolete V 3 1 = The APM feature set is enabled 2:1 Reserved F 0 Shall be cleared to zero to indicate that the DOWNLOAD MICROCODE command is not supported
87	M			Commands and feature sets supported or enabled F 15 Shall be cleared to zero F 14 Shall be set to one 13:9 Reserved F 8 Shall be set to one to indicate that the mandatory WWN is supported 7:6 Reserved F 5 This bit is a copy of word 84 bit 5 4:0 Reserved
Key:				O/M – Mandatory/optional requirement. M – Support of the word is mandatory. O – Support of the word is optional. S/P – Content applies to Serial or Parallel transport S – Serial Transport P – Parallel Transport B – Both Serial and Parallel Transports N – Belongs to a transport other than Serial or Parallel
F/V – Fixed/variable content F – The content of the field is fixed and does not change. The DCO command may change the value of a fixed field. V – The contents of the field is variable and may change depending on the state of the device or the commands processed by the device. X – The fixed or variable type of this field is not defined in this standard.				

Table 39 — IDENTIFY PACKET DEVICE data (part 10 of 13)

Word	O M	S P	F V	Description
88	M	B		Ultra DMA modes 15 Reserved V 14 1 = Ultra DMA mode 6 is selected V 13 1 = Ultra DMA mode 5 is selected V 12 1 = Ultra DMA mode 4 is selected V 11 1 = Ultra DMA mode 3 is selected V 10 1 = Ultra DMA mode 2 is selected V 9 1 = Ultra DMA mode 1 is selected V 8 1 = Ultra DMA mode 0 is selected 7 Reserved F 6 1 = Ultra DMA mode 6 and below are supported. F 5 1 = Ultra DMA mode 5 and below are supported. F 4 1 = Ultra DMA mode 4 and below are supported. F 3 1 = Ultra DMA mode 3 and below are supported. F 2 1 = Ultra DMA mode 2 and below are supported. F 1 1 = Ultra DMA mode 1 and below are supported. F 0 1 = Ultra DMA mode 0 is supported.
89	O	B	F	Time required for Normal Erase mode SECURITY ERASE UNIT command
90	O	B	F	Time required for an Enhanced Erase mode SECURITY ERASE UNIT command
91				Reserved
92	O	B	V	Master Password Identifier
93	M	B		Hardware reset result. The contents of bits (12:0) of this word shall change only during the execution of a hardware reset. F 15 Shall be cleared to zero. F 14 Shall be set to one. V 13 1 = device detected CBLID- above V_{iH} . 0 = device detected CBLID- below V_{iL} . 12:8 Device 1 hardware reset result. Device 0 shall clear these bits to zero. Device 1 shall set these bits as follows: 12 Reserved. V 11 0 = Device 1 did not assert PDIAG-.
Key:				O/M – Mandatory/optional requirement. M – Support of the word is mandatory. O – Support of the word is optional. S/P – Content applies to Serial or Parallel transport S – Serial Transport P – Parallel Transport B – Both Serial and Parallel Transports N – Belongs to a transport other than Serial or Parallel
F/V – Fixed/variable content F – The content of the field is fixed and does not change. The DCO command may change the value of a fixed field. V – The contents of the field is variable and may change depending on the state of the device or the commands processed by the device. X – The fixed or variable type of this field is not defined in this standard.				

Table 39 — IDENTIFY PACKET DEVICE data (part 11 of 13)

Word	O M	S P	F V	Description
			V	1 = Device 1 asserted PDIAG-.
			F	10:9 These bits indicate how Device 1 determined the device number: 00b = Reserved. 01b = a jumper was used. 10b = the CSEL signal was used. 11b = some other method was used or the method is unknown.
			F	8 Shall be set to one.
			F	7:0 Device 0 hardware reset result. Device 1 shall clear these bits to zero. Device 0 shall set these bits as follows: 7 Reserved.
			V	6 0 = Device 0 does not respond when Device 1 is selected. 1 = Device 0 responds when Device 1 is selected.
			V	5 0 = Device 0 did not detect the assertion of DASP-. 1 = Device 0 detected the assertion of DASP-.
			V	4 0 = Device 0 did not detect the assertion of PDIAG-. 1 = Device 0 detected the assertion of PDIAG-.
			V	3 0 = Device 0 failed diagnostics. 1 = Device 0 passed diagnostics.
			V	2:1 These bits indicate how Device 0 determined the device number: 00b = Reserved. 01b = a jumper was used. 10b = the CSEL signal was used. 11b = some other method was used or the method is unknown.
			F	0 Shall be set to one.
94	O		F	Current automatic acoustic management value
		B	F	15:8 Vendor's recommended acoustic management value.
		B	V	7:0 Current automatic acoustic management value.
95-107				Reserved
108-111	M	B	F	World wide name
112-115				Reserved for world wide name extension to 128 bits
116-118				Reserved
<p>Key:</p> <p>F/V – Fixed/variable content</p> <p>F – The content of the field is fixed and does not change. The DCO command may change the value of a fixed field.</p> <p>V – The contents of the field is variable and may change depending on the state of the device or the commands processed by the device.</p> <p>X – The fixed or variable type of this field is not defined in this standard.</p>				<p>O/M – Mandatory/optional requirement.</p> <p>M – Support of the word is mandatory.</p> <p>O – Support of the word is optional.</p> <p>S/P – Content applies to Serial or Parallel transport</p> <p>S – Serial Transport</p> <p>P – Parallel Transport</p> <p>B – Both Serial and Parallel Transports</p> <p>N – Belongs to a transport other than Serial or Parallel</p>

Table 39 — IDENTIFY PACKET DEVICE data (part 12 of 13)

Word	O M	S P	F V	Description
119				Commands and feature sets supported 15:0 Reserved
120				Commands and feature sets supported or enabled 15:0 Reserved
121-125				Reserved
125	M	B	F	ATAPI byte count = 0 behavior
126-127			X	Obsolete
128	O			Security status 15:9 Reserved 8 Mater Password Capability: 0 = High, 1 = Maximum 7:6 Reserved 5 1 = The enhanced security erase mode is supported 4 1 = The Security count is expired 3 1 = Security is frozen 2 1 = Security is locked 1 1 = Security is enabled 0 1 = Security is supported
129-159			X	Vendor specific
Key:				O/M – Mandatory/optional requirement. M – Support of the word is mandatory. O – Support of the word is optional. S/P – Content applies to Serial or Parallel transport S – Serial Transport P – Parallel Transport B – Both Serial and Parallel Transports N – Belongs to a transport other than Serial or Parallel
F/V – Fixed/variable content F – The content of the field is fixed and does not change. The DCO command may change the value of a fixed field. V – The contents of the field is variable and may change depending on the state of the device or the commands processed by the device. X – The fixed or variable type of this field is not defined in this standard.				

Table 39 — IDENTIFY PACKET DEVICE data (part 13 of 13)

Word	O M	S P	F V	Description
160-175		N		Reserved for assignment by the CompactFlash Association
176-221				Reserved
222	M	B	F	Transport Major version number. 0000h or FFFFh = device does not report version 15:12 Transport Type 0h = Parallel 1h = Serial 2h-Fh = Reserved Parallel Serial 11:5 Reserved Reserved 4 Reserved SATA Rev 2.6 3 Reserved SATA Rev 2.5 2 Reserved SATA II: Extensions 1 ATA/ATAPI-7 SATA 1.0a 0 ATA8-APT ATA8-AST
223	M	B	F	Transport Minor version number
224-254				Reserved
255	O	B	V	Integrity word 15:8 Checksum 7:0 Checksum Validity Indicator
Key:				O/M – Mandatory/optional requirement. M – Support of the word is mandatory. O – Support of the word is optional. S/P – Content applies to Serial or Parallel transport S – Serial Transport P – Parallel Transport B – Both Serial and Parallel Transports N – Belongs to a transport other than Serial or Parallel
F/V – Fixed/variable content F – The content of the field is fixed and does not change. The DCO command may change the value of a fixed field. V – The contents of the field is variable and may change depending on the state of the device or the commands processed by the device. X – The fixed or variable type of this field is not defined in this standard.				

7.17.6.2 Word 0: General configuration

Bits (15:14) of word 0 indicate the type of device. Bit 15 shall be set to one and bit 14 shall be cleared to zero to indicate the device is an ATAPI device.

Bits (12:8) of word 0 indicate the command set used by the device. This value follows the peripheral device type as defined in SPC-4 (e.g., 05h indicates a CD/DVD device).

Bit 7 of word 0 is Obsolete.

For PATA devices, bits (6:5) of word 0 indicate the DRQ response time when a PACKET command is received. A value of 00b indicates that the maximum time for a device to set DRQ to one after receiving a PACKET command is 3 ms. The value 01b is obsolete. A value of 10b indicates that the maximum time for a device to set DRQ to one after receiving a PACKET command is 50µs. The value 11b is reserved.

If bit 2 of word 0 is set to one, then the content of the IDENTIFY PACKET DEVICE data is incomplete. This may occur if the device supports the PUIS feature set and required data is contained on the device media. The content of IDENTIFY DEVICE data word 0 and word 2 shall be valid.

Bits (1:0) of word 0 indicate the packet size the device supports. A value of 00b indicates that a 12-byte packet is supported; a value of 01b indicates a 16 byte packet. The values 10b and 11b are reserved.

7.17.6.3 Word 1: Reserved

7.17.6.4 Word 2: Specific configuration

Word 2 shall have the same content described for IDENTIFY DEVICE data word 2 (see 7.16.7.4).

7.17.6.5 Words 3-9: Reserved

7.17.6.6 Words 10-19: Serial number

If the ATAPI device does not report the serial number, the content shall be 0000h in each word; otherwise, the content shall be as described for IDENTIFY DEVICE data words 10-19 (see 7.16.7).

7.17.6.7 Words 20-22: Reserved

7.17.6.8 Words 23-26: Firmware revision

Words 23-26 shall have the content described for IDENTIFY DEVICE data words 23-26 (see 7.16.7.13).

7.17.6.9 Words 27-46: Model number

Words 27-46 shall have the content described for IDENTIFY DEVICE data words 27-46 (see 7.16.7.14).

7.17.6.10 Words 47-48: Reserved

7.17.6.11 Word 49: Capabilities

Bits (15:12) of word 49 are obsolete.

Bit 11 of word 49 indicates whether a device supports IORDY. If this bit is set to one, then the device supports IORDY operation. If this bit is cleared to zero, the device may support IORDY. This ensures backward compatibility. If a device supports PIO mode 3 or higher, then this bit shall be set to one. For SATA devices, this bit shall be set to one.

Bit 10 of word 49 indicates a device's ability to enable or disable the use of IORDY. If this bit is set to one, then the device supports the disabling of IORDY. Disabling and enabling of IORDY is accomplished using the SET FEATURES command. For SATA devices, this bit shall be set to one.

Bit 9 of word 49 shall be set to one.

Bit 8 of word 49 indicates that DMA is supported. Devices that require the DMADIR bit in the PACKET command shall clear this bit to 0

7.17.6.12 Word 50: Capabilities

Word 50 shall have the content described for IDENTIFY DEVICE data word 50 (see 7.16.7.17). Support of this word is mandatory if the STANDBY command is supported.

7.17.6.13 Word 51: Obsolete

7.17.6.14 Word 52: Obsolete

7.17.6.15 Word 53

Word 53 bits (2:0) shall have the content described for IDENTIFY DEVICE data word 53 bits (2:0). Bits (15:3) are reserved.

7.17.6.16 Words 54-61: Reserved

7.17.6.17 Word 62: DMADIR

ATAPI devices may require use of the DMADIR bit to indicate transfer direction for PACKET commands using the DMA data transfer protocol. Word 62 indicates if such support is required.

If bit 15 of word 62 is set to one, then the DMADIR bit in the PACKET command is required by the device for PACKET commands using the DMA data transfer protocol and bits (2:0) of word 63, bits 15 and 8 in word 49, and bits (6:0) of word 88 shall be cleared to zero.

If bit 15 of word 62 is cleared to zero, then the DMADIR bit in the PACKET command is not required. If bit 15 of word 62 is cleared to zero, then all bits of word 62 shall be cleared to zero.

Bits (14:11) of word 62 are reserved.

Bits (10:1) of word 62 indicate DMA mode support. Since the DMADIR bit is only used for a Serial ATAPI device, all of these bits are set to one.

7.17.6.18 Word 63: Multiword DMA transfer

Word 63 identifies the Multiword DMA transfer modes supported by the device and indicates the mode that is currently selected. Only one DMA mode shall be selected at any given time. If an Ultra DMA mode is enabled, then no Multiword DMA mode shall be enabled. If a Multiword DMA mode is enabled then no Ultra DMA mode shall be enabled.

Bits (15:11) of word 63 are reserved.

Bits (10:8) of word 63 shall have the content described for IDENTIFY DEVICE data word 63. (see 7.16.7.24)

Bits (7:3) of word 63 are reserved

If bit 2 of Word 63 is set to one, then Multiword DMA modes 2 and below are supported. If this bit is cleared to zero, then Multiword DMA mode 2 is not supported. If Multiword DMA mode 2 is supported, then Multiword DMA modes 1 and 0 shall also be supported. If bit 2 of Word 63 is set to one, bits (1:0) shall be set to one.

For SATA devices, bit 2 of word 63 shall be set to one except this bit shall be cleared to zero for Serial ATAPI devices requiring the DMADIR bit in the PACKET command.

If bit 1 of Word 63 is set to one, then Multiword DMA modes 1 and below are supported. If this bit is cleared to zero, then Multiword DMA mode 1 is not supported. If Multiword DMA mode 1 is supported, then Multiword DMA mode 0 shall also be supported. If bit 1 of Word 63 is set to one, bit 0 shall be set to one.

For SATA devices, bit 1 of word 63 bit shall be set to one except this bit shall be cleared to zero for Serial ATAPI devices that require the DMADIR bit in the PACKET command.

If bit 0 of word 63 is set to one, then Multiword DMA mode 0 is supported. For SATA devices, this bit shall be set to one except this bit shall be cleared to zero for Serial ATAPI devices that require the DMADIR bit in the PACKET command.

7.17.6.19 Word 64: PIO transfer modes supported

Word 64 shall have the content described for IDENTIFY DEVICE data word 64 (see 7.16.7.25).

7.17.6.20 Word 65: Minimum multiword DMA transfer cycle time per word

Word 65 shall have the content described for IDENTIFY DEVICE data word 65 (see 7.16.7.26).

7.17.6.21 Word 66: Device recommended multiword DMA transfer cycle time

Word 66 shall have the content described for IDENTIFY DEVICE data word 66 (see 7.16.7.27).

7.17.6.22 Word 67: Minimum PIO transfer cycle time without flow control

Word 67 shall have the content described for IDENTIFY DEVICE data word 67 (see 7.16.7.28).

7.17.6.23 Word 68: Minimum PIO transfer cycle time with IORDY

Word 68 shall have the content described for IDENTIFY DEVICE data word 68 (see 7.16.7.29).

7.17.6.24 Words 69-70: Reserved**7.17.6.25 Words 71-72: Obsolete****7.17.6.26 Words 73-74: Reserved****7.17.6.27 Word 75: Obsolete****7.17.6.28 Word 76: Serial ATA Capabilities**

Word 76 shall have the content described for IDENTIFY DEVICE data word 76 (see 7.16.7.32)

7.17.6.29 Word 77: Reserved for Serial ATA**7.17.6.30 Word 78: Serial ATA features supported**

Word 78 shall have the content described for IDENTIFY DEVICE data word 78 (see 7.16.7.34)

7.17.6.31 Word 79: Serial ATA features enabled

Word 79 shall have the content described for IDENTIFY DEVICE data word 79 (see 7.16.7.35)

7.17.6.32 Word 80: Major version number

Word 80 shall have the content described for IDENTIFY DEVICE data word 80 (see 7.16.7.36).

7.17.6.33 Word 81: Minor version number

Word 81 shall have the content described for IDENTIFY DEVICE data word 81 (see 7.16.7.37).

7.17.6.34 Words 82-84, 119: Commands and feature sets supported

Words 82-84 and 119 shall have the content described for IDENTIFY DEVICE data words 82-84 and 119 (see 7.16.7.38) except as specified in table 39.

7.17.6.35 Words 85-87, 120: Commands and feature sets supported or enabled

Words 85-87 and 120 shall have the content described for IDENTIFY DEVICE data words 85-87 and 120 (see 7.16.7.39) except as specified in table 39.

7.17.6.36 Word 88: Ultra DMA modes

Word 88 shall have the content described for IDENTIFY DEVICE data word 88 (see 7.16.7.40), except bits (6:0) shall be cleared to zero for Serial ATAPI devices that require the DMADIR bit in the PACKET command.

7.17.6.37 Word 89: Time required for Normal Erase mode SECURITY ERASE UNIT command

Word 89 shall have the content described for IDENTIFY DEVICE data word 89 (see 7.16.7.41).

7.17.6.38 Word 90: Time required for an Enhanced Erase mode SECURITY ERASE UNIT command

Word 90 shall have the content described for IDENTIFY DEVICE data word 90 (see 7.16.7.42).

7.17.6.39 Word 91: Reserved**7.17.6.40 Word 92: Master Password Identifier**

Word 92 shall have the content described for IDENTIFY DEVICE data word 92 (see 7.16.7.44).

7.17.6.41 Word 93: Hardware reset results

Word 93 shall have the content described for IDENTIFY DEVICE data word 93 (see 7.16.7.45). Support of bits (15:13) is mandatory. Support of bits (12:0) are optional.

7.17.6.42 Word 94: Current automatic acoustic management value

Word 94 shall have the content described for IDENTIFY DEVICE data word 94 (see 7.16.7.46).

7.17.6.43 Word 95-107: Reserved**7.17.6.44 Words 108-111: World wide name**

Words 108-111 shall have the content described for IDENTIFY DEVICE data words 108-111 (see 7.16.7.56).

7.17.6.45 Words 112-115: Reserved for a 128-bit world wide name

7.17.6.46 Words 116-118: Reserved

7.17.6.47 Words 119-120: See words 82-84 and words 85-87

7.17.6.48 Words 121-124: Reserved

7.17.6.49 Word 125 ATAPI byte count = 0 behavior

If the contents of word 125 are 0000h and the value of the Byte Count Limit is zero, the device shall return command aborted.

If the contents of word 125 are non-zero and the value of the Byte Count Limit is zero, the device shall use the contents of word 125 as the actual byte count limit for the current command and shall not abort.

The device may be reconfigured to report a new value. However, after the device is reconfigured, the content of word 125 reported shall not change until after the next power-on reset or hardware reset.

7.17.6.50 Word 126-127: Obsolete

7.17.6.51 Word 128: Security status

Word 128 shall have the content described for IDENTIFY DEVICE data word 128 (see 7.16.7.64).

7.17.6.52 Words 129-159: Reserved

7.17.6.53 Words 160-175: Reserved for assignment by the CompactFlash Association

7.17.6.54 Words 176-221: Reserved

7.17.6.55 Word 222: Transport major version number

Word 222 shall have the content described for IDENTIFY DEVICE data word 222 (see 7.16.7.82).

7.17.6.56 Word 223: Transport minor version number

Word 223 shall have the content described for IDENTIFY DEVICE data word 223 (see 7.16.7.83).

7.17.6.57 Words 224-254: Reserved

7.17.6.58 Word 255: Integrity word

Word 255 shall have the content described for IDENTIFY DEVICE data word 255 (see 7.16.7.88).

7.18 IDLE - E3h, Non-Data

7.18.1 Feature Set

This 28-bit command is mandatory for devices implementing the Power Management feature set.

7.18.2 Description

The IDLE command allows the host to place the device in the Idle mode and also set the Standby timer.

If the host sets the Count field to 00h, then the device shall disable its Standby timer (see 4.18). If the host sets the Count field to a value > 00h, then table 40 defines the Standby timer value.

7.18.3 Inputs

Name	Description
Feature	Reserved
Count	This value shall determine the time period programmed into the Standby timer. Table 40 defines these values
LBA	Reserved
Device	<p>Bit Description</p> <ul style="list-style-type: none"> 7 Obsolete 6 N/A 5 Obsolete 4 Transport Dependent - See 6.2.11 3:0 Reserved
Command	7:0 E3h

Table 40 — Standby timer periods

Count field	Description
00h	Standby time disabled
01h-F0h	(value * 5) seconds (i.e., 5 seconds to 1200 seconds (i.e., 20 minutes))
F1h-FBh	((value - 240) * 30) minutes (i.e., 30 minutes to 330 minutes (i.e., 5.5 hours))
FCh	21 minutes
FDh	Between 8 hours and 12 hours
FEh	Reserved
FFh	21 minutes 15 seconds
Note 1 - Times are approximate.	

7.18.4 Normal Outputs

See table 99.

7.18.5 Error Outputs

See table 122.

7.19 IDLE IMMEDIATE - E1h, Non-Data

7.19.1 Feature Set

This 28-bit command is mandatory for devices implementing the Power Management feature set.

7.19.2 Description

7.19.2.1 Default Function

The IDLE IMMEDIATE command allows the host to immediately place the device in the Idle mode. Command completion may occur even though the device has not fully transitioned into the Idle mode.

7.19.2.2 Unload feature

The optional unload feature of the IDLE IMMEDIATE command provides a method for the host to cause a device that has movable read/write heads to move them to a safe position.

Upon receiving an IDLE IMMEDIATE command with the unload feature, a device shall:

- a) stop read look-ahead if that operation is in process;
- b) stop writing cached data to the media if that operation is in process;
- c) if a device implements unloading its head(s) onto a ramp, then the device shall retract the head(s) onto the ramp;
- d) if a device implements parking its head(s) in a landing zone on the media, then the device shall park its head(s) in the landing zone; and
- e) transition to the Idle mode.

The device shall retain data in the write cache and resume writing the cached data onto the media after receiving a Software Reset, a Hardware Reset, or any new command except IDLE IMMEDIATE with unload feature.

A device shall report command completion after the head(s) have been unloaded or parked.

NOTE 14 — The time required by a device to complete an unload or park operation is vendor specific.

7.19.3 Inputs (Default Function)

Name	Description
Feature	N/A except when the unload feature is requested, see 7.19.4
Count	N/A except when the unload feature is requested, see 7.19.4
LBA	N/A except when the unload feature is requested, see 7.19.4
Device	<p>Bit Description</p> <p>7 Obsolete</p> <p>6 N/A</p> <p>5 Obsolete</p> <p>4 Transport Dependent - See 6.2.11</p> <p>3:0 Reserved</p>
Command	7:0 E1h

7.19.4 Inputs (Unload Feature)

Name	Description
Feature	44h
Count	00h
LBA	0554E4Ch
Device	<p>Bit Description</p> <p>7 Obsolete</p> <p>6 N/A</p> <p>5 Obsolete</p> <p>4 Transport Dependent - See 6.2.11</p> <p>3:0 Reserved</p>
Command	7:0 E1h

7.19.5 Normal Outputs (default)

See table 99.

7.19.6 Normal Outputs (unload feature)

See table 105.

7.19.7 Error Outputs

See table 122.

7.20 Non-Volatile Cache

7.20.1 NV Cache Overview

The optional NV Cache Commands feature set permits a host to modify the NV Cache Pinned Set of a device in a manner that allows the device to improve response times to read and write commands while reducing the device's power consumption.

The NV Cache Commands feature set provides a set of commands that guide a device's management of the contents of its NV Cache.

Commands unique to the NV Cache Commands feature set use a single command code and are differentiated from one another by the value placed in the Feature field. A device that implements the NV Cache Commands feature set shall implement the following commands:

- a) ADD LBA(S) TO NV CACHE PINNED SET;
- b) REMOVE LBA(S) FROM NV CACHE PINNED SET;
- c) QUERY NV CACHE PINNED SET;
- d) QUERY NV CACHE MISSES;
- e) FLUSH NV CACHE; and
- f) NV CACHE ENABLE/DISABLE.

Individual NV Cache Commands are identified by the value placed in the Feature field as shown in table 41.

Table 41 — NV Cache Commands

Value	Command Name
0000h-000Fh	Reserved for the NV Cache Power Management feature set
0010h	ADD LBA(S) TO NV CACHE PINNED SET
0011h	REMOVE LBA(S) FROM NV CACHE PINNED SET
0012h	QUERY NV CACHE PINNED SET
0013h	QUERY NV CACHE MISSES
0014h	FLUSH NV CACHE
0015h	NV CACHE ENABLE
0016h	NV CACHE DISABLE
0017h-002Fh	Reserved for the NV Cache feature set
0030h-00CFh	Reserved
00D0h-00EFh	Vendor Specific
00F0h-FFFFh	Reserved

7.20.2 NV Cache Power Management Overview

The optional NV Cache Power Management feature set permits a host to modify the behavior of a device in a manner that allows the device to improve response times to read and write commands while reducing the device's power consumption.

Commands unique to the NV Cache Power Management feature set use a single command code and are differentiated from one another by the value placed in the Feature field. A device that implements the NV Cache Power Management feature set shall implement the following commands:

- a) SET NV CACHE POWER MODE; and
- b) RETURN FROM NV CACHE POWER MODE.

Individual NV Cache Power Management commands are identified by the value placed in the Feature field as shown in table 42.

Table 42 — NV Cache Power Management Commands

Value	Command Name
0000h	SET NV CACHE POWER MODE
0001h	RETURN FROM NV CACHE POWER MODE
0002h-000Fh	Reserved for the NV Cache Power Management feature set
0010h-002Fh	Reserved for the NV Cache feature set
0030h-00CFh	Reserved
00D0h-00EFh	Vendor Specific
00F0h-FFFFh	Reserved

7.20.3 ADD LBA(S) TO NV CACHE PINNED SET - B6h/10h, DMA**7.20.3.1 Feature set**

This 48-bit command is mandatory for devices implementing the NV Cache feature set.

7.20.3.2 Description

This command adds the logical blocks specified in the NV Cache Set Data to the NV Cache Pinned Set.

If the PI bit is set to one, then the command shall not complete until the NV Cache population is complete. If the PI bit is cleared to zero, then the command shall complete immediately and the population of the logical sector data shall be completed on subsequent Write operations to the LBA ranges that are in the NV Cache Pinned Set. If a Read operation occurs to an LBA marked for population before the logical sector data is populated in the NV Cache, then this data shall be sourced from the valid data located outside the Non-volatile cache and may require a disk spin up.

If an LBA Range Entry (see 7.20.3.6) specified in the NV Cache Set Data does exist but is beyond the range of user addressable logical blocks, the device shall add the logical blocks to the NV Cache Pinned Set, but continue to fail all reads and writes to the LBA as before.

The response to this command shall be the number of logical sectors that may be added to the NV Cache's pinned set.

7.20.3.3 Inputs**7.20.3.3.1 Overview**

Name	Description
Feature	0010h
Count	Number of 512-byte data blocks to be transferred. 0000h specifies that 65,536 blocks shall be transferred
LBA	<p>Bit Description</p> <p>47:1 Reserved</p> <p>0 Populate Immediately (PI) - See 7.20.3.3.2</p>
Device	<p>Bit Description</p> <p>7:5 N/A</p> <p>4 Transport Dependent - See 6.2.11</p> <p>3:0 Reserved</p>
Command	7:0 B6h

7.20.3.3.2 Populate Immediately

If the PI (Populate Immediately) bit is set to one, then the device shall add the logical blocks specified in the Pin Request Data (see table 43) to the device's NV Pinned Cache Set and populated with the specified data from the rotating media before command completion.

If PI is cleared to zero, then the logical blocks specified in the Pin Request Data shall be added to the device's NV Pinned Cache Set and:

- a) the LBA in the pinned set shall be populated with data from a subsequent write operation; and
- b) the LBA in the pinned set may be populated with data from a subsequent read operation.

7.20.3.4 Normal Outputs

See table 114.

7.20.3.5 Error Outputs

If this command fails, none of the requested logical blocks are added to the NV Cache Pinned Set. See table 153 for more information.

7.20.3.6 Output From the Host to the Device Data Structure

Pin Request Data is a list of individual LBA ranges. Each entry in the Pin Request Data is called a LBA Range Entry (see 4.16.3.2). If the range length is 0 then the LBA Range Entry is not valid. The range entries shall be non-overlapping and shall be sorted with the LBA values in ascending order.

Table 43 — Request Pin Data

Byte	Type	Description
0-7	QWord	Entry #0 63:48 Range Length 47:0 LBA Value
8-15	QWord	Entry #1 63:48 Range Length 47:0 LBA Value
...		...
496-511	QWord	Entry #63 63:48 Range Length 47:0 LBA Value

7.20.4 FLUSH NV CACHE - B6h/14h, Non-Data

7.20.4.1 Feature set

This 48-bit command is mandatory for devices implementing the NV Cache feature set.

7.20.4.2 Description

When the device processes a FLUSH NV CACHE command, the device shall provide at least as many logical blocks as are specified in LBA (31:0) for use by the NV Cache Pinned Set. If necessary the device flushes logical blocks from the NV Cache Unpinned Set to provide the capacity requested. The device may spin-up to complete this command. The logical blocks shall remain available until the next reset or NV Cache feature set command is processed by the device.

7.20.4.3 Inputs

Name	Description
Feature	0014h
Count	Reserved
LBA	<p>Bit Description</p> <p>47:32 Reserved</p> <p>31:0 Minimum number of logical blocks to flush</p>
Device	<p>Bit Description</p> <p>7:5 N/A</p> <p>4 Transport Dependent - See 6.2.11</p> <p>3:0 Reserved</p>
Command	7:0 B6h

7.20.4.4 Normal Outputs

The number of unflushed logical blocks is the number of logical blocks that have yet to be flushed from the NV Cache Unpinned Set to satisfy the Minimum Number of logical blocks to flush or to empty the NV Cache Unpinned Set, whichever is less. See table 115.

7.20.4.5 Error Outputs

See table 155.

7.20.5 NV CACHE DISABLE- B6h/16h, Non-Data**7.20.5.1 Feature set**

This 48-bit command is mandatory for devices implementing the NV Cache feature set.

7.20.5.2 Description

In response to receiving this command, the device shall perform the following actions:

- a) flush all non-volatile cached data (both pinned and unpinned data) to other non-volatile media;
- b) erase the pinned logical sectors list;
- c) disable the NV Cache Power Management feature set; and
- d) no longer read user data from or write user data to the non-volatile cache.

Once the device has reported successful command completion, the device shall return command aborted for all commands in the NV Cache feature set except for NV CACHE ENABLE (see 7.20.6).

This setting is non-volatile.

7.20.5.3 Inputs

Name	Description
Feature	0016h
Count	Reserved
LBA	Reserved
Device	<p style="text-align: center;">Bit Description</p> <p>7:5 N/A</p> <p>4 Transport Dependent - See 6.2.11</p> <p>3:0 Reserved</p>
Command	7:0 B6h

7.20.5.4 Normal Outputs

See table 111.

7.20.5.5 Error Outputs

See table 155.

7.20.6 NV CACHE ENABLE - B6h/15h, Non-Data**7.20.6.1 Feature set**

This 48-bit command is mandatory for devices implementing the NV Cache feature set.

7.20.6.2 Description

In response to this command, the device may read data from or write data to the non-volatile cache.

This setting is non-volatile.

7.20.6.3 Inputs

Name	Description
Feature	0015h
Count	Reserved
LBA	Reserved
Device	<p style="text-align: center;">Bit Description</p> <p>7:5 N/A</p> <p>4 Transport Dependent - See 6.2.11</p> <p>3:0 Reserved</p>
Command	7:0 B6h

7.20.6.4 Normal Outputs

See table 111.

7.20.6.5 Error Outputs

See table 155.

7.20.7 QUERY NV CACHE MISSES - B6h/13h, DMA**7.20.7.1 Feature set**

This 48-bit command is mandatory for devices implementing the NV Cache feature set.

7.20.7.2 Description

This command requests the device to report Cache Miss Data (see table 44) in LBA Ranges in a single 512-byte block. The first 64 cache misses are returned as LBA Ranges and shall be listed in accessed order. If the device does not have as many LBA ranges as are requested in the transfer, the unused LBA ranges shall be filled with zeroes.

Any of the following conditions shall cause the Cache Miss Data to be cleared:

- a) the device processes a power-on reset;
- b) the device completes a QUERY NV CACHE MISSES command; or
- c) the device completes a STANDBY IMMEDIATE command.

7.20.7.3 Inputs

Name	Description
Feature	0013h
Count	0001h
LBA	Reserved
Device	<p style="text-align: center;">Bit Description</p> <p>7:5 N/A</p> <p>4 Transport Dependent - See 6.2.11</p> <p>3:0 Reserved</p>
Command	7:0 B6h

7.20.7.4 Normal Outputs

See table 114.

7.20.7.5 Error Outputs

See table 156.

7.20.7.6 Input From the Device to the Host Data Structure

Cache Miss Data is a list of individual LBA ranges. Each entry in Cache Miss Data is called a LBA Range Entry (see 4.16.3.2) and is represented by 8 bytes. If the range length is 0 then the LBA Range Entry is not valid.

Table 44 — Cache Miss Data

Byte	Type	Description
0-7	QWord	Entry #0 63:48 Range Length 47:0 LBA Value
8-15	QWord	Entry #1 63:48 Range Length 47:0 LBA Value
...		...
496-511	QWord	Entry #63 63:48 Range Length 47:0 LBA Value

7.20.8 QUERY NV CACHE PINNED SET - B6h/12h, DMA**7.20.8.1 Feature set**

This 48-bit command is mandatory for devices implementing the NV Cache feature set.

7.20.8.2 Description

This command requests the device to send the LBA Ranges currently in the NV Cache Pinned Set in one or more 512-byte blocks equal to the number in Block Count. If a device does not have as many LBA Ranges as are requested in the transfer, the unused LBA Range Entries shall be filled with zero.

7.20.8.3 Inputs

Name	Description
Feature	0012h
Count	Number of 512-byte data blocks to be transferred. 0000h specifies that 65,536 blocks shall be transferred
LBA	Starting 512-byte data block. The first 512-byte data block is numbered zero.
Device	<p>Bit Description</p> <p>7:5 N/A</p> <p>4 Transport Dependent - See 6.2.11</p> <p>3:0 Reserved</p>
Command	7:0 B6h

7.20.8.4 Normal Outputs

See table 114.

7.20.8.5 Error Outputs

See table 156.

7.20.8.6 Input From the Device to the Host Data Structure

Pin Set Data is a list of individual LBA ranges. Each entry in Pin Set Data is called a LBA Range Entry (see 4.16.3.2) and is represented by 8 bytes. The LBA Range Entries shall be sent in ascending numerical order by LBA value.

Table 45 — Pin Set Data

Byte	Word	Description
0-7	QWord	Entry #0 63:48 Range Length 47:0 LBA Value
8-15	QWord	Entry #1 63:48 Range Length 47:0 LBA Value
...		...
496-511	QWord	Entry #63 63:48 Range Length 47:0 LBA Value

7.20.9 REMOVE LBA(S) FROM NV CACHE PINNED SET - B6h/11h, DMA/Non-Data**7.20.9.1 Feature set**

This 48-bit command is mandatory for devices implementing the NV Cache feature set.

7.20.9.2 Description

This command removes the logical blocks specified in the NV Cache Set Data from the NV Cache's pinned set. This command may not remove the logical blocks from the NV Cache.

If the NV Cache Set Data specifies an LBA not in the NV Cache Pinned Set, the LBA shall be ignored without causing an error.

The response to this command shall be the number of additional logical blocks that the host may add to the NV Cache's pinned working set as specified in the Count and LBA fields.

7.20.9.3 Inputs**7.20.9.3.1 Overview**

Name	Description
Feature	0011h
Count	Number of 512-byte data blocks to be transferred. 0000h specifies that 65,536 blocks shall be transferred
LBA	<p>Bit Description</p> <p>47:1 Reserved</p> <p>0 Unpin All (UA) - See 7.20.9.3.2</p>
Device	<p>Bit Description</p> <p>7:5 N/A</p> <p>4 Transport Dependent - See 6.2.11</p> <p>3:0 Reserved</p>
Command	7:0 B6h

7.20.9.3.2 Unpin All

If the UA (Unpin All) bit is set to one, then the device shall:

- a) ignore the value in the Count field;
- b) unmap all logical blocks in the NV Cache Pinned Set; and
- c) use the Non-Data protocol.

7.20.9.4 Normal Outputs

See table 114.

7.20.9.5 Error Outputs

If a device completes this command with an error, then none of the requested logical blocks are removed from the NV Cache Pinned Set. See table 154.

7.20.9.6 Output From the Host to the Device Data Structure

Remove Pin Data is a list of individual LBA ranges. Each entry in Remove Pin Data is called a LBA Range Entry (see 4.16.3.2) and is represented by 8 bytes. If the range length is 0 then the LBA Range Entry is not valid. The range entries shall be non-overlapping and sorted with the LBA Values in ascending order

Table 46 — Remove Pin Data

Byte	Type	Description
0-7	QWord	Entry #0 63:48 Range Length 47:0 LBA Value
8-15	QWord	Entry #1 63:48 Range Length 47:0 LBA Value
...		...
496-511	QWord	Entry #63 63:48 Range Length 47:0 LBA Value

7.20.10 RETURN FROM NV CACHE POWER MODE - B6h/01h, Non-Data

7.20.10.1 Feature set

This 48-bit command is mandatory for devices implementing the NV Cache Power Management feature set.

7.20.10.2 Description

This command shall cause the device to disable the NV Cache power mode and clear IDENTIFY DEVICE word 214 bit 1. Upon completion of this command the device shall disable the NV Cache power mode timer.

This command shall not enable or disable the non-volatile cache or the NV Cache feature set.

7.20.10.3 Inputs

Name	Description
Feature	0001h
Count	Reserved
LBA	Reserved
Device	<p style="text-align: center;">Bit Description</p> <p>7:5 N/A</p> <p>4 Transport Dependent - See 6.2.11</p> <p>3:0 Reserved</p>
Command	7:0 B6h

7.20.10.4 Normal Outputs

See table 99.

7.20.10.5 Error Outputs

See table 125

7.20.11 SET NV CACHE POWER MODE - B6h/00h, Non-Data**7.20.11.1 Feature set**

This 48-bit command is mandatory for devices implementing the NV Cache Power Management feature set.

7.20.11.2 Description

This command shall cause the device to set the NV Cache power mode timer and set IDENTIFY DEVICE data word 214 bit 1 to one. The device should minimize power consumption and use the NV Cache to complete read and write requests whenever possible.

When the device spins-up its rotating media, the rotating media shall remain spun-up for at least as many seconds as the value in the Count field.

If the standby timer expires before the NV Cache power mode timer, the device shall not transition to Standby mode until the NV Cache power mode timer expires. APM shall not cause the device to transition to a lower power state until the NV Cache power mode timer expires.

7.20.11.3 Inputs**7.20.11.3.1 Overview**

Name	Description
Feature	0000h
Count	Minimum High-Power Time - See 7.20.11.3.2
LBA	Reserved
Device	<p>Bit Description</p> <p>7:5 N/A</p> <p>4 Transport Dependent - See 6.2.11</p> <p>3:0 Reserved</p>
Command	7:0 B6h

7.20.11.3.2 Minimum High-Power Time

Minimum High-Power Time contains the minimum value, in seconds, that the device shall stay in the Active or Idle state when the device needs to enter the high power state to access its media while NV CACHE power mode is set. The high power state may include any Power Management state in which the media is spun up and available.

The maximum amount of time the device shall keep the media spun up is vendor specific.

7.20.11.4 Normal Outputs

See table 99.

7.20.11.5 Error Outputs

See table 125

7.21 NOP - 00h, Non-Data

7.21.1 Feature Set

This 28-bit command is mandatory for ATAPI devices and for devices implementing the TCQ feature set.

7.21.2 Description

The subcommand determines the effect on TCQ commands (see table 47).

7.21.3 Inputs

Name	Description
Feature	Subcommand Code (see table 47)
Count	N/A
LBA	N/A
Device	<p>Bit Description</p> <ul style="list-style-type: none"> 7 Obsolete 6 N/A 5 Obsolete 4 Transport Dependent - See 6.2.11 3:0 Reserved
Command	7:0 00h

Table 47 — NOP Subcommand Code

Subcommand Code	Description	Action
00h	NOP	Return command aborted and abort any outstanding queued commands.
01h	NOP Auto Poll	When processed by a device, write all data in the write cache to the media, return command aborted and do not abort any outstanding TCQ commands (see 4.24.2). When processed by a host adapter that supports hardware polling, initiate hardware polling, do not transmit the command to the device, and return command aborted (see 4.24.1).
02h-FFh	Reserved	Return command aborted and do not abort any outstanding TCQ commands.

7.21.4 Normal Outputs

When processed by a device, this command always fails with an error (see table 47).

When subcommand code 01h is processed by a host adapter as a host adapter function (see 4.24), see table 99.

The Count and LBA fields retain the values that were present when the NOP command was accepted.

7.21.5 Error Outputs

See table 142

7.22 PACKET - A0h, Packet

7.22.1 Feature Set

This 28-bit command is mandatory for devices implementing the PACKET feature set.

7.22.2 Description

The PACKET command transfers a SCSI Command Descriptor Block (CDB) via a command packet. If the native form of the encapsulated command is shorter than the packet size reported in bits (1:0) of word 0 of the IDENTIFY PACKET DEVICE data, the encapsulated command shall begin at byte 0 of the packet. Packet bytes beyond the end of the encapsulated command are reserved.

7.22.3 Inputs

Name	Description
Feature	<p>Bit Description</p> <p>7:3 Reserved</p> <p>2 DMADIR - See 7.22.4</p> <p>1 Obsolete</p> <p>0 DMA - This bit is set to one to inform the device that the data transfer (i.e., not the command packet transfer) associated with this command is via Multiword DMA or Ultra DMA mode.</p>
Count	<p>Bit Description</p> <p>7:3 Obsolete</p> <p>2:0 N/A</p>
LBA	<p>Bit Description</p> <p>27:24 Reserved</p> <p>23:8 Byte Count Limit - See 7.22.5</p> <p>7:0 Reserved</p>
Device	<p>Bit Description</p> <p>7 Obsolete</p> <p>6 N/A</p> <p>5 Obsolete</p> <p>4 Transport Dependent - See 6.2.11</p> <p>3:0 Reserved</p>
Command	7:0 A0h

7.22.4 DMADIR

The DMADIR bit indicates the direction of the DMA data transfer for the PACKET command and is used only for ATAPI devices that require direction indication from the host. If IDENTIFY PACKET DEVICE data word 62 bit 15 is set to one, then the device requires the use of the DMADIR bit for DMA data transfer for PACKET commands.

If the device requires the DMADIR bit to be set to one for a DMA data transfer for a PACKET command (i.e., bit 0, the DMA bit, is set to one), then this bit indicates the direction of data transfer (i.e., 0 = transfer to the device, and 1 = transfer to the host). If the device requires the DMADIR bit to be set for a DMA data transfer for a PACKET command, but the current operation is a PIO data transfer (i.e., bit 0, the DMA bit, is cleared to zero), then this bit is ignored.

Since the data transfer direction is set by the host as the command is constructed, the DMADIR bit should not conflict with the data transfer direction of the command. If a conflict between the command transfer direction and the DMADIR bit occurs, the device should return with an ABORTED command, and the sense key set to ILLEGAL REQUEST.

If the device does not require the DMADIR bit to be set for a DMA data transfer for a PACKET command, then this bit should be cleared to zero.

A device that does not support the DMADIR feature may return command aborted for a command if the DMADIR bit is set to one.

7.22.5 Byte Count Limit

The Byte Count Limit is the maximum byte count that is to be transferred in any single DRQ data block for PIO transfers. The Byte Count Limit does not apply to the command packet transfer. If the PACKET command does not transfer data, the Byte Count Limit is ignored.

NOTE 15 — The amount of data transferred by this command is specified in the CDB.

If the PACKET command results in a data transfer, then:

- a) the host should not set the Byte Count Limit to zero (see 7.17.6.49);
- b) if the total requested data transfer length is greater than the Byte Count Limit, then the value set into the Byte Count Limit shall be even;
- c) if the total requested data transfer length is equal to or less than the Byte Count Limit, then the value set into the Byte Count Limit may be odd; and
- d) the value FFFFh shall be interpreted by the device as though the value were FFFEh.

7.22.6 Normal Outputs

7.22.6.1 Awaiting command

When the device is ready to accept the command packet from the host the return structure shall be set according to table 106. The Input/Output bit shall be cleared to zero, and the Command/Data bit shall be set to one. The Byte Count Limit shall reflect the value set by the host when the command was issued.

7.22.6.2 Data transmission

Data transfer shall occur after the receipt of the command packet. See table 106 for the return structure when the device is ready to transfer data requested by a data transfer command. Input/Output is ignored, and Command/Data shall be set to zero.

If the transfer is to be in PIO mode, then the byte count of the data to be transferred for this DRQ data block shall be:

- a) not equal to zero;
- b) less than or equal to the byte count limit value received from the host;
- c) less than or equal to FFFEh; and
- d) even if this is not the the last transfer of a command.

If this is the last transfer for a command in PIO mode, then the byte count for the DRQ data block may be odd. If the data block is odd, then the last byte transferred shall be a pad byte (i.e., to make the total number of bytes transferred be even). The value of the pad byte is undefined.

7.22.6.3 Successful command completion

When the device has command completion without error, the device returns the data structure found in table 106. Input/Output shall be set to one, Command/Data shall be set to one. Byte Count is reserved at command completion.

7.22.7 Error Outputs

The device shall not terminate the PACKET command with an error before the last byte of the command packet has been written. See table 143.

7.23 READ BUFFER - E4h, PIO Data-In

7.23.1 Feature Set

This 28-bit command is optional for devices not implementing the PACKET feature set.

7.23.2 Description

The READ BUFFER command enables the host to read a 512-byte block of data.

The READ BUFFER and WRITE BUFFER commands shall be synchronized such that sequential WRITE BUFFER and READ BUFFER commands access the same data.

The command prior to a READ BUFFER command should be a WRITE BUFFER command. If the READ BUFFER command is not preceded by a WRITE BUFFER command, the data returned by READ BUFFER may be indeterminate.

7.23.3 Inputs

Name	Description
Feature	N/A
Count	N/A
LBA	N/A
Device	<p>Bit Description</p> <p>7 Obsolete</p> <p>6 N/A</p> <p>5 Obsolete</p> <p>4 Transport Dependent - See 6.2.11</p> <p>3:0 Reserved</p>
Command	7:0 E4h

7.23.4 Normal Outputs

See table 99.

7.23.5 Error Outputs

A device may return command completion with the Error bit set to one if an Interface CRC error has occurred. See table 123.

NOTE 16 — There is no defined mechanism for a device to return an Interface CRC error status that may have occurred during the last data block of a PIO-in data transfer; there may be other mechanisms in which a host may verify that an Interface CRC error occurred in these cases.

7.24 READ DMA - C8h, DMA

7.24.1 Feature Set

This 28-bit command is mandatory for devices not implementing the PACKET feature set.

7.24.2 Description

The READ DMA command allows the host to read data using the DMA data transfer protocol.

7.24.3 Inputs

Name	Description
Feature	N/A
Count	The number of logical sectors to be transferred. A value of 00h indicates that 256 logical sectors are to be transferred
LBA	LBA of first logical sector to be transferred
Device	<p>Bit Description</p> <ul style="list-style-type: none"> 7 Obsolete 6 Shall be set to one 5 Obsolete 4 Transport Dependent - See 6.2.11 3:0 Reserved
Command	7:0 C8h

7.24.4 Normal Outputs

See table 99.

7.24.5 Error Outputs

If an unrecoverable error occurs while the device is processing this command, then the device shall return command completion with the Error bit set to one and the LBA field set to the LBA of the logical sector where the first unrecoverable error occurred. The validity of the data transferred is indeterminate. See table 130.

7.25 READ DMA EXT - 25h, DMA

7.25.1 Feature Set

This 48-bit command is mandatory for devices implementing the 48-bit Address feature set.

7.25.2 Description

The READ DMA EXT command allows the host to read data using the DMA data transfer protocol.

7.25.3 Inputs

Name	Description
Feature	Reserved
Count	The number of logical sectors to be transferred. A value of 0000h indicates that 65,536 logical sectors are to be transferred
LBA	LBA of first logical sector to be transferred
Device	<p>Bit Description</p> <ul style="list-style-type: none"> 7 Obsolete 6 Shall be set to one 5 Obsolete 4 Transport Dependent - See 6.2.11 3:0 Reserved
Command	7:0 25h

7.25.4 Normal Outputs

See table 111.

7.25.5 Error Outputs

If an unrecoverable error occurs while the device is processing this command, then the device shall return command completion with the Error bit set to one and the LBA field set to the LBA of the logical sector where the first unrecoverable error occurred. The validity of the data transferred is indeterminate. See table 131.

7.26 READ DMA QUEUED - C7h, DMA Queued

7.26.1 Feature Set

This 28-bit command is mandatory for devices implementing the TCQ feature set.

7.26.2 Description

A device processes this command in a similar manner to a READ DMA command. The device may perform a release or may process the data transfer without performing a release if the data is ready to transfer.

7.26.3 Inputs

Name	Description
Feature	The number of logical sectors to be transferred. A value of 00h indicates that 256 logical sectors are to be transferred
Count	<p>Bit Description</p> <p>7:3 Tag - See 6.4.5</p> <p>2:0 N/A</p>
LBA	LBA of first logical sector to be transferred
Device	<p>Bit Description</p> <p>7 Obsolete</p> <p>6 Shall be set to one</p> <p>5 Obsolete</p> <p>4 Transport Dependent - See 6.2.11</p> <p>3:0 Reserved</p>
Command	7:0 C7h

7.26.4 Normal Outputs

7.26.4.1 Data transmission

Data transfer may occur after receipt of the command or may occur after the receipt of a SERVICE command. When the device is ready to transfer data requested by a data transfer command, the device returns the data structure described in table 107. Release shall be cleared to zero, Input/Output shall be set to one, and Command/Data shall be cleared to zero.

7.26.4.2 Release

If the device performs a release before transferring data for this command, the device returns the data structure described in table 107. Release shall be set to one, Input/Output shall be cleared to zero, and Command/Data shall be cleared to zero.

7.26.4.3 Service request

When the device is ready to transfer data or complete a command after the command has performed a release, the device shall set the Service bit to one and not change the state of any other bit in the Status field. When the SERVICE command is received, the device shall set outputs as described in 7.26.4.1, 7.26.4.4, or 7.26.5 on the service the device requires.

7.26.4.4 Command completion

When the transfer of all requested data has occurred without error, the device returns the data structure described in table 107. Release shall be cleared to zero, Input/Output shall be set to one, and Command/Data shall be set to one.

7.26.5 Error Outputs

The Interrupt Reason field contains the Tag for this command. The device shall return command aborted if the device supports the TCQ feature set and the Tag is invalid. If an unrecoverable error occurs while the device is processing this command, then the device shall return command completion with the Error bit set to one and the LBA field set to the LBA of the logical sector where the first unrecoverable error occurred. If write cache is enabled, unrecoverable errors may not be reported because they may occur after the completion of the command. The validity of the data transferred is indeterminate. If a device completes a TCQ command with an error, and there are other TCQ commands in the queue, then the device shall abort all of the commands in the queue and shall not report status for those commands. See table 144.

7.27 READ DMA QUEUED EXT- 26h, DMA Queued

7.27.1 Feature Set

This 48-bit command is mandatory for devices implementing both the TCQ and 48-bit feature sets

7.27.2 Description

A device processes this command in a similar manner to a READ DMA EXT command. The device may perform a release or may process the data transfer without performing a release if the data is ready to transfer.

7.27.3 Inputs

Name	Description
Feature	The number of logical sectors to be transferred. A value of 0000h indicates that 65,536 logical sectors are to be transferred
Count	<p>Bit Description</p> <p>15:8 Reserved</p> <p>7:3 Tag - See 6.4.5</p> <p>2:0 N/A</p>
LBA	LBA of first logical sector to be transferred
Device	<p>Bit Description</p> <p>7 Obsolete</p> <p>6 Shall be set to one</p> <p>5 Obsolete</p> <p>4 Transport Dependent - See 6.2.11</p> <p>3:0 Reserved</p>
Command	7:0 26h

7.27.4 Normal Outputs

7.27.4.1 Data transmission

Data transfer may occur after receipt of the command or may occur after the receipt of a SERVICE command. When the device is ready to transfer data requested by a data transfer command, the device returns the data structure described in table 113. Release shall be cleared to zero, Input/Output shall be set to one, and Command/Data shall be cleared to zero.

7.27.4.2 Release

If the device performs a release before transferring data for this command, the device returns the data structure described in table 113. Release shall be set to one, Input/Output shall be cleared to zero, and Command/Data shall be cleared to zero.

7.27.4.3 Service request

When the device is ready to transfer data or complete a command after the command has performed a release, the device shall set the Service bit to one and not change the state of any other status bit. When the SERVICE command is received, the device shall set outputs as described in 7.27.4.1, 7.27.4.4, or 7.27.5 depending on the service the device requires.

7.27.4.4 Command completion

When the transfer of all requested data has occurred without error, the device returns the data structure described in table 113. Release shall be cleared to zero, Input/Output shall be set to one, and Command/Data shall be set to one.

7.27.5 Error Outputs

The Interrupt Reason field contains the Tag for this command. The device shall return command aborted if the device supports the TCQ feature set and the Tag is invalid. If an unrecoverable error occurs while the device is processing this command, then the device shall return command completion with the Error bit set to one and the LBA field set to the LBA of the logical sector where the first unrecoverable error occurred. If write cache is enabled, unrecoverable errors may not be reported as they may occur after the completion of the command. If a device completes a TCQ command with an error, and there are other TCQ commands in the queue, then the device shall abort all of the commands in the queue and shall not report status for those commands. The validity of the data transferred is indeterminate. See table 145.

7.28 READ FPDMA QUEUED - 60h, DMA Queued

7.28.1 Feature Set

This 48-bit command is mandatory for devices implementing the NCQ feature set.

7.28.2 Description

This command requests data to be transferred from the device to the host.

7.28.3 Inputs

7.28.3.1 Overview

Name	Description
Feature	The number of logical sectors to be transferred. A value of 0000h indicates that 65,536 logical sectors are to be transferred
Count	<p>Bit Description</p> <p>15:8 Reserved</p> <p>7:3 NCQ Tag - See 6.5.2</p> <p>2:0 N/A</p>
LBA	LBA of first logical sector to be transferred
Device	<p>Bit Description</p> <p>7 FUA - See 7.28.3.2</p> <p>6 Shall be set to one</p> <p>5 Reserved</p> <p>4 Shall be set to zero</p> <p>3:0 Reserved</p>
Command	7:0 60h

7.28.3.2 Forced Unit Access (FUA)

When the FUA bit is set to one the device shall retrieve the data from the non-volatile media regardless of whether the device holds the requested information in its volatile cache. If the device holds a modified copy of the requested data as a result of having volatile cached writes, the modified data shall be written to the non-volatile media before being retrieved from the non-volatile media as part of this operation. When the FUA bit is cleared to zero the data shall be retrieved either from the device's non-volatile media or cache.

7.28.4 Command Acceptance Outputs

See table 116

7.28.5 Normal Outputs

See table 117.

7.28.6 Error Outputs

This return indicates that the command was aborted due to LBA out of range, a duplicate tag number, an invalid tag number, or an Interface CRC error, see table 157 for more information.

Errors that occur during the processing of this command are reported by returning a transport dependent indicator with additional information available in the NCQ Command Error log. The validity of the data transferred is indeterminate. See table 159.

7.29 READ LOG EXT - 2Fh, PIO Data-In

7.29.1 Feature Set

This 48-bit command is mandatory for devices implementing the GPL feature set.

7.29.2 Description

This command returns the specified log to the host. See table A.2 for the list of logs.

7.29.3 Inputs

7.29.3.1 Overview

All the logs in this standard reserve the Feature field unless otherwise specified.

Name	Description
Feature	Log Specific
Count	Block Count - See 7.29.3.2
LBA	<p>Bit Description</p> <p>47:40 Reserved</p> <p>39:32 Page # (15:8) - See 7.29.3.4.</p> <p>31:16 Reserved</p> <p>15:8 Page # (7:0) - See 7.29.3.4.</p> <p>7:0 Log Address - See 7.29.3.3.</p>
Device	<p>Bit Description</p> <p>7 Obsolete</p> <p>6 N/A</p> <p>5 Obsolete</p> <p>4 Transport Dependent - See 6.2.11</p> <p>3:0 Reserved</p>
Command	7:0 2Fh

7.29.3.2 Block Count

Specifies the number of 512-byte blocks of data to be read from the specified log. The log transferred by the device shall start at the block of data in the specified log at the specified offset, regardless of the block count requested. A value of zero is illegal and shall result in command aborted.

7.29.3.3 Log Address

Specifies the log to be read as described in table A.2. A device may support a subset of the available logs. Support for individual logs is determined by support for the associated feature set. Support of the associated log(s) is mandatory for devices implementing the associated feature.

7.29.3.4 Page

Specifies the first log page (see 3.1.40) to be read from the specified log address. The first page number shall be zero.

7.29.4 Normal Outputs

See table 111.

7.29.5 Error Outputs

A device shall return command aborted if:

- a) the feature set associated with the log specified in the LBA field (7:0) is not supported or not enabled;
- b) the values in other fields are invalid (e.g., the Count field is cleared to zero); or
- c) the value in the Page # field plus the value in the Count field is larger than the log size reported in the General Purpose Log Directory.

A device may return command aborted if an Interface CRC error has occurred. The validity of the data transferred is indeterminate.

See table 132.

NOTE 17 — There is no defined mechanism for a device to return an Interface CRC error status that may have occurred during the last data block of a PIO-in data transfer; there may be other mechanisms in which a host may verify that an Interface CRC error occurred in these cases.

7.30 READ LOG DMA EXT - 47h, DMA

7.30.1 Feature Set

This 48-bit command is optional for devices implementing the General Purpose Logging feature set.

7.30.2 Description

See 7.29.2.

7.30.3 Inputs

See 7.29.3.

7.30.4 Normal Outputs

See 7.29.4.

7.30.5 Error Outputs

See 7.29.5.

7.31 READ MULTIPLE - C4h, PIO Data-In

7.31.1 Feature Set

This 28-bit command is mandatory for devices implementing the General feature set.

7.31.2 Description

This command reads the number of logical sectors specified in the Count field.

The number of logical sectors per DRQ data block is defined by the content of IDENTIFY DEVICE data word 59. The device shall interrupt for each DRQ data block transferred.

If the number of requested logical sectors is not evenly divisible by the DRQ data block count, as many full DRQ data blocks as possible are transferred, followed by a final, partial DRQ data block transfer. The partial DRQ data block transfer shall be for n logical sectors, where $n = \text{remainder}(\text{Count} / \text{DRQ data block count})$.

Device errors encountered during READ MULTIPLE commands are posted at the beginning of the block or partial block transfer.

If a READ MULTIPLE command is received by the device and:

- a) IDENTIFY DEVICE data word 59 bit 8 is cleared to zero; or
- b) IDENTIFY DEVICE data word 59 bit 8 is set to one and bits 7:0 are set to zero,

then the device shall return command aborted. A successful SET MULTIPLE MODE command should precede a READ MULTIPLE command.

7.31.3 Inputs

Name	Description
Feature	N/A
Count	The number of logical sectors to be transferred. A value of 00h indicates that 256 logical sectors are to be transferred
LBA	LBA of first logical sector to be transferred
Device	<p>Bit Description</p> <ul style="list-style-type: none"> 7 Obsolete 6 Shall be set to one 5 Obsolete 4 Transport Dependent - See 6.2.11 3:0 Reserved
Command	7:0 C4h

7.31.4 Normal Outputs

See table 99.

7.31.5 Error Outputs

If an unrecoverable error occurs while the device is processing this command, then the device shall return command completion with the Error bit set to one and the LBA field set to the LBA of the logical sector where the first unrecoverable error occurred. The validity of the data transferred is indeterminate. A device may return command completion with the Error bit set to one if an Interface CRC error has occurred. See table 133.

NOTE 18 — There is no defined mechanism for a device to return an Interface CRC error status that may have occurred during the last data block of a PIO-in data transfer; there may be other mechanisms in which a host may verify that an Interface CRC error occurred in these cases.

7.32 READ MULTIPLE EXT - 29h, PIO Data-In

7.32.1 Feature Set

This 48-bit command is mandatory for all devices implementing the 48-bit Address feature set.

7.32.2 Description

This command reads the number of logical sectors specified in the Count field.

The number of logical sectors per DRQ data block is defined by the content of word 59 in the IDENTIFY DEVICE data. The device shall interrupt for each DRQ data block transferred.

If the number of requested logical sectors is not evenly divisible by the DRQ data block count, as many full DRQ data blocks as possible are transferred, followed by a final, partial DRQ data block transfer. The partial DRQ data block transfer shall be for n logical sectors, where $n = \text{remainder}(\text{Count} / \text{DRQ data block count})$.

Device errors encountered during READ MULTIPLE EXT commands are posted at the beginning of the block or partial block transfer.

If IDENTIFY DEVICE data word 59 bit 8 is cleared to zero, and a READ MULTIPLE EXT command is received by the device, and no successful SET MULTIPLE MODE command has been processed by the device, the device shall return command aborted. A successful SET MULTIPLE MODE command should precede a READ MULTIPLE EXT command.

7.32.3 Inputs

Name	Description
Feature	Reserved
Count	The number of logical sectors to be transferred. A value of 0000h indicates that 65,536 logical sectors are to be transferred
LBA	LBA of first logical sector to be transferred
Device	<p>Bit Description</p> <ul style="list-style-type: none"> 7 Obsolete 6 Shall be set to one 5 Obsolete 4 Transport Dependent - See 6.2.11 3:0 Reserved
Command	7:0 29h

7.32.4 Normal Outputs

See table 111.

7.32.5 Error Outputs

If an unrecoverable error occurs while the device is processing this command, then the device shall return command completion with the Error bit set to one and the LBA field set to the LBA of the logical sector where the first unrecoverable error occurred. The validity of the data transferred is indeterminate. A device may return command completion with the Error bit set to one if an Interface CRC error has occurred. See table 147.

NOTE 19 — There is no defined mechanism for a device to return an Interface CRC error status that may have occurred during the last data block of a PIO-in data transfer; there may be other mechanisms in which a host may verify that an Interface CRC error occurred in these cases.

7.33 READ NATIVE MAX ADDRESS - F8h, Non-Data

7.33.1 Feature Set

This 28-bit command is mandatory for devices implementing the HPA feature set.

7.33.2 Description

This command returns the native max address. The native max address returned is the maximum LBA that is valid when using the SET MAX ADDRESS command.

If the 48-bit Address feature set is supported and the 48-bit native max address is greater than 268,435,455, the READ NATIVE MAX ADDRESS command shall return a maximum value of 268,435,454.

7.33.3 Inputs

Name	Description
Feature	N/A
Count	N/A
LBA	N/A
Device	<p>Bit Description</p> <ul style="list-style-type: none"> 7 Obsolete 6 Shall be set to one 5 Obsolete 4 Transport Dependent - See 6.2.11 3:0 Reserved
Command	7:0 F8h

7.33.4 Normal Outputs

See table 108. LBA contains the native max address.

7.33.5 Error Outputs

See table 125.

7.34 READ NATIVE MAX ADDRESS EXT - 27h, Non-Data

7.34.1 Feature Set

This 48-bit command is mandatory for devices implementing both the HPA feature set and the 48-bit Address feature set.

7.34.2 Description

This command returns the native max address. The native max address returned is the maximum LBA that is valid when using the SET MAX ADDRESS EXT command.

7.34.3 Inputs

Name	Description
Feature	N/A
Count	N/A
LBA	N/A
Device	<p style="text-align: center;">Bit Description</p> <ul style="list-style-type: none"> 7 Obsolete 6 Shall be set to one 5 Obsolete 4 Transport Dependent - See 6.2.11 3:0 Reserved
Command	7:0 27h

7.34.4 Normal Outputs

See table 112. LBA contains the native max address.

7.34.5 Error Outputs

See table 148.

7.35 READ SECTOR(S) - 20h, PIO Data-In

7.35.1 Feature Set

This 28-bit command is mandatory for all devices implementing the General and PACKET feature sets.

7.35.2 Description

This command reads from 1 to 256 logical sectors as specified in the Count field. The transfer shall begin at the logical sector specified in the LBA field.

7.35.3 Inputs

Name	Description
Feature	N/A
Count	The number of logical sectors to be transferred. A value of 00h indicates that 256 logical sectors are to be transferred
LBA	LBA of first logical sector to be transferred
Device	<p>Bit Description</p> <ul style="list-style-type: none"> 7 Obsolete 6 Shall be set to one 5 Obsolete 4 Transport Dependent - See 6.2.11 3:0 Reserved
Command	7:0 20h

7.35.4 Outputs

7.35.5 Normal Outputs

See table 99.

7.35.6 Outputs for PACKET feature set devices

In response to this command, ATAPI shall report command aborted and place the ATAPI device signature in the LBA field (23:8), see table 104 for a list of the possible signatures.

7.35.7 Error Outputs

The validity of the data transferred is indeterminate. A device may return command completion with the Error bit set to one if an Interface CRC error has occurred. See table 133.

NOTE 20 — There is no defined mechanism for a device to return an Interface CRC error status that may have occurred during the last data block of a PIO-in data transfer; there may be other mechanisms in which a host may verify that an Interface CRC error occurred in these cases.

7.36 READ SECTOR(S) EXT - 24h, PIO Data-In

7.36.1 Feature Set

This 48-bit command is mandatory for devices implementing the 48-bit Address feature set

7.36.2 Description

This command reads from 1 to 65,536 logical sectors as specified in the Count field. The transfer shall begin at the logical sector specified in the LBA field.

7.36.3 Inputs

Name	Description
Feature	Reserved
Count	The number of logical sectors to be transferred. A value of 0000h indicates that 65,536 logical sectors are to be transferred
LBA	LBA of first logical sector to be transferred
Device	<p style="text-align: center;">Bit Description</p> <ul style="list-style-type: none"> 7 Obsolete 6 Shall be set to one 5 Obsolete 4 Transport Dependent - See 6.2.11 3:0 Reserved
Command	7:0 24h

7.36.4 Normal Outputs

See table 111.

7.36.5 Error Outputs

The validity of the data transferred is indeterminate. A device may return command completion with the Error bit set to one if an Interface CRC error has occurred. See table 147.

NOTE 21 — There is no defined mechanism for a device to return an Interface CRC error status that may have occurred during the last data block of a PIO-in data transfer; there may be other mechanisms in which a host may verify that an Interface CRC error occurred in these cases.

7.37 READ STREAM DMA EXT - 2Ah, DMA

7.37.1 Feature Set

This 48-bit command is mandatory for devices that implement the Streaming feature set.

7.37.2 Description

The READ STREAM DMA EXT command provides a method for a host to read data within an allotted time. This command allows the host to specify that additional actions are to be performed by the device prior to the completion of the command.

7.37.3 Inputs

7.37.3.1 Inputs Overview

Name	Description
Feature	<p>Bit Description</p> <p>15:8 Command Completion Time Limit (CCTL) - See 7.37.3.2</p> <p>7 Obsolete</p> <p>6 Read Continuous (RC) - See 7.37.3.3</p> <p>5 Not Sequential (NS) – See 7.37.3.4</p> <p>4 Obsolete</p> <p>3 Reserved</p> <p>2:0 Stream ID – See 7.37.3.5</p>
Count	The number of logical sectors to be transferred. A value of 0000h indicates that 65,536 logical sectors are to be transferred
LBA	LBA of first logical sector to be transferred
Device	<p>Bit Description</p> <p>7 Obsolete</p> <p>6 Shall be set to one</p> <p>5 Obsolete</p> <p>4 Transport Dependent - See 6.2.11</p> <p>3:0 Reserved</p>
Command	7:0 2Ah

7.37.3.2 Command Completion Time Limit (CCTL)

CCTL specifies the time allowed for the device to process the command before reporting command completion.

If CCTL is not cleared to zero, then the device shall report command completion within (CCTL * (IDENTIFY DEVICE data words 98-99) microseconds). The device shall measure the time before reporting command completion from command acceptance.

If CCTL is cleared to zero, and Default CCTL was not cleared to zero in the most recent CONFIGURE STREAM command (see 7.9) for the Stream ID, then the device shall report command completion within the time specified by Default CCTL (see 7.9.3.4).

If CCTL is cleared to zero, and Default CCTL was cleared to zero in the most recent CONFIGURE STREAM command (see 7.9) for the Stream ID, or CCTL is cleared to zero and no previous CONFIGURE STREAM command was used to specify a Default CCTL for this Stream ID, then the result is vendor specific.

7.37.3.3 Read Continuous

If RC is set to one, then:

- a) the device shall not stop processing the command due to errors associated with reading the media;
- b) if an error occurs during data transfer or while reading data from the media before command completion or before the amount of time allowed for command completion based on the setting of CCTL (see 7.37.3.2) or Default CCTL (see 7.9.3) is reached, then the device:
 - 1) shall continue to transfer the amount of data requested;
 - 2) may continue reading data from the media;
 - 3) shall report command completion after all data for the command has been transferred; and
 - 4) shall save the error information in the Read Streaming Error log;
 or
- c) if the amount of time allowed for command completion based on the setting of CCTL (see 7.37.3.2) or Default CCTL (see 7.9.3) is reached, then the device:
 - 1) shall stop processing the command;
 - 2) shall report command completion; and
 - 3) shall set the Command Completion Time Out bit in the Read Streaming Error log to one.

If RC is cleared to zero and an error occurs, then the device:

- a) may continue transferring data; and
- b) shall report command completion after the data transfer has been completed.

7.37.3.4 Not Sequential (NS)

If NS is set to one, then the next READ STREAM command with the same Stream ID may not be sequential in the LBA space. Any read of the device media or internal device buffer management as a result of the state of the NS bit is vendor specific.

7.37.3.5 Stream ID

Stream ID specifies the stream to be read. The device shall operate according to the parameters specified by the most recent successful CONFIGURE STREAM command specifying this Stream ID.

7.37.4 Normal Outputs

See table 103 for the definition of Normal Outputs.

7.37.5 Error Outputs

If:

- a) RC was set to one in the command, and
- b) the device is able to return the amount of data requested for the command (e.g., an error occurred while reading from the media);

then the device shall set the Stream Error bit to one and clear the Error bit to zero.

If:

- a) RC was set to one in the command, and
- b) the device is not able to return the amount of data requested for the command (e.g., an Interface CRC error is reported at command completion);

then the device shall clear Stream Error bit to zero and set the Error bit to one.

If:

- a) RC was cleared to zero in the command;
- b) CCTL was not cleared to zero in the command, or CCTL was cleared to zero in the command and Default CCTL specified in the most recent CONFIGURE STREAM command for the Stream ID (see 7.9) was not cleared to zero; and

- c) the time specified for command completion by CCTL (see 7.37.3.2) or Default CCTL (see 7.9.3) has been reached;

then the device shall clear the Stream Error bit to zero, set the Error bit to one, and set the Abort bit to one.

If:

- a) RC was cleared to zero in the command;
- b) CCTL was cleared to zero in the command; and
- c) Default CCTL was cleared to zero in the most recent CONFIGURE STREAM command for the Stream ID (see 7.9);

then the device shall clear the Stream Error bit to zero, set the Error, Interface CRC, ID Not Found, and/or Abort bits to one (i.e., indicating the error type).

The validity of the data transferred is indeterminate. See table 134.

7.38 READ STREAM EXT - 2Bh, PIO Data-In

7.38.1 Feature Set

This 48-bit command is mandatory for devices that implement the Streaming feature set.

7.38.2 Description

See 7.37.2 for the description of this command.

7.38.3 Inputs

See 7.37.3 for a description of the inputs for this command.

7.38.4 Normal Outputs

See 7.37.4 for a description of the Normal Outputs.

7.38.5 Error Outputs

See 7.37.5 for the description of Error Outputs.

NOTE 22 — There is no defined mechanism for a device to return an Interface CRC error status that may have occurred during the last data block of a PIO-in data transfer; there may be other mechanisms in which a host may verify that an Interface CRC error occurred in these cases.

7.39 READ VERIFY SECTOR(S) - 40h, Non-Data

7.39.1 Feature Set

This 28-bit command is mandatory for all devices that implement the General feature set

7.39.2 Description

This command is similar to the the READ SECTOR(S) command, except that no data is transferred from the device to the host, and the device shall read the data from the non-volatile media and verify that there are no errors.

7.39.3 Inputs

Name	Description
Feature	N/A
Count	The number of logical sectors to be verified. A value of 00h indicates that 256 logical sectors are to be verified
LBA	LBA of first logical sector to be verified
Device	<p>Bit Description</p> <ul style="list-style-type: none"> 7 Obsolete 6 Shall be set to one 5 Obsolete 4 Transport Dependent - See 6.2.11 3:0 Reserved
Command	7:0 40h

7.39.4 Normal Outputs

See table 99.

7.39.5 Error Outputs

See table 133.

7.40 READ VERIFY SECTOR(S) EXT - 42h, Non-Data

7.40.1 Feature Set

This 48-bit command is mandatory for devices implementing the 48-bit Address feature set

7.40.2 Description

This command is similar to the the READ SECTOR(S) EXT command, except that no data is transferred from the device to the host, and the device shall read the data from the non-volatile media and verify that there are no errors.

7.40.3 Inputs

Name	Description
Feature	Reserved
Count	The number of logical sectors to be verified. A value of 0000h indicates that 65,536 logical sectors are to be verified
LBA	LBA of first logical sector to be verified
Device	<p style="text-align: center;">Bit Description</p> <ul style="list-style-type: none"> 7 Obsolete 6 Shall be set to one 5 Obsolete 4 Transport Dependent - See 6.2.11 3:0 Reserved
Command	7:0 42h

7.40.4 Normal Outputs

See table 111.

7.40.5 Error Outputs

See table 147.

7.41 SECURITY DISABLE PASSWORD - F6h, PIO Data-Out

7.41.1 Feature Set

This 28-bit command is mandatory for devices that implement the Security feature set.

7.41.2 Description

The SECURITY DISABLE PASSWORD command transfers 512 bytes of data from the host. Table 48 defines the content of this information.

If the password selected by word 0 matches the password previously saved by the device, the device shall disable the User password, and return the device to the SEC1 state.

This command shall not change the Master password or the Master Password Identifier.

If security is disabled, then:

- a) if the Identifier bit is set to User, then the device shall return command aborted; or
- b) if the Identifier bit is set to Master, then the device may compare the password supplied with the stored Master password.

When security is enabled, and the Master Password Capability is High, then:

- a) if the Identifier bit is set to Master, then the password supplied shall be compared with the stored Master password; or
- b) if the Identifier bit is set to User, then the password supplied shall be compared with the stored User password.

When security is enabled, and the Master Password Capability is Maximum, then:

- a) if the Identifier bit is set to Master, then the device shall return command aborted, even if the supplied Master password is valid; or
- b) if the Identifier bit is set to User, then the password supplied shall be compared with the stored User password.

Upon successful completion of this command, these fields of the IDENTIFY DEVICE data or the IDENTIFY PACKET DEVICE data shall be updated as follows:

- a) word 85, bit 1 shall be cleared to zero (i.e., there is no active User password);
- b) word 128, bit 1 shall be equal to word 85, bit 1; and
- c) word 128, bit 8 shall be cleared to zero (i.e., the Master Password Capability is not Maximum).

7.41.3 Inputs

Name	Description
Feature	N/A
Count	N/A
LBA	N/A
Device	<p>Bit Description</p> <p>7 Obsolete</p> <p>6 N/A</p> <p>5 Obsolete</p> <p>4 Transport Dependent - See 6.2.11</p> <p>3:0 Reserved</p>
Command	7:0 F6h

7.41.4 Normal Outputs

See table 99.

7.41.5 Error Outputs

The device shall return command aborted if:

- a) the Security feature set is not supported;
- b) security is Locked (i.e., the device is in SEC4);
- c) security is Frozen (i.e., the device is in states SEC2 or SEC6); or
- d) the password received in the data for the command does not match the password previously saved by the device.

A device may return command completion with the Error bit set to one if an Interface CRC error has occurred. See table 123.

7.41.6 Output From the Host to the Device Data Structure

Table 48 — SECURITY DISABLE PASSWORD data content

Word	Content									
0	Control word <table border="1" style="margin-left: 20px;"> <thead> <tr> <th>Bit</th> <th>Field Name</th> <th>Description</th> </tr> </thead> <tbody> <tr> <td>15:1</td> <td>Reserved</td> <td></td> </tr> <tr> <td>0</td> <td>Identifier</td> <td>0=compare User password 1=compare Master password</td> </tr> </tbody> </table>	Bit	Field Name	Description	15:1	Reserved		0	Identifier	0=compare User password 1=compare Master password
Bit	Field Name	Description								
15:1	Reserved									
0	Identifier	0=compare User password 1=compare Master password								
1-16	Password (32 bytes)									
17-255	Reserved									

7.42 SECURITY ERASE PREPARE - F3h, Non-Data

7.42.1 Feature Set

This 28-bit command is mandatory for devices that implement the Security feature set.

7.42.2 Description

The SECURITY ERASE PREPARE command shall be issued immediately before the SECURITY ERASE UNIT command.

7.42.3 Inputs

Name	Description
Feature	N/A
Count	N/A
LBA	N/A
Device	<p style="text-align: center;">Bit Description</p> <p style="text-align: center;">7 Obsolete</p> <p style="text-align: center;">6 N/A</p> <p style="text-align: center;">5 Obsolete</p> <p style="text-align: center;">4 Transport Dependent - See 6.2.11</p> <p style="text-align: center;">3:0 Reserved</p>
Command	7:0 F3h

7.42.4 Normal Outputs

See table 99.

7.42.5 Error Outputs

The Abort bit shall be set to one if the device is in Frozen mode. See table 122.

7.43 SECURITY ERASE UNIT - F4h, PIO Data-Out

7.43.1 Feature Set

This 28-bit command is mandatory for devices that implement the Security feature set.

7.43.2 Description

This command transfers 512-bytes of data from the host. Table 49 defines the content of this information.

The SECURITY ERASE PREPARE command shall be completed immediately prior to the SECURITY ERASE UNIT command. If the device receives a SECURITY ERASE UNIT command and the previous command was not a successful SECURITY ERASE PREPARE command, the device shall return command aborted for the SECURITY ERASE UNIT command.

When security is disabled and the Identifier bit is set to User, then the device shall return command aborted.

When Security is Enabled:

- a) If the Identifier bit is set to Master, then the password supplied shall be compared with the stored Master password; or
- b) If the Identifier bit is set to User, then the password supplied shall be compared with the stored User password.

When Normal Erase mode is specified, the SECURITY ERASE UNIT command shall replace the contents of LBA 0 to the LBA reported by the larger of READ NATIVE MAX or READ NATIVE MAX EXT with all binary zeroes or all binary ones. If the device replaces the contents of native max address + 1 to the Maximum LBA reported in DEVICE CONFIGURATION IDENTIFY data words 3-6 it shall use the same data pattern found in LBA 0. IDENTIFY DEVICE or IDENTIFY PACKET DEVICE word 89 gives an estimate of the time required to complete the erasure.

The Enhanced Erase mode is optional. IDENTIFY DEVICE or IDENTIFY PACKET DEVICE word 128, bit 5 indicates whether the mode is supported. When Enhanced Erase mode is specified, the device shall write vendor specific data patterns from LBA 0 to the Maximum LBA reported in DEVICE CONFIGURATION IDENTIFY data words 3-6. In Enhanced Erase mode, all previously written user data shall be overwritten, including sectors that are no longer in use due to reallocation. IDENTIFY DEVICE or IDENTIFY PACKET DEVICE word 90 gives an estimate of the time required to complete the erasure.

On successful completion, this command shall disable Security (e.g., returns the device to Security state SEC1), and invalidate any existing User password. Any previously valid Master password and Master Password Identifier remains valid.

Upon successful completion, these fields in the IDENTIFY DEVICE information or the IDENTIFY PACKET DEVICE information shall be updated as follows:

- a) word 85, bit 1 shall be cleared to zero (i.e., there is no active User password);
- b) word 128, bit 1 shall be cleared to zero (i.e., there is no active User password); and
- c) word 128, bit 8 shall be cleared to zero (i.e., the Master Password Capability is set to High).

7.43.3 Inputs

Name	Description
Feature	N/A
Count	N/A
LBA	N/A
Device	<p>Bit Description</p> <p>7 Obsolete</p> <p>6 N/A</p> <p>5 Obsolete</p> <p>4 Transport Dependent - See 6.2.11</p> <p>3:0 Reserved</p>
Command	7:0 F4h

7.43.4 Normal Outputs

See table 99.

7.43.5 Error Outputs

The device shall return command aborted if:

- a) this command was not immediately preceded by a SECURITY ERASE PREPARE command;
- b) Enhanced mode was requested but the device does not support that mode;
- c) the password received in the data for the command does not match the password previously saved by the device;
- d) an invalid password was specified; or
- e) if the data area is not successfully overwritten.

A device may return command completion with the Error bit set to one if an Interface CRC error has occurred. See table 123.

7.43.6 Output From the Host to the Device Data Structure

Table 49 — SECURITY ERASE UNIT data content

Word	Content												
0	<p>Control word</p> <table border="1"> <thead> <tr> <th>Bit</th> <th>Field Name</th> <th>Description</th> </tr> </thead> <tbody> <tr> <td>15:2</td> <td>Reserved</td> <td></td> </tr> <tr> <td>1</td> <td>Erase mode</td> <td>0=Normal Erase 1=Enhanced Erase</td> </tr> <tr> <td>0</td> <td>Identifier</td> <td>0=Compare User password 1=Compare Master password</td> </tr> </tbody> </table>	Bit	Field Name	Description	15:2	Reserved		1	Erase mode	0=Normal Erase 1=Enhanced Erase	0	Identifier	0=Compare User password 1=Compare Master password
Bit	Field Name	Description											
15:2	Reserved												
1	Erase mode	0=Normal Erase 1=Enhanced Erase											
0	Identifier	0=Compare User password 1=Compare Master password											
1-16	Password (32 bytes)												
17-255	Reserved												

7.44 SECURITY FREEZE LOCK - F5h, Non-Data

7.44.1 Feature Set

This 28-bit command is mandatory for devices that implement the Security feature set.

7.44.2 Description

The SECURITY FREEZE LOCK command shall set the device to Frozen mode. After command completion any other commands that update the device Lock mode shall be command aborted. Frozen mode shall be disabled by power-off or hardware reset. If SECURITY FREEZE LOCK is issued when the device is in Frozen mode, the command executes and the device shall remain in Frozen mode.

See table 9 for a list of commands disabled by SECURITY FREEZE LOCK.

Upon successful completion, IDENTIFY DEVICE data or IDENTIFY PACKET DEVICE data word 128, bit 3 shall be set to one.

7.44.3 Inputs

Name	Description
Feature	N/A
Count	N/A
LBA	N/A
Device	<p>Bit Description</p> <p>7 Obsolete</p> <p>6 N/A</p> <p>5 Obsolete</p> <p>4 Transport Dependent - See 6.2.11</p> <p>3:0 Reserved</p>
Command	7:0 F5h

7.44.4 Normal Outputs

See table 99.

7.44.5 Error Outputs

The Abort bit shall be set to one if the device is in locked mode. See table 122.

7.45 SECURITY SET PASSWORD - F1h, PIO Data-Out

7.45.1 Feature Set

This 28-bit command is mandatory for devices that implement the Security feature set.

7.45.2 Description

7.45.2.1 Overview

This command transfers 512 bytes of data from the host. Table 50 defines the content of this information. The command sets only one password at a time.

7.45.2.2 Setting the Master Password

If a Master password is specified, the device shall save the supplied Master password in a non-volatile location. The Master Password Capability shall remain unchanged. This does not cause any changes to IDENTIFY DEVICE or IDENTIFY PACKET DEVICE words 85 or 128.

If the device supports the Master Password Identifier feature and a valid identifier is supplied (see 4.20.11), the device shall save the identifier in a non-volatile location. This new value shall be returned in word 92 of IDENTIFY DEVICE or IDENTIFY PACKET DEVICE data. If the host attempts to set the Master Password Identifier to 0000h or FFFFh, the device shall preserve the existing Master Password Identifier and return successful command completion.

If the device does not support the Master Password Identifier feature, the device shall not validate the identifier field, and shall not change word 92 of IDENTIFY DEVICE or IDENTIFY PACKET DEVICE and shall not return command aborted.

7.45.2.3 Setting the User Password

If a User password is specified, the device shall save the User password in a non-volatile location and update the Master Password Capability. The Master Password Identifier shall not be changed. These fields in the IDENTIFY DEVICE data or the IDENTIFY PACKET DEVICE data shall be updated as follows:

- a) word 85, bit 1 shall be set to one (i.e., Security is enabled);
- b) word 128, bit 1 shall be set to one (i.e., Security is enabled); and
- c) word 128, bit 8 shall indicate the Master Password Capability.

7.45.3 Inputs

Name	Description
Feature	N/A
Count	N/A
LBA	N/A
Device	<p>Bit Description</p> <p>7 Obsolete</p> <p>6 N/A</p> <p>5 Obsolete</p> <p>4 Transport Dependent - See 6.2.11</p> <p>3:0 Reserved</p>
Command	7:0 F1h

7.45.4 Normal Outputs

See table 99.

7.45.5 Error Outputs

If the device is in the Locked or Frozen modes, then the device shall return command aborted. A device may return command completion with the Error bit set to one if an Interface CRC error has occurred. See table 123.

7.45.6 Output From the Host to the Device Data Structure

Table 50 — SECURITY SET PASSWORD data content

Word	Content															
0	Control word <table border="1" data-bbox="423 457 1279 751"> <thead> <tr> <th data-bbox="423 457 488 499">Bit</th> <th data-bbox="488 457 938 499">Field Name</th> <th data-bbox="938 457 1279 499">Description</th> </tr> </thead> <tbody> <tr> <td data-bbox="423 499 488 541">15:9</td> <td data-bbox="488 499 938 541">Reserved</td> <td data-bbox="938 499 1279 541"></td> </tr> <tr> <td data-bbox="423 541 488 625">8</td> <td data-bbox="488 541 938 625">Master Password Capability</td> <td data-bbox="938 541 1279 625">0=High 1=Maximum</td> </tr> <tr> <td data-bbox="423 625 488 667">7:1</td> <td data-bbox="488 625 938 667">Reserved</td> <td data-bbox="938 625 1279 667"></td> </tr> <tr> <td data-bbox="423 667 488 751">0</td> <td data-bbox="488 667 938 751">Identifier</td> <td data-bbox="938 667 1279 751">0=set User password 1=set Master password</td> </tr> </tbody> </table>	Bit	Field Name	Description	15:9	Reserved		8	Master Password Capability	0=High 1=Maximum	7:1	Reserved		0	Identifier	0=set User password 1=set Master password
Bit	Field Name	Description														
15:9	Reserved															
8	Master Password Capability	0=High 1=Maximum														
7:1	Reserved															
0	Identifier	0=set User password 1=set Master password														
1-16	Password (32 bytes)															
17	Master Password Identifier. This word is valid if word 0 bit 0 is set to one.															
18-255	Reserved															

7.46 SECURITY UNLOCK - F2h, PIO Data-Out

7.46.1 Feature Set

This 28-bit command is mandatory for devices that implement the Security feature set.

7.46.2 Description

This command transfers 512 bytes of data from the host. Table 51 defines the content of this information.

When security is disabled and the Identifier bit is set to User, then the device shall return command aborted.

When Security is Enabled, and the Master Password Capability is set to High, then:

- a) if the Identifier bit is set to Master, then the password supplied shall be compared with the stored Master password; or
- b) if the Identifier bit is set to User, then the password supplied shall be compared with the stored User password.

When Security is Enabled and the Master Password Capability is set to Maximum, then:

- a) if the Identifier bit is set to Master, then the device shall return command aborted; or
- b) if the Identifier bit is set to User, then the password supplied shall be compared with the stored User password.

If the password received in the data for the command does not match the password previously saved by the device, then the device shall return command aborted and decrement the password attempt counter. When this counter reaches zero, IDENTIFY DEVICE or IDENTIFY PACKET DEVICE word 128 bit 4 shall be set to one, and SECURITY UNLOCK and SECURITY ERASE UNIT commands shall return command aborted until a power-on reset or a hardware reset. SECURITY UNLOCK commands issued when the device is unlocked have no effect on the unlock counter.

Upon successful completion of this command, IDENTIFY DEVICE data or IDENTIFY PACKET DEVICE data word 128, bit 2 shall be cleared to zero (i.e., the device is not in a Locked state).

7.46.3 Inputs

Name	Description
Feature	N/A
Count	N/A
LBA	N/A
Device	<p>Bit Description</p> <p>7 Obsolete</p> <p>6 N/A</p> <p>5 Obsolete</p> <p>4 Transport Dependent - See 6.2.11</p> <p>3:0 Reserved</p>
Command	7:0 F2h

7.46.4 Normal Outputs

See table 99.

7.46.5 Error Outputs

If the device is in Frozen mode or an invalid password is supplied or the password attempt counter has decremented to zero, the device shall return command aborted.

A device may return command completion with the Error bit set to one if an Interface CRC error has occurred. See table 123.

7.46.6 Output From the Host to the Device Data Structure

Table 51 — SECURITY UNLOCK data content

Word	Content									
0	Control word <table border="1"> <thead> <tr> <th>Bit</th> <th>Field Name</th> <th>Description</th> </tr> </thead> <tbody> <tr> <td>15:1</td> <td>Reserved</td> <td></td> </tr> <tr> <td>0</td> <td>Identifier</td> <td>0=compare User password 1=compare Master password</td> </tr> </tbody> </table>	Bit	Field Name	Description	15:1	Reserved		0	Identifier	0=compare User password 1=compare Master password
Bit	Field Name	Description								
15:1	Reserved									
0	Identifier	0=compare User password 1=compare Master password								
1-16	Password (32 bytes)									
17-255	Reserved									

7.47 SERVICE - A2h, DMA Queued

7.47.1 Feature Set

This 28-bit command is mandatory for devices that implement the TCQ feature set.

7.47.2 Description

The SERVICE command provides data transfer and/or status of a command that was previously released.

The device shall have performed a release for a previous READ DMA QUEUED, READ DMA QUEUED EXT, WRITE DMA QUEUED, WRITE DMA QUEUED EXT or WRITE DMA QUEUED FUA EXT command and shall have set the Service bit (see 6.2.9) to one to request the SERVICE command be issued to continue data transfer and/or provide command status (see 7.48.15).

7.47.3 Inputs

Name	Description
Feature	N/A
Count	N/A
LBA	N/A
Device	<p>Bit Description</p> <ul style="list-style-type: none"> 7 Obsolete 6 N/A 5 Obsolete 4 Transport Dependent - See 6.2.11 3:0 Reserved
Command	7:0 A2h

7.47.4 Outputs

Outputs as a result of a SERVICE command are described in the command description for the command for which SERVICE is being requested.

7.48 SET FEATURES - EFh, Non-Data

7.48.1 Feature Set

This 28-bit command is mandatory for all devices.

7.48.2 Description

This command is used by the host to establish parameters that affect the execution of certain device features. Table 52 defines these features.

After a power-on reset or a hardware reset, the settings of the functions specified by the subcommands are vendor specific unless otherwise specified in this standard. Software Reset is described in the individual subcommands as needed.

Table 52 — SET FEATURES Feature field definitions (part 1 of 3)

Value	Description
00h	Reserved
01h	If the device implements the CFA feature set, then enable 8-bit PIO transfer mode (see 7.48.3); otherwise this value is reserved.
02h	Enable volatile write cache (see 7.48.4)
03h	Set transfer mode (see 7.48.5)
04h	Obsolete
05h	Enable the APM feature set (see 7.48.6)
06h	Enable the PUIS feature set (see 7.48.7)
07h	PUIS feature set device spin-up (see 7.48.8)
08h	Reserved
09h	If the device implements the CFA feature set, then this subcommand is reserved for CFA. Otherwise, this subcommand is reserved for Address Offset Reserved Area Boot Method.
0Ah	Enable CFA power mode 1 (see 7.48.9)
0Bh	Enable Write-Read-Verify feature set (see 7.48.10)
0Ch-0Fh	Reserved
10h	Enable use of SATA feature (see 7.48.18)
11h-1Fh	Reserved
20h	Reserved for TLC
21h	Reserved for TLC
22h-30h	Reserved
31h	Obsolete
32h	Reserved
33h	Obsolete
34h-40h	Reserved
41h	Enable the Free-fall Control feature set (see 7.48.17)
42h	Enable the AAM feature set (see 7.48.11)
43h	Set Maximum Host Interface Sector Times (see 7.48.12)
44h	Obsolete
45h-53h	Reserved
54h	Obsolete
55h	Disable read look-ahead feature (see 7.48.13)

Table 52 — SET FEATURES Feature field definitions (part 2 of 3)

Value	Description
56h-5Ch	Vendor Specific
5Dh	Enable release interrupt (see 7.48.14)
5Eh	Enable service interrupt (see 7.48.15)
5Fh	Reserved for DDT
60h-65h	Reserved
66h	Disable reverting to power-on defaults (see 7.48.16)
67h-68h	Reserved
69h	If the device implements the CFA feature set, then this subcommand is reserved for CFA; otherwise this value is reserved.
6Ah-76h	Reserved
77h	Obsolete
78h-80h	Reserved
81h	If the device implements the CFA feature set, then disable 8-bit PIO transfer mode (see 7.48.3); otherwise this value is reserved.
82h	Disable volatile write cache (see 7.48.4)
83h	Reserved
84h	Obsolete
85h	Disable the APM feature set (see 7.48.6)
86h	Disable the PUIS feature set (see 7.48.7)
87h	Reserved
88h	Obsolete
89h	If the device implements the CFA feature set, then this subcommand is reserved for CFA; otherwise this subcommand is reserved for Address Offset Reserved Area Boot Method.
8Ah	Disable CFA power mode 1 (see 7.48.9)
8Bh	Disable Write-Read-Verify feature set (see 7.48.10)
8Ch-8Fh	Reserved
90h	Disable use of SATA feature (see 7.48.18)
91h-94h	Reserved
95h	Obsolete
96h-99h	Reserved
99h	Obsolete

Table 52 — SET FEATURES Feature field definitions (part 3 of 3)

Value	Description
9Ah	Obsolete
9Bh-A9h	Reserved
AAh	Enable read look-ahead feature (see 7.48.13)
ABh	Obsolete
ACh-BAh	Reserved
BBh	Obsolete
BCh-C0h	Reserved
C1h	Disable the Free-fall Control feature set (see 7.48.17)
C2h	Disable the AAM feature set (see 7.48.11)
C3h-CBh	Reserved
CCh	Enable reverting to power-on defaults
CDh-D5h	Reserved
D6h-DCh	Vendor Specific
DDh	Disable release interrupt (see 7.48.14)
DEh	Disable SERVICE interrupt (see 7.48.15)
DFh	Reserved for DDT
E0h	Vendor Specific
E1h-EFh	Reserved
F0h-F3h	Reserved for assignment by the CompactFlash Association
F4h-FFh	Reserved

7.48.3 Enable/disable 8-bit PIO data transfer

Subcommand codes 01h and 81h allow the host to enable or disable 8-bit PIO data transfers. Devices implementing the CFA feature set shall support 8-bit PIO data transfers. Devices not implementing the CFA feature set shall not support 8-bit PIO data transfers. See the CFA specification for more information.

7.48.4 Enable/disable volatile write cache

Subcommand codes 02h and 82h allow the host to enable or disable volatile write cache in devices that implement volatile write cache. When the disable volatile write cache subcommand is issued, the device shall initiate the sequence to flush volatile cache to non-volatile media before command completion (see 7.14). These subcommands may affect caching for commands in the Streaming feature set. Enable/disable write cache subcommands are mandatory when a write cache is implemented.

7.48.5 Set transfer mode

The set transfer mode subcommand is mandatory. A host selects the transfer mechanism by Set Transfer Mode, subcommand code 03h, and specifying a value in the Count field. The upper 5 bits define the type of transfer

and the low order 3 bits encode the mode value. The host may change the selected modes by the SET FEATURES command. Table 53 shows the available transfer modes.

Table 53 — Transfer modes

Mode	Bits (7:3)	Bits (2:0)
PIO default mode	00000b	000b
PIO default mode, disable IORDY	00000b	001b
PIO flow control transfer mode	00001b	Mode
Retired	00010b	N/A
Multiword DMA mode	00100b	Mode
Ultra DMA mode	01000b	Mode
Reserved	10000b	N/A
Mode = transfer mode number (See 7.16.7.24, 7.16.7.25, 7.16.7.40)		

If a device receives a SET FEATURES command with a Set Transfer Mode subcommand and the Count field value set to 0000_0000b, then the device shall set the default PIO mode. If the Count field is set to 0000_0001b, and the device supports disabling of IORDY, then the device shall set the default PIO mode and disable IORDY. A device shall support all PIO modes below the highest mode supported (e.g., if PIO mode 1 is supported PIO mode 0 shall be supported).

Support of IORDY is mandatory when PIO mode 3 or above is the current mode of operation.

A device shall support all Multiword DMA modes below the highest mode supported, e.g., if Multiword DMA mode 1 is supported Multiword DMA mode 0 shall be supported.

A device shall support all Ultra DMA modes below the highest mode supported, e.g., if Ultra DMA mode 1 is supported Ultra DMA mode 0 shall be supported.

If an Ultra DMA mode is enabled any previously enabled Multiword DMA mode shall be disabled by the device. If a Multiword DMA mode is enabled any previously enabled Ultra DMA mode shall be disabled by the device.

For PATA systems using a cable assembly, the host should determine that an 80-conductor cable assembly is connecting the host with the device(s) before enabling any Ultra DMA mode greater than 2 in the device(s).

7.48.6 Enable/disable the APM feature set

Subcommand code 05h allows the host to enable APM. To enable APM, the host writes the Count field with the desired APM level and then executes a SET FEATURES command with subcommand code 05h. The APM level is a scale from the lowest power consumption setting of 01h to the maximum performance level of FEh. Table 54 shows these values.

Table 54 — APM levels

Count	Level
00h	Reserved
01h	Minimum power consumption with Standby
02h-7Fh	Intermediate power management levels with Standby
80h	Minimum power consumption without Standby
81h-FDh	Intermediate power management levels without Standby
FEh	Maximum performance
FFh	Reserved

Device performance may increase with increasing APM levels. Device power consumption may increase with increasing power management levels. The APM levels may contain discrete bands (e.g., a device may

implement one APM method from 80h to A0h and a higher performance, higher power consumption method from level A1h to FEh). APM levels 80h and higher do not permit the device to spin down to save power.

Subcommand code 85h disables APM. Subcommand 85h may not be implemented on all devices that implement SET FEATURES subcommand 05h.

7.48.7 Enable/disable the PUIS feature set

Subcommand code 06h enables the PUIS feature set. When this feature set is enabled, the device shall power-up into Standby mode (i.e., the device shall be ready to receive commands but shall not spin-up) (see 4.19). Once this feature set is enabled, it shall only be disabled by a subsequent SET FEATURES command disabling this feature set. This feature set shall not be disabled after a power-on reset, a hardware reset, or a software reset.

Subcommand code 86h disables the PUIS feature set. When this feature set is disabled, the device shall power-up into Active mode. The factory default for this feature set shall be disabled.

7.48.8 PUIS feature set device spin-up

Subcommand code 07h shall cause a device that has powered-up into Standby to go to the Active state (see 4.19 and figure 14).

7.48.9 Enable/disable CFA power mode 1

Subcommand code 0Ah causes a CFA device to transition to CFA Power Mode 1. CFA devices may consume up to 500 mA maximum average RMS current for either 3.3 V or 5 V operation in Power Mode 1.

Subcommand 8Ah causes a CFA device to transition to CFA Power Mode 0. CFA devices may consume up to 75 mA maximum average RMS current for 3.3 V or 100 mA maximum average RMS current for 5 V operation in Power Mode 0.

If a CFA device is in CFA Power Mode 0, then the device shall transition to CFA Power Mode 1 after processing of a power-on reset or a hardware reset.

If a CFA device is in CFA Power Mode 0 and in the Reverting to defaults enabled mode (see 7.48.16), then the device shall transition to CFA Power Mode 1 after processing of a software reset.

If a CFA device is in CFA Power Mode 0 and in the Reverting to defaults disabled mode (see 7.48.16), then the device shall not transition to CFA Power Mode 1 after processing of a software reset.

Enabling CFA Power Mode 1 does not cause a spin-up.

A device in Power Mode 0 shall accept the following commands:

- a) IDENTIFY DEVICE
- b) SET FEATURES (function codes 0Ah and 8Ah)
- c) STANDBY
- d) STANDBY IMMEDIATE
- e) SLEEP
- f) CHECK POWER MODE
- g) EXECUTE DEVICE DIAGNOSTICS
- h) CFA REQUEST EXTENDED ERROR

A device in Power Mode 0 may accept any command that the device is capable of executing within the Power Mode 0 current restrictions. Commands that require more current than specified for Power Mode 0 shall be rejected with an abort error.

7.48.10 Enable/Disable Write-Read-Verify feature set

Subcommand code 0Bh enables the Write-Read-Verify feature set.

Bits (7:0) of the LBA field in the SET FEATURES command specify the Write-Read-Verify mode. Table 55 defines the Write-Read-Verify modes.

Table 55 — Write-Read-Verify Modes

Mode	Description
00h ^a	Always enabled (i.e., the device shall perform a Write-Read-Verify for all logical sectors for all write commands).
01h ^a	The device shall perform a Write-Read-Verify on the first 65,536 logical sectors written by the host after: <ul style="list-style-type: none"> a) spin-up; or b) the device completes a SET FEATURES command setting the Write-Read-Verify mode without error.
02h ^a	The number of logical sectors on which a device performs a Write-Read-Verify is vendor specific.
03h	The device shall perform a Write-Read-Verify on the first (number specified by the Count field in the SET FEATURES command x 1,024) logical sectors written by the host after: <ul style="list-style-type: none"> a) spin-up; or b) the device completes a SET FEATURES command setting the Write-Read-Verify mode without error.
04h-FFh	Reserved
^a the Count field shall be ignored.	

Subcommand code 8Bh disables the Write-Read-Verify feature set.

A device shall set the Write-Read-Verify feature set to its factory default setting after processing of a power-on reset or a hardware reset.

If a device is in the reverting to defaults enabled mode (see 7.48.16), then the device shall set the Write-Read-Verify feature set to its factory default setting after processing of a software reset.

If a device is in the reverting to defaults disabled mode (see 7.48.16), then the device shall not change the settings of the Write-Read-Verify feature set after processing of a software reset.

7.48.11 Enable/disable the AAM feature set

Subcommand code 42h allows the host to enable the AAM feature set. To enable the AAM feature set, the host writes the Count field with the requested automatic acoustic management level and executes a SET FEATURES command with subcommand code 42h. The AAM level is selected on a scale from 01h to FEh. Table 56 shows the AAM level values.

Enabling or disabling of the AAM feature set, and the current AAM level setting shall be preserved by the device across all forms of reset (i.e., power-on, hardware, and software resets).

Table 56 — AAM levels

Count	Level
00h	Vendor Specific
01h-7Fh	Retired
80h	Minimum acoustic emanation level
81h-FDh	Intermediate acoustic management levels
FEh	Maximum performance
FFh	Reserved

Device performance may increase with increasing AAM levels. Device power consumption may decrease with decreasing AAM levels. The AAM levels may contain discrete bands (e.g., a device may implement one acoustic management method from 80h to BFh and a higher performance, higher acoustic management method from level C0h to FEh).

Upon successful completion of this SET FEATURES subcommand, IDENTIFY DEVICE or IDENTIFY PACKET DEVICE data word 94, bits (7:0) shall be updated by the device. If the command is aborted by the device, the previous AAM state shall be retained.

Subcommand code C2h disables the AAM feature set. Devices that implement SET FEATURES subcommand 42h are not required to implement subcommand C2h. If the device completes processing of this subcommand without error, then the acoustic behavior of the device shall be vendor-specific, and the device shall return zeros in bits (7:0) of word 94 and bit 9 of word 86 of the IDENTIFY DEVICE or IDENTIFY PACKET DEVICE data.

Upon completion of SET FEATURES subcommands 42h and C2h, the device may update words 96-97 and word 104 in IDENTIFY DEVICE or IDENTIFY PACKET DEVICE data.

7.48.12 Set Maximum Host Interface Sector Times

Subcommand code 43h allows the host to inform the device of a host interface rate limitation. This information shall be used by the device to meet the Command Completion Time Limits of the commands of the Streaming feature set. To inform the device of a host interface rate limitation, the host writes the value of its Typical PIO Host Interface Sector Time to the Count field (7:0) and LBA (7:0) field and writes the value of its Typical DMA Host Interface Sector Time to the LBA (23:8) field. The Typical Host Interface Sector Times have the same units as IDENTIFY DEVICE data word 96 for DMA and word 104 for PIO. A value of zero indicates that the host interface shall be capable of transferring data at the maximum rate allowed by the selected transfer mode. The Typical PIO Mode Host Interface Sector Time includes the host's interrupt service time.

Upon completion of SET FEATURES subcommand 43h, the device may adjust IDENTIFY DEVICE data words 96-97 to allow for the specified host interface sector time.

Field	Bits	Description
Count	15:8	Reserved
	7:0	Typical PIO Mode Host Interface Sector Time (7:0)
LBA	47:24	Reserved
	23:8	Typical DMA Mode Host Interface Sector Time
	7:0	Typical PIO Mode Host Interface Sector Time (15:8)

7.48.13 Enable/disable read look-ahead

Subcommand codes AAh and 55h allow the host to request the device to enable or disable read look-ahead. Error recovery performed by the device is vendor specific.

7.48.14 Enable/disable release interrupt

Subcommand codes 5Dh and DDh allow a host to enable or disable the asserting of Interrupt Pending when a device releases the bus for a TCQ command.

7.48.15 Enable/disable SERVICE interrupt

Subcommand codes 5Eh and DEh allow a host to enable or disable the asserting of an Interrupt Pending when DRQ is set to one in response to a SERVICE command.

7.48.16 Enable/disable reverting to defaults

Subcommand codes CCh and 66h allow the host to enable or disable the reverting to defaults mode.

A device is in the reverting to defaults disabled mode after completing a SET FEATURES command with subcommand code 66h without error. In this mode a device shall not reset parameters to their default power-on values during the processing of a software reset.

A device is in the Reverting to defaults enabled mode after the device:

- a) processes a power-on reset or hardware reset; or
- b) completes a SET FEATURES command with subcommand CCh without error.

A device in the reverting to defaults enabled mode may reset parameters to their default power-on values during the processing of a software reset

7.48.17 Enable/Disable the Free-fall Control feature set

Subcommand codes 41h and C1h allow the host to enable or disable the Free-fall Control feature set. To enable the Free-fall Control feature set, the host writes the Count field with the requested free-fall control sensitivity setting and executes a SET FEATURES command with subcommand code 41h.

The sensitivity is selected on a scale from 00h to FFh. A value of zero selects the device vendor's recommended setting. Other values are vendor specific. The higher the sensitivity value, the more sensitive the device is to changes in acceleration.

Enabling or disabling of the Free-fall Control feature set, and the current free-fall sensitivity setting shall be preserved by the device across all forms of reset (i.e., power-on, hardware, and software resets).

7.48.18 Enable/Disable SATA feature

7.48.18.1 Overview

Subcommand codes 10h and 90h allow the host to enable or disable Serial ATA features. The Count field contains the specific Serial ATA feature to enable or disable. The specific Serial ATA features are defined as defined in table 57.

Table 57 — SATA Features

Count	Description
00h	Reserved for Serial ATA
01h	Non-zero Buffer Offsets
02h	DMA Setup FIS Auto-Activate optimization
03h	Device-initiated interface power state transitions
04h	Guaranteed In-Order Data Delivery
05h	Asynchronous Notification
06h	Software Settings Preservation
07h-FFh	Reserved Serial ATA

7.48.18.2 Enable/Disable Non-Zero Buffer Offsets

A Count field value of 01h is used to enable or disable non-zero buffer offsets for commands in the NCQ feature set. By default, non-zero buffer offsets are disabled. The enable/disable state for non-zero offsets shall be preserved across software reset. The enable/disable state for non-zero offsets shall be reset to its default state upon COMRESET. See SATA 2.6 for more information.

7.48.18.3 Enable/Disable DMA Setup FIS Auto-Activate Optimization

A Count field value of 02h is used to enable or disable DMA Setup FIS Auto-Activate optimization. See SATA 2.6 for more information. The enable/disable state for the auto-activate optimization shall be preserved across software reset. The enable/disable state for the auto-activate optimization shall be reset to its default state upon COMRESET.

7.48.18.4 Enable/Disable Device-Initiated Interface Power State Transitions

A Count field value of 03h is used to enable or disable device initiation of interface power state transitions. By default, the device is not permitted to initiate interface power state transitions. See SATA 2.6 for more information. The enable/disable state for device initiated power management shall persist across software reset. The enable/disable state shall be reset to its default disabled state upon COMRESET.

If device initiated interface power management is enabled, the device shall not attempt to initiate an interface power state transition between reset and the delivery of the device reset signature (see table 104).

7.48.18.5 Enable/Disable Guaranteed in-Order Data Delivery

A Count field value of 04h is used to enable or disable guaranteed in-order data delivery for commands in the NCQ feature set. This setting is only valid when non-zero buffer offsets are enabled. By default, guaranteed in-order data delivery is disabled. See SATA 2.6 for more information. The enable/disable state for guaranteed in-order data delivery shall be preserved across software reset. The enable/disable state for guaranteed in-order data delivery shall be reset to its default state upon COMRESET.

7.48.18.6 Enable/Disable Asynchronous Notification

For ATAPI devices, a Count field value of 05h is used to enable or disable asynchronous notification. By default, asynchronous notification is disabled. See SATA 2.6 for more information. The enable/disable state for asynchronous notification shall be preserved across software reset. The enable/disable state for asynchronous notification shall be reset to its default state upon COMRESET.

7.48.18.7 Enable/Disable Software Settings Preservation

See table 15 for a list of the preserved feature sets and settings. A Count field value of 06h is used to enable or disable software settings preservation. By default, if the device supports software settings preservation the feature is enabled when it processes a power-on reset. The enable/disable state for software settings preservation shall persist across software reset. The enable/disable state for software settings preservation shall be reset to its default state upon COMRESET. The host may disable software settings preservation in order to cause software settings to revert to their power-on default state when the device receives a COMRESET.

7.48.19 Inputs

Name	Description
Feature	Subcommand Code - See table 52
Count	Subcommand specific
LBA	Subcommand specific
Device	<p>Bit Description</p> <p>7 Obsolete</p> <p>6 N/A</p> <p>5 Obsolete</p> <p>4 Transport Dependent - See 6.2.11</p> <p>3:0 Reserved</p>
Command	7:0 EFh

7.48.20 Normal Outputs

See table 99.

7.48.21 Error Outputs

The Abort bit shall be set to one if any subcommand input value is not supported or is invalid. See table 122.

7.49 SET MAX

7.49.1 SET MAX Overview

Individual SET MAX commands are identified by the value placed in the Feature field. Table 58 shows these Feature field values.

Table 58 — SET MAX Feature field values

Value	Command
00h	Obsolete
01h	SET MAX SET PASSWORD
02h	SET MAX LOCK
03h	SET MAX UNLOCK
04h	SET MAX FREEZE LOCK
05h-FFh	Reserved

7.49.2 SET MAX ADDRESS - F9h, Non-Data

7.49.2.1 Feature Set

This 28-bit command is mandatory for devices that implement the HPA feature set.

7.49.2.2 Description

After successful command completion, all read and write access attempts to an LBA greater than the LBA specified by the successful SET MAX ADDRESS command shall be rejected with the ID Not Found bit (see 6.3.6) set to one. IDENTIFY DEVICE data words 60-61 shall reflect the maximum LBA set with this command.

If the device successfully processes a SET MAX ADDRESS command with an LBA less than the native max without error, and the 48-bit Address feature set is supported, then the value placed in IDENTIFY DEVICE data words 100-103 shall be the same as the value placed in IDENTIFY DEVICE data words 60-61.

A host should not issue more than one non-volatile SET MAX ADDRESS or SET MAX ADDRESS EXT command after a power-on or hardware reset.

A device shall not change the content in words 60-61 or 100-103 in IDENTIFY DEVICE data during processing of a software reset.

The contents of IDENTIFY DEVICE data and the maximum LBA shall not be changed if a SET MAX ADDRESS command fails.

After a successful SET MAX ADDRESS command using a new maximum LBA the content of all IDENTIFY DEVICE data words shall comply with 4.11.4 and the content of IDENTIFY DEVICE data words 60-61 shall be equal to the new Maximum LBA + 1.

A successful READ NATIVE MAX ADDRESS command should immediately precede a SET MAX ADDRESS command. If the SET MAX ADDRESS command is not preceded by a successful READ NATIVE MAX ADDRESS command, the device shall return command aborted for the SET MAX ADDRESS command or process one of the following commands: SET MAX SET PASSWORD, SET MAX LOCK, SET MAX UNLOCK, SET MAX FREEZE LOCK. The result depends on the value of the Feature field.

When the device successfully processes a SET MAX ADDRESS command with the value returned by the READ NATIVE MAX ADDRESS command, the device shall:

- a) If the value returned by the READ NATIVE MAX EXT command is greater than the value returned by the READ NATIVE MAX command, then words 100-103 of IDENTIFY DEVICE shall indicate the value returned by the READ NATIVE MAX EXT command and words 60-61 shall comply with 4.11.4; or
- b) Otherwise words 60-61 of IDENTIFY DEVICE shall indicate the value returned by the READ NATIVE MAX command and words 100-103 shall comply with 4.11.4.

7.49.2.3 Inputs

7.49.2.3.1 Overview

Name	Description
Feature	N/A
Count	<p>Bit Description</p> <p>7:1 N/A</p> <p>0 Volatile_Value (V_V) - See 7.49.2.3.2.</p>
LBA	Maximum LBA
Device	<p>Bit Description</p> <p>7 Obsolete</p> <p>6 Shall be set to one</p> <p>5 Obsolete</p> <p>4 Transport Dependent - See 6.2.11</p> <p>3:0 Reserved</p>
Command	7:0 F9h

7.49.2.3.2 Volatile_Value (V_V)

If V_V is set to one, then, during processing of a power-on reset or a hardware reset, a device shall not change the content in words 60-61 (see 7.16.7.22) or 100-103 (see 7.16.7.51) in the IDENTIFY DEVICE data.

If V_V is cleared to zero, then, during processing of a power-on reset or a hardware reset, a device shall change the content in words 60-61 and words 100-103 in the IDENTIFY DEVICE data to be a value one greater than the value of either:

- a) the value in the SET MAX LBA field in the most recent SET MAX ADDRESS or SET MAX ADDRESS EXT command that completed without error in which V_V was set to one; or
- b) if no SET MAX ADDRESS or SET MAX ADDRESS EXT command has completed without error, then the native max address.

7.49.2.4 Normal Outputs

See Table 108.

7.49.2.5 Error Outputs

If the maximum value to be set exceeds the capacity of the device, a host protected area has been established by a SET MAX ADDRESS EXT command, or the device is HPA Locked or has successfully processed a SET MAX FREEZE LOCK command, then the device shall return command aborted. If the Maximum LBA is less than the native max address, then the ID Not Found bit shall be set to one if a previous non-volatile SET MAX ADDRESS command has been processed since the last power-on or hardware reset. The Abort bit shall be set to one if the maximum value requested exceeds the device capacity, a host protected area has been established by a SET MAX ADDRESS EXT command, the device is HPA Locked or has successfully processed a SET MAX FREEZE LOCK command, or the command is not immediately preceded by a READ NATIVE MAX ADDRESS command. See table 135.

7.49.3 SET MAX FREEZE LOCK – F9h/04h, Non-Data**7.49.3.1 Feature Set**

This 28-bit command is mandatory for devices that implement the HPA Security Extensions.

7.49.3.2 Description

After successful command completion, any subsequent SET MAX commands shall return command aborted until a power-on reset has been processed by the device.

Commands disabled by SET MAX FREEZE LOCK are:

- a) SET MAX ADDRESS
- b) SET MAX SET PASSWORD
- c) SET MAX LOCK
- d) SET MAX UNLOCK
- e) SET MAX ADDRESS EXT

This command should not be immediately preceded by a READ NATIVE MAX ADDRESS command. If this command is immediately preceded by a READ NATIVE MAX ADDRESS command, it shall be interpreted as a SET MAX ADDRESS command.

7.49.3.3 Inputs

Name	Description
Feature	04h
Count	N/A
LBA	N/A
Device	<p>Bit Description</p> <p>7 Obsolete</p> <p>6 N/A</p> <p>5 Obsolete</p> <p>4 Transport Dependent - See 6.2.11</p> <p>3:0 Reserved</p>
Command	7:0 F9h

7.49.3.4 Normal Outputs

See table 99.

7.49.3.5 Error Outputs

See table 125.

7.49.4 SET MAX LOCK - F9h/02h, Non-Data

7.49.4.1 Feature Set

This 28-bit command is mandatory for devices that implement the HPA Security Extensions.

7.49.4.2 Description

The device is HPA Locked when it successfully processes a SET MAX LOCK comand. When the device has successfully processed the SET MAX LOCK command, the HPA Security Extensions unlock counter shall be set to a value of five. After this command is completed any other SET MAX commands except SET MAX UNLOCK and SET MAX FREEZE LOCK shall be command aborted. The device shall remain in this state until a power-on reset has been processed or command completion without error of a SET MAX UNLOCK or SET MAX FREEZE LOCK command.

This command should not be immediately preceded by a READ NATIVE MAX ADDRESS command. If this command is immediately preceded by a READ NATIVE MAX ADDRESS command, it shall be interpreted as a SET MAX ADDRESS command.

7.49.4.3 Inputs

Name	Description
Feature	02h
Count	N/A
LBA	N/A
Device	<p>Bit Description</p> <p>7 Obsolete</p> <p>6 N/A</p> <p>5 Obsolete</p> <p>4 Transport Dependent - See 6.2.11</p> <p>3:0 Reserved</p>
Command	7:0 F9h

7.49.4.4 Normal Outputs

See table 99.

7.49.4.5 Error Outputs

The Abort bit shall be set to one if the device is HPA Locked or has successfully processed a SET MAX FREEZE LOCK command. See table 125.

7.49.5 SET MAX SET PASSWORD - F9h/01h, PIO Data-Out

7.49.5.1 Feature Set

This 28-bit command is mandatory for devices that implement the HPA Security Extensions.

7.49.5.2 Description

This command requests a transfer of a single 512-byte block of data from the host. Table 59 defines the content of this 512-byte block of data. The password is not retained by the device after the device has processed a power-on reset.

NOTE 23 — This password is not related to the passwords that are part of the Security feature set (see 4.20).

This command should not be immediately preceded by a READ NATIVE MAX ADDRESS command. If this command is immediately preceded by a READ NATIVE MAX ADDRESS command, it shall be interpreted as a SET MAX ADDRESS command.

7.49.5.3 Inputs

Name	Description
Feature	01h
Count	N/A
LBA	N/A
Device	<p>Bit Description</p> <ul style="list-style-type: none"> 7 Obsolete 6 N/A 5 Obsolete 4 Transport Dependent - See 6.2.11 3:0 Reserved
Command	7:0 F9h

7.49.5.4 Normal Outputs

See table 99.

7.49.5.5 Error Outputs

If a device is HPA Locked or has successfully processed a SET MAX FREEZE LOCK command, then the device shall return command aborted. A device may return command completion with the Error bit set to one if an Interface CRC error has occurred. See table 135.

7.49.5.6 Output From the Host to the Device Data Structure

Table 59 — SET MAX SET PASSWORD data content

Word	Content
0	Reserved
1-16	Password (32 bytes)
17-255	Reserved

7.49.6 SET MAX UNLOCK - F9h/03h, PIO Data-Out

7.49.6.1 Feature Set

This 28-bit command is mandatory for devices that implement the HPA Security Extensions.

7.49.6.2 Description

This command requests a transfer of a single 512-byte block of data from the host. Table 59 defines the content of this data.

The password supplied in the data transferred shall be compared with the password set by the SET MAX SET PASSWORD command.

If the device is locked from HPA commands and the password compare fails, then the device shall return command aborted and decrement the HPA Security Extensions unlock counter. This counter shall be decremented for each password mismatch when SET MAX UNLOCK is issued and the device is locked from HPA commands. When this counter reaches zero in a device, then the device shall return command aborted for all subsequent SET MAX UNLOCK commands until after the device has processed a power-on reset.

NOTE 24 — The HPA Security Extensions unlock counter is not related to the Security feature set unlock counter.

If the device is HPA Locked, the HPA Security Extensions unlock counter is not zero, and the password compare matches, then the device is HPA Unlocked and all SET MAX commands shall be accepted.

This command should not be immediately preceded by a READ NATIVE MAX ADDRESS command. If this command is immediately preceded by a READ NATIVE MAX ADDRESS command, it shall be interpreted as a SET MAX ADDRESS command.

7.49.6.3 Inputs

Name	Description
Feature	03h
Count	N/A
LBA	N/A
Device	<p>Bit Description</p> <p>7 Obsolete</p> <p>6 N/A</p> <p>5 Obsolete</p> <p>4 Transport Dependent - See 6.2.11</p> <p>3:0 Reserved</p>
Command	7:0 F9h

7.49.6.4 Normal Outputs

See table 99.

7.49.6.5 Error Outputs

If a device is not HPA Locked, then the device shall return command aborted. A device may return command completion with the Error bit set to one if an Interface CRC error has occurred. See table 126.

7.50 SET MAX ADDRESS EXT - 37h, Non-Data

7.50.1 Feature Set

This 48-bit command is mandatory for devices that implement both the HPA feature set and the 48-bit Address feature set.

7.50.2 Description

After successful command completion, all read and write access attempts to an LBA greater than the LBA specified by the successful SET MAX ADDRESS EXT command shall be rejected with an ID Not Found error.

A host should not issue more than one non-volatile SET MAX ADDRESS EXT command after a power-on or hardware reset.

The contents of IDENTIFY DEVICE data and the maximum LBA shall not be changed if a SET MAX ADDRESS EXT command fails.

After a successful SET MAX ADDRESS EXT command using a new maximum LBA the content of all IDENTIFY DEVICE data words shall comply with 4.11.4.

A successful READ NATIVE MAX EXT command should immediately precede SET MAX ADDRESS EXT. If the device receives a SET MAX ADDRESS EXT that is not immediately preceded by READ NATIVE MAX EXT, the device shall report command aborted.

7.50.3 Inputs

7.50.3.1 Overview

Name	Description
Feature	N/A
Count	<p>Bit Description</p> <p>15:1 N/A</p> <p>0 Volatile_Value (V_V) - See 7.50.3.2.</p>
LBA	Maximum LBA
Device	<p>Bit Description</p> <p>7 Obsolete</p> <p>6 Shall be set to one</p> <p>5 Obsolete</p> <p>4 Transport Dependent - See 6.2.11</p> <p>3:0 Reserved</p>
Command	7:0 37h

7.50.3.2 Volatile_Value (V_V)

If V_V is set to one, then, during processing of a power-on reset or a hardware reset, a device shall not change the content in words 60-61 (see 7.16.7.22) or 100-103 (see 7.16.7.51) in the IDENTIFY DEVICE data.

If V_V is cleared to zero, then, during processing of a power-on or hardware reset, a device shall:

- a) change the content in words 100-103 in the IDENTIFY DEVICE data to be a value one greater than the value of either:

- A) the value in the SET MAX LBA field in the most recent SET MAX ADDRESS or SET MAX ADDRESS EXT command that completed without error in which V_V was set to one; or
 - B) if no SET MAX ADDRESS or SET MAX ADDRESS EXT command has completed without error, then the native max address;
- and
- b) change the content in words 60-61 in the IDENTIFY DEVICE data to be the value in words 100-103 in IDENTIFY DEVICE data or 0FFF_FFFFh, whichever is less.

Regardless of the setting of V_V, a device shall not change the content in words 60-61 or 100-103 in the IDENTIFY DEVICE data during processing of a software reset.

7.50.4 Normal Outputs

See table 112.

7.50.5 Error Outputs

If the maximum value to be set exceeds the capacity of the device, a host protected area has been established by a SET MAX ADDRESS command, the command is not immediately preceded by a READ NATIVE MAX ADDRESS EXT command, the device is HPA Locked, or the device has successfully processed a SET MAX FREEZE LOCK command, then the device shall return command aborted. If the Maximum LBA is less than the native max address, then the ID Not Found bit shall be set to one if a previous non-volatile SET MAX ADDRESS EXT command has been processed since the last power-on or hardware reset. See table 149.

7.51 SET MULTIPLE MODE - C6h, Non-Data

7.51.1 Feature Set

This 28-bit command is mandatory for devices implementing the General feature set

7.51.2 Description

This command establishes the number of logical sectors in the DRQ data block count for READ MULTIPLE, READ MULTIPLE EXT, WRITE MULTIPLE, and WRITE MULTIPLE EXT commands. The content of the Count field shall be less than or equal to the value in IDENTIFY DEVICE data word 47 bits (7:0). The host should set the content of the Count field to 1, 2, 4, 8, 16, 32, 64 or 128.

Devices shall support the DRQ data block size specified in the IDENTIFY DEVICE data word 47 bits (7:0), and may also support smaller values.

Upon receipt of the command, the device checks the Count field. If the content of the Count field is not zero, the Count field contains a valid value, and the DRQ data block count is supported, then the value in the Count field is used for all subsequent READ MULTIPLE, READ MULTIPLE EXT, WRITE MULTIPLE, WRITE MULTIPLE EXT and WRITE MULTIPLE FUA EXT commands and their execution is enabled.

If the content of the Count field is zero and the SET MULTIPLE command completes without error, then the device shall respond to any subsequent READ MULTIPLE, READ MULTIPLE EXT, WRITE MULTIPLE, WRITE MULTIPLE EXT, and WRITE MULTIPLE FUA EXT command with command aborted until a subsequent successful SET MULTIPLE command completion where the Count field is not set to zero.

If the content of the Count field is zero, then the device may:

- a) disable multiple mode (i.e., respond with command aborted for all subsequent READ MULTIPLE, READ MULTIPLE EXT, WRITE MULTIPLE, WRITE MULTIPLE EXT, and WRITE MULTIPLE FUA EXT commands);
- b) return command aborted for all SET MULTIPLE MODE commands; or
- c) retain the previous multiple mode settings.

After a successful SET MULTIPLE command the device shall report the valid value set by that command in IDENTIFY DEVICE data word 59.

After a power-on or hardware reset, if IDENTIFY DEVICE data word 59 bit 8 is set to one and IDENTIFY DEVICE data word 59 bits (7:0) are cleared to zero, a SET MULTIPLE command is required before issuing a READ MULTIPLE, READ MULTIPLE EXT, WRITE MULTIPLE, or WRITE MULTIPLE EXT command. If bit 8 is set to one and bits (7:0) are not cleared to zero, a SET MULTIPLE command may be issued to change the multiple value required before issuing a READ MULTIPLE, READ MULTIPLE EXT, WRITE MULTIPLE, or WRITE MULTIPLE EXT command.

7.51.3 Inputs

Name	Description
Feature	N/A
Count	Number of logical sectors per DRQ Block
LBA	N/A
Device	<p data-bbox="402 415 602 449">Bit Description</p> <p data-bbox="423 457 565 491">7 Obsolete</p> <p data-bbox="423 499 505 533">6 N/A</p> <p data-bbox="423 541 565 575">5 Obsolete</p> <p data-bbox="423 583 854 617">4 Transport Dependent - See 6.2.11</p> <p data-bbox="402 625 570 659">3:0 Reserved</p>
Command	7:0 C6h

7.51.4 Normal Outputs

See table 99.

7.51.5 Error Outputs

The Abort bit shall be set to one if the block count is not supported. See table 122.

7.52 SLEEP - E6h, Non-Data

7.52.1 Feature Set

This 28-bit command is mandatory for devices implementing the Power Management feature set.

7.52.2 Description

This command is the only way to cause the device to enter Sleep mode. The device shall exit Sleep (i.e., State PM3) only after processing a hardware reset, a software reset, or a DEVICE RESET command.

A device shall not power-on in Sleep mode.

7.52.3 Inputs

Name	Description
Feature	N/A
Count	N/A
LBA	N/A
Device	<p>Bit Description</p> <ul style="list-style-type: none"> 7 Obsolete 6 Shall be set to one 5 Obsolete 4 Transport Dependent - See 6.2.11 3:0 Reserved
Command	7:0 E6h

7.52.4 Normal Outputs

See table 99.

7.52.5 Error Outputs

See table 122.

7.53 SMART

7.53.1 Overview

Individual SMART commands are identified by the value placed in the Feature field. Table 60 shows these values.

Table 60 — SMART Feature field values

Value	Command
00h-CFh	Reserved
D0h	SMART READ DATA
D1h	Obsolete
D2h	SMART ENABLE/DISABLE ATTRIBUTE AUTOSAVE
D3h	Obsolete
D4h	SMART EXECUTE OFF-LINE IMMEDIATE
D5h	SMART READ LOG
D6h	SMART WRITE LOG
D7h	Obsolete
D8h	SMART ENABLE OPERATIONS
D9h	SMART DISABLE OPERATIONS
DAh	SMART RETURN STATUS
DBh	Obsolete
DCh-DFh	Reserved
E0h-FFh	vendor specific

7.53.2 SMART DISABLE OPERATIONS - B0h/D9h, Non-Data

7.53.2.1 Feature Set

This 28-bit command is mandatory for devices that implement the SMART feature set.

7.53.2.2 Description

After command acceptance the device shall disable all SMART operations. After completion of this command without error the device shall report command aborted for all other SMART commands (e.g., SMART DISABLE OPERATIONS commands), except for the SMART ENABLE OPERATIONS command and the SCT Command Transport commands, which shall be processed as defined. The state of SMART, either enabled or disabled, shall be preserved by the device during all power-on reset events.

7.53.2.3 Inputs

Name	Description
Feature	D9h
Count	N/A
LBA	<p>Bit Description</p> <p>27:24 N/A</p> <p>23:8 C24Fh</p> <p>7:0 N/A</p>
Device	<p>Bit Description</p> <p>7 Obsolete</p> <p>6 N/A</p> <p>5 Obsolete</p> <p>4 Transport Dependent - See 6.2.11</p> <p>3:0 Reserved</p>
Command	7:0 B0h

7.53.2.4 Normal Outputs

See table 99.

7.53.2.5 Error Outputs

The Abort bit shall be set to one if SMART is not enabled, or if an input value is invalid. See table 122.

7.53.3 SMART ENABLE/DISABLE ATTRIBUTE AUTOSAVE - B0h/D2h, Non-Data

7.53.3.1 Feature Set

This 28-bit command is mandatory for devices that implement the SMART feature set.

7.53.3.2 Description

This command enables and disables the optional attribute autosave feature of the device. This command may either allow the device, after some vendor specified event, to save the device updated attributes to non-volatile memory; or this command may cause the autosave feature to be disabled. The state of the attribute autosave feature, either enabled or disabled, shall be preserved by the device during all power and reset events.

A value of zero written by the host into the device's Count field before issuing this command shall cause this feature to be disabled. Disabling this feature does not preclude the device from saving SMART data to non-volatile memory during some other normal operation (e.g., during a power-on or power-off sequence or during an error recovery sequence).

A value of F1h written by the host into the device's Count field before issuing this command shall cause this feature to be enabled. Any other other non-zero value written by the host into this field before issuing this command is vendor specific. The meaning of any non-zero value written to this field at this time shall be preserved by the device during all power and reset events.

If the device receives a command from the host while executing the autosave routine the device shall begin processing the command within two seconds.

7.53.3.3 Inputs

Name	Description
Feature	D2h
Count	<p data-bbox="370 331 602 363">Value Description</p> <p data-bbox="396 375 764 407">00h Disable attribute autosave</p> <p data-bbox="339 420 639 451">01h-F0h Vendor specific</p> <p data-bbox="396 464 756 495">F1h Enable attribute autosave</p> <p data-bbox="339 508 639 539">F2h-FFh Vendor specific</p>
LBA	<p data-bbox="402 630 602 661">Bit Description</p> <p data-bbox="370 674 501 705">27:24 N/A</p> <p data-bbox="386 718 537 749">23:8 C24Fh</p> <p data-bbox="402 762 501 793">7:0 N/A</p>
Device	<p data-bbox="402 884 602 915">Bit Description</p> <p data-bbox="423 928 565 959">7 Obsolete</p> <p data-bbox="423 972 501 1003">6 N/A</p> <p data-bbox="423 1016 565 1047">5 Obsolete</p> <p data-bbox="423 1060 854 1092">4 Transport Dependent - See 6.2.11</p> <p data-bbox="402 1104 570 1136">3:0 Reserved</p>
Command	7:0 B0h

7.53.3.4 Normal Outputs

See table 99.

7.53.3.5 Error Outputs

The Abort bit shall be set to one if SMART is not enabled, or if an input value is invalid. See table 122.

7.53.4 SMART ENABLE OPERATIONS - B0h/D8h, Non-Data**7.53.4.1 Feature Set**

This 28-bit command is mandatory for devices that implement the SMART feature set.

7.53.4.2 Description

This command enables access to all available SMART capabilities within the device. The state of SMART, either enabled or disabled, shall be preserved by the device during all power and reset events. Once enabled, the receipt of subsequent SMART ENABLE OPERATIONS commands shall not affect any SMART data or functions.

7.53.4.3 Inputs

Name	Description
Feature	D8h
Count	N/A
LBA	<p style="text-align: center;">Bit Description</p> 27:24 N/A 23:8 C24Fh 7:0 N/A
Device	<p style="text-align: center;">Bit Description</p> 7 Obsolete 6 N/A 5 Obsolete 4 Transport Dependent - See 6.2.11 3:0 Reserved
Command	7:0 B0h

7.53.4.4 Normal Outputs

See table 99.

7.53.4.5 Error Outputs

See table 122.

7.53.5 SMART EXECUTE OFF-LINE IMMEDIATE - B0h/D4h, Non-Data

7.53.5.1 Feature Set

This 28-bit command is optional for devices that implement the SMART feature set.

7.53.5.2 Description

7.53.5.2.1 Overview

This command causes the device to immediately initiate the optional set of activities that collect SMART data in an off-line mode and then preserve this data across power and reset events, or process a vendor specific self-diagnostic test routine in either captive or off-line mode. Table 61 lists the SMART EXECUTE OFF-LINE IMMEDIATE Subcommands.

Table 61 — SMART EXECUTE OFF-LINE IMMEDIATE Subcommands

Value	Description of subcommand to be processed
00h	Execute SMART off-line routine immediately in off-line mode
01h	Execute SMART Short self-test routine immediately in off-line mode
02h	Execute SMART Extended self-test routine immediately in off-line mode
03h	Execute SMART Conveyance self-test routine immediately in off-line mode
04h	Execute SMART Selective self-test routine immediately in off-line mode
05h-3Fh	Reserved
40h-7Eh	Vendor specific
7Fh	Abort off-line mode self-test routine
80h	Reserved
81h	Execute SMART Short self-test routine immediately in captive mode
82h	Execute SMART Extended self-test routine immediately in captive mode
83h	Execute SMART Conveyance self-test routine immediately in captive mode
84h	Execute SMART Selective self-test routine immediately in captive mode
85h-8Fh	Reserved
90h-FFh	Vendor specific

7.53.5.2.2 Off-line mode

The following describes the protocol for executing a SMART EXECUTE OFF-LINE IMMEDIATE subcommand routine, including a self-test routine, in the off-line mode:

- 1) the device shall report command completion before processing the subcommand routine;
- 2) the device shall remain ready to receive a new command during execution of the subcommand routine;
- 3) if the device is in the process of performing the subcommand routine and is interrupted by any new command from the host except a SLEEP, SMART DISABLE OPERATIONS, SMART EXECUTE OFF-LINE IMMEDIATE, or STANDBY IMMEDIATE command, the device shall suspend or abort the subcommand routine and begin processing the new command within two seconds after receipt of the new command. After servicing the interrupting command from the host the device may immediately re-initiate or resume the subcommand routine without any additional commands from the host (see 7.53.6.10);
- 4) if the device is in the process of performing a subcommand routine and is interrupted by a SLEEP command from the host, the device may abort the subcommand routine and process the SLEEP command. If the device is in the process of performing any self-test routine and is interrupted by a SLEEP command from the host, the device shall abort the subcommand routine and process the SLEEP command;
- 5) if the device is in the process of performing the subcommand routine and is interrupted by a SMART DISABLE OPERATIONS command from the host, the device shall suspend or abort the subcommand routine and begin processing the new command within two seconds after receipt of the command. Upon

- receipt of the next SMART ENABLE OPERATIONS command the device may, either re-initiate the subcommand routine or resume the subcommand routine from where it had been previously suspended;
- 6) if the device is in the process of performing the subcommand routine and is interrupted by a SMART EXECUTE OFF-LINE IMMEDIATE command from the host, the device shall abort the subcommand routine and begin processing the new command within two seconds after receipt of the command. The device shall then service the new SMART EXECUTE OFF-LINE IMMEDIATE subcommand;
 - 7) if the device is in the process of performing the subcommand routine and is interrupted by a STANDBY IMMEDIATE or IDLE IMMEDIATE command from the host, the device shall suspend or abort the subcommand routine, and begin processing the new command within two seconds after receipt of the command. After receiving a new command that causes the device to exit a power saving mode, the device shall initiate or resume the subcommand routine without any additional commands from the host unless these activities were aborted by the host;
 - 8) while the device is performing the subcommand routine it shall not change power states (e.g., as a result of its Standby timer expiring); and
 - 9) if a test failure occurs while a device is performing a self-test routine the device may discontinue the testing and place the test results in the Self-test execution status byte (see table 62).

7.53.5.2.3 Captive mode

When executing a self-test in captive mode, the device executes the self-test routine after receipt of the command. At the end of the routine the device places the results of this routine in the Self-test execution status byte (see table 62) and reports command completion. If an error occurs while a device is performing the routine the device may discontinue its testing, place the results of this routine in the Self-test execution status byte, and complete the command.

7.53.5.2.4 SMART off-line routine

This routine shall only be performed in the off-line mode. The results of this routine are placed in the Off-line data collection status byte (see table 63).

7.53.5.2.5 SMART Short self-test routine

Depending on the value in the LBA field (7:0), this self-test routine may be performed in either the captive or the off-line mode. This self-test routine should take on the order of minutes to complete (see table 62).

7.53.5.2.6 SMART Extended self-test routine

Depending on the value in the LBA field (7:0), this self-test routine may be performed in either the captive or the off-line mode. This self-test routine should take on the order of tens of minutes to complete (see table 62).

7.53.5.2.7 SMART Conveyance self-test routine

Depending on the value in the LBA field (7:0), this self-test routine may be performed in either the captive or the off-line mode. This self-test routine is intended to identify damage incurred during transporting of the device. This self-test routine should take on the order of minutes to complete (see table 62).

7.53.5.2.8 SMART Selective self-test routine

The SMART Selective self-test routine is an optional self-test routine. If the routine is implemented, all features of the routine shall be implemented. Support for the routine is indicated in off-line data collection capabilities (see 7.53.6.10). When the value in the LBA field (7:0) is 4 or 132, the Selective self-test routine shall be performed. This self-test routine shall include the initial tests performed by the Extended self-test routine plus a selectable read scan. The host should not write the Selective self-test log while the execution of a Selective self-test command is in progress.

The host may choose to do read scan only on specific areas of the media. To do this, the host should set the test spans desired in the Selective self-test log and set the flags in the Feature flags field of the Selective self-test log to indicate do not perform off-line scan. In this case, the test spans defined shall be read scanned in their entirety. The Selective self-test log is updated as the self-test proceeds indicating test progress. When all specified test spans have been completed, the test is terminated and the appropriate self-test execution status is reported in the SMART READ DATA response depending on the occurrence of errors. Figure 16 shows an example of a Selective self-test definition with three test spans defined. In this example, the test terminates when all three test spans have been scanned.

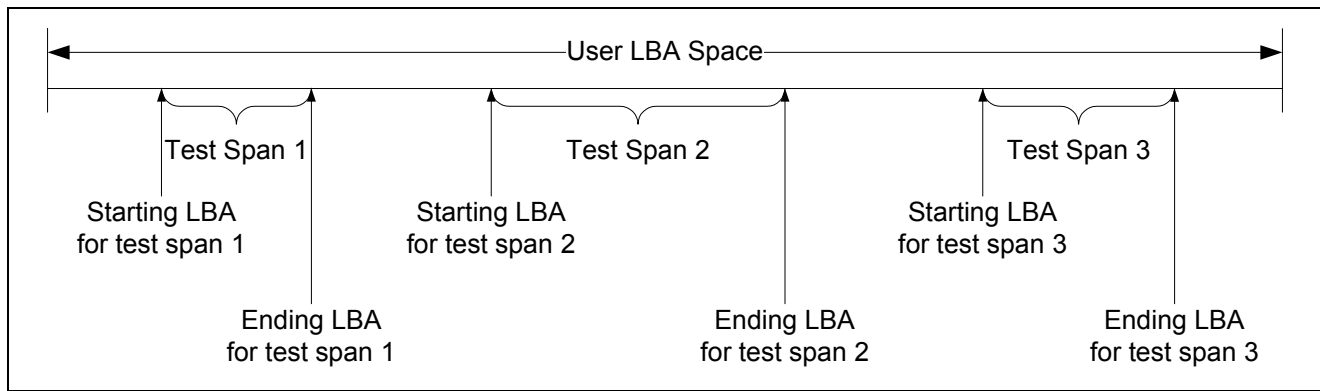

Figure 16 — Selective self-test span example

After the scan of the selected spans described above, the host may cause the device to scan the rest of media in an off-line mode by setting the flag to enable off-line scan in addition to the other settings. If an error occurs during the scanning of the test spans, the error is reported in the self-test execution status in the SMART READ DATA response and the off-line scan is not executed. When the test spans defined have been scanned, then the device shall:

- a) set the off-line scan pending and active flags in the Selective self-test log to one;
- b) set the span under test to a value greater than five;
- c) set the self-test execution status in the SMART READ DATA response to 00h;
- d) set a value of 03h in the off-line data collection status in the SMART READ DATA response; and
- e) proceed to perform an off-line read scan through all areas not included in the test spans.

This off-line read scan shall be completed as soon as possible, no pauses between block reads, and any errors encountered shall not be reported to the host. Instead error locations may be logged for future reallocation. If the device is powered-down before the off-line scan is completed, the off-line scan shall resume when the device is again powered up. From power-up, the resumption of the scan shall be delayed the time indicated in the Selective self-test pending time field in the Selective self-test log. During this delay time the pending flag shall be set to one and the active flag shall be set to zero in the Selective self-test log. Once the time expires, the active flag shall be set to one, and the off-line scan shall resume. When the entire media has been scanned, the off-line scan shall terminate, both the pending and active flags shall be cleared to zero, and the off-line data collection status in the SMART READ DATA response shall be set to 02h indicating completion.

The time to complete off-line testing and the self-test polling times do not apply to the selective self-test. Progress through the test spans is indicated in the selective self-test log.

When bit 3 in the Selective self-test feature flags field is set to one (see A.13), a device shall continue processing the Selective self-test after processing a hardware reset or a software reset. When bit 3 in the Selective self-test feature flags field is cleared to zero, a device shall abort the Selective self-test during processing a hardware reset or a software reset.

If a device receives a SMART EXECUTE OFF-LINE IMMEDIATE command with the Abort off-line test routine subcommand, then the device shall abort the Selective self-test.

If a device receives a SMART EXECUTE OFF-LINE IMMEDIATE command specifying that the device perform a self-test while a selective self-test is in progress, the device shall abort the selective self-test and process the specified self-test.

7.53.5.3 Inputs

Name	Description
Feature	D4h
Count	N/A
LBA	<p style="text-align: center;">Bit Description</p> 27:24 N/A 23:8 C24Fh 7:0 Table 61 defines the subcommand that shall be processed
Device	<p style="text-align: center;">Bit Description</p> 7 Obsolete 6 N/A 5 Obsolete 4 Transport Dependent - See 6.2.11 3:0 Reserved
Command	7:0 B0h

7.53.5.4 Normal Outputs

See table 109.

7.53.5.5 Error Outputs

The ID Not Found bit shall be set to one if the SMART data is not available. The Abort bit shall be set to one if SMART is not enabled or if a self-test fails while executing a sequence in captive mode. See table 138.

7.53.6 SMART READ DATA - B0h/D0h, PIO Data-In**7.53.6.1 Feature Set**

This 28-bit command is optional for devices that implement the SMART feature set.

7.53.6.2 Description

This command returns the Device SMART data structure to the host.

7.53.6.3 Inputs

Name	Description
Feature	D0h
Count	N/A
LBA	<p style="text-align: center;">Bit Description</p> 27:24 N/A 23:8 C24Fh 7:0 N/A
Device	<p style="text-align: center;">Bit Description</p> 7 Obsolete 6 N/A 5 Obsolete 4 Transport Dependent - See 6.2.11 3:0 Reserved
Command	7:0 B0h

7.53.6.4 Normal Outputs

See table 99.

7.53.6.5 Error Outputs

If SMART data is uncorrectable, then the device shall return command completion with the Uncorrectable bit set to one. If the SMART data is not available or the data structure checksum is invalid, then the device shall return command completion with the ID Not Found bit set to one. If SMART is not enabled or if field values are invalid, then the device shall return command aborted. A device may return command completion with the Error bit set to one if an Interface CRC error has occurred. See table 146.

NOTE 25 — There is no defined mechanism for a device to return an Interface CRC error status that may have occurred during the last data block of a PIO-in data transfer; there may be other mechanisms in which a host may verify that an Interface CRC error occurred in these cases.

7.53.6.6 Input From the Device to the Host Data Structure

Table 62 defines the 512 bytes that make up the Device SMART data structure.

Table 62 — Device SMART data structure

Byte	F/V	Description
0-361	X	Vendor specific
362	V	Off-line data collection status
363	X	Self-test execution status byte
364-365	V	Total time in seconds to complete off-line data collection activity (word)
366	X	Vendor specific
367	F	Off-line data collection capability
368-369	F	SMART capability
370	F	Error logging capability 7:1 Reserved 0 1=Device error logging supported
371	X	Vendor specific
372	F	Short self-test routine recommended polling time (in minutes)
373	F	Extended self-test routine recommended polling time in minutes. If FFh, use bytes 375 and 376 for the polling time.
374	F	Conveyance self-test routine recommended polling time in minutes
375-376	F	Extended self-test routine recommended polling time in minutes (word)
377-385	R	Reserved
386-510	X	Vendor specific
511	V	Data structure checksum
Key: F = the content of the byte is fixed and does not change. V = the content of the byte is variable and may change depending on the state of the device or the commands processed by the device. X = the content of the byte is vendor specific and may be fixed or variable. R = the content of the byte is reserved and shall be zero.		

7.53.6.7 Off-line collection status byte

The value of the off-line data collection status byte defines the current status of the off-line activities of the device. Table 63 lists the values and their respective definitions.

Table 63 — Off-line data collection status byte values

Value	Definition
00h or 80h	Off-line data collection activity was never started.
01h	Reserved
02h or 82h	Off-line data collection activity was completed without error.
03h	Off-line activity in progress.
04h or 84h	Off-line data collection activity was suspended by an interrupting command from host.
05h or 85h	Off-line data collection activity was aborted by an interrupting command from host.
06h or 86h	Off-line data collection activity was aborted by the device with a fatal error.
07h-3Fh	Reserved
40h-7Fh	Vendor specific
81h	Reserved
83h	Reserved
87h-BFh	Reserved
C0h-FFh	Vendor specific

7.53.6.8 Self-test execution status byte

The self-test execution status byte reports the execution status of the self-test routine as follows:

- a) for bits (3:0) (i.e., Percent Self-Test Remaining), the value indicates an approximation of the percent of the self-test routine remaining until completion in ten percent increments. Valid values are 9 through 0. A value of 0 indicates that the self-test routine is complete. A value of 9 indicates 90% of total test time is remaining; and
- b) for bits (7:4) (i.e., Self-test Execution Status), the value indicates the current Self-test Execution Status (see table 64).

Table 64 — Self-test execution status values

Value	Description
0h	The previous self-test routine completed without error or no self-test has ever been run
1h	The self-test routine was aborted by the host
2h	The self-test routine was interrupted by the host with a hardware or software reset
3h	A fatal error or unknown test error occurred while the device was executing its self-test routine and the device was unable to complete the self-test routine.
4h	The previous self-test completed having a test element that failed and the test element that failed is not known.
5h	The previous self-test completed having the electrical element of the test failed.
6h	The previous self-test completed having the servo and/or seek test element of the test failed.
7h	The previous self-test completed having the read element of the test failed.
8h	The previous self-test completed having a test element that failed and the device is suspected of having handling damage.
9h-Eh	Reserved.
Fh	Self-test routine in progress.

7.53.6.9 Total time to complete off-line data collection

The total estimated time in seconds to complete off-line data collection activity word specifies how many seconds the device requires to complete the sequence of off-line data collection activity. Valid values for this word are from 0001h to FFFFh.

7.53.6.10 Off-line data collection capabilities

Table 65 defines the off-line data collection capability bits. If the value of all of these bits is cleared to zero, then no off-line data collection is implemented by this device.

Table 65 — Offline Data Collection Capabilities

Bit	Description
7	Reserved
6	Selective self-test implemented - If this bit is cleared to zero, the device does not implement the Selective self-test routine. If this bit is set to one, the device implements the Selective self-test routine.
5	Conveyance self-test implemented - If this bit is cleared to zero, the device does not implement the Conveyance self-test routines. If this bit is set to one, the device implements the Conveyance self-test routines.
4	Self-test implemented - If this bit is cleared to zero, the device does not implement the Short and Extended self-test routines. If this bit is set to one, the device implements the Short and Extended self-test routines.
3	Off-line read scanning implemented - If this bit is cleared to zero, the device does not support off-line read scanning. If this bit is set to one, the device supports off-line read scanning.
2	Abort/restart off-line by host - If this bit is set to one, then the device shall abort all off-line data collection activity initiated by a SMART EXECUTE OFF-LINE IMMEDIATE command upon receipt of a new command within 2 seconds of receiving the new command. If this bit is cleared to zero, the device shall suspend off-line data collection activity after an interrupting command and resume off-line data collection activity after some vendor-specified event.
1	Vendor specific.
0	EXECUTE OFF-LINE IMMEDIATE implemented - If this bit is set to one, then the SMART EXECUTE OFF-LINE IMMEDIATE command is implemented by this device. If this bit is cleared to zero, then the SMART EXECUTE OFF-LINE IMMEDIATE command is not implemented by this device.

7.53.6.11 SMART capabilities

The following defines the SMART capabilities bits:

- a) If bit 0 is set to one, then the device saves SMART data prior to going into a power saving mode (i.e., Idle, Standby, or Sleep) or immediately upon return to Active or Idle mode from a Standby mode. If bit 0 is cleared to zero, then the device does not save SMART data prior to going into a power saving mode (Idle, Standby, or Sleep) or immediately upon return to Active or Idle mode from a Standby mode;
- b) Bit 1 shall be set to one to indicate that the device supports the SMART ENABLE/DISABLE ATTRIBUTE AUTOSAVE command; and
- c) Bits (15:2) are reserved.

7.53.6.12 Self-test routine recommended polling time

The self-test routine recommended polling time shall be equal to the estimated number of minutes that is the minimum recommended time before which the host should first poll check for test completion status. Actual test time may be several times this value. The host should wait at least this long before sending the first SMART READ DATA command to check for test completion status. Polling Checking before this time may extend the self-test execution time or abort the test depending on the state of bit 2 of the offline data capability bits. Subsequent checking by the host should be at a vendor specific interval.

7.53.6.13 Data structure checksum

The data structure checksum is the two's complement of the sum of the first 511 bytes in the data structure. Each byte shall be added with unsigned arithmetic, and overflow shall be ignored. The sum of all 512 bytes shall be zero when the checksum is correct. The checksum is placed in byte 511.

7.53.7 SMART READ LOG - B0h/D5h, PIO Data-In**7.53.7.1 Feature Set**

This 28-bit command is optional for devices that implement the SMART feature set.

7.53.7.2 Description

This command returns the specified log to the host. See table A.2 for the list of logs.

7.53.7.3 Inputs

Name	Description
Feature	D5h
Count	Specifies the number of log pages to be read from the specified log. The log transferred by the ATA device shall start at the first page in the specified log, regardless of the Count requested
LBA	<p style="text-align: center;">Bit Description</p> <p>27:24 N/A</p> <p>23:8 C24Fh</p> <p>7:0 Log Address - Specifies the log to be read as described in table A.2. See 7.29.3.3 for more information</p>
Device	<p style="text-align: center;">Bit Description</p> <p>7 Obsolete</p> <p>6 N/A</p> <p>5 Obsolete</p> <p>4 Transport Dependent - See 6.2.11</p> <p>3:0 Reserved</p>
Command	7:0 B0h

7.53.7.4 Normal Outputs

See table 99.

7.53.7.5 Error Outputs

The Uncorrectable Error bit shall be set to one if SMART data is uncorrectable. The ID Not Found bit shall be set to one if the data is not available or the data structure checksum is invalid. The Abort bit shall be set to one if SMART is not enabled, if the Count field is cleared to zero, or if field values are invalid. The Abort bit shall be set to one if the Count is larger than the log size reported in the Log Directory. A device may return command completion with the Error bit set to one if an Interface CRC error has occurred. See table 146.

7.53.8 SMART RETURN STATUS - B0h/DAh, Non-Data**7.53.8.1 Feature Set**

This 28-bit command is mandatory for devices that implement the SMART feature set.

7.53.8.2 Description

This command causes the device to communicate the reliability status of the device to the host.

7.53.8.3 Inputs

Name	Description
Feature	DAh
Count	N/A
LBA	<p style="text-align: center;">Bit Description</p> 27:24 N/A 23:8 C24Fh 7:0 N/A
Device	<p style="text-align: center;">Bit Description</p> 7 Obsolete 6 N/A 5 Obsolete 4 Transport Dependent - See 6.2.11 3:0 Reserved
Command	7:0 B0h

7.53.8.4 Normal Outputs

See table 110.

7.53.8.5 Error Outputs

The Abort bit shall be set to one if SMART is not enabled. See table 122.

7.53.9 SMART WRITE LOG - B0h/D6h, PIO Data-Out

7.53.9.1 Feature Set

This 28-bit command is optional for devices that implement the SMART feature set.

7.53.9.2 Description

Specifies the log to be written as described in table A.2. This command causes the device to write the specified number of log pages to the specified log. See table A.2 for the list of logs.

7.53.9.3 Inputs

7.53.9.3.1 Overview

Name	Description
Feature	D6h
Count	Specifies the number of log pages that shall be written. The data transferred to the device shall be stored starting at the first block in the specified log. If the device receives a value of zero in this field, then the device shall report command aborted
LBA	<p>Bit Description</p> <p>27:24 N/A</p> <p>23:8 C24Fh</p> <p>7:0 Log Address - See 7.53.9.3.2</p>
Device	<p>Bit Description</p> <p>7 Obsolete</p> <p>6 N/A</p> <p>5 Obsolete</p> <p>4 Transport Dependent - See 6.2.11</p> <p>3:0 Reserved</p>
Command	7:0 B0h

7.53.9.3.2 Log Address

A device may support a subset of the available logs. Support for individual logs is determined by support for the associated feature set. Support of the associated log(s) is mandatory for devices implementing the associated feature set. If the host attempts to write to a read only log address, the device shall return command aborted.

7.53.9.4 Normal Outputs

See table 99.

7.53.9.5 Error Outputs

If the SMART data is not available, then the device shall return command completion with the ID Not Found bit set to one. If SMART is not enabled, the log is not implemented, or the Count field is cleared to zero, then the device shall return command aborted for the command. A device may return command completion with the Error bit set to one if an Interface CRC error has occurred. See table 136.

7.54 STANDBY - E2h, Non-Data

7.54.1 Feature Set

This 28-bit command is mandatory for devices that implement the Power Management feature set.

7.54.2 Description

This command causes the device to enter the Standby mode.

If the Count field is non-zero then the Standby timer shall be enabled. The value in the Count field shall be used to determine the time programmed into the Standby timer (see table 40).

If the Count field is zero then the Standby timer is disabled.

7.54.3 Inputs

Name	Description
Feature	N/A
Count	This value shall determine the time period programmed into the Standby timer. Table 40 defines these values.
LBA	N/A
Device	<p>Bit Description</p> <p>7 Obsolete</p> <p>6 N/A</p> <p>5 Obsolete</p> <p>4 Transport Dependent - See 6.2.11</p> <p>3:0 Reserved</p>
Command	7:0 E2h

7.54.4 Normal Outputs

See table 99.

7.54.5 Error Outputs

See table 122.

7.55 STANDBY IMMEDIATE - E0h, Non-Data

7.55.1 Feature Set

This 28-bit command is mandatory for devices that implement the Power Management feature set.

7.55.2 Description

This command causes the device to immediately enter the Standby mode.

7.55.3 Inputs

Name	Description
Feature	N/A
Count	N/A
LBA	N/A
Device	<p style="text-align: center;">Bit Description</p> <p style="text-align: center;">7 Obsolete</p> <p style="text-align: center;">6 N/A</p> <p style="text-align: center;">5 Obsolete</p> <p style="text-align: center;">4 Transport Dependent - See 6.2.11</p> <p style="text-align: center;">3:0 Reserved</p>
Command	7:0 E0h

7.55.4 Normal Outputs

See table 99.

7.55.5 Error Outputs

See table 122.

7.56 TRUSTED NON-DATA - 5Bh, Non-Data

7.56.1 Feature Set

This 28-bit command is optional for devices implementing the Trusted Computing feature set.

7.56.2 Description

The TRUSTED NON-DATA command delivers the SP Specific field using the specified Security Protocol.

7.56.3 Inputs

7.56.3.1 Overview

Name	Description
Feature	Security Protocol (see 7.57.3.2)
Count	Reserved
LBA	<p>Bit Description</p> <p>27:25 Reserved</p> <p>24 0 - Non-Data TRUSTED SEND, 1 - Non-Data TRUSTED RECEIVE</p> <p>23:8 SP Specific - Security Protocol Specific (see 7.57.6)</p> <p>7:0 Reserved</p>
Device	<p>Bit Description</p> <p>7 Obsolete</p> <p>6 N/A</p> <p>5 Obsolete</p> <p>4 Transport Dependent - See 6.2.11</p> <p>3:0 Reserved</p>
Command	7:0 5Bh

7.56.3.2 Security Protocol

If Bit 24 is cleared to zero then see 7.59.3.2; otherwise, see 7.57.3.2.

7.56.4 Normal Outputs

If Bit 24 is cleared to zero then see 7.59.4; otherwise, see 7.57.4.

7.56.5 Error Outputs

If Bit 24 is cleared to zero then see 7.59.5; otherwise, see 7.57.5.

7.57 TRUSTED RECEIVE - 5Ch, PIO Data-In

7.57.1 Feature Set

This 28-bit command is mandatory for devices implementing the Trusted Computing feature set.

7.57.2 Description

The TRUSTED RECEIVE command retrieves security protocol information (see 7.57.6) or the results from one or more TRUSTED SEND commands.

Any association between a previous TRUSTED SEND command and the data transferred by a TRUSTED RECEIVE command depends on the protocol specified by the Security Protocol field (see table 66). If the device has no data to transfer (e.g., the results for any previous TRUSTED SEND commands are not yet available), the device may transfer data indicating it has no other data to transfer.

Indications of data overrun or underrun and the mechanism, if any, for processing retries depend on the protocol specified by the Security Protocol field (see table 66).

For Security Protocol field set to 00h, the format of the data is described in 7.57.6. The format of the data for other Security Protocol values is documented by the group that owns the associated Security Protocol value.

The device shall retain data resulting from a TRUSTED SEND command awaiting retrieval by a TRUSTED RECEIVE command until one of the following events is processed:

- a) the data is delivered according to the Security Protocol field (see table 66) specific rules for the TRUSTED RECEIVE command;
- b) any reset; or
- c) loss of communication with the host that sent the TRUSTED SEND command.

7.57.3 Inputs

7.57.3.1 Overview

Name	Description
Feature	Security Protocol (see 7.57.3.2)
Count	Transfer Length (7:0) - See 7.57.3.4
LBA	<p>Bit Description</p> <p>27:24 Reserved</p> <p>23:8 SP Specific - Security Protocol Specific (see 7.57.3.3)</p> <p>7:0 Transfer Length (15:8) - See 7.57.3.4</p>
Device	<p>Bit Description</p> <p>7 Obsolete</p> <p>6 N/A</p> <p>5 Obsolete</p> <p>4 Transport Dependent - See 6.2.11</p> <p>3:0 Reserved</p>
Command	7:0 5Ch

7.57.3.2 Security Protocol

The Security Protocol field identifies which security protocol is being used. This determines the format of the SP Specific field and of the data that is transferred (see table 66). If the Security Protocol field is set to a reserved value, the device shall return command aborted.

Table 66 — TRUSTED RECEIVE Security Protocol field description

Value	Description
00h	Return security protocol information (see 7.57.6)
01h – 06h	Defined by TCG, see 7.57.6
07h – 1Fh	Reserved
20h	Reserved for T10
21h-EDh	Reserved
EEm	Defined by IEEE 1667
EFh	Reserved for T10
F0h – FFh	Vendor Specific.

The meaning of the SP Specific field is defined by each security protocol.

7.57.3.3 SP Specific

The SP Specific field provides Security Protocol field specific information. The meaning of these fields are defined by each security protocol.

7.57.3.4 Transfer Length

The Transfer Length is security protocol specific

7.57.4 Normal outputs

See table 111

7.57.5 Error outputs

The device shall return command aborted if an unrecoverable error occurred during the execution of the command. The amount of data transferred is indeterminate. A device may return command completion with the Error bit set to one if an Interface CRC error has occurred. See table 124.

7.57.6 Security Protocol 00h Description

7.57.6.1 Overview

The purpose of Security Protocol 00h is to return basic information about the device. A TRUSTED RECEIVE using Security Protocol field set to 00h is not linked to an earlier TRUSTED SEND command.

The Transfer Length field contains the number of 512-byte blocks of data to be transferred (e.g., one means 512 bytes, two means 1,024 bytes). A transfer length of zero is invalid.

The total data length shall conform to the Transfer Length field requirements (e.g., the total data length shall be a multiple of 512). Pad bytes shall be added as needed to meet this requirement. Pad bytes shall have a value of 00h.

If the length of the TRUSTED RECEIVE parameter data is greater than the Transfer Length, then the device shall return the TRUSTED RECEIVE parameter data truncated to the requested Transfer Length.

When the Security Protocol field is set to 00h, the SP Specific field is shown in table 67.

Table 67 — Security Protocol 00h - SP Specific field descriptions for Protocol 00h

SP Specific	Description	Support
0000h	Return supported security protocol list (see 7.57.6.2)	Mandatory
0001h	Return a certificate (see 7.57.6.3)	Mandatory
0002h-FFFFh	Reserved	

If the SP Specific field is set to a reserved value, the command shall be aborted.

Each time a TRUSTED RECEIVE command with Security Protocol field set to 00h is received, the device shall transfer the data starting with byte 0.

7.57.6.2 Supported security protocols list description

When the Security Protocol field is set to 00h, and SP Specific is set to 0000h in a TRUSTED RECEIVE command, the parameter data shall have the format shown in table 68.

Table 68 — TRUSTED RECEIVE parameter data for SP Specific=0000h

Bit Byte	7	6	5	4	3	2	1	0
0	Reserved							
1	Reserved							
2	Reserved							
3	Reserved							
4	Reserved							
5	Reserved							
6	List Length (M-7) bits (15:8)							
7	List Length (M-7) bits (7:0)							
8	Supported Security Protocol List							
M								
M+1								
511	Pad bytes (if any)							

The List Length field indicates the total length, in bytes, of the supported security protocol list.

The Supported Security Protocol List field shall contain a list of all supported Security Protocol field values. Each byte indicates a supported Security Protocol field value. The values shall be in ascending order starting with 00h.

The total data length shall be 512 bytes. Pad bytes are appended as needed to meet this requirement. Pad bytes shall have a value of 00h.

7.57.6.3 Certificate data description

7.57.6.3.1 Certificate overview

A certificate is either an X.509 Attribute Certificate or an X.509 Public Key Certificate depending on the capabilities of the device.

When the Security Protocol field of the TRUSTED RECEIVE command is set to 00h, and SP Specific is 0001h, the parameter data shall have the format shown in table 69.

Table 69 — TRUSTED RECEIVE parameter data for SP Specific=0001h

Bit Byte	7	6	5	4	3	2	1	0
0	Reserved							
1	Reserved							
2	(MSB)	CERTIFICATE LENGTH (M - 3)						(LSB)
3	X.509 certificate bytes							
4								
M								
M+1								
511	Pad bytes (if any)							

The CERTIFICATE LENGTH indicates the total length, in bytes, of the certificate(s). This length includes one or more certificates. If the device has no certificate to return, the certificate length is set to 0000h and only the 4 byte header and 508 pad bytes are returned.

The contents of the certificate fields are defined in 7.57.6.3.2 and 7.57.6.3.3.

The total data length shall conform to the Transfer Length field requirements.

7.57.6.3.2 Public Key certificate description

RFC 3280 defines the certificate syntax for certificates consistent with the X.509v3 Public Key Certificate Specification.

7.57.6.3.3 Attribute certificate description

RFC 3281 defines the certificate syntax for certificates consistent with the X.509v2 Attribute Certificate Specification.

7.58 TRUSTED RECEIVE DMA - 5Dh, DMA

7.58.1 Feature Set

This 28-bit command is mandatory for devices implementing the Trusted Computing feature set.

7.58.2 Description

See 7.57.2 for the description.

7.58.3 Inputs

Name	Description
Feature	Security Protocol (see 7.57.3.2)
Count	Transfer Length (7:0) - See 7.57.3.4
LBA	<p>Bit Description</p> <p>27:24 Reserved</p> <p>23:8 SP Specific - Security Protocol Specific (see 7.57.3.3)</p> <p>7:0 Transfer Length (15:8) - See 7.57.3.4</p>
Device	<p>Bit Description</p> <p>7 Obsolete</p> <p>6 N/A</p> <p>5 Obsolete</p> <p>4 Transport Dependent - See 6.2.11</p> <p>3:0 Reserved</p>
Command	7:0 5Dh

See 7.57.3 for a description of the inputs to this command

7.58.4 Normal Outputs

See 7.57.4 for the normal outputs of this command

7.58.5 Error Outputs

See 7.57.5 for the error outputs of this command.

7.59 TRUSTED SEND - 5Eh, PIO Data-Out

7.59.1 Feature Set

This 28-bit command is mandatory for devices implementing the Trusted Computing feature set.

7.59.2 Description

The TRUSTED SEND command sends data to the device. The data sent contains one or more Security Protocol specific instructions to be performed by the device. The host uses TRUSTED RECEIVE commands to retrieve any data resulting from these instructions.

Any association between a TRUSTED SEND command and a subsequent TRUSTED RECEIVE command depends on the protocol specified by the Security Protocol field (see table 70). Each protocol shall specify whether:

- a) the device shall complete the command without error as soon as the device determines the data has been received without error. An indication that the data has been processed is obtained by sending a TRUSTED RECEIVE command and receiving the results in the associated data transfer; or
- b) the device shall complete the command without error only after the data has been processed without error and an associated TRUSTED RECEIVE command is not required.

The completion of background activity resulting from a trusted command shall not return command aborted for any outstanding queued commands.

The format of the data and some of the parameters depends on the protocol specified by the Security Protocol field (see table 70).

7.59.3 Inputs

7.59.3.1 Overview

Name	Description
Feature	Security Protocol (see 7.59.3.2)
Count	Transfer Length (7:0) - See 7.59.3.4
LBA	<p>Bit Description</p> <p>27:24 Reserved</p> <p>23:8 SP Specific - Security Protocol Specific (see 7.59.3.3)</p> <p>7:0 Transfer Length (15:8) - See 7.59.3.4</p>
Device	<p>Bit Description</p> <p>7 Obsolete</p> <p>6 N/A</p> <p>5 Obsolete</p> <p>4 Transport Dependent - See 6.2.11</p> <p>3:0 Reserved</p>
Command	7:0 5Eh

7.59.3.2 Security Protocol

The Security Protocol field identifies which security protocol is being used. This determines the format of the parameters and of the data that is transferred (see table 70). If the Security Protocol field is set to a reserved value, the device shall return command aborted.

Table 70 — TRUSTED SEND - Security Protocol field description

Value	Description
00h	Reserved
01h – 06h	Defined by TCG
07h-1Fh	Reserved
20h	Reserved for T10
21h – EDh	Reserved
EEh	Defined by IEEE 1667
EFh	Reserved for T10
F0h – FFh	Vendor Specific

For Security Protocol values 01h-06h, see 7.59.6.

7.59.3.3 SP Specific

The meaning of the security protocol-specific field is defined by each security protocol.

7.59.3.4 Transfer Length

The Transfer Length is security protocol specific.

7.59.4 Normal outputs

See table 111

7.59.5 Error outputs

The device shall return command aborted if an unrecoverable error occurred during the execution of the command. The amount of data transferred is indeterminate. A device may return command completion with the Error bit set to one if an Interface CRC error has occurred. See table 124.

7.59.6 Parameters for Security Protocol 01h - 06h

The Transfer Length Field contains the number of 512-byte blocks of data to be transferred (e.g., one means 512 bytes, two means 1,024 bytes). Pad bytes are appended to the valid data as needed to meet this requirement. Pad bytes shall have a value of 00h. A transfer length of zero is invalid.

The SP Specific field provides Security Protocol field specific information. The meaning of this field is defined by each security protocol.

7.60 TRUSTED SEND DMA - 5Fh, DMA

7.60.1 Feature Set

This 28-bit command is mandatory for devices implementing the Trusted Computing feature set.

7.60.2 Description

See 7.59.2 for the description.

7.60.3 Inputs

Name	Description
Feature	Security Protocol (see 7.59.3.2)
Count	Transfer Length (7:0) - See 7.59.3.4
LBA	<p>Bit Description</p> <p>27:24 Reserved</p> <p>23:8 SP Specific - Security Protocol Specific (see 7.59.3.3)</p> <p>7:0 Transfer Length (15:8) - See 7.59.3.4</p>
Device	<p>Bit Description</p> <p>7 Obsolete</p> <p>6 N/A</p> <p>5 Obsolete</p> <p>4 Transport Dependent - See 6.2.11</p> <p>3:0 Reserved</p>
Command	7:0 5Fh

See 7.59.3 for a description of the inputs to this command

7.60.4 Normal Outputs

See 7.59.4 for the normal outputs of this command

7.60.5 Error Outputs

See 7.59.5 for the error outputs of this command.

7.61 WRITE BUFFER - E8h, PIO Data-Out

7.61.1 Feature Set

This 28-bit command is optional for devices that implement the General feature set.

7.61.2 Description

This command enables the host to write the contents of one 512-byte block of data to the device's buffer.

The READ BUFFER and WRITE BUFFER commands shall be synchronized within the device such that sequential WRITE BUFFER and READ BUFFER commands access the same bytes within the buffer.

7.61.3 Inputs

Name	Description
Feature	N/A
Count	N/A
LBA	N/A
Device	<p>Bit Description</p> <ul style="list-style-type: none"> 7 Obsolete 6 N/A 5 Obsolete 4 Transport Dependent - See 6.2.11 3:0 Reserved
Command	7:0 E8h

7.61.4 Normal Outputs

See table 99.

7.61.5 Error Outputs

A device may return command completion with the Error bit set to one if an Interface CRC error has occurred. See table 123.

7.62 WRITE DMA - CAh, DMA

7.62.1 Feature Set

This 28-bit command is mandatory for devices that implement the General feature set.

7.62.2 Description

The WRITE DMA command allows the host to write data using the DMA data transfer protocol.

7.62.3 Inputs

Name	Description
Feature	N/A
Count	The number of logical sectors to be transferred. A value of 00h indicates that 256 logical sectors are to be transferred
LBA	LBA of first logical sector to be transferred
Device	<p style="text-align: center;">Bit Description</p> <p style="text-align: center;">7 Obsolete</p> <p style="text-align: center;">6 Shall be set to one</p> <p style="text-align: center;">5 Obsolete</p> <p style="text-align: center;">4 Transport Dependent - See 6.2.11</p> <p style="text-align: center;">3:0 Reserved</p>
Command	7:0 CAh

7.62.4 Normal Outputs

See table 99.

7.62.5 Error Outputs

See table 151.

7.63 WRITE DMA EXT - 35h, DMA

7.63.1 Feature Set

This 48-bit command is mandatory for devices that implement the 48-bit Address feature set.

7.63.2 Description

The WRITE DMA EXT command allows the host to write data using the DMA data transfer protocol.

7.63.3 Inputs

Name	Description
Feature	Reserved
Count	The number of logical sectors to be transferred. A value of 0000h indicates that 65,536 logical sectors are to be transferred
LBA	LBA of first logical sector to be transferred
Device	<p>Bit Description</p> <ul style="list-style-type: none"> 7 Obsolete 6 Shall be set to one 5 Obsolete 4 Transport Dependent - See 6.2.11 3:0 Reserved
Command	7:0 35h

7.63.4 Normal Outputs

See table 111.

7.63.5 Error Outputs

See table 139.

7.64 WRITE DMA FUA EXT - 3Dh, DMA

7.64.1 Feature Set

This 48-bit command is mandatory for devices that implement the 48-bit Address feature set.

7.64.2 Description

The WRITE DMA FUA EXT command provides the same function as the WRITE DMA EXT command except that regardless of whether volatile and/or non-volatile write caching in the device is enabled or not, the user data shall be written to non-volatile media before command completion is reported.

7.64.3 Inputs

Name	Description
Feature	Reserved
Count	The number of logical sectors to be transferred. A value of 0000h indicates that 65,536 logical sectors are to be transferred
LBA	LBA of first logical sector to be transferred
Device	<p>Bit Description</p> <ul style="list-style-type: none"> 7 Obsolete 6 Shall be set to one 5 Obsolete 4 Transport Dependent - See 6.2.11 3:0 Reserved
Command	7:0 3Dh

7.64.4 Normal Outputs

See table 111.

7.64.5 Error Outputs

See table 139.

7.65 WRITE DMA QUEUED - CCh, DMA Queued

7.65.1 Feature Set

This 28-bit command is mandatory for devices that implement the TCQ feature set.

7.65.2 Description

This command executes in a similar manner to a WRITE DMA command. The device may perform a release or may process the data transfer without performing a release if the data is ready to transfer.

If the device performs a release, the host should reselect the device using the SERVICE command.

Once the data transfer is begun, the device shall not perform a release until the entire data transfer has been completed.

7.65.3 Inputs

Name	Description
Feature	The number of logical sectors to be transferred. A value of 00h indicates that 256 logical sectors are to be transferred
Count	<p>Bit Description</p> <p>7:3 Tag - See 6.4.5</p> <p>2:0 N/A</p>
LBA	LBA of first logical sector to be transferred
Device	<p>Bit Description</p> <p>7 Obsolete</p> <p>6 Shall be set to one</p> <p>5 Obsolete</p> <p>4 Transport Dependent - See 6.2.11</p> <p>3:0 Reserved</p>
Command	7:0 CCh

7.65.4 Normal Outputs

7.65.4.1 Data transmission

Data transfer may occur after receipt of the command or may occur after the receipt of a SERVICE command. When the device is ready to transfer data requested by a data transfer command, the device sets the field content described in table 107. See table 107 for the layout of the Normal Outputs data structure. The Release bit shall be cleared to zero, the Input/Output bit shall be cleared to zero, and the Command/Data bit shall be cleared to zero.

7.65.4.2 Release

If the device performs a release before transferring data for this command, the field content upon performing a release shall be as shown in table 107, and the Release bit shall be set to one, the Input/Output bit shall be cleared to zero, and the Command/Data bit shall be cleared to zero.

7.65.4.3 Service request

When the device is ready to transfer data or complete a command after the command has performed a release, the device shall set the Service bit to one and not change the state of any other status field bit. When the

SERVICE command is received, the device shall set outputs as described in 7.65.4.1, 7.65.4.4, or 7.64.5 depending on the service the device requires.

7.65.4.4 Command completion

When the transfer of all requested data has occurred without error, see table 107 for Normal Outputs, the Release bit shall be cleared to zero, the Input/Output bit shall be set to one, and the Command/Data bit shall be set to one.

7.65.5 Error Outputs

The Interrupt Reason field contains the Tag for this command if the device supports the TCQ feature set. The device shall return command aborted if the device supports the TCQ feature set and the Tag is invalid. If an unrecoverable error occurs while the device is processing this command, then the device shall return command aborted and the LBA field set to the LBA of the logical sector where the first unrecoverable error occurred. If write cache is enabled, then unrecoverable errors may not be reported, as they may occur after command completion. If a queue existed, the unrecoverable error shall cause the queue to abort. See table 152.

7.66 WRITE DMA QUEUED EXT - 36h, DMA Queued

7.66.1 Feature Set

This 48-bit command is mandatory for devices that implement both the TCQ feature set and 48-bit Address feature set.

7.66.2 Description

This command executes in a similar manner to a WRITE DMA EXT command. The device may perform a release of the bus or may process the data transfer without performing a release if the data is ready to transfer.

If the device performs a release, the host should reselect the device using the SERVICE command.

Once the data transfer is begun, the device shall not perform a release until the entire data transfer has been completed.

7.66.3 Inputs

Name	Description
Feature	The number of logical sectors to be transferred. A value of 0000h indicates that 65,536 logical sectors are to be transferred
Count	<p>Bit Description</p> 15:8 Reserved 7:3 Tag - See 6.4.5 2:0 Reserved
LBA	LBA of first logical sector to be transferred
Device	<p>Bit Description</p> 7 Obsolete 6 Shall be set to one 5 Obsolete 4 Transport Dependent - See 6.2.11 3:0 Reserved
Command	7:0 36h

7.66.4 Normal Outputs

7.66.4.1 Data transmission

Data transfer may occur after receipt of the command or may occur after the receipt of a SERVICE command. When the device is ready to transfer data requested by a data transfer command, the device sets the field content as described in table 113 to initiate the data transfer. See table 113 for the layout of the Normal Outputs data structure. The Release, Input/Output, and Command/Data bits shall be cleared to zero.

7.66.4.2 Release

If the device performs a release before transferring data for this command, the field content upon performing a release shall be as shown in table 113, and the Release bit shall be set to one, and the Input/Output and Command/Data bits shall be cleared to zero.

7.66.4.3 Service request

When the device is ready to transfer data or complete a command after the command has performed a release, the device shall set the Service bit to one and not change the state of any other status field bit. When the SERVICE command is received, the device shall set outputs as described in 7.66.4.1, 7.66.4.4, or 7.66.5 depending on the service the device requires.

7.66.4.4 Command completion

When the transfer of all requested data has occurred without error, the field content shall be as described in table 113. See table 113 for the layout of the Normal Outputs data structure. The Release bit shall be cleared to zero, the Input/Output and Command/Data bits shall be set to one.

7.66.5 Error Outputs

The Interrupt Reason field contains the Tag for this command if the device supports the TCQ feature set. The device shall return command aborted if the device supports the TCQ feature set and the Tag is invalid. If an unrecoverable error occurs while the device is processing this command, then the device shall return command aborted with the LBA field set to the LBA of the logical sector where the first unrecoverable error occurred. If write cache is enabled, then unrecoverable errors may not be reported as they may occur after command completion. If a queue existed, the unrecoverable error shall cause the queue to abort. If the LBA plus Count is larger than the value reported in IDENTIFY DEVICE data words 100-103, and if ID Not Found is cleared to zero, then the Abort bit shall be set to one. See table 152.

7.67 WRITE DMA QUEUED FUA EXT - 3Eh, DMA Queued

7.67.1 Feature Set

This 48-bit command is mandatory for devices that implement both the TCQ feature set and 48-bit Address feature set.

7.67.2 Description

This command executes in a similar manner to a WRITE DMA FUA EXT command. The device may perform a release or may process the data transfer without performing a release if the data is ready to transfer.

If the device performs a release, the host should reselect the device using the SERVICE command.

Once the data transfer is begun, the device shall not perform a release until the entire data transfer has been completed.

The WRITE DMA QUEUED FUA EXT command provides the same function as the WRITE DMA EXT command except that regardless of whether volatile and/or non-volatile write caching in the device is enabled or not, the user data shall be written to non-volatile media before command completion is reported.

7.67.3 Inputs

Name	Description
Feature	The number of logical sectors to be transferred. A value of 0000h indicates that 65,536 logical sectors are to be transferred
Count	<p>Bit Description</p> <p>15:8 Reserved</p> <p>7:3 Tag - See 6.4.5</p> <p>2:0 Reserved</p>
LBA	LBA of first logical sector to be transferred
Device	<p>Bit Description</p> <p>7 Obsolete</p> <p>6 Shall be set to one</p> <p>5 Obsolete</p> <p>4 Transport Dependent - See 6.2.11</p> <p>3:0 Reserved</p>
Command	7:0 3Eh

7.67.4 Normal Outputs

See 7.66.4.

7.67.5 Error Outputs

See 7.66.5.

7.68 WRITE FPDMA QUEUED - 61h, DMA Queued

7.68.1 Feature Set

This 48-bit command is mandatory for devices implementing the NCQ feature set.

7.68.2 Description

This command causes data to be transferred from the host to the device.

7.68.3 Inputs

7.68.3.1 Overview

Name	Description
Feature	The number of logical sectors to be transferred. A value of 0000h indicates that 65,536 logical sectors are to be transferred
Count	<p>Bit Description</p> <p>15:8 Reserved</p> <p>7:3 NCQ Tag - See 6.5.2</p> <p>2:0 Reserved</p>
LBA	LBA of first logical sector to be transferred
Device	<p>Bit Description</p> <p>7 FUA - See 7.68.3.2</p> <p>6 Shall be set to one</p> <p>5 Reserved</p> <p>4 Shall be set to zero</p> <p>3:0 Reserved</p>
Command	7:0 61h

7.68.3.2 Forced Unit Access (FUA)

When the FUA bit is set to one regardless of whether volatile and/or non-volatile write caching in the device is enabled or not, the user data shall be written to non-volatile media before command completion is reported. When the FUA bit is cleared to zero the device may return command completion before the data is written to the non-volatile media.

7.68.4 Command Acceptance Outputs

See table 116.

7.68.5 Normal Outputs

See table 117.

7.68.6 Error Outputs

If the Error bit is set to one, then the device aborted the command due to LBA out of range, a duplicate tag number, an invalid tag number, or an Interface CRC error, see table 157 for more information.

Errors that occur during the processing of this command are reported by returning a transport dependent indicator with additional information available in the NCQ Command Error log, see table 158 for more information.

7.69 WRITE LOG EXT - 3Fh, PIO Data-Out

7.69.1 Feature Set

This 48-bit command is mandatory for devices that implement the General Purpose Logging feature set.

7.69.2 Description

This command writes a specified number of 512 byte blocks of data to the specified log. See table A.2 for the list of logs.

7.69.3 Inputs

7.69.3.1 Overview

Name	Description
Feature	Reserved
Count	Log Page Count - See 7.69.3.2
LBA	<p>Bit Description</p> <p>47:40 Reserved</p> <p>39:32 Page # (15:8) - See 7.69.3.3</p> <p>31:16 Reserved</p> <p>15:8 Page # (7:0) - See 7.69.3.3</p> <p>7:0 Log Address - Specifies the log to be written as described in table A.2. See 7.53.9.3.2</p>
Device	<p>Bit Description</p> <p>7 Obsolete</p> <p>6 N/A</p> <p>5 Obsolete</p> <p>4 Transport Dependent - See 6.2.11</p> <p>3:0 Reserved</p>
Command	7:0 3Fh

7.69.3.2 Log Page Count

Specifies the number of log pages that shall be written to the specified log. If the number is zero, or the number is greater than the number indicated in the GPL Directory (see table A.3), the device shall return command aborted.

7.69.3.3 Page

Specifies the first page number to be written to the specified log address. Pages are numbered starting with zero.

7.69.4 Normal Outputs

See table 111.

7.69.5 Error Outputs

A device shall return command aborted for the command if:

- a) the Count field is cleared to zero;

- b) the feature set associated with the log specified in the LBA field (7:0) is not supported or not enabled;
- c) the values in the Feature, Count, or LBA (47:8) fields are invalid;
- d) the host attempts to write to a read only log address; or
- e) the value in the Page # field plus the the value in the Log Page Count field is larger than the log size reported in the GPL Directory.

If the log data is not available or a data structure checksum error occurred, then the device shall return command completion for the command with the ID Not Found bit set to one.

A device may return command completion with the Error bit set to one if an Interface CRC error has occurred.

See table 137.

7.70 WRITE LOG DMA EXT - 57h, DMA

7.70.1 Feature Set

This 48-bit command is optional for devices implementing the General Purpose Logging feature set.

7.70.2 Description

See 7.69.2.

7.70.3 Inputs

See 7.69.3.

7.70.4 Normal Outputs

See 7.69.4.

7.70.5 Error Outputs

See 7.69.5.

7.71 WRITE MULTIPLE - C5h, PIO Data-Out

7.71.1 Feature Set

This 28-bit command is mandatory for devices that implement the General feature set.

7.71.2 Description

This command writes the number of logical sectors specified in the Count field.

The number of logical sectors per DRQ data block is defined by the content of IDENTIFY DEVICE data word 59.

If the number of requested logical sectors is not evenly divisible by the DRQ data block count, as many full blocks as possible are transferred, followed by a final, partial block transfer. The partial block transfer is for n logical sectors, where:

$$n = \text{Remainder}(\text{Count} / \text{DRQ data block count}).$$

Device errors encountered during WRITE MULTIPLE commands are posted after the attempted device write of the DRQ data block or partial DRQ data block is transferred. The command ends with the logical sector in error, even if the error was in the middle of a DRQ data block. Subsequent DRQ data blocks are not transferred in the event of an error.

The contents of the Command Structure following the transfer of a DRQ data block that had a logical sector in error are undefined. The host should retry the transfer as individual requests to obtain valid error information.

If IDENTIFY DEVICE data word 59 bit 8 is cleared to zero or IDENTIFY DEVICE data word 59 bits (7:0) are set to zero, and a WRITE MULTIPLE command is received by the device, and no successful SET MULTIPLE MODE command has been processed by the device, the device shall return command aborted. A successful SET MULTIPLE MODE command should precede a WRITE MULTIPLE command.

7.71.3 Inputs

Name	Description
Feature	N/A
Count	The number of logical sectors to be transferred. A value of 00h indicates that 256 logical sectors are to be transferred
LBA	LBA of first logical sector to be transferred
Device	<p>Bit Description</p> <ul style="list-style-type: none"> 7 Obsolete 6 Shall be set to one 5 Obsolete 4 Transport Dependent - See 6.2.11 3:0 Reserved
Command	7:0 C5h

7.71.4 Normal Outputs

See table 99.

7.71.5 Error Outputs

If an unrecoverable error occurs while the device is processing this command, then the device shall return command completion with the Error bit set to one and the LBA field set to the LBA of the logical sector where the first unrecoverable error occurred. The amount of data transferred is indeterminate. A device may return command completion with the Error bit set to one if an Interface CRC error has occurred. See table 150.

7.72 WRITE MULTIPLE EXT - 39h, PIO Data-Out

7.72.1 Feature Set

This 48-bit command is mandatory for devices that implement the 48-bit Address feature set.

7.72.2 Description

This command writes the number of logical sectors specified in the Count field.

The number of logical sectors per DRQ data block is defined by the content of IDENTIFY DEVICE data word 59.

If the number of requested logical sectors is not evenly divisible by the DRQ data block count, as many full blocks as possible are transferred, followed by a final, partial block transfer. The partial block transfer is for n logical sectors, where:

$$n = \text{Remainder}(\text{Count} / \text{DRQ data block count}).$$

Device errors encountered during WRITE MULTIPLE EXT commands are posted after the attempted device write of the DRQ data block or partial DRQ data block is transferred. The command ends with the logical sector in error, even if the error was in the middle of a DRQ data block. Subsequent DRQ data blocks are not transferred in the event of an error.

The contents of the Command Structure following the transfer of a data block that had a logical sector in error are undefined. The host should retry the transfer as individual requests to obtain valid error information.

If IDENTIFY DEVICE data word 59 bit 8 is cleared to zero or IDENTIFY DEVICE data word 59 bits (7:0) are set to zero, and a WRITE MULTIPLE EXT command is received by the device, and no successful SET MULTIPLE MODE command has been processed by the device, the device shall return command aborted. A successful SET MULTIPLE MODE command should precede a WRITE MULTIPLE EXT command.

7.72.3 Inputs

Name	Description
Feature	Reserved
Count	The number of logical sectors to be transferred. A value of 0000h indicates that 65,536 logical sectors are to be transferred
LBA	LBA of first logical sector to be transferred
Device	<p>Bit Description</p> <ul style="list-style-type: none"> 7 Obsolete 6 Shall be set to one 5 Obsolete 4 Transport Dependent - See 6.2.11 3:0 Reserved
Command	7:0 39h

7.72.4 Normal Outputs

See table 111.

7.72.5 Error Outputs

If an unrecoverable error occurs while the device is processing this command, then the device shall return command completion with the Error bit set to one and the LBA field set to the LBA of the logical sector where the first unrecoverable error occurred. The amount of data transferred is indeterminate. A device may return command completion with the Error bit set to one if an Interface CRC error has occurred. See table 139.

7.73 WRITE MULTIPLE FUA EXT - CEh, PIO Data-Out

7.73.1 Feature Set

This 48-bit command is mandatory for devices that implement the 48-bit Address feature set.

7.73.2 Description

The WRITE MULTIPLE FUA EXT command provides the same functionality as the WRITE MULTIPLE EXT command except that regardless of whether volatile and/or non-volatile write caching in the device is enabled or not, the user data shall be written to non-volatile media before command completion is reported.

If IDENTIFY DEVICE data word 59 bit 8 is cleared to zero or IDENTIFY DEVICE data word 59 bits (7:0) are set to zero, and a WRITE MULTIPLE FUA EXT command is received by the device, and no successful SET MULTIPLE MODE command has been processed by the device, the device shall return command aborted. A successful SET MULTIPLE MODE command should precede a WRITE MULTIPLE FUA EXT command.

7.73.3 Inputs

Name	Description
Feature	Reserved
Count	The number of logical sectors to be transferred. A value of 0000h indicates that 65,536 logical sectors are to be transferred
LBA	LBA of first logical sector to be transferred
Device	<p>Bit Description</p> <ul style="list-style-type: none"> 7 Obsolete 6 Shall be set to one 5 Obsolete 4 Transport Dependent - See 6.2.11 3:0 Reserved
Command	7:0 CEh

7.73.4 Normal Outputs

See table 111.

7.73.5 Error Outputs

If an unrecoverable error occurs while the device is processing this command, then the device shall return command completion with the Error bit set to one and the LBA field set to the LBA of the logical sector where the first unrecoverable error occurred. The amount of data transferred is indeterminate. A device may return command completion with the Error bit set to one if an Interface CRC error has occurred. See table 139.

7.74 WRITE SECTOR(S) - 30h, PIO Data-Out

7.74.1 Feature Set

This 28-bit command is mandatory for devices that implement the General feature set.

7.74.2 Description

This command writes from 1 to 256 logical sectors as specified in the Count field.

7.74.3 Inputs

Name	Description
Feature	N/A
Count	The number of logical sectors to be transferred. A value of 00h indicates that 256 logical sectors are to be transferred
LBA	LBA of first logical sector to be transferred
Device	<p>Bit Description</p> <ul style="list-style-type: none"> 7 Obsolete 6 Shall be set to one 5 Obsolete 4 Transport Dependent - See 6.2.11 3:0 Reserved
Command	7:0 30h

7.74.4 Normal Outputs

See table 99.

7.74.5 Error Outputs

If an unrecoverable error occurs while the device is processing this command, then the device shall return command completion with the Error bit set to one and the LBA field set to the LBA of the logical sector where the first unrecoverable error occurred. The amount of data transferred is indeterminate. A device may return command completion with the Error bit set to one if an Interface CRC error has occurred. See table 150.

7.75 WRITE SECTOR(S) EXT - 34h, PIO Data-Out

7.75.1 Feature Set

This 48-bit command is mandatory for devices that implement the 48-bit Address feature set.

7.75.2 Description

This command writes from 1 to 65,536 logical sectors as specified in the Count field.

7.75.3 Inputs

Name	Description
Feature	Reserved
Count	The number of logical sectors to be transferred. A value of 0000h indicates that 65,536 logical sectors are to be transferred
LBA	LBA of first logical sector to be transferred
Device	<p>Bit Description</p> <ul style="list-style-type: none"> 7 Obsolete 6 Shall be set to one 5 Obsolete 4 Transport Dependent - See 6.2.11 3:0 Reserved
Command	7:0 34h

7.75.4 Normal Outputs

See table 111.

7.75.5 Error Outputs

If an unrecoverable error occurs while the device is processing this command, then the device shall return command completion with the Error bit set to one and the LBA field set to the LBA of the logical sector where the first unrecoverable error occurred. The amount of data transferred is indeterminate. A device may return command completion with the Error bit set to one if an Interface CRC error has occurred. See table 139.

7.76 WRITE STREAM DMA EXT - 3Ah, DMA

7.76.1 Feature Set

This 48-bit command is mandatory for devices that implement the Streaming feature set.

7.76.2 Description

The WRITE STREAM DMA EXT command provides a method for a host to write data within an allotted time. This command allows for the host to specify that additional actions are to be performed by the device prior to the completion of the command.

7.76.3 Inputs

7.76.3.1 Inputs overview

Name	Description
Feature	<p>Bit Description</p> <p>15:8 Command Completion Time Limit (CCTL) - See 7.37.3.2.</p> <p>7 Obsolete</p> <p>6 Write Continuous (WC) - See 7.76.3.2</p> <p>5 Flush - See 7.76.3.3</p> <p>4 Obsolete</p> <p>3 Reserved</p> <p>2:0 Stream ID – See 7.76.3.4</p>
Count	The number of logical sectors to be transferred. A value of 0000h indicates that 65,536 logical sectors are to be transferred
LBA	LBA of first logical sector to be transferred
Device	<p>Bit Description</p> <p>7 Obsolete</p> <p>6 Shall be set to one</p> <p>5 Obsolete</p> <p>4 Transport Dependent - See 6.2.11</p> <p>3:0 Reserved</p>
Command	7:0 3Ah

7.76.3.2 Write Continuous (WC)

WC specifies whether the Write Continuous mode is enabled or disabled.

If WC is set to one, then:

- a) the device shall not stop processing the command due to errors;
- b) if an error occurs during data transfer or while writing data to media before command completion or before the amount of time allowed for command completion based on the setting of CCTL (see 7.37.3.2) or Default CCTL (see 7.9.3) is reached, then the device:
 - 1) shall continue to transfer the amount of data requested;
 - 2) may continue writing data to the media;
 - 3) shall report command completion after all data for the command has been transferred; and
 - 4) shall save the error information in the Write Streaming Error log; or

- c) if the amount of time allowed for command completion based on the setting of CCTL (see 7.37.3.2) or Default CCTL (see 7.9.3) is reached, then the device:
 - 1) shall stop processing the command;
 - 2) shall report command completion;
 - 3) shall set the Command Completion Time Out bit in the Write Streaming Error log to one; and
 - 4) may continue writing data to the media.

If WC is cleared to zero and an error occurs, then the device:

- a) shall stop processing the command and report command completion; and
- b) may continue writing data to the media.

7.76.3.3 Flush

If Flush is set to one, Default CCTL is cleared to zero, and CCTL is cleared to zero, then the device shall write all data for the specified stream to the media before command completion is reported.

If Flush is set to one and Default CCTL was not cleared to zero in the most recent CONFIGURE STREAM command (see 7.9) for the Stream ID, then the device shall report command completion within the time specified by Default CCTL (see 7.9.3.4).

If Flush is set to one and CCTL is not cleared to zero, then the device shall report command completion within $(\text{CCTL} * (\text{IDENTIFY DEVICE data words 98-99}) \text{ microseconds})$.

If Flush is set to one and either Default CCTL was not cleared to zero in the most recent CONFIGURE STREAM command (see 7.9) for the Stream ID, or CCTL is not cleared to zero, then the device:

- a) shall measure the time before reporting command completion from command acceptance;
- b) shall set the Command Completion Time Out to one if all of the data for the command has been received by the device, but the device has not yet written all of the data to its media; and
- c) should continue writing data to its media after reporting command completion.

7.76.3.4 Stream ID

Stream ID specifies the stream to be written. The device shall operate according to the parameters specified by the most recent successful CONFIGURE STREAM command specifying this Stream ID. Any write to the device media or internal device buffer management as a result of the Stream ID is vendor specific.

7.76.4 Normal Outputs

See table 103 for the definition of Normal Outputs.

7.76.5 Error Outputs

If:

- a) The WC bit was set to one in the command, and
- b) the device is able to accept the amount of data requested for the command (e.g., an error occurred while writing to the media);

then the device shall set the Stream Error bit to one and clear the Error bit to zero.

If:

- a) The WC bit was set to one in the command, and
- b) the device is not able to return the amount of data requested for the command (e.g., an Interface CRC error shall be reported at command completion);

then the device shall clear the Stream Error bit to zero and set the Error bit to one.

If:

- a) The WC bit was cleared to zero in the command;
- b) The CCTL bit was not cleared to zero in the command, or CCTL was cleared to zero in the command and Default CCTL specified in the most recent CONFIGURE STREAM command (see 7.9) for the Stream ID was not cleared to zero; and

- c) the time specified for command completion by CCTL (see 7.37.3.2) or Default CCTL (see 7.9.3) has been reached;

then the device shall clear the Stream Error bit to zero, set the Error bit to one, and set the Abort bit to one whether or not all data has been flushed to media.

If:

- a) The WC bit was cleared to zero in the command;
- b) CCTL was cleared to zero in the command; and
- c) Default CCTL specified in the most recent CONFIGURE STREAM command (see 7.9) for the Stream ID was cleared to zero;

then the device shall clear the Stream Error bit to zero, set the Error bit to one, and set The Interface CRC, ID Not Found, and/or Abort bits to one (i.e., indicating the error type).

A device may return command completion with the Error bit set to one if an Interface CRC error has occurred. See table 140.

7.77 WRITE STREAM EXT - 3Bh, PIO Data-Out

7.77.1 Feature Set

This 48-bit command is mandatory for devices that implement the Streaming feature set.

7.77.2 Description

See 7.76.2 for the description of this command.

7.77.3 Inputs

See 7.76.3 for the inputs to this command.

7.77.4 Normal Outputs

See 7.76.4 for Normal Outputs.

7.77.5 Error Outputs

See 7.76.5 for Error Outputs.

7.78 WRITE UNCORRECTABLE EXT - 45h, Non-Data

7.78.1 Feature Set

This 48-bit command is optional for devices implementing the General feature set.

7.78.2 Description

The WRITE UNCORRECTABLE EXT command is used to cause the device to report an uncorrectable error when the specified logical sector is subsequently read. If the logical sector is part of a larger physical sector, then all the logical sectors within the physical sector may report uncorrectable errors.

When the Feature field (7:0) contains a value of 55h the WRITE UNCORRECTABLE EXT command shall cause the device to indicate a failure when reads to any of the sectors that are contained in the physical block of the specified sector are performed. These sectors are referred to as pseudo uncorrectable sectors. Whenever a pseudo uncorrectable sector is accessed via a read command the device shall perform normal error recovery to the fullest extent until:

- a) the error recovery process is completed then set the Uncorrectable Error and Error bits; or
- b) a command time-out that applies to error recovery control occurs before error recovery is completed and an error is reported as a result of the command time-out (see 8.3.4).

Sectors that have been made pseudo uncorrectable when read back shall be treated in the same manner as an Uncorrectable Error, including error logging and SMART.

When the Feature field (7:0) contains a value of AAh the WRITE UNCORRECTABLE EXT command shall cause the device to flag the specified sector as flagged uncorrectable. Flagging a logical sector as uncorrectable shall cause the device to indicate a failure when reads to the specified sector are performed. Whenever a flagged uncorrectable sector is accessed via a read command the device shall set the Uncorrectable Error and Error bits to one to indicate the sector is bad. Reading of flagged sectors should not be logged by the device as an error or by SMART.

When the device processes a read command, it shall set the Uncorrectable Error bit to one and the Error bit to one when a pseudo uncorrectable or flagged uncorrectable sector is read. If the host writes to a pseudo uncorrectable or flagged uncorrectable sector, the device shall attempt to write the data to the sector. The write shall clear the uncorrectable status of the sector and should verify that the sector may now be read without error.

The pseudo uncorrectable or flagged uncorrectable status of a logical sector shall remain set during the processing of all power and reset events. If the device is unable to process a WRITE UNCORRECTABLE EXT command for any reason the device shall return command aborted.

7.78.3 Inputs

Name	Description
Feature	<p>Bit Description</p> <p>15:8 Reserved</p> <p>7:0 Uncorrectable options</p> <p>Value Description</p> <p>00h-54h Reserved</p> <p>55h Create a pseudo-uncorrectable error with logging</p> <p>56h-59h Reserved</p> <p>5Ah Vendor specific</p> <p>5Bh-A4h Reserved</p> <p>A5h Vendor Specific</p> <p>A6h-A9h Reserved</p> <p>AAh Create a flagged error without logging</p> <p>ABh-FFh Reserved</p>
Count	The number of logical sectors to be marked. A value of 0000h indicates that 65,536 logical sectors are to be marked
LBA	LBA of first logical sector to be marked
Device	<p>Bit Description</p> <p>7 Obsolete</p> <p>6 Shall be set to one</p> <p>5 Obsolete</p> <p>4 Transport Dependent - See 6.2.11</p> <p>3:0 Reserved</p>
Command	7:0 45h

7.78.4 Normal Outputs

See table 99.

7.78.5 Error Outputs

See table 122.

8 SCT Command Transport

8.1 Introduction

8.1.1 Overview

The SCT Command Transport provides a method for a host to send commands and data to a device and for a device to send data and status to a host using logs. Log Address E0h (e.g., SCT Command/Status) is used to issue commands and return status. Log Address E1h (e.g., SCT Data Transfer) is used to transport data.

The following methods are used to access the logs defined for the SCT Command Transport:

- a) using SMART READ LOG and SMART WRITE LOG commands; and
- b) using READ LOG (DMA) EXT and WRITE LOG (DMA) EXT commands.

These sets of commands access the same logs and provide the same capabilities. The two methods are also used in the same way: a command is issued, data is transferred, if necessary, and status may be retrieved multiple times if desired.

If the SMART feature set (see 4.21) is supported and not enabled, then a device that implements this feature set shall support SMART READ LOG and SMART WRITE LOG commands to the SCT Command/Status log and the SCT Data Transfer log.

Sending a key 512-byte block of data (i.e., key data block) to the SCT Command/Status log starts the command process. The key data block specifies Action and Function Codes along with the parameters that are required to perform the action. The SCT command response, either error or command, is the same for both methods of issuing commands.

SCT commands are processed like other ATA commands, therefore they take precedence over any background function the device may be performing when the SCT command is issued (i.e., a function initiated by a SMART EXECUTE OFFLINE IMMEDIATE command). Some SCT commands indicate command completion and return status while the SCT command is still executing.

A device supporting the SCT Command Transport should report a length of one in the General Purpose Log Directory and the SMART Log Directory for the SCT Command/Status log and the SCT Data Transfer log. The length of the SCT Data Transfer log does not indicate the length of an SCT Command Transport data transfer. This differs from the requirement in this standard that the GPL Directory and the SMART Log Directory report the actual length of the specified log pages.

8.1.2 SCT command nesting and interspersing with standard commands

Standard ATA commands may be interspersed with some SCT commands, but SCT commands shall not be nested. If an SCT command has not completed processing and another SCT command is received by the device (i.e., the host writes the SCT command/status log), then the first SCT command shall be aborted and the new SCT command shall be processed. SCT commands that do not require a subsequent data transfer operation are not interspersed with any ATA commands or each other. SCT commands that do require data transfer, on the other hand, shall not be nested; that is, if the device receives another SCT command before all available data is transferred, then the device shall abort the current SCT operation and process the new SCT command without reporting an error. In most cases, however, ATA read/write commands may be inserted in between data transfers for SCT commands, that is, between complete log commands.

8.1.3 Resets

A device shall terminate processing an SCT command during the processing of a software reset, hardware reset, or power-on reset. This may result in partial command execution or data loss. There is no indication once the device becomes ready that the previous command was terminated.

A device shall clear the SCT Status Response fields (i.e., Extended Status Code, Action Code, and Function Code) during the processing of a power-on reset and a hardware reset. A device shall clear the Extended status code during processing of a software reset and the other content of the SCT Status Response fields shall not be affected by the device processing the reset.

8.2 Processing SCT commands

8.2.1 Processing SCT commands overview

There are four phases involved in processing of SCT commands. These phases are:

- 1) Capability identification (see 8.2.2);
- 2) Command transfer (see 8.2.3);
- 3) Data transfer (see 8.2.4); and
- 4) Status (see 8.2.5).

8.2.2 SCT capability identification

Capability Identification is performed by the host issuing an IDENTIFY DEVICE command to determine if the SCT Command Transport is enabled and which Action Codes are supported (see 7.16.7.71).

8.2.3 SCT command transfer

Transfer of an SCT command occurs when a 512-byte data packet is created by the host and written to the SCT Command/Status log. The 512-byte data packet contains a single command as defined in the SCT Command Transport.

Table 71 defines the SCT command format, contained in the input data of the SMART WRITE LOG command.

Table 71 — Fields to issue an SCT command using SMART WRITE LOG

Name	Description
Feature	D6h (i.e., SMART WRITE LOG)
Count	01h
LBA	<p>Bit Description</p> <p>27:24 N/A</p> <p>23:8 C24Fh</p> <p>7:0 E0h (i.e., SCT Command/Status log address)</p>
Device	<p>Bit Description</p> <p>7 Obsolete</p> <p>6 N/A</p> <p>5 Obsolete</p> <p>4 Transport Dependent - See 6.2.11</p> <p>3:0 Reserved</p>
Command	7:0 B0h

Table 72 defines the SCT command format, contained in the input data of the WRITE LOG (DMA) EXT command.

Table 72 — Fields to issue an SCT command using WRITE LOG (DMA) EXT

Name	Description
Feature	Reserved
Count	0001h
LBA	<p style="text-align: center;">Bit Description</p> 47:40 Reserved 39:32 00h 31:16 Reserved 15:8 00h 7:0 E0h (i.e., SCT Command/Status log address)
Device	<p style="text-align: center;">Bit Description</p> 7 Obsolete 6 N/A 5 Obsolete 4 Transport Dependent - See 6.2.11 3:0 Reserved
Command	7:0 3Fh (i.e., WRITE LOG EXT) 57h (i.e., WRITE LOG DMA EXT)

Table 73 defines how a device shall set the fields after successful completion of an SCT command.

Table 73 — Successful SCT command response

Name	Description
Error	00h
Count	SCT Command Dependent Data
LBA	SCT Command Dependent Data
Device	<p>Bit Description</p> <ul style="list-style-type: none"> 7 Obsolete 6 N/A 5 Obsolete 4 Transport Dependent - See 6.2.11 3:0 Reserved
Status	<p>Bit Description</p> <ul style="list-style-type: none"> 7:6 Transport Dependent - See 6.2.11. 5:1 N/A 0 Error - See 6.2.8

Table 74 defines how a device shall set the fields after an error occurred during processing of an SCT command.

Table 74 — SCT command error response

Name	Description
Error	<p>Bit Description</p> <p>7:5 N/A</p> <p>4 ID Not Found - See 6.3.6.</p> <p>3 N/A</p> <p>2 Abort - See 6.3.2.</p> <p>1 N/A</p> <p>0 Obsolete</p>
Count	Extended Status Code (7:0) (see table 75)
LBA	<p>Bit Description</p> <p>27:24 Reserved</p> <p>23:8 SCT Command dependent.</p> <p>7:0 Extended Status Code (15:8) (see table 75)</p>
Device	<p>Bit Description</p> <p>7 Obsolete</p> <p>6 N/A</p> <p>5 Obsolete</p> <p>4 Transport Dependent - See 6.2.11</p> <p>3:0 Reserved</p>
Status	<p>Bit Description</p> <p>7:6 Transport Dependent - See 6.2.11.</p> <p>5:1 N/A</p> <p>0 Error - See 6.2.8</p>

Table 75 — Extended Status codes

Extended Status Code	Description
0000h	Command complete without error
0001h	Invalid Function Code
0002h	Input LBA out of range
0003h	Request 512-byte data block count overflow. The number of data blocks requested to transfer (Count field) in the log command is larger than specified by the SCT command
0004h	Invalid Function code in Error Recovery command
0005h	Invalid Selection code in Error Recovery command
0006h	Host read command timer is less than minimum value
0007h	Host write command timer is less than minimum value
0008h	Background SCT command was aborted because of an interrupting host command
0009h	Background SCT command was terminated because of unrecoverable error
000Ah	Invalid Function code in SCT Read/Write Long command
000Bh	SCT data transfer command was issued without first issuing an SCT command
000Ch	Invalid Function code in SCT Feature Control command
000Dh	Invalid Feature code in SCT Feature Control command
000Eh	Invalid New State value in SCT Feature Control command
000Fh	Invalid Option Flags value in SCT Feature Control command
0010h	Invalid SCT Action code
0011h	Invalid Table ID (table not supported)
0012h	Command was aborted due to device security being locked
0013h	Invalid revision code in SCT data
0014h	Foreground SCT operation was terminated because of unrecoverable error
0015h	The most recent non-SCT command completed with an error due to the SCT Error Recovery Control Read Command Timer or SCT Error Recovery Control Write Command Timer expiring.
0016h-BEFFh	Reserved
BF00h-BFFFh	Reserved for Serial ATA
C000h-FFEFh	Vendor specific
FFF0h-FFFEh	Reserved
FFFFh	SCT command executing in background

8.2.4 SCT data transfer

Once an SCT command for a data transfer has been issued, status is checked and data is transferred using the SCT Data Transfer log. Up to 255 512-byte blocks of data may be transferred at a time. If the SCT command requires more than 255 blocks of data transfer and SMART READ LOG or SMART WRITE LOG commands are used to transfer the data, the data may be written or read in up to 255 data block increments. If GPL feature set commands are used to transfer data, up to 65,535 512-byte data blocks may be transferred by a single command. If more than 65,535 data blocks are required, then multiple GPL feature set commands may be

issued. Table 76 shows how to perform an SCT data transfer using a SMART READ LOG or SMART WRITE LOG command.

Table 76 — SCT data transfer using SMART READ LOG or SMART WRITE LOG

Name	Description
Feature	D6h (i.e., SMART WRITE LOG) D5h (i.e., SMART READ LOG)
Count	Number of 512-byte data blocks to transfer
LBA	<p style="text-align: center;">Bit Description</p> 27:24 N/A 23:8 C24Fh 7:0 E1h (i.e., SCT Data Transfer)
Device	<p style="text-align: center;">Bit Description</p> 7 Obsolete 6 N/A 5 Obsolete 4 Transport Dependent - See 6.2.11 3:0 Reserved
Command	7:0 B0h

Table 77 defines the fields for data transfer using a READ LOG (DMA) EXT or WRITE LOG (DMA) EXT command.

Table 77 — SCT data transfer using the GPL feature set

Name	Description
Feature	Reserved
Count	Number of 512-byte data blocks to transfer
LBA	<p>Bit Description</p> <p>47:40 Reserved</p> <p>39:32 00h</p> <p>31:16 Reserved</p> <p>15:8 00h</p> <p>7:0 E1h (i.e., SCT Data Transfer)</p>
Device	<p>Bit Description</p> <p>7 Obsolete</p> <p>6 N/A</p> <p>5 Obsolete</p> <p>4 Transport Dependent - See 6.2.11</p> <p>3:0 Reserved</p>
Command	<p>7:0 2Fh (i.e., READ LOG EXT)</p> <p>47h (i.e., READ LOG DMA EXT)</p> <p>3Fh (i.e., WRITE LOG EXT)</p> <p>57h (i.e., WRITE LOG DMA EXT)</p>

8.2.5 SCT status

Status for an SCT command may be read at any time by reading the SCT Command/Status log. If the command involves data transfer, the host should check status before data is transferred to ensure that the device is ready. The host should also check status when the command is complete to confirm that the data was transferred without error. When the command is complete, the host may check status a third time to determine if the command succeeded, failed, or partially succeeded.

Once an SCT command has been issued, status is reported in the ATA fields. This status indicates that the command was accepted or that an error occurred. This ATA status return does not indicate successful completion of the SCT actions, except Foreground LBA Segment Access commands that require the completion of the SCT action (i.e., LBA Segment Access with function code 0101h and 0102h). Some commands may take several minutes or even hours to process. In this case, the host determines execution progress by requesting SCT status. Some commands may require setup time before a device is ready to receive data. SCT status indicates when the device is ready to receive data.

Reading the SCT Command/Status log retrieves the status information. The SCT status may be acquired any time that the host is allowed to send a command to the device. This command shall not change the power state of the device, nor terminate any background activity, including any SCT command in progress. This means if the device is in the Standby or Idle state, then the log request shall succeed.

Table 78 defines shows how to get the SCT status using a SMART READ LOG command.

Table 78 — SCT status request using SMART READ LOG

Name	Description
Feature	D5h (i.e., SMART READ LOG)
Count	01h
LBA	<p style="text-align: center;">Bit Description</p> 27:24 N/A 23:8 C24Fh 7:0 E0h (i.e., SCT Command/Status log address)
Device	<p style="text-align: center;">Bit Description</p> 7 Obsolete 6 N/A 5 Obsolete 4 Transport Dependent - See 6.2.11 3:0 Reserved
Command	7:0 B0h

Table 79 defines the fields for retrieving status using a READ LOG (DMA) EXT command.

Table 79 — SCT status request using the GPL feature set

Name	Description
Feature	Reserved
Count	0001h
LBA	<p>Bit Description</p> <p>47:40 Reserved</p> <p>39:32 00h</p> <p>31:16 Reserved</p> <p>15:8 00h</p> <p>7:0 E0h (i.e., SCT Command/Status log address)</p>
Device	<p>Bit Description</p> <p>7 Obsolete</p> <p>6 N/A</p> <p>5 Obsolete</p> <p>4 Transport Dependent - See 6.2.11</p> <p>3:0 Reserved</p>
Command	<p>7:0 2Fh (i.e., READ LOG EXT)</p> <p>47h (i.e., READ LOG DMA EXT)</p>

Table 80 defines the format of the status response information that shall be set by the device in the SCT Command/Status log.

Table 80 — Format of SCT status response

Byte	Type	Field Name	Description
0-1	Word	Format Version	0003h - Status Response format version number.
2-3	Word	SCT Version	Manufacturer's vendor specific implementation version number
4-5	Word	SCT Spec.	Obsolete
6-9	DWord	Status Flags	<p>Bits (31:1) - Reserved</p> <p>Bit 0 - Segment Initialized Flag. If this bit is set to one, a SCT Write Same command to all logical blocks has completed without error. This bit shall be cleared to zero when any user LBA is written, even if write cache is enabled. This bit shall also be cleared to zero if the capacity of the device is changed via SET MAX ADDRESS, SET MAX ADDRESS EXT or DEVICE CONFIGURATION SET. This bit is preserved during the processing of all power and reset events.</p>

Table 80 — Format of SCT status response

Byte	Type	Field Name	Description
10	Byte	Device State	00h - Active waiting for a command 01h - Stand-by 02h - Sleep 03h - DST executing in background 04h - SMART Off-line Data Collection executing in background 05h - SCT command executing in background 06h-FFh - Reserved
11-13	Byte [3]	reserved	
14-15	Word	Extended Status Code	Status of last SCT command issued. FFFFh if SCT command executing in background (see table 75).
16-17	Word	Action Code	Action code of last SCT command issued. If the Extended Status Code is FFFFh this is the Action Code of the command that is currently executing
18-19	Word	Function Code	Function code of last SCT command issued. If the Extended Status Code is FFFFh this is the Function Code of the command that is currently executing
20-39	Byte [20]	reserved	
40-47	QWord	LBA	Current LBA of SCT command executing in background. If there is no command currently executing in the background, this field is undefined.
48-199	Byte [152]	reserved	
200	Byte	HDA Temp	Current device HDA temperature in degrees Celsius. This is a 2's complement integer. 80h indicates that this value is invalid.
201	Byte	Min Temp	Minimum HDA temperature in degrees Celsius seen this power cycle. This is a 2's complement integer. 80h indicates that this value is invalid.
202	Byte	Max Temp	Maximum HDA temperature in degrees Celsius seen this power cycle. This is a 2's complement integer. 80h indicates that this value is invalid.
203	Byte	Life Min Temp	Minimum HDA temperature in degrees Celsius seen for the life of the device. This is a 2's complement integer. 80h indicates that this value is invalid.
204	Byte	Life Max Temp	Maximum HDA temperature in degrees Celsius seen for the life of the device. This is a 2's complement integer. 80h indicates that this value is invalid.
205	Byte	reserved	
206-209	DWord	Over Limit Count	Number of temperature recording Intervals since the last power-on reset where the recorded temperature was greater than Max Op Limit. See table 95 for information about this Interval.
210-213	DWord	Under Limit Count	Number of temperature recording Intervals since the last power-on reset where the recorded temperature was less than Min Op Limit. See table 95 for information about this Interval.
214-479	Byte [266]	reserved	
480-511	Byte [32]	Vendor Specific	

8.3 SCT Command Set

8.3.1 Overview

An SCT command shall be 512 bytes long. While an SCT command is in progress a host may use an SCT status request to retrieve status information (e.g., to determine if a command is active or complete, the current LBA, or error information) about the current SCT command.

Table 81 defines the generic format of an SCT command written to the SCT Command/Status log.

Table 81 — SCT command format

Byte	Field	Words	Description
0-1	Action Code	1	This field specifies the command type and the type of data being accessed, or the action being performed. (See table 82 for definition of the Action Code field contents.)
2-3	Function Code	1	This field specifies the type of access and varies by command.
4-x	Parameter1	Depends on command	Depends on command
x+1 - y	Parameter2	Depends on command	Depends on command
...
	Total Words	256	

Table 82 — SCT Action Codes

Action Code	Description
0000h	Reserved
0001h	SCT Read/Write Long command
0002h	SCT Write Same command
0003h	SCT Error Recovery Control command
0004h	SCT Feature Control command
0005h	SCT Data Tables command
0006h	Vendor specific
0007h	Reserved for Serial ATA
0008h-BFFFh	Reserved
C000h-FFFFh	Vendor specific

8.3.2 SCT Read/Write Long command

The function performed by the SCT Read/Write Long command is based on the obsolete ATA READ LONG/WRITE LONG capability, and has been extended beyond 28-bit addressing.

When IDENTIFY DEVICE data word 106 bit 12 is cleared to zero, the SCT Read/Write Long command data format for both reads and writes is two log pages long. The first page contains the user data. The second page contains the error correction and detection bytes. The remainder of the second page should contain zeros. Once the SCT command has been issued and the status response indicates that the device is ready to transfer data, the SCT Data Transfer log should be read or written to transfer the data. SCT Read/Write Long commands cause a forced unit access to occur.

Table 83 defines the format of an SCT Read/Write Long command written to the SCT Command/Status log.

Table 83 — SCT Read/Write Long command

Word	Name	Value	Description
0	Action Code	0001h	Read or Write a sector with full ECC or CRC data
1	Function Code	0000h	Reserved
		0001h	Read Long function
		0002h	Write Long function
		0003h-FFFFh	Reserved
2-5	LBA	QWord	Logical sector to be read or written 63:48 Reserved 47:0 LBA to be read or written

Table 84 defines the format of the status response for an SCT Read/Write Long command.

Table 84 — SCT Read/Write Long command status response

Name	Description
Error	<p>Bit Description</p> <p>7:5 N/A</p> <p>4 ID Not Found - See 6.3.6.</p> <p>3 N/A</p> <p>2 Abort - See 6.3.2.</p> <p>1 N/A</p> <p>0 Obsolete</p>
Count	Number of ECC/CRC bytes (7:0)
LBA	<p>Bit Description</p> <p>27:24 Reserved</p> <p>23:8 Number of 512-byte data blocks requested (e.g., 0002h)</p> <p>7:0 Number of ECC/CRC bytes (15:8)</p>
Device	<p>Bit Description</p> <p>7 Obsolete</p> <p>6 N/A</p> <p>5 Obsolete</p> <p>4 Transport Dependent - See 6.2.11</p> <p>3:0 Reserved</p>
Status	<p>Bit Description</p> <p>7:6 Transport Dependent - See 6.2.11.</p> <p>5:1 N/A</p> <p>0 Error - See 6.2.8</p>

Table 85 defines the format of the data to be written to the SCT Data Transfer log for an SCT Read/Write Long command.

Table 85 — SCT Read/Write Long command Format

Field	Size	Description
First Block		
User Data	512 bytes	This is the data normally sent to or returned by a read or write command. This data may be encoded.
Second Block		
ECC/CRC Data	Vendor Specific	Error correction and detection bytes in vendor-specific format. The number of bytes is returned as status response data on both read and write operations.
Reserved	Remainder of block	All zeros

8.3.3 SCT Write Same command

The SCT Write Same command provides the ability for the host to specify that the device shall write a specific pattern to its media.

The SCT Write Same command shall cause the device to begin writing logical sectors from the first logical sector specified by the command in the Start field (see table 86) in incrementing order until the number of logical sectors specified by the command in the Count field (see table 86) have been written. If the Count field contains all zeros, then the device shall write all logical sectors beginning with the logical sector specified by the Start field through the last user LBA on the device. If the HPA feature set is implemented by and enabled on the device, then this feature set shall determine the last user LBA. This command shall not write over a hidden partition when hidden partitions are enabled using the HPA feature set. Automatic sector reassignment is permitted during the operation of this function.

If the Start field or the Start field plus the Count field specify an LBA greater than the last user LBA, then the device shall report an error and return command aborted. If the Start field and the Count field contain zero, then the device shall write the specified pattern to all user logical blocks on the device.

Any new command other than an SCT status request, including IDENTIFY DEVICE, received by the device while this command is in progress shall terminate the SCT Write Same command. The device shall process the new command.

While a background SCT Write Same command is in progress, the SCT status error code shall be set to FFFFh. If the command completes without error, then the SCT status error code shall be set to 0000h. If any error occurs during command processing, then the SCT status error code shall be set to a value less than FFFFh and greater than 0000h.

Once the key data block has been issued, if the Function Code was 0002h and the input data structure indicates that the device is ready to receive data, the SCT Data Transfer log should be written to transfer the data.

For the Foreground SCT Write Same command with function code 0101h the Command Completion Status of the write to the SCT Command/Status log shall indicate the success or failure of the SCT Write Same command. For the Foreground SCT Write Same command with function Code 0102h the Command Completion Status of the write to the SCT Data Transfer log shall indicate the success or failure of the SCT Write Same command. The Status and Error fields indicate the status/error values as defined in clause 6. In the case of an error an SCT Status Request may be made by reading the SCT Command/Status log to obtain a more detailed analysis of the error.

This command may change the Segment Initialized Flag. If the command writes all the user addressable sectors and completes without encountering an error or being aborted, then the Segment Initialized Flag (i.e., bit 0 of the Status Flags in the SCT status) shall be set to one. A write to any user addressable sector on the device, except one caused by another SCT Write Same command with the Start field and the Count field set to zero (i.e., an SCT Write Same command causing the device to write to all user logical blocks), shall cause the Segment Initialized Flag to be cleared. Reallocations as a result of reading data, either in the foreground or background, shall not clear the Device Zeroed flag.

Table 86 defines the format of a SCT Write Same command written to the SCT Command/Status log.

Table 86 — SCT Write Same command

Word	Name	Value	Description
0	Action Code	0002h	This action writes a pattern or 512-byte data block repeatedly to the media.
1	Function Code	0000h 0001h 0002h 0003h-0100h 0101h 0102h 0103h-FFFFh	Reserved Repeat write pattern Repeat write data block Reserved Repeat write pattern foreground Repeat write data block foreground Reserved
2-5	Start	QWord	First logical sector to write 63:48 Reserved 47:0 First LBA
6-9	Count	QWord	Number of logical sectors to fill
10-11	Pattern	DWord	If the Function Code is 0001h or 0101h, this field contains a 32-bit pattern that is written on the media starting at the location specified in words 2-5.

Table 87 defines the format of the status response for a SCT Write Same command.

Table 87 — SCT Write Same command status response

Name	Description
Error	<p>Bit Description</p> <p>7:5 N/A</p> <p>4 ID Not Found - See 6.3.6.</p> <p>3 N/A</p> <p>2 Abort - See 6.3.2.</p> <p>1 N/A</p> <p>0 Obsolete</p>
Count	Reserved
LBA	<p>Bit Description</p> <p>27:24 Reserved</p> <p>23:8 0000h – If FC=0001h or FC=0101h 0001h – If FC=0002h or FC=0102h</p> <p>7:0 Reserved</p>
Device	<p>Bit Description</p> <p>7 Obsolete</p> <p>6 N/A</p> <p>5 Obsolete</p> <p>4 Transport Dependent - See 6.2.11</p> <p>3:0 Reserved</p>
Status	<p>Bit Description</p> <p>7:6 Transport Dependent - See 6.2.11.</p> <p>5:1 N/A</p> <p>0 Error - See 6.2.8</p>

8.3.4 SCT Error Recovery Control command

The SCT Error Recovery Control command sets time limits for read and write error recovery. For commands that are not TCQ commands or NCQ commands, these timers apply to command completion at the host interface. For TCQ commands or NCQ commands where in-order data delivery is enabled, these timers begin counting when the device begins to process the command, not when the command is sent to the device. These timers do not apply to streaming commands or to queued commands when out-of-order data delivery is enabled.

The typical usage for this command is when a device has its write cache function enabled. With write cache enabled, the device may not be able to report an error on a write command. This is because the write command with which a device is experiencing difficulty is one for which the device has reported status (i.e., considered by the host to be complete). This leaves no recourse for the device other than to reallocate any sectors with which it is experiencing difficulty.

Table 88 defines the format of an SCT Error Recovery Control command written to the SCT Command/Status log.

Table 88 — SCT Error Recovery Control command

Word	Name	Value	Description
0	Action Code	0003h	Set the read and write error recovery time
1	Function Code	0000h	Reserved
		0001h	Set New Value
		0002h	Return Current Value
		0003h-FFFFh	Reserved
2	Selection Code	0000h	Reserved
		0001h	Read Command Timer
		0002h	Write Command Timer
		0003h-FFFFh	Reserved
3	Recovery Time Limit		If the Function Code is 0001h then this field contains the recovery time limit in 100 ms units (e.g., a value of 1 = 100 ms, 2 = 200 ms). The tolerance is vendor specific.

The Recovery Time Limit value for the Read Command Timer establishes an upper limit for the amount of time a device processes a read command. This limit is the amount of time the device shall process a read command in total. The minimum Recovery Time Limit value for an enabled Read Command Timer is one. Setting this value to zero shall disable the Read Command timer, allowing the device to perform all available error recovery procedures.

The device shall report command completion or stop processing the command and report an Uncorrectable Error (see 6.3.13) for the LBA that was causing error recovery to be invoked prior to Read Command Timer expiration. Extended status code 0015h should be returned in the SCT Status data if the read command timer expires. The LBA may be recoverable given more time for error recovery.

The Write Command Timer sets the upper limit for the amount of time a device processes a write command. The minimum value for the Write Command Timer is one. Setting this value to zero shall disable Write Command time-out, allowing the device to perform all available error recovery procedures without a time limit.

A large Write Command Timer value allows the device to use more available error recovery procedures for dealing with write errors. If the timer is about to expire, then the device should attempt to reallocate the data before the timer expires. Extended status code 0015h should be returned in the SCT Status data if the write command timer expires. If the device is unable to complete data reallocation before the timer expires then the device fails the command when the timer expires. When write cache is enabled the operation of the timer is vendor specific.

NOTE 26 — A host implementor should use the Write Command Timer with great caution as a very small timer value may cause a device to permanently reallocate good sectors as the result of temporary, external conditions (e.g., induced vibration).

The Extended status code shall persist until the next non-SCT Status request command is received by the device.

Read and Write Command Timer values are set to default values at power-on but may be altered by an SCT command at any time. A device shall not change these settings while processing a hardware reset or a software reset.

Table 89 defines the format of the status response for a SCT Error Recovery Control command.

Table 89 — SCT Error Recovery Control command status response

Name	Description
Error	<p>Bit Description</p> <p>7:5 N/A</p> <p>4 ID Not Found - See 6.3.6.</p> <p>3 N/A</p> <p>2 Abort - See 6.3.2.</p> <p>1 N/A</p> <p>0 Obsolete</p>
Count	If Function Code was 0002h, then this is the requested recovery limit (7:0); otherwise, this field is reserved.
LBA	<p>Bit Description</p> <p>27:8 Reserved</p> <p>7:0 If the Function Code was 0002h, then this is the requested recovery limit (15:8); otherwise, this field is reserved.</p>
Device	<p>Bit Description</p> <p>7 Obsolete</p> <p>6 N/A</p> <p>5 Obsolete</p> <p>4 Transport Dependent - See 6.2.11</p> <p>3:0 Reserved</p>
Status	<p>Bit Description</p> <p>7:6 Transport Dependent - See 6.2.11.</p> <p>5:1 N/A</p> <p>0 Error - See 6.2.8</p>

8.3.5 SCT Feature Control command

The SCT Feature Control command is used to determine and set the state (i.e., enabled or disabled) of the features specified by the command.

Table 90 defines the format of a SCT Feature Control command written to the SCT Command/Status log.

Table 90 — SCT Feature Control command

Word	Name	Value	Description
0	Action Code	0004h	Set or return the state of device features defined in table 91
1	Function Code	0000h	Reserved
		0001h	Set state for a feature
		0002h	Return the current state of a feature
		0003h	Return feature option flags
		0004h-FFFFh	Reserved
2	Feature Code		See table 91 for definition of the Feature Code
3	State		Feature Code dependent value
4	Option Flags		<p>Bit Description</p> <p>15:1 Reserved</p> <p>0 If the function code is 0001h, setting bit 0 to one shall cause the requested feature state change to be preserved during all power and reset events. If the function code is 0001h, setting bit 0 to zero shall cause the requested feature state change to be volatile. A hard reset causes the device to revert to default, or last non-volatile setting.</p>

Table 91 — Feature Code List

Feature Code	State Definition
0000h	Reserved
0001h	<p>If State is set to 0001h, then the SET FEATURES command shall determine the state of the write cache (see 7.48.4).</p> <p>If State is set to 0002h, then write cache shall be enabled.</p> <p>If State is set to 0003h, then write cache shall be disabled.</p> <p>If State is set to 0002h or 0003h, then write cache shall be set to the specified state, and any attempt to change the write cache settings using a SET FEATURES command shall not result in an error but shall not change the operational state of the write cache.</p> <p>In all cases, IDENTIFY DEVICE data word 85 bit 5 shall reflect the current operational state of write cache (i.e., if set to one, then volatile write cache is enabled, and if set to zero, then write cache is disabled).</p> <p>The default is State set to 0001h.</p>
0002h	<p>If State is set to 0001h, then volatile Write Cache Reordering shall be enabled (i.e., disk write scheduling may be reordered by the device).</p> <p>If State is set to 0002h, then volatile Write Cache Reordering shall be disabled, and disk write scheduling is processed on a first-in-first-out (FIFO) basis.</p> <p>If volatile write cache is disabled, then the current volatile Write Cache Reordering state is remembered but has no effect on non-cached writes, which are always written in the order received.</p> <p>The state of volatile Write Cache Reordering has no effect on TCQ or NCQ commands.</p> <p>The default is State set to 0001h.</p>
0003h	<p>The value in State sets the time interval for temperature logging.</p> <p>State set to 0000h is invalid.</p> <p>State may be set to 0001h to FFFFh to specify the temperature logging interval in minutes</p> <p>This value applies to the Absolute HDA Temperature History queue. Issuing this command shall cause the queue to be reset and any prior values in the queues shall be lost. Queue Index shall be set to zero and the first queue location shall be set to the current value. All remaining queue locations are set to 80h. The Sample Period, Max Op Limit, Over Limit, Min Op Limit and Under Limit values are preserved.</p> <p>The default is State set to 0001h.</p>
0004h-0005h	Reserved for Serial ATA
0006h-CFFFh	Reserved
D000h-FFFFh	Vendor Specific

Table 92 defines the format of the status response for a SCT Feature Control command.

Table 92 — SCT Feature Control command status response

Name	Description
Error	<p>Bit Description</p> <p>7:5 N/A</p> <p>4 ID Not Found - See 6.3.6.</p> <p>3 N/A</p> <p>2 Abort - See 6.3.2.</p> <p>1 N/A</p> <p>0 Obsolete</p>
Count	<p>If the Function Code was set to 0002h, then this is the Feature State (7:0). If the Function Code was set to 0003h, then this is the Option Flags (7:0). Otherwise this field is reserved.</p>
LBA	<p>Bit Description</p> <p>27:8 Reserved</p> <p>7:0 If the Function Code was set to 0002h, then this is the Feature State (15:8). If the Function Code was set to 0003h, then this is the Option Flags (15:8). Otherwise this field is reserved.</p>
Device	<p>Bit Description</p> <p>7 Obsolete</p> <p>6 N/A</p> <p>5 Obsolete</p> <p>4 Transport Dependent - See 6.2.11</p> <p>3:0 Reserved</p>
Status	<p>Bit Description</p> <p>7:6 Transport Dependent - See 6.2.11.</p> <p>5:1 N/A</p> <p>0 Error - See 6.2.8</p>

8.3.6 SCT Data Table command

The SCT Data Table command reads the specified data table.

Table 93 defines the format of an SCT Data Table command written to the SCT Command/Status log.

Table 93 — SCT Data Table command

Word	Name	Value	Description
0	Action Code	0005h	Read a data table
1	Function Code	0000h	Reserved
		0001h	Read Table
		0002h-FFFFh	Reserved
2	Table ID	Word	See Table 94 for a list of SCT data tables

Table 94 — SCT Data Tables (by Table Identifier)

Table Id	Description
0000h	Invalid
0001h	Reserved
0002h	HDA Temperature History Table (in degrees C). See Table 95 for more information.
0003h-0004h	Reserved for Serial ATA
0005h-CFFFh	Reserved
D000h-FFFFh	Vendor Specific

Table 95 — Absolute HDA Temperature

Byte	Size	Field Name	Description
0-1	Word	Format Version	0002h - Data table format version
2-3	Word	Sampling Period	Absolute HDA Temperature sampling period in minutes. This is how often the device samples its temperature sensor. This period takes precedence over new read or write operations, but does not interrupt operations in process. The Sampling Period may be smaller than the timer interval between entries in the history queue. A value of 0000h in this field indicates that sampling is disabled.
4-5	Word	Interval	The timer interval between entries in the history queue. The default value of this field is vendor specific. This value should not be less than the Sampling Period.
6	Byte	Max Op Limit	Maximum recommended continuous operating temperature ^c . This is a one byte two's complement number that allows a range from -127 °C to +127 °C to be indicated. 80h is an invalid value. This is a fixed value.
7	Byte	Over Limit	Maximum temperature limit. Operating the device above this temperature may cause physical damage to the device ^c . This is a one-byte two's complement number that allows a range from -127 °C to +127 °C to be indicated. 80h is an invalid value. This is a fixed value.
8	Byte	Min Op Limit	Minimum recommended continuous operating limit ^c . This is a one byte 2's complement number that allows a range from -127 °C to +127 °C to be indicated. 80h is an invalid value. This is a fixed value.
9	Byte	Under Limit	Minimum temperature limit. Operating the device below this temperature may cause physical damage to the device ^c . This is a one-byte two's complement number that allows a range from -127 °C to +127 °C to be indicated. 80h is an invalid value. This is a fixed value.
10-29	Byte [20]	reserved	
30-31	Word	CB Size	Number of entry locations in history buffer. This number shall be in the range of 128 to 478.
32-33	Word	CB Index	Last updated entry in buffer. CB Index is zero-based, so CB Index 0000h is the first location in the buffer (i.e., at offset 34). The most recent temperature entered in the buffer is at CB Index + 34 ^{ab} .

Table 95 — Absolute HDA Temperature

Byte	Size	Field Name	Description
34 to (CB Size + 33)	Byte [CB Size]	CB	This is a circular buffer of absolute HDA Temperature values. Other device activities (e.g., data transfer), take priority over writing this data to non-volatile storage. These are one-byte two's complement numbers that allow a range from -127 °C to +127 °C to be indicated. A value of 80h indicates an initial value or a discontinuity in temperature recording. The time between samples may vary because commands shall not be interrupted. The sampling period is the minimum time between samples ^a . If the host changes the logging interval using the volatile option, then the interval between entries in the queue may change between power cycles with no indication to the host.
(CB Size + 34) to 511	Byte [512 - CB Size - 34]	reserved	Shall be zero.
<p>^a The Absolute HDA Temperature History is preserved during the processing of all power and reset events with the requirement that when the device powers up, a new entry is made in the history queue with a value of 80h (i.e., an invalid absolute temperature value). This allows an application viewing the history to see the discontinuity in temperature resulting from the device being turned off. If the device does not sample temperatures during a certain power state (e.g., Sleep or Standby), then a value of 80h is entered into the history queue to indicate that temperature sensing has resumed.</p> <p>^b When the Absolute HDA Temperature history is cleared (e.g., for new devices or after changing the Logging Interval) the Queue Index shall be set to zero and the first queue location shall be set to the current Absolute HDA Temperature value. All remaining queue locations shall be set to 80h.</p> <p>^c These values should take into account the accuracy of the temperature sensor. The placement, accuracy, and granularity of temperature sensors to support table 95 are vendor specific.</p>			

Table 96 defines the format of the status response for an SCT Data Table command.

Table 96 — SCT Data Table command status response

Name	Description
Error	<p>Bit Description</p> <p>7:5 N/A</p> <p>4 ID Not Found - See 6.3.6.</p> <p>3 N/A</p> <p>2 Abort - See 6.3.2.</p> <p>1 N/A</p> <p>0 Obsolete</p>
Count	Reserved
LBA	<p>Bit Description</p> <p>27:24 Reserved</p> <p>23:8 For Table ID 0002h, 0001h (i.e., Number of data blocks requested); otherwise reserved.</p> <p>7:0 Reserved.</p>
Device	<p>Bit Description</p> <p>7 Obsolete</p> <p>6 N/A</p> <p>5 Obsolete</p> <p>4 Transport Dependent - See 6.2.11</p> <p>3:0 Reserved</p>
Status	<p>Bit Description</p> <p>7:6 Transport Dependent - See 6.2.11.</p> <p>5:1 N/A</p> <p>0 Error - See 6.2.8</p>

9 Normal and Error Outputs

9.1 Overview

The commands listed in clause 7 each have sections labeled “Normal Outputs” and “Error Outputs”. Subclauses 9.2 and 9.3 document the return data format for all the commands described in clause 7. Each command in clause 7 may provide additional information about a normal or error output, but all the information that is referenced in clause 9 applies to the command as well.

The references preceding each table indicate each command that generates the output in the table.

9.2 Normal Outputs

The tables in this subclause document all the possible Normal Outputs a command returns.

Reference: 7.2

Table 97 — Error Bit Defined For Normal Output

Name	Description
Error	N/A
Count	N/A
LBA	N/A
Device	<p>Bit Description</p> <ul style="list-style-type: none"> 7 Obsolete 6 N/A 5 Obsolete 4 Transport Dependent - See 6.2.11 3:0 Reserved
Status	<p>Bit Description</p> <ul style="list-style-type: none"> 7:6 Transport Dependent - See 6.2.11. 5 Device Fault – See 6.2.6 4 N/A 3 Transport Dependent - See 6.2.11. 2:1 N/A 0 Error - See 6.2.8

Reference: 7.3

Table 98 — Extended Error Code for Normal Output

Name	Description
Error	Extended error code (see table 22)
Count	Vendor Specific
LBA	Vendor Specific
Device	<p>Bit Description</p> <ul style="list-style-type: none"> 7 Obsolete 6 N/A 5 Obsolete 4 Transport Dependent - See 6.2.11 3:0 Reserved
Status	<p>Bit Description</p> <ul style="list-style-type: none"> 7:6 Transport Dependent - See 6.2.11. 5:1 N/A 0 Error - See 6.2.8

Reference: 7.10.4, 7.10.2, 7.10.3, 7.10.5, 7.12, 7.14, 7.16, 7.17, 7.18, 7.19, 7.21.4, 7.20.11, 7.23, 7.24, 7.31, 7.35, 7.39, 7.41, 7.42, 7.43, 7.44, 7.45, 7.46, 7.48, 7.49.5, 7.49.4, 7.49.6, 7.49.3, 7.51, 7.52, 7.53.2, 7.53.3, 7.53.4, 7.53.6, 7.53.7, 7.53.9, 7.54, 7.55, 7.61, 7.62, 7.71, 7.74, 7.78

Table 99 — Generic Normal Output (No LBA Return Value) for Normal Output

Name	Description
Error	N/A
Count	N/A
LBA	N/A
Device	<p>Bit Description</p> <ul style="list-style-type: none"> 7 Obsolete 6 N/A 5 Obsolete 4 Transport Dependent - See 6.2.11 3:0 Reserved
Status	<p>Bit Description</p> <ul style="list-style-type: none"> 7:6 Transport Dependent - See 6.2.11. 5 Device Fault – See 6.2.6 4 N/A 3 Transport Dependent - See 6.2.11. 2:1 N/A 0 Error - See 6.2.8

Reference: 7.4, 7.5, 7.6

Table 100 — CFA Normal Output

Name	Description
Error	N/A
Count	N/A
LBA	N/A
Device	<p>Bit Description</p> <ul style="list-style-type: none"> 7 Obsolete 6 N/A 5 Obsolete 4 Transport Dependent - See 6.2.11 3:0 Reserved
Status	<p>Bit Description</p> <ul style="list-style-type: none"> 7:6 Transport Dependent - See 6.2.11. 5:1 N/A 0 Error - See 6.2.8

Reference: 7.7

Table 101 — Media Card Type Normal Output

Name	Description
Error	N/A
Count	55h
LBA	<p>Bit Description</p> <p>27 Write Protect - shall be set to one if the device is write protected, Write Protect shall be cleared to zero if the device is not write protected.</p> <p>26:24 Media Type</p> <p>Value Description</p> <p>000b Reserved</p> <p>001b SD Memory Card</p> <p>010b Obsolete</p> <p>011b Obsolete</p> <p>100b Obsolete</p> <p>101b-111b Reserved</p> <p>23:8 Card specific Data</p> <p>7:0 Shall be set to AAh</p>
Device	<p>Bit Description</p> <p>7 Obsolete</p> <p>6 N/A</p> <p>5 Obsolete</p> <p>4 Transport Dependent - See 6.2.11</p> <p>3:0 Reserved</p>
Status	<p>Bit Description</p> <p>7:6 Transport Dependent - See 6.2.11</p> <p>5 Device Fault - See 6.2.6</p> <p>4:1 N/A</p> <p>0 Error - See 6.2.8</p>

Reference: 7.8

Table 102 — Check Power Mode Normal Output

Name	Description
Error	N/A
Count	<p>Value Description</p> <p>00h Device is in PM2: Standby state.</p> <p>40h Device is in the PM0: Active state, the NV Cache power mode is enabled, and the spindle is spun down or spinning down.</p> <p>41h Device is in the PM0: Active state, the NV Cache power mode is enabled, and the spindle is spun up or spinning up.</p> <p>80h Device is in PM1: Idle state.</p> <p>FFh Device is in the PM0: Active state or PM1: Idle State.</p>
LBA	N/A
Device	<p>Bit Description</p> <p>7 Obsolete</p> <p>6 N/A</p> <p>5 Obsolete</p> <p>4 Transport Dependent - See 6.2.11</p> <p>3:0 Reserved</p>
Status	<p>Bit Description</p> <p>7:6 Transport Dependent - See 6.2.11.</p> <p>5 Device Fault - See 6.2.6</p> <p>4 N/A</p> <p>3 Transport Dependent - See 6.2.11.</p> <p>2:1 N/A</p> <p>0 Error - See 6.2.8</p>

Reference: 7.9, 7.37, 7.76

Table 103 — Stream Normal Output

Name	Description
Error	N/A
Count	Reserved
LBA	Reserved
Device	<p>Bit Description</p> <ul style="list-style-type: none"> 7 Obsolete 6 N/A 5 Obsolete 4 Transport Dependent - See 6.2.11 3:0 Reserved
Status	<p>Bit Description</p> <ul style="list-style-type: none"> 7:6 Transport Dependent - See 6.2.11. 5 Stream Error - See 6.2.10 4 N/A 3 Transport Dependent - See 6.2.11. 2:1 N/A 0 Error - See 6.2.8

Reference: 3.1.69, 7.11, 7.13, 7.16, 7.35

Table 104 — Device Signatures for Normal Output

Name	Description																														
Error	Diagnostic Results - The diagnostic code as described in table 28 is returned. This field shall be reserved for the DEVICE RESET command. For the READ SECTOR(S) command or the IDENTIFY DEVICE command, bit 2 of this field shall be set to one and the remaining bits are N/A.																														
Count	<table border="1"> <thead> <tr> <th data-bbox="326 510 475 579">Bit</th> <th data-bbox="479 510 638 579">ATA Device</th> <th data-bbox="641 510 800 579">ATAPI Device</th> <th data-bbox="803 510 963 579">Reserved for SATA</th> <th data-bbox="966 510 1125 579">Reserved for SATA</th> <th data-bbox="1128 510 1305 579">Reserved for CE-ATA</th> </tr> </thead> <tbody> <tr> <td data-bbox="326 583 475 653">7:0</td> <td data-bbox="479 583 638 653">01h</td> <td data-bbox="641 583 800 653">01h</td> <td data-bbox="803 583 963 653">01h</td> <td data-bbox="966 583 1125 653">01h</td> <td data-bbox="1128 583 1305 653">Reserved for CE-ATA</td> </tr> </tbody> </table>						Bit	ATA Device	ATAPI Device	Reserved for SATA	Reserved for SATA	Reserved for CE-ATA	7:0	01h	01h	01h	01h	Reserved for CE-ATA	All other signatures reserved												
Bit	ATA Device	ATAPI Device	Reserved for SATA	Reserved for SATA	Reserved for CE-ATA																										
7:0	01h	01h	01h	01h	Reserved for CE-ATA																										
LBA	<table border="1"> <tbody> <tr> <td data-bbox="326 661 475 697">27:24</td> <td data-bbox="479 661 638 697">Reserved</td> <td data-bbox="641 661 800 697">Reserved</td> <td data-bbox="803 661 963 697">Reserved</td> <td data-bbox="966 661 1125 697">Reserved</td> <td data-bbox="1128 661 1305 697">Reserved</td> </tr> <tr> <td data-bbox="326 701 475 737">23:16</td> <td data-bbox="479 701 638 737">00h</td> <td data-bbox="641 701 800 737">EBh</td> <td data-bbox="803 701 963 737">C3h</td> <td data-bbox="966 701 1125 737">96h</td> <td data-bbox="1128 701 1305 737">AAh</td> </tr> <tr> <td data-bbox="326 741 475 777">15:8</td> <td data-bbox="479 741 638 777">00h</td> <td data-bbox="641 741 800 777">14h</td> <td data-bbox="803 741 963 777">3Ch</td> <td data-bbox="966 741 1125 777">69h</td> <td data-bbox="1128 741 1305 777">CEh</td> </tr> <tr> <td data-bbox="326 781 475 856">7:0</td> <td data-bbox="479 781 638 856">01h</td> <td data-bbox="641 781 800 856">01h</td> <td data-bbox="803 781 963 856">01h</td> <td data-bbox="966 781 1125 856">01h</td> <td data-bbox="1128 781 1305 856">Reserved for CE-ATA</td> </tr> </tbody> </table>						27:24	Reserved	Reserved	Reserved	Reserved	Reserved	23:16	00h	EBh	C3h	96h	AAh	15:8	00h	14h	3Ch	69h	CEh	7:0	01h	01h	01h	01h	Reserved for CE-ATA	
27:24	Reserved	Reserved	Reserved	Reserved	Reserved																										
23:16	00h	EBh	C3h	96h	AAh																										
15:8	00h	14h	3Ch	69h	CEh																										
7:0	01h	01h	01h	01h	Reserved for CE-ATA																										
Device	<p>Bit Description</p> <ul style="list-style-type: none"> 7 Obsolete 6 N/A 5 Obsolete 4 Transport Dependent - See 6.2.11 3:0 Reserved 																														
Status	<p>Bit Description</p> <ul style="list-style-type: none"> 7:6 Transport Dependent - See 6.2.11. 5 Device Fault - See 6.2.6 4 N/A 3 Transport Dependent - See 6.2.11. 2:1 N/A 0 Error - See 6.2.8 																														

Reference: 7.19

Table 105 — IDLE Unload Normal Output

Name	Description
Error	N/A
Count	N/A
LBA	<p>Bit Description</p> <p>27:8 N/A</p> <p>7:0 C4h</p>
Device	<p>Bit Description</p> <p>7 Obsolete</p> <p>6 N/A</p> <p>5 Obsolete</p> <p>4 Transport Dependent - See 6.2.11</p> <p>3:0 Reserved</p>
Status	<p>Bit Description</p> <p>7:6 Transport Dependent - See 6.2.11.</p> <p>5 Device Fault - See 6.2.6</p> <p>4 N/A</p> <p>3 Transport Dependent - See 6.2.11.</p> <p>2:1 N/A</p> <p>0 Error - See 6.2.8</p>

Reference: 7.22.6

Table 106 — ATAPI Normal Output

Name	Description
Error	N/A
Interrupt Reason	<p>Bit Description</p> <ul style="list-style-type: none"> 7:3 Tag - See 6.4.5 2 Obsolete 1 Input/Output - See 6.4.3 0 Command/Data - See 6.4.2
LBA	<p>Bit Description</p> <ul style="list-style-type: none"> 27:24 N/A 23:8 Byte Count 7:0 N/A
Device	<p>Bit Description</p> <ul style="list-style-type: none"> 7 Obsolete 6 N/A 5 Obsolete 4 Transport Dependent - See 6.2.11 3:0 Reserved
Status	<p>Bit Description</p> <ul style="list-style-type: none"> 7 Transport Dependent - See 6.2.11. 6 N/A 5 Obsolete 4 Service - See 6.2.9. 3 Transport Dependent - See 6.2.11. 2:1 N/A 0 Error - See 6.2.8. Shall be cleared to zero

Reference: 7.26.4, 7.65.4

Table 107 — Queued Normal Output

Name	Description
Error	N/A
Interrupt Reason	<p>Bit Description</p> <p>7:3 Tag - See 6.4.5.</p> <p>2 Release - See 6.4.4.</p> <p>1 Input/Output - See 6.4.3.</p> <p>0 Command/Data - See 6.4.2.</p>
LBA	N/A
Device	<p>Bit Description</p> <p>7 Obsolete</p> <p>6 N/A</p> <p>5 Obsolete</p> <p>4 Transport Dependent - See 6.2.11</p> <p>3:0 Reserved</p>
Status	<p>Bit Description</p> <p>7 Transport Dependent - See 6.2.11.</p> <p>6 N/A</p> <p>5 Device Fault - See 6.2.6</p> <p>4 Service - See 6.2.9.</p> <p>3 Transport Dependent - See 6.2.11</p> <p>2:1 N/A</p> <p>0 Error - See 6.2.8. Shall be cleared to zero</p>

Reference: 7.33, 7.49.2

Table 108 — HPA Normal Output

Name	Description
Error	N/A
Count	N/A
LBA	Maximum LBA
Device	<p>Bit Description</p> <ul style="list-style-type: none"> 7 Obsolete 6 N/A 5 Obsolete 4 Transport Dependent - See 6.2.11 3:0 Reserved
Status	<p>Bit Description</p> <ul style="list-style-type: none"> 7:6 Transport Dependent - See 6.2.11. 5:1 N/A 0 Error - See 6.2.8

Reference: 7.53.5

Table 109 — SMART Off-Line Immediate Normal Output

Name	Description
Error	N/A
Count	N/A
LBA	<p>Bit Description</p> <p>27:24 N/A</p> <p>23:8</p> <p>Value Description</p> <p>C24Fh Subcommand specified a captive self-test that has completed without error.</p> <p>All Other the subcommand specified an off-line routine including an off-line self-test routine.</p> <p>7:0 N/A</p>
Device	<p>Bit Description</p> <p>7 Obsolete</p> <p>6 N/A</p> <p>5 Obsolete</p> <p>4 Transport Dependent - See 6.2.11</p> <p>3:0 Reserved</p>
Status	<p>Bit Description</p> <p>7:6 Transport Dependent - See 6.2.11.</p> <p>5 Device Fault - See 6.2.6</p> <p>4 N/A</p> <p>3 Transport Dependent - See 6.2.11.</p> <p>2:1 N/A</p> <p>0 Error - See 6.2.8</p>

Reference: 7.53.8

Table 110 — SMART Return Status Normal Output

Name	Description
Error	N/A
Count	N/A
LBA	<p>Bit Description</p> <p>27:24 N/A</p> <p>23:8</p> <p>Value Description</p> <p>C24Fh Subcommand specified a captive self-test that has completed without error.</p> <p>2CF4h The device has detected a threshold exceeded condition</p> <p>All Other Undefined Values</p> <p>7:0 N/A</p>
Device	<p>Bit Description</p> <p>7 Obsolete</p> <p>6 N/A</p> <p>5 Obsolete</p> <p>4 Transport Dependent - See 6.2.11</p> <p>3:0 Reserved</p>
Status	<p>Bit Description</p> <p>7:6 Transport Dependent - See 6.2.11.</p> <p>5 Device Fault - See 6.2.6</p> <p>4 N/A</p> <p>3 Transport Dependent - See 6.2.11.</p> <p>2:1 N/A</p> <p>0 Error - See 6.2.8</p>

Reference: 7.15, 7.20.5, 7.25, 7.29, 7.32, 7.36, 7.40, 7.57, 7.59, 7.63, 7.64, 7.69, 7.72, 7.73, 7.75

Table 111 — Generic Extended Normal Output

Name	Description
Error	Reserved
Count	Reserved
LBA	Reserved
Device	<p>Bit Description</p> <ul style="list-style-type: none"> 7 Obsolete 6 N/A 5 Obsolete 4 Transport Dependent - See 6.2.11 3:0 Reserved
Status	<p>Bit Description</p> <ul style="list-style-type: none"> 7:6 Transport Dependent - See 6.2.11. 5 Device Fault – See 6.2.6 4 N/A 3 Transport Dependent - See 6.2.11. 2:1 N/A 0 Error - See 6.2.8

Reference: 7.34, 7.50

Table 112 — SETMAX Extended Normal Output

Name	Description
Error	Reserved
Count	Reserved
LBA	Maximum LBA
Device	<p>Bit Description</p> <ul style="list-style-type: none"> 7 Obsolete 6 N/A 5 Obsolete 4 Transport Dependent - See 6.2.11 3:0 Reserved
Status	<p>Bit Description</p> <ul style="list-style-type: none"> 7:6 Transport Dependent - See 6.2.11. 5:1 N/A 0 Error - See 6.2.8

Reference: 7.27.4, 7.66.4

Table 113 — Queued Extended Normal Output

Name	Description
Error	N/A
Interrupt Reason	<p>Bit Description</p> <p>7:3 Tag - See 6.4.5.</p> <p>2 Release - See 6.4.4.</p> <p>1 Input/Output - See 6.4.3.</p> <p>0 Command/Data - See 6.4.2.</p>
LBA	Reserved
Device	<p>Bit Description</p> <p>7 Obsolete</p> <p>6 N/A</p> <p>5 Obsolete</p> <p>4 Transport Dependent - See 6.2.11</p> <p>3:0 Reserved</p>
Status	<p>Bit Description</p> <p>7 Transport Dependent - See 6.2.11.</p> <p>6 N/A</p> <p>5 Device Fault - See 6.2.6</p> <p>4 Service - See 6.2.9.</p> <p>3 Transport Dependent - See 6.2.11</p> <p>2:1 N/A</p> <p>0 Error - See 6.2.8. Shall be cleared to zero</p>

Reference: 7.20.3, 7.20.9, 7.20.8, 7.20.7

Table 114 — NV Cache Normal Output

Name	Description
Error	Reserved
Count	Reserved
LBA	Number of unpinned logical blocks remaining
Device	<p>Bit Description</p> <ul style="list-style-type: none"> 7 Obsolete 6 N/A 5 Obsolete 4 Transport Dependent - See 6.2.11 3:0 Reserved
Status	<p>Bit Description</p> <ul style="list-style-type: none"> 7:6 Transport Dependent - See 6.2.11. 5 Device Fault – See 6.2.6 4 N/A 3 Transport Dependent - See 6.2.11. 2:1 N/A 0 Error - See 6.2.8

Reference: 7.20.4

Table 115 — NV Cache Flush Normal Output

Name	Description
Error	Reserved
Count	Reserved
LBA	Number of unflushed logical blocks remaining
Device	<p>Bit Description</p> <ul style="list-style-type: none"> 7 Obsolete 6 N/A 5 Obsolete 4 Transport Dependent - See 6.2.11 3:0 Reserved
Status	<p>Bit Description</p> <ul style="list-style-type: none"> 7:6 Transport Dependent - See 6.2.11. 5 Device Fault – See 6.2.6 4 N/A 3 Transport Dependent - See 6.2.11. 2:1 N/A 0 Error - See 6.2.8

Reference: 7.28.4, 7.68.4

Table 116 — NCQ Command Acceptance Normal Output

Name	Description
Error	Shall be cleared to zero
Count	N/A
LBA	N/A
Device	<p>Bit Description</p> <p>7:4 N/A</p> <p>3:0 Reserved</p>
Status	<p>Bit Description</p> <p>7:6 Transport Dependent - See 6.2.11.</p> <p>5 Device Fault – See 6.2.6</p> <p>4 N/A</p> <p>3 Transport Dependent - See 6.2.11.</p> <p>2:1 N/A</p> <p>0 Error - See 6.2.8</p>

Reference: 7.28.5, 7.68.5

Table 117 — NCQ Normal Outputs

Name	Description
SATA Status	Transport Dependent
Error	Shall be cleared to zero
Status	<p>Bit Description</p> <p>7:6 Transport Dependent - See 6.2.11.</p> <p>5 Device Fault – See 6.2.6</p> <p>4 N/A</p> <p>3 Transport Dependent - See 6.2.11.</p> <p>2:1 N/A</p> <p>0 Error - See 6.2.8</p>
SActive	31:0 Transport dependent completion indicator

9.3 Error Outputs

The tables in this subclause document all the possible Error Outputs a command returns. References to these tables are found in clause 7.

Reference: 7.1.9

Table 118 — Unsupported Command Error

Name	Description
Error	<p>Bit Description</p> <p>7:3 N/A</p> <p>2 Abort - See 6.3.2</p> <p>1:0 N/A</p>
Count	N/A
LBA	N/A
Device	<p>Bit Description</p> <p>7:4 N/A</p> <p>3:0 Reserved</p>
Status	<p>Bit Description</p> <p>7:6 Transport Dependent - See 6.2.11.</p> <p>5:1 N/A</p> <p>0 Error - See 6.2.8</p>

Reference: 7.2

Table 119 — CFA Erase Error

Name	Description
Error	<p>Bit Description</p> <p>7:5 N/A</p> <p>4 ID Not Found - See 6.3.6</p> <p>3 N/A</p> <p>2 Abort - See 6.3.2</p> <p>1 N/A</p> <p>0 Media Error - See 6.3.11</p>
Count	N/A
LBA	LBA of first unrecoverable error
Device	<p>Bit Description</p> <p>7 Obsolete</p> <p>6 N/A</p> <p>5 Obsolete</p> <p>4 Transport Dependent - See 6.2.11</p> <p>3:0 Reserved</p>
Status	<p>Bit Description</p> <p>7:6 Transport Dependent - See 6.2.11.</p> <p>5 Device Fault - See 6.2.6</p> <p>4:1 N/A</p> <p>0 Error - See 6.2.8</p>

Reference: 7.5, 7.6

Table 120 — CFA Write Error

Name	Description
Error	<p>Bit Description</p> <p>7:5 N/A</p> <p>4 ID Not Found - See 6.3.6</p> <p>3 N/A</p> <p>2 Abort - See 6.3.2</p> <p>1 N/A</p> <p>0 Media Error - See 6.3.11</p>
Count	N/A
LBA	LBA of first unrecoverable error
Device	<p>Bit Description</p> <p>7 Obsolete</p> <p>6 N/A</p> <p>5 Obsolete</p> <p>4 Transport Dependent - See 6.2.11</p> <p>3:0 Reserved</p>
Status	<p>Bit Description</p> <p>7:6 Transport Dependent - See 6.2.11.</p> <p>5 Device Fault - See 6.2.6</p> <p>4 Transport Dependent - See 6.2.11</p> <p>3:1 N/A</p> <p>0 Error - See 6.2.8</p>

Reference: 7.3, 7.4, 7.8

Table 121 — CFA & Check Power Mode Abort Error

Name	Description
Error	<p>Bit Description</p> <p>7:3 N/A</p> <p>2 Abort - See 6.3.2</p> <p>1:0 N/A</p>
Count	N/A
LBA	N/A
Device	<p>Bit Description</p> <p>7 Obsolete</p> <p>6 N/A</p> <p>5 Obsolete</p> <p>4 Transport Dependent - See 6.2.11</p> <p>3:0 Reserved</p>
Status	<p>Bit Description</p> <p>7:6 Transport Dependent - See 6.2.11.</p> <p>5 Device Fault - See 6.2.6</p> <p>4:1 N/A</p> <p>0 Error - See 6.2.8</p>

Reference: 7.7, 7.10.4, 7.10.2, 7.18, 7.19, 7.42, 7.44, 7.48, 7.51, 7.52, 7.53.2, 7.53.3, 7.53.4, 7.53.8, 7.54, 7.55, 7.78

Table 122 — Generic Abort wo/ICRC Error

Name	Description
Error	<p>Bit Description 7:3 N/A 2 Abort - See 6.3.2 1:0 N/A</p>
Count	N/A
LBA	N/A
Device	<p>Bit Description 7 Obsolete 6 N/A 5 Obsolete 4 Transport Dependent - See 6.2.11 3:0 Reserved</p>
Status	<p>Bit Description 7:6 Transport Dependent - See 6.2.11. 5 Device Fault - See 6.2.6 4 N/A 3 Transport Dependent - See 6.2.11 2:1 N/A 0 Error - See 6.2.8</p>

Reference: 7.10.3, 7.12, 7.17, 7.23, 7.41, 7.43, 7.45, 7.46, 7.61

Table 123 — Generic Abort Error

Name	Description
Error	<p>Bit Description</p> <p>7 Interface CRC - See 6.3.10</p> <p>6:3 N/A</p> <p>2 Abort - See 6.3.2</p> <p>1:0 N/A</p>
Count	N/A
LBA	N/A
Device	<p>Bit Description</p> <p>7 Obsolete</p> <p>6 N/A</p> <p>5 Obsolete</p> <p>4 Transport Dependent - See 6.2.11</p> <p>3:0 Reserved</p>
Status	<p>Bit Description</p> <p>7:6 Transport Dependent - See 6.2.11.</p> <p>5 Device Fault - See 6.2.6</p> <p>4 N/A</p> <p>3 Transport Dependent - See 6.2.11</p> <p>2:1 N/A</p> <p>0 Error - See 6.2.8</p>

Reference: 7.57, 7.59

Table 124 — Trusted Abort Error

Name	Description
Error	<p>Bit Description</p> <ul style="list-style-type: none"> 7 Interface CRC - See 6.3.10 6:3 N/A 2 Abort - See 6.3.2 1:0 N/A
Count	Reserved
LBA	Reserved
Device	<p>Bit Description</p> <ul style="list-style-type: none"> 7 Obsolete 6 N/A 5 Obsolete 4 Transport Dependent - See 6.2.11 3:0 Reserved
Status	<p>Bit Description</p> <ul style="list-style-type: none"> 7:6 Transport Dependent - See 6.2.11. 5 Device Fault - See 6.2.6 4 N/A 3 Transport Dependent - See 6.2.11 2:1 N/A 0 Error - See 6.2.8

Reference: 7.33, 7.49.4, 7.49.3

Table 125 — Generic SET MAX Error

Name	Description
Error	<p>Bit Description</p> <p>7:3 N/A</p> <p>2 Abort - See 6.3.2</p> <p>1:0 N/A</p>
Count	N/A
LBA	N/A
Device	<p>Bit Description</p> <p>7 Obsolete</p> <p>6 N/A</p> <p>5 Obsolete</p> <p>4 Transport Dependent - See 6.2.11</p> <p>3:0 Reserved</p>
Status	<p>Bit Description</p> <p>7:6 Transport Dependent - See 6.2.11.</p> <p>5:1 N/A</p> <p>0 Error - See 6.2.8</p>

Reference:7.49.6

Table 126 — SET MAX Unlock Error

Name	Description
Error	<p>Bit Description</p> <ul style="list-style-type: none"> 7 Interface CRC - See 6.3.10 6:3 N/A 2 Abort - See 6.3.2 1:0 N/A
Count	N/A
LBA	N/A
Device	<p>Bit Description</p> <ul style="list-style-type: none"> 7 Obsolete 6 N/A 5 Obsolete 4 Transport Dependent - See 6.2.11 3:0 Reserved
Status	<p>Bit Description</p> <ul style="list-style-type: none"> 7:6 Transport Dependent - See 6.2.11. 5:1 N/A 0 Error - See 6.2.8

Reference: 7.9

Table 127 — Configure Stream Error

Name	Description
Error	<p>Bit Description</p> <p>7:3 N/A</p> <p>2 Abort - See 6.3.2</p> <p>1:0 N/A</p>
Count	Reserved
LBA	Reserved
Device	<p>Bit Description</p> <p>7 Obsolete</p> <p>6 N/A</p> <p>5 Obsolete</p> <p>4 Transport Dependent - See 6.2.11</p> <p>3:0 Reserved</p>
Status	<p>Bit Description</p> <p>7:6 Transport Dependent - See 6.2.11.</p> <p>5 Stream Error - See 6.2.10</p> <p>4 N/A</p> <p>3 Transport Dependent - See 6.2.11.</p> <p>2:1 N/A</p> <p>0 Error - See 6.2.8</p>

Reference: 7.14

Table 128 — Flush Cache Error

Name	Description
Error	<p>Bit Description</p> <p>7:3 N/A</p> <p>2 Abort - See 6.3.2</p> <p>1:0 N/A</p>
Count	N/A
LBA	LBA of first unrecoverable error
Device	<p>Bit Description</p> <p>7 Obsolete</p> <p>6 N/A</p> <p>5 Obsolete</p> <p>4 Transport Dependent - See 6.2.11</p> <p>3:0 Reserved</p>
Status	<p>Bit Description</p> <p>7:6 Transport Dependent - See 6.2.11.</p> <p>5 Device Fault - See 6.2.6</p> <p>4 N/A</p> <p>3 Transport Dependent - See 6.2.11.</p> <p>2:1 N/A</p> <p>0 Error - See 6.2.8</p>

Reference: 7.15

Table 129 — Flush Cache Ext Error

Name	Description
Error	<p>Bit Description</p> <p>7:3 N/A</p> <p>2 Abort - See 6.3.2</p> <p>1:0 N/A</p>
Count	Reserved
LBA	LBA of first unrecoverable error
Device	<p>Bit Description</p> <p>7 Obsolete</p> <p>6 N/A</p> <p>5 Obsolete</p> <p>4 Transport Dependent - See 6.2.11</p> <p>3:0 Reserved</p>
Status	<p>Bit Description</p> <p>7:6 Transport Dependent - See 6.2.11.</p> <p>5 Device Fault - See 6.2.6</p> <p>4 N/A</p> <p>3 Transport Dependent - See 6.2.11.</p> <p>2:1 N/A</p> <p>0 Error - See 6.2.8</p>

Reference: 7.24

Table 130 — Read DMA Error

Name	Description
Error	<p>Bit Description</p> <ul style="list-style-type: none"> 7 Interface CRC - See 6.3.10 6 Uncorrectable Error - See 6.3.13. 5 Obsolete 4 ID Not Found - See 6.3.6 3 Obsolete 2 Abort - See 6.3.2 1:0 Obsolete
Count	N/A
LBA	LBA of first unrecoverable error
Device	<p>Bit Description</p> <ul style="list-style-type: none"> 7 Obsolete 6 N/A 5 Obsolete 4 Transport Dependent - See 6.2.11 3:0 Reserved
Status	<p>Bit Description</p> <ul style="list-style-type: none"> 7:6 Transport Dependent - See 6.2.11. 5 Device Fault - See 6.2.6 4 N/A 3 Transport Dependent - See 6.2.11. 2:1 N/A 0 Error - See 6.2.8

Reference: 7.25

Table 131 — Read DMA Ext Error

Name	Description
Error	<p>Bit Description</p> <ul style="list-style-type: none"> 7 Interface CRC - See 6.3.10 6 Uncorrectable Error - See 6.3.13. 5 Obsolete 4 ID Not Found - See 6.3.6 3 Obsolete 2 Abort - See 6.3.2 1:0 Obsolete
Count	Reserved
LBA	LBA of first unrecoverable error
Device	<p>Bit Description</p> <ul style="list-style-type: none"> 7 Obsolete 6 N/A 5 Obsolete 4 Transport Dependent - See 6.2.11 3:0 Reserved
Status	<p>Bit Description</p> <ul style="list-style-type: none"> 7:6 Transport Dependent - See 6.2.11. 5 Device Fault - See 6.2.6 4 N/A 3 Transport Dependent - See 6.2.11. 2:1 N/A 0 Error - See 6.2.8

Reference: 7.29

Table 132 — Read Log Ext Error

Name	Description
Error	<p>Bit Description</p> <ul style="list-style-type: none"> 7 Interface CRC - See 6.3.10 6 Uncorrectable Error - See 6.3.13. 5 N/A 4 ID Not Found - See 6.3.6 3 N/A 2 Abort - See 6.3.2. 1 N/A 0 Obsolete
Count	Reserved
LBA	Reserved
Device	<p>Bit Description</p> <ul style="list-style-type: none"> 7 Obsolete 6 N/A 5 Obsolete 4 Transport Dependent - See 6.2.11 3:0 Reserved
Status	<p>Bit Description</p> <ul style="list-style-type: none"> 7:6 Transport Dependent - See 6.2.11. 5 Device Fault - See 6.2.6 4 N/A 3 Transport Dependent - See 6.2.11. 2:1 N/A 0 Error - See 6.2.8

Reference: 7.31, 7.35, 7.39

Table 133 — Read PIO Error

Name	Description
Error	<p>Bit Description</p> <ul style="list-style-type: none"> 7 Interface CRC - See 6.3.10 6 Uncorrectable Error - See 6.3.13 5 Obsolete 4 ID Not Found - See 6.3.6 3 Obsolete 2 Abort - See 6.3.2 1:0 Obsolete
Count	N/A
LBA	LBA of first unrecoverable error
Device	<p>Bit Description</p> <ul style="list-style-type: none"> 7 Obsolete 6 N/A 5 Obsolete 4 Transport Dependent - See 6.2.11 3:0 Reserved
Status	<p>Bit Description</p> <ul style="list-style-type: none"> 7:6 Transport Dependent - See 6.2.11. 5 Device Fault - See 6.2.6 4 N/A 3 Transport Dependent - See 6.2.11. 2:1 N/A 0 Error - See 6.2.8

Reference: 7.37

Table 134 — Read Stream Error

Name	Description
Error	<p>Bit Description</p> <ul style="list-style-type: none"> 7 Interface CRC - See 6.3.10 6 Uncorrectable Error - See 6.3.13. 5 Obsolete 4 ID Not Found - See 6.3.6 3 Obsolete 2 Abort - See 6.3.2 1 Obsolete 0 Command Completion Time Out - See 6.3.4
Count	Length of Stream Error - number of contiguous logical sectors containing potentially bad data, beginning with the LBA of the first logical sector with an uncorrectable error
LBA	LBA of first unrecoverable error
Device	<p>Bit Description</p> <ul style="list-style-type: none"> 7 Obsolete 6 N/A 5 Obsolete 4 Transport Dependent - See 6.2.11 3:0 Reserved
Status	<p>Bit Description</p> <ul style="list-style-type: none"> 7:6 Transport Dependent - See 6.2.11. 5 Stream Error - See 6.2.10. 4 Deferred Write Error - See 6.2.5. 3 Transport Dependent - See 6.2.11. 2:1 N/A 0 Error - See 6.2.8

Reference: 7.49.2, 7.49.5

Table 135 — HPA Error

Name	Description
Error	<p>Bit Description</p> <p>7:5 N/A</p> <p>4 ID Not Found - See 6.3.6.</p> <p>3 N/A</p> <p>2 Abort - See 6.3.2.</p> <p>1 N/A</p> <p>0 Obsolete</p>
Count	N/A
LBA	N/A
Device	<p>Bit Description</p> <p>7 Obsolete</p> <p>6 N/A</p> <p>5 Obsolete</p> <p>4 Transport Dependent - See 6.2.11</p> <p>3:0 Reserved</p>
Status	<p>Bit Description</p> <p>7:6 Transport Dependent - See 6.2.11.</p> <p>5 Device Fault - See 6.2.6</p> <p>4 N/A</p> <p>3 Transport Dependent - See 6.2.11.</p> <p>2:1 N/A</p> <p>0 Error - See 6.2.8</p>

Reference: 7.53.9

Table 136 — Write Log Error

Name	Description
Error	<p>Bit Description</p> <ul style="list-style-type: none"> 7 Interface CRC - See 6.3.10 6:5 N/A 4 ID Not Found - See 6.3.6. 3 N/A 2 Abort - See 6.3.2. 1 N/A 0 Obsolete
Count	N/A
LBA	N/A
Device	<p>Bit Description</p> <ul style="list-style-type: none"> 7 Obsolete 6 N/A 5 Obsolete 4 Transport Dependent - See 6.2.11 3:0 Reserved
Status	<p>Bit Description</p> <ul style="list-style-type: none"> 7:6 Transport Dependent - See 6.2.11 5 Device Fault - See 6.2.6 4 N/A 3 Transport Dependent - See 6.2.11 2:1 N/A 0 Error - See 6.2.8

Reference: 7.69

Table 137 — Write Log Ext Error

Name	Description
Error	<p>Bit Description</p> <ul style="list-style-type: none"> 7 Interface CRC - See 6.3.10 6:5 N/A 4 ID Not Found - See 6.3.6. 3 N/A 2 Abort - See 6.3.2. 1 N/A 0 Obsolete
Count	Reserved
LBA	Reserved
Device	<p>Bit Description</p> <ul style="list-style-type: none"> 7 Obsolete 6 N/A 5 Obsolete 4 Transport Dependent - See 6.2.11 3:0 Reserved
Status	<p>Bit Description</p> <ul style="list-style-type: none"> 7:6 Transport Dependent - See 6.2.11 5 Device Fault - See 6.2.6 4 N/A 3 Transport Dependent - See 6.2.11 2:1 N/A 0 Error - See 6.2.8

Reference: 7.53.5

Table 138 — SMART Error

Name	Description
Error	<p>Bit Description</p> <p>7:5 N/A</p> <p>4 ID Not Found - See 6.3.6.</p> <p>3 N/A</p> <p>2 Abort - See 6.3.2.</p> <p>1 N/A</p> <p>0 Obsolete</p>
Count	Reserved
LBA	<p>Bit Description</p> <p>27:24 N/A</p> <p>23:8</p> <p>Value Description</p> <p>C24Fh Subcommand specified a captive self-test and some error other than a self-test routine failure occurred (i.e., if the sub-command is not supported or field values are invalid)</p> <p>2CF4h the subcommand specified a captive self-test routine that has failed during execution.</p> <p>All Other Values the subcommand specified an off-line routine including an off-line self-test routine.</p> <p>7:0 N/A</p>
Device	<p>Bit Description</p> <p>7 Obsolete</p> <p>6 N/A</p> <p>5 Obsolete</p> <p>4 Transport Dependent - See 6.2.11</p> <p>3:0 Reserved</p>
Status	<p>Bit Description</p> <p>7:6 Transport Dependent - See 6.2.11.</p> <p>5 Device Fault - See 6.2.6</p> <p>4 N/A</p> <p>3 Transport Dependent - See 6.2.11.</p> <p>2:1 N/A</p> <p>0 Error - See 6.2.8</p>

Reference: 7.63, 7.64, 7.72, 7.73, 7.75

Table 139 — Write Extended Error

Name	Description
Error	<p>Bit Description</p> <ul style="list-style-type: none"> 7 Interface CRC - See 6.3.10 6:5 Obsolete. 4 ID Not Found - See 6.3.6 3 Obsolete 2 Abort - See 6.3.2 1 Obsolete 0 N/A
Count	Reserved
LBA	LBA of first unrecoverable error
Device	<p>Bit Description</p> <ul style="list-style-type: none"> 7 Obsolete 6 N/A 5 Obsolete 4 Transport Dependent - See 6.2.11 3:0 Reserved
Status	<p>Bit Description</p> <ul style="list-style-type: none"> 7:6 Transport Dependent - See 6.2.11 5 Device Fault - See 6.2.6 4 N/A 3 Transport Dependent - See 6.2.11 2:1 N/A 0 Error - See 6.2.8

Reference: 7.76

Table 140 — Write Stream Error

Name	Description
Error	<p>Bit Description</p> <ul style="list-style-type: none"> 7 Interface CRC - See 6.3.10 6:5 Obsolete 4 ID Not Found - See 6.3.6 3 Obsolete 2 Abort - See 6.3.2 1 Obsolete 0 Command Completion Time Out - See 6.3.4
Count	Length of Stream Error - number of contiguous logical sectors containing potentially bad data, beginning with the LBA of the first logical sector with an uncorrectable error
LBA	LBA of first unrecoverable error
Device	<p>Bit Description</p> <ul style="list-style-type: none"> 7 Obsolete 6 N/A 5 Obsolete 4 Transport Dependent - See 6.2.11 3:0 Reserved
Status	<p>Bit Description</p> <ul style="list-style-type: none"> 7:6 Transport Dependent - See 6.2.11. 5 Stream Error - See 6.2.10. 4 Deferred Write Error - See 6.2.5. 3 Transport Dependent - See 6.2.11. 2:1 N/A 0 Error - See 6.2.8.

Reference: 7.10.5

Table 141 — DCO Set Error

Name	Description
Error	<p>Bit Description</p> <p>7 Interface CRC - See 6.3.10</p> <p>6:3 N/A</p> <p>2 Abort - See 6.3.2</p> <p>1:0 N/A</p>
Count	Vendor Specific
LBA	<p>Bit Description</p> <p>27:24 N/A</p> <p>23:16 Word Location - If the command was aborted because an attempt was made to modify a bit that shall not be modified with the device in its current state, this field shall contain the offset of the first word encountered that the device shall not change. If an illegal maximum LBA is encountered, this field shall be set to 03h. If a checksum error occurred, this field shall be set to FFh. A value of 00h indicates that the Data Structure Revision was invalid.</p> <p>15:0 Bit Location - If the command was aborted because an attempt was made to disable at least one mode or feature that shall not be disabled with the device in its current state, this field shall contain an array of bits that correspond to the device configuration overlay data structure listed in Table 11 relative to the word indicated in bits (23:16) (i.e., Word Location). A one in this array indicates that the requested mode or feature shall not be disabled by the device. If the bit location is not reported, then the value shall be 0000h.</p>
Device	<p>Bit Description</p> <p>7 Obsolete</p> <p>6 N/A</p> <p>5 Obsolete</p> <p>4 Transport Dependent - See 6.2.11</p> <p>3:0 Reserved</p>
Status	<p>Bit Description</p> <p>7:6 Transport Dependent - See 6.2.11.</p> <p>5 Device Fault - See 6.2.6</p> <p>4 N/A</p> <p>3 Transport Dependent - See 6.2.11.</p> <p>2:1 N/A</p> <p>0 Error - See 6.2.8</p>

Reference: 7.21

Table 142 — NOP Error

Name	Description
Error	<p>Bit Description</p> <p>7:3 N/A</p> <p>2 Abort - See 6.3.2</p> <p>1:0 N/A</p>
Count	Initial Value
LBA	Initial Value
Device	<p>Bit Description</p> <p>7 Obsolete</p> <p>6 N/A</p> <p>5 Obsolete</p> <p>4 Transport Dependent - See 6.2.11</p> <p>3:0 Reserved</p>
Status	<p>Bit Description</p> <p>7:6 Transport Dependent - See 6.2.11.</p> <p>5 Device Fault - See 6.2.6</p> <p>4 N/A</p> <p>3 Transport Dependent - See 6.2.11.</p> <p>2:1 N/A</p> <p>0 Error - See 6.2.8</p>

Reference: 7.22

Table 143 — PACKET command Error

Name	Description
Error	<p>Bit Description</p> <p>7:4 Sense Key - See 6.3.12</p> <p>3 N/A</p> <p>2 Abort - See 6.3.2</p> <p>1 End of Media - See 6.3.5</p> <p>0 Illegal Length Indicator - See 6.3.7</p>
Interrupt Reason	<p>Bit Description</p> <p>7:3 Tag - See 6.4.5</p> <p>2 Release - See 6.4.4. Shall be cleared to zero</p> <p>1 Input/Output - See 6.4.3. Shall be set to one</p> <p>0 Command/Data - See 6.4.2. Shall be set to one</p>
LBA	N/A
Device	<p>Bit Description</p> <p>7 Obsolete</p> <p>6 N/A</p> <p>5 Obsolete</p> <p>4 Transport Dependent - See 6.2.11</p> <p>3:0 Reserved</p>
Status	<p>Bit Description</p> <p>7:6 Transport Dependent - See 6.2.11.</p> <p>5 N/A</p> <p>4 Service - See 6.2.9.</p> <p>3 Transport Dependent - See 6.2.11.</p> <p>2:1 N/A</p> <p>0 Check Condition - See 6.2.3.</p>

Reference: 7.26.5

Table 144 — Read DMA Queued Error

Name	Description
Error	<p>Bit Description</p> <ul style="list-style-type: none"> 7 Interface CRC - See 6.3.10 6 Uncorrectable Error - See 6.3.13 5 Obsolete 4 ID Not Found - See 6.3.6 3 Obsolete 2 Abort - See 6.3.2 1:0 Obsolete
Interrupt Reason	<p>Bit Description</p> <ul style="list-style-type: none"> 7:3 Tag - See 6.4.5. This field shall contain the Tag of the command being released. 2 Release - See 6.4.4. Shall be cleared to zero 1 Input/Output - See 6.4.3. Shall be set to one 0 Command/Data - See 6.4.2. Shall be set to one
LBA	LBA of first unrecoverable error
Device	<p>Bit Description</p> <ul style="list-style-type: none"> 7 Obsolete 6 N/A 5 Obsolete 4 Transport Dependent - See 6.2.11 3:0 Reserved
Status	<p>Bit Description</p> <ul style="list-style-type: none"> 7:6 Transport Dependent - See 6.2.11. 5 Device Fault - See 6.2.6 4 Service - See 6.2.9 3 Transport Dependent - See 6.2.11. 2:1 N/A 0 Error - See 6.2.8

Reference: 7.27

Table 145 — Read DMA Queued Extended Error

Name	Description
Error	<p>Bit Description</p> <ul style="list-style-type: none"> 7 Interface CRC - See 6.3.10 6 Uncorrectable Error - See 6.3.13 5 Obsolete 4 ID Not Found - See 6.3.6 3 Obsolete 2 Abort - See 6.3.2 1:0 Obsolete
Interrupt Reason	<p>Bit Description</p> <ul style="list-style-type: none"> 15:8 Reserved 7:3 Tag - See 6.4.5. This field shall contain the Tag of the command being released. 2 Release - See 6.4.4. Shall be cleared to zero 1 Input/Output - See 6.4.3. Shall be set to one 0 Command/Data - See 6.4.2. Shall be set to one
LBA	LBA of first unrecoverable error
Device	<p>Bit Description</p> <ul style="list-style-type: none"> 7 Obsolete 6 N/A 5 Obsolete 4 Transport Dependent - See 6.2.11 3:0 Reserved
Status	<p>Bit Description</p> <ul style="list-style-type: none"> 7:6 Transport Dependent - See 6.2.11. 5 Device Fault - See 6.2.6 4 Service - See 6.2.9 3 Transport Dependent - See 6.2.11. 2:1 N/A 0 Error - See 6.2.8

Reference:, 7.53.6, 7.53.7

Table 146 — SMART Read Log/SMART Read Data Error

Name	Description
Error	<p>Bit Description</p> <ul style="list-style-type: none"> 7 Interface CRC - See 6.3.10 6 Uncorrectable Error - See 6.3.13. 5 N/A 4 ID Not Found - See 6.3.6 3 N/A 2 Abort - See 6.3.2. 1 N/A 0 Obsolete
Count	N/A
LBA	N/A
Device	<p>Bit Description</p> <ul style="list-style-type: none"> 7 Obsolete 6 N/A 5 Obsolete 4 Transport Dependent - See 6.2.11 3:0 Reserved
Status	<p>Bit Description</p> <ul style="list-style-type: none"> 7:6 Transport Dependent - See 6.2.11. 5 Device Fault - See 6.2.6 4 N/A 3 Transport Dependent - See 6.2.11. 2:1 N/A 0 Error - See 6.2.8

Reference: 7.32, 7.36, 7.40

Table 147 — Read PIO Extended Error

Name	Description
Error	<p>Bit Description</p> <ul style="list-style-type: none"> 7 Interface CRC - See 6.3.10 6 Uncorrectable Error - See 6.3.13. 5 N/A 4 ID Not Found - See 6.3.6 3 N/A 2 Abort - See 6.3.2. 1 N/A 0 Obsolete
Count	Reserved
LBA	LBA of first unrecoverable error
Device	<p>Bit Description</p> <ul style="list-style-type: none"> 7 Obsolete 6 N/A 5 Obsolete 4 Transport Dependent - See 6.2.11 3:0 Reserved
Status	<p>Bit Description</p> <ul style="list-style-type: none"> 7:6 Transport Dependent - See 6.2.11. 5 Device Fault - See 6.2.6 4 N/A 3 Transport Dependent - See 6.2.11. 2:1 N/A 0 Error - See 6.2.8

Reference: 7.34

Table 148 — Read Native Max Extended Error

Name	Description
Error	<p>Bit Description</p> <p>7:3 N/A</p> <p>2 Abort - See 6.3.2.</p> <p>1 N/A</p> <p>0 Obsolete</p>
Count	Reserved
LBA	Reserved
Device	<p>Bit Description</p> <p>7 Obsolete</p> <p>6 N/A</p> <p>5 Obsolete</p> <p>4 Transport Dependent - See 6.2.11</p> <p>3:0 Reserved</p>
Status	<p>Bit Description</p> <p>7:6 Transport Dependent - See 6.2.11.</p> <p>5:1 N/A</p> <p>0 Error - See 6.2.8</p>

Reference: 7.50

Table 149 — SETMAX Extended Error

Name	Description
Error	<p>Bit Description</p> <p>7:5 N/A</p> <p>4 ID Not Found - See 6.3.6.</p> <p>3 N/A</p> <p>2 Abort - See 6.3.2.</p> <p>1 N/A</p> <p>0 Obsolete</p>
Count	Reserved
LBA	Reserved
Device	<p>Bit Description</p> <p>7 Obsolete</p> <p>6 N/A</p> <p>5 Obsolete</p> <p>4 Transport Dependent - See 6.2.11</p> <p>3:0 Reserved</p>
Status	<p>Bit Description</p> <p>7:6 Transport Dependent - See 6.2.11.</p> <p>5 Device Fault - See 6.2.6</p> <p>4 N/A</p> <p>3 Transport Dependent - See 6.2.11.</p> <p>2:1 N/A</p> <p>0 Error - See 6.2.8</p>

Reference: 7.71, 7.74

Table 150 — Write Error

Name	Description
Error	<p>Bit Description</p> <ul style="list-style-type: none"> 7 Interface CRC - See 6.3.10 6:5 Obsolete 4 ID Not Found - See 6.3.6 3 Obsolete 2 Abort - See 6.3.2. 1 Obsolete 0 N/A
Count	N/A
LBA	LBA of first unrecoverable error
Device	<p>Bit Description</p> <ul style="list-style-type: none"> 7 Obsolete 6 N/A 5 Obsolete 4 Transport Dependent - See 6.2.11 3:0 Reserved
Status	<p>Bit Description</p> <ul style="list-style-type: none"> 7:6 Transport Dependent - See 6.2.11. 5 Device Fault - See 6.2.6 4 N/A 3 Transport Dependent - See 6.2.11. 2:1 N/A 0 Error - See 6.2.8

Reference: 7.62

Table 151 — Write DMA Error

Name	Description
Error	<p>Bit Description</p> <ul style="list-style-type: none"> 7 Interface CRC - See 6.3.10 6:5 Obsolete 4 ID Not Found - See 6.3.6 3 Obsolete 2 Abort - See 6.3.2. 1:0 Obsolete
Count	N/A
LBA	LBA of first unrecoverable error
Device	<p>Bit Description</p> <ul style="list-style-type: none"> 7 Obsolete 6 N/A 5 Obsolete 4 Transport Dependent - See 6.2.11 3:0 Reserved
Status	<p>Bit Description</p> <ul style="list-style-type: none"> 7:6 Transport Dependent - See 6.2.11. 5 Device Fault - See 6.2.6 4 N/A 3 Transport Dependent - See 6.2.11. 2:1 N/A 0 Error - See 6.2.8

Reference: 7.65, 7.66

Table 152 — Write DMA Queued Error

Name	Description
Error	<p>Bit Description</p> <ul style="list-style-type: none"> 7 Interface CRC - See 6.3.10 6:5 Obsolete 4 ID Not Found - See 6.3.6 3 Obsolete 2 Abort - See 6.3.2 1:0 Obsolete
Interrupt Reason	<p>Bit Description</p> <ul style="list-style-type: none"> 7:3 Tag - See 6.4.5. This field shall contain the Tag of the command being released. 2 Release - See 6.4.4. Shall be cleared to zero 1 Input/Output - See 6.4.3. Shall be set to one 0 Command/Data - See 6.4.2. Shall be set to one
LBA	LBA of first unrecoverable error
Device	<p>Bit Description</p> <ul style="list-style-type: none"> 7 Obsolete 6 N/A 5 Obsolete 4 Transport Dependent - See 6.2.11 3:0 Reserved
Status	<p>Bit Description</p> <ul style="list-style-type: none"> 7:6 Transport Dependent - See 6.2.11. 5 Device Fault - See 6.2.6 4 Service - See 6.2.9 3 Transport Dependent - See 6.2.11. 2:1 N/A 0 Error - See 6.2.8

Reference: 7.20.3

Table 153 — NV Cache Add Abort Error

Name	Description
Error	<p>Bit Description</p> <ul style="list-style-type: none"> 7 Interface CRC - See 6.3.10 6:3 Reserved 2 Abort - See 6.3.2 1 Insufficient LBA Range Entries - See 6.3.8 0 Insufficient NV Cache space - See 6.3.9
Count	N/A
LBA	N/A
Device	<p>Bit Description</p> <ul style="list-style-type: none"> 7 Obsolete 6 N/A 5 Obsolete 4 Transport Dependent - See 6.2.11 3:0 Reserved
Status	<p>Bit Description</p> <ul style="list-style-type: none"> 7:6 Transport Dependent - See 6.2.11. 5 Device Fault - See 6.2.6 4 N/A 3 Transport Dependent - See 6.2.11. 2:1 N/A 0 Error - See 6.2.8

Reference: 7.20.9

Table 154 — NV Cache Remove Abort Error

Name	Description
Error	<p>Bit Description</p> <ul style="list-style-type: none"> 7 Interface CRC - See 6.3.10 6:3 Reserved 2 Abort - See 6.3.2 1 Reserved 0 Attempted partial range removal from the NV Cache pinned set - See 6.3.3
Count	N/A
LBA	N/A
Device	<p>Bit Description</p> <ul style="list-style-type: none"> 7 Obsolete 6 N/A 5 Obsolete 4 Transport Dependent - See 6.2.11 3:0 Reserved
Status	<p>Bit Description</p> <ul style="list-style-type: none"> 7:6 Transport Dependent - See 6.2.11. 5 Device Fault - See 6.2.6 4 N/A 3 Transport Dependent - See 6.2.11. 2:1 N/A 0 Error - See 6.2.8

Reference: 7.20.4, 7.20.5

Table 155 — NV Cache Abort Error

Name	Description
Error	<p>Bit Description</p> <ul style="list-style-type: none"> 7 Reserved 6:3 Reserved 2 Abort - See 6.3.2 1:0 Reserved
Count	N/A
LBA	N/A
Device	<p>Bit Description</p> <ul style="list-style-type: none"> 7 Obsolete 6 N/A 5 Obsolete 4 Transport Dependent - See 6.2.11 3:0 Reserved
Status	<p>Bit Description</p> <ul style="list-style-type: none"> 7:6 Transport Dependent - See 6.2.11. 5 Device Fault - See 6.2.6 4 N/A 3 Transport Dependent - See 6.2.11. 2:1 N/A 0 Error - See 6.2.8

Reference: 7.20.8, 7.20.7

Table 156 — NV Cache Abort with Data Transfer Error

Name	Description
Error	<p>Bit Description</p> <ul style="list-style-type: none"> 7 Interface CRC - See 6.3.10 6:3 Reserved 2 Abort - See 6.3.2 1:0 Reserved
Count	N/A
LBA	N/A
Device	<p>Bit Description</p> <ul style="list-style-type: none"> 7 Obsolete 6 N/A 5 Obsolete 4 Transport Dependent - See 6.2.11 3:0 Reserved
Status	<p>Bit Description</p> <ul style="list-style-type: none"> 7:6 Transport Dependent - See 6.2.11. 5 Device Fault - See 6.2.6 4 N/A 3 Transport Dependent - See 6.2.11. 2:1 N/A 0 Error - See 6.2.8

Reference: 7.28.6, 7.68.6

Table 157 — NCQ Command Acceptance Error

Name	Description
Error	<p>Bit Description</p> <ul style="list-style-type: none"> 7 Interface CRC - See 6.3.10. 6:3 N/A 2 Abort - See 6.3.2. 1:0 N/A
Count	N/A
LBA	N/A
Device	<p>Bit Description</p> <ul style="list-style-type: none"> 7:4 N/A 3:0 Reserved
Status	<p>Bit Description</p> <ul style="list-style-type: none"> 7:6 Transport Dependent - See 6.2.11. 5 Device Fault – See 6.2.6 4 N/A 3 Transport Dependent - See 6.2.11. 2:1 N/A 0 Error - See 6.2.8

Reference: 7.68.6

Table 158 — NCQ Write Command Aborted Error

Name	Description
SATA Status	Transport Dependent
Error	<p>Bit Description</p> <ul style="list-style-type: none"> 7 Interface CRC - See 6.3.10 6:5 Obsolete 4 ID Not Found - See 6.3.6 3 Obsolete 2 Abort - See 6.3.2 1:0 Obsolete
Status	<p>Bit Description</p> <ul style="list-style-type: none"> 7 Shall be cleared to zero 6 Transport Dependent - See 6.2.11 5 Device Fault – See 6.2.6 4 N/A 3 Shall be cleared to zero. 2:1 N/A 0 Error - See 6.2.8
SActive	31:0 Transport dependent completion indicator

Reference: 7.28.6

Table 159 — NCQ Read Command Aborted Error

Name	Description
SATA Status	Transport Dependent
Error	<p>Bit Description</p> <ul style="list-style-type: none"> 7 Interface CRC - See 6.3.10 6 Uncorrectable Error - See 6.3.13 5 Obsolete 4 ID Not Found - See 6.3.6 3 Obsolete 2 Abort - See 6.3.2 1:0 Obsolete
Status	<p>Bit Description</p> <ul style="list-style-type: none"> 7 Shall be cleared to zero 6 Transport Dependent - See 6.2.11 5 Device Fault – See 6.2.6 4 N/A 3 Shall be cleared to zero. 2:1 N/A 0 Error - See 6.2.8
SActive	31:0 Transport dependent completion indicator

Annex A
(Normative)

Log Definitions

A.1 Overview

This Annex provides a comprehensive description of all standardized logs. These logs are accessible via several commands (see 7.29, 7.30, 7.53.7, 7.53.9, 7.69, 7.70). Table A.2 is a summary of these logs. There are 3 terms associated with logs: names, addresses and pages. The log name is a term that describes the data in the associated log. Each log name has an associated numeric value that is the log address. The log address is used by read and write log commands to access a specific log. Each log is composed of one or more pages. Log pages shall be 512 bytes of data. Table A.1 illustrates the conceptual layout of several logs. The SMART READ LOG command and the SMART WRITE LOG command always start sending their data from the first page and allow the host to specify the number of log pages to be returned. GPL feature set commands allow the host to specify the starting log page number as well as the number of log pages to be returned.

Table A.1 — Example Log Structure

Log Name	Log Address	Log pages
Log Directory	00h	Page #0 (the Log Directory only has 1 512-byte page)
Host Vendor Specific	80h	Page #0 (first 512-byte log page)
		Page #1 (second 512-byte log page)
		...
		Page #15 (last 512-byte log page)
Host Vendor Specific	81h	Page #0 (first 512-byte log page)
		Page #1 (second 512-byte log page)
		...
		Page #15 (last 512-byte log page)
...		
Host Vendor Specific	9Fh	Page #0 (first 512-byte log page)
		Page #1 (second 512-byte log page)
		...
		Page #15 (last 512-byte log page)

Table A.2 — Log address definition

Log Address	Log Name	Feature Set	R/W	Access
00h	Log directory, see A.2 and A.3	N/A	RO	GPL,SL
01h	Summary SMART Error Log, see A.15	SMART	RO	SL
02h	Comprehensive SMART Error Log, see A.4	SMART	RO	SL
03h	Extended Comprehensive SMART Error Log, see A.7	SMART	RO	GPL
04h	Device Statistics, see A.5	N/A	RO	GPL,SL
05h	Reserved			
06h	SMART Self-Test Log, see A.14	SMART	RO	SL
07h	Extended SMART Self-Test Log, see A.8	SMART	RO	GPL
08h	Reserved	N/A	Reserved	
09h	Selective Self-Test Log, see A.13	SMART	R/W	SL
0Ah-0Fh	Reserved	N/A	Reserved	
10h	NCQ Command Error, see A.10	NCQ	RO	GPL
11h	SATA Phy Event Counters, see A.12	N/A	RO	GPL
12h-17h	Reserved for Serial ATA	N/A	Reserved	
18h-1Fh	Reserved	N/A	Reserved	
20h	Obsolete			
21h	Write Stream Error Log, see A.16	Streaming	RO	GPL
22h	Read Stream Error Log, see A.11	Streaming	RO	GPL
23h	Obsolete			
24h-7Fh	Reserved	N/A	Reserved	
80h-9Fh	Host Vendor Specific, see A.9	SMART	R/W	GPL,SL
A0h-DFh	Device Vendor Specific, see A.6	SMART	VS	GPL,SL
E0h	SCT Command/Status, see 8.1	SCT	R/W	GPL,SL
E1h	SCT Data Transfer, see 8.1	SCT	R/W	GPL,SL
E2h-FFh	Reserved	N/A		

Key -

RO - Log is read only.

R/W - Log is read or written.

VS - Log is vendor specific thus read/write ability is vendor specific.

GPL - General Purpose Logging

SL - SMART Logging

The device shall return command aborted if a GPL feature set command accesses a log that is marked only with SL.

The device shall return command aborted if a SMART feature set command accesses a log that is marked only with GPL.

A.2 General Purpose Log Directory (GPL Log Address 00h)

Table A.3 defines the 512 bytes that make up the General Purpose Log Directory.

Table A.3 — General Purpose Log Directory

Word	Description
0	General Purpose Logging Version (word)
1	Number of log pages at log address 01h (word)
2	Number of log pages at log address 02h (word)
3	Number of log pages at log address 03h (word)
4	Number of log pages at log address 04h (word)
...	
128	Number of log pages at log address 80h (word)
129	Number of log pages at log address 81h (word)
...	
255	Number of log pages at log address FFh (word)

The value of the General Purpose Logging Version word shall be 0001h. A value of 0000h indicates that no General Purpose Log Directory exists.

A.3 SMART Log Directory (SMART Logging Log Address 00h)

Table A.4 defines the 512-bytes that make up the optional SMART Log Directory. The SMART Log Directory is defined as one log page.

Table A.4 — SMART Log Directory

Byte	Description
0-1	SMART Logging Version (word)
2	Number of log pages at log address 1
3	Reserved
4	Number of log pages at log address 2
5	Reserved
...	...
510	Number of log pages at log address 255
511	Reserved

The value of the SMART Logging Version word shall be 0001h if the device supports multi-block SMART logs. If the device does not support multi-block SMART logs, then log address 00h is defined as reserved.

A.4 Comprehensive SMART Error Log (Log Address 02h)

A.4.1 Overview

Table A.5 defines the format of each of the log pages that are part of the Comprehensive SMART error log. The Comprehensive SMART error log provides logging for 28-bit addressing only. For 48-bit addressing, see A.7.

The maximum size of the SMART comprehensive error log shall be 51 log pages. Devices may support fewer than 51 log pages. The comprehensive error log data structures shall include, but is not limited to, Uncorrectable errors, ID Not Found errors for which the LBA requested was valid, servo errors, write fault errors. Comprehensive SMART Error Log data structures shall not include errors attributed to the receipt of faulty commands (e.g., command codes not supported by the device or requests with invalid parameters or invalid LBAs).

Table A.5 — Comprehensive error log

Byte	First Log Page	Subsequent Log Pages
0	SMART error log version	Reserved
1	Error log index	Reserved
2-91	First error log data structure	Data structure 5n+1
92-181	Second error log data structure	Data structure 5n+2
182-271	Third error log data structure	Data structure 5n+3
272-361	Fourth error log data structure	Data structure 5n+4
362-451	Fifth error log data structure	Data structure 5n+5
452-453	Device error count	Reserved
454-510	Reserved	Reserved
511	Data structure checksum	Data structure checksum
n is the n th log page within the log. The first log page is numbered zero.		

A.4.2 Error log version

The value of the error log version byte shall be set to 01h.

A.4.3 Error log index

The error log index indicates the error log data structure representing the most recent error. If there have been no error log entries, the error log index is set to zero. Valid values for the error log index are zero to 255.

A.4.4 Error log data structure

The error log is viewed as a circular buffer. The device may support from two to 51 error log blocks. When the last supported error log block has been filled, the next error shall create an error log data structure that replaces the first error log data structure in logical block zero. The next error after that shall create an error log data structure that replaces the second error log data structure in block zero. The sixth error after the log has filled shall replace the first error log data structure in block one, and so on.

The error log index indicates the most recent error log data structure. Unused error log data structures shall be filled with zeros.

The content of the error log data structure entries is defined in A.15.4.

A.4.5 Device error count

The Device Error Count field is defined in A.15.5.

A.4.6 Data structure checksum

The data structure checksum is defined in A.7.6.

A.5 Device Statistics (Log Address 04h)

A.5.1 Overview

The optional Device Statistics log contains selected statistics about the device. This log is supported if there is a non-zero length for log address 04h in the General Purpose Log Directory. The format of the data is defined in table A.6. If the Device Statistics log is supported, only the Structure Version field is required. Each statistic is composed of a 1-byte flag field and the statistic. If bit 63 is set to one then the statistic is supported. Each statistic shall be a multiple of 8 bytes long. The number of log pages may be greater than one.

A.5.2 Reserved (Page 00h, 02h-FFh)

A.5.3 General Statistics (Page 01h)

A.5.3.1 Overview

Device Statistics log page 01h contains general information about the device as described in table A.6.

Table A.6 — General Statistics

Offset	Type	Content
0-7	QWord	Structure Version Bit Meaning 63:16 Reserved 15:0 0001h
8-15	Qword	Lifetime Power-On Resets Bit Meaning 63:56 Flag 63 1 = Counter Supported, 0 = Counter not supported 62:56 Reserved 55:32 Reserved 31:0 Number of times that the device has processed a Power-On Reset event
16-511	Byte	Reserved

A.5.3.2 Structure Version

Structure version indicates the format of the structure for this page.

A.5.3.3 Lifetime Power-On Resets

A.5.3.3.1 Description

Lifetime Power-On Resets is a counter that records the number of times that the device has processed a power-on reset.

A.5.3.3.2 Update Interval

Lifetime Power-On Resets is incremented by one after processing each Power-On Reset and the device is capable of recording this statistic.

A.5.3.3.3 Measurement Units

Lifetime Power-On Resets is incremented by one for each Power-On Reset event.

A.5.3.3.4 Initialization

Lifetime Power-On Resets shall be initialized to zero at the time of manufacture.

A.6 Device Vendor Specific Logs (Log Addresses A0h-DFh)

Support for device vendor specific logs is optional. Device vendor specific logs may be used by the device vendor to store any data and need only be implemented if used.

A.7 Extended Comprehensive SMART Error log (Log Address 03h)

A.7.1 Overview

Table A.7 defines the format of each of the log pages that define the Extended Comprehensive SMART error log. The maximum size of the Extended Comprehensive SMART error log is 16,383 log pages. Devices may support fewer than 16,383 log pages. Error log data structures shall include, but are not limited to, Uncorrectable errors (see 6.3.13), ID Not Found errors (see 6.3.6) for which the LBA requested was valid, servo errors, write fault errors. Error log data structures shall not include errors attributed to the receipt of faulty commands (e.g., command codes not implemented by the device or requests with invalid parameters or invalid LBAs).

All 28-bit entries contained in the Comprehensive SMART log, defined under section A.4, shall also be included in the Extended Comprehensive SMART error log with the 48-bit entries.

Table A.7 — Extended Comprehensive SMART error log

Byte	First Log Page	Subsequent Log Pages
0	SMART error log version	Reserved
1	Reserved	Reserved
2-3	Error log index (word)	Reserved
4-127	First error log data structure	Data structure 4n+1
128-251	Second error log data structure	Data structure 4n+2
252-375	Third error log data structure	Data structure 4n+3
376-499	Fourth error log data structure	Data structure 4n+4
500-501	Device error count (word)	Reserved
502-510	Reserved	Reserved
511	Data structure checksum	Data structure checksum
n is the logical log page number within the log. The first log page is numbered zero		

A.7.2 Error log version

The value of the SMART error log version byte shall be 01h.

A.7.3 Error log index

The error log index is the error log data structure number representing the most recent error. If there have been no error log entries, the error log index is cleared to zero. Valid values for the error log index are zero to 65,535.

A.7.4 Extended Error log data structure

A.7.4.1 Overview

The Extended Comprehensive SMART error log is viewed as a circular buffer. When the last supported error log has been filled, the next error shall create an error log data structure that replaces the first error log data structure in log page zero. The next error after that shall create an error log data structure that replaces the second error log data structure in log page zero. The fifth error after the log has filled shall replace the first error log data structure in log page one, and so on.

The error log index indicates the most recent error log data structure. Unused error log data structures shall be filled with zeros.

The content of the error log data structure entries is defined in Table A.8.

Table A.8 — Extended Error log data structure

Byte	Description
n to n+17	First command data structure
n+18 to n+35	Second command data structure
n+36 to n+53	Third command data structure
n+54 to n+71	Fourth command data structure
n+72 to n+89	Fifth command data structure
n+90 to n+123	Error data structure

A.7.4.2 Command data structure

The fifth command data structure shall contain the command or reset for which the error is being reported. The fourth command data structure should contain the command or reset that preceded the command or reset for which the error is being reported, the third command data structure should contain the command or reset preceding the one in the fourth command data structure, etc. If fewer than four commands and resets preceded the command or reset for which the error is being reported, the unused command data structures shall be zero filled (e.g., if only three commands and resets preceded the command or reset for which the error is being reported, the first command data structure shall be zero filled). In some devices, the hardware implementation may preclude the device from reporting the commands that preceded the command for which the error is being reported or that preceded a reset. In this case, the command data structures are zero filled.

If the command data structure represents a command or software reset, the content of the command data structure shall be as shown in Table A.9. If the command data structure represents a hardware reset, the content

of byte n shall be FFh, the content of bytes n+1 through n+13 are vendor specific, and the content of bytes n+14 through n+17 shall contain the timestamp.

Table A.9 — Command data structure

Byte	Description
n	Content of the Device Control field when the Command was initiated.
n+1	Content of the Feature field (7:0) when the Command was initiated.
n+2	Content of the Feature field (15:8) when the Command was initiated.
n+3	Content of the Count field (7:0) when the Command was initiated.
n+4	Content of the Count field (15:8) when the Command was initiated.
n+5	Content of the LBA field (7:0) when the Command was initiated.
n+6	Content of the LBA field (31:24) when the Command was initiated.
n+7	Content of the LBA field (15:8) when the Command was initiated.
n+8	Content of the LBA field (39:32) when the Command was initiated.
n+9	Content of the LBA field (23:16) when the Command was initiated.
n+10	Content of the LBA field (47:40) when the Command was initiated.
n+11	Content of the Device field when the Command was initiated.
n+12	Content written to the Command field when the command was initiated
n+13	Reserved
n+14 to n+17	Timestamp (DWord)

Timestamp shall be the time since power-on in milliseconds when command acceptance occurred. This timestamp may wrap around.

A.7.4.3 Error data structure

The error data structure shall contain the error description of the command for which an error was reported as described in Table A.10. If the error was logged for a hardware reset, the content of bytes n+1 through n+11 shall be vendor specific and the remaining bytes shall be as defined in Table A.10.

Table A.10 — Error data structure

Byte	Description
n	Transport specific value when the Command was initiated. See the appropriate transport standard, reference Device Control field.
n+1	Content of the Error field (7:0) after command completion occurred.
n+2	Content of the Count field (7:0) after command completion occurred.
n+3	Content of the Count field (15:8) after command completion occurred.
n+4	Content of the LBA field (7:0) when the command completion occurred.
n+5	Content of the LBA field (31:24) when the command completion occurred.
n+6	Content of the LBA field (15:8) when the command completion occurred.
n+7	Content of the LBA field (39:32) when the command completion occurred.
n+8	Content of the LBA field (23:16) when the command completion occurred.
n+9	Content of the LBA field (47:40) when the command completion occurred.
n+10	Content of the Device field after command completion occurred.
n+11	Content written to the Status field after command completion occurred.
n+12 to n+30	Extended error information
n+31	State
n+32 to n+33	Life timestamp (word)

Extended error information shall be vendor specific.

State shall contain a value indicating the state of the device when the command was initiated or the reset occurred as described in Table A.11.

Table A.11 — State field values

Value	State
x0h	Unknown
x1h	Sleep
x2h	Standby
x3h	Active/Idle
x4h	Executing SMART off-line or self-test
x5h-xAh	Reserved
xBh-xFh	Vendor specific
The value of x is vendor specific and may be different for each state.	

Sleep indicates the reset for which the error being reported was received when the device was in the Sleep mode.

Standby indicates the command or reset for which the error being reported was received when the device was in the Standby mode.

Active/Idle indicates the command or reset for which the error being reported was received when the device was in the Active or Idle mode.

Executing SMART off-line or self-test indicates the command or reset for which the error being reported was received when the device was in the process of executing a SMART off-line or self-test.

Life timestamp shall contain the power-on lifetime of the device in hours when command completion occurred.

A.7.5 Device error count

The Device Error Count field shall contain the total number of errors attributable to the device that have been reported by the device during the life of the device (e.g., Uncorrectable errors (see 6.3.13), ID Not Found errors (see 6.3.6) for which the LBA requested was valid, servo errors, write fault errors). This count shall not include errors attributed to the receipt of faulty commands (e.g., command codes not implemented by the device or requests with invalid parameters or invalid LBAs). If the maximum value for this field is reached, the count shall remain at the maximum value when additional errors are encountered and logged.

A.7.6 Data structure checksum

The data structure checksum is the two's complement of the sum of the first 511 bytes in the data structure. Each byte shall be added with unsigned arithmetic, and overflow shall be ignored. The sum of all 512 bytes shall be zero when the checksum is correct. The checksum is placed in byte 511.

A.8 Extended SMART Self-Test Log (Log Address 07h)

A.8.1 Overview

Table A.12 defines the format of each of the log pages that define the Extended SMART Self-test log. The maximum size of the self-test log is 3,449 log pages. Devices may support fewer than 3,449 log pages.

The Extended SMART self-test log shall support 48-bit and 28-bit addressing. All 28-bit entries contained in the SMART self-test log, defined in A.14 shall also be included in the Extended SMART self-test log with all 48-bit entries.

Table A.12 — Extended Self-test log data structure

Byte	First Log Page	Subsequent Log Pages
0	Self-test log data structure revision number	Reserved
1	Reserved	Reserved
2-3	Self-test descriptor index (word)	Reserved
4-29	Descriptor entry 1	Descriptor entry 19n+1
30-55	Descriptor entry 2	Descriptor entry 19n+2
....
472-497	Descriptor entry 19	Descriptor entry 19n+19
498-499	Vendor specific	Vendor specific
500-510	Reserved	Reserved
511	Data structure checksum	Data structure checksum
n is the n th log page within the log. The first log page is number zero		

This log is viewed as a circular buffer. When the last supported Self-test log has been filled, the next self-test shall create a descriptor that replaces descriptor entry 1 in log page 0. The next self-test after that shall create a descriptor that replaces descriptor entry 2 in log page 0, and so on. All unused self-test descriptors shall be filled with zeros.

A.8.2 Self-test descriptor index

The Self-test descriptor index indicates the most recent self-test descriptor. If there have been no self-tests, the Self-test descriptor index is set to zero. Valid values for the Self-test descriptor index are zero to 65,535.

A.8.3 Self-test log data structure revision number

The value of the self-test log data structure revision number shall be 01h.

A.8.4 Extended Self-test log descriptor entry

The content of the self-test descriptor entry is shown in Table A.13.

Table A.13 — Extended Self-test log descriptor entry

Byte	Description
n	Content of the LBA field (7:0)
n+1	Content of the self-test execution status byte
n+2 to n+3	Life timestamp (word)
n+4	Content of the self-test failure checkpoint byte
n+5	Failing LBA (7:0)
n+6	Failing LBA (15:8)
n+7	Failing LBA (23:16)
n+8	Failing LBA (31:24)
n+9	Failing LBA (39:32)
n+10	Failing LBA (47:40)
n+11 to n+25	Vendor specific.

Content of the LBA field (7:0) shall be the content of the LBA field (7:0) when the nth self-test subcommand was issued (see 7.53.5.2).

Content of the self-test execution status byte shall be the content of the self-test execution status byte when the nth self-test was completed (see 7.53.6.8).

Life timestamp shall contain the power-on lifetime of the device in hours when the nth self-test subcommand was completed.

Content of the self-test failure checkpoint byte may contain additional information about the self-test that failed.

The failing LBA shall be the LBA of the logical sector that caused the test to fail. If the device encountered more than one failed logical sector during the test, this field shall indicate the LBA of the first failed logical sector encountered. If the test passed or the test failed for some reason other than a failed logical sector, the value of this field is undefined.

A.8.5 Data structure checksum

The data structure checksum is the two's complement of the sum of the first 511 bytes in the data structure. Each byte shall be added with unsigned arithmetic, and overflow shall be ignored. The sum of all 512 bytes is zero when the checksum is correct. The checksum is placed in byte 511.

A.9 Host Vendor Specific Logs (Log Addresses 80h-9Fh)

The mandatory Host Vendor Specific logs shall each contain sixteen log pages. The content of the Host Vendor Specific logs shall be common to all log commands. This means that if the host places data in a Host Vendor

Specific page using SMART WRITE LOG, and then issues a READ LOG EXT to the same page, that the host receives the same data that was originally stored by SMART WRITE LOG.

These host vendor specific logs may be used by the host to store any data desired. If a host vendor specific log has never been written by the host, when read the content of the log shall be zeros.

A.10 NCQ Command Error (Log Address 10h)

A.10.1 Overview

The NCQ Command Error log describes the most recent NCQ command failure, is one page in length, and is defined in table A.14. Devices supporting the NCQ feature set shall support log address 10h (i.e., NCQ Command Error).

Table A.14 — NCQ Command Error Log

Byte	Description
0	Bit Name 7 NQ (see A.10.3) 6:5 Reserved 4:0 NCQ Tag (see A.10.2)
1	Reserved
2	Status
3	Error
4	LBA (7:0)
5	LBA (15:8)
6	LBA (23:16)
7	Device
8	LBA (31:24)
9	LBA (39:32)
10	LBA (47:40)
11	Reserved
12	Count (7:0)
13	Count (15:8)
14-255	Reserved
256-510	Vendor Specific
511	Checksum

A.10.2 NCQ Tag

If the NQ bit is cleared, the NCQ Tag field contains the NCQ Tag corresponding to the NCQ command that failed.

A.10.3 NQ

If set indicates that the error condition was a result of a non-NCQ command having been issued and that the NCQ Tag field is therefore not valid. If cleared indicates that the NCQ Tag field is valid and that the error condition applies to a NCQ command.

A.10.4 Return Fields

The Status, Error, LBA and Count fields indicate the error that caused the device to stop processing NCQ commands.

NOTE 27 — The value returned in the Error field of the NCQ Command Error log may be different than the value returned in the Error field of the command Error Output structure when the initial error condition is signaled. The Error field in command Error Output structure is used for the purpose of signaling an error for an NCQ command, while the value in the Error field of the NCQ Command Error log provides specific information about the error condition.

A.10.5 Checksum

The data structure checksum is the two's complement of the sum of the first 511 bytes in the data structure. Each byte shall be added with 8-bit unsigned arithmetic and overflow shall be ignored. The sum of all 512 bytes of the data structure shall be zero.

A.11 Read Stream Error Log (Log Address 22h)

Table A.15 defines the format of the Read Stream Error log. Entries are placed into the Read Stream Error log only when the Stream Error bit is set to one in the Status field. The 512 bytes returned shall contain a maximum of 31 error entries. The Read Stream Error Count shall contain the total number of Read Stream Errors detected since the last successful completion of the READ LOG EXT command with LBA field (7:0) set to 22h. This error count may be greater than 31, but only the most recent 31 errors are represented by entries in the log. If the Read Stream Error Count reaches its maximum value, after the next error is detected the Read Stream Error Count shall remain at the maximum value. During processing of a READ LOG EXT command with the LBA field (7:0) set to 22h, a device shall clear the Read Stream Error Log and clear the Error Log Index and Read Stream Error Count to zero. When the Error Log Index is zero there are no error log entries. A device shall clear the content of the Read Stream Error Log during processing of a power-on reset. For a PATA device, the log is also cleared when processing a hardware reset. For a SATA device, the log is cleared on a hardware reset if Software Settings Preservation is disabled, otherwise it is preserved.

Table A.15 — Read Stream Error Log

Byte	Content
0	Structure Version
1	Error Log Index
2-3	Read Stream Error Log Count (word)
4-15	Reserved
16-31	Read Stream Error Log Entry #1
32-47	Read Stream Error Log Entry #2
48-63	Read Stream Error Log Entry #3
64-511	Read Stream Error Log Entries #4 through #31

The Data Structure Version field shall contain a value of 02h indicating the second revision of the structure format.

The Read Stream Error Log Count field shall contain the number of uncorrected logical sector entries currently reportable to the host. This value may exceed 31.

The Error Log Index indicates the error log data structure representing the most recent error. Only values 1 through 31 are valid.

Table A.16 defines the format of each entry in the Read Stream Error Log.

Table A.16 — Stream Error Log Entry

Byte	Value
0	Feature (7:0)
1	Feature (15:8)
2	Status
3	Error
4	LBA (7:0)
5	LBA (15:8)
6	LBA (23:16)
7	LBA (31:24)
8	LBA (39:32)
9	LBA (47:40)
10-11	Reserved
12	Count (7:0)
13	Count (15:8)
14	Reserved
15	Reserved

Byte 0-1 contains the contents of the Feature field when the error occurred. In the Write Stream Error Log, this value shall be set to FFFFh for a deferred write error.

Byte 2 contains the contents of the Status field when the error occurred.

Byte 3 contains the contents of the Error field when the error occurred.

Bytes 4-9 indicate the starting LBA of the error.

Bytes 12-13 contains the contents of the Count field which indicates the length of the error. Each entry may describe a range of logical sectors starting at the given LBA and spanning the specified number of logical sectors.

A.12 SATA Phy Event Counters (Log Address 11h)

A.12.1 Overview

The SATA Phy Event Counters log is one log page in length. The first Dword of the log page contains information that applies to the rest of the log page. Software should continue to process counters until a counter identifier with value 0h is found or the entire page has been read. A counter identifier with value 0h indicates that the log page contains no more counter values past that point. The SATA Phy Event Counters log is defined in table A.17.

Table A.17 — SATA Phy Event Counters Format

Byte	Description
0-3	Reserved
4-5	Counter 0 Identifier (word)
6 to Counter 0 Length+5	Counter 0 Value
...
n to n+1	Counter x Identifier (word)
n+2 to Counter x Length+n+1	Counter x Value
...	...
508-510	Reserved
511	Checksum

There are two mechanisms by which the host explicitly causes the Phy counters to be reset. The first mechanism is to issue a BIST Activate FIS to the device. Upon reception of a BIST Activate FIS the device shall reset all Phy event counters to their reset value.

The second mechanism uses the READ LOG EXT command. When the device receives a command to read The SATA Phy Event Counters log and bit 0 in the Feature field is set to one, the device shall return the current counter values for the command and then reset all Phy event counter values.

See SATA 2.6 for more information.

A.12.2 Counter x Identifier

Phy event counter identifier that corresponds to Counter n Value. Specifies the particular event counter that is being reported. The Identifier is 16 bits in length. Valid identifiers are listed in SATA 2.6.

A.12.3 Counter x Value

Value of the Phy event counter that corresponds to Counter x Identifier. The number of significant bits is determined by Counter x Identifier bits (14:12), see SATA 2.6 for more information. The length of Counter x Value shall always be a multiple of 16-bits. All counters are one-extended (e.g., if a counter is only physically implemented as 8-bits when it reaches the maximum value of FFh, it shall be one-extended to FFFFh). The counter shall stop, and not wrap to zero, after reaching its maximum value.

A.12.4 Counter x Length

Size of the SATA Phy event counter as defined by bits (14:12) of Counter n Identifier. The size of the Phy event counter shall be a multiple of 16-bits.

A.12.5 Checksum

The data structure checksum is the 2's complement of the sum of the first 511 bytes in the data structure. Each byte shall be added with unsigned arithmetic and overflow shall be ignored. The sum of all 512 bytes of the data structure is zero when the checksum is correct.

A.13 Selective Self-Test Log (Log Address 09h)

A.13.1 Overview

The Selective self-test log is a log that may be both written and read by the host. This log allows the host to select the parameters for the self-test and to monitor the progress of the self-test. Table A.18 defines the content of the Selective self-test log.

Table A.18 — Selective self-test log

Byte	Type	Description	Read/Write
0-1	Word	Data structure revision number	R/W
2-9	Qword	Starting LBA for test span 1	R/W
10-17	Qword	Ending LBA for test span 1	R/W
18-25	Qword	Starting LBA for test span 2	R/W
26-33	Qword	Ending LBA for test span 2	R/W
34-41	Qword	Starting LBA for test span 3	R/W
42-49	Qword	Ending LBA for test span 3	R/W
50-57	Qword	Starting LBA for test span 4	R/W
58-65	Qword	Ending LBA for test span 4	R/W
66-73	Qword	Starting LBA for test span 5	R/W
74-81	Qword	Ending LBA for test span 5	R/W
82-337		Reserved	Reserved
338-491		Vendor specific	Vendor specific
492-499	Qword	Current LBA under test	Read ^a
500-501	Word	Current span under test	Read ^a
502-503	Word	Feature flags	R/W
504-507		Vendor specific	Vendor specific
508-509	Word	Selective self-test pending time	R/W
510		Reserved	Reserved
511		Data structure checksum	R/W
^a Fields marked Read shall be ignored by the device when the host writes them.			

A.13.2 Data structure revision number

The value of the data structure revision number shall be 01h. This value shall be written by the host and returned unmodified by the device.

A.13.3 Test span definition

The Selective self-test log provides for the definition of up to five test spans. The starting LBA for each test span is the LBA of the first logical sector tested in the test span and the ending LBA for each test span is the last LBA tested in the test span. If the starting and ending LBA values for a test span are both zero, a test span is not defined and not tested. These values shall be written by the host and returned unmodified by the device.

A.13.4 Current LBA under test

As the self-test progresses, the device shall modify this value to contain the beginning LBA of the 65,536 logical sector block currently being tested. When the self-test including the off-line scan between test spans has been completed, a zero value shall be placed in this field.

A.13.5 Current span under test

As the self-test progresses, the device shall modify this value to contain the test span number of the current span being tested. If an off-line scan between test spans is selected, a value greater than five is placed in this field during the off-line scan. When the self-test including the off-line scan between test spans has been completed, a zero value shall be placed in this field.

A.13.6 Feature flags

The Feature flags define the features of Selective self-test to be processed (see table A.19).

Table A.19 — Selective self-test feature flags

Bit	Description
5-15	Reserved.
4	When set to one, off-line scan after selective test is active.
3	When set to one, off-line scan after selective test is pending.
2	Vendor specific
1	When set to one, perform off-line scan after selective test.
0	Vendor specific

Bit (1) shall be written by the host and returned unmodified by the device. Bits (4:3) shall be written as zeros by the host and the device shall modify them as the test progresses.

A.13.7 Selective self-test pending time

The selective self-test pending time is the time in minutes from power-on to the resumption of the off-line testing if the pending bit is set. At the expiration of this time, the device sets the active bit (i.e., Selective self-test feature flags bit 4) to one, and resumes the off-line scan that had begun before power-down.

A.13.8 Data structure checksum

The data structure checksum is defined in A.15.6.

A.14 SMART Self-Test Log (Log Address 06h)

A.14.1 Overview

Table A.20 defines the log page that make up the SMART self-test log. The SMART Self-Test log supports 28-bit addressing only.

Table A.20 — Self-test log data structure

Byte	Description
0-1	Self-test log data structure revision number
2-25	First descriptor entry
26-49	Second descriptor entry
.....
482-505	Twenty-first descriptor entry
506-507	Vendor specific
508	Self-test index
509-510	Reserved
511	Data structure checksum

This log is viewed as a circular buffer. The first entry shall begin at byte 2, the second entry shall begin at byte 26, and so on until the twenty-second entry, that shall replace the first entry. Then, the twenty-third entry shall replace the second entry, and so on. If fewer than 21 self-tests have been performed by the device, the unused descriptor entries shall be filled with zeroes.

A.14.2 Self-test log data structure revision number

The value of the self-test log data structure revision number shall be 0001h.

A.14.3 Self-test log descriptor entry

The content of the self-test descriptor entry is shown in table A.21.

Table A.21 — Self-test log descriptor entry

Byte	Description
n	Content of the LBA field (7:0)
n+1	Content of the self-test execution status byte
n+2 to n+3	Life timestamp (word)
n+4	Content of the self-test failure checkpoint byte
n+5	Failing LBA (7:0)
n+6	Failing LBA (15:8)
n+7	Failing LBA (23:16)
n+8	Failing LBA (27:24)
n+9 to n+23	Vendor specific

Content of the LBA field (7:0) shall be the content of the LBA field (7:0) when the nth self-test subcommand was issued (see 7.53.5.2).

Content of the self-test execution status byte shall be the content of the self-test execution status byte when the nth self-test was completed (see 7.53.6.8).

Life timestamp shall contain the power-on lifetime of the device in hours when the nth self-test subcommand was completed.

Content of the self-test failure checkpoint byte may contain additional information about the self-test that failed.

The failing LBA shall be the LBA of the uncorrectable logical sector that caused the test to fail. If the device encountered more than one uncorrectable logical sector during the test, this field shall indicate the LBA of the first uncorrectable logical sector encountered. If the test passed or the test failed for some reason other than an uncorrectable logical sector, the value of this field is undefined.

A.14.4 Self-test index

The self-test index shall point to the most recent entry. Initially, when the log is empty, the index shall be set to zero. It shall be set to one when the first entry is made, two for the second entry, etc., until the 22nd entry, when the index shall be reset to one.

A.14.5 Data structure checksum

The data structure checksum is the two's complement of the sum of the first 511 bytes in the data structure. Each byte shall be added with unsigned arithmetic, and overflow shall be ignored. The sum of all 512 bytes is zero when the checksum is correct. The checksum is placed in byte 511.

A.15 Summary SMART Error Log (Log Address 01h)

A.15.1 Overview

Table A.22 defines the log page that makes up the SMART summary error log. Summary SMART Error log data structures shall include, but are not limited to, Uncorrectable errors, ID Not Found errors for which the LBA requested was valid, servo errors, write fault errors. Summary error log data structures shall not include errors attributed to the receipt of faulty commands (e.g., command codes not implemented by the device or requests with invalid parameters or invalid LBAs). If the device supports the Comprehensive SMART Error log, then the Summary SMART Error log duplicates the last five error entries in the Comprehensive SMART Error log. The Summary SMART Error log supports 28-bit addressing only.

Table A.22 — Summary SMART Error log

Byte	Description
0	SMART error log version
1	Error log index
2-91	First error log data structure
92-181	Second error log data structure
182-271	Third error log data structure
272-361	Fourth error log data structure
362-451	Fifth error log data structure
452-453	Device error count (word)
454-510	Reserved
511	Data structure checksum

A.15.2 Error log version

The value of the Summary SMART Error log version byte shall be 01h.

A.15.3 Error log index

The error log index indicates the error log data structure representing the most recent error. Only values zero through five are valid. If there are no error log entries, the value of the error log index shall be zero.

A.15.4 Error log data structure

A.15.4.1 Overview

An error log data structure shall be presented for each of the last five errors reported by the device. These error log data structure entries are viewed as a circular buffer. That is, the first error shall create the first error log data structure; the second error, the second error log structure; etc. The sixth error shall create an error log data structure that replaces the first error log data structure; the seventh error replaces the second error log structure, etc. The error log pointer indicates the most recent error log structure. If fewer than five errors have occurred, the unused error log structure entries shall be zero filled. Table A.23 describes the content of a valid error log data structure.

Table A.23 — Error log data structure

Byte	Description
n - n+11	First command data structure
n+12 - n+23	Second command data structure
n+24 - n+35	Third command data structure
n+36 - n+47	Fourth command data structure
n+48 - n+59	Fifth command data structure
n+60 - n+89	Error data structure

A.15.4.2 Command data structure

The fifth command data structure shall contain the command or reset for which the error is being reported. The fourth command data structure should contain the command or reset that preceded the command or reset for which the error is being reported, the third command data structure should contain the command or reset preceding the one in the fourth command data structure, etc. If fewer than four commands and resets preceded the command or reset for which the error is being reported, the unused command data structures shall be zero filled (e.g., if only three commands and resets preceded the command or reset for which the error is being reported, the first command data structure shall be zero filled). In some devices, the hardware implementation may preclude the device from reporting the commands that preceded the command for which the error is being reported or that preceded a reset. In this case, the command data structures are zero filled.

If the command data structure represents a command or software reset, the content of the command data structure shall be as shown in table A.24. If the command data structure represents a hardware reset, the

content of byte n shall be FFh, the content of bytes n+1 through n+7 are vendor specific, and the content of bytes n+8 through n+11 shall contain the timestamp.

Table A.24 — Command data structure

Byte	Description
n	Transport specific value when the Command was initiated. See the appropriate transport standard, reference Device Control field.
n+1	Content of the Feature (7:0) when the Command was initiated
n+2	Content of the Count (7:0) when the Command was initiated
n+3	Content of the LBA field (7:0) when the Command was initiated
n+4	Content of the LBA field (15:8) when the Command was initiated
n+5	Content of the LBA field (23:16) when the Command was initiated
n+6	Content of the Device field when the Command was initiated
n+7	Content written when the Command was initiated
n+8 to n+11	Timestamp (DWord)

Timestamp shall be the time since power-on in milliseconds when command acceptance occurred. This timestamp may wrap around.

A.15.4.3 Error data structure

The error data structure shall contain the error description of the command for which an error was reported as described in table A.24. If the error was logged for a hardware reset, the content of bytes n+1 through n+7 shall be vendor specific and the remaining bytes shall be as defined in table A.25.

Table A.25 — Error data structure

Byte	Description
n	Reserved
n+1	Content of the Error (7:0) after command completion occurred
n+2	Content of the Count (7:0) after command completion occurred
n+3	Content of the LBA field (7:0) after command completion occurred
n+4	Content of the LBA field (15:8) after command completion occurred
n+5	Content of the LBA field (23:16) after command completion occurred
n+6	Content of the Device field after command completion occurred
n+7	Content written to the Status field after command completion occurred
n+8 to n+26	Extended error information
n+27	State
n+28 to n+29	Life timestamp (word)

Extended error information shall be vendor specific.

State shall contain a value indicating the state of the device when the command was initiated or the reset occurred as described in table A.26.

Table A.26 — State field values

Value	State
x0h	Unknown
x1h	Sleep
x2h	Standby
x3h	Active/Idle
x4h	Executing SMART off-line or self-test
x5h-xAh	Reserved
xBh-xFh	Vendor specific
The value of x is vendor specific and may be different for each state.	

Sleep indicates the reset for which the error being reported was received when the device was in the Sleep mode.

Standby indicates the command or reset for which the error being reported was received when the device was in the Standby mode.

Active/Idle indicates the command or reset for which the error being reported was received when the device was in the Active or Idle mode.

Executing SMART off-line or self-test indicates the command or reset for which the error being reported was received when the device was in the process of executing a SMART off-line or self-test.

Life timestamp shall contain the power-on lifetime of the device in hours when command completion occurred.

A.15.5 Device error count

The Device Error Count field shall contain the total number of errors attributable to the device that have been reported by the device during the life of the device (e.g., these errors shall include Uncorrectable errors, ID Not Found errors for which the LBA requested was valid, servo errors, write fault errors). This count shall not include errors attributed to the receipt of faulty commands (e.g., command codes not implemented by the device or requests with invalid parameters or invalid LBAs). If the maximum value for this field is reached, the count shall remain at the maximum value when additional errors are encountered and logged.

A.15.6 Data structure checksum

The data structure checksum is the two's complement of the sum of the first 511 bytes in the data structure. Each byte shall be added with unsigned arithmetic, and overflow shall be ignored. The sum of all 512 bytes shall be zero when the checksum is correct. The checksum is placed in byte 511.

A.16 Write Stream Error Log (Log Address 21h)

Table A.27 defines the format of the Write Stream Error log. Entries are placed into the Write Stream Error log only when the Stream Error bit is set to one in the Status field. The log page shall contain a maximum of 31 error entries. The Write Stream Error Count shall contain the total number of Write Stream Errors detected since the last successful reading of the Write Stream Error log. This error count may be greater than 31, but only the most recent 31 errors are represented by entries in the log. If the Write Stream Error Count reaches its maximum value, then after the next error is detected the Write Stream Error Count shall remain at the maximum value. When the Write Stream Error log has been read by the host, the device shall clear the Write Stream Error Log and clear the Error Log Index and Write Stream Error Count to zero. When the Error Log Index is zero, there are no entries in the Write Stream Error Log. A device shall clear the content of the Write Stream Error Log during

processing of a power-on reset. For a PATA device, the log is also cleared when processing a hardware reset. For a SATA device, the log is cleared on a hardware reset if Software Settings Preservation is disabled, otherwise it is preserved.

Table A.27 — Write Stream Error Log

Byte	Content
0	Structure Version
1	Error Log Index
2-3	Write Stream Error Log Count (word)
4-15	Reserved
16-31	Write Stream Error Log Entry #1
32-47	Write Stream Error Log Entry #2
48-63	Write Stream Error Log Entry #3
64-511	Write Stream Error Log Entries #4 through #31

The Data Structure Version field shall contain a value of 02h indicating the second revision of the structure format.

The Write Stream Error Log Count field shall contain the number of WRITE STREAM command entries since the last power-on reset, hardware reset, or since this log was last read.

The Error Log Index indicates the error log data structure representing the most recent error. Only values 1 through 31 are valid.

Table A.16 defines the format of each Write Stream Error Log Entry.

Annex B
(Informative)

Command Set summary

The following four tables are provided to facilitate the understanding of the command set. Table B.1 provides information on which command codes are currently defined. Table B.2 provides a list of all of the commands in order of command code with the required use for each. Table B.3 provides a summary of all commands in alphabetical order with the required use for each. Table B.4 documents the assignment history of each opcode by ATA standard. Table B.5 documents the assignment history of each SET FEATURES code by ATA standard.

Table B.1 — Command Matrix

	x0h	x1h	x2h	x3h	x4h	x5h	x6h	x7h	x8h	x9h	xAh	xBh	xCh	xDh	xEh	xFh
0xh	C	R	R	C	R	R	R	R	C	R	R	R	R	R	R	R
1xh	O	E	E	E	E	E	E	E	E	E	E	E	E	E	E	E
2xh	C	O	O	O	C	C	C	C	R	C	C	C	R	R	R	C
3xh	C	O	O	O	C	C	C	C	C	C	C	C	O	C	C	C
4xh	C	O	C	R	R	C*	R	C*	R	R	R	R	R	R	R	R
5xh	O	C*	R	R	R	R	R	C*	R	R	R	C*	C*	C*	C*	C*
6xh	C*	C*	S	S	S	S	S	S	R	R	R	R	R	R	R	R
7xh	O	E	E	E	E	E	E	E	E	E	E	E	E	E	E	E
8xh	V	V	V	V	V	V	V	F	V	V	V	V	V	V	V	V
9xh	C	O	C	R	E	E	E	E	E	E	V	R	R	R	R	R
Axh	C	C	C	R	R	R	R	R	R	R	R	R	R	R	R	R
Bxh	C	C	R	R	R	R	C*	R	A	A	A	R	R	R	R	R
Cxh	F	V	V	V	C	C	C	C	C	O	C	O	C	C	C	R
Dxh	R	C	M	M	M	R	R	R	R	R	O*	E	E	E	O*	O*
Ex h	C	C	C	C	C	C	C	C	C	E	C	R	C	O	O	C
Fxh	V	C	C	C	C	C	C	V	C	C	V	V	V	V	V	V

Key:

- C = defined command.
- R = Reserved, undefined in current specifications.
- V = Vendor specific commands.
- O = Obsolete.
- E = retired command.
- F= If the device does not implement the CFA feature set, this command code is Vendor specific.
- A= Reserved for assignment by the CompactFlash Association
- M = Reserved for the Media Card Pass Through Command feature set.
- S = Reserved for Serial ATA
- * indicates that the entry in this table has changed from ATA/ATAPI-7.

Table B.2 — Command codes (sorted by command code) (part 1 of 4)

Command	Command Code	General Feature Set	PACKET Feature Set	Protocol	Argument
NOP	00h	O	M	ND	28-bit
Reserved	01h-02h				
CFA REQUEST EXTENDED ERROR	03h	O	N	ND	28-bit
Reserved	04h-07h				
DEVICE RESET	08h	N	M	DR	28-bit
Reserved	09h-0Fh				
Obsolete	10h				
Retired	11h-1Fh				
READ SECTOR(S)	20h	M	M	PI	28-bit
Obsolete	21h-23h				
READ SECTOR(S) EXT	24h	O	N	PI	48-bit
READ DMA EXT	25h	O	N	DM	48-bit
READ DMA QUEUED EXT	26h	O	N	DMQ	48-bit
READ NATIVE MAX ADDRESS EXT	27h	O	N	ND	48-bit
Reserved	28h				
READ MULTIPLE EXT	29h	O	N	PI	48-bit
READ STREAM DMA EXT	2Ah	O	N	DM	48-bit
READ STREAM EXT	2Bh	O	N	PI	48-bit
Reserved	2Ch-2Fh				
READ LOG EXT	2Fh	O	O	PI	48-bit
WRITE SECTOR(S)	30h	M	N	PO	28-bit
Obsolete	31h-33h				
WRITE SECTOR(S) EXT	34h	O	N	PO	48-bit
WRITE DMA EXT	35h	O	N	DM	48-bit
WRITE DMA QUEUED EXT	36h	O	N	DMQ	48-bit
SET MAX ADDRESS EXT	37h	O	N	ND	48-bit
CFA WRITE SECTORS WITHOUT ERASE	38h	O	N	PO	28-bit
WRITE MULTIPLE EXT	39h	O	N	PO	48-bit
WRITE STREAM DMA EXT	3Ah	O	N	DM	48-bit
WRITE STREAM EXT	3Bh	O	N	PO	48-bit
Obsolete	3Ch				
WRITE DMA FUA EXT	3Dh	O	N	DM	48-bit
WRITE DMA QUEUED FUA EXT	3Eh	O	N	DMQ	48-bit
WRITE LOG EXT	3Fh	O	O	PO	48-bit
Key:					
ND = Non-Data command		M = Mandatory			
PI = PIO Data-In command		O = Optional			
PO = PIO Data-Out command		N = Use prohibited			
DM = DMA command		V = Vendor specific implementation			
DMQ = DMA QUEUED command		E = Retired			
DR = DEVICE RESET command		B = Obsolete			
DD = EXECUTE DEVICE DIAGNOSTIC command		R = Reserved			
P = PACKET command		F = If the device does not implement the CFA feature set, this command code is Vendor specific.			
VS = Vendor specific					

Table B.2 — Command codes (sorted by command code) (part 2 of 4)

Command	Command Code	General Feature Set	PACKET Feature Set	Protocol	Argument																		
READ VERIFY SECTOR(S)	40h	M	N	ND	28-bit																		
Obsolete	41h																						
READ VERIFY SECTOR(S) EXT	42h	O	N	ND	48-bit																		
Reserved	43h-44h																						
WRITE UNCORRECTABLE EXT	45h	O	N	ND	48-bit																		
Reserved	46h																						
READ LOG DMA EXT	47h	O	O	DM	48-bit																		
Reserved	48h-4Fh																						
Obsolete	50h																						
CONFIGURE STREAM	51h	O	O	ND	48-bit																		
Reserved	52h-56h																						
WRITE LOG DMA EXT	57h	O	O	DM	48-bit																		
Reserved	58h-5Ah																						
TRUSTED NON-DATA	5Bh	O	P	ND	28-bit																		
TRUSTED RECEIVE	5Ch	O	P	PI	28-bit																		
TRUSTED RECEIVE DMA	5Dh	O	P	DM	28-bit																		
TRUSTED SEND	5Eh	O	P	PO	28-bit																		
TRUSTED SEND DMA	5Fh	O	P	DM	28-bit																		
READ FPDMA QUEUED	60h	O	N	DMQ	48-bit																		
WRITE FPDMA QUEUED	61h	O	N	DMQ	48-bit																		
Reserved	62h-6Fh																						
Obsolete	70h																						
Retired	71h-7Fh																						
Vendor Specific	80h-86h			VS																			
CFA TRANSLATE SECTOR	87h	O	N	PI	28-bit																		
Vendor Specific	88h-8Fh			VS																			
EXECUTE DEVICE DIAGNOSTIC	90h	M	M	DD	28-bit																		
Obsolete	91h																						
DOWNLOAD MICROCODE	92h	O	N	PO	28-bit																		
Reserved	93h																						
Retired	94h-99h																						
Vendor Specific	9Ah																						
Reserved	9Bh-9Fh																						
PACKET	A0h	N	M	P																			
IDENTIFY PACKET DEVICE	A1h	N	M	PI	28-bit																		
<p>Key:</p> <table> <tr> <td>ND = Non-Data command</td> <td>M = Mandatory</td> </tr> <tr> <td>PI = PIO Data-In command</td> <td>O = Optional</td> </tr> <tr> <td>PO = PIO Data-Out command</td> <td>N = Use prohibited</td> </tr> <tr> <td>DM = DMA command</td> <td>V = Vendor specific implementation</td> </tr> <tr> <td>DMQ = DMA QUEUED command</td> <td>E = Retired</td> </tr> <tr> <td>DR = DEVICE RESET command</td> <td>B = Obsolete</td> </tr> <tr> <td>DD = EXECUTE DEVICE DIAGNOSTIC command</td> <td>R = Reserved</td> </tr> <tr> <td>P = PACKET command</td> <td>F = If the device does not implement the CFA feature set, this command code is Vendor specific.</td> </tr> <tr> <td>VS = Vendor specific</td> <td></td> </tr> </table>						ND = Non-Data command	M = Mandatory	PI = PIO Data-In command	O = Optional	PO = PIO Data-Out command	N = Use prohibited	DM = DMA command	V = Vendor specific implementation	DMQ = DMA QUEUED command	E = Retired	DR = DEVICE RESET command	B = Obsolete	DD = EXECUTE DEVICE DIAGNOSTIC command	R = Reserved	P = PACKET command	F = If the device does not implement the CFA feature set, this command code is Vendor specific.	VS = Vendor specific	
ND = Non-Data command	M = Mandatory																						
PI = PIO Data-In command	O = Optional																						
PO = PIO Data-Out command	N = Use prohibited																						
DM = DMA command	V = Vendor specific implementation																						
DMQ = DMA QUEUED command	E = Retired																						
DR = DEVICE RESET command	B = Obsolete																						
DD = EXECUTE DEVICE DIAGNOSTIC command	R = Reserved																						
P = PACKET command	F = If the device does not implement the CFA feature set, this command code is Vendor specific.																						
VS = Vendor specific																							

Table B.2 — Command codes (sorted by command code) (part 3 of 4)

Command	Command Code	General Feature Set	PACKET Feature Set	Protocol	Argument
SERVICE	A2h	O	O	P/DMQ	
Reserved	A3h-AFh				
SMART	B0h	O	N	ND	
Device Configuration Overlay	B1h	O	O	ND	28-bit
Reserved	B2h-B5h				
NV Cache	B6h	O	N	DM/ND	48-bit
Reserved for the CompactFlash Association	B7h-BBh				
Reserved	BCh-BFh				
CFA ERASE SECTORS	C0h	F	N	ND	28-bit
Vendor Specific	C1h-C3h			VS	
READ MULTIPLE	C4h	M	N	PI	28-bit
WRITE MULTIPLE	C5h	M	N	PO	28-bit
SET MULTIPLE MODE	C6h	M	N	ND	28-bit
READ DMA QUEUED	C7h	O	N	DMQ	28-bit
READ DMA	C8h	M	N	DM	28-bit
Obsolete	C9h				
WRITE DMA	CAh	M	N	DM	28-bit
Obsolete	CBh				
WRITE DMA QUEUED	CCh	O	N	DMQ	28-bit
CFA WRITE MULTIPLE WITHOUT ERASE	CDh	O	N	PO	28-bit
WRITE MULTIPLE FUA EXT	CEh	O	N	PO	48-bit
Reserved	CFh				
Reserved	D0h				
CHECK MEDIA CARD TYPE	D1h	O	N	ND	28-bit
Reserved for the Media Card Pass Through Command feature set	D2h				
Reserved for the Media Card Pass Through Command feature set	D3h				
Reserved for the Media Card Pass Through Command feature set	D4h				
Reserved	D5h-D9h				
Obsolete	DAh				
Retired	DBh-DDh				
Obsolete	DEh				
Obsolete	DFh				
STANDBY IMMEDIATE	E0h	M	M	ND	28-bit

Key:

ND = Non-Data command	M = Mandatory
PI = PIO Data-In command	O = Optional
PO = PIO Data-Out command	N = Use prohibited
DM = DMA command	V = Vendor specific implementation
DMQ = DMA QUEUED command	E = Retired
DR = DEVICE RESET command	B = Obsolete
DD = EXECUTE DEVICE DIAGNOSTIC command	R = Reserved
P = PACKET command	F = If the device does not implement the CFA feature set, this command code is Vendor specific.
VS = Vendor specific	

Table B.2 — Command codes (sorted by command code) (part 4 of 4)

Command	Command Code	General Feature Set	PACKET Feature Set	Protocol	Argument
IDLE IMMEDIATE	E1h	M	M	ND	28-bit
STANDBY	E2h	M	O	ND	28-bit
IDLE	E3h	M	O	ND	28-bit
READ BUFFER	E4h	O	N	PI	28-bit
CHECK POWER MODE	E5h	M	M	ND	28-bit
SLEEP	E6h	M	M	ND	28-bit
FLUSH CACHE	E7h	M	O	ND	28-bit
WRITE BUFFER	E8h	O	N	PO	28-bit
Retired	E9h				
FLUSH CACHE EXT	EAh	O	N	ND	28-bit
Reserved	EBh				
IDENTIFY DEVICE	ECh	M	M	PI	28-bit
Obsolete	EDh				
Obsolete	EEh				
SET FEATURES	EFh	M	M	ND	28-bit
Vendor Specific	F0h			VS	
SECURITY SET PASSWORD	F1h	O	O	PO	28-bit
SECURITY UNLOCK	F2h	O	O	PO	28-bit
SECURITY ERASE PREPARE	F3h	O	O	ND	28-bit
SECURITY ERASE UNIT	F4h	O	O	PO	28-bit
SECURITY FREEZE LOCK	F5h	O	O	ND	28-bit
SECURITY DISABLE PASSWORD	F6h	O	O	PO	28-bit
Vendor Specific	F7h				
READ NATIVE MAX ADDRESS	F8h	O	O	ND	28-bit
SET MAX ADDRESS	F9h	O	O	ND	28-bit
Vendor Specific	FAh-FFh			VS	
Key:					
ND = Non-Data command		M = Mandatory			
PI = PIO Data-In command		O = Optional			
PO = PIO Data-Out command		N = Use prohibited			
DM = DMA command		V = Vendor specific implementation			
DMQ = DMA QUEUED command		E = Retired			
DR = DEVICE RESET command		B = Obsolete			
DD = EXECUTE DEVICE DIAGNOSTIC command		R = Reserved			
P = PACKET command		F = If the device does not implement the CFA feature set, this command code is Vendor specific.			
VS = Vendor specific					

Table B.3 — Command codes (sorted by command name) (part 1 of 3)

Command	Command Code	General Feature Set	PACKET Feature Set	Protocol	Argument
CFA ERASE SECTORS	C0h	F	N	ND	28-bit
CFA REQUEST EXTENDED ERROR	03h	O	N	ND	28-bit
CFA TRANSLATE SECTOR	87h	O	N	PI	28-bit
CFA WRITE MULTIPLE WITHOUT ERASE	CDh	O	N	PO	28-bit
CFA WRITE SECTORS WITHOUT ERASE	38h	O	N	PO	28-bit
CHECK MEDIA CARD TYPE	D1h	O	N	ND	28-bit
CHECK POWER MODE	E5h	M	M	ND	28-bit
CONFIGURE STREAM	51h	O	O	ND	48-bit
Device Configuration Overlay	B1h	O	O	ND	28-bit
DEVICE RESET	08h	N	M	DR	28-bit
DOWNLOAD MICROCODE	92h	O	N	PO	28-bit
EXECUTE DEVICE DIAGNOSTIC	90h	M	M	DD	28-bit
FLUSH CACHE	E7h	M	O	ND	28-bit
FLUSH CACHE EXT	EAh	O	N	ND	28-bit
IDENTIFY DEVICE	ECh	M	M	PI	28-bit
IDENTIFY PACKET DEVICE	A1h	N	M	PI	28-bit
IDLE	E3h	M	O	ND	28-bit
IDLE IMMEDIATE	E1h	M	M	ND	28-bit
NOP	00h	O	M	ND	28-bit
NV Cache	B6h	O	N	DM/ND	48-bit
Obsolete	10h,21h-23h, 31h-33h,3Ch, 41h, 50h, 70h, 91h, C9h, CBh, DAh, DEh, DFh, EDh, EEh				
PACKET	A0h	N	M	P	
READ BUFFER	E4h	O	N	PI	28-bit
READ DMA	C8h	M	N	DM	28-bit
READ DMA EXT	25h	O	N	DM	48-bit
READ DMA QUEUED	C7h	O	N	DMQ	28-bit
READ DMA QUEUED EXT	26h	O	N	DMQ	48-bit
READ FPDMA QUEUED	60h	O	N	DMQ	48-bit
READ LOG DMA EXT	47h	O	O	DM	48-bit
READ LOG EXT	2Fh	O	O	PI	48-bit
READ MULTIPLE	C4h	M	N	PI	28-bit
READ MULTIPLE EXT	29h	O	N	PI	48-bit
READ NATIVE MAX ADDRESS	F8h	O	O	ND	28-bit
Key:					
ND = Non-Data command		M = Mandatory			
PI = PIO Data-In command		O = Optional			
PO = PIO Data-Out command		N = Use prohibited			
DM = DMA command		V = Vendor specific implementation			
DMQ = DMA QUEUED command		E = Retired			
DR = DEVICE RESET command		B = Obsolete			
DD = EXECUTE DEVICE DIAGNOSTIC command		R = Reserved			
P = PACKET command		F = If the device does not implement the CFA feature set, this command code is Vendor specific.			
VS = Vendor specific					

Table B.3 — Command codes (sorted by command name) (part 2 of 3)

Command	Command Code	General Feature Set	PACKET Feature Set	Protocol	Argument
READ NATIVE MAX ADDRESS EXT	27h	O	N	ND	48-bit
READ SECTOR(S)	20h	M	M	PI	28-bit
READ SECTOR(S) EXT	24h	O	N	PI	48-bit
READ STREAM DMA EXT	2Ah	O	N	DM	48-bit
READ STREAM EXT	2Bh	O	N	PI	48-bit
READ VERIFY SECTOR(S)	40h	M	N	ND	28-bit
READ VERIFY SECTOR(S) EXT	42h	O	N	ND	48-bit
Reserved	01h-02h, 04h-07h, 09h-0Fh, 28h, 2Ch-2Fh, 43h-44h, 46h, 48h-4Fh, 52h-56h, 58h-5Ah, 62h-6Fh, 93h, 9Bh-9Fh, A3h-AFh, B2h-B5h, BCh-BFh, CFh-D0h, D5h-D9h, EBh				
Reserved for the Media Card Pass Through Command feature set	D2h-D4h				
Reserved for the CompactFlash Association	B7h-BBh				
Retired	11h-1Fh, 71h-7Fh, 94h-99h, DBh-DDh, E9h				
SECURITY DISABLE PASSWORD	F6h	O	O	PO	28-bit
SECURITY ERASE PREPARE	F3h	O	O	ND	28-bit
SECURITY ERASE UNIT	F4h	O	O	PO	28-bit
SECURITY FREEZE LOCK	F5h	O	O	ND	28-bit
SECURITY SET PASSWORD	F1h	O	O	PO	28-bit
SECURITY UNLOCK	F2h	O	O	PO	28-bit
SERVICE	A2h	O	O	P/DMQ	
SET FEATURES	EFh	M	M	ND	28-bit
SET MAX ADDRESS	F9h	O	O	ND	28-bit
SET MAX ADDRESS EXT	37h	O	N	ND	48-bit
SET MULTIPLE MODE	C6h	M	N	ND	28-bit
SLEEP	E6h	M	M	ND	28-bit
SMART	B0h	O	N	ND	
STANDBY	E2h	M	O	ND	28-bit
STANDBY IMMEDIATE	E0h	M	M	ND	28-bit
TRUSTED NON-DATA	5Bh	O	P	ND	28-bit
TRUSTED RECEIVE	5Ch	O	P	PI	28-bit
TRUSTED RECEIVE DMA	5Dh	O	P	DM	28-bit
TRUSTED SEND	5Eh	O	P	PO	28-bit
Key:	<p> ND = Non-Data command PI = PIO Data-In command PO = PIO Data-Out command DM = DMA command DMQ = DMA QUEUED command DR = DEVICE RESET command DD = EXECUTE DEVICE DIAGNOSTIC command P = PACKET command VS = Vendor specific </p> <p> M = Mandatory O = Optional N = Use prohibited V = Vendor specific implementation E = Retired B = Obsolete R = Reserved F = If the device does not implement the CFA feature set, this command code is Vendor specific. </p>				

Table B.3 — Command codes (sorted by command name) (part 3 of 3)

Command	Command Code	General Feature Set	PACKET Feature Set	Protocol	Argument
TRUSTED SEND DMA	5Fh	O	P	DM	28-bit
Vendor Specific	80h-86h, 88h-8Fh, 9Ah, C1h-C3h, F0h, F7h, FAh-FFh				
WRITE BUFFER	E8h	O	N	PO	28-bit
WRITE DMA	CAh	M	N	DM	28-bit
WRITE DMA EXT	35h	O	N	DM	48-bit
WRITE DMA FUA EXT	3Dh	O	N	DM	48-bit
WRITE DMA QUEUED	CCh	O	N	DMQ	28-bit
WRITE DMA QUEUED EXT	36h	O	N	DMQ	48-bit
WRITE DMA QUEUED FUA EXT	3Eh	O	N	DMQ	48-bit
WRITE FPDMA QUEUED	61h	O	N	DMQ	48-bit
WRITE LOG DMA EXT	57h	O	O	DM	48-bit
WRITE LOG EXT	3Fh	O	O	PO	48-bit
WRITE MULTIPLE	C5h	M	N	PO	28-bit
WRITE MULTIPLE EXT	39h	O	N	PO	48-bit
WRITE MULTIPLE FUA EXT	CEh	O	N	PO	48-bit
WRITE SECTOR(S)	30h	M	N	PO	28-bit
WRITE SECTOR(S) EXT	34h	O	N	PO	48-bit
WRITE STREAM DMA EXT	3Ah	O	N	DM	48-bit
WRITE STREAM EXT	3Bh	O	N	PO	48-bit
WRITE UNCORRECTABLE EXT	45h	O	N	ND	48-bit
Key:					
ND = Non-Data command		M = Mandatory			
PI = PIO Data-In command		O = Optional			
PO = PIO Data-Out command		N = Use prohibited			
DM = DMA command		V = Vendor specific implementation			
DMQ = DMA QUEUED command		E = Retired			
DR = DEVICE RESET command		B = Obsolete			
DD = EXECUTE DEVICE DIAGNOSTIC command		R = Reserved			
P = PACKET command		F = If the device does not implement the CFA feature set, this command code is Vendor specific.			
VS = Vendor specific					

Table B.4 — Historical Command Assignments (part 1 of 8)

Opcode	Command Name	ATA1	ATA2	ATA3	ATA4	ATA5	ATA6	ATA7	ATA8
00h	NOP	C	C	C	C	C	C	C	C
01h		R	R	R	R	R	R	R	R
02h		R	R	R	R	R	R	R	R
03h	CFA REQUEST EXTENDED ERROR	R	R	R	C	C	C	C	C
04h		R	R	R	R	R	R	R	R
05h		R	R	R	R	R	R	R	R
06h		R	R	R	R	R	R	R	R
07h		R	R	R	R	R	R	R	R
08h	ATAPI Soft Reset / DEVICE RESET	R	R	C	C	C	C	C	C
09h		R	R	R	R	R	R	R	R
0Ah		R	R	R	R	R	R	R	R
0Bh		R	R	R	R	R	R	R	R
0Ch		R	R	R	R	R	R	R	R
0Dh		R	R	R	R	R	R	R	R
0Eh		R	R	R	R	R	R	R	R
0Fh		R	R	R	R	R	R	R	R
10h	RECALIBRATE	C	C	C	O	O	O	O	O
11h	RECALIBRATE	C	C	O	E	E	E	E	E
12h	RECALIBRATE	C	C	O	E	E	E	E	E
13h	RECALIBRATE	C	C	O	E	E	E	E	E
14h	RECALIBRATE	C	C	O	E	E	E	E	E
15h	RECALIBRATE	C	C	O	E	E	E	E	E
16h	RECALIBRATE	C	C	O	E	E	E	E	E
17h	RECALIBRATE	C	C	O	E	E	E	E	E
18h	RECALIBRATE	C	C	O	E	E	E	E	E
19h	RECALIBRATE	C	C	O	E	E	E	E	E
1Ah	RECALIBRATE	C	C	O	E	E	E	E	E
1Bh	RECALIBRATE	C	C	O	E	E	E	E	E
1Ch	RECALIBRATE	C	C	O	E	E	E	E	E
1Dh	RECALIBRATE	C	C	O	E	E	E	E	E
1Eh	RECALIBRATE	C	C	O	E	E	E	E	E
1Fh	RECALIBRATE	C	C	O	E	E	E	E	E
Key:		<p>A = Reserved for assignment by the CompactFlash Association</p> <p>F = If the device does not implement the CFA feature set, this command code is Vendor specific.</p> <p>M = Reserved for the Media Card Pass Through Command feature set.</p> <p>S = Reserved for Serial ATA.</p> <p>*Indicates this definition is new to ATA8.</p>							
C = a defined command.									
E = a retired command.									
O = Obsolete.									
R = Reserved, undefined in current specifications.									
V = Vendor specific commands.									

Table B.4 — Historical Command Assignments (part 2 of 8)

Opcode	Command Name	ATA1	ATA2	ATA3	ATA4	ATA5	ATA6	ATA7	ATA8
20h	READ SECTORS	C	C	C	C	C	C	C	C
21h	READ SECTORS WITHOUT RETRY	C	C	C	C	O	O	O	O
22h	READ LONG	C	C	C	O	O	O	O	O
23h	READ LONG WITHOUT RETRY	C	C	C	O	O	O	O	O
24h	READ SECTORS EXT	R	R	R	R	R	C	C	C
25h	READ DMA EXT	R	R	R	R	R	C	C	C
26h	READ DMA QUEUED EXT	R	R	R	R	R	C	C	C
27h	READ NATIVE MAX ADDRESS EXT	R	R	R	R	R	C	C	C
28h		R	R	R	R	R	R	R	R
29h	READ MULTIPLE EXT	R	R	R	R	R	C	C	C
2Ah	READ STREAM DMA	R	R	R	R	R	R	C	C
2Bh	READ STREAM	R	R	R	R	R	R	C	C
2Ch		R	R	R	R	R	R	R	R
2Dh		R	R	R	R	R	R	R	R
2Eh		R	R	R	R	R	R	R	R
2Fh	READ LOG EXT	R	R	R	R	R	C	C	C
30h	WRITE SECTORS	C	C	C	C	C	C	C	C
31h	WRITE SECTORS WITHOUT RETRY	C	C	C	C	O	O	O	O
32h	WRITE LONG	C	C	C	O	O	O	O	O
33h	WRITE LONG WITHOUT RETRY	C	C	C	O	O	O	O	O
34h	WRITE SECTORS EXT	R	R	R	R	O	C	C	C
35h	WRITE DMA EXT	R	R	R	R	R	C	C	C
36h	WRITE DMA QUEUED EXT	R	R	R	R	R	C	C	C
37h	SET NATIVE MAX ADDRESS EXT	R	R	R	R	R	C	C	C
38h	CFA WRITE SECTORS WITHOUT ERASE	R	R	R	C	C	C	C	C
39h	WRITE MULTIPLE EXT	R	R	R	R	R	C	C	C
3Ah	WRITE STREAM DMA	R	R	R	R	R	R	C	C
3Bh	WRITE STREAM	R	R	R	R	R	R	C	C
3Ch	WRITE VERIFY	C	C	C	O	O	O	O	O
3Dh	WRITE DMA FUA EXT	R	R	R	R	R	R	C	C
3Eh	WRITE DMA QUEUED FUA EXT	R	R	R	R	R	R	C	C
Key:		<p>A = Reserved for assignment by the CompactFlash Association F = If the device does not implement the CFA feature set, this command code is Vendor specific. M = Reserved for the Media Card Pass Through Command feature set. S = Reserved for Serial ATA. *Indicates this definition is new to ATA8.</p>							
C = a defined command. E = a retired command. O = Obsolete. R = Reserved, undefined in current specifications. V = Vendor specific commands.									

Table B.4 — Historical Command Assignments (part 3 of 8)

Opcode	Command Name	ATA1	ATA2	ATA3	ATA4	ATA5	ATA6	ATA7	ATA8
3Fh	WRITE LOG EXT	R	R	R	R	R	C	C	C
40h	READ VERIFY SECTORS	C	C	C	C	C	C	C	C
41h	READ VERIFY SECTORS WITHOUT RETRY	C	C	C	C	O	O	O	O
42h	READ VERIFY SECTORS EXT	R	R	R	R	R	C	C	C
43h		R	R	R	R	R	R	R	R
44h		R	R	R	R	R	R	R	R
45h	WRITE UNCORRECTABLE EXT	R	R	R	R	R	R	R	C*
46h		R	R	R	R	R	R	R	R
47h	READ LOG DMA EXT	R	R	R	R	R	R	R	C*
48h		R	R	R	R	R	R	R	R
49h		R	R	R	R	R	R	R	R
4Ah		R	R	R	R	R	R	R	R
4Bh		R	R	R	R	R	R	R	R
4Ch		R	R	R	R	R	R	R	R
4Dh		R	R	R	R	R	R	R	R
4Eh		R	R	R	R	R	R	R	R
4Fh		R	R	R	R	R	R	R	R
50h	FORMAT TRACK	C	C	C	O	O	O	O	O
51h	CONFIGURE STREAM	R	R	R	R	R	R	C	C
52h		R	R	R	R	R	R	R	R
53h		R	R	R	R	R	R	R	R
54h		R	R	R	R	R	R	R	R
55h		R	R	R	R	R	R	R	R
56h		R	R	R	R	R	R	R	R
57h	WRITE LOG DMA EXT	R	R	R	R	R	R	R	C*
58h		R	R	R	R	R	R	R	R
59h		R	R	R	R	R	R	R	R
5Ah		R	R	R	R	R	R	R	R
5Bh	TRUSTED NON-DATA	R	R	R	R	R	R	R	C*
5Ch	TRUSTED RECEIVE	R	R	R	R	R	R	R	C*
5Dh	TRUSTED RECEIVE DMA	R	R	R	R	R	R	R	C*
5Eh	TRUSTED SEND	R	R	R	R	R	R	R	C*
5Fh	TRUSTED SEND DMA	R	R	R	R	R	R	R	C*
60h	READ FPDMA QUEUED	R	R	R	R	R	R	S	C*
Key:		<p>A = Reserved for assignment by the CompactFlash Association F = If the device does not implement the CFA feature set, this command code is Vendor specific. M = Reserved for the Media Card Pass Through Command feature set. S = Reserved for Serial ATA. *Indicates this definition is new to ATA8.</p>							
C = a defined command. E = a retired command. O = Obsolete. R = Reserved, undefined in current specifications. V = Vendor specific commands.									

Table B.4 — Historical Command Assignments (part 4 of 8)

Opcode	Command Name	ATA1	ATA2	ATA3	ATA4	ATA5	ATA6	ATA7	ATA8
61h	WRITE FPDMA QUEUED	R	R	R	R	R	R	S	C*
62h	SATA (reserved)	R	R	R	R	R	R	S	S
63h	SATA (reserved)	R	R	R	R	R	R	S	S
64h	SATA (reserved)	R	R	R	R	R	R	S	S
65h	SATA (reserved)	R	R	R	R	R	R	S	S
66h	SATA (reserved)	R	R	R	R	R	R	S	S
67h	SATA (reserved)	R	R	R	R	R	R	S	S
68h		R	R	R	R	R	R	S	S
69h		R	R	R	R	R	R	S	S
6Ah		R	R	R	R	R	R	S	S
6Bh		R	R	R	R	R	R	S	S
6Ch		R	R	R	R	R	R	S	S
6Dh		R	R	R	R	R	R	S	S
6Eh		R	R	R	R	R	R	S	S
6Fh		R	R	R	R	R	R	S	S
70h	SEEK	C	C	C	C	C	C	O	O
71h	SEEK	C	C	O	E	E	E	E	E
72h	SEEK	C	C	O	E	E	E	E	E
73h	SEEK	C	C	O	E	E	E	E	E
74h	SEEK	C	C	O	E	E	E	E	E
75h	SEEK	C	C	O	E	E	E	E	E
76h	SEEK	C	C	O	E	E	E	E	E
77h	SEEK	C	C	O	E	E	E	E	E
78h	SEEK	C	C	O	E	E	E	E	E
79h	SEEK	C	C	O	E	E	E	E	E
7Ah	SEEK	C	C	O	E	E	E	E	E
7Bh	SEEK	C	C	O	E	E	E	E	E
7Ch	SEEK	C	C	O	E	E	E	E	E
7Dh	SEEK	C	C	O	E	E	E	E	E
7Eh	SEEK	C	C	O	E	E	E	E	E
7Fh	SEEK	C	C	O	E	E	E	E	E
80h	(vendor specific)	V	V	V	V	V	V	V	V
81h	(vendor specific)	V	V	V	V	V	V	V	V
82h	(vendor specific)	V	V	V	V	V	V	V	V
83h	(vendor specific)	V	V	V	V	V	V	V	V
Key:		<p>A = Reserved for assignment by the CompactFlash Association F = If the device does not implement the CFA feature set, this command code is Vendor specific. M = Reserved for the Media Card Pass Through Command feature set. S = Reserved for Serial ATA. *Indicates this definition is new to ATA8.</p>							
C = a defined command. E = a retired command. O = Obsolete. R = Reserved, undefined in current specifications. V = Vendor specific commands.									

Table B.4 — Historical Command Assignments (part 5 of 8)

Opcode	Command Name	ATA1	ATA2	ATA3	ATA4	ATA5	ATA6	ATA7	ATA8
84h	(vendor specific)	V	V	V	V	V	V	V	V
85h	(vendor specific)	V	V	V	V	V	V	V	V
86h	(vendor specific)	V	V	V	V	V	V	V	V
87h	(vendor specific) / CFA TRANSLATE SECTOR	V	V	V	F	F	F	F	F
88h	(vendor specific)	V	V	V	V	V	V	V	V
89h	(vendor specific)	V	V	V	V	V	V	V	V
8Ah	(vendor specific)	V	V	V	V	V	V	V	V
8Bh	(vendor specific)	V	V	V	V	V	V	V	V
8Ch	(vendor specific)	V	V	V	V	V	V	V	V
8Dh	(vendor specific)	V	V	V	V	V	V	V	V
8Eh	(vendor specific)	V	V	V	V	V	V	V	V
8Fh	(vendor specific)	V	V	V	V	V	V	V	V
90h	EXECUTE DEVICE DIAGNOSTICS	C	C	C	C	C	C	C	C
91h	INITIALIZE DEVICE PARAMETERS	C	C	C	C	C	O	O	O
92h	DOWNLOAD MICROCODE	R	C	C	C	C	C	C	C
93h		R	R	R	R	R	R	R	R
94h	STANDBY IMMEDIATE	C	C	C	E	E	E	E	E
95h	IDLE IMMEDIATE	C	C	C	E	E	E	E	E
96h	STANDBY	C	C	C	E	E	E	E	E
97h	IDLE	C	C	C	E	E	E	E	E
98h	CHECK POWER MODE	C	C	C	E	E	E	E	E
99h	SLEEP	C	C	C	E	E	E	E	E
9Ah	(vendor specific)	V	V	V	V	V	V	V	V
9Bh		R	R	R	R	R	R	R	R
9Ch		R	R	R	R	R	R	R	R
9Dh		R	R	R	R	R	R	R	R
9Eh		R	R	R	R	R	R	R	R
9Fh		R	R	R	R	R	R	R	R
A0h	PACKET	R	R	C	C	C	C	C	C
A1h	IDENTIFY PACKET DEVICE	R	R	C	C	C	C	C	C
A2h	SERVICE	R	R	C	C	C	C	C	C
A3h		R	R	R	R	R	R	R	R
Key:		<p>A = Reserved for assignment by the CompactFlash Association F = If the device does not implement the CFA feature set, this command code is Vendor specific. M = Reserved for the Media Card Pass Through Command feature set. S = Reserved for Serial ATA. *Indicates this definition is new to ATA8.</p>							
<p>C = a defined command. E = a retired command. O = Obsolete. R = Reserved, undefined in current specifications. V = Vendor specific commands.</p>									

Table B.4 — Historical Command Assignments (part 6 of 8)

Opcode	Command Name	ATA1	ATA2	ATA3	ATA4	ATA5	ATA6	ATA7	ATA8
A4h		R	R	R	R	R	R	R	R
A5h		R	R	R	R	R	R	R	R
A6h		R	R	R	R	R	R	R	R
A7h		R	R	R	R	R	R	R	R
A8h		R	R	R	R	R	R	R	R
A9h		R	R	R	R	R	R	R	R
AAh		R	R	R	R	R	R	R	R
ABh		R	R	R	R	R	R	R	R
ACH		R	R	R	R	R	R	R	R
ADh		R	R	R	R	R	R	R	R
Aeh		R	R	R	R	R	R	R	R
Afh		R	R	R	R	R	R	R	R
B0h	SMART	R	R	C	C	C	C	C	C
B1h	CFA DEVICE CONFIGURATION	R	R	R	R	R	C	C	C
B2h		R	R	R	R	R	R	R	R
B3h		R	R	R	R	R	R	R	R
B4h		R	R	R	R	R	R	R	R
B5h		R	R	R	R	R	R	R	R
B6h	NV CACHE	R	R	R	R	R	R	R	C*
B7h	Reserved for the CompactFlash Association	R	R	R	R	R	R	R	R
B8h	Reserved for the CompactFlash Association	R	R	R	R	A	A	A	A
B9h	Reserved for the CompactFlash Association	R	R	R	R	A	A	A	A
BAh	Reserved for the CompactFlash Association	R	R	R	R	A	A	A	A
BBh	Reserved for the CompactFlash Association	R	R	R	R	A	A	A	A
BCh	Reserved	R	R	R	R	A	A	A	R
BDh	Reserved	R	R	R	R	A	A	A	R
BEh	Reserved	R	R	R	R	A	A	A	R
Bfh	Reserved	R	R	R	R	A	A	A	R
C0h	(vendor specific) / CFA ERASE SECTORS	V	V	V	F	F	F	F	F
C1h	(vendor specific)	V	V	V	V	V	V	V	V
Key: C = a defined command. E = a retired command. O = Obsolete. R = Reserved, undefined in current specifications. V = Vendor specific commands.		A = Reserved for assignment by the CompactFlash Association F = If the device does not implement the CFA feature set, this command code is Vendor specific. M = Reserved for the Media Card Pass Through Command feature set. S = Reserved for Serial ATA. *Indicates this definition is new to ATA8.							

Table B.4 — Historical Command Assignments (part 7 of 8)

Opcode	Command Name	ATA1	ATA2	ATA3	ATA4	ATA5	ATA6	ATA7	ATA8
C2h	(vendor specific)	V	V	V	V	V	V	V	V
C3h	(vendor specific)	V	V	V	V	V	V	V	V
C4h	READ MULTIPLE	C	C	C	C	C	C	C	C
C5h	WRITE MULTIPLE	C	C	C	C	C	C	C	C
C6h	SET MULTIPLE MODE	C	C	C	C	C	C	C	C
C7h	READ DMA QUEUED	R	R	R	C	C	C	C	C
C8h	READ DMA	C	C	C	C	C	C	C	C
C9h	READ DMA WITHOUT RETRIES	C	C	C	C	O	O	O	O
CAh	WRITE DMA	C	C	C	C	C	C	C	C
CBh	WRITE DMA WITHOUT RETRIES	C	C	C	C	O	O	O	O
CCh	WRITE DMA QUEUED	R	R	R	C	C	C	C	C
CDh	CFA WRITE MULTIPLE WITHOUT ERASE	R	R	R	C	C	C	C	C
CEh	WRITE MULTIPLE FUA EXT	R	R	R	R	R	R	C	C
CFh		R	R	R	R	R	R	R	R
D0h		R	R	R	R	R	R	R	R
D1h	CHECK MEDIA CARD TYPE	R	R	R	R	R	C	C	C
D2h	Reserved for the Media Card Pass Through Command feature set	R	R	R	R	R	M	M	M
D3h	Reserved for the Media Card Pass Through Command feature set	R	R	R	R	R	M	M	M
D4h	Reserved for the Media Card Pass Through Command feature set	R	R	R	R	R	M	M	M
D5h		R	R	R	R	R	R	R	R
D6h		R	R	R	R	R	R	R	R
D7h		R	R	R	R	R	R	R	R
D8h		R	R	R	R	R	R	R	R
D9h		R	R	R	R	R	R	R	R
DAh	GET MEDIA STATUS	R	R	R	C	C	C	C	O*
DBh	ACKNOWLEDGE MEDIA CHANGE	C	C	O	E	E	E	E	E
DCh	BOOT POST BOOT	C	C	O	E	E	E	E	E
DDh	BOOT PRE BOOT	C	C	O	E	E	E	E	E
DEh	MEDIA LOCK	C	C	C	C	C	C	C	O*
DFh	MEDIA UNLOCK	C	C	C	C	C	C	C	O*
E0h	STANDBY IMMEDIATE	C	C	C	C	C	C	C	C
Key:		<p>A = Reserved for assignment by the CompactFlash Association F = If the device does not implement the CFA feature set, this command code is Vendor specific. M = Reserved for the Media Card Pass Through Command feature set. S = Reserved for Serial ATA. *Indicates this definition is new to ATA8.</p>							
C = a defined command. E = a retired command. O = Obsolete. R = Reserved, undefined in current specifications. V = Vendor specific commands.									

Table B.4 — Historical Command Assignments (part 8 of 8)

Opcode	Command Name	ATA1	ATA2	ATA3	ATA4	ATA5	ATA6	ATA7	ATA8
E1h	IDLE IMMEDIATE	C	C	C	C	C	C	C	C
E2h	STANDBY	C	C	C	C	C	C	C	C
E3h	IDLE	C	C	C	C	C	C	C	C
E4h	READ BUFFER	C	C	C	C	C	C	C	C
E5h	CHECK POWER MODE	C	C	C	C	C	C	C	C
E6h	SLEEP	C	C	C	C	C	C	C	C
E7h	FLUSH CACHE	R	R	R	C	C	C	C	C
E8h	WRITE BUFFER	C	C	C	C	C	C	C	C
E9h	WRITE SAME	C	C	O	E	E	E	E	E
EAh	FLUSH CACHE EXT	R	R	R	R	R	C	C	C
EBh		R	R	R	R	R	R	R	R
ECh	IDENTIFY DEVICE	C	C	C	C	C	C	C	C
EDh	MEDIA EJECT	R	C	C	C	C	C	C	O
EEh	IDENTIFY DEVICE DMA	R	R	C	O	O	O	O	O
EFh	SET FEATURES	C	C	C	C	C	C	C	C
F0h	(vendor specific)	V	V	V	V	V	V	V	V
F1h	SECURITY SET PASSWORD	V	V	C	C	C	C	C	C
F2h	SECURITY UNLOCK	V	V	C	C	C	C	C	C
F3h	SECURITY ERASE PREPARE	V	V	C	C	C	C	C	C
F4h	SECURITY ERASE UNIT	V	V	C	C	C	C	C	C
F5h	SECURITY FREEZE LOCK	V	V	C	C	C	C	C	C
F6h	SECURITY DISABLE PASSWORD	V	V	C	C	C	C	C	C
F7h	(vendor specific)	V	V	V	V	V	V	V	V
F8h	READ NATIVE MAX ADDRESS	V	V	V	C	C	C	C	C
F9h	SET MAX ADDRESS	V	V	V	C	C	C	C	C
FAh	(vendor specific)	V	V	V	V	V	V	V	V
FBh	(vendor specific)	V	V	V	V	V	V	V	V
FCh	(vendor specific)	V	V	V	V	V	V	V	V
FDh	(vendor specific)	V	V	V	V	V	V	V	V
FEh	(vendor specific)	V	V	V	V	V	V	V	V
FFh	(vendor specific)	V	V	V	V	V	V	V	V
Key:		<p>A = Reserved for assignment by the CompactFlash Association</p> <p>F = If the device does not implement the CFA feature set, this command code is Vendor specific.</p> <p>M = Reserved for the Media Card Pass Through Command feature set.</p> <p>S = Reserved for Serial ATA.</p> <p>*Indicates this definition is new to ATA8.</p>							
<p>C = a defined command.</p> <p>E = a retired command.</p> <p>O = Obsolete.</p> <p>R = Reserved, undefined in current specifications.</p> <p>V = Vendor specific commands.</p>									

Table B.5 — Historical SET FEATURE Code Assignments (part 1 of 9)

Feature Code	Description	ATA1	ATA2	ATA3	ATA4	ATA5	ATA6	ATA7	ATA8
01h	Enable 8-bit data transfers	C	C	O	E	F	F	F	F
02h	Enable write cache	V	V	C	C	C	C	C	C
03h	Set transfer mode	C	C	C	C	C	C	C	C
04h	Enable all automatic defect reassignment	R	R	C	O	O	O	O	O
05h	Enable advanced power management	R	R	R	C	C	C	C	C
06h	Enable Power-Up in Standby feature set	R	R	R	R	C	C	C	C
07h	Power-up in Standby feature set device spin-up	R	R	R	R	C	C	C	C
09h	Reserved for Address offset reserved boot area method technical report	R	R	R	R	C	C	C	C
0Ah	Enable CFA power mode 1	R	R	R	R	C	C	C	C
0Bh	Reserved	R	R	R	R	R	R	R	R
0Ch	Reserved	R	R	R	R	R	R	R	R
0Dh	Reserved	R	R	R	R	R	R	R	R
0Eh	Reserved	R	R	R	R	R	R	R	R
0Fh	Reserved	R	R	R	R	R	R	R	R
10h	Enable use of SATA feature	R	R	R	R	R	R	S	C
11h	Reserved	R	R	R	R	R	R	R	R
12h	Reserved	R	R	R	R	R	R	R	R
13h	Reserved	R	R	R	R	R	R	R	R
14h	Reserved	R	R	R	R	R	R	R	R
15h	Reserved	R	R	R	R	R	R	R	R
16h	Reserved	R	R	R	R	R	R	R	R
17h	Reserved	R	R	R	R	R	R	R	R
18h	Reserved	R	R	R	R	R	R	R	R
19h	Reserved	R	R	R	R	R	R	R	R
1Ah	Reserved	R	R	R	R	R	R	R	R
1Bh	Reserved	R	R	R	R	R	R	R	R
Key:		<p>F = If the device does not implement the CFA feature set, this command code is Vendor specific.</p> <p>M = Reserved for the Media Card Pass Through Command feature set.</p> <p>S = Reserved for Serial ATA.</p> <p>T = Reserved for Technical Report T13/DT1696 (Time-Limited Commands).</p> <p>*Indicates this definition is new to ATA8</p>							
<p>C = a defined command.</p> <p>E = a retired command.</p> <p>O = Obsolete.</p> <p>R = Reserved, undefined in current specifications.</p> <p>V = Vendor specific command.</p> <p>A = Reserved for assignment by the CompactFlash Association.</p>									

Table B.5 — Historical SET FEATURE Code Assignments (part 2 of 9)

Feature Code	Description	ATA1	ATA2	ATA3	ATA4	ATA5	ATA6	ATA7	ATA8
1Ch	Reserved	R	R	R	R	R	R	R	R
1Dh	Reserved	R	R	R	R	R	R	R	R
1Eh	Reserved	R	R	R	R	R	R	R	R
1Fh	Reserved	R	R	R	R	R	R	R	R
20h	Reserved for Technical Report (T13/DT1696)	R	R	R	R	R	R	T	T
21h	Reserved for Technical Report (T13/DT1696)	R	R	R	R	R	R	T	T
22h	Reserved	R	R	R	R	R	R	R	R
23h	Reserved	R	R	R	R	R	R	R	R
24h	Reserved	R	R	R	R	R	R	R	R
25h	Reserved	R	R	R	R	R	R	R	R
26h	Reserved	R	R	R	R	R	R	R	R
27h	Reserved	R	R	R	R	R	R	R	R
28h	Reserved	R	R	R	R	R	R	R	R
29h	Reserved	R	R	R	R	R	R	R	R
2Ah	Reserved	R	R	R	R	R	R	R	R
2Bh	Reserved	R	R	R	R	R	R	R	R
2Ch	Reserved	R	R	R	R	R	R	R	R
2Dh	Reserved	R	R	R	R	R	R	R	R
2Eh	Reserved	R	R	R	R	R	R	R	R
2Fh	Reserved	R	R	R	R	R	R	R	R
30h	Reserved	R	R	R	R	R	R	R	R
31h	Disable Media Status Notification	R	R	R	C	C	C	C	O
32h	Reserved	R	R	R	R	R	R	R	R
33h	Disable retry	V	V	C	C	O	O	O	O
34h	Reserved	R	R	R	R	R	R	R	R
35h	Reserved	R	R	R	R	R	R	R	R
36h	Reserved	R	R	R	R	R	R	R	R
37h	Reserved	R	R	R	R	R	R	R	R
38h	Reserved	R	R	R	R	R	R	R	R
39h	Reserved	R	R	R	R	R	R	R	R
Key:	<p>F = If the device does not implement the CFA feature set, this command code is Vendor specific. M = Reserved for the Media Card Pass Through Command feature set. S = Reserved for Serial ATA. T = Reserved for Technical Report T13/DT1696 (Time-Limited Commands). *Indicates this definition is new to ATA8</p> <p>C = a defined command. E = a retired command. O = Obsolete. R = Reserved, undefined in current specifications. V = Vendor specific command. A = Reserved for assignment by the CompactFlash Association.</p>								

Table B.5 — Historical SET FEATURE Code Assignments (part 3 of 9)

Feature Code	Description	ATA1	ATA2	ATA3	ATA4	ATA5	ATA6	ATA7	ATA8
3Ah	Reserved	R	R	R	R	R	R	R	R
3Bh	Reserved	R	R	R	R	R	R	R	R
3Ch	Reserved	R	R	R	R	R	R	R	R
3Dh	Reserved	R	R	R	R	R	R	R	R
3Eh	Reserved	R	R	R	R	R	R	R	R
3Fh	Reserved	R	R	R	R	R	R	R	R
40h	Reserved	R	R	R	R	R	R	R	R
41h	Enable Free-fall Control feature set	R*	R*	R*	R*	R*	R*	R*	C*
42h	Enable Automatic Acoustic Management feature set	R	R	R	R	R	R	C	C
43h	Set Maximum Host Interface Sector Times	R	R	R	R	R	R	C	C
44h	Vendor specific length of ECC on read long/write long commands	C	C	C	O	O	O	O	O
45h	Reserved	R	R	R	R	R	R	R	R
46h	Reserved	R	R	R	R	R	R	R	R
47h	Reserved	R	R	R	R	R	R	R	R
48h	Reserved	R	R	R	R	R	R	R	R
49h	Reserved	R	R	R	R	R	R	R	R
4Ah	Reserved	R	R	R	R	R	R	R	R
4Bh	Reserved	R	R	R	R	R	R	R	R
4Ch	Reserved	R	R	R	R	R	R	R	R
4Dh	Reserved	R	R	R	R	R	R	R	R
4Eh	Reserved	R	R	R	R	R	R	R	R
4Fh	Reserved	R	R	R	R	R	R	R	R
50h	Reserved	R	R	R	R	R	R	R	R
51h	Reserved	R	R	R	R	R	R	R	R
52h	Reserved	R	R	R	R	R	R	R	R
53h	Reserved	R	R	R	R	R	R	R	R
54h	Set cache segments to the Count field value	V	V	C	O	O	O	O	O
Key:		<p>F = If the device does not implement the CFA feature set, this command code is Vendor specific.</p> <p>M = Reserved for the Media Card Pass Through Command feature set.</p> <p>S = Reserved for Serial ATA.</p> <p>T = Reserved for Technical Report T13/DT1696 (Time-Limited Commands).</p> <p>*Indicates this definition is new to ATA8</p>							
<p>C = a defined command.</p> <p>E = a retired command.</p> <p>O = Obsolete.</p> <p>R = Reserved, undefined in current specifications.</p> <p>V = Vendor specific command.</p> <p>A = Reserved for assignment by the CompactFlash Association.</p>									

Table B.5 — Historical SET FEATURE Code Assignments (part 4 of 9)

Feature Code	Description	ATA1	ATA2	ATA3	ATA4	ATA5	ATA6	ATA7	ATA8
55h	Disable read look-ahead feature	C	C	C	C	C	C	C	C
56h	Vendor Specific	R	R	R	R	R	R	R	V
57h	Vendor Specific	R	R	R	R	R	R	R	V
58h	Vendor Specific	R	R	R	R	R	R	R	V
59h	Vendor Specific	R	R	R	R	R	R	R	V
5Ah	Vendor Specific	R	R	R	R	R	R	R	V
5Bh	Vendor Specific	R	R	R	R	R	R	R	V
5Ch	Vendor Specific	R	R	R	R	R	R	R	V
5Dh	Enable release interrupt	R	R	R	C	C	C	C	C
5Eh	Enable SERVICE interrupt	R	R	R	C	C	C	C	C
5Fh	Reserved	R	R	R	R	R	R	R	R
60h	Reserved	R	R	R	R	R	R	R	R
61h	Reserved	R	R	R	R	R	R	R	R
62h	Reserved	R	R	R	R	R	R	R	R
63h	Reserved	R	R	R	R	R	R	R	R
64h	Reserved	R	R	R	R	R	R	R	R
65h	Reserved	R	R	R	R	R	R	R	R
66h	Disable reverting to power on defaults	C	C	C	C	C	C	C	C
67h	Reserved	R	R	R	R	R	R	R	R
68h	Reserved	R	R	R	R	R	R	R	R
69h	Reserved	R	R	R	R	R	R	R	R
6Ah	Reserved	R	R	R	R	R	R	R	R
6Bh	Reserved	R	R	R	R	R	R	R	R
6Ch	Reserved	R	R	R	R	R	R	R	R
6Dh	Reserved	R	R	R	R	R	R	R	R
6Eh	Reserved	R	R	R	R	R	R	R	R
6Fh	Reserved	R	R	R	R	R	R	R	R
70h	Reserved	R	R	R	R	R	R	R	R
71h	Reserved	R	R	R	R	R	R	R	R
72h	Reserved	R	R	R	R	R	R	R	R
Key:		<p>F = If the device does not implement the CFA feature set, this command code is Vendor specific.</p> <p>M = Reserved for the Media Card Pass Through Command feature set.</p> <p>S = Reserved for Serial ATA.</p> <p>T = Reserved for Technical Report T13/DT1696 (Time-Limited Commands).</p> <p>*Indicates this definition is new to ATA8</p>							
<p>C = a defined command.</p> <p>E = a retired command.</p> <p>O = Obsolete.</p> <p>R = Reserved, undefined in current specifications.</p> <p>V = Vendor specific command.</p> <p>A = Reserved for assignment by the CompactFlash Association.</p>									

Table B.5 — Historical SET FEATURE Code Assignments (part 5 of 9)

Feature Code	Description	ATA1	ATA2	ATA3	ATA4	ATA5	ATA6	ATA7	ATA8
73h	Reserved	R	R	R	R	R	R	R	R
74h	Reserved	R	R	R	R	R	R	R	R
75h	Reserved	R	R	R	R	R	R	R	R
76h	Reserved	R	R	R	R	R	R	R	R
77h	Disable ECC	V	V	C	O	O	O	O	O
78h	Reserved	R	R	R	R	R	R	R	R
79h	Reserved	R	R	R	R	R	R	R	R
7Ah	Reserved	R	R	R	R	R	R	R	R
7Bh	Reserved	R	R	R	R	R	R	R	R
7Ch	Reserved	R	R	R	R	R	R	R	R
7Dh	Reserved	R	R	R	R	R	R	R	R
7Eh	Reserved	R	R	R	R	R	R	R	R
7Fh	Reserved	R	R	R	R	R	R	R	R
80h	Reserved	R	R	R	R	R	R	R	R
81h	Disable 8-bit data transfers	C	C	O	E	F	F	F	F
82h	Disable write cache	V	V	C	C	C	C	C	C
83h	Reserved	R	R	R	R	R	R	R	R
84h	Disable all automatic defect reassignment	R	R	C	O	O	O	O	O
85h	Disable advanced power management	R	R	R	C	C	C	C	C
86h	Disable Power-Up in Standby feature set	R	R	R	R	C	C	C	C
87h	Reserved	R	R	R	R	R	R	R	R
88h	Enable ECC	V	V	C	C	C	O	O	O
89h	Reserved for Address offset reserved boot area method technical report	R	R	R	R	C	C	C	C
8Ah	Disable CFA power mode 1	R	R	R	R	C	C	F	F
8Bh	Reserved	R	R	R	R	R	R	R	R
8Ch	Reserved	R	R	R	R	R	R	R	R
8Dh	Reserved	R	R	R	R	R	R	R	R
8Eh	Reserved	R	R	R	R	R	R	R	R
Key:	<p>C = a defined command. E = a retired command. O = Obsolete. R = Reserved, undefined in current specifications. V = Vendor specific command. A = Reserved for assignment by the CompactFlash Association.</p> <p>F = If the device does not implement the CFA feature set, this command code is Vendor specific. M = Reserved for the Media Card Pass Through Command feature set. S = Reserved for Serial ATA. T = Reserved for Technical Report T13/DT1696 (Time-Limited Commands). *Indicates this definition is new to ATA8</p>								

Table B.5 — Historical SET FEATURE Code Assignments (part 6 of 9)

Feature Code	Description	ATA1	ATA2	ATA3	ATA4	ATA5	ATA6	ATA7	ATA8
8Fh	Reserved	R	R	R	R	R	R	R	R
90h	Disable use of SATA feature	R	R	R	R	R	R	S	C
91h	Reserved	R	R	R	R	R	R	R	R
92h	Reserved	R	R	R	R	R	R	R	R
93h	Reserved	R	R	R	R	R	R	R	R
94h	Reserved	R	R	R	R	R	R	R	R
95h	Enable Media Status Notification	R	R	R	C	C	C	C	O
96h	Reserved	R	R	R	R	R	R	R	R
97h	Reserved	R	R	R	R	R	R	R	R
98h	Reserved	R	R	R	R	R	R	R	R
99h	Enable retries	V	V	C	O	O	O	O	O
9Ah	Set device maximum average current	R	R	C	O	O	O	O	O
9Bh	Reserved	R	R	R	R	R	R	R	R
9Ch	Reserved	R	R	R	R	R	R	R	R
9Dh	Reserved	R	R	R	R	R	R	R	R
9Eh	Reserved	R	R	R	R	R	R	R	R
9Fh	Reserved	R	R	R	R	R	R	R	R
A0h	Reserved	R	R	R	R	R	R	R	R
A1h	Reserved	R	R	R	R	R	R	R	R
A2h	Reserved	R	R	R	R	R	R	R	R
A3h	Reserved	R	R	R	R	R	R	R	R
A4h	Reserved	R	R	R	R	R	R	R	R
A5h	Reserved	R	R	R	R	R	R	R	R
A6h	Reserved	R	R	R	R	R	R	R	R
A7h	Reserved	R	R	R	R	R	R	R	R
A8h	Reserved	R	R	R	R	R	R	R	R
A9h	Reserved	R	R	R	R	R	R	R	R
AAh	Enable read look-ahead features	C	C	C	C	C	C	C	C
ABh	Set maximum prefetch using the Count field value	V	V	C	O	O	O	O	O
Key:		<p>F = If the device does not implement the CFA feature set, this command code is Vendor specific. M = Reserved for the Media Card Pass Through Command feature set. S = Reserved for Serial ATA. T = Reserved for Technical Report T13/DT1696 (Time-Limited Commands). *Indicates this definition is new to ATA8</p>							
<p>C = a defined command. E = a retired command. O = Obsolete. R = Reserved, undefined in current specifications. V = Vendor specific command. A = Reserved for assignment by the CompactFlash Association.</p>									

Table B.5 — Historical SET FEATURE Code Assignments (part 7 of 9)

Feature Code	Description	ATA1	ATA2	ATA3	ATA4	ATA5	ATA6	ATA7	ATA8
ACh	Reserved	R	R	R	R	R	R	R	R
ADh	Reserved	R	R	R	R	R	R	R	R
A Eh	Reserved	R	R	R	R	R	R	R	R
AFh	Reserved	R	R	R	R	R	R	R	R
B0h	Reserved	R	R	R	R	R	R	R	R
B1h	Reserved	R	R	R	R	R	R	R	R
B2h	Reserved	R	R	R	R	R	R	R	R
B3h	Reserved	R	R	R	R	R	R	R	R
B4h	Reserved	R	R	R	R	R	R	R	R
B5h	Reserved	R	R	R	R	R	R	R	R
B6h	Reserved	R	R	R	R	R	R	R	R
B7h	Reserved	R	R	R	R	R	R	R	R
B8h	Reserved	R	R	R	R	R	R	R	R
B9h	Reserved	R	R	R	R	R	R	R	R
BAh	Reserved	R	R	R	R	R	R	R	R
BBh	4 bytes of ECC apply on read long/write long commands	C	C	C	O	O	O	O	O
BCh	Reserved	R	R	R	R	R	R	R	R
BDh	Reserved	R	R	R	R	R	R	R	R
BEh	Reserved	R	R	R	R	R	R	R	R
BFh	Reserved	R	R	R	R	R	R	R	R
C0h	Reserved	R	R	R	R	R	R	R	R
C1h	Disable Free-fall Control feature set	R*	R*	R*	R*	R*	R*	R*	C*
C2h	Disable Automatic Acoustic Management feature set	R	R	R	R	R	R	C	C
C3h	Reserved	R	R	R	R	R	R	R	R
C4h	Reserved	R	R	R	R	R	R	R	R
C5h	Reserved	R	R	R	R	R	R	R	R
C6h	Reserved	R	R	R	R	R	R	R	R
C7h	Reserved	R	R	R	R	R	R	R	R
C8h	Reserved	R	R	R	R	R	R	R	R
C9h	Reserved	R	R	R	R	R	R	R	R
Key:	<p>F = If the device does not implement the CFA feature set, this command code is Vendor specific. M = Reserved for the Media Card Pass Through Command feature set. S = Reserved for Serial ATA. T = Reserved for Technical Report T13/DT1696 (Time-Limited Commands). *Indicates this definition is new to ATA8</p> <p>C = a defined command. E = a retired command. O = Obsolete. R = Reserved, undefined in current specifications. V = Vendor specific command. A = Reserved for assignment by the CompactFlash Association.</p>								

Table B.5 — Historical SET FEATURE Code Assignments (part 8 of 9)

Feature Code	Description	ATA1	ATA2	ATA3	ATA4	ATA5	ATA6	ATA7	ATA8
CAh	Reserved	R	R	R	R	R	R	R	R
CBh	Reserved	R	R	R	R	R	R	R	R
CCh	Enable reverting to power on defaults	C	C	C	C	C	C	C	C
CDh	Reserved	R	R	R	R	R	R	R	R
CEh	Reserved	R	R	R	R	R	R	R	R
CFh	Reserved	R	R	R	R	R	R	R	R
D0h	Reserved	R	R	R	R	R	R	R	R
D1h	Reserved	R	R	R	R	R	R	R	R
D2h	Reserved	R	R	R	R	R	R	R	R
D3h	Reserved	R	R	R	R	R	R	R	R
D4h	Reserved	R	R	R	R	R	R	R	R
D5h	Reserved	R	R	R	R	R	R	R	R
D6h	Vendor Specific	R	R	R	R	R	R	R	V
D7h	Vendor Specific	R	R	R	R	R	R	R	V
D8h	Vendor Specific	R	R	R	R	R	R	R	V
D9h	Vendor Specific	R	R	R	R	R	R	R	V
DAh	Vendor Specific	R	R	R	R	R	R	R	V
DBh	Vendor Specific	R	R	R	R	R	R	R	V
DCh	Vendor Specific	R	R	R	R	R	R	R	V
DDh	Disable release interrupt	R	R	R	C	C	C	C	C
DEh	Disable SERVICE interrupt	R	R	R	C	C	C	C	C
DFh	Reserved	R	R	R	R	R	R	R	R
E0h	Vendor specific	R	R	R	R	R	R	O	O
E1h	Reserved	R	R	R	R	R	R	R	R
E2h	Reserved	R	R	R	R	R	R	R	R
E3h	Reserved	R	R	R	R	R	R	R	R
E4h	Reserved	R	R	R	R	R	R	R	R
E5h	Reserved	R	R	R	R	R	R	R	R
E6h	Reserved	R	R	R	R	R	R	R	R
E7h	Reserved	R	R	R	R	R	R	R	R
E8h	Reserved	R	R	R	R	R	R	R	R
Key:		<p>F = If the device does not implement the CFA feature set, this command code is Vendor specific. M = Reserved for the Media Card Pass Through Command feature set. S = Reserved for Serial ATA. T = Reserved for Technical Report T13/DT1696 (Time-Limited Commands). *Indicates this definition is new to ATA8</p>							
<p>C = a defined command. E = a retired command. O = Obsolete. R = Reserved, undefined in current specifications. V = Vendor specific command. A = Reserved for assignment by the CompactFlash Association.</p>									

Table B.5 — Historical SET FEATURE Code Assignments (part 9 of 9)

Feature Code	Description	ATA1	ATA2	ATA3	ATA4	ATA5	ATA6	ATA7	ATA8
E9h	Reserved	R	R	R	R	R	R	R	R
EAh	Reserved	R	R	R	R	R	R	R	R
EBh	Reserved	R	R	R	R	R	R	R	R
ECh	Reserved	R	R	R	R	R	R	R	R
EDh	Reserved	R	R	R	R	R	R	R	R
EEh	Reserved	R	R	R	R	R	R	R	R
EFh	Reserved	R	R	R	R	R	R	R	R
F0h		R	R	R	R	A	A	A	A
F1h		R	R	R	R	A	A	A	A
F2h		R	R	R	R	A	A	A	A
F3h		R	R	R	R	A	A	A	A
F4h		R	R	R	R	A	A	A	A
F5h		R	R	R	R	A	A	A	A
F6h		R	R	R	R	A	A	A	A
F7h		R	R	R	R	A	A	A	A
F8h		R	R	R	R	A	A	A	A
F9h		R	R	R	R	A	A	A	A
FAh		R	R	R	R	A	A	A	A
FBh		R	R	R	R	A	A	A	A
FCh		R	R	R	R	A	A	A	A
FDh		R	R	R	R	A	A	A	A
FEh		R	R	R	R	A	A	A	A
FFh		R	R	R	R	A	A	A	A
Key:	<p>F = If the device does not implement the CFA feature set, this command code is Vendor specific. M = Reserved for the Media Card Pass Through Command feature set. S = Reserved for Serial ATA. T = Reserved for Technical Report T13/DT1696 (Time-Limited Commands). *Indicates this definition is new to ATA8</p> <p>C = a defined command. E = a retired command. O = Obsolete. R = Reserved, undefined in current specifications. V = Vendor specific command. A = Reserved for assignment by the CompactFlash Association.</p>								

Annex C

(Informative)

Design and programming considerations for large physical sector devices

C.1 Introduction

In ATA standards preceding ATA/ATAPI-7, the smallest host addressable unit of data was the 512-byte sector. In disk drives each physical sector has an associated error correcting code field to allow detection and correction of read errors. Over time, error correcting code fields have been lengthened to provide greater detection and correction capability. As a result, the proportion of device media devoted to ECC fields has risen. Increasing the length of data sectors on the media increases the efficiency of ECC by enabling better error detection and correction using a smaller proportion of media.

C.2 Physical sectors

Because the 512-byte sector has been a constant since the beginning of ATA many software changes are required if device logical sectors were made larger. To preserve the legacy software that assumes a 512-byte logical sector, logical addressing based on 512-byte sectors has been retained. Larger physical sectors are implemented as power of two multiples of the logical sector size (e.g., 1, 2, 4, 8, 16). For example, devices may have physical sectors that are 8 logical sectors long or 4,096 bytes total. It is not possible to report a logical sector that spans two physical sectors.

C.3 Unaligned write

While allowing a logical sector to be smaller than a physical sector maintains software compatibility, it introduces a potential performance issue, unaligned write, which should be avoided. A physical sector is written to the media in a single operation. To complete a write command that writes a fraction of a physical sector the device reads the entire physical sector into buffer memory, updates the buffer memory with the write data, and then writes the entire physical sector to the media. This may incur a performance penalty of one media revolution or more.

Write commands may begin mid physical sector and end mid physical sector resulting in two unaligned writes. In this case the device has to read both the beginning and ending physical sector of the write into the buffer.

To avoid the performance penalty from an unaligned write, all write operations should begin with the first sector of a physical sector and end with the last sector of a physical sector.

Figure C.1 illustrates an unaligned write on a device with 2,048 byte physical sectors. The first four logical sectors, LBA 0 - LBA 3, reside on physical sector 0. To write only LBA 3 the host sends a conventional write command and the data for LBA 3. On receipt of the write command the device seeks to the physical sector that contains LBA 3, which is physical sector 0. Physical sector 0 is read into the device buffer. Then the new write data for LBA 3 is placed in the buffer, overwriting a segment of the buffer. The buffer data is then written to the media, physical sector 0.

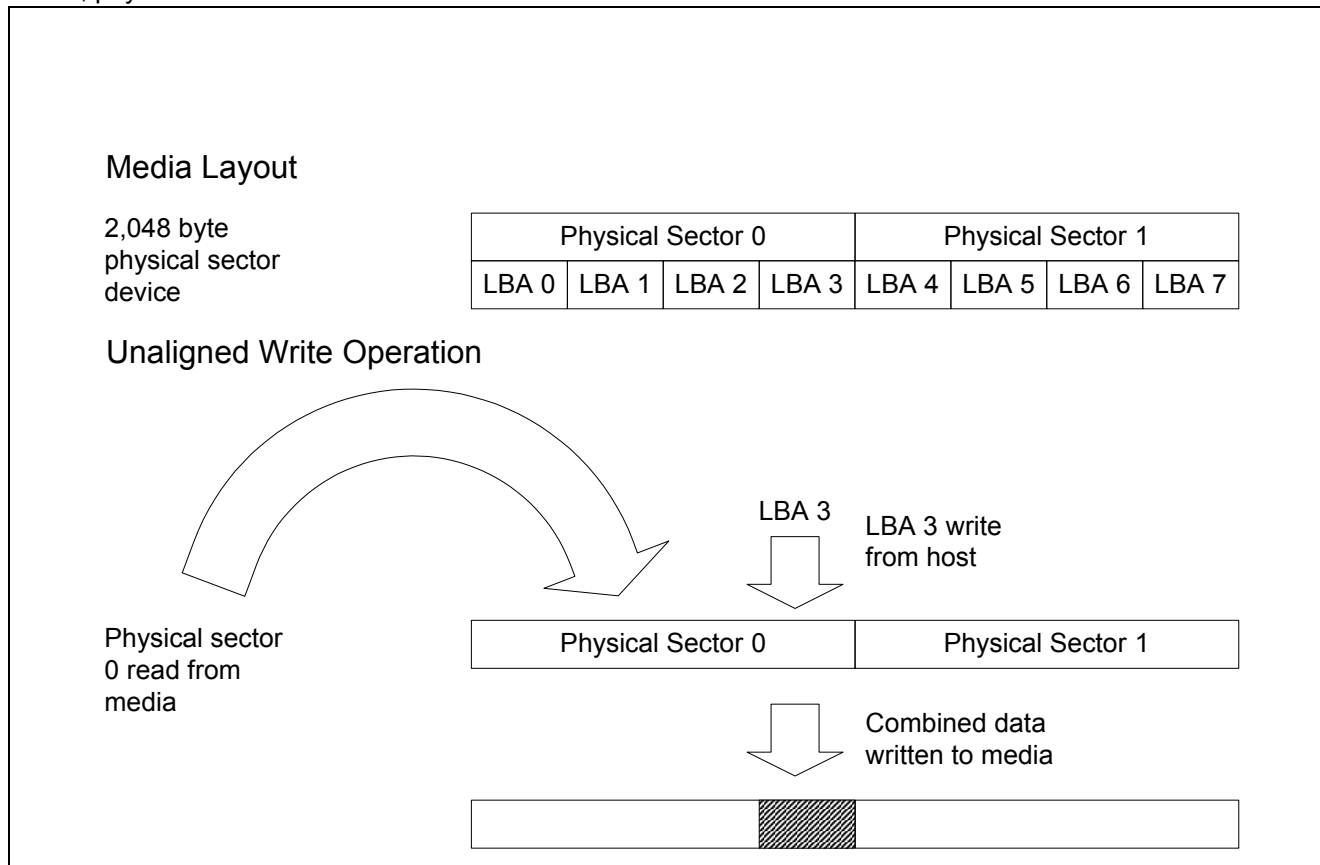

Figure C.1 — Unaligned Write Example

C.4 SET MAX

A Host that uses the SET MAX ADDRESS command (see 7.49.2) or SET MAX ADDRESS EXT command (see 7.50) should set a value to the last logical sector of a physical sector to allow writes to the end of the user area without requiring an unaligned write. Devices should accommodate a SET MAX setting to any LBA to maintain compatibility.

C.5 Software compatibility

While the current specification allows devices to report up to 2^{15} or 32,768 logical sectors per physical sector there are file system limitations in existing systems that restrict practical device implementations to 4,096 bytes per physical sector.

Annex D

(Informative)

How to use SCT commands

D.1 How to use SCT commands overview

SCT commands piggy-back on the standard ATA commands: SMART READ LOG and SMART WRITE LOG, or READ LOG EXT and WRITE LOG EXT. As viewed through an ATA protocol analyzer, an SCT command is seen as data being transferred by these commands; whereas from the perspective of a device that implements this feature set, this data is interpreted as an SCT command request, an SCT command response, SCT command status, or SCT command data.

Figure D.1 is an example flowchart that shows how to process SCT commands using read log and write log commands:

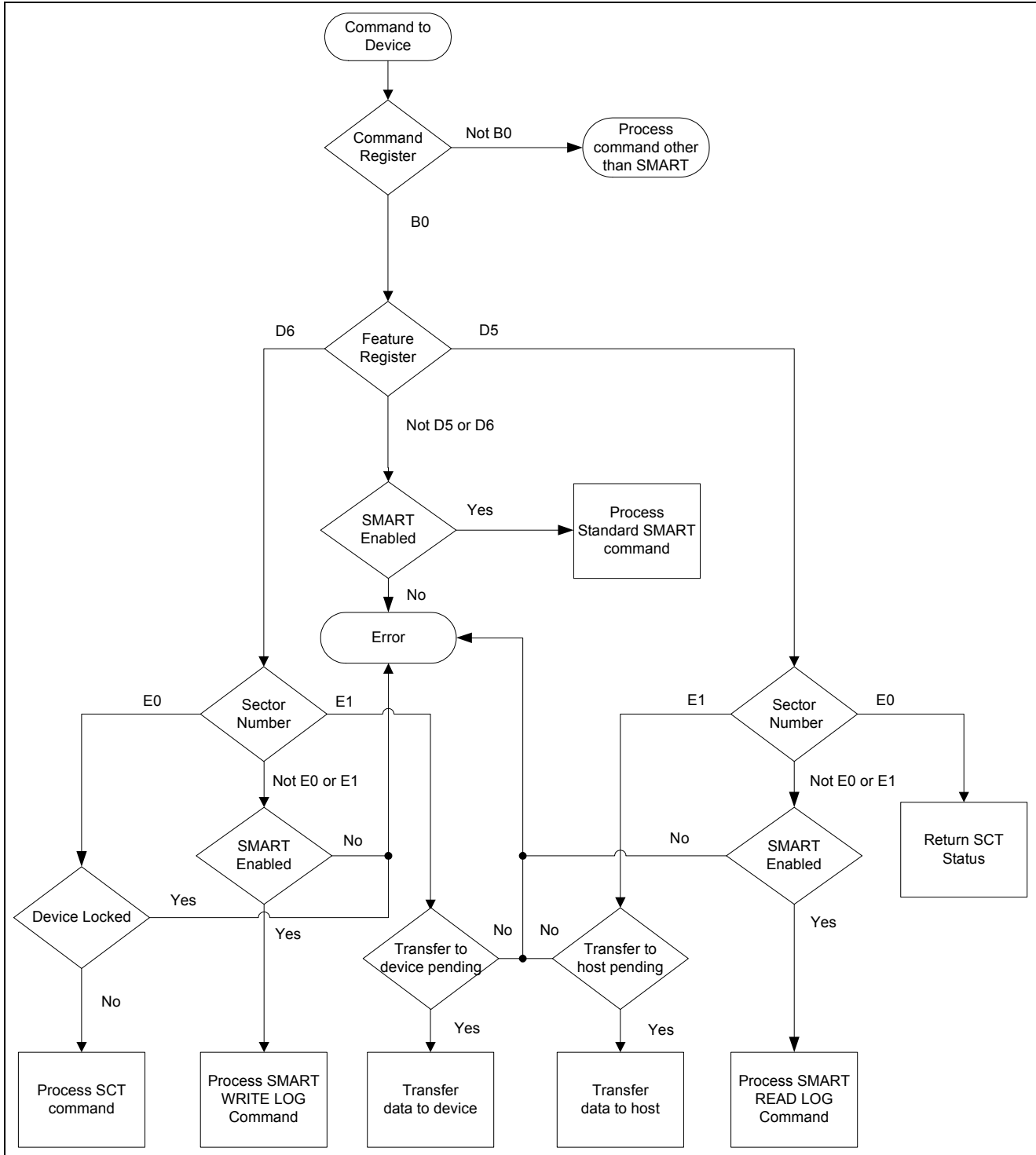

Figure D.1 — Example flowchart for SCT commands

D.2 Examples of Log page command sequences

Figure D.2 shows an example of a foreground write same with a repeating write pattern.

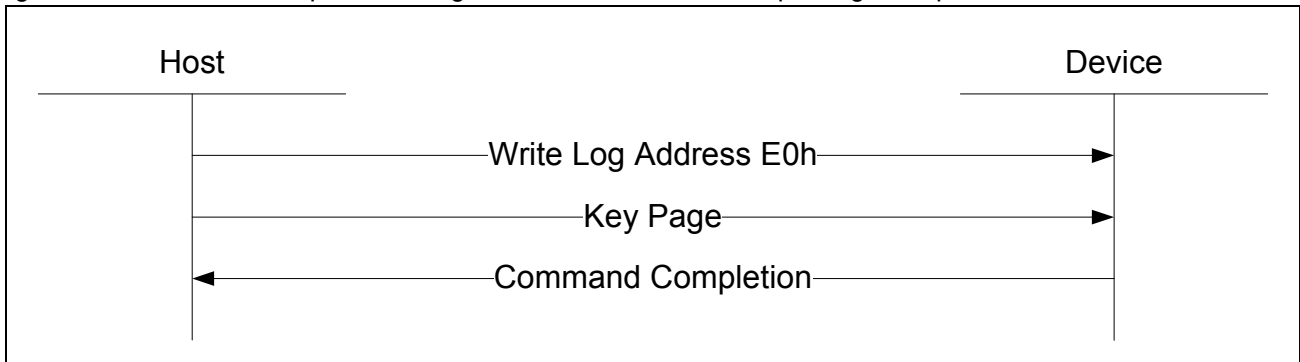

Figure D.2 — Example sequence for foreground write same with a repeating pattern

Figure D.3 shows an example of a foreground write same with a repeating sector.

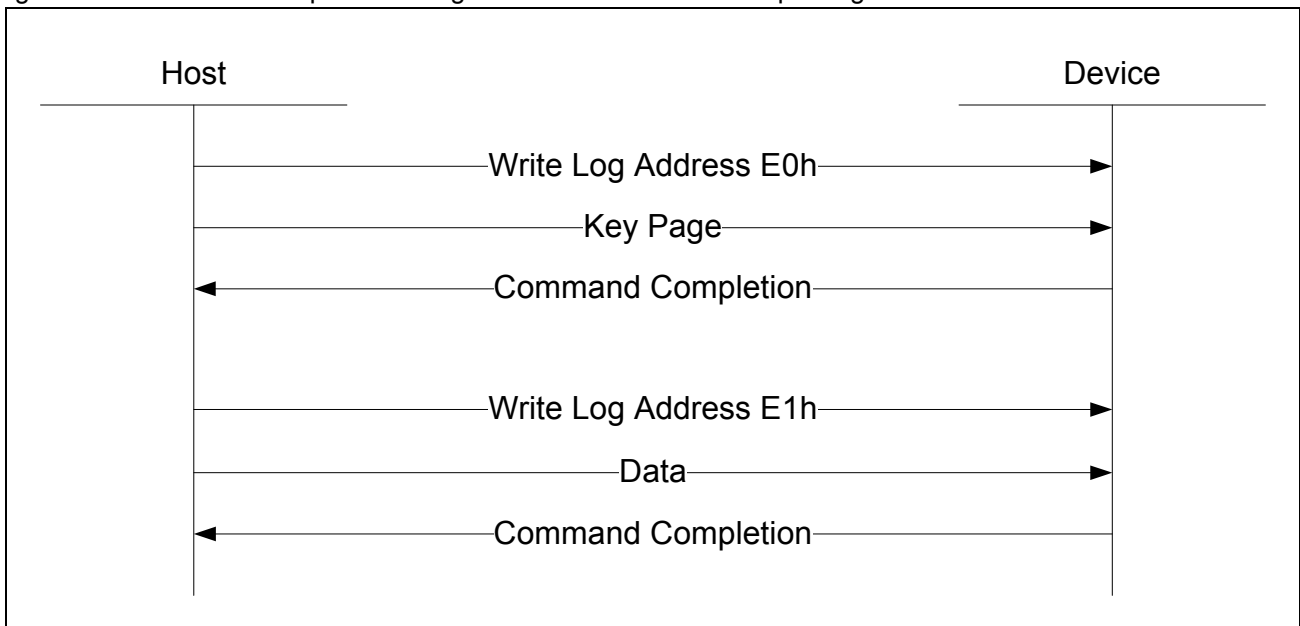

Figure D.3 — Example sequence for foreground write same with a repeating sector

Figure D.4 shows an example command sequence for writing data to a device using an SCT command with no background activity.

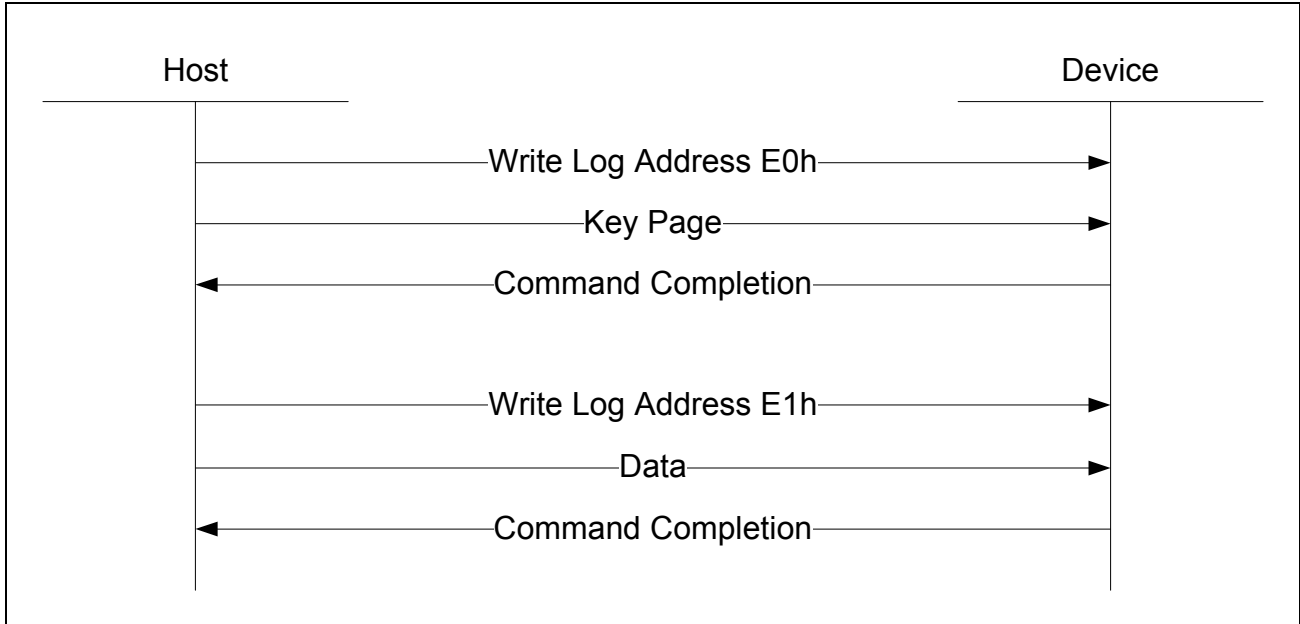

Figure D.4 — Example sequence for writing data using an SCT command with no background activity

Figure D.5 shows an example command sequence for reading data from a device using an SCT command with no background activity.

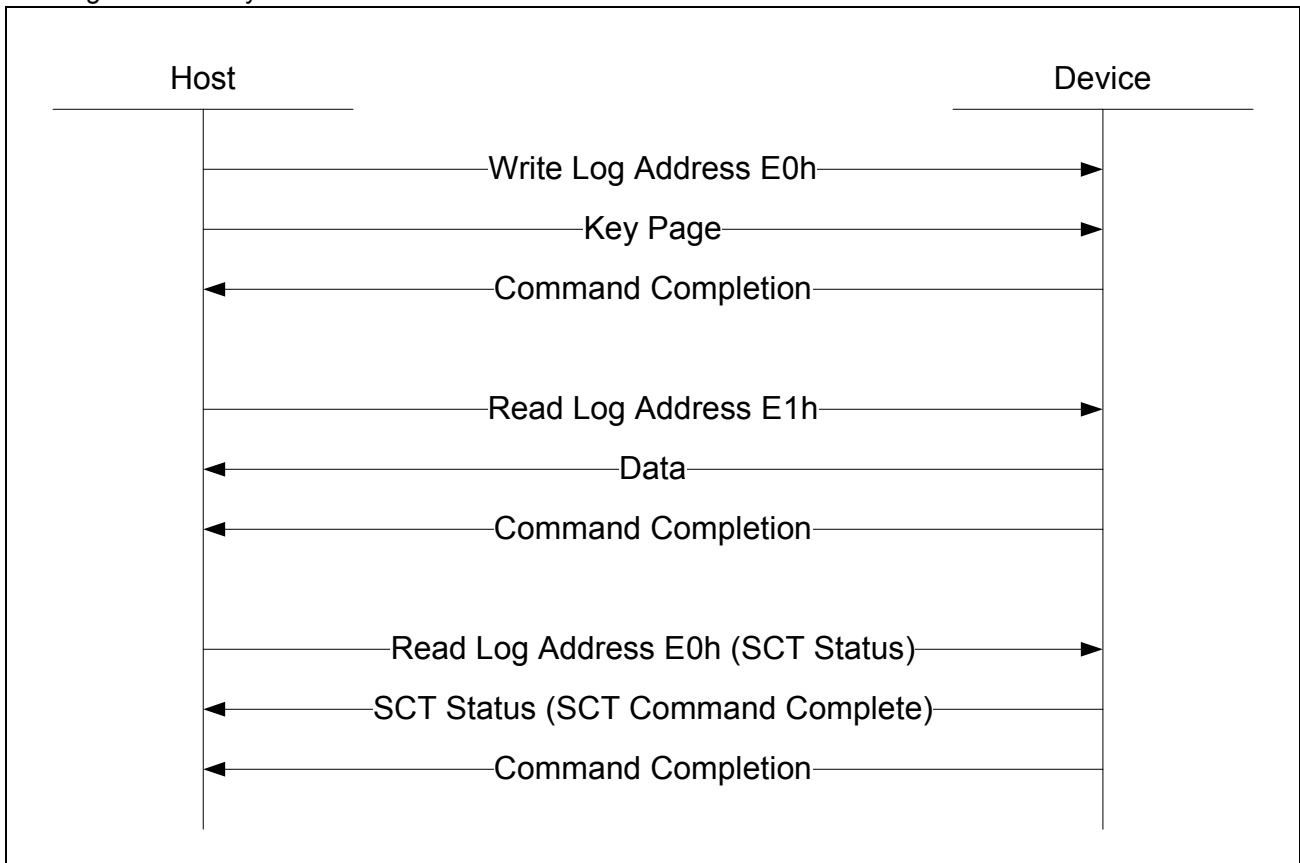

Figure D.5 — Example sequence for reading data using an SCT command with no background activity

Figure D.6 shows an example command sequence for issuing a Log page command that does not transfer data and has no background activity.

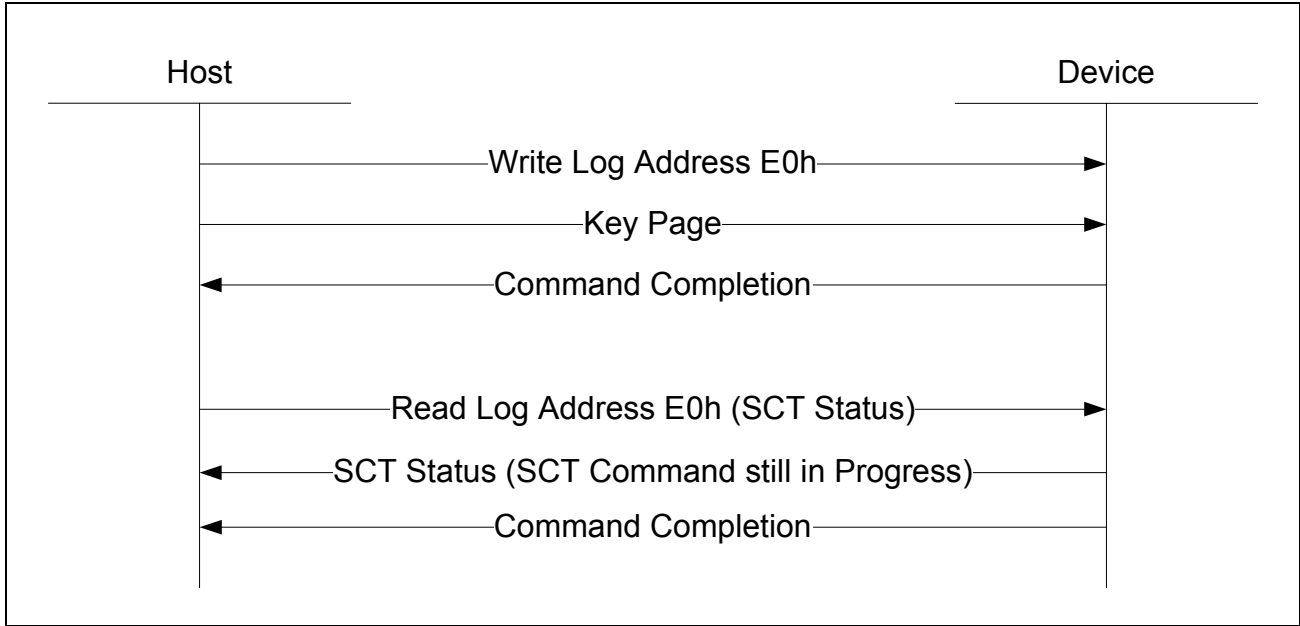

Figure D.6 — Example Sequence for a Non-Data SCT command with no background activity

Figure D.7 shows an example command sequence for issuing an SCT command that writes data in the background.

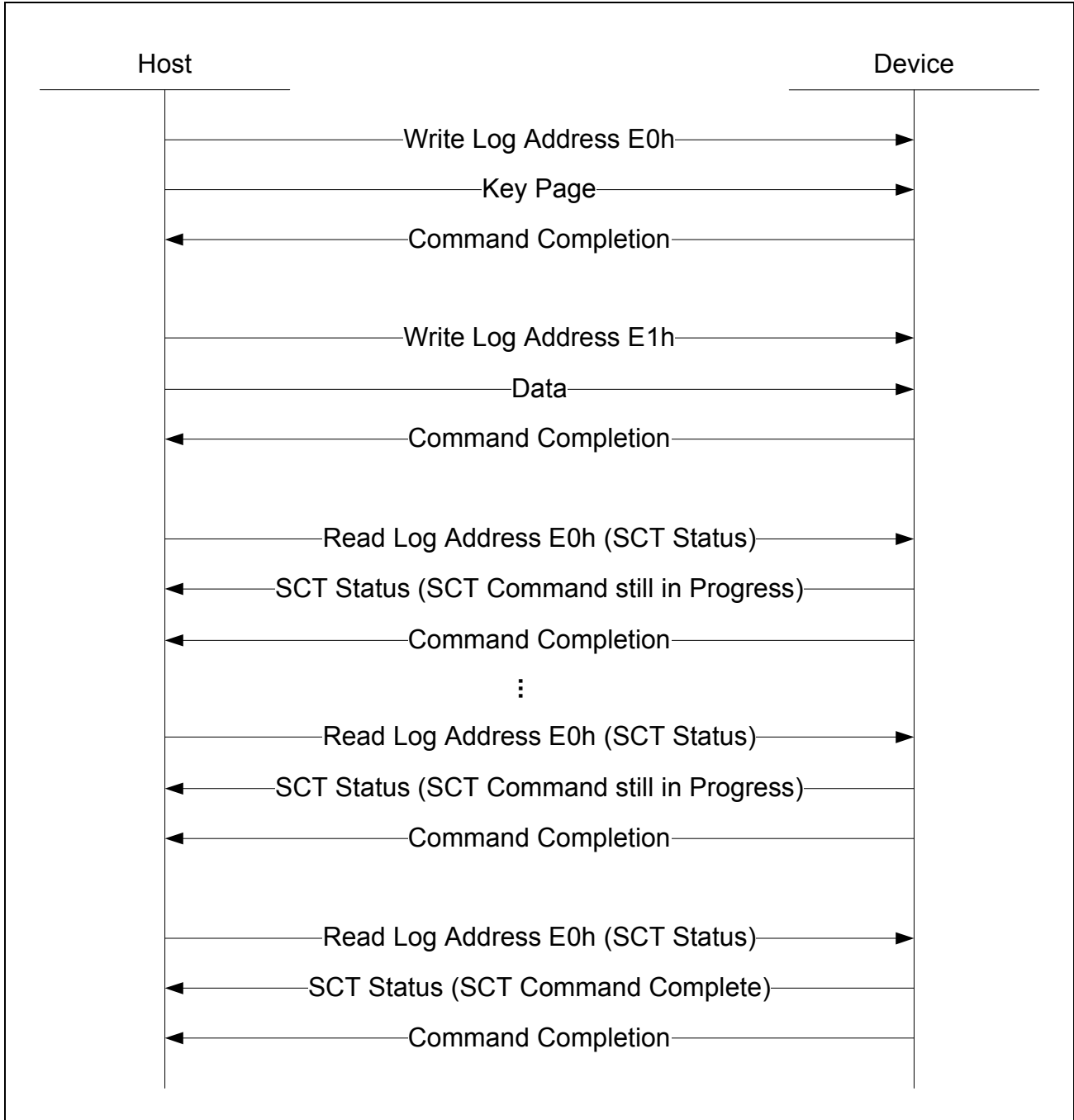

Figure D.7 — Example sequence for writing data using an SCT command with background activity

Figure D.8 shows an example command sequence for issuing an SCT command that executes in the background but does not require the transfer of data to or from the host.

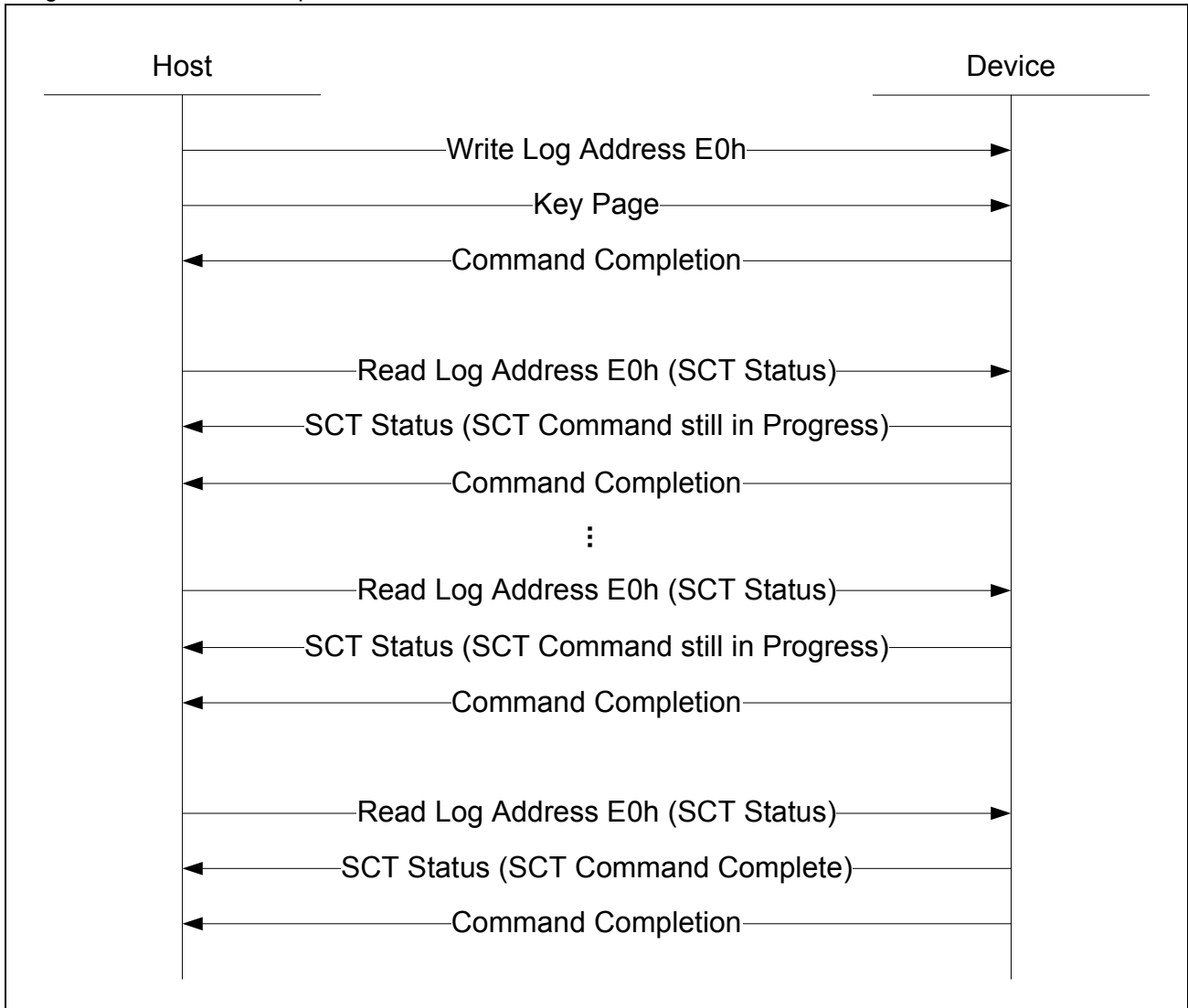

Figure D.8 — Example sequence for a Non-Data SCT command with background activity

D.3 Issuing an SCT command to a device

D.3.1 Step 1 - Build a Key Page

The host builds the key page in a host buffer for the appropriate action and parameters.

D.3.2 Step 2 - Issue the SCT command

The host issues the SCT command (see table D.1 or table D.2), and sends the key page to the device.

Table D.1 — SCT command using SMART WRITE LOG command

Name	Description
Feature	D6h (e.g., SMART WRITE LOG)
Count	01h
LBA	<p>Bit Description</p> <p>27:24 N/A</p> <p>23:8 C24Fh</p> <p>7:0 E0h (e.g., SCT Command/Status log address)</p>
Device	<p>Bit Description</p> <p>7 Obsolete</p> <p>6 N/A</p> <p>5 Obsolete</p> <p>4 Transport Dependent - See 6.2.11</p> <p>3:0 Reserved</p>
Command	7:0 B0h

Table D.2 — SCT command using WRITE LOG EXT command

Name	Description
Feature	Reserved
Count	0001h (e.g., one sector for SCT commands)
LBA	<p>Bit Description</p> <p>47:40 Reserved</p> <p>39:32 00h</p> <p>31:16 Reserved</p> <p>15:8 00h</p> <p>7:0 E0h (e.g., SCT Command/Status log address)</p>
Device	<p>Bit Description</p> <p>7 Obsolete</p> <p>6 N/A</p> <p>5 Obsolete</p> <p>4 Transport Dependent - See 6.2.11</p> <p>3:0 Reserved</p>
Command	<p>7:0 3Fh (e.g., WRITE LOG EXT)</p> <p>57h (e.g., WRITE LOG DMA EXT)</p>

The device responds with successful status (see table 73). If the command is aborted (i.e., Status = 51h and Error = 04h), then either the key page format is invalid, the command structure contains an invalid value or the command encountered an execution error. The host checks the Count and LBA (7:0) fields for the error code (see table 74 and table 75). If the command was a write command, the command is terminated, there is no data transfer, and the host skips Step 3. However, if the command was a read command, there may be partial output available (e.g., on a sector read command, the data up to and including the sector in error is available) and the host may proceed to Step 3 to get the partial data. In some cases the error is not fatal and serves only as a warning.

If the status is 50h, then the host checks LBA (23:8). If LBA (23:8) is cleared to 0000h, then the command is complete, terminated without error, and the host proceeds to Step 4. If the values are greater than 0, then the host proceeds to Step 3.

D.3.3 Step 3 - Transfer Data if Required

To transfer data from the device to the host, the host issues a SMART READ LOG, READ LOG DMA EXT or READ LOG EXT command to the SCT Data Transfer log (see table 76 and table 77). To transfer data from the host to the device, the host issues a SMART WRITE LOG, WRITE LOG DMA EXT or WRITE LOG EXT command to the SCT Data Transfer log (see table 76 and table 77). The transfer request is in the range of 1 sector up to the total number of sectors not yet transferred. The number of sectors remaining was posted in the LBA (23:8) field in the previous step. If the requested number of sectors is larger than the number of the sectors remaining, the device reports an error. If the value is less than the number of sectors remaining, the host may repeat Step 3 until all sectors have been transferred.

For SCT commands that access the media, the device advances the sector pointer by the number of sectors transferred, and reports in the LBA (23:8) field the number of sectors remaining to be transferred. If both fields contain zero, then the command is complete, and the host proceeds to Step 4. The host has complete control over the number of sectors to transfer at a time. If the number of sectors to be transferred is greater than or

equal to FFFFh, the device sets LBA (23:8) to FFFFh. The value remains FFFFh until the number of sectors remaining drops below FFFFh. The exact number to be transferred is reported by the SCT Status command. Upon receiving the last block of data, the device performs the specified operation. In the case of very large amounts of data (e.g., Write Same) some data may be processed (e.g., written to the disk) prior to receiving all of the data from the host.

D.3.4 Step 4 - Final Status/SCT Command Completion

The host reads the SCT status response (see table 78, table 79, and table 80) to determine how the command completed. If the command has not completed (i.e., by reporting FFFFh in table 80 byte 14) then the host waits for some period of time and repeats Step 4 until the command is complete. For SCT commands that require transfer of data to the device (e.g., a write command), the command is not complete until the last block of data has been transferred to the device.

Annex E (Informative)

Implementation Guidelines For 1,024/4,096 Byte Sector Sizes

E.1 Introduction

The disk drive industry has been standardized on a 512-byte sector size for over 25 years. In the continual pursuit for size and performance, larger sector sizes are being considered.

E.2 Scope

This annex provides guidelines for implementing a media format that incorporates sector sizes greater than 512 bytes. This annex does not make a case for using larger sector sizes. Instead, this annex assumes that the move to larger sector sizes is going to happen and addresses both system and industry implications.

The information provided in this annex enables sector sizes that are a binary multiple greater than 512 bytes. This standard also specifies methods to report sector sizes that are not a binary multiple. Common sector sizes that are not binary multiples include 520, 524, 528 and 532 byte sectors. Non-binary multiples are beyond the scope of this annex.

E.3 Overview

The disk drive industry is considering implementing drives with a media sector size larger than 512 bytes. The purpose of this change is to allow for greater format efficiency, greater error recovery capability, or both. Figure E.1 shows major system components that are affected by a change in sector size.

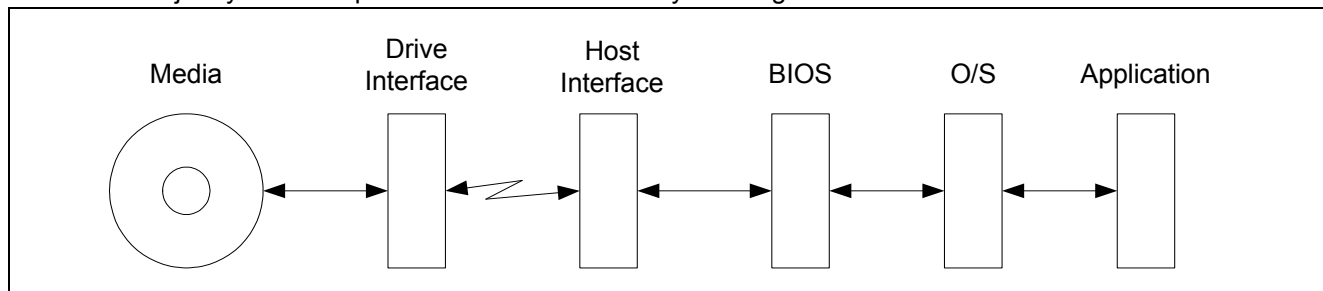

Figure E.1 — System Dependency Chain

There are two competing possibilities for expanding the sector size on the media. One proposal expands the sector size seen at the drive interface; the other keeps the 512-byte sector size at the drive interface. Both possibilities have drawbacks. Figure E.2 illustrates the possibilities.

	Today	512-Byte LB ^a	Physical Sector Size LB ^a	512-Byte LB ^a	Physical Sector Size LB ^a
Interface Sector Size	512 Bytes	512 Bytes Requires RMW, is compatible with system food chain	1,024 Bytes Incompatible with food chain, does not require RMW	512 Bytes Requires RMW, is compatible with system food chain	4,096 Bytes Incompatible with food chain, does not require RMW
Media Sector Size	512 Bytes	1,024 Bytes	1,024 Bytes	4,096 Bytes	4,096 Bytes

^aLogical Block

Figure E.2 — Mapping Proposals

Using the 512-byte LB mechanism, the Drive Interface, Host Interface, BIOS, OS, and Applications still function. Optimal performance is achieved if the OS were modified to properly align the disk accesses. The 512-byte LB mechanism also allows a drive manufacturer to ship a utility with the unit that optimizes performance. If the Physical Sector Size LB mechanism is employed, the existing Drive Interface, Host Interface, BIOS, OS, and Applications may not function. The reason they may not function is that many components in the System Dependency Chain are hardwired to 512 bytes. These hardwired elements include hardware, firmware and software (e.g., if you attach a drive with 1,024-byte sectors at the interface to a system today it should not be able to boot using Windows[®] 2000 or Windows[®] XP). If the host interface is able to transfer the data, it is highly likely that the system BIOS is hardwired to 512 bytes. If the BIOS were able to launch a Windows[®] operating system, the user should find that the operating system is hardwired to 512 bytes and the system may hang. In the case where the BIOS or host interface is hardwired to 512 bytes, no utility may reasonably be used to fix the problem.

This standard provides a mechanism for describing media format and host LBA alignment requirements in the IDENTIFY DEVICE command and as a part of the Long Logical and Long Physical feature sets. Figure E.3 illustrates an example of the capability documented in this standard.

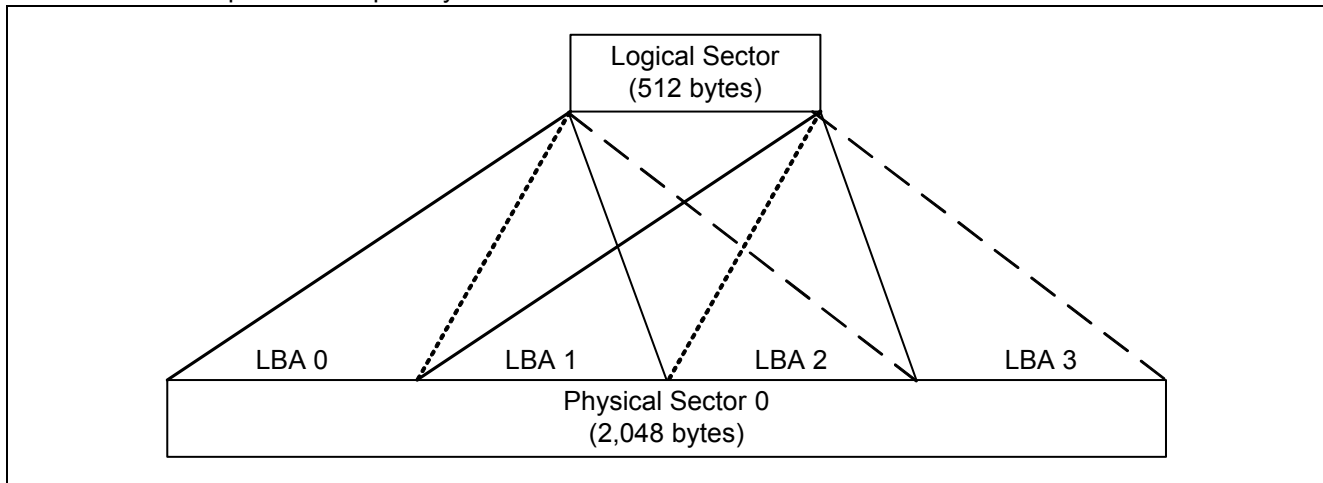

Figure E.3 — Logical to Physical Mapping

In this example, the interface sector size (i.e., logical sector size) is 512 bytes, and the media (physical) sector size is 2,048 bytes. This mechanism allows an ATA device to both implement a larger physical sector and maintain compatibility with existing systems, interfaces, and software. One of the drawbacks of this method is that drive performance may suffer if the host writes data starting or ending on an LBA that is misaligned with respect to the physical sector boundaries. When misalignment occurs, the drive is forced to perform a Read-Modify-Write (RMW) operation in order to satisfy the host request.

ATA also allows the Logical Sector size to be changed. This allows a device to implement a 4,096-byte sector on the media and require that the host transfer 4,096 bytes of data for each logical block requested. This type of implementation avoids the RMW issue noted above. The main drawback of this implementation is that existing systems, interfaces, BIOS and system software, OS and otherwise, have to change in order to accommodate the device.

E.4 Implementation

E.4.1 1,024 Byte Sector Size Implementation

The 1,024-byte sector size allows for greater format efficiency, and a slight increase in performance. The change to 1,024-byte sectors may cause some issues regarding access alignment. These issues should not be seen in an environment that has been optimized for 4,096 byte sector size accessing.

The device indicates the 1,024-byte sector size to the host by returning 6001h in word 106 of IDENTIFY DEVICE data. This indicates that the device has two 512-byte logical sectors to compose a 1,024-byte physical sector. The host may use this information to know that transfers should start on even LBAs and end on odd LBAs for best performance.

Or

The device indicates the 1,024-byte sector size to the host by returning 6000h in word 106 and 400h in words 117-118 of IDENTIFY DEVICE data. This indicates that the device has one 1,024-byte logical sector per 1,024-byte physical sector. The host may use this information to know that transfers require 1,024 bytes per logical block requested.

E.4.2 4,096 Byte Sector Size Implementation

The 4,096-byte sector size allows for greater format efficiency than the 1,024-byte sector size; as well as a slight increase in performance. The change to 4,096-byte sectors causes additional issues regarding access alignment.

The device indicates the 4,096-byte sector size to the host by returning 6003h in word 106 of IDENTIFY DEVICE data. This indicates that the device has eight 512-byte logical sectors to compose a 4,096-byte physical sector. The host may use this information to know that transfers should start with an LBA where the low order 3 bits are zero and the transfer ends on an LBA where the low order 3 bits are one.

Or

The device indicates the 4,096-byte sector size to the host by returning 6000h in word 106 and 1000h in words 117-118 of IDENTIFY DEVICE data. This indicates that the device has one 4,096-byte logical sector per 4,096-byte physical sector. The host may use this information to know that transfers require 4,096 bytes per logical block requested.

E.4.3 Reporting Alignment (512 Byte LBA Only)

This standard defines the ability to report alignment by placing the sector number of the first alignment point in IDENTIFY DEVICE data word 209.

If the drive reports a 4,096-byte physical sector and a 512-byte logical sector, the following word 209 values report the alignment:

- 1) Logical LBA 0 is aligned to the beginning for the first physical sector - word 209 = 4000h
- 2) Logical LBA 0 is offset from the start of the first physical sector by 512 bytes (1 sector) - word 209 = 4001h
- 3) Logical LBA 0 is offset from the start of the first physical sector by 1024 bytes (1 sector) - word 209 = 4002h
- 4) Logical LBA 0 is offset from the start of the first physical sector by 1536 bytes (1 sector) - word 209 = 4003h

- 5) Logical LBA 0 is offset from the start of the first physical sector by 2048 bytes (1 sector) - word 209 = 4004h
- 6) Logical LBA 0 is offset from the start of the first physical sector by 2560 bytes (1 sector) - word 209 = 4005h
- 7) Logical LBA 0 is offset from the start of the first physical sector by 3072 bytes (1 sector) - word 209 = 4006h
- 8) Logical LBA 0 is offset from the start of the first physical sector by 3584 bytes (1 sector) - word 209 = 4007h

For systems that use Windows[®] XP and earlier, and have drives formatted with a single partition, the optimal value is 4001h.

Windows[®] XP and earlier do not check the logical and physical sector size fields reported in IDENTIFY DEVICE data. Therefore, it is recommended to optimize alignment to support the target applications required by the host system.

E.4.4 Read-Modify-Write (RMW) (512-Byte LBA Only)

For devices with a logical sector size of 512 bytes, the drive may be forced to perform RMW when it receives an unaligned transfer. Write commands do not provide a way to return an error other than an Abort (see 6.3.2) or a Device Fault (see 6.2.6). If there is an uncorrectable error encountered during the initial read operation, the Write command has no way to report the issue. Further, this error may affect sectors not accessed by the Write command. There are several possible solutions for drive vendors to choose from in providing the information to the host. Figure E.4 illustrates the issue.

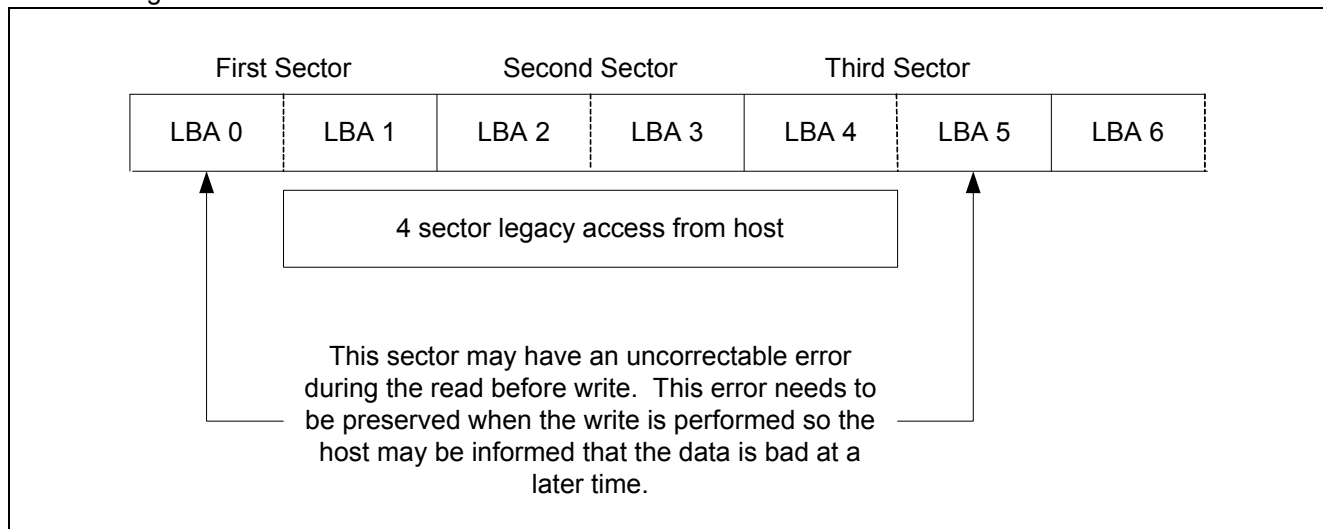

Figure E.4 — Uncorrectable Error Handling

E.5 Implementation Issues (512-Byte LBA Only)

E.5.1 Overview

Although the implementation described here allows a drive to function in a legacy system without modification, there are some issues that are critical in allowing the drive to perform at peak efficiency. Figure E.5 describes a typical device media layout showing the positions of the Master Boot Record (MBR), BIOS Parameter Block (BPB), and the remainder of a FAT based file system. This layout varies based on the type of FAT file system used, but all the elements described here are generally present. The sector numbers on the left hand side of the

figures show typical and/or legacy locations for the various data structures on the media. The following sections describe alignment issues associated with current media layout.

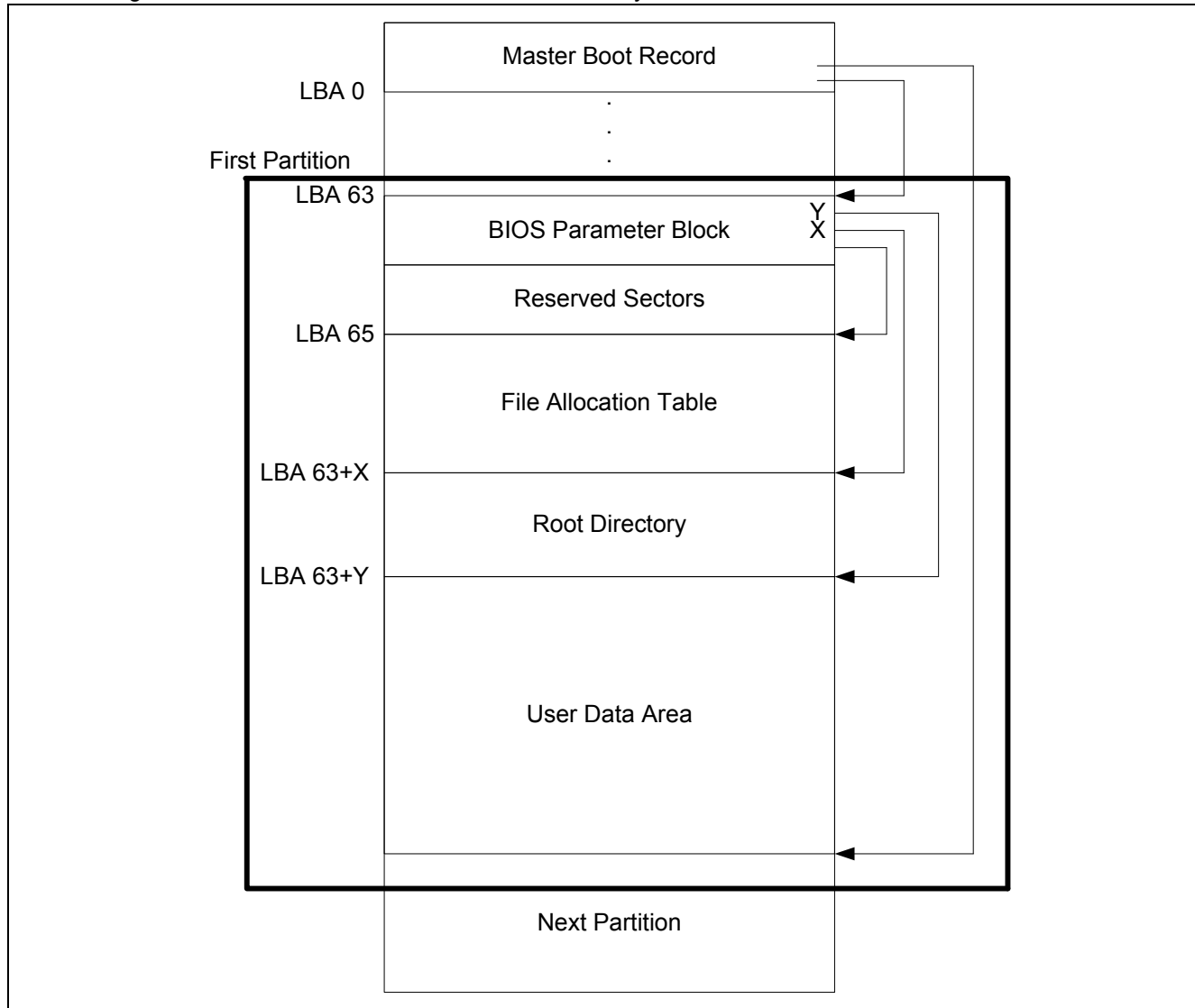

Figure E.5 — Typical HDD Layout Using A Master Boot Record

E.5.2 Drive Partitioning

In 1993 when the HDD industry was still dealing in cylinders heads and sectors, an important milestone was reached that caused drive manufacturers to standardize on 63 sectors per track. The norm for disk partitioning software was to place the Master Boot Record (MBR) at Cylinder 0, Head 0, sector 1 (or LBA 0). The MBR contains a pointer to the first partition. The common practice was to place the first partition at Cylinder 0 Head 1, sector 1. This meant that the LBA value of the first sector in the first partition may vary. Once the sectors per track standardized on 63, the LBA value of the first sector in the first partition standardized on LBA 63. Today, there are some applications that check to make sure that partitions start on a track boundary, even though there is no meaning for cylinders heads and sectors.

As we move forward and create larger sectors, partition alignment becomes an important issue. In the case of a 1,024-byte sector device, the partitions should start on an even numbered sector and end on an odd numbered sector. If the drive implements a 4,096-byte sector on the media, then the partition should start on an LBA where the low order 3 bits are zero.

For drives that use 512-byte LBA, all partitions should start on an LBA that is aligned with the start of a physical sector on the media. This affects some applications that check to make sure the first partition starts on sector 63, but a change is required to implement larger sectors on the media.

E.5.3 File System Formatting

There are many file systems that cluster sectors together to create an allocation unit larger than a single 512-byte sector. These file systems generally implement a table to associate clusters with files, commonly called a File Allocation Table (FAT). A typical cluster size is 4,096 bytes or eight 512-byte sectors. Even if the Partition is properly aligned, there is an issue where the size of the FAT may cause the individual clusters in the user data area to be unaligned relative to the physical sectors on the media. This also results in performance degradation.

If the clusters in the file system are properly aligned, file accesses is naturally aligned in many cases and performance is not degraded.

E.5.4 Virtual Memory accessing

Once the clusters in the file system are aligned, the OS memory manager needs to be modified to prevent unaligned accesses. When a drive has alignment requirements, disk performance tests may show acceptable performance, but if the virtual memory activity is not aligned, CPU performance tests may provide unacceptable results.

E.5.5 Booting

The drives with alignment requirements should not show significant performance degradation on unaligned reads. Since booting is mainly a reading process, an impact on system boot times in an unaligned environment is not expected.