

# Power Analyser

## UMG 96 RM-EL

Operating instructions and  
technical data

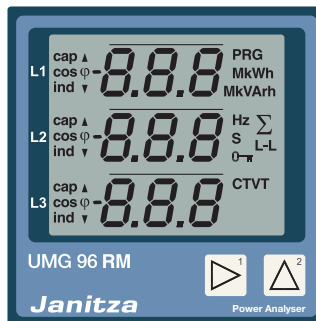

Janitza electronics GmbH  
Vor dem Polstück 1  
D-35633 Lahnau  
Support tel. 0049 6441 9642-22  
Fax 0049 6441 9642-30  
E-mail: [info@janitza.com](mailto:info@janitza.com)  
Internet: <http://www.janitza.com>

**Janitza®**

**Contents**

<b>General</b>	<b>4</b>	Programming parameters	38
<b>Inspection on receipt</b>	<b>6</b>	TCP/IP configuration	39
Scope of delivery – UMG 96RM-EL	7	<b>Parameters</b>	<b>42</b>
Available accessories	7	User password (addr. 050)	42
<b>Product description</b>	<b>8</b>	Mean value	43
Intended use	8	Averaging method	43
Performance characteristics - UMG 96RM-EL	9	Min. and max. values	44
Measuring method	10	Energy meter	44
Operating concept	10	Mains frequency (Addr. 034)	45
GridVis network analysis software	10	Harmonics	46
Connection variants	11	Measured value relay	47
<b>Assembly</b>	<b>12</b>	Measured value displays	47
<b>Installation</b>	<b>14</b>	Reset energy meter (Addr. 507)	49
Supply voltage	14	Phase sequence	49
Voltage metering	16	LCD contrast (Addr. 035)	50
Current measurement	22	Backlight	50
Ethernet interface	28	Time recording	51
<b>Operation</b>	<b>30</b>	Operating hours meter	51
Display mode	30	Serial number (Addr. 754)	52
Programming mode	30	<b>Commissioning</b>	<b>53</b>
Parameters and measured values	32	Applying the supply voltage	53
<b>Configuration</b>	<b>34</b>	Applying the measured voltage	53
Applying the supply voltage	34	Applying the measured current	53
Current and voltage transformers	34	Rotation field direction	54
Programming current transformers	36	Checking the phase assignment	54
Programming voltage transformers	37	Checking the power measurement	54

Checking the measurement	54
Checking the individual power ratings	54
Check the sum power ratings	55
Comparators and monitoring threshold values	55
Comparator in the GridVis software	59
<b>Service and maintenance</b>	<b>60</b>
Service	60
Device calibration	60
Calibration intervals	60
Firmware update	61
<b>Error messages</b>	<b>62</b>
<b>Technical data</b>	<b>68</b>
Function parameters	72
Table 1 - Parameter list	74
Number formats	79
Dimensional drawings	80
<b>Measured value displays overview</b>	<b>82</b>
<b>Declaration of conformity</b>	<b>88</b>
<b>Connection example</b>	<b>90</b>
<b>Basic functions quick guide</b>	<b>91</b>
<b>TCP/IP addressing quick guide</b>	<b>92</b>

## General

### Copyright

This operating manual is subject to the legal requirements for copyright protection and may not be, either in whole or in part, photocopied, reprinted, or reproduced by mechanical or electronic means, or in any other manner be duplicated or redistributed without the legally binding, written agreement of

Janitza electronics GmbH, Vor dem Polstück 1,  
D 35633 Lahnuau, Germany.

### Trademarks

All trademarks and their resulting rights belong to the respective holders of these rights.

### Disclaimer

Janitza electronics GmbH takes no responsibility for errors or defects within this operating manual and takes no responsibility for keeping the contents of this operating manual up to date.

## Comments on the operating manual

We welcome your comments. In the event that anything in this operating manual seems unclear, please let us know and send us an EMAIL to: [info@janitza.de](mailto:info@janitza.de)

## Meaning of the symbols

The following pictograms are used in the operating manual at hand:



### Dangerous voltage!

Danger to life or risk of serious injury. Disconnect system and device from power supply before beginning work.



### Caution!

Please follow the documentation. This symbol warns of possible dangers that can arise during installation, commissioning and use.



### Note!

## Instructions for use

Please read the operating manual at hand as well as all other publications that must be drawn from for working with this product (in particular for the installation, operation or maintenance).

Follow all safety regulations and warning information. If you do not follow the information, it can result in bodily injury and/or damage to the product.

Any unauthorized changes or use of this device, which transcend the mechanical, electrical or otherwise stated operating limitations, can result in bodily injury or/and damage to the product.

Any of such unauthorized changes constitute „misuse“ and/or „negligence“ in terms of the warranty for the product and therefore eliminates the warranty for covering any potential damage resulting from this.

This device is to be operated and maintained exclusively by specialized personnel.

Specialized personnel are persons, that based on their respective training and experience, are qualified to recognize risks and prevent potential dangers that can be caused by the operation or maintenance of the device.

Additional legal and safety regulations required for the respective application are to be following during the use of the device.



If the device is not operated according to the operating manual, protection is no longer ensured and danger can come from the device.



Conductors made from single wires must be fitted with wire-end ferrules.



Only pluggable screw terminals with the same number of poles and the same type of construction are permitted to be connected together.

## Concerning these operating instructions

These operating instructions are a part of the product.

- Read the operating instructions before using the device.
- Keep the operating instructions throughout the entire service life of the product and have them readily available for reference.
- Pass the operating instructions on to each subsequent owner or user of the product.



All screw-type terminals included in delivery are attached to the device.

## Inspection on receipt

The prerequisites of faultless, safe operation of this device are proper transport and proper storage, set-up and assembly, as well as careful operation and maintenance. If it can be assumed that risk-free operation is no longer possible, the unit must be immediately put out of operation and secured against being put back into operation again.

The packing and unpacking must be carried out with the customary care without the use of force and only using suitable tools. The devices should be visually checked for flawless mechanical condition.

It can be assumed that risk-free operation is no longer possible if the device, for example,

- has visible damage
- no longer works despite the mains power supply being intact
- has been exposed to long-term adverse conditions (e.g. storage outside the permissible climate limits without being adapted to the room climate, condensation etc.) or rough handling during transportation (e.g. fall from a height, even if there is no visible external damage etc.)
- Please check the delivered items for completeness before you start installing the device.

**Scope of delivery – UMG 96RM-EL**

Number	Part no.	Description
1	52.22.040	UMG 96RM-EL
2	29.01.036	Mounting clips
1	33.03.164	Operating instructions
1	51.00.116	CD with following content. - GridVis programming software - GridVis functional description
1	10.01.855	Screw-type terminal, pluggable, 2-pole (auxiliary power)
1	10.01.849	Screw-type terminal, pluggable, 4-pole (voltage measurement)
1	10.01.871	Screw-type terminal, pluggable, 6-pole (current measurement I1-I3)
1	08.01.505	Patch cable 2m, coiled, grey (connection UMG 96RM-EL – PC/Switch)

**Available accessories**

Part no.	Description
29.01.907	Seal, 96 x 96

## Product description

### Intended use

The UMG 96RM-EL is provided for the measurement and calculation of electrical parameters such as voltage, current, power, energy, harmonics, etc. for building installations, to distributors, circuit breakers and busbar trunking systems.

The UMG 96RM-EL is suitable for installation in permanent, weatherproof switchboards. Conducting switchboards must be earthed. It can be mounted in any position.

Measurement voltages and measurement currents must originate from the same grid.

The measurement results can be displayed and can be read and processed over the Ethernet interface.

The voltage measurement inputs are designed for measuring in low voltage grids in which nominal voltages up to 300V phase can occur in countercurrent with ground and overvoltages of overvoltage category III.

The UMG 96RM-EL current measurement inputs are connected via external  $\dots/1A$  or  $\dots/5A$  current transformers.

Measurements in medium and high voltage systems generally use current and voltage transformers.

The UMG 96RM-EL can be used in residential and industrial areas.

### Device characteristics

- Installation depth: 45 mm
- Supply voltage:  
20V - 250V (45..65Hz) or DC 20V - 300V
- Frequency range: 45-65 Hz

### Device functions

- 3 voltage measurements, 300 V
- 3 current measurements  
(via current transformer)
- Ethernet interface



## Performance characteristics - UMG 96RM-EL

### General

- Front panel integration device with dimensions 96x96 mm.
- Connection via pluggable screw terminals
- LCD display with backlighting
- Operation via 2 buttons
- 3 voltage measurements inputs (300V CATIII)
- 3 current measurement inputs for current transformer.
- Ethernet interface
- Working temperature range -10°C .. +55°C
- Storage of minimum and maximum values (without time stamp).

### Uncertainty in measurement

- Active energy uncertainty in measurement class 0.5 for ../5A transformer
- Active energy uncertainty in measurement class 1 for ../1A transformer
- Reactive energy, class 2

### Measurement

- Measurement in IT, TN and TT networks
- Measurement in networks with nominal voltage up to L-L 480V and L-N 277V
- Measuring range current 0 to 5A eff.
- True RMS (TRMS)
- Continuous sampling of the voltage and current measurement inputs
- Frequency range of the mains frequency 45 Hz .. 65 Hz.
- Measurement of harmonics 1 to 40 for ULN and I.
- Uln, I, P (import/delivery), Q (ind./cap.).
- Fourier analyses 1 to 40. Harmonic for U and I.
- 7 Energiezähler für
  - Active energy (import)
  - Active energy (export)
  - Active energy (without a backstop)
  - Reactive energy (ind.)
  - Reactive energy (capacitive)
  - Reactive energy (without a backstop)
  - Apparent energy
  - each for L1, L2, L3 and total.

## Measuring method

The UMG 96RM-EL measures uninterrupted and calculates all root mean squares over a 10/12-period interval (200ms). The UMG 96RM-EL measures the true root mean square (TRMS) of the voltages and currents applied to the measuring inputs.

## Operating concept

There are several ways to program the UMG 96RM-EL and retrieve measured values.

- Directly on the device using two buttons.
- Via the programming software of the GridVis.

These operating instructions only describe the operation of the UMG 96RM-EL using the 2 buttons.

The programming software of the GridVis has its own “online help”.

## GridVis network analysis software

The UMG 96RM-EL can be programmed and read with the GridVis network analysis software which is part of the scope of delivery. For this a PC must be connected to the UMG 96RM-EL via Ethernet.

## Characteristics of GridVis

- Programming the UMG 96RM-EL
- Graphic representation of measured values

## Connection variants

Direct connection of a UMG 96RM-EL to a PC via Ethernet.



Connecting a UMG 96RM-EL to a PC via Ethernet.

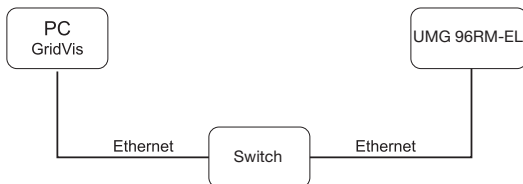

## Assembly

### Installation location

The UMG 96RM-EL is suitable for installation in permanent, weatherproof switchboards. Conducting switchboards must be earthed.

### Installation position

The UMG 96RM-EL must be installed vertically in order to achieve sufficient ventilation. The clearance to the top and bottom must be at least 50 mm and 20 mm at the sides.

### Front panel cutout

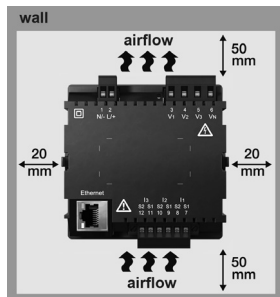

Cutout dimensions:  
 $92^{+0.8} \times 92^{+0.8}$  mm.

*Fig. UMG 96RM-EL  
 installation location  
 (rear view)*

### Mounting

The UMG 96RM-EL is mounted on the switchboard by the side mounting brackets. These must be removed before using the device. Mounting is carried out by inserting and engaging the brackets.

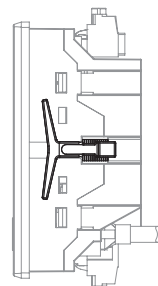

*Fig. UMG 96RM-EL  
 mounting bracket  
 (side view)*



Failure to comply with the minimum spacing can destroy the UMG 96RM-EL at high ambient temperatures!



## Installation

### Supply voltage

A supply voltage is required to operate the UMG 96RM-EL.

The voltage supply is connected via plug-in terminals on the back of the device.

Before applying the supply voltage, ensure that the voltage and frequency correspond with the details on the nameplate!

The supply voltage must be connected via a UL/IEC approved fuse (6 A, type C).

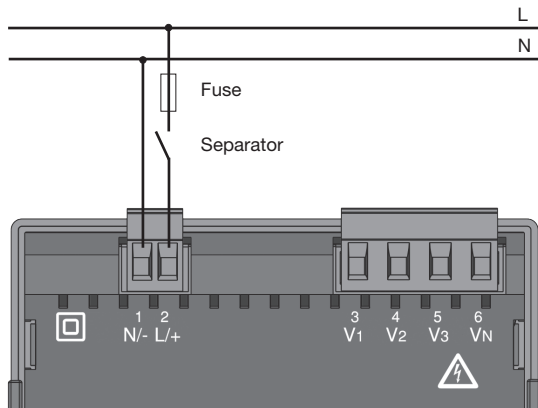

*Fig. Connection example of the supply voltage to the UMG 96RM-EL*



- In building installations, the supply voltage must be provided with a disconnect switch or circuit breaker.
- The disconnect switch must be attached near the device and must be easily accessible by the user.
- The switch must be labelled as a separator for this device.
- Voltages that exceed the permissible voltage range can destroy the device.

### Voltage metering

The UMG 96RM-EL can be used for voltage measurement in TN, TT and IT systems.

Voltage measurement in the UMG 96RM-EL is designed for the 300 V overvoltage category CATIII (4 kV rated pulse voltage).

In systems without a neutral, measured values that require a neutral refer to a calculated neutral.

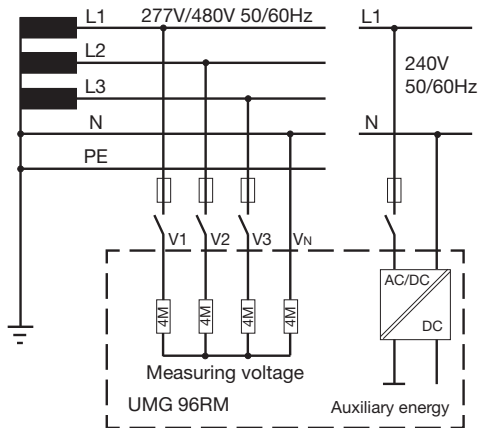

Fig. Principle circuit diagram - Measurement in three-phase 4-wire systems.

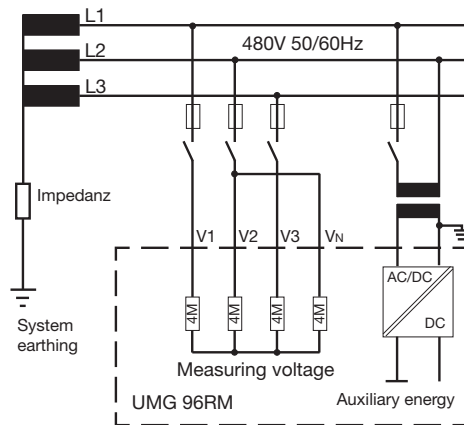

Fig. Principle circuit diagram - Measurement in three-phase 3-wire systems.



## Rated mains voltage

Lists of the networks and their rated mains voltage in which the UMG 96RM-EL can be used.

### Three-phase 4-wire systems with earthed neutral conductor.

$U_{L-N} / U_{L-L}$
66 V/115 V
120 V/208 V
127 V/220 V
220 V/380 V
230 V/400 V
240 V/415 V
260 V/440 V
277 V/480 V

Maximum rated voltage of the network

*Fig. Table of the rated mains voltages suitable for the voltage measuring inputs according to EN60664-1:2003.*

### Unearthed three-phase, 3-wire systems.

$U_{L-L}$
66 V
120 V
127 V
220 V
230 V
240 V
260 V
277 V
347 V
380 V
400 V
415 V
440 V
480 V

Maximum rated voltage of the network

*Fig. Table of the rated mains voltages suitable for the voltage measuring inputs according to EN60664-1:2003.*

## Voltage measurement inputs

The UMG 96RM-EL has three voltage measurement inputs (V1, V2, V3).

### Overvoltage

The voltage measurement inputs are suitable for measurement in networks in which overvoltages of overvoltage category 300V CATIII (4 kV rated pulse voltage) can occur.

### Frequency

The UMG 96RM-EL requires the mains frequency for the measurement and calculation of measured values. The UMG 96RM-EL is suitable for measurements in the frequency range of 45 to 65 Hz.

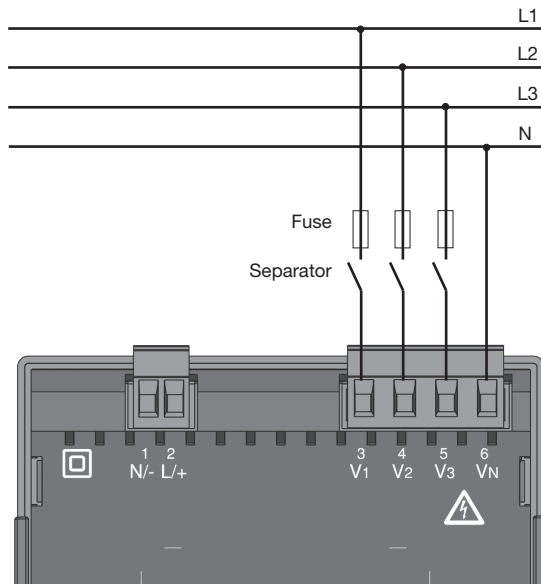

Fig. Connection example for the voltage measurement

When connecting the voltage measurement, the following must be observed:

- A suitable separator must be provided in order to switch off the power to the UMG 96RM-EL.
- The separator must be placed near the UMG 96RM-EL, marked for the user and easily accessible.
- Use a fuse protected, UL/IEC approved 10A circuit breaker (type C) as an overcurrent protection device and separator.
- The overcurrent protection device must have a nominal value that is designed for the short circuit current on the connection point.
- Measurement voltages and measurement currents must originate from the same grid

**Attention!**

Voltages that exceed the permitted rated mains voltages must be connected via voltage transformers.

**Attention!**

The UMG 96RM-EL is not suitable for the measurement of DC voltages.

**Attention!**

The voltage measurement inputs on the UMG 96RM-EL are dangerous to touch!

## Connection diagram, voltage measurement

- 3p 4w (addr. 509 = 0), factory setting

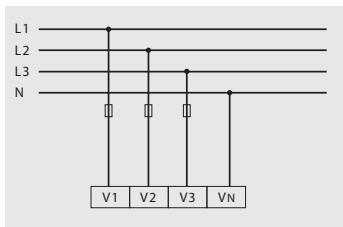

Fig. System with three-phase conductors and a neutral conductor.

- 3p 4u (addr. 509 = 2)

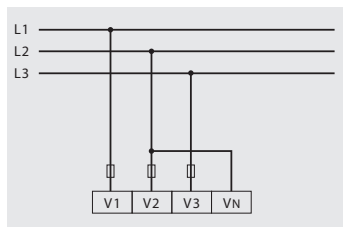

Fig. System with three-phase conductors and no neutral conductor. Measured values that require a neutral refer to a calculated neutral.

- 3p 4wu (addr. 509 = 1)

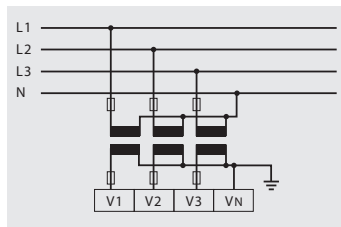

Fig. System with three-phase conductors and a neutral conductor. Measurement via voltage transformer.

- 3p 2u (addr. 509 = 5)

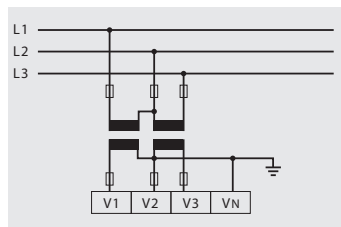

Fig. System with three-phase conductors and no neutral conductor. Measurement via voltage transformer. Measured values that require a neutral refer to a calculated neutral.

- 1p 2w1 (addr. 509 = 4)

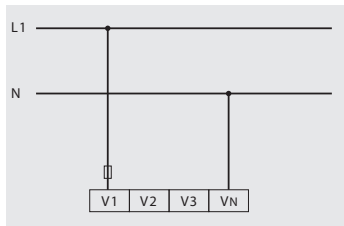

Fig. Measured values derived from the V2 and V3 voltage measurement inputs are assumed to be zero and not calculated.

- 1p 2w (addr. 509 = 6)

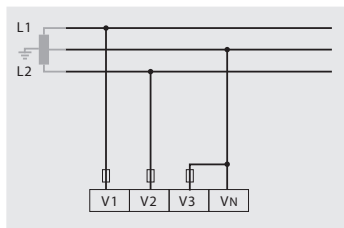

Fig. TN-C system with single-phase, three-wire connection. Measured values derived from the V3 voltage measurement input Zero are assumed to be zero and not calculated.

- 2p 4w (addr. 509 = 3)

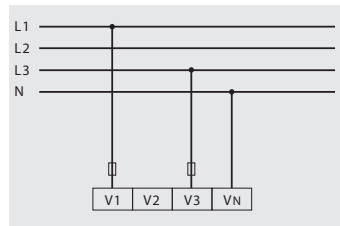

Fig. System with uniform phase loading. The measured values for the V2 voltage measurement input are calculated.

- 3p 1w (addr. 509 = 7)

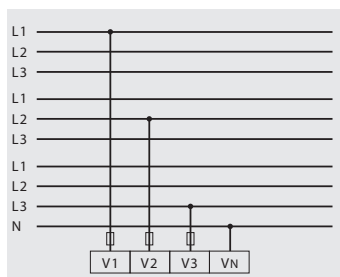

Fig. Three systems with uniform phase loading. The measurement values L2/L3 resp. L1/L3 resp. L1/L2 of the respective system are calculated.

## Current measurement

The UMG 96RM-EL is designed for connecting current transformers with secondary currents of  $..1A$  and  $..5A$ . The factory set current transformer ratio is  $5/5 A$  and may need to be adapted to the current transformers.

It is not possible to perform a direct measurement without a current transformer with the UMG 96RM-EL.

Only AC currents (and not DC currents) can be measured.



### Earthing of current transformers!

If a connection is provided for the earthing of secondary windings then this must be connected to the earth.



### Attention!

The UMG 96RM-EL is not suitable for the measurement of DC voltages.



### Attention!

The current measurement inputs are dangerous to touch.

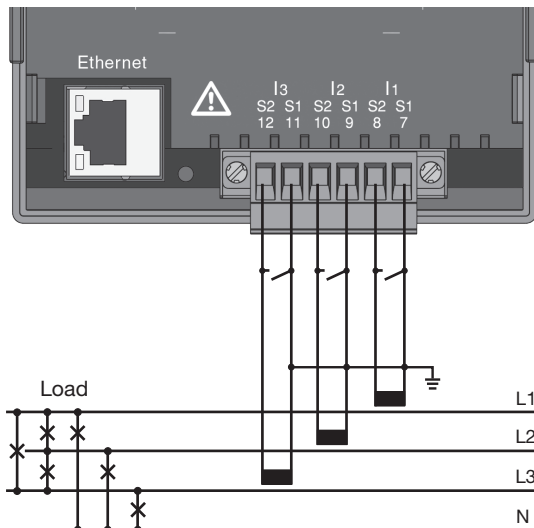

Fig. Current measurement via current transformer (connection example)



The attached screw terminal has to be fixed sufficiently with two screws on the device!

## Direction of the current

The current direction can be individually corrected on the device or via the serial interfaces for each phase.

In the case of incorrect connection, the current transformer does not need to be subsequently reconnected.



### Earthing of current transformers!

If a connection is provided for the earthing of secondary windings then this must be connected to the earth.



### Current transformer connections!

The secondary connection of the current transformer must be short-circuited on this before the current feed to the UMG 96RM-EL is disconnected!

If a test switch, which automatically short-circuits the secondary wires of the current transformer, is available then it is sufficient to set this to the „Test“ position insofar as the short-circuiting device has been checked beforehand.



### Open-circuit current transformers!

High voltage spikes that are dangerous to touch can occur on current transformers that are driven with open-circuit secondary windings!

With “safe open-circuit current transformers” the winding insulation is rated such that the current transformer can be driven open. However, even these current transformers are dangerous to touch when they are driven open-circuit.

## Connection diagram, current measurement

- 3p 4w (addr. 510 = 0), factory setting

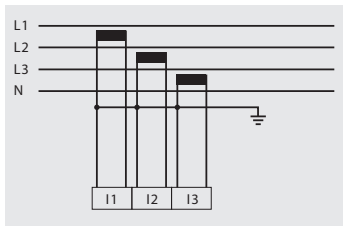

Fig. Measurement in a three-phase net-work with an unbalanced load.

- 3p 2i (addr. 510 = 1)

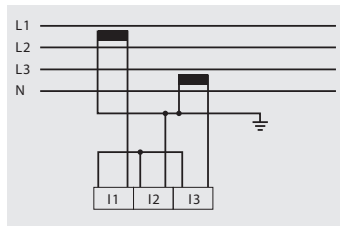

Fig. System with uniform phase loading. The measured values for the I2 current measurement input are measured.

- 3p 2i0 (addr. 510 = 2)

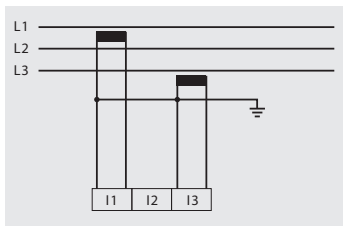

Fig. The measured values for the I2 current measurement input are calculated.

- 3p 3w3 (addr. 510 = 3)

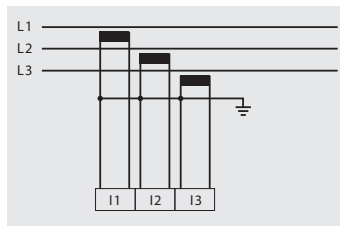

Fig. Measurement in a three-phase net-work with an unbalanced load.



- 3p 3w (addr. 510 = 4)

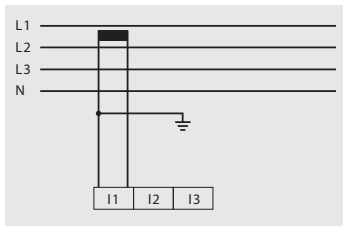

Fig. System with uniform phase loading. The measured values for the I2 and I3 current measurement inputs are calculated.

- 2p 4w (addr. 510 = 5)

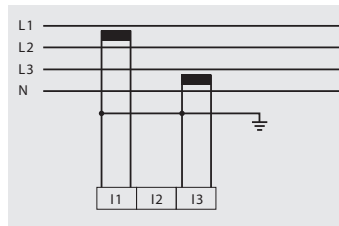

Fig. System with uniform phase loading. The measured values for the I2 current measurement input are calculated.

- 1p 2i (addr. 510 = 6)

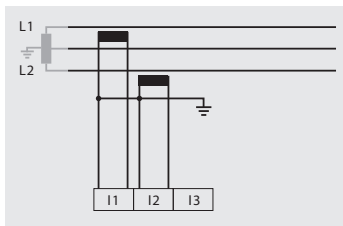

Fig. Measured values derived from the I3 current measurement input are assumed to be zero and not calculated.

- 1p 2w (addr. 510 = 7)

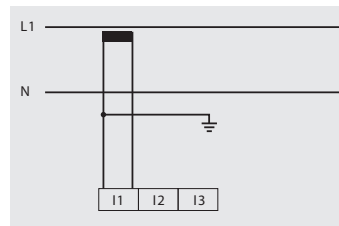

Fig. Measured values derived from the I2 and I3 current measurement inputs are assumed to be zero and not calculated.

## Connection diagram, current measurement

- 3p 1w (addr. 510 = 8)

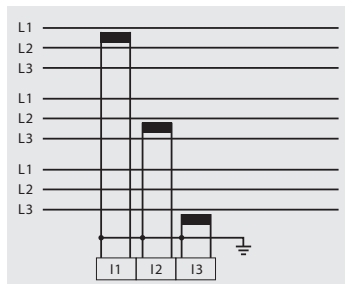

Fig. Three systems with uniform phase loading. The current measurement values of the phases of the respective system where are no CTs connected are calculated ( $I_2/I_3$  resp.  $I_1/I_3$  resp.  $I_1/I_2$ ).

## Ammeter

If you want to measure the current not only with the UMG 96RM-EL but also with the ammeter, the ammeter must be connected in series with the UMG 96RM-EL.

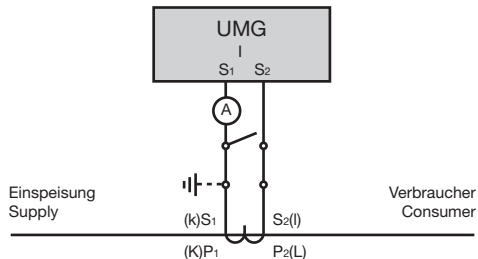

Fig. Current measurement with an additional ammeter (example).



### Caution!

The UMG96RM is only approved for a current measurement using the current transformer.

## Total current measurement

If the current measurement takes place via two current transformers, the total transformer ratio of the current transformer must be programmed in the UMG 96RM-EL.

Example: The current measurement takes place via two current transformers. Both current transformers have a transformer ratio of 1000/5 A. The total measurement is performed with a 5+5/5 A total current transformer.

The UMG 96RM-EL must then be set as follows:  
 Primary current:  $1000\text{ A} + 1000\text{ A} = 2000\text{ A}$   
 Secondary current:  $5\text{ A}$

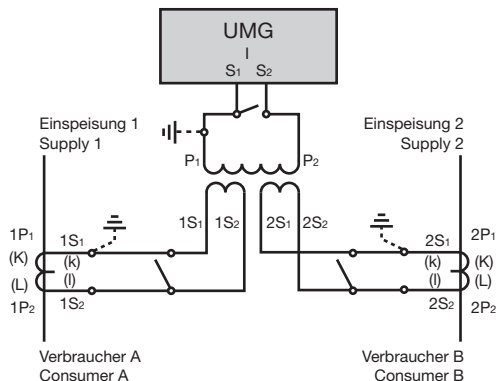
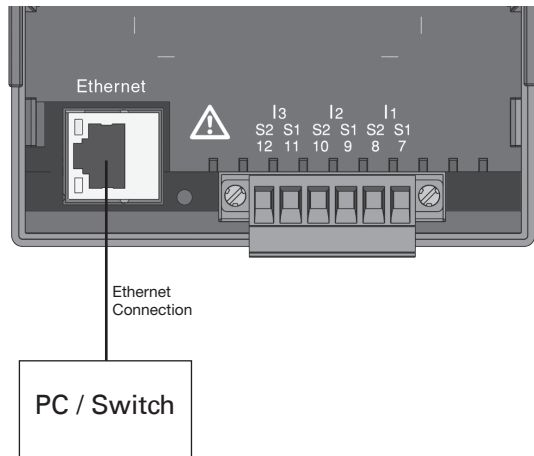

Fig. Current measurement via a total current transformer (example).

## Ethernet interface

The Ethernet network settings should be specified by the network administrator and set on UMG 96RM-EL accordingly.

If the network settings are not known, the UMG 96RM-EL may not be integrated into the network through the patch cable.



### Caution!

Connection of the UMG96RM-EL to the Ethernet may only be carried out after discussion with the network administrator!



### Caution!

The UMG 96RM-EL is factory-programmed for the dynamic allocation of the IP settings (**DHCP mode**).

Settings can be changed as described in TCP/IP Configuration or, for example, via an appropriate Ethernet connection by means of GridVis software.



## Operation

The UMG 96RM-EL is operated via buttons 1 and 2 with the following functions:

- briefly pressing button 1 and 2:  
next step (+1)
- pressing and holding button 1 and 2:  
previous step (-1)

Measured values and programming data are displayed on an LCD display.

There are *display* and *programming* modes. You can avoid an unintentional change of programming data by entering a password.

### Display mode

In display mode, you can scroll through the programmed measured values by pressing buttons 1 and 2. When the device is delivered, all measured value indications of profile 1 can be retrieved. For each measured value, up to three measured values are indicated. The measured value rotation can display selected measured value indications one after the other with a selectable changing time.

## Programming mode

You can view and change the necessary settings of the UMG 96RM-EL in programming mode. Press button 1 and 2 simultaneously for about 1 second to switch to programming mode after entering the password. If no password is programmed, you get directly to the programming mode menu. Programming mode is marked by the text „PRG“ on the display.

Press button 2 to switch between the following menus:

- Current transformer,
- Voltage transformer,
- Parameter list,
- TCP/IP device address,
- Subnet mask,
- Gateway address,
- Dynamic TCP/IP addressing (in/out).

If no button was pressed for about 60 seconds when you are in programming mode, or button 1 and 2 are pressed simultaneously for about 1 second, the UMG 96RM-EL will switch back to display mode.

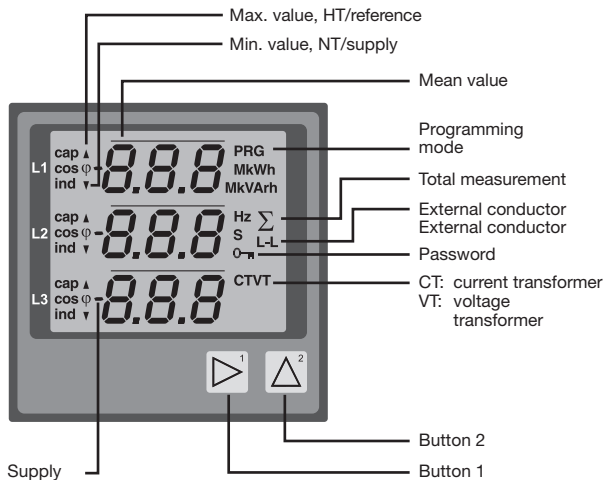

## Parameters and measured values

All parameters necessary for operating the UMG 96RM-EL, e.g. the current transformer data, and a selection of frequently required measured values are stored in the table.

The contents of most addresses can be accessed via the serial interface and the buttons on the UMG 96RM-EL.

Only the first 3 significant digits of a value can be entered on the device. Values with more digits can be entered using GridVis.

The device always only displays the first 3 significant digits of a value.

Selected measured values are summarised in measured value display profiles and can be shown in display mode using buttons 1 and 2.

The current measured value display profile and the current display change profile can only be read and changed via the Ethernet interface.

## Example of the parameter display

On the UMG 96RM-EL display the value “006” is shown as the content of address “036”. This parameter reflects the brightness of the backlighting (0=dark, 9=bright).



## Example of the measured value display

In this example, the UMG 96 RM-EL display shows the voltages L to N with 230 V each.





## Button functions

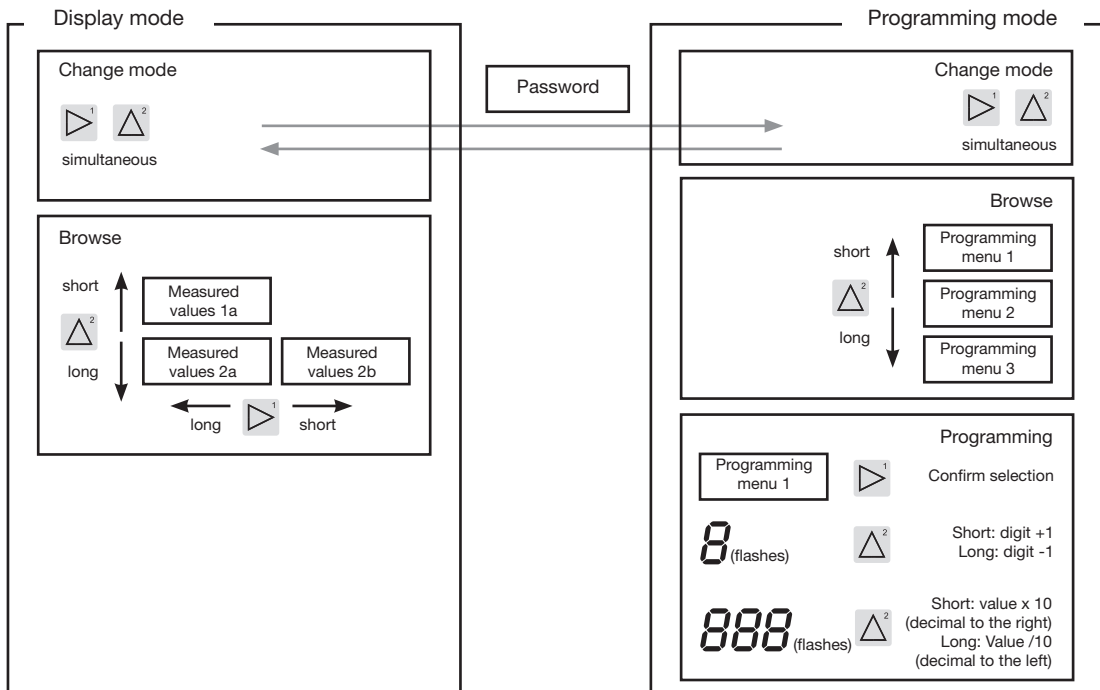

## Configuration

### Applying the supply voltage

To configure the UMG 96RM-EL, the supply voltage must be connected.

The level of supply voltage for the UMG 96RM-EL can be found on the nameplate.

If no display appears, check the operating voltage to determine whether it is within the rated voltage range.

### Current and voltage transformers

A current transformer is set to 5/5 A in the factory. The pre-programmed voltage transformer ratio only needs to be changed if voltage transformers are connected.

When connecting voltage transformers, the measurement voltage on the UMG 96RM-EL nameplate must be observed!



#### Attention!

Supply voltages that do not correspond to the nameplate information can lead to device malfunction or destruction.



The adjustable value 0 for the primary current transformer does not produce any useful energy values and must not be used.



Devices, which are programmed to automatic frequency detection, need approximately 20 seconds to detect grid frequency. During this period, the measured values do not keep the confirmed measuring accuracy.



Prior to commissioning potential production dependant contents of the energy counter and min/max values have to be deleted.



### Current and voltage transformers

The GridVis software included with delivery can be used to individually program the current and voltage transformer input transformer ratios.

Only the transformer ratio of the respective group of the current inputs I1-I3 and the voltage measurement inputs V1-V3 can be adjusted on the device.

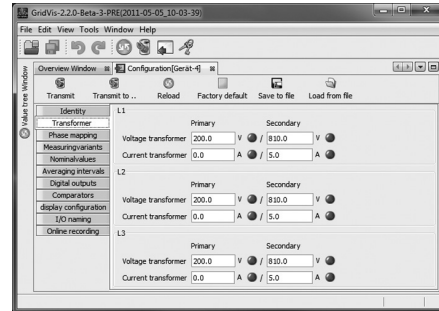

*Fig. Indication to configure the current and voltage transformers in the GridVis software.*

## Programming current transformers

### Switching to programming mode

- Simultaneously press buttons 1 and 2 in order to switch to programming mode. If a user password was programmed, the password request will appear with "000". The first digit of the user password flashes and can be changed with button 2. The next digit is selected by pressing button 2 and will begin flashing. If the correct combination was entered or if no user password was programmed, the device will enter programming mode.
- The symbols for the programming mode (PRG) and for the current transformer (CT) appear.
- Confirm the selection with button 1.
- The first digit of the input area for the primary current starts flashing.

### Current transformer primary current input

- Change the flashing digit with button 2.
- Select the next digit to be changed with button 1. The selected digit to be changed starts flashing. If the entire number is flashing, the decimal point can be moved with button 2.

### Current transformer secondary current input

- Only 1 A or 5 A can be set as the secondary current.
- Select the secondary current with button 1.
- Change the flashing digit with button 2.

### Leaving programming mode

- Simultaneously press buttons 1 and 2 to exit the programming mode.

## Programming voltage transformers

- Switch to the programming mode as described. The symbols for the programming mode (PRG) and for the current transformer (CT) appear.
- Use button 2 to switch to the voltage transformer setting.
- Confirm the selection with button 1.
- The first digit of the input area for the primary current starts flashing. The ratio of primary to secondary voltage of the voltage transformer can be set in the same way as the assignment of the current transformer ratio of primary to secondary current.

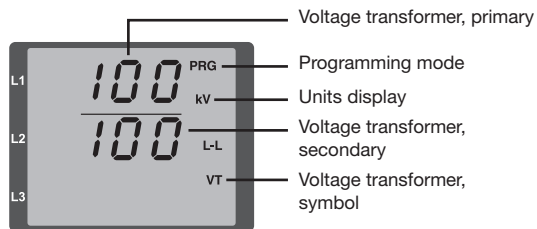
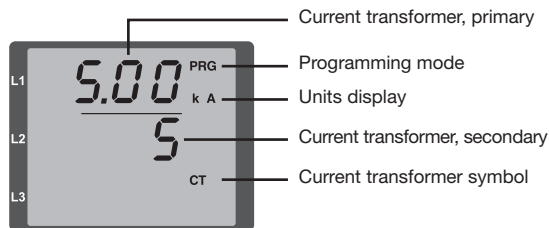

## Programming parameters

### Switching to programming mode

- Switch to the programming mode as described. The symbols for the programming mode (PRG) and for the current transformer (CT) appear.
- Use button 2 to switch to the voltage transformer setting. The first parameter of the parameter list is shown by repeatedly pressing button 2.

### Changing parameters

- Confirm the selection with button 1.
- The most recently selected address is displayed with the associated value.
- The first digit of the address flashes and can be changed using button 2. Button 1 provides a selection of digits that, in turn, can be changed with button 2.

### Changing the value

- Once the desired address is set, a digit of the value is selected with button 1 and changed with button 2.

### Leaving programming mode

- Simultaneously press buttons 1 and 2 to exit the programming mode.



*Fig. Password request*  
If a password was set, it can be entered using buttons 1 and 2.



*Fig. Current transformer programming mode*  
The primary and secondary currents can be changed using buttons 1 and 2 (cf. page 36).



*Fig. Programming mode Voltage transformer*  
The primary and secondary currents can be changed using buttons 1 and 2 (cf. page 37).



*Fig. Programming mode Parameter display*  
The individual parameters can be changed using buttons 1 and 2 (cf. page 32).

## TCP/IP configuration

Within an Ethernet, each device has a unique TCP / IP address that can be assigned manually or from a DHCP server. The 4-byte device address (0 to 3 byte) can be extended in the TCP / IP configuration using the subnet mask and gateway data.

Setting the TCP / IP device address (addr) manually

- Select in the programming mode as described. The symbols for the programming mode PRG and the current transformer mode CT appear on the display.
- Press button 2 three times to get to the TCP / IP settings for the device addressing.
- Press button 1 to select the desired digit. The selection is indicated by a flashing digit.
- Press button 2 to adjust the selected digit.
- Use button 1 to select the next digit and set it again by pressing button 2.
- If byte is set to 0, the TCP / IP address can be set from 1 to 3 by pressing button 1. Then the display jumps back to Byte 0 (**no** digit is flashing).

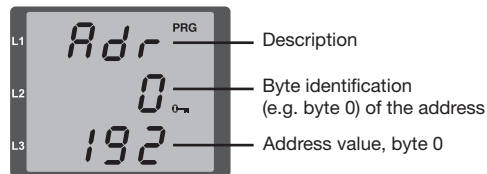

Fig. TCP/IP address, byte 1  
A TCP / IP address consists of 4 bytes with the following structure:



Example: 192.168.003.177

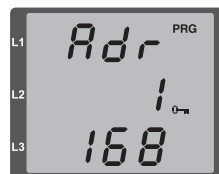

Fig. TCP / IP address,  
byte 2, value 003



Fig. TCP / IP address,  
byte 3, value 177



#### Manual setting of the subnet mask (Sub)

- When in the programming mode, press button 2 to get to the subnet mask settings (SUB display).
- Use button 1 to select the desired digit and set it by pressing button 2. Repeat this step for each digit in bytes 0 to 3 in a way similar to setting the TCP / IP device address.
- After repeated display of byte 0 (**no** digit is flashing) one can set the gateway address.

#### Manual setting of the gateway address (GAt)

- When in the programming mode, press button 2 to get to the gateway address settings (GAt display).
- Press buttons 1 and 2 to set the desired gateway address in bytes 0 to 3 as described above.

The dynamic IP allocation must also be deactivated to ensure that the manual settings of the TCP / IP device address, subnet mask and gateway address are not overwritten by a DHCP server. To do so set the parameter „dyn IP“ to a value of 0 or 3 (see „IP mode configuration“ table) as described under „Dynamic IP allocation“.

#### Dynamic IP allocation (dyn)

The dynamic allocation of the TCP / IP settings (device/gateway address and subnet mask) provides for a fully automated integration of the device into an existing network with a DHCP server. TCP / IP settings do not need to be configured manually as they are automatically assigned by the DHCP server when the device is started.

Addresses are read out in the programming mode the same way as in the manual settings.

- Switch to the programming mode as described. The symbols for the programming mode PRG and the current transformer mode CT appear on the display.
- Press button 2 several times to display the dynamic IP allocation (dYn IP).
- Activate the parameter with button 1 (1st digit flashes) and then select the last digit (digit flashes) with button 1. Use button 2 to set the parameter to 2 or 5 in accordance with the „IP mode configuration“ table.
- Confirm the parameter with button 1 and exit programming mode or wait for ca. 60 seconds.



Changes will only take effect after you exit the programming mode.



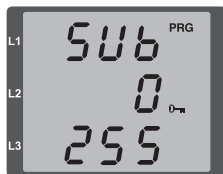

*Fig. Subnet mask (Sub),  
byte 0, value 255*



*Fig. Gateway (GAt),  
byte 0, value 192*



*Fig. Parameter setting for  
dynamic allocation (DHCP)  
of a TCP/IP address*



*Parameter setting for  
allocation of a fixed TCP/IP  
address*



### Caution!

Connection of the UMG96RM-EL to the Ethernet may only be carried out after discussion with the network administrator!



### Caution!

The UMG 96RM-EL is factory-programmed for the dynamic allocation of the IP settings (**DHCP mode**).

Settings can be changed as described in TCP/IP Configuration or, for example, via an appropriate Ethernet connection by means of GridVis software.



If the key symbol is displayed, the dynamic IP allocation is enabled.

Device / gateway address and subnet mask are provided and automatically accepted by the DHCP server.

### IP mode configuration table

0	Fixed IP address
1	BootP
2	DHCP
3	Fixed IP with ARP-Probe and Gratuitous-ARP
4	BootP with ARP-Probe and Gratuitous-ARP
5	DHCP with ARP-Probe and Gratuitous-ARP

## Parameters

### User password (addr. 050)

A user password can be programmed in order to impede any accidental change to programming data. A switch to the next programming menu can only be made after entering the correct user password.

No user password is specified in the factory. In this case, the password menu is skipped and the current transformer menu is reached directly.

If a user password was programmed, the password menu will appear with the display "000".

The first digit of the user password flashes and can be changed with button 2. The next digit is selected by pressing button 1 and will begin flashing.

The programming menu for the current transformer can only be accessed after entering the correct number combination.

### Forgotten password

If you have forgotten the password, the password can only be cleared by using the GridVis PC software.

To do this, connect the UMG 96RM-EL to the PC via a suitable interface. More information can be found in the help section of GridVis.

## Mean value

Mean values are averaged over an adjustable period for the current, voltage and power measured values. The mean values are indicated by a bar over the measured value.

The averaging time can be selected from a list with 9 fixed averaging times.

**Averaging time, current (Addr. 040)**

**Averaging time, power (Addr. 041)**

**Averaging time, voltage (Addr. 042)**

## Averaging method

The applied exponential messaging method reaches at least 95% of the measurement value once the reporting time has run its course.

Setting	Averaging time/sec.
0	5
1	10
2	15
3	30
4	60
5	300
6	480 (factory setting)
7	600
8	900

## Min. and max. values

All measured values are measured and calculated during all 10/12 periods. Minimum and maximum values are determined for most measured values.

The min. value is the smallest measured value determined since the last deletion. The max. value is the highest measured value determined since the last deletion. All minimum and maximum values are compared with the corresponding measured values and overwritten when exceeded or fallen short of.

The minimum and maximum values are saved every 5 minutes in an EEPROM without date and time. Thus, the minimum and maximum values of the past 5 minutes may be lost due to an operating voltage failure.

## Delete min. and max. values (Addr.506)

If "001" is set for address 506, all minimum and maximum values can be deleted simultaneously. One exception is the maximum value of the mean current. Press and hold button 2 to delete the maximum value of the mean current in the display menu.

## Energy meter

The UMG 96RM-EL has power meters for active energy, reactive energy and apparent energy.

### Active energy reading

Total active energy

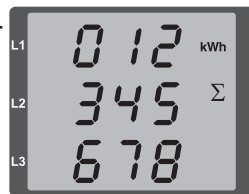

*The active energy given in this example is 12 345 678 kWh*

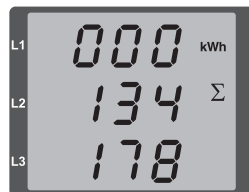

*The active energy given in this example is 134 178 kWh*

### Mains frequency (Addr. 034)

For automatic ascertainment of the mains frequency, an L1-N voltage larger than 10V<sub>eff</sub> must be applied to the voltage measurement input V1.

The sampling frequency is computed for the current and voltage inputs based on the mains frequency.

If the test voltage is missing, neither the network nor the sampling frequency can be computed. An acknowledgeable error message "500" will be displayed.

Voltage, current and all resulting values are calculated and displayed based on the most recent frequency measurement and/or possible power couplings. The measured values that have been determined can no longer guarantee the declared precision.

When another measurement of frequency can be carried out, the error message will automatically disappear in about 5 seconds after the voltage returns.

The error is not displayed when a fixed frequency is set.

Setting range: 0, 45 .. 65

0 = automatic frequency determination.

The mains frequency is determined based on the measurement voltage.

45..65 = fixed frequency

The mains frequency is pre-selected as a fixed value.

## Harmonics

Harmonics are the integer multiple of a mains frequency. The voltage mains frequency for the UMG 96RM-EL must be in the range between 45 and 65 Hz. The calculated voltage and current harmonics refer to this mains frequency.

Harmonics up to 40x the mains frequency are recorded.

The harmonics for currents are given in amperes and the harmonics for voltages are given in volts.

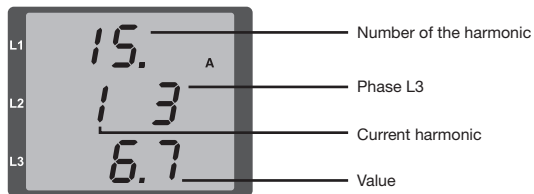

Fig. Display of the 15th harmonic of the current in the L3 phase (example).



Harmonics are not displayed in the factory default setting.

## Total Harmonic Distortion (THD)

THD is the ratio of the root mean square value of harmonics to the root mean square value of the mains frequency.

Total Harmonic Distortion of the current (THDI):

$$THD_I = \frac{1}{|I_{fund}|} \sqrt{\sum_{n=2}^M |I_{n,Harm}|^2}$$

Total Harmonic Distortion of the voltage (THDU):

$$THD_U = \frac{1}{|U_{fund}|} \sqrt{\sum_{n=2}^M |U_{n,Harm}|^2}$$

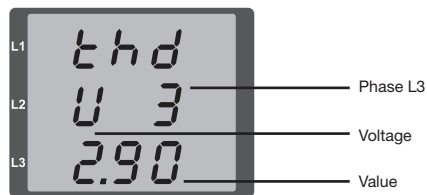

Fig. Display of the total harmonic distortion of the voltage from the L3 phase (example).

## Measured value relay

All 10/12 periods the measured values are calculated and the readings are displayed on a per second basis. There are two ways to retrieve the measurement readings:

- The automatically changing display of selected measured values, referred to here as measured value relaying.
- Selection of a measured value display using buttons 1 and 2 from a preselected display profile.

Both methods are simultaneously available. Measured value relaying is active if at least one measured value display is programmed with a changeover time greater than 0 seconds.

If a button is pressed, the measured value displays of the selected display profile can be browsed. If no button is pressed for about 60 seconds, the device switches to the measured value relay and the measured values from the selected display change profile of the programmed measured value displays are shown one after the other.

## Changeover time (addr. 039)

Adjustment range: 0 .. 60 seconds

If 0 seconds are set, no changeover takes place between the measured value displays selected for the measured value relay.

The changeover time applies for all display change profiles.

## Display change profile (addr. 038)

Adjustment range: 0 .. 3

0 - Display changeover profile 1, by default.

1 - Display changeover profile 2, by default.

2 - Display changeover profile 3, by default.

3 - Customised display changeover profile.

## Measured value displays

After return of the power supply, the UMG 96RM-EL shows the first measured value panel from the current display profile. In order to keep the selection of measured values to be displayed arranged in a clear manner, only one part of the available measured values is pre-programmed for recall in the measured value display by default. A different display profile can be selected if other measured values are required to be shown on the UMG 96RM-EL display.

## Display profile (Addr. 037)

Setting range: 0 .. 3

- 0 - Display profile 1, default value.
- 1 - Display profile 2, default value.
- 2 - Display profile 3, default value.
- 3 - Display profile, customizable.



The customizable profiles (display rotation profile and display profile) can only be programmed using the GridVis software.



### Profile setting

Both profiles (display rotation profile and display profile) are illustrated in the GridVis software included in the delivery package. The profiles can be adjusted using the Device Configuration function of the software; customizable display profiles are programmed individually.

A connection between the UMG 96RM-EL and the PC via an interface is required for the use of the GridVis software

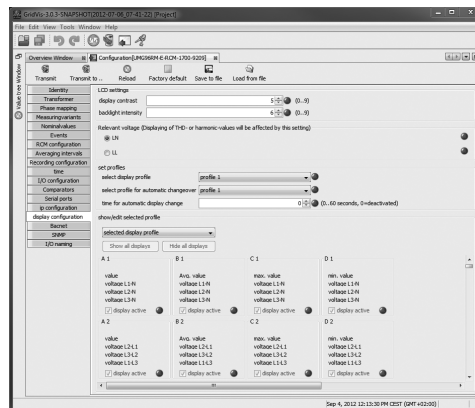

Fig. Profile setting in the GridVis software.



## Reset energy meter (Addr. 507)

The real, apparent and reactive energy meters can only be reset simultaneously.

Set "001" for address 507 to reset the energy meter.



Prior to commissioning potential production dependant contents of the energy counter and min/max values have to be deleted.



If you reset the energy meter, the data will be lost. To avoid data loss, you should read and save the measured values before deletion using the GridVis software.

## Phase sequence

The voltage phase sequence and the phase L1 frequency are displayed on the screen.

The phase sequence shows the three-phase system sequence. The rotary field usually rotates to the "right". The voltage measurement input phase sequence is checked and displayed in the UMG 96RM-EL. If the string moves in a clockwise direction, this means that the rotary field rotates to the "right"; if the string moves in a counter-clockwise direction, this means that the rotary field rotates to the "left".

The field rotation can only be determined when the measurement and operating voltage inputs are fully connected. If a phase is missing or two equal phases are connected, then the phase sequence is not determined and the string is not moving.



Fig. Indication of the supply frequency (50.0) and the phase sequence.



Fig. Rotary field direction can not be determined.

**LCD contrast (Addr. 035)**

The preferred view for the LCD display is from "below". The LCD display contrast can be adapted by the user. The contrast can be set stepwise in the range from 0 to 9.

0 = very bright  
9 = very dark

Factory default setting: 5

**Backlight**

The LCD backlight allows the display to be read easily even in poor light. The brightness can be controlled by the user in stages from 0 to 9.

The UMG 96RM has two different types of backlight:

- the operation backlight
- the standby backlight

**Operation backlight (addr. 036)**

The operation backlight is activated by pushing the appropriate button, or with a restart.

**Standby backlight (addr. 747)**

This backlight is activated after an adjustable period of time (addr. 746). If no button is pressed within this period, then the device switches to the standby backlight. If buttons 1 - 3 are pressed, the device switches to the operation backlight and the defined period of time begins again.

If the brightness settings for the two backlights are set to the same value, then no change is discernible between the operation and standby backlights.

Addr.	Description	Setting range	Default setting
036	Brightness for operation backlight	0 .. 9	6
746	Period of time after which the backlight will switch to standby	60 .. 9999 Sek.	900 Sek.
747	Brightness for standby backlight	0 .. 9	0

0 = min. brightness, 9 = max. brightness

## Time recording

The UMG 96RM-EL records the operating hours and the overall runtime of each comparator,

- where the operating period is measured and displayed in hours with a resolution of 0.1 h
- and the overall runtime of the comparators is displayed in seconds (when reaching 999999s is displayed in hours).

The periods are marked by the digits 1 to 6 for the measured value display enquiry:

keine = operating hours meter

1 = Overall runtime, comparator 1A

2 = Overall runtime, comparator 2A

3 = Overall runtime, comparator 1B

4 = Overall runtime, comparator 2B

5 = Overall runtime, comparator 1C

6 = Overall runtime, comparator 2C

In the measured value display, a maximum of 99999.9 h (= 11.4 years) can be displayed.

## Operating hours meter

The operating hours meter measures the UMG 96RM-EL recording and displaying time.

The operating period is measured and displayed in hours with a resolution of 0.1 h. The operating hours meter cannot be reset.

## Overall runtime of comparators

The overall runtime of a comparator is the sum of the runtimes exceeding the comparator result limit value.

The total running time of the comparators can only be reset by the GridVis software. All running times are reset simultaneously.



*Fig. Measured value indications  
Operating hours meter*

*The UMG 96RM-EL operating hours meter reading is 140.8h. This corresponds to 140 hours and 80 industrial minutes. 100 industrial minutes = 60 minutes. In this example, 80 industrial minutes = 48 minutes.*

**Serial number (Addr. 754)**

The serial number displayed by the UMG 96RM-EL consists of 6 digits and is a part of the serial number given on the rating plate.

The serial number cannot be changed.

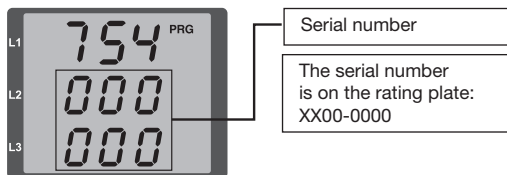
**Software release (Addr. 750)**

The UMG 96RM-EL software is continuously improved and extended. The software status in the device is identified with a 3 digit number, the software release. The software release cannot be changed by the user.

## Commissioning

### Applying the supply voltage

- The level of supply voltage for the UMG 96RM-EL can be found on the nameplate.
- After applying the supply voltage, the UMG 96RM-EL switches to the first measured value display.
- If no display appears, the supply voltage must be checked to determine whether it is in the rated voltage range.

### Applying the measured voltage

- Voltage measurements in networks with rated voltages above 300V AC to ground must be connected to a voltage transformer.
- After the measured voltages are connected, the measured values for the L-N and L-L voltages displayed by the UMG 96RM-EL must match those at the voltage measurement input.



#### Attention!

Voltages and currents outside the permissible metering range can result in personal injury and damage to the device.

### Applying the measured current

The UMG 96RM-EL is designed for connecting  $\dots/1$  A and  $\dots/5$  A current transformers.

Only AC currents and not DC currents can be measured via the current measurement inputs.

Short circuit all current transformer outputs except for one. Compare the currents displayed on the UMG 96RM-EL with the applied current.

The current displayed by the UMG 96RM-EL must match the input current, taking the current transformer ratio into consideration.

In the short circuit current measurement inputs, the UMG 96RM-EL must show approx. zero amperes.

The factory-set current transformer ratio is 5/5 A and may need to be adapted to the current transformer used.



#### Attention!

Supply voltages that do not correspond to the nameplate information can lead to device malfunction or destruction.



#### Attention!

The UMG 96RM-EL is not suitable for the measurement of DC voltages.

### Rotation field direction

Check the direction of the voltage rotation field on the measured value display of the UMG 96RM-EL. Usually there is a "clockwise" spinning rotation field.

### Checking the phase assignment

The assignment of the phase conductor to the current transformer is correct if a current transformer is short circuited at the secondary terminals and the current shown by the UMG 96RM-EL in the corresponding phase sinks to 0A.

### Checking the power measurement

Short circuit all current transformer outputs except for one and check the displayed power. The UMG 96RM-EL must only show one rating in the phase with the non-short-circuited current transformer input. If this does not apply, check the measured voltage connection and the measured current connection.

If the magnitude of the real power is correct but the sign of the real power is negative, this can be due to two causes:

- The connections S1 (k) and S2 (l) on the current transformer are inverted.
- Active energy is being returned to the network.

### Checking the measurement

If all voltage and current measurement inputs are correctly connected, the individual and sum power ratings are accurately calculated and displayed.

### Checking the individual power ratings

If the current transformer is assigned to the wrong phase conductor, the associated power rating will be incorrectly measured and displayed.

The assignment of the phase conductor to the current transformer on the UMG 96RM-EL is correct if there is no voltage between the phase conductor and the associated current transformer (primary).

In order to ensure that a phase conductor on the voltage measurement input is assigned to the correct current transformer, the respective current transformer can be short-circuited at the secondary terminals. The apparent power shown by the UMG 96RM-EL must then be zero in this phase.

If the apparent power is correctly displayed but the real power is shown with a "-" sign, the current transformer terminals are inverted or power is being fed to the power company.

## Check the sum power ratings

If all voltages, currents and power ratings for the respective phase conductor are correctly displayed, the sum power ratings measured by the UMG 96RM-EL must also be correct. For confirmation, the sum power ratings measured by the UMG 96RM-EL should be compared with the energy of the active and reactive power meters at the power feed.

## Comparators and monitoring threshold values

Two comparator groups (1-2) and 3 comparators per group (A – C) can be selected in order to monitor/control the thresholds. The results of the comparators A to C can be linked with AND or OR operators.

The function “display blinking” can be additionally assigned to every comparator group. The effect is the change of the display backlight between maximum and minimum brightness when the comparator output is active (addr. 145).

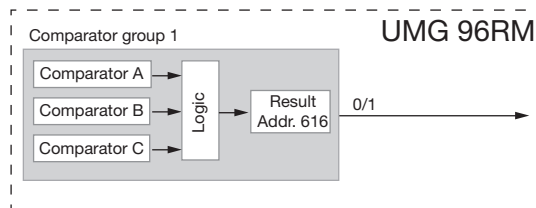

Block diagram: Use of Comparator group 1

**Example: Current monitoring in the neutral line**

If the current in the neutral line is greater than 100 A for 60 seconds, the result of the comparator group 1 should be latched for at least 2 minutes.

The following must be programmed:

1. Comparator group 1

Select comparator group 1 for the limit value monitoring. Since only one limit value is monitored, select comparator A and program it as follows:

The address of the measured value to be monitored by comparator A:

Address 110 = 866  
(address of the current in the neutral line)

The measured values for the B and C comparators are set to 0.

Address 116 = 0 (the comparator is inactive)  
Address 122 = 0 (the comparator is inactive)

The limit value to be observed.

Address 108 = 100 (100 A)

For a minimum exposure time of 2 minutes, the result of the comparator group 1 should be latched if the limit value is exceeded.

Address 111 = 120 seconds

For the lead time of 60 seconds, any exceeding should be minimised.

Address 112 = 60 seconds

The operator for comparison between the measured value and the limit value.

Address 113 = 0 (corresponds >=)

2. Linking comparators

The B and C comparators have not been set and are equal to zero.

The result of comparator A is issued as a comparator result through the OR link of comparators A, B and C.

Address 107 = 0 (OR link)

Result

The result of the comparator group 1 is latched for at least 2 minutes if the current in the neutral line is greater than 100 A for more than 60 seconds.



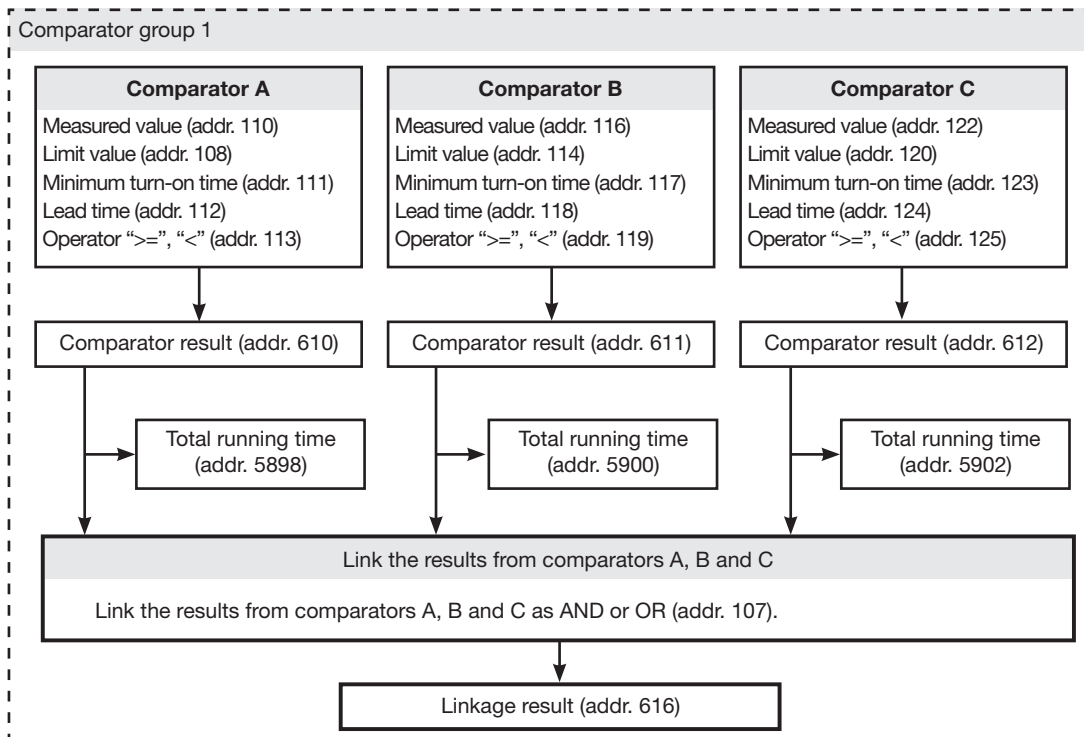

- Measured value (addr. 110,116,122,129,135,141)**  
 The address of the measured value to be monitored is in the measured value.  
 If measured value = 0, the comparator is inactive.
- Limit value (addr. 108,114,120,127,133,139)**  
 Write the value in the limit that is to be compared with the measured value.
- Minimum turn-on time (addr. 111,117,123,130,136,142)**  
 The linkage result (e.g. address 610) is maintained for the duration of the minimum turn-on time.  
 Adjustment range: 1 to 32,000 seconds
- Lead time (addr. 112,118,124,131,137,143)**  
 If a limit value violation is present for at least the duration of the lead time, the comparator result is changed.  
 Times in the range from 1 to 32,000 seconds can be assigned to the lead time.
- Operator (addr. 113,119,125,132,138,144)**  
 Two operators are available for comparing the measured value and the limit value.  
 Operator = corresponds to 0 greater than or equal to ( $\geq$ )  
 Operator = corresponds to 1 less than ( $<$ )
- Comparator result (addr. 610,611,612,613,614,615)**  
 The result from the comparison between the measured value and the limit value is in the comparator result.  
 Therefore:  
 0 = there is no limit value violation.  
 1 = there is a limit value violation.
- Total running time**  
 The sum of all times for which there was a limit value violation in the comparator result.
- Linkage (addr. 107, 126)**  
 Link the results from comparators A, B and C as AND or OR.
- Total linkage result (addr. 616,617)**  
 The linked comparator results from comparators A, B and C are in the total linkage result.

## Comparator in the GridVis software

Configuration (adjustment) of the individual comparators can also be performed via GridVis in the menu of the device configuration.

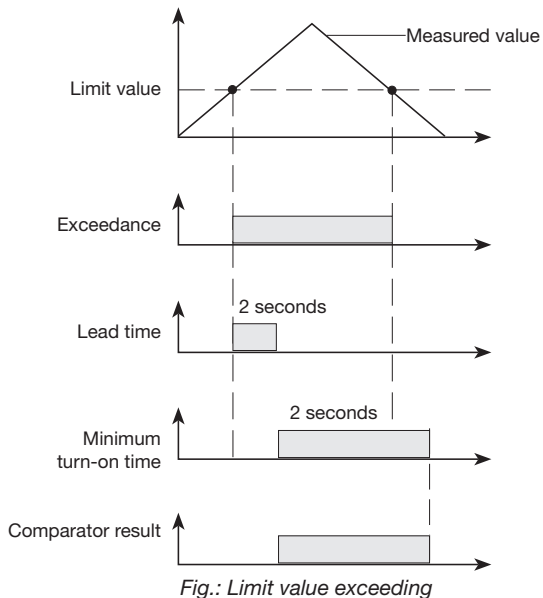

Fig.: Limit value exceeding

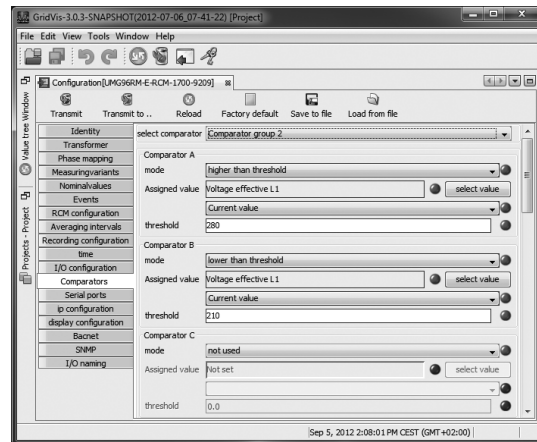

Fig.: Software GridVis, configuration menu

## Service and maintenance

The device is subjected to several different safety tests before leaving the factory and is labelled with a seal. If a device is opened then the safety checks must be repeated. Warranty claims will only be accepted if the device is unopened.

### Repair and calibration

Repair work and calibration can be carried out by the manufacturer only.

### Front film

The front film can be cleaned with a soft cloth and standard household cleaning agent. Do not use acids and products containing acid for cleaning.

### Disposal

The UMG 96RM-EL can be reused or recycled as electronic scrap in accordance with the legal provisions. The permanently installed lithium battery must be disposed of separately.

## Service

Should questions arise, which are not described in this manual, please contact the manufacturer directly.

We will need the following information from you to answer any questions:

- Device name (see rating plate),
- Serial number (see rating plate),
- Software release (see measured value display),
- Measuring-circuit voltage and power supply voltage,
- Precise description of the error.

### Device calibration

The devices are calibrated by the manufacturer at the factory - it is not necessary to recalibrate the device providing that the environmental conditions are complied with.

### Calibration intervals

It is recommended to have a new calibration carried out by the manufacturer or an accredited laboratory every 5 years approximately.

## Firmware update

If the device is connected to a computer via Ethernet, then the device firmware can be updated via the GridVis software.

Select a suitable update file (menu *Extras / Update device*) and the device and the new firmware will be transferred.

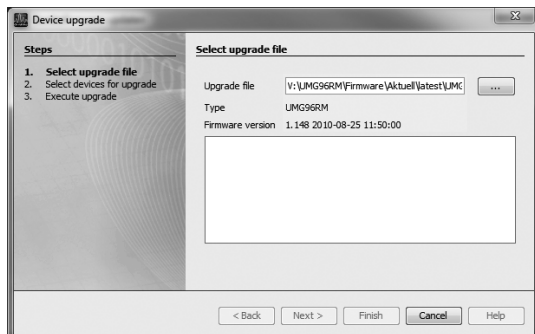

Fig. GridVis firmware update assistant

## Error messages

The UMG 96RM-EL shows three different error messages on the display:

- warnings,
- serious error and
- metering range exceedances.

If there are warnings and serious errors, the error message is indicated by the symbol "EEE" followed by an error number.

The three-digit error number is composed of the error description and (if detectable by the UMG 96RM-EL) one or more error causes.

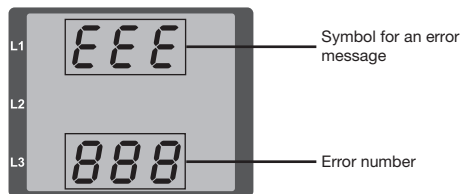
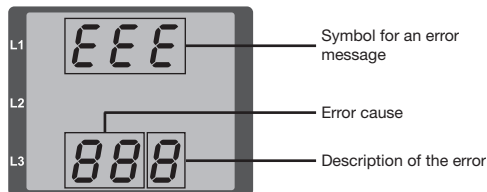

Fig. Error message



Example of error message 911:

The error number is composed of serious error 910 and internal error cause 0x01.

In this example, an error occurred when reading the calibration from the EEPROM. The device must be sent to the manufacturer for inspection.



## Warnings

Warnings are minor errors that can be acknowledged by buttons 1 or 2. The measured values continue to be retrieved and displayed. This error is displayed after each voltage return.



*Fig. Warning message with number 500 (mains frequency)*

Errors	Error description
EEE 500	<p>The mains frequency could not be determined.</p> <p>Possible causes:</p> <ul style="list-style-type: none"> <li>The voltage at L1 is too small.</li> <li>The mains frequency does not range between 45 and 65Hz.</li> </ul> <p>Remedy:</p> <ul style="list-style-type: none"> <li>Check the mains frequency.</li> <li>Select fixed frequency on the device.</li> </ul>

Errors	Error description
EEE 810	<p>A failure has been detected in the configuration.</p> <p>The configuration will be reset and restored to default values (factory setting) when that failure was displayed.</p> <p><b>Device has to be re-configured where required.</b></p>

## Major errors

When a major error occurs, the device must be sent to the manufacturer's service center for inspection and adjustment.

Errors	Error description
EEE 910	Error while reading the calibration.

Internal causes:

The UMG 96RM-EL sometimes determines the cause of a major internal error with the following error code.

Errors	Error description
0x01	EEPROM does not respond.
0x02	Address overrange.
0x04	Checksum error.
0x08	Error in the internal I2C bus.

## Metering range exceedance

Metering range exceedances are displayed as long as they are present and cannot be acknowledged. A metering range is exceeded if at least one of the three voltage or current measuring inputs is outside of its specified metering range.

The phase in which the metering range exceedance occurred is indicated with the "up" arrow. The "V" and "A" symbols show whether the metering range exceedance occurred in the current or voltage circuit.

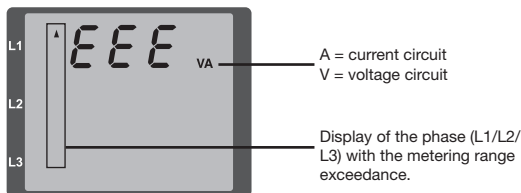

## Examples

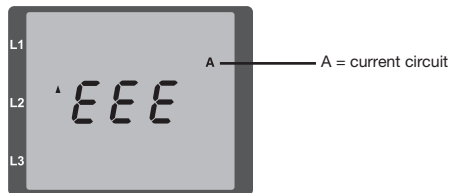

Fig.: Display of the metering range exceedance in the current circuit of the 2nd phase (I2).

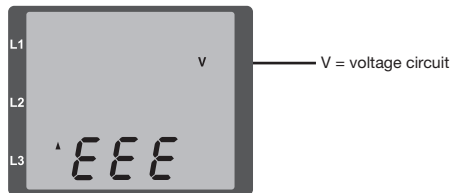

Fig.: Display of the metering range exceedance in the voltage circuit L3.

Limit values for metering range exceedance:

$$I = 7 A_{eff}$$

$$U_{L-N} = 520 V_{L-N}$$



## Parameters of the metering range exceedance

A continuative error description is stored encoded in the parameters of the metering range exceedance (addr. 600) in the following format:

0x	F	F	F	F	F	F	F	F
Phase 1:		1		1				
Phase 2:		2		2				
Phase 3:		4		4				
		Current:		U <sub>L-N</sub>				

*Example: Error in phase 2 in the current circuit:*

**0xF2FFFFFF**

*Example: Error in phase 3 in the voltage circuit U<sub>L-N</sub>:*

**0xFFF4FFFF**

## Procedure in the event of faults

Possible fault	Cause	Remedy
No display	External fusing for the power supply voltage has tripped.	Replace fuse.
No current display	Measurement voltage is not connected.	Connect the measuring-circuit voltage.
	Measurement current is not connected.	Connect measuring-circuit current.
Current displayed is too large or too small.	Current measurement in the wrong phase.	Check connection and correct if necessary.
	Current transformer factor is incorrectly programmed.	Read out and program the current transformer transformation ratio at the current transformer.
	The current peak value at the measurement input was exceeded by harmonic components.	Install current transformer with a larger transformation ratio.
	The current at the measurement input fell short of.	Install current transformer with a suitable transformation ratio.
Voltage displayed is too large or too small.	Measurement in the wrong phase.	Check connection and correct if necessary.
	Voltage transformer incorrectly programmed.	Read out and program the voltage transformer transformation ratio at the voltage transformer.
Voltage displayed is too small.	Overrange.	Install voltage transformers.
	The peak voltage value at the measurement input has been exceeded by harmonic components.	<b>Caution!</b> Ensure the measurement inputs are not overloaded.
Phase shift ind/cap.	A current path is assigned to the wrong voltage path.	Check connection and correct if necessary.
Effective power, consumption/supply reversed.	At least one current transformer connection is mixed up/reversed.	Check connection and correct if necessary.
	A current path is assigned to the wrong voltage path.	Check connection and correct if necessary.

Possible fault	Cause	Remedy
Effective power too large or too small.	The programmed current transformer transformation ratio is incorrect.	Read out and program the current transformer transformation ratio at the current transformer
	The current path is assigned to the wrong voltage path.	Check connection and correct if necessary.
	The programmed voltage transformer transformation ratio is incorrect.	Read out and program the voltage transformer transformation ratio at the voltage transformer.
"EEE" in the display	See error messages.	
No connection with the device.	<ul style="list-style-type: none"> <li>- IP address is incorrect.</li> <li>- Incorrect addressing mode</li> <li>- Network cable is defective</li> </ul>	<ul style="list-style-type: none"> <li>- Adjust IP address at the device.</li> <li>- Adjust the IP address assignment mode</li> <li>- Replace network cable</li> </ul>
Device still does not work despite the above measures.	Device defective.	Send the device to the manufacturer for inspection and testing along with an accurate fault description.

## Technical data

General information	
Net weight (with attached connectors)	ca. 300g
Packaging weight (including accessories)	ca. 600g
Service life of background lighting	40000h (after this period of time the background lighting efficiency will reduce by approx. 50 %)

Transport and storage	
The following information applies to devices which are transported or stored in the original packaging.	
Free fall	1m
Temperature	K55 (-25°C bis +70°C)
Relative humidity	0 to 90 % RH

Ambient conditions during operation	
The UMG 96RM-EL is intended for use in weather-protected, fixed locations. Protection class II according to IEC 60563 (VDE 0106, part 1).	
Rated temperature range	K55 (-10°C .. +55°C)
Relative humidity	0 bis 75 % RH
Operational altitude	0 .. 2000m über NN
Degree of pollution	2
Installation position	vertical
Ventilation	Forced ventilation is not required.
Foreign body and water protection - Front - Back - Front with seal	IP40 according to EN60529 IP20 according to EN60529 IP42 according to EN60529

<b>Supply voltage</b>	
Installation overvoltage category	300V CAT II
Protection of the power supply (fuse)	6 A, type C (approved by UL/IEC)
Nominal range	20V - 250V (45..65Hz) oder DC 20V - 300V
Working area	+/-10% from the nominal range
Power consumption	max. 5.5VA / 2W

<b>Connection capacity of the terminals (power supply)</b>	
Connectable conductor. Only one conductor may be connected per contact point!	
Single-wire, multi-wire, finely stranded conductor	0.2 - 2.5mm <sup>2</sup> , AWG 26 - 12
Pin terminals, ferrules	0,2 - 2.5mm <sup>2</sup>
Tightening torque	0.4 - 0.5Nm
Stripping length	7mm

<b>Voltage metering</b>	
Three-phase, 4-wire systems with nominal voltages up to	277V/480V (+-10%)
Three-phase, 3-wire systems, unearthed, with nominal voltages up to	IT 480V (+-10%)
Overvoltage category	300V CAT III
Rated surge voltage	4kV
Metering range L-N	0 <sup>1)</sup> .. 300 Vrms (max. overvoltage 520 Vrms )
Metering range L-L	0 <sup>1)</sup> .. 520Vrms (max. overvoltage 900Vrms )
Resolution	0.01V
Crest factor	2.45 (relative to the metering range)
Impedance	4MΩm/phase
Power consumption	approx. 0.1 VA
Sampling rate	21.33kHz (50Hz), 25.6 kHz (60Hz) per measuring channel
Mains frequency - Resolution	45Hz .. 65Hz 0.01Hz

<sup>1)</sup> The UMG 96RM-EL can only determine values, if a voltage L-N greater than 10Veff or a voltage L-L of greater than 18Veff is present at least one voltage measurement input.

<b>Current measurement</b>	
Rated current	5A
Measurement range	0 .. 6Arms
Crest factor	1.98
Resolution	0.1mA (Display 0.01A)
Overvoltage category	300V CAT II
Measurement surge voltage	2kV
Power consumption	approx. 0.2 VA (Ri=5mOhm)
Overload for 1 sec.	120A (sinusoidal)
Sampling frequency	21.33 kHz (50 Hz), 25.6 kHz (60 Hz) per measuring channel

<b>Connection capacity of the terminals (voltage and current measurement)</b>		
Connectable conductor. Only one conductor may be connected per contact point!		
	<b>Current</b>	<b>Voltage</b>
Single-wire, multi-wire, finely stranded conductor	0.2 - 2.5mm <sup>2</sup> , AWG 26-12	0.08 - 4.0mm <sup>2</sup> , AWG 28-12
Pin terminals, ferrules	0.2 - 2.5mm <sup>2</sup>	0.2 - 2.5mm <sup>2</sup>
Tightening torque	0.4 - 0.5Nm	0.4 - 0.5Nm
Stripping length	7mm	7mm

<b>Ethernet connection</b>	
Connection	RJ45
Protocols	TCP/IP, DHCP-Client (BootP), Modbus/TCP (Port 502), ICMP (Ping), Modbus RTU over Ethernet (Port 8000)

## Function parameters

Function	Symbol	Accuracy class	Metering range	Display range
Total real power	P	0.5 <sup>5)</sup> (IEC61557-12)	0 .. 5.4 kW	0 W .. 999 GW *
Total reactive power	QA, Qv	1 (IEC61557-12)	0 .. 5.4 kvar	0 varh .. 999 Gvar *
Total apparent power	SA, Sv	0.5 <sup>5)</sup> (IEC61557-12)	0 .. 5.4 kVA	0 VA .. 999 GVA *
Total active energy	Ea	0.5S <sup>5)</sup> 6) (IEC61557-12)	0 .. 5.4 kWh	0 Wh .. 999 GWh *
Total reactive energy	ErA, ErV	1 (IEC61557-12)	0 .. 5.4 kvarh	0 varh .. 999 Gvarh *
Total apparent energy	EapA, EapV	0.5 <sup>5)</sup> (IEC61557-12)	0 .. 5.4 kVAh	0 VAh .. 999 GVAh *
Frequency	f	0.05 (IEC61557-12)	45 .. 65 Hz	45.00 Hz .. 65.00 Hz
Phase current	I	0.2 (IEC61557-12)	0 .. 6 Arms	0 A .. 999 kA
Measured neutral conductor current	IN	-	-	-
Calculated neutral conductor current	INc	1.0 (IEC61557-12)	0.03 .. 25 A	0.03 A .. 999 kA
Voltage	U L-N	0.2 (IEC61557-12)	10 .. 300 Vrms	0 V .. 999 kV
Voltage	U L-L	0.2 (IEC61557-12)	18 .. 520 Vrms	0 V .. 999 kV
Displacement factor	PFA, PFV	0.5 (IEC61557-12)	0.00 .. 1.00	0.00 .. 1.00
Short-term flicker, long-term flicker	Pst, Plt	-	-	-
Voltage dips (L-N)	Udip	-	-	-
Voltage surges (L-N)	Uswl	-	-	-
Transient overvoltages	Utr	-	-	-
Voltage interruptions	Uint	-	-	-
Voltage unbalance (L-N) <sup>1)</sup>	Unba	-	-	-
Voltage unbalance (L-N) <sup>2)</sup>	Unb	-	-	-
Voltage harmonics	Uh	Class 1 (IEC61000-4-7)	up to 2.5 kHz	0 V .. 999 kV
THD of the voltage <sup>3)</sup>	THDu	1.0 (IEC61557-12)	up to 2.5 kHz	0 % .. 999 %
THD of the voltage <sup>4)</sup>	THD-Ru	-	-	-



Function	Symbol	Accuracy class	Metering range	Display range
Current harmonics	lh	Class 1 (IEC61000-4-7)	up to 2.5 kHz	0 A .. 999 kA
THD of the current <sup>3)</sup>	THDi	1.0 (IEC61557-12)	up to 2.5 kHz	0 % .. 999 %
THD of the current <sup>4)</sup>	THD-Ri	-	-	-
Mains signal voltage	MSV	-	-	-

1) Referred to amplitude.

2) Referred to phase and amplitude.

3) Referred to mains frequency.

4) Referred to root mean square value.

5) Accuracy class 0.5 with  $\pm 0.5$  A transformer.

Accuracy class 1 with  $\pm 1$  A transformer.

6) Accuracy class 0.5S according IEC62053-22

\* The display returns to 0 W when the maximum total energy values are reached.

## Parameter and Modbus address list

The following excerpt from the parameter list contains settings that are necessary for proper operation of the UMG 96RM-EL, such as current transformers and device addresses. The values in the parameter list can be written and read.



A complete overview of the parameters and measured values as well as explanations regarding the selected measured values is filed in the document “Modbus Address List” on the CD or Internet.

In the excerpt, the measured value list files the measured and calculated measured values, output status data and recorded values so that they can be read.

**Table 1 - Parameter list**

Address	Format	RD/WR	Unit	Note	Adjustment Range	Default
10	FLOAT	RD/WR	A	Current transformer I1, primary	0..1000000 <sup>(2)</sup>	5
12	FLOAT	RD/WR	A	Current transformer I1, sec.	1..5	5
14	FLOAT	RD/WR	V	Voltage transformer V1, primary	0..1000000 <sup>(2)</sup>	400
16	FLOAT	RD/WR	V	Voltage transformer V1, sec.	100, 400	400
18	FLOAT	RD/WR	A	Current transformer I2, primary	0..1000000 <sup>(2)</sup>	5
20	FLOAT	RD/WR	A	Current transformer I2, sec.	1..5	5
22	FLOAT	RD/WR	V	Voltage transformer V2, primary	0..1000000	400
24	FLOAT	RD/WR	V	Voltage transformer V2, sec.	100, 400	400
26	FLOAT	RD/WR	A	Current transformer I3, primary	0..1000000	5
28	FLOAT	RD/WR	A	Current transformer I3, sec.	1..5	5
30	FLOAT	RD/WR	V	Voltage transformer V3, primary	0..1000000	400
32	FLOAT	RD/WR	V	Voltage transformer V3, sec.	100, 400	400

<sup>(1)</sup> The values 0 and 248 to 255 are reserved and must not be used.

<sup>(2)</sup> The adjustable value 0 does not produce any sensible energy values and must not be used.

Address	Format	RD/WR	Unit	Note	Adjustment Range	Default
34	SHORT	RD/WR	Hz	Frequency determination 0=Auto, 45 .. 65=Hz	0, 45 .. 65	0
35	SHORT	RD/WR	-	Display contrast 0 (low), 9 (high)	0 .. 9	5
36	SHORT	RD/WR	-	Backlight 0 (dark), 9 (light)	0 .. 9	6
37	SHORT	RD/WR	-	Display profile 0=default display profile 1=default display profile 2=default display profile 3=freely selectable display profile	0 .. 3	0
38	SHORT	RD/WR	-	Display change profile 0..2=default display change profiles 3=freely selectable display change profile	0 .. 3	0
39	SHORT	RD/WR	s	Changeover time	0 .. 60	0
40	SHORT	RD/WR	-	Averaging time, I	0 .. 8*	6
41	SHORT	RD/WR	-	Averaging time, P	0 .. 8*	6
42	SHORT	RD/WR	-	Averaging time, U	0 .. 8*	6
45	USHORT	RD/WR	mA	Response threshold of I1 .. I3	0 .. 200	5
50	SHORT	RD/WR	-	Password	0 .. 999	0 (no password)
107	SHORT	RD/WR	-	Result from comparator group 1; Link A, B, C (1=and, 0=or)	0,1	0

\* 0 = 5sec.; 1 = 10sec.; 2 = 15sec.; 3 = 30sec.; 4 = 1min.; 5 = 5min.; 6 = 8min.; 7 = 10min.; 8 = 15min.

Address	Format	RD/WR	Unit	Note	Adjustment Range	Default
108	FLOAT	RD/WR	-	Comparator 1A, Limit value	$-10^{12}-1..+10^{12}-1$	0
110	SHORT	RD/WR	-	Comparator 1A, Address of the measured value	0..32000	0
111	SHORT	RD/WR	s	Comparator 1A, Minimum turn-on time	0..32000	0
112	SHORT	RD/WR	s	Comparator 1A, Lead time	0..32000	0
113	SHORT	RD/WR	-	Comparator 1A, Operator "≥"=0, "<"=1	0,1	0
114	FLOAT	RD/WR	-	Comparator 1B, Limit value	$-10^{12}-1..+10^{12}-1$	0
116	SHORT	RD/WR	-	Comparator 1B, Address of the measured value	0..32000	0
117	SHORT	RD/WR	s	Comparator 1B, Minimum turn-on time	0..32000	0
118	SHORT	RD/WR	s	Comparator 1B, Lead time	0..32000	0
119	SHORT	RD/WR	-	Comparator 1B, Operator "≥"=0 "<"=1	0,1	0
120	FLOAT	RD/WR	-	Comparator 1C, Limit value	$-10^{12}-1..+10^{12}-1$	0
122	SHORT	RD/WR	-	Comparator 1C, Address of the measured value	0..32000	0
123	SHORT	RD/WR	s	Comparator 1C, Minimum turn-on time	0..32000	0
124	SHORT	RD/WR	s	Comparator 1C, Lead time	0..32000	0
125	SHORT	RD/WR	-	Comparator 1C, Operator "≥"=0 "<"=1	0,1	0
126	SHORT	RD/WR	-	Result from comparator group 2; Link A, B, C (1=and, 0=or)	0,1	0
127	FLOAT	RD/WR	-	Comparator 2A, Limit value	$-10^{12}-1..+10^{12}-1$	0
129	SHORT	RD/WR	-	Comparator 2A, Address of the measured value	0..32000	0
130	SHORT	RD/WR	s	Comparator 2A, Minimum turn-on time	0..32000	0

Address	Format	RD/WR	Unit	Note	Adjustment Range	Default
131	SHORT	RD/WR	s	Comparator 2A, Lead time	0..32000	0
132	SHORT	RD/WR	-		Comparator 2A, Operator "≥"=0 "<"=1	0,1
133	FLOAT	RD/WR	-	Comparator 2B, Limit value	-10 <sup>12</sup> -1..+10 <sup>12</sup> -1	0
135	SHORT	RD/WR	-		Comparator 2B, Address of the measured value	0..32000
136	SHORT	RD/WR	s	Comparator 2B, Minimum turn-on time	0..32000	0
137	SHORT	RD/WR	s	Comparator 2B, Lead time	0..32000	0
138	SHORT	RD/WR	-	Comparator 2B, Operator "≥"=0 "<"=1	0,1	0
139	FLOAT	RD/WR	-	Comparator 2C, limit value	-10 <sup>12</sup> -1..+10 <sup>12</sup> -1	0
141	SHORT	RD/WR	-		Comparator 2C, Address of the measured value	0..32000
142	SHORT	RD/WR	s	Comparator 2C, Minimum turn-on time	0..32000	0
143	SHORT	RD/WR	s	Comparator 2C, lead time	0..32000	0
144	SHORT	RD/WR	-	Comparator 2C, Operator "≥"=0 "<"=1	0,1	0
145	SHORT	RD/WR	-	„Display blinking“ Bit 1 = 1/0: active/inactive for comparator group output 1 Bit 2 = 1/0: active/inactive for comparator group output 2	0-3	0
500	SHORT	RD/WR	-	Terminal assignment, I L1	-3..0..+3 <sup>1)</sup>	+1
501	SHORT	RD/WR	-	Terminal assignment, I L2	-3..0..+3 <sup>1)</sup>	+2
502	SHORT	RD/WR	-	Terminal assignment, I L3	-3..0..+3 <sup>1)</sup>	+3
503	SHORT	RD/WR	-	Terminal assignment, U L1	0..3 <sup>1)</sup>	1
504	SHORT	RD/WR	-	Terminal assignment, U L2	0..3 <sup>1)</sup>	2
505	SHORT	RD/WR	-	Terminal assignment, U L3	0..3 <sup>1)</sup>	3
506	SHORT	RD/WR	-	Clear min. and max. values	0..1	0

<sup>1)</sup> 0 = No measurement of the current or voltage path.

Address	Format	RD/WR	Unit	Note	Adjustment Range	Default
507	SHORT	RD/WR	-	Clear energy meter	0..1	0
508	SHORT	RD/WR	-	Force write EEPROM.	0..1	0
Note: Energy values and minimum and maximum values are written to the EEPROM every 5 minutes.						
509	SHORT	RD/WR	-	Voltage connection diagram	0..8 <sup>1)</sup>	0
510	SHORT	RD/WR	-	Current connection diagram	0..8	0
511	SHORT	RD/WR	-	Relative voltage for THD and FFT	0, 1	0
The voltages for THD and FFT can be shown on the display as L-N or L-L values. 0=LN, 1=LL						
600	UINT	RD/WR	-	Metering range exceedance	0..0xFFFFFFFF	
610	SHORT	RD	-	Comparator result 1 Output A		
611	SHORT	RD	-	Comparator result 1 Output B		
612	SHORT	RD	-	Comparator result 1 Output C		
613	SHORT	RD	-	Comparator result 2 Output A		
614	SHORT	RD	-	Comparator result 2 Output B		
615	SHORT	RD	-	Comparator result 2 Output C		
616	SHORT	RD	-	Linkage result of comparator group 1		
617	SHORT	RD	-	Linkage result of comparator group 2		
750	SHORT	RD	-	Software Release		
754	SERNR	RD	-	Serial number		
756	SERNR	RD	-	Production number		
746	SHORT	RD/WR	s	Period of time after which the backlight will switch to standby	60 .. 9999	900
747	SHORT	RD/WR	s	Brightness of the standby backlight	0 .. 9	0

<sup>1)</sup> The setting 8 is equal setting 0.

## Number formats

Type	Size	Minimum	Maximum
short	16 bit	$-2^{15}$	$2^{15} - 1$
ushort	16 bit	0	$2^{16} - 1$
int	32 bit	$-2^{31}$	$2^{31} - 1$
uint	32 bit	0	$2^{32} - 1$
float	32 bit	IEEE 754	IEEE 754



### Notes on saving measurement values and configuration data:

- The following measurement values are saved at least every 5 minutes:
  - Comparator timer
  - S0 meter readings
  - Minimum / maximum / mean values
  - Energy values
- Configuration data is saved immediately!

## Dimensional drawings

All dimensions in mm.

### Rear view

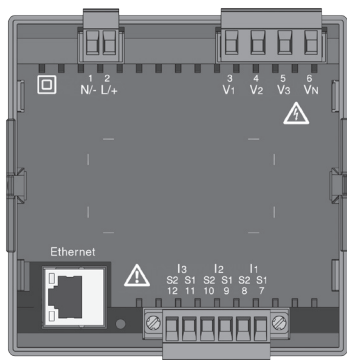

### Bottom view

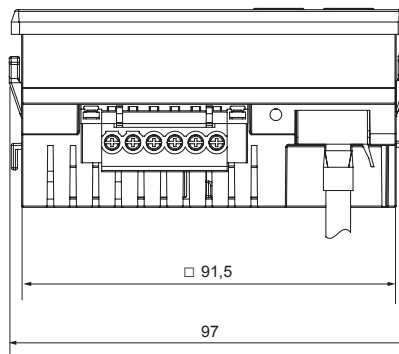



Side view

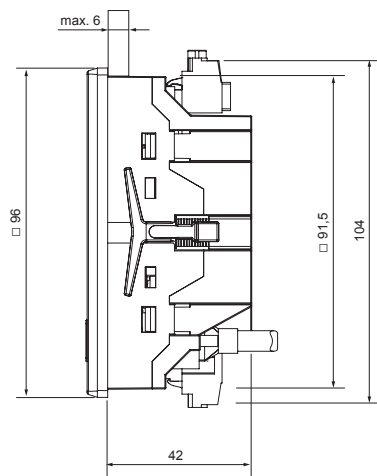

Cutout dimensions

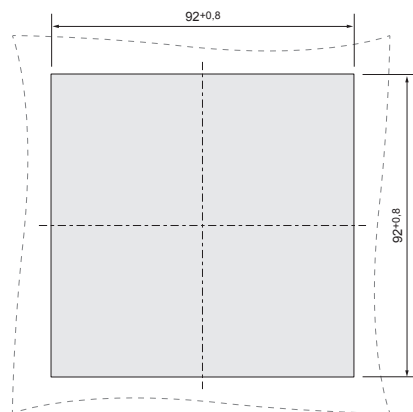

## Measured value displays overview

<p>△</p> <p>A01</p> <p>Measured values L1-N voltage L2-N voltage L3-N voltage</p>	<p>▷</p> <p>B01</p> <p>Mean values L1-N voltage L2-N voltage L3-N voltage</p>	<p>▷</p> <p>C01</p> <p>Maximum values L1-N voltage L2-N voltage L3-N voltage</p>	<p>▷</p> <p>D01</p> <p>Minimum values L1-N voltage L2-N voltage L3-N voltage</p>
<p>△</p> <p>A02</p> <p>Measured values L1-L2 voltage L2-L3 voltage L3-L1 voltage</p>	<p>B02</p> <p>Mean values L1-L2 voltage L2-L3 voltage L3-L1 voltage</p>	<p>C02</p> <p>Maximum values L1-L2 voltage L2-L3 voltage L3-L1 voltage</p>	<p>D02</p> <p>Minimum values L1-L2 voltage L2-L3 voltage L3-L1 voltage</p>
<p>△</p> <p>A03</p> <p>Measured values L1 current L2 current L3 current</p>	<p>B03</p> <p>Mean values L1 current L2 current L3 current</p>	<p>C03</p> <p>Maximum values L1 current L2 current L3 current</p>	<p>D03</p> <p>Max. values (mean value) L1 current L2 current L3 current</p>
<p>△</p> <p>A04</p> <p>Measured value Sum Current in the N line</p>	<p>B04</p> <p>Mean value Sum Current in the N line</p>	<p>C04</p> <p>Maximum value Measured value sum Current in the N line</p>	<p>D04</p> <p>Maximum values Sum mean value Current in the N line</p>
<p>△</p> <p>A05</p> <p>Measured values L1 active power L2 active power L3 active power</p>	<p>B05</p> <p>Mean value L1 active power L2 active power L3 active power</p>	<p>C05</p> <p>Maximum values L1 active power L2 active power L3 active power</p>	
<p>△</p> <p>A06</p> <p>Measured value Sum Active power</p>	<p>B06</p> <p>Mean value Sum Active power</p>	<p>C06</p> <p>Maximum value Sum Active power</p>	<p>D06</p> <p>Maximum value Sum Active power mean value</p>
<p>△</p> <p>A07</p> <p>Measured values L1 apparent power L2 apparent power L3 apparent power</p>	<p>B07</p> <p>Mean values L1 apparent power L2 apparent power L3 apparent power</p>	<p>C07</p> <p>Maximum values L1 apparent power L2 apparent power L3 apparent power</p>	

△	A08	B08	C08
	Measured value Sum Apparent power	Mean value Sum Apparent power	Maximum value Sum Apparent power
△	A09	B09	C09
	Measured values L1 reactive power L2 reactive power L3 reactive power	Mean values L1 reactive power L2 reactive power L3 reactive power	Maximum values (ind) L1 reactive power L2 reactive power L3 reactive power
△	A10	B10	C10
	Measured value Sum of reactive power	Mean value Sum of reactive power	Maximum value (ind) Sum of reactive power
△	A11	B11	C11
	Measured value Distortion factor (THD) U L1	Measured value Distortion factor (THD) U L2	Measured value Distortion factor (THD) U L3
△	A12	B12	C12
	Measured value Distortion factor (THD) I L1	Measured value Distortion factor (THD) I L2	Measured value Distortion factor (THD) I L3
△	A13	B13	C13
	Maximum value Distortion factor (THD) U L1	Maximum value Distortion factor (THD) U L2	Maximum value Distortion factor (THD) U L3
△	A14	B14	C14
	Maximum value Distortion factor (THD) I L1	Maximum value Distortion factor (THD) I L2	Maximum value Distortion factor (THD) I L3

△	A15						
	Measured value L1 cos(phi) L2 cos(phi) L3 cos(phi)						
△	A16	B16					
	Measured value Sum of cos(phi)	Mean value Sum of cos(phi)					
△	A17						
	Measured value Frequency L1 Rotation field display						
△	A18	B18	C18	D18	E18	F18	G18
	Measured value Total active energy (without a backstop)	Measured value Total active energy (import)	Measured value Total active energy (export)	Measured value Sum Apparent energy	Measured value Active energy L1 Import (tariff 1)	Measured value Active energy L2 Import (tariff 1)	Measured value Active energy L3 Import (tariff 1)
△	A19	B19	C19	D19	E19	F19	
	Measured value (ind) Reactive energy	Measured value Sum Reactive energy cap.	Measured value Sum Reactive energy ind.	Measured value Reactive energy L1 ind. (tariff 1)	Measured value Reactive energy L2 ind. (tariff 1)	Measured value Reactive energy L3 ind. (tariff 1)	
△	A20	B20		G20			
	Operating hours meter 1	Comparator 1A Total running time	...	Comparator 2C Total running time			
△	A21	B21		H21			
	Measured value 1st. harmonic U L1	Measured value 3rd. harmonic U L1	...	Measured value 15th. harmonic U L1			

Marked menus are not displayed in the factory presetting.

△ A22	▷ B22	▷ H22
Measured value 1st. harmonic U L2	Measured value 3rd. harmonic U L2	Measured value 15th. harmonic U L2
...	...	...
△ A23	B23	H23
Measured value 1st. harmonic U L3	Measured value 3rd. harmonic U L3	Measured value 15th. harmonic U L3
...	...	...
△ A24	B24	H24
Measured value 1st. harmonic I L1	Measured value 3rd. harmonic I L1	Measured value 15th. harmonic I L1
...	...	...
△ A25	B25	H25
Measured value 1st. harmonic I L2	Measured value 3rd. harmonic I L2	Measured value 15th. harmonic I L2
...	...	...
△ A26	B26	H26
Measured value 1st. harmonic I L3	Measured value 3rd. harmonic I L3	Measured value 15th. harmonic I L3
...	...	...
△ A27	B27	H27
Maximum value 1st. harmonic U L1	Maximum value 3rd. harmonic U L1	Maximum value 15th. harmonic U L1
...	...	...
△ A28	B28	H28
Maximum value 1st. harmonic U L2	Maximum value 3rd. harmonic U L2	Maximum value 15th. harmonic U L2
...	...	...

Marked menus are not displayed in the factory presetting.

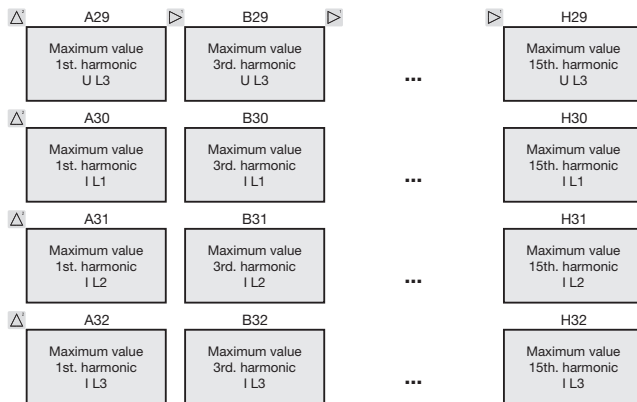

**Even** and **odd** harmonics up to the **40th order** can be called up via the GridVis software and can be viewed in the software.

Marked menus are not displayed in the factory presetting.



## Declaration of conformity

The product fulfils the following EC Directives:	
2004/108/EG	Electromagnetic compatibility of electrical equipment.
2006/95/EG	Electrical equipment for use within certain voltage limits.
Considered standards:	
Noise immunity IEC/EN 61326-1:2013 IEC/EN 61000-4-2:2009 IEC/EN 61000-4-3:2011 IEC/EN 61000-4-3:2011, EMV-ILA V01-03 IEC/EN 61000-4-4:2013, EMV-ILA V01-03 IEC/EN 61000-4-5:2007, EMV-ILA V01-03 IEC/EN 61000-4-6:2009, EMV-ILA V01-03 IEC/EN 61000-4-8:2010 IEC/EN 61000-4-11:2005, EMV-ILA V01-03	Class A: Industrial environment Electrostatic discharge Electromagnetic RF Field 80-1000MHz Electromagnetic RF Field 1000-2700MHz Burst Surge Conducted disturbances 0.15-80MHz Power frequency magnetic field Voltage dips, short interrupts, voltage variations and frequency changes
Noise emission IEC/EN 61326-1:2013 IEC/CISPR11/EN 55011:2011 IEC/CISPR11/EN 55011:2011 EMV-ILA V01-03 EMV-ILA V01-03	Class B: Residential environment Radio disturbance field strength 30-1000MHz Radio disturbance voltage 0.15-30MHz Radio disturbance voltage 9-150kHz Flicker
Equipment safety IEC/EN 61010-1:2011  IEC/EN 61010-2-030:2011	Safety requirements for electrical equipment for Measurement, control and laboratory use – Part 1: General requirements Particular requirements for testing and measuring circuits





## Connection example

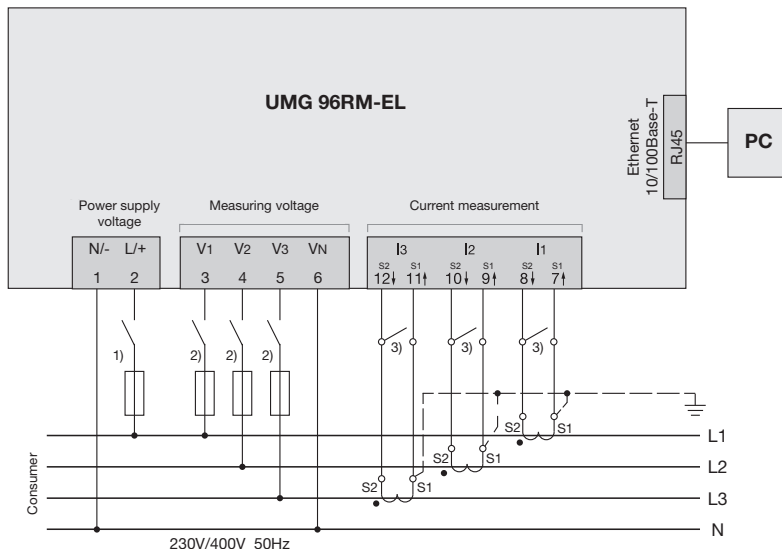

- 1) UL / IEC approved overcurrent protection system (6A type C)
- 2) UL / IEC approved overcurrent protection system (10A type C)
- 3) Jumpers (external)

## Basic functions quick guide

### Adjusting the current transformer

Switch to the programming mode:

- Press button 1 and 2 simultaneously for around 1 second to switch to the programming mode. The symbols for the programming mode PRG and the current transformer mode CT appear on the display.
- Press button 1 to confirm the selection.
- The first digit of the input field for the primary current is flashing.

Adjusting the primary current

- Press button 2 to change the flashing digit.
- Press button 1 to select the next digit to be changed. The selected digit to be changed is flashing. If the entire number is flashing, press button 2 to move the decimal point.

Adjusting the secondary current

- Only 1A or 5A can be set as secondary current.
- Press button 1 to select the secondary current.
- Press button 2 to change the flashing digit.

Exit programming mode

- Press button 1 and 2 simultaneously for around 1 second to switch to the display mode.

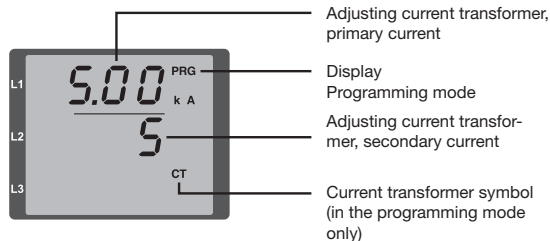

### View measured values

Switch to the display mode:

- If you are still in the programming mode (PRG and CT icons displayed on the screen), press button 1 and 2 simultaneously for around 1 second to switch to the display mode.
- A measured value display (e.g. voltage) appears

Button controls

- Press button 2 to change the measured value display for current, voltage, power, etc.
- Press button 1 to change the mean values, max. values etc. associated with the measured value.

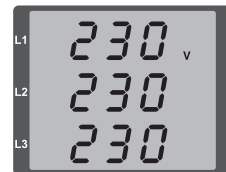

## TCP/IP addressing quick guide

### Manual TCP/IP settings

Switch to the programming mode:

- Press button 1 and 2 simultaneously for around 1 second to switch to the programming mode. The symbols for the programming mode PRG and the current transformer mode CT appear on the display.

Adjust the TCP/IP address (Adr.)

- Press button 2 to select "Adr"
- Press button 1 to enable the first digit (byte 0) of the address (digit is flashing). Press button 2 to set the digit.
- Press button 1 to select the next digit (flashing) and set the desired digit by pressing button 2.
- If byte is set to 0, the address can be set from 1 to 3 by pressing button 1. Then the display jumps back to Byte 0 (**no** digit is flashing).

Subnet mask (SUB)

- Press button 2 to select the subnet mask and set it in a manner similar to adjusting the address by pressing button 1 and 2.

Adjusting the gateway address (GAT)

- Use button 2 and 1 to set the gateway in a manner similar to adjusting the address.

Deactivate dynamic IP allocation (cf. page 41)

- Set the parameter „dYn IP“ to the „Fixed IP address“ mode

Exit programming mode

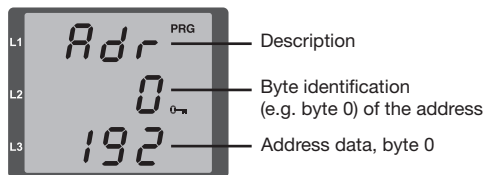
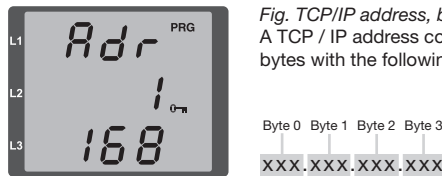

Fig. TCP/IP address, byte 1  
A TCP / IP address consists of 4 bytes with the following structure:



- Press button 1 and 2 simultaneously to exit the mode or wait 60 seconds.

### Activate/deactivate dynamic IP allocation (dyn)

Device/gateway address and subnet mask are assigned by a DHCP server and enable automatic integration of the device into the existing mains.

- When in programming mode, press button 2 repeatedly to display the tab labelled „dYn IP“ and activate the parameter with button 1.
- Select the parameter digit with button 1 and set the value (e.g. 000=fixed IP address, 002 = Activated DHCP mode) with button 2.
- Exit programming mode.