

Power Quality Analyser

UMG 512

Operation manual
and technical data



Janitza electronics GmbH
Vor dem Polstück 1
D-35633 Lahnuau
Support Tel. 0049 6441 9642-22
Fax 0049 6441 9642-30
E-mail: info@janitza.com
Website: <http://www.janitza.com>

Janitza®

Table of contents

General information	4	Operation	47
Inspection on receipt	7	Meaning of the keys	47
Scope of delivery UMG 512	8	Measured value display	48
Available accessories	8	"Home" measured value display	49
Product description	9	Selecting a measured value display	50
Proper use	9	View additional information	51
UMG 512 features	10	Deleting min./max. values individually	52
Measuring process	11	Transients list	53
Operating concept	11	Event list	54
GridVis network analysis software	11	Configuration	55
Connection variants	12	Connecting the supply voltage	55
Installation	13	Configuration menu	56
Position of installation	13	Language	56
Mounting position	13	Communication	57
Front panel section	13	Measurement	59
Ethernet	14	Measuring transducer	60
Mounting	14	Transients	64
Installation	16	Events	66
Ground wire connection	16	Relevant voltage	68
Supply voltage	16	Nominal frequency	69
Voltage measurement	18	Flicker	70
Three-phase 3-conductor systems	18	Temperature	70
Rated voltages	19	System	71
Frequency measurement	27	Password	72
Current measurement	28	Resetting	73
Residual current measurement inputs (RCM)	32	Display	76
Temperature measurement input	35	Extensions	79
RS485 interface	36	Commissioning the unit	81
Profibus interface	40	Connecting the supply voltage	81
Ethernet interface	42	Connecting the measured voltage	81
Digital outputs	43	Frequency measurement	82

Direction of the rotating field	82
Applying the measuring-circuit voltage	83
Applying the residual current	85
Checking the power measurement	87
Checking the communication	87
Measurement range exceeded (overload)	88
RS485 interface	89
Profibus	91
Digital in-/outputs	95
Service and maintenance	100
Service	100
Device calibration	100
Calibration intervals	100
Firmware update	101
Battery	101
Technical data	104
Function parameters	111
Dimension diagrams	116
Configuration menu overview	118
Measured value displays overview	119
Connection example	124

General information

Copyright

This manual is subject to the statutory provisions of copyright law and may not be photocopied, reprinted, or reproduced - in whole or in part, by mechanical or electronic means - nor otherwise duplicated or republished, without the binding written permission of:

Janitza electronics GmbH, Vor dem Polstück 1,
D 35633 Lahnau, Germany.

Trademarks

All trademarks and the resulting rights are the property of their respective owners.

Disclaimer

Janitza electronics GmbH accepts no responsibility for errors or deficiencies within this manual, and makes no commitment to keep the contents of this functional description up to date.

Comments on the manual

We welcome your comments. If anything in this manual seems unclear, please let us know by sending an e-mail to: info@janitza.de

Meaning of symbols

This manual uses the following pictograms:



Dangerous voltage!

Risk to life or serious injury. Before commencing work on the system and the device, they must first be de-energised.



Please note!

Please pay attention to the documentation. This symbol is intended to warn you of potential dangers, which could occur during installation, commissioning and use.



Note!



Ground wire connection.



Inductive.

The current lags behind the voltage.



Capacitive.

The voltage lags behind the current.

Instructions on use

Please read this operation manual as well as all other publications that must be consulted for working with this product (in particular, for the installation, operation or maintenance).

Observe all safety instructions and warnings. Failure to comply with the instructions can result in personal injuries and/or damage to the product.

Any unauthorised changes or use of this device, which go beyond the mechanical, electrical or otherwise stated operating limitations, can result in bodily injury or/and damage to the product.

Any such unauthorised change constitutes "misuse" and/or "negligence" according to the warranty for the product and thus excludes the warranty for covering possible damage resulting from this.

This device must only be operated and repaired by specialised personnel.

Specialised personnel are persons, that based on their respective training and experience, are qualified to recognise risks and prevent potential dangers that can be caused by the operation or maintenance of the device.

Additional legal and safety regulations required for the respective application are to be followed during the use of the device.



If the device is not operated according to the operation manual, protection is no longer ensured and hazards can be presented by the device.



Single core conductor must be provided with sleeves.



Only pluggable screw terminals with the same number of poles and the same type of construction are permitted to be connected together.

Concerning this operation manual

This operation manual is part of the product.

- Read the operation manual before using the device.
- Keep the operation manual instructions throughout the entire service life of the product and have them readily available for reference.
- Pass the operation manual on to each subsequent owner or user of the product.



All screw-type terminals included in the scope of delivery are attached to the device.



All supplied options and versions are described on the delivery note.

Inspection on receipt

The prerequisites of faultless, safe operation of this device are proper transport and proper storage, set-up and installation, as well as careful operation and maintenance. If it can be assumed that risk-free operation is no longer possible, the device must be immediately put out of operation and secured against being put back into operation again.

Packing and unpacking must be carried out with customary care without the use of force and only using suitable tools. The devices should be visually checked for flawless mechanical condition.

It can be assumed that risk-free operation is no longer possible if the device, for example,

- has visible damage
- no longer works despite the mains power supply being intact
- has been exposed to prolonged adverse conditions (e.g. storage outside the permissible climate limits without being adapted to the room climate, condensation, etc.) or rough handling during transportation (e.g. falling from a height, even if there is no visible external damage, etc.)
- please check the delivered items for completeness before you start installing the device.

Scope of delivery UMG 512

Number	Part no.	Name
1	52.17.xxx ¹⁾	UMG 512
1	33.03.192	Operation manual
1	51.00.116	CD with following content - GridVis programming software - GridVis functional description - UMG 512, GSD file "JAN0EDC.GSD"
1	10.01.855	Screw-type terminal, pluggable, 2-pole (auxilliary power)
1	10.01.847	Screw-type terminal, pluggable, 5-pole (voltage measurement 1-4)
1	10.01.853	Screw-type terminal, pluggable, 8-pole (current measurement 1-4)
1	10.01.873	Screw-type terminal, pluggable, 6-pole (digital inputs/outputs)
1	10.01.888	Screw-type terminal, pluggable, 7-pole (RCM, thermistor input)
1	10.01.859	Screw-type terminal, pluggable, 3-pole (RS 485)
1	08.01.505	Patch cable 2 m, twisted, grey (connection UMG PC/switch)
1	52.19.301	Mounting clips

¹⁾ For the item number, see delivery note

Available accessories

Part no.	Name
21.01.102	Lithium battery CR2450, 3V (approval according to i.a.w. UL 1642)
13.10.539	Profibus connector, 9-pole, D-SUB
13.10.543	Profibus connector, 9-pole, D-SUB, angled
29.01.903	Seal, 144 x 144

Product description

Proper use

The UMG 512 is intended for the measurement of voltage quality according to EN61000-4-30 in building installations, on distribution units, circuit breakers and busbar trunking systems.

Measured voltages and measured currents must derive from the same network.

The UMG 512 is suitable for integration into fixed and weatherproof switch panels. Conductive switch panels must be earthed.

The UMG 512 can be used in 2, 3 and 4-conductor networks and in TN and TT networks.

The current measurement inputs 1–4 of the UMG 512 are connected via external $..1A$ or $..5A$ current transformers.

Measurements in medium and high-voltage networks are always performed via current and voltage transformers.

The measurement results can be displayed and read out and further processed via the interfaces (Ethernet, Modbus, Profibus).

The UMG 512 can be used in industrial and domestic settings.

By continuously monitoring the residual currents (RCM) of an electrical system via the inputs I5 and I6, warning pulses can be triggered if a response threshold is exceeded. Using these, the system operator can be alarmed before a protective equipment reacts. The UMG 512 does not provide protection against electric shock!

The residual current monitoring is performed via the current measurement inputs I5 and I6 via an external residual current transformer with a rated current of 30 mA.



Residual current monitoring monitors residual currents via external current transformers and can trigger a warning impulse when a response threshold is exceeded. The device is thus **not** an independent protective device!

UMG 512 features

General information

- Front panel integration device with dimensions 144 x 144 mm
- Connection via pluggable screw terminals
- Colour graphic display 320x240, 256 colours
- Operation via 6 buttons
- 4 Voltage and 4 current measurement inputs
- 2 Residual current inputs with failure monitoring
- 1 Temperature measurement input
- 2 digital outputs and 2 digital inputs
- 16-bit A/converter, memory 256 Mbyte Flash, SDRAM 32 Mbyte
- RS485 interface (Modbus RTU, slave, up to 115 kbps)
- Profibus DP/V0
- Ethernet (web server, e-mail)
- Capturing more than 2000 measured values
- Clock and battery (with battery monitoring function)
- Working temperature range -10°C .. +55°C
- Continuous sampling of the voltage and current measurement inputs
- Continuous monitoring of residual currents with failure monitoring
- Temperature measurement
- Measurement of the power quality in accordance with DIN EN61000-4-30, Class A
- Flicker measurement in accordance with DIN EN61000-4-15:2011, Class F1
- Working measurement, measurement uncertainty in accordance to DIN EN50470-3:
 - Class C for ../5A converter,
 - Class B for ../1A converter,
- Measurement of the harmonics 1st to 63rd in accordance with DIN EN61000-4-7 class 1, for
 - Ull, Uln, I, P (cons./del.) and
 - Q (ind./cap.),
- Measurement of the interharmonics 1st to 63rd for (Uln, Ull, I) in accordance with DIN EN61000-4-7 cl.1

Measurement

- Measurement in TN and TT networks
- Continuous sampling of the voltage and current measurement inputs at 25.6 kHz
- Frequency range of the fundamental oscillation 15Hz .. 440Hz
- Acquisition of transients >39 µs and storage of up to approx. 330,000 sampling points
- Metering range current 0.001 to 7Arms.
- True RMS (TRMS)
- Analysis and evaluation in accordance with DIN EN50160 with the GridVis programming software included in the scope of delivery
- Programming separate applications in Jasic

Measuring process

The UMG 512 measures continuously and calculates all effective values over a 200 ms interval. The device measures the real effective value (TRMS) of the voltages and currents connected to the measurement inputs.

Operating concept

You can program and call up the measured values via many routes using the UMG 512.

- **Directly** on the device via 6 buttons and the display
- Using the **GridVis** programming software.
- Using the device **homepage**
- Using the Modbus **protocol**.

You can modify and call up the data using the Modbus address list. The list can be called up via the device's home page and can be found on the enclosed CD.

This operation manual only describes how to operate the UMG 512 using the six buttons.

The GridVis programming software has its own "online help" system.

GridVis network analysis software

The UMG 512 can be programmed and read out using the GridVis network analysis software included in the scope of the delivery. For this, a PC must be connected to the UMG 512 via a serial interface (RS485/Ethernet).

GridVis features

- Programming the UMG 512
- Configuring recordings
- Analysing the read out data according to EN 61000-2-4.
- Reading out recordings
- Saving data to a database
- Graphical representation of measured values
- Programming customer-specific applications

Connection variants

Connection of a UMG 512 to a PC via an interface converter: Direct connection of a UMG 512 to a PC via Ethernet.



Connection of a UMG 96RM via a UMG 512 as a gateway

Connection of a UMG 512 to a PC via Ethernet.

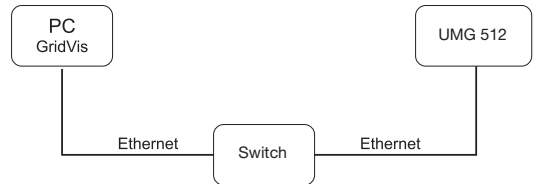
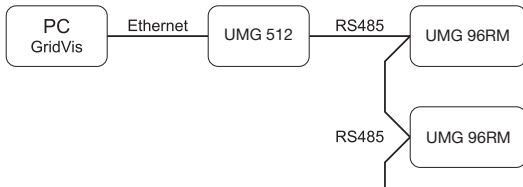

Installation

Position of installation

The UMG 512 is suitable for integration into fixed and weatherproof switch panels. Conductive switch panels must be earthed.

Mounting position

To ensure adequate ventilation, the UMG 512 must be installed vertically. There should be separation above and below of at least 50mm with 20mm space to the sides.

Front panel section

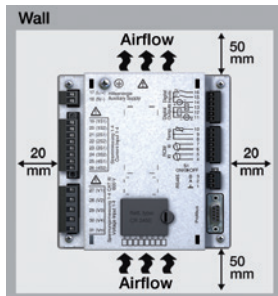

Cut-out size:
 $138^{+0.8} \times 138^{+0.8}$ mm

Fig. mounting position UMG 512 (View from rear)



Failure to meet the minimum clearances can destroy the UMG 512 at high ambient temperatures!

Ethernet

The Ethernet connection of the UMG 512 is on the bottom of the housing.

Depending on the bending radius of the Ethernet cable and connector type, you must install a connection area below the UMG 512.

The connection area below the UMG 512 should not be smaller than 50 mm.

Mounting

The UMG 512 is mounted in the switchboard with two mounting clips that are installed at the top and bottom of the device.

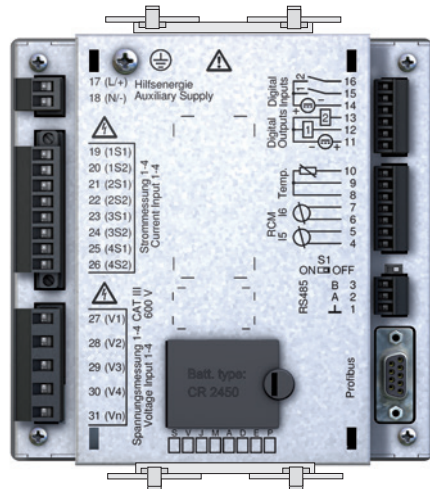
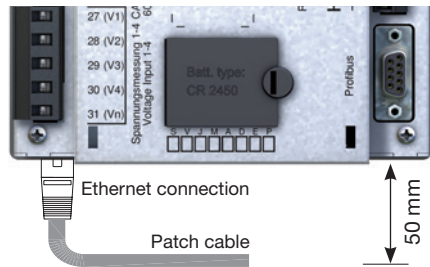

Installation

Ground wire connection

Use a ring cable lug for connecting the protective conductor to the UMG 512.

Supply voltage

The UMG 512 needs supply voltage to operate. The type and amount of the supply voltage required is specified on the rating plate. The supply voltage is connected on the rear side of the device via terminal blocks.

Before connecting the supply voltage, ensure that the voltage and frequency correspond to the details on the rating plate!

The supply voltage must be connected through a UL/IEC approved fuse (6A type C).

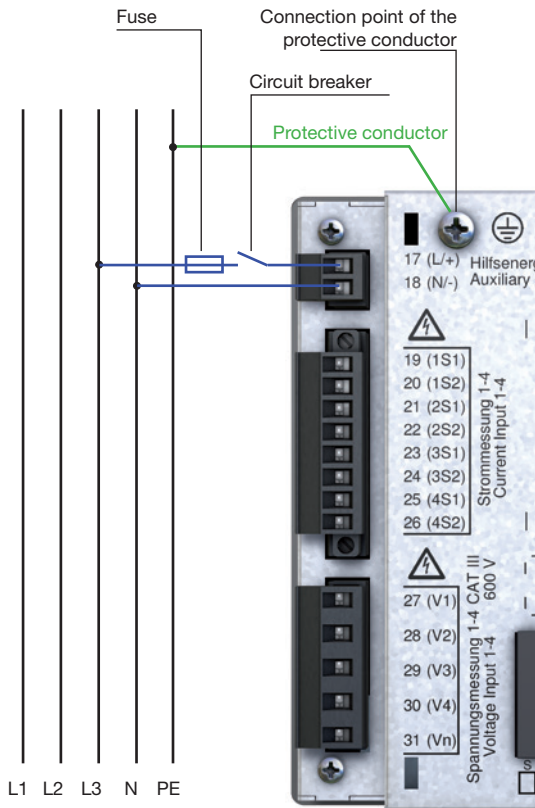

Caution: Risk to life!

The ground wire connection on the device must be connected with the system earthing.

Fig. connection example of the supply voltage to a UMG 512.

**Please note!**

The inputs for the supply voltage are hazardous if touched!

**Please note!**

Make sure to observe the specifications for the supply voltage that are provided on the rating plate of the UMG 512.



- If installed in a building, a disconnect or circuit breaker must be provided for the supply voltage.
- The disconnect must be installed near the device and easily accessible to the user.
- The switch must be marked as the circuit breaker for this device.
- Voltages which are over the permitted voltage range can destroy the device.

Voltage measurement

Three-phase 4-conductor systems

The UMG 512 can be used in three-phase 4-conductor systems (TN, TT networks) with an earthed neutral conductor. The bodies of the electrical system are earthed.

The voltage measurement in the UMG 512 is designed for the overvoltage category 600V CAT III (measurement voltage surge 6kV).

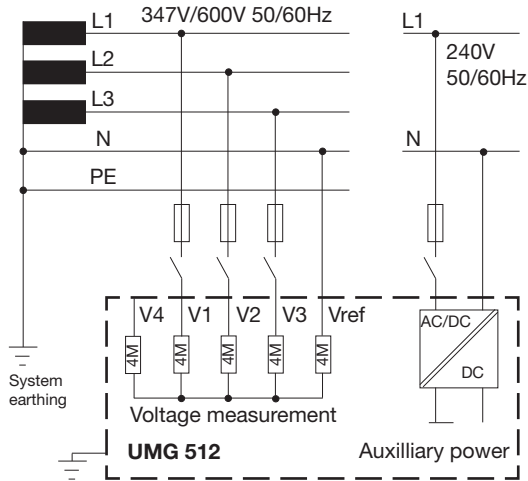

Fig. Schematic diagram, UMG 512 in a TN network.

Three-phase 3-conductor systems

The UMG 512 is only suitable to a limited extent for use in IT networks, since the measured voltage relative to the housing potential is measured and the input impedance of the device creates residual current against the earth. The residual current can trigger the insulation monitoring in IT networks.

The connection variants with voltage transformers are suitable for unlimited use in IT networks.

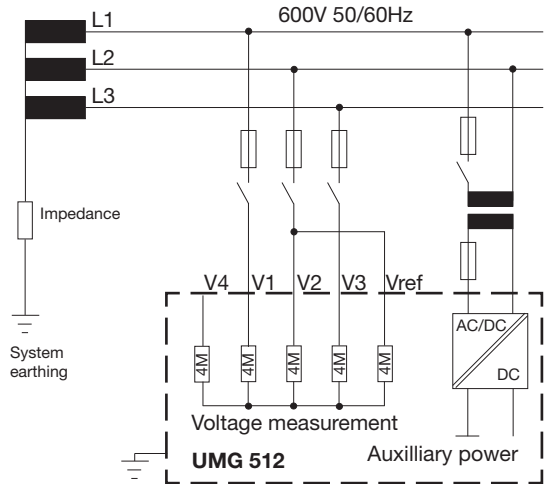

Fig. Schematic diagram, UMG 512 in an IT network without N.

Rated voltages

Lists of networks and their nominal network voltages in which the UMG 512 can be used.

Three-phase 4-conductor systems with earthed neutral conductor.

U_{L-N} / U_{L-L}
66V / 115V
120V / 208V
127V / 220V
220V / 380V
230V / 400V
240V / 415V
260V / 440V
277V / 480V
347V / 600V
400V / 690V
417V / 720V

Maximum system rated voltage according to UL

Maximum system rated voltage

Three-phase 3-conductor systems, ungrounded.

U_{L-L}
66V
115V
120V
127V
200V
220V
230V
240V
260V
277V
347V
380V
400V
415V
440V
480V
500V
577V
600V

Maximum system rated voltage

Fig. Table for network rated voltages i.a.w. EN60664-1:2003 suitable for the voltage measurement inputs.

Fig. Table for network rated voltages i.a.w. EN60664-1:2003 suitable for the voltage measurement inputs.

Voltage measurement inputs

The UMG 512 has four voltage measurement inputs (V1, V2, V3, V4).

Voltage swell

The voltage measurement inputs are suitable for measurements in networks where overvoltages of overvoltage category 600V CATIII can occur.



For measurement with the supporting measurement (V4), a voltage must be connected to the baseline measurement for frequency determination.



If the baseline measurement (inputs V1-V3) is connected to a three-phase 3-conductor network, the supporting measurement (input V4) can no longer be used as a measurement input.

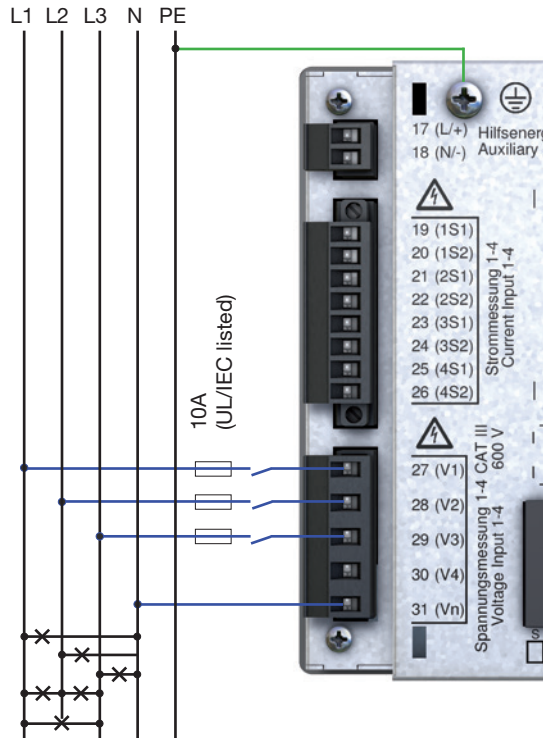

Fig. Example connection for measuring voltage.

When connecting the voltage to be measured, the following must be observed:

- A suitable circuit breaker must be fitted to disconnect and de-energise the UMG 512.
- The circuit breaker must be placed in the vicinity of the UMG 512, be marked for the user and easily accessible.
- Use a UL/IEC approved circuit breaker 10A (Type C) for the overcurrent protection and disconnect.
- The overcurrent protection must have a rated value, which is suitable for the short circuit current at the connection point.
- Measured voltages and measured currents must derive from the same network.

**Please note!**

Voltages that exceed the allow nominal network voltages must be connected via a voltage transformer.

**Please note!**

The UMG 512 is not suitable for measuring DC voltages.

**Please note!**

The voltage measurement inputs on the UMG 512 are dangerous if touched!

**Please note!**

The voltage measurement inputs may not be used for voltage measurement in SELV circuits (safe extra low voltage).

Baseline measurement, digital inputs 1-3

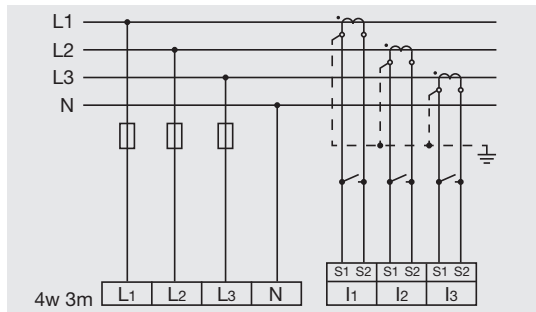

Fig. Measurement in a three-phase 4-conductor network with asymmetric loading.

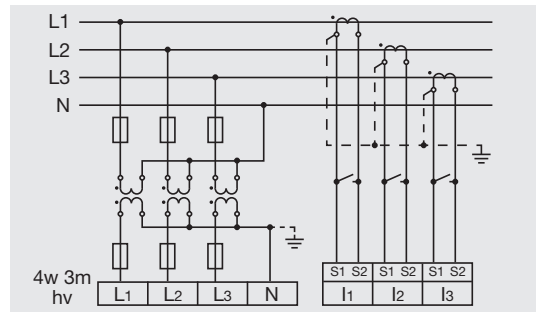

Fig. Measurement via 3 voltage transformers in a three-phase 4-conductor network with asymmetric loading.

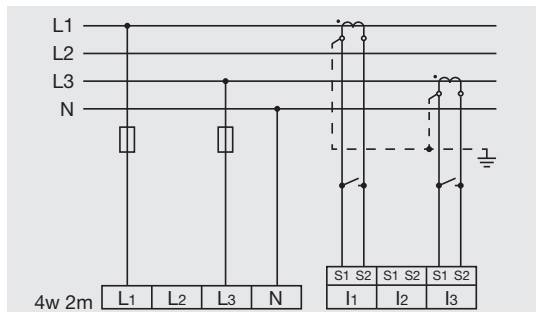

Fig. Measurement in a three-phase 4-conductor network with symmetric loading.

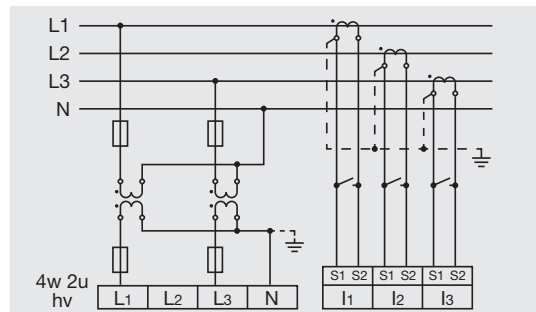

Fig. Measurement via 2 voltage transformers in a three-phase 4-conductor network with asymmetric loading.

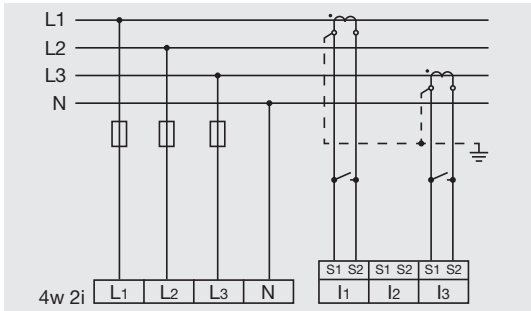

Fig. Measurement via 2 voltage transformers in a three-phase 3-conductor network with symmetric loading.

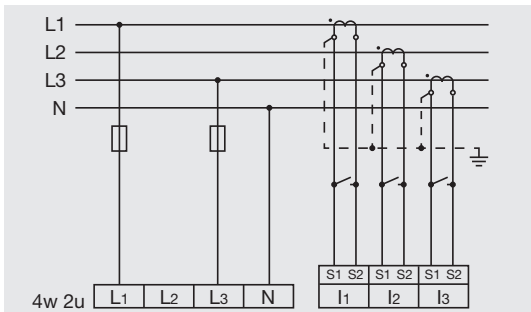

Fig. Measurement in a three-phase 4-conductor network with asymmetric loading.

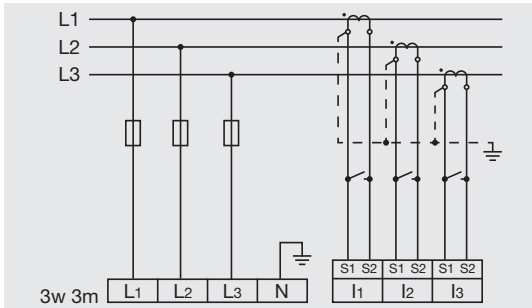

Fig. Measurement in a three-phase 3-conductor network with asymmetric loading.

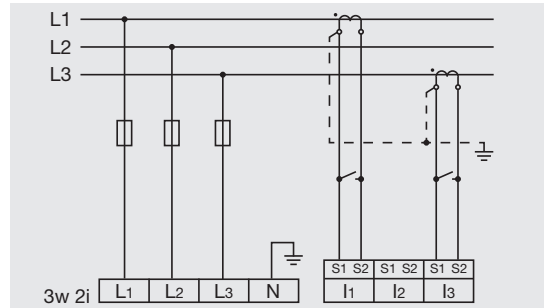

Fig. Measurement in a three-phase 3-conductor network with asymmetric loading.

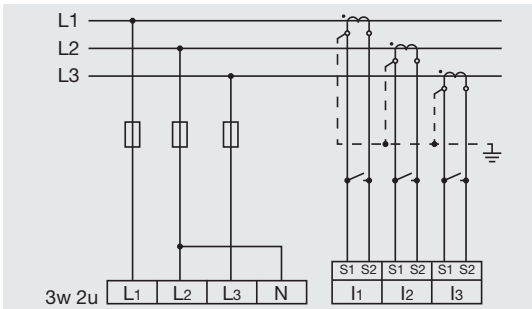

Fig. Measurement in a three-phase 3-conductor network with asymmetric loading.

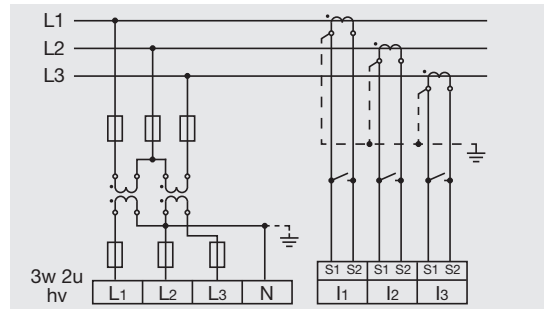

Fig. Measurement in a three-phase 3-conductor network with asymmetric loading.

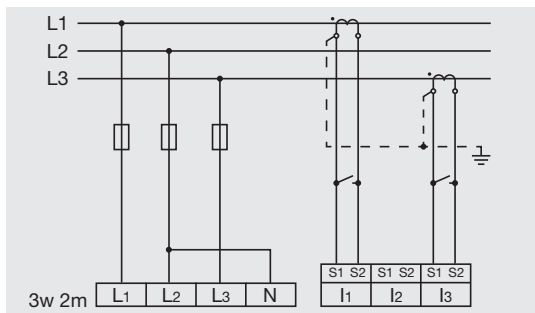

Fig. Measurement in a three-phase 3-conductor network with asymmetric loading.

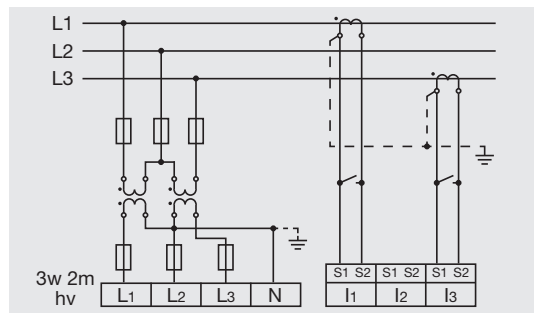

Fig. Measurement in a three-phase 3-conductor network with asymmetric loading.

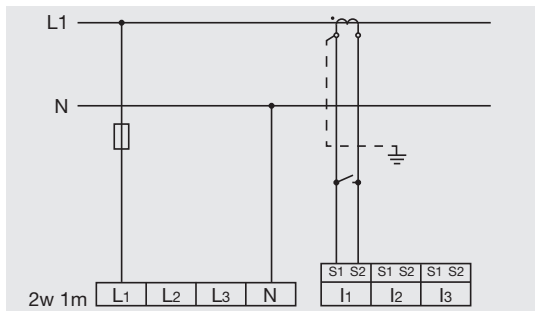

Fig. Measurement of one phase in a three-phase 4-conductor network.

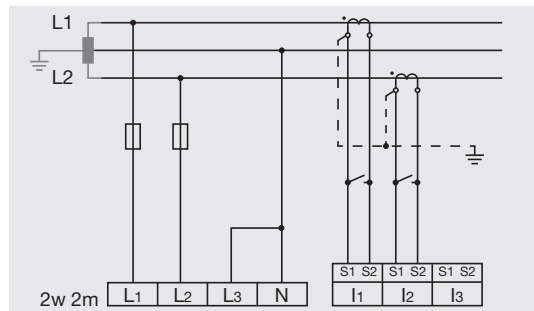

Fig. Measurement in single-phase 3-conductor network. I_3 and U_3 are not calculated and set to zero.

Supporting measurement, input V4

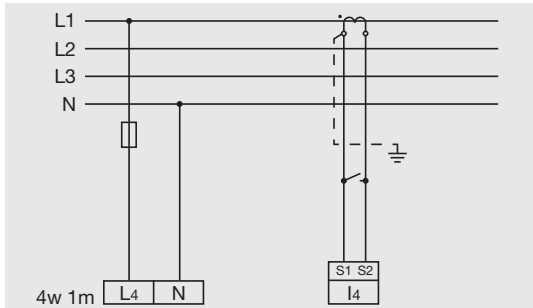

Fig. Measurement in a three-phase 4-conductor network with symmetric loading.

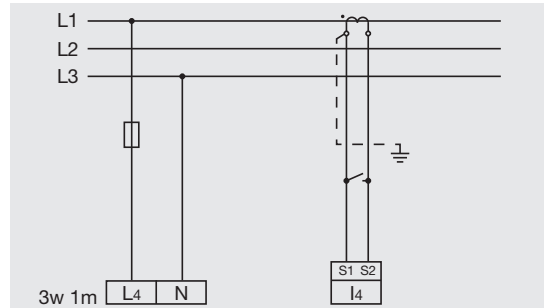

Fig. Measurement in a three-phase 3-conductor network with symmetric loading.

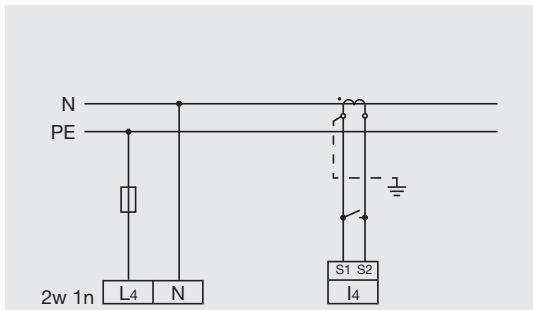

Fig. Measurement of the voltage between N and PE. Measurement of the current in the neutral conductor.



If the baseline measurement (inputs V1-V3) is connected to a three-phase 3-conductor network, the supporting measurement (input V4) can no longer be used as a measurement input.



For measurement with the supporting measurement (V4), a voltage must be connected to the baseline measurement for frequency determination.

Frequency measurement

The UMG 512 is suitable for measurements in networks in which the fundamental oscillation of the voltage is in the range 15Hz to 440Hz.

To automatically determine (wide range) the mains frequency, a voltage L1-N of greater than 10Veff must be applied to voltage measurement input V1.

The mains frequency is only measured on the measurement inputs of the baseline measurement (V1,V2,V3).



Measured voltages and measured currents must derive from the same network.

Current measurement

The UMG 512 is intended for the connection of current transformers with secondary currents of $\dots/1A$ and $\dots/5A$. The factory default for the current transformer ratio is $5/5A$ and must be adapted to the current transformer employed if necessary.

Only AC currents can be measured - DC currents cannot.

Any of the current measurement inputs can be loaded with 120A for 1 second.

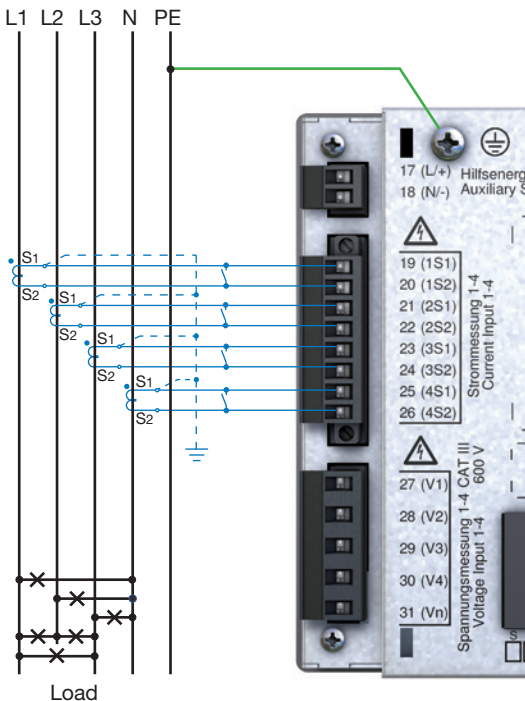

Please note!

The measurement lines must be suitable for an operating temperature of at least 80°C!



Please note!

The UMG 512 is not suitable for measuring DC voltages.



The attached screw-type terminal must be fixed using the two screws on the device!

Fig. Current measurement (I1-I3) via current transformers (connection example)

Current direction

The current direction can be individually corrected via the existing serial interfaces or on the device for each phase.

If incorrectly connected, a subsequent re-connection of the current transformer is not required.



Current transformer connections!

The secondary connection of the current transformer must be short circuited on this before the current feed to the UMG 512 is disconnected!

If a test switch, which automatically short-circuits the secondary wires of the current transformer, is available then it is sufficient to set this to the "Test" position insofar as the short-circuiting device has been checked beforehand.



Please note!

Residual current monitoring is performed using the terminals I5 and I6. There is no directional sensitivity of the residual currents of the network or load sides (not directionally sensitive).



Earthing of current transformers!

If a connection is provided for the earthing of secondary windings, then it must be connected to the earth.



Open-circuit current transformers!

High voltage spikes that are dangerous to touch can occur on current transformers that are driven with open-circuit secondary windings!

With "safe open-circuit current transformers" the winding insulation is rated such that the current transformer can be driven open. However, even these current transformers are dangerous to touch when they are driven open-circuit.

Total current measurement

If the current measurement is done via two current transformers, the overall transformation ratio of the current transformers must be programmed into the UMG 512.

Example:

The current is measured via two current transformers. Both current transformers have a transformation ratio of 1000/5A. The summation measurement is performed using a total current transformer 5+5/5A.

The UMG 512 must then be setup as follows:

Primary current: $1000A + 1000A = 2000A$
 Secondary current: $5A$

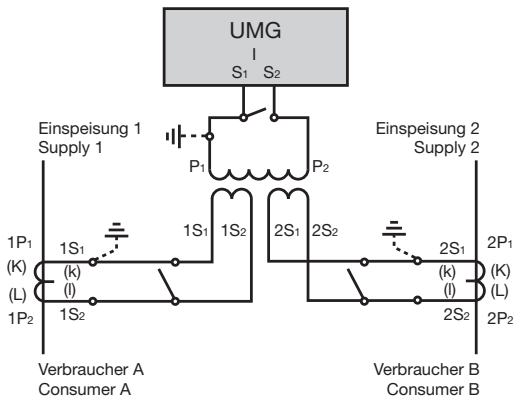

Fig. Example, current measurement via a total current transformer

Direct measurement

You can use the UMG 512 to measure currents up to 5A directly without current transformers.

In this case, it must be taken into consideration that the direct measurement of the current can only be performed in three-phase 4-conductor systems with nominal network voltages up to

- 127V/220V (300V CAT III) according to UL
- 277V/480V (300V CAT III)

and three-phase 3-conductor systems with nominal network voltages up to

- 277V (300V CAT III) according to UL
- 480V (300V CAT III).

Since the UMG 512 does not feature any integrated protection for the current measurement, this protection must be provided in the installation.

Ammeter

If you wish to measure the current not just using the UMG 512, rather also with an ammeter, the ammeter must be connected to the UMG 512 in series.

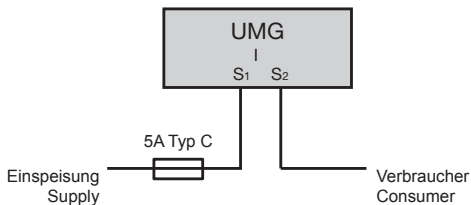
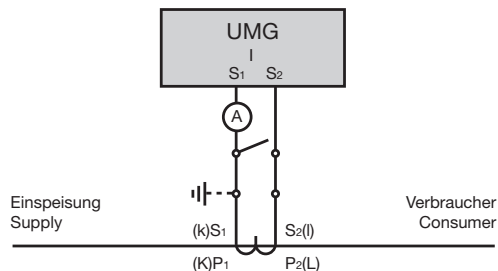

Residual current measurement inputs (RCM)

The UMG 512 is suitable for use as a residual current monitoring device (RCM) as well as for monitoring AC, pulsing DC, and DC.

The UMG 512 can measure type A residual currents in accordance with IEC/TR 60755 (2008-01)



The connection of suitable external residual current transformers with a rated current of 30 mA is performed via the residual current transformer inputs I5 (terminals 4/5) and I6 (terminals 6/7).

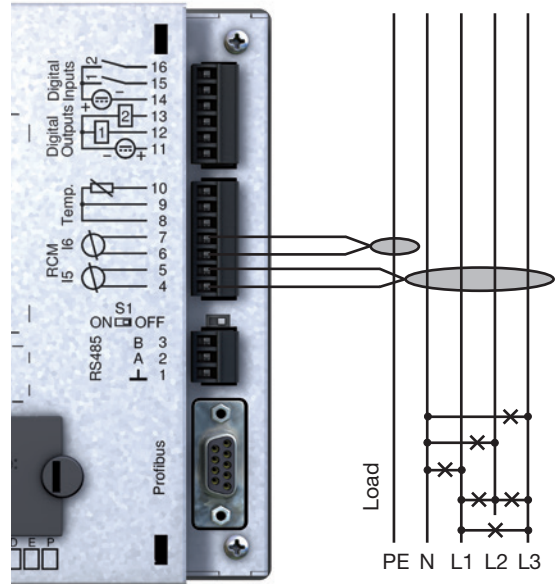

Fig. Connection example of residual current monitoring via current transformers



Residual current transformer ratio

The GridVis software included in the scope of the delivery can be used to individually program the residual current transformer inputs' transformer ratios.



It is not necessary to configure a connection schematic for measurement inputs I5 and I6.

**Please note!**

Operating equipment connected to the analogue inputs must feature reinforced or double insulation to the mains supply circuits!

Example - temperature sensor:

A temperature sensor in close proximity to **non**-isolated mains cables should measure within a 300V CAT III network.

Remedy:

The temperature sensor must be equipped with reinforced or double insulation for 300V CAT III. This equates to a test voltage for the temperature sensor of 3000V AC (duration 1 min.).

Example - residual current transformer:

A residual current transformer should measure on isolated mains cables within a 300V CAT III network.

Remedy:

The insulation of the mains cables and the insulation of the residual current transformer must fulfil the basic insulation requirements for 300V CAT III. This equates to a test voltage of 1500V AC (duration 1 min.) for the insulated mains cables and a test voltage of 1500 V AC (duration 1 min.) for the residual current transformer.

Failure monitoring

The UMG 512 monitors the ohmic resistance at the residual current measurement inputs.

If the ohmic resistance is greater than 300 Ohm, there is a failure (e.g. cable breakage) with the residual current monitoring.

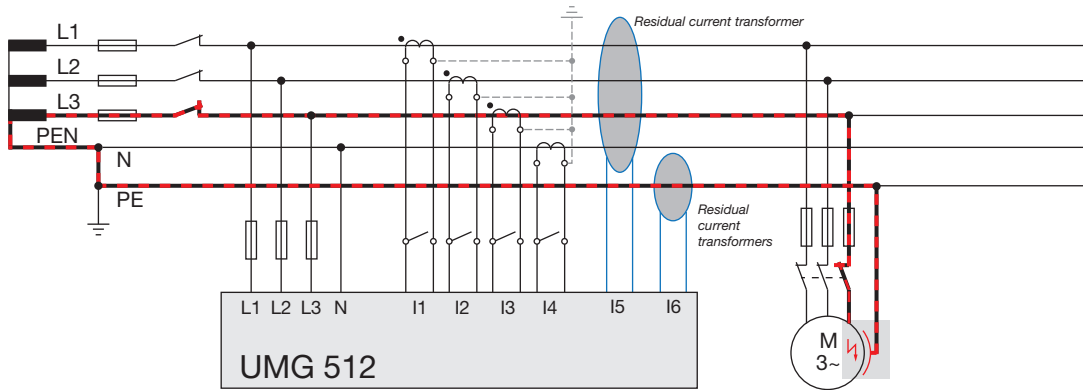

Fig. Example UMG 512 with residual current monitoring via measuring inputs I5/I6.

Temperature measurement input

The UMG 512 has one temperature measurement input. The temperature is measured here via terminals 8 through 10.

Do not exceed the total resistance load (sensor + cable) of 4kOhm.

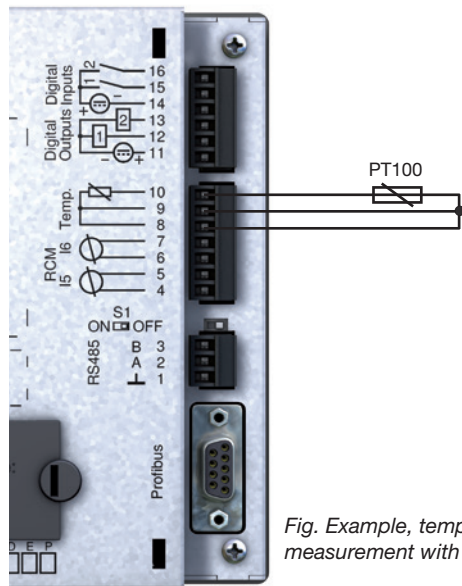
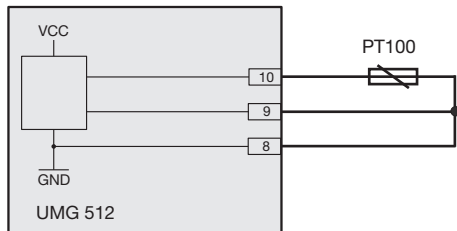

Fig. Example, temperature measurement with a Pt100



Please note!

Profibus, RS485 and the temperature measurement input are not galvanically separated from each other.



Use a shielded cable to connect the temperature sensor.

RS485 interface

In the UMG 512, the RS485 interface is designed as a 3-pin plug contact, which communicates via the Modbus RTU protocol.

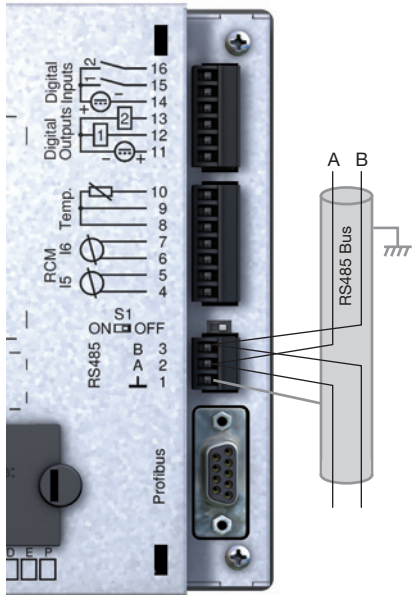



Termination resistors

The cable is terminated with resistors (120Ohm, 1/4W) at the beginning and at the end of a segment.

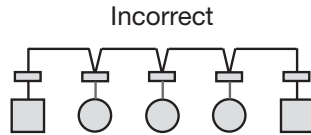
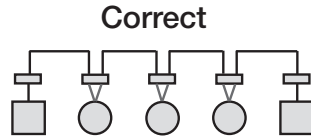
Termination within the device is possible via the S1 DIP switch of the UMG 512.



-  Terminal strip in the cabinet.
-  Device with RS485 interface. (without termination resistor)
-  Device with RS485 interface. (with termination resistor on the device)

Screening

Twisted screened cable should be used for connections via the RS485 interface.

- Earth the screens of all cables that lead to the cabinet and at the cabinet entry.
- Connect the screens over a generous area and in a manner that will conduct well, to a low-noise earth.
- Gather the cables mechanically above the earthing clamp in order to avoid damage due to cable movements.
- Use suitable cable glands to feed the cables into the cabinet, for example, armoured conduit couplings.

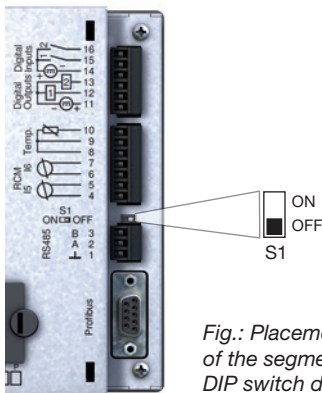

Fig.: Placement in the middle of the segment; termination via S1 DIP switch deactivated (OFF)

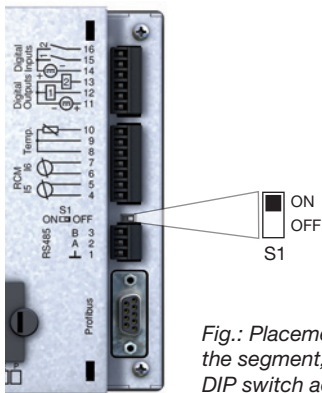

Fig.: Placement at the end of the segment; termination via S1 DIP switch activated (ON)

Cable type

The cable used must be suitable for an environmental temperature of at least 80°C.

Recommended cable types:

Unitronic Li2YCY(TP) 2x2x0.22 (from Lapp Kabel)

Unitronic BUS L2/FIP 1x2x0.64 (from Lapp Kabel)

Maximum cable length

1200m at a baud rate of 38.4k.

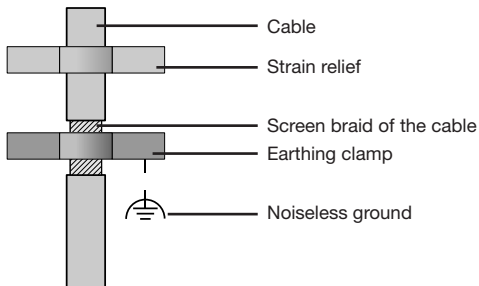

Fig. Screening procedure at cabinet entry.



If the bus line is laid in the switch cabinet, the screen must be connected to functional earth (PE).

When laying bus lines in the switch cabinet it is normally sufficient if the screen of the bus line is connected at least once to the functional earth (PE).

If there are more significant sources of interference, such as a frequency converter, installed in the switch cabinet, the screen must be connected to the functional earth (PE) as close as possible to the device.



CAT cables are not suitable for bus wiring. Use the recommended cable types for this.

Bus structure

- All devices are connected in a bus structure (line) and each device has its own address within the bus (see also Parameter programming).
- Up to 32 subscribers can be connected together in a single segment.
- The cable is terminated with resistors (bus termination 120Ω, 1/4W) at the beginning and at the end of a segment.
- With more than 32 subscribers, repeaters (amplifiers) must be used to connect the individual segments.
- Devices for which the bus connection is switched on must be under current.
- It is recommended that the master be placed at the end of a segment.
- If the master is replaced with a bus connection, the bus must be switched off.
- Replacing a slave with a bus connection that is either switched on or de-energised can destabilise the bus.
- Devices that are not connected to the bus can be replaced without destabilising the bus.

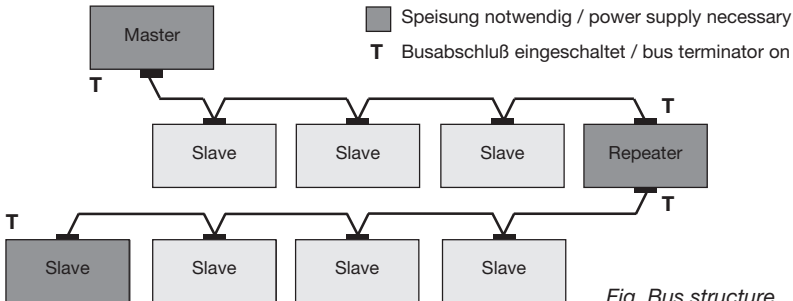

Fig. Bus structure

Profibus interface

This 9-pole D-sub receptacle RS485 interface supports the Profibus DP V0 slave protocol.

For the simple connection of inbound and outbound bus wiring, it should be connected to the UMG 512 via a Profibus connector.

For the connection, we recommend a 9-pole Profibus connector, e.g. type "SUBCON-Plus-ProfiB/AX/SC" from Phoenix, item number 2744380. (Janitza item no: 13.10.539)

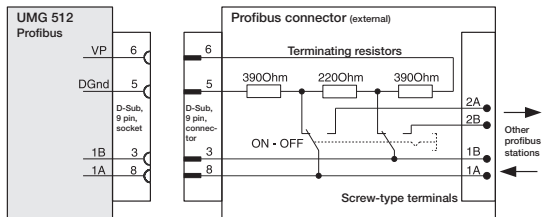

Fig. Profibus connector with termination resistors.



When using the device in a Profibus system, the device address must be set using the configuration menu.

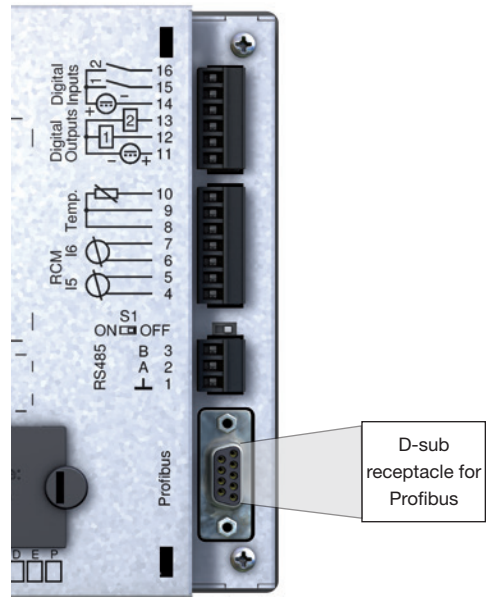

Fig. UMG 512 with D-sub receptacle for Profibus (View from rear).

Connection of the bus wiring

The inbound bus wiring is connected to terminals 1A and 1B of the Profibus connector. The continuing bus wiring for the next device in line should be connected to terminals 2A and 2B.

If there are no subsequent devices in the line, then the bus wiring must be terminated with a resistor (switch to ON).

With the switch set to ON, terminals 2A and 2B are switched off for further continuing bus wiring.

Transfer speeds in Kbit/s	Max. segment length
9.6, 19.2, 45.45, 93.75	1200m
187.5	1000m
500	400m
1500	200m
3000, 6000, 12000	100m

Table Segment lengths per Profibus specification.

Ethernet interface

The Ethernet network settings should be specified by the network administrator and set on the UMG 512 accordingly.

If the network settings are not known, the UMG 512 may not be integrated into the network through the patch cable.



Please note!

Connection of the UMG 512 to the Ethernet may only be carried out after consulting the network administrator!



Please note!

The UMG 512 is factory-set for the dynamic IP address assignment (**DHCP mode**). Settings can be changed as described in "TCP/IP Configuration" or, for example, via an appropriate Ethernet connection by means of GridVis software.

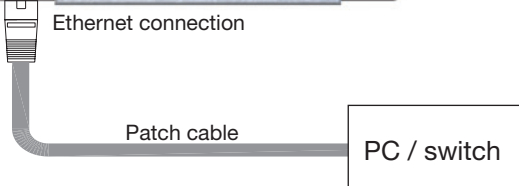
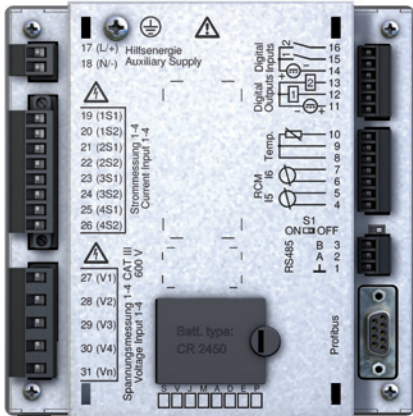

Digital outputs

The UMG 512 has two digital outputs. These outputs are galvanically separated from the analysis electronics using optocouplers. The digital outputs have a joint reference.

- The digital outputs can switch DC loads.
- The digital outputs are **not** short-circuit proof.
- Connected cables that are longer than 30m must be shielded when laid.
- An external auxiliary voltage is required.
- The digital outputs can be used as impulse outputs.

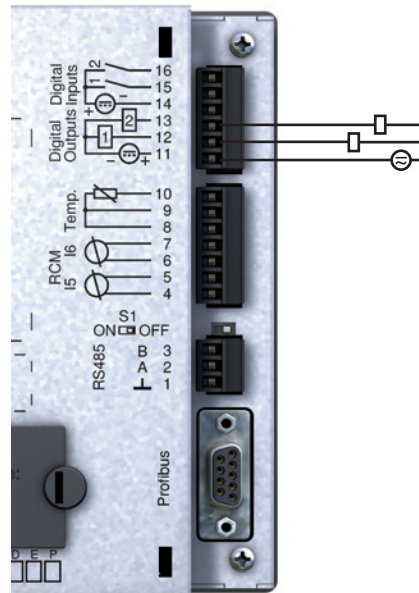

Fig. Connection of digital outputs

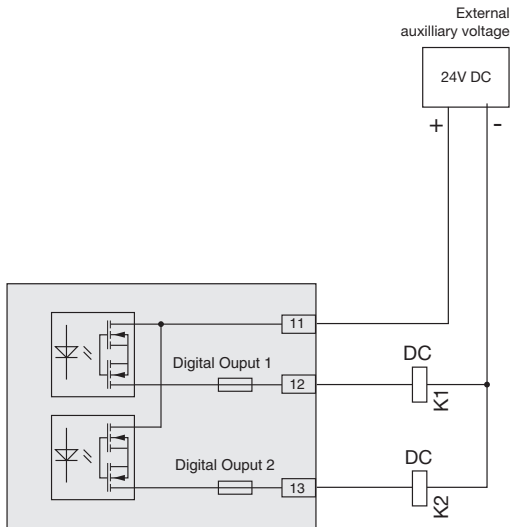

Fig. Example for two relays connected to the digital outputs



When using the digital outputs as pulse outputs, the auxiliary voltage (DC) must have a max. residual ripple of 5%.



Functions for the digital outputs can be adjusted clearly in the GridVis software provided in the scope of delivery. A connection between the UMG 512 and the PC via an interface is required to use the GridVis software.



Please note!
Digital outputs are not short-circuit proof!

Digital inputs

The UMG 512 has two digital inputs. An input signal is detected on a digital input if a voltage of at least 18V and maximum 28V DC (typically at 4mA) is applied. There is no input signal for a voltage of 0 to 5V and a current less than 0.5 mA.

Wiring longer than 30m must be screened.

Note the correct polarity of the supply voltage!

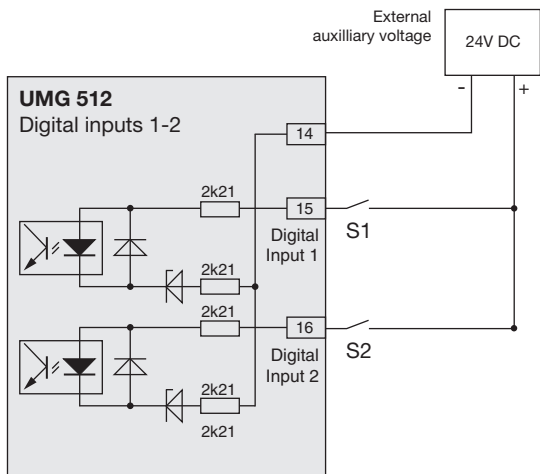

Fig. Example for the connection of external switch contacts S1 and S2 to digital inputs 1 and 2.

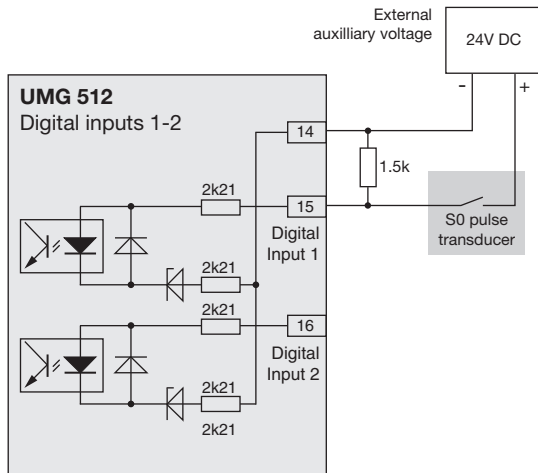

Fig. Connection of digital outputs

S0 pulse input

You can connect an S0 pulse transducer per DIN EN62053-31 to any digital input.

This requires an external auxilliary voltage with an output voltage in the range 18 .. 28V DC and a resistor of 1.5kOhm.



Operation





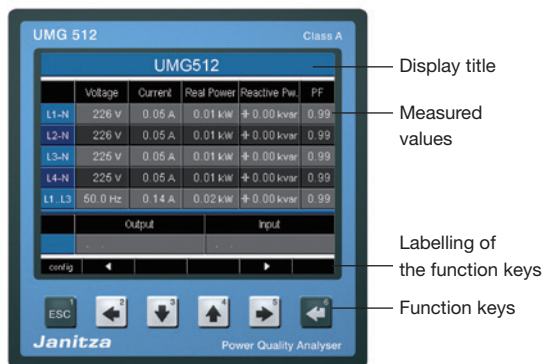

The UMG 512 is operated by six function keys.

Depending on the context, the six keys are assigned with different functions:

- Selecting measured value displays.
- Navigation within the menus.
- Editing device settings.



Meaning of the keys

Key	Function
	<ul style="list-style-type: none"> • Returns to the first screen (home) • Exits selection menu
	<ul style="list-style-type: none"> • Selects number • Selects main values (U, I, P ...)
	<ul style="list-style-type: none"> • Changes (number -1) • By-values (select) • Selects menu item
	<ul style="list-style-type: none"> • Changes (number +1) • By-values (select) • Selects menu item
	<ul style="list-style-type: none"> • Selects number • Selects main values (U, I, P ...)
	<ul style="list-style-type: none"> • Opens selection menu • Confirm selection

Measured value display

Main values

Using the 2 and 5 keys, you can scroll between the main values of the measured value displays (see page 120-123).

By-values

Using the 3 and 4 keys, you can select the by-values of a measured value display (see page 120-123).

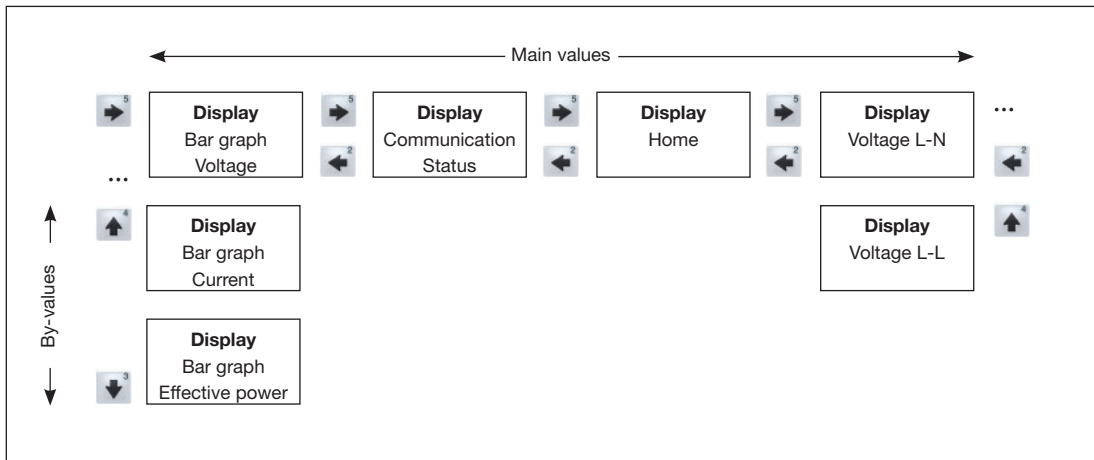

"Home" measured value display

After the power returns, the UMG 512 starts with the "Home" measured value display.

This measured value display contains the device names and an overview of important measured values. In its delivery condition, the unit name consists of the device type and the serial number of the device.

UMG512 - 51201480					
	Voltage	Current	Real Power	Reactive Pw.	PF
L1-N	221 V	0.05 A	0.01 kW	± 0.00 kvar	1.00
L2-N	221 V	0.05 A	0.01 kW	± 0.00 kvar	1.00
L3-N	221 V	0.05 A	0.01 kW	± 0.00 kvar	1.00
L4-N	221 V	0.05 A	0.02 kW	± 0.00 kvar	1.00
L1, L3	50.0 Hz	0.14 A	0.02 kW	± 0.00 kvar	1.00
Dig. Output			Dig. Input		
.		
config ◀ ▶					

home

ESC

Using the "Home - key 1", you navigate directly to the first "Home" measured value display from the measured value displays for the main values.

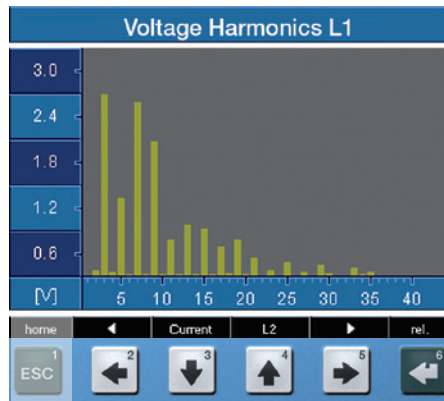

Selecting a measured value display

You would like to switch to a measured value display with main values.

- Using the 2 and 5 function keys, you can scroll between the measured value displays of the main values.
- Using the 1 (home) function key, you always navigate to the first measured value display.

You would like to switch to a measured value display with by-values.

- Select the measured value display with the main values.
- Using the 3 and 4 function keys, select the measured value display for the by-values.

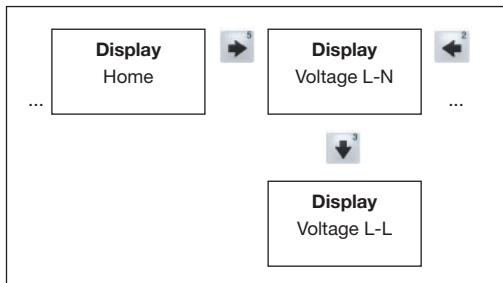

Example: Selecting the voltage by-values.

Voltage L-N			
	Value	Min Value	Max Value
L1-N	225.5 v	217.0 v	228.7 v
L2-N	225.5 v	217.1 v	233.9 v
L3-N	225.4 v	216.9 v	233.8 v
L4-N	225.4 v	216.9 v	233.8 v

home	←	L-L	→	select
ESC 1	← 2	↓ 3	↑ 4	→ 5
				← 6



Voltage L-L			
	Value	Min Value	Max Value
L1-L2	384.1 v	217.1 v	404.4 v
L2-L3	383.4 v	216.9 v	403.4 v
L3-L1	383.5 v	217.7 v	404.4 v
L4-N	0.4 v	0.2 v	1.6 v

home	←	L-N	→	select
------	---	-----	---	--------

View additional information

- Using the 2 and 5 keys, scroll to the desired measured value display.
- Activate the measured value selection using the 6 key (select).
- The background colours for the measured value switches from grey to green. The additional information is displayed in blue window.
- Using the 2 and 5 keys, select the desired measured value.
- End the procedure using the 1 key (ESC) or select another measured value with the 2 to 5 keys.

Voltage L-N			
	Value	Min Value	Max Value
L1-N	225,5 v	217,0 v	228,7 v
L2-N	225,5 v	217,1 v	233,9 v
L3-N	225,4 v	216,9 v	233,8 v
L4-N	225,4 v	216,9 v	233,8 v

home ← L-L → select

ESC 1 ← 2 ↓ 3 ↑ 4 → 5 ← 6

Voltage L-N			
	Value	Min Value	Max Value
L1-N	225,3 v	217,0 v	228,7 v
L2-N	THD 2,3 % Power Factor 1.00 Frequency 50.00 Hz	17,1 v	233,9 v
L3-N	225,2 v	216,9 v	233,8 v
L4-N	225,2 v	216,9 v	233,8 v

esc ← ↓ ↑ →

Deleting min./max. values individually

- Using the 2 and 5 keys, scroll to the desired measured value display.
- Activate the measured value selection using the 6 key (select).
- The background colours for the measured value switches from grey to green. The additional information is displayed in blue window.
- Using the 2 and 5 keys, select the desired minimum or maximum value.
- The time along with the date of the occurrence are displayed as additional information.
- Using the 6 key (reset), you can delete the selected minimum or maximum value.
- End the procedure using the 1 key (ESC) or select another minimum or maximum value with the 2 to 5 keys.

Voltage L-N			
	Value	Min Value	Max Value
L1-N	225.5 v	217.0 v	228.7 v
L2-N	225.5 v	217.1 v	233.9 v
L3-N	225.4 v	216.9 v	233.8 v
L4-N	225.4 v	216.9 v	233.8 v

home ← L-N → select

1 ESC 2 ← 3 ↓ 4 ↑ 5 → 6 ←

Voltage L-N			
	Value	Min Value	Max Value
L1-N	225.1 v	223.4 v	225.9 v
L2-N	225.1 v	217.1 v	233.9 v
L3-N	225.0 v	216.9 v	233.8 v
L4-N	225.0 v	216.9 v	233.8 v

06-04-2011 07:47:08

esc ← ↓ ↑ → reset ←



The date and time for the minimum/maximum values are specified displayed in UTC time (Coordinated Universal Time).

Transients list

The detected transients are listed in the transients list.

- The transients list consists of 2 pages.
- On page 1, the transients 1 through 8 are listed and on page 2, the transients 9 through 16 are listed.

Displaying transients

- Using the 2 and 5 keys, scroll to the "Transient" main value display.
- Select the desired page using the 4 key.
- Navigate to the transients list using key 6 (select) and select a transient using the 3 or 4 keys.
- Using the 6 key (select), have a transient displayed in a graph.
- Show or hide the legend using the 6 key (select).
- You can exit the transient graph display using the 1 key (ESC).

Transient voltages are fast impulse transient effects in electrical networks.

The time when transient voltages occur cannot be predicted and they have a limited duration.

Transient voltages are caused by lightning strikes, switching operations or by tripped fuses.

Transients (1..8)		
Phase	Reason	Date/Time
L1	delta	2011 Mar 16 15:32:07,122
L4	delta	2011 Mar 16 15:32:29,826
L3	delta	2011 Mar 16 15:32:29,819
L2	delta	2011 Mar 16 15:32:29,813
L2	delta	2011 Mar 16 15:32:29,806
L1	delta	2011 Mar 16 15:32:29,799
L4	delta	2011 Mar 16 15:32:29,793
L3	delta	2011 Mar 16 15:32:29,786

Navigation controls: ESC (1), Left (2), Down (3), Up (4), Right (5), Left (6)

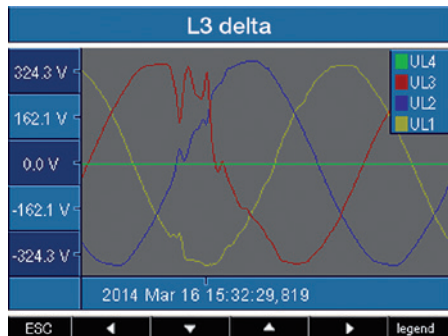

Event list

Detected events are listed in the event list.

- The event list consists of 2 pages.
- On page 1, the events 1 through 8 are listed and on page 2, the events 9 through 16 are listed.

Displaying events

- Using the 2 and 5 keys, scroll to the "Event" main value display.
- Select the desired page using the 4 key.
- Navigate to the event list using key 6 (select) and select an event using the 3 or 4 keys.
- Using the 6 key (select), have an event displayed in a graph.
- Show or hide the legend using the 6 key (select).
- You can exit the result graph display using the 1 key (ESC).

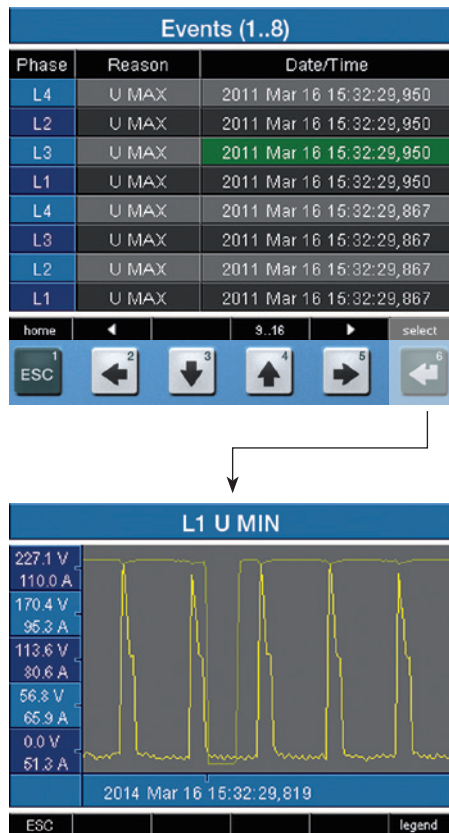

Events are threshold value violations of effective current and voltage values.

Configuration

The supply voltage must be connected for the configuration of the UMG 512.

Connecting the supply voltage

- The supply voltage level for the UMG 512 is specified on the rating plate.
- After applying the supply voltage, a start-up display appears. Approximately ten seconds later, the UMG 512 switches to the first "Home" measured value display.
- If no display appears, check whether the applied supply voltage is within the rated voltage range.

UMG512 - 51201480					
	Voltage	Current	Real Power	Reactive Pw.	PF
L1-N	221 V	0.05 A	0.01 kW	± 0.00 kvar	1.00
L2-N	221 V	0.05 A	0.01 kW	± 0.00 kvar	1.00
L3-N	221 V	0.05 A	0.01 kW	± 0.00 kvar	1.00
L4-N	221 V	0.05 A	0.02 kW	± 0.00 kvar	1.00
L1..L3	50.0 Hz	0.14 A	0.02 kW	± 0.00 kvar	1.00
	Dig. Output		Dig. Input		
	.		.		
config	◀			▶	

Fig. Example of the "Home" measured value display



Please note!

If the supply voltage does not correspond to the voltage indicated on the rating plate, this may lead to malfunctions and severe damage to the device.

Configuration menu

After the power returns, the device starts on the "Home" measured value display.

- Open the Configuration menu using the 1 button.

If you are in a measured value display for main values, you can navigate directly to the "Home" measured value display using the 1 button (home). Pressing the 1 key again opens the Configuration menu. Using the 3 or 4 keys, you select the desired submenu that can be activated using the 6 key (enter).

UMG512 - 51201480					
	Voltage	Current	Real Power	Reactive Pw.	PF
L1-N	221 V	0.05 A	0.01 kW	± 0.00 kvar	1.00
L2-N	221 V	0.05 A	0.01 kW	± 0.00 kvar	1.00
L3-N	221 V	0.05 A	0.01 kW	± 0.00 kvar	1.00
L4-N	221 V	0.05 A	0.02 kW	± 0.00 kvar	1.00
L1 L3	50.0 Hz	0.14 A	0.02 kW	± 0.00 kvar	1.00
Dig. Output			Dig. Input		
config					
ESC 1	← 2	↓ 3	↑ 4	→ 5	← 6

Main menu	
Language	English
Communication	->
Measurement	->
System	->
Display	->
Colors	->
Extensions	->
esc	enter

Language

You can set the language for the measured value displays and menus directly in the "Configuration" menu.

There are different languages available for selection. The factory default setting for the language is "English".

If the language field is marked green, then the desired language can be selected by pressing the key 6 (enter) and the keys 3 or 4. Pressing the key 6 (enter) again confirms the selection and changes the language.

Communication

The UMG 512 has an Ethernet and a RS485 interface.

Ethernet (TCP/IP)

Select the type of the address assignment for the Ethernet interface here.

DHCP mode

- **Off** - The IP address, netmask and gateway are defined by the user and set directly on the UMG 512. Select this mode for straightforward networks without DHCP servers.
- **BOOTP** - BootP enables the fully automatic integration of a UMG 512 into an existing network. However, BootP is an older protocol and does not provide the scope of functions provided by DHCP.
- **DHCP** - When started, the UMG 512 automatically obtains the IP address, the network mask and the gateway from a DHCP server.

Factory default setting: **DHCP**



Connection of the UMG 512 to the Ethernet may only be carried out after consulting the network administrator!

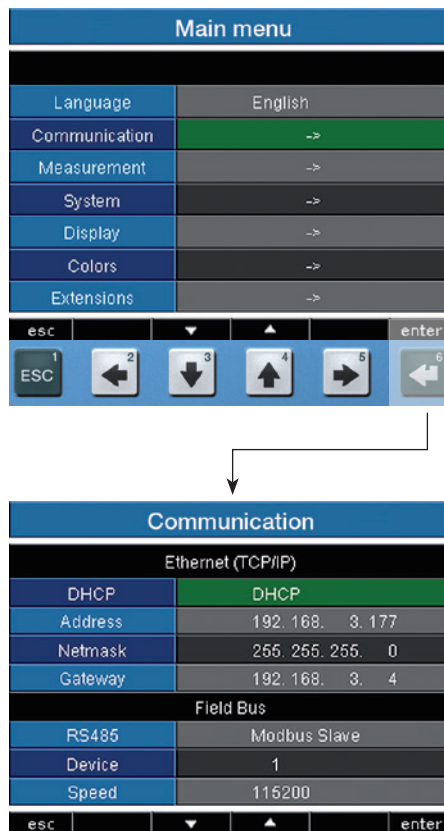

RS485

You can specify the protocol, device address and baud rate for operation with the RS485 interface. The device address must be uniquely assigned within the bus structure; the baud rate specification must be selected uniformly.

The corresponding field can be selected via the keys 3 or 4 (green marking). Key 6 (enter) provides you with access the selection options, which can then be selected with key 3 or 4. Pressing the 6 key (enter) again confirms the selection.

Protocol

Selection options:

- Modbus slave
- Modbus master/gateway (default setting)
- Profibus DP V0 (option)

Device address

Setting range: 0 - 255
 Factory default setting: 1

Baud rate

Setting range: 9600, 19200, 38400, 57600,
 115200 (default setting),
 921600 kbps

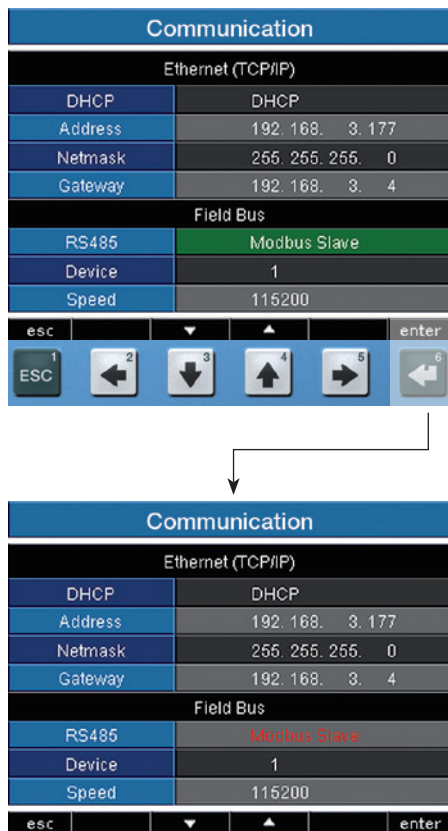

Measurement

Measurement	
Transformer	->
Transients	->
Events	->
Voltage mode	L-N
Rated Freq.	50 Hz (fixed frequency)
Flicker	230V/50Hz
Temperature	PT100
esc	
	▼ ▲
	enter

Configure the following here:

- The measuring transducer for the current and voltage measurement
- Recording transients
- Recording events
- The relevant voltage
- The mains frequency
- The flicker settings

The UMG 512 has 4 measurement channels used to measure the current (I1..I4) and 4 measurement channels used to measure the voltage (V1..V4 against Vref).

Measured voltage and measured current for the measurement channels 1-4 must derive from the same network.

Baseline measurement

The baseline measurement uses the measurement channels 1-3. Use the measurement channels 1-3 in three-phase systems.

Supporting measurement

The supporting measurement only uses measurement channel 4. Use measurement channel 4 when measuring in single-phase systems or in three-phase systems with symmetrical loads.

The frequency setting and the setting for the relevant voltage are pulled automatically from the baseline measurement settings.

Measuring transducer

Current transformer

You can assign current transformer ratios to the baseline measurement and the supporting measurement.
Select the 5/5A setting when measuring currents directly.

Setting range:

Primary	1 to 1000000
Secondary	1 to 5

Factory default setting:

Primary	5
Secondary	5

Rated current

The rated current defines the value to which

- Overcurrent
- Current transients
- K-factor and the
- Automatic scaling of graphics refer.

Setting range: 0 to 1000000A

Transformer MAIN		
	primary	secondary
Current Transf.	5A	5A
Voltage Transf.	400V	400V
Rated Current	5A	
Rated Voltage	230V	
Apply to AUX	No	
Connection	4w3m	
esc ▼ ▲ enter		

Transformer MAIN		
	primary	secondary
Current Transf.	5A	5A
Voltage Transf.	400V	400V
Rated Current	5A	
Rated Voltage	230V	
Apply to AUX	No	
Connection	4w3m	
esc ▼ ▲ enter		

Residual current transformer

When using residual current inputs I5 and I6, the corresponding transformer ratios of the used residual current transformer must be set.

Setting range:

Primary 1 to 1000000
 Secondary 1

Factory default setting:

Primary 127
 Secondary 1

Residual current transformer			
	primary	secondary	
Current Transf. I5	600	1	
Monitoring I5	active		
Current Transf. I6	127	1	
Monitoring I6	inactive		
esc	▼	▲	enter

Monitoring

Activates or deactivates the failure monitoring of the corresponding residual current inputs.

- **Activated** - Switches on the failure monitoring for residual current monitoring.
- **Deactivated** - Switches off the failure monitoring for residual current monitoring.

Residual current transformer			
	primary	secondary	
Current Transf. I5	600	1	
Monitoring I5	active		
Current Transf. I6	127	1	
Monitoring I6	inactive		
esc	▼	▲	enter

Voltage transformer

You can assign voltage transformer ratios to the baseline measurement and the supporting measurement. Select the 400/400V setting when measuring without a voltage transformer.

Setting range:

Primary	1 to 1000000
Secondary	1 to 999

Factory default setting:

Primary	400
Secondary	400

Rated voltage

The rated voltage corresponding to the "arranged input voltage U_{din} " according to EN 61000-4-30. The rated voltage defines the value to which

- Upward deviation (EN 61000-4-30),
- Downward deviation (EN 61000-4-30),
- Transients,
- Events and the
- Automatic scaling of graphics refer.

Setting range: 0 to 1000000V

Factory default setting: 230V

Transformer MAIN		
	primary	secondary
Current Transf.	5A	5A
Voltage Transf.	400V	400V
Rated Current	5A	
Rated Voltage	230V	
Apply to AUX	No	
Connection	4w3m	
esc ▾ ▲ enter		

Transformer MAIN		
	primary	secondary
Current Transf.	5A	5A
Voltage Transf.	400V	400V
Rated Current	5A	
Rated Voltage	230V	
Apply to AUX	No	
Connection	4w3m	
esc ▾ ▲ enter		

Accepting AUX / MAIN

The measuring transducer can be configured for the baseline measurement and supporting measurement. You can accept the measuring transducer settings in each case from the supporting or baseline measurement.

- **No** - The settings from the supporting and baseline measurement are not accepted.
- **Yes** - The settings from the supporting measurement and baseline measurement are accepted.

Connection

You can select between different connection schemes (see page 22) for the voltage and current measurement using the "Connection" selection.

Factory default setting: 4w3m

Transformer MAIN		
	primary	secondary
Current Transf.	5A	5A
Voltage Transf.	400V	400V
Rated Current	5A	
Rated Voltage	230V	
Apply to AUX	No	
Connection	4w3m	

esc ▾ ▲ enter

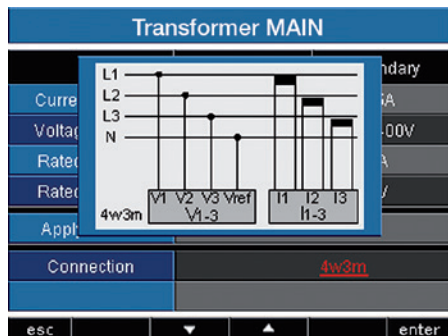

Fig. Example for the measurement in a three-phase 4-conductor network with asymmetric loading

Transients

Transient voltages are fast impulse transient effects in electrical networks. The time when transient voltages occur cannot be predicted and they have a limited duration.

Transient voltages are caused by lightning strikes, switching operations or by tripped fuses.

- The UMG 512 detects transients that are longer than 39 μ s.
- The UMG 512 monitors the measurement inputs for transients.
- There are two independent criteria by which transients are detected.
- If a transient has been detected, the wave form will be saved to a transient record.
- If a transient has been detected, the threshold value increases by 20V, both in automatic and in manual mode. This automatic increase of the threshold value switches off within 10 minutes.
- If a further transient is detected within the next 60 seconds, it will be recorded with 512 points.
- The GridVis event browser can display recorded transients.

Measurement	
Transformer	->
Transients	->
Events	->
Voltage mode	L-N
Rated Freq.	50 Hz (fixed frequency)
Flicker	230V/50Hz
Temperature	PT100
esc	▼
▲	enter

Mode (absolute)

If a sampled value exceeds the set threshold value, a transient is detected.

- **Off** - Transient monitoring has been switched off.
- **Automatic** - Factory default setting. The threshold value is calculated automatically and is 110% of the current 200ms effective value.
- **Manual** - The transient monitoring uses the configurable threshold values under "Peak".

Mode (delta)

If the difference between two neighbouring sampled points exceeds the set threshold value, a transient is detected.

- **Off** - Transient monitoring has been switched off.
- **Automatic** - Factory default setting. The threshold value is calculated automatically and is 0.2175 times the current 200ms effective value.
- **Manual** - The transient monitoring uses the configurable threshold values under "Trns U".

Mode (envelop)

If a sampled value exceeds the envelope range, a transient is detected.

- **Off** - Transient monitoring has been switched off.
- **Automatic** - Factory default setting. The envelop is automatically calculated and is $\pm 5\%$ of the rated voltage.
- **Manual** - The transient monitoring uses the configurable envelop.

Accepting AUX / MAIN

The transient monitoring can be configured for the baseline measurement and supporting measurement. You can accept the settings from the supporting or baseline measurement.

- **No** - The settings from the supporting and baseline measurement are not accepted.
- **Yes** - The settings from the supporting measurement and baseline measurement are accepted.

Allocations MAIN	
Transients	
Mode (abs)	automatically
Peak U	0% (0.0V)
Mode (delta)	automatically
Trns U	0% (0.0V)
Modus (abs I)	automatically
Peak I	0% (0.0A)
Modus (envelop)	automatically
Envelop U	0% (0.0V)
Apply to AUX	No
esc	▼
▲	enter

Events

Events are threshold value violations of set threshold values for current and voltage.

Here, threshold values are compared with the half wave effective values for current and voltage from the measurement channels. The event record consists of a mean value, a minimum or maximum value, a start time and an end time.

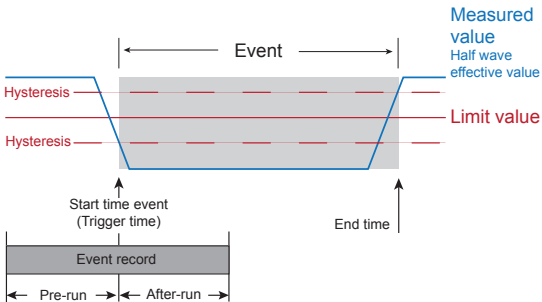

- An event describes a fault due to undervoltages/ overvoltages, voltage loss, overcurrent, overfrequency/ underfrequency and rapid frequency changes
- Monitoring of the threshold values can be switched off (Off/Manual).
- Threshold values and hysteresis must be set as a percentage of the nominal value.
- Threshold values can be set for excess voltage, undervoltage, voltage interruption and overcurrent.
- If an event has occurred, the corresponding measured value is recorded with the set pre-run and after-run periods (respectively 0..1000 half waves).
- Event records are configured with the GridVis and displayed with the event browser.

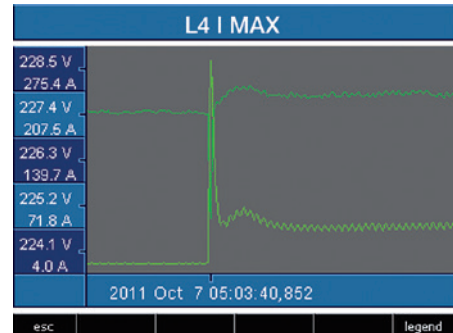

Fig. Shows the half wave effective values for an event.

Voltage

Drop

A voltage drop is set in % of the rated voltage.

Voltage swell

The voltage swell is set in % of the rated voltage.

Current

Overcurrent

The rapid increase of current is set in % of the nominal current.

Accepting AUX / MAIN

The event monitoring can be configured for the baseline measurement and supporting measurement. You can accept the settings from the supporting or baseline measurement.

- **No** - The settings from the supporting and baseline measurement are not accepted.
- **Yes** - The settings from the supporting measurement and baseline measurement are accepted.

Allocations MAIN		
Voltage		
Sag	90%	(292.7V)
Swell	110%	(357.8V)
Current		
Inrush	110%	(7.8A)
Apply to AUX	No	
esc	▼	▲
		enter



Lead time

You can only set the lead time with GridVis.
Factory default setting: 0



After-run

You can only set the after-run with GridVis.
Factory default setting: 0

Relevant voltage

Depending on the application, the voltage between the outer conductors (L) or the voltage between the outer conductor (L) and the neutral conductor (N) is relevant for analysing the power quality.

We recommend the "L-N" setting for measuring the power quality in low voltage networks. You should select the "L-L" setting in medium voltage networks.

Measurement	
Transformer	->
Transients	->
Events	->
Voltage mode	L-N
Rated Freq.	50 Hz (fixed frequency)
Flicker	230V/50Hz
Temperature	PT100
esc	▼
▲	enter



Flicker values can only be determined if the relevant voltage L-N is given.

Nominal frequency

The UMG 512 determines the mains frequency from the voltage applied to L1 and uses this for the additional calculations.

The nominal frequency is required as a reference for measurement of the voltage quality.

Configure the nominal frequency for the mains on the UMG 512 prior to starting the measurement.

Select the mains frequency 50Hz or 60Hz for measuring the power quality in accordance with EN61000-4-30 and EN50160.

Setting range of the nominal frequency:

- 50Hz (factory default setting)
- 60Hz
- 15Hz to 440Hz (wide range)

Set the nominal frequency to "Wide range" for measurements in networks with other nominal frequencies e.g. 16 2/3Hz or 400Hz.

Measurement			
Transformer	->		
Transients	->		
Events	->		
Voltage mode	L-N		
Rated Freq.	50 Hz (fixed frequency)		
Flicker	230V/50Hz		
Temperature	PT100		
esc	▼	▲	enter



In order to determine the mains frequency, a voltage L1-N of greater than 10V_{eff} must be applied to voltage measurement input V1.

Flicker

The UMG 512 requires the mains base values in order to provide voltage and frequency-independent measurement and calculation of the flicker values (flicker measurement as per DIN EN61000-4-15:2011). These values are to be specified by the user and can be selected from a predefined list:

- 230V/50Hz (factory default setting)
- 120V/50Hz
- 230V/60Hz
- 120V/60Hz



Flicker values can only be determined if the relevant voltage L-N is given.

Measurement	
Transformer	->
Transients	->
Events	->
Voltage mode	L-N
Rated Freq.	50 Hz (fixed frequency)
Flicker	230V/50Hz
Temperature	PT100
esc	▼ ▲ enter

Temperature

When using a temperature measurement, the corresponding sensor type must be selected from a predefined list.

- PT100
- PT1000
- KTY83
- KTY84

Measurement	
Transformer	->
Transients	->
Events	->
Voltage mode	L-N
Rated Freq.	50 Hz (fixed frequency)
Flicker	230V/50Hz
Temperature	PT100
esc	▼ ▲ enter

System

Display of the device-specific system settings with:

System	
Version	2.052
Serial	51104018
MAC	00:0E:6B:03:22:8C
Address	192.168. 3. 177
Gateway	192.168. 3. 4
Date/Time	01.01.1970 01:37:06
Password	0
Re-initialization	->
esc ▼ ▲ enter	

Firmware version
 Serial number of the device
 Fixed MAC address of the device
 Set IP address
 Set gateway address
 Date and time
 Set password
 Reset settings



You cannot configure the date and time directly on the device. You can carry out the settings for the time synchronisation and date and time with the GridVis.

Password

The user can block access to the configuration with a password. The configuration can then only be changed directly on the device by entering the password.

The password consists of a 6-digit code.

Setting range: 1-999999 = With password
 000000 = Without password

Password (000000) is not factory-programmed.

- To change a password that has already been set, you must know the current password.
- Note down the changed password.
- When selecting the "Password" (green marking), the password can be changed using the 6 key (enter) and keys 2 to 5. Pressing the 6 key again confirms the entry.
- If you no longer want a password prompt, enter the password "000000".



System	
Version	2.052
Serial	51104018
MAC	00:0E:6B:03:22:8C
Address	192.168. 3. 177
Gateway	192.168. 3. 4
Date/Time	01.01.1970 01:37:06
Password	0
Re-initialization	->
esc	▼
▲	enter

Forgot my password

If you no longer remember your password, you can only delete it using the "GridVis" PC software.

In order to do so, connect the UMG 512 to the PC with a suitable interface. More information can be found in the GridVis assistant.

Resetting

Clearing energy meters

You can clear all energy meters in the UMG 512 at the same time using the "Reset" key.

Some specific energy meters cannot be selected.

- Highlight the "Clear energy" button (green marking) and enable the deletion process using the key 6 (enter).

Re-initialization	
Reset energy	No
Clear min/max	No
Delivery status	No
Reset	No
esc	▼
	▲
	enter

- Select "Yes" with the 4 key.
- Confirm the selection using the 6 key.
- The "Carried out" message appears in the line, all energy meters have been cleared.

Re-initialization	
Reset energy	Yes
Clear min/max	No
Delivery status	No
Reset	No
esc	▼
	▲
	enter

Deleting min. and max. values

You can delete all min. and max. values in the UMG 512 at the same time using the "Reset" key.

The "Deleting minimum/maximum values individually" section describes how you can individually delete min. and max. values.

- Highlight the "Min/max values" item (green marking) and enable the clear process using the key 6 (enter).
- Select "Yes" with the 4 key.
- Confirm the selection using the 6 key.
- The "Carried out" message appears in the line, all minimum and maximum values have been cleared.



Prior to commissioning potential production dependant contents of the energy counter, min/max values and records have to be deleted.

Re-initialization			
Reset energy	No		
Clear min/max	No		
Delivery status	No		
Reset	No		
esc	▼	▲	enter

Re-initialization			
Reset energy	No		
Clear min/max	No		
Delivery status	No		
Reset	No		
esc	▼	▲	enter

Delivery status

All settings, such as the configuration and the recorded data, are restored to the factory default settings or deleted. Entered activation codes are not deleted.

- Select "Yes" with the 4 key.
- Confirm using the 6 key.
- The "Carried out" message appears in the line, the delivery status is restored.

Re-initialization			
Reset energy	No		
Clear min/max	No		
Delivery status	No		
Reset	No		
esc	▼	▲	enter

Re-initialisation

The UMG 512 is started again.

- Select "Yes" with the 4 key.
- Confirm using the 6 key.
- The device starts again within approx. 10 seconds

Re-initialization			
Reset energy	No		
Clear min/max	No		
Delivery status	No		
Reset	No		
esc	▼	▲	enter

Display

Brightness

The backlight brightness can be configured. The brightness set here is used when the UMG 512 is operated.

Setting range: 0 to 100%
 Factory default setting: 70%
 (0% = dark, 100% = very bright)

Standby

Time after which the brightness switches to the "Standby brightness".

Setting range: 60 to 9999 sec.
 Factory default setting: 900 sec.

Standby brightness

Brightness level the system switches to after the standby time expires. The standby time is restarted by using keys 1-6.

Setting range: 0 to 60%
 Factory default setting: 40%

Screen Saver

The screen saver prevents a screen image that is not changed for a longer time period from "burning into" the LCD.

Setting range: Yes, No
 Factory default setting: Yes

Display	
Brightness	70%
Standby	900s
Brightness(standby)	40%
Screen Saver	Yes
Screen Update	fast
Rotate	No
Rotation Interval	0s
esc	▼
▲	enter

Screen Update

Here, you can define the speed at which the new measured values appear in the measured value displays.

Setting range: fast (200ms), slow (1 sec.)

Factory default setting: Fast

Rotate

The measured value displays are automatically shown one after the other. This does not affect the displays of the configuration.

Setting range: Yes, No

Factory default setting: No

Rotation interval

Here, you can set the time after which the screen automatically switches to the next measured value display.

Setting range: 0 to 255 seconds

Factory default setting: 0 seconds





The service life of the backlight is extended if the brightness of the backlight is lower.

Colours

Selection of the colours for displaying the current and voltage in the graphic representations.

- Using the keys 3 or 4, select the desired coloured field.
- Confirm the selection using the 6 key.
- Using the keys 3 or 4, select the desired colour.
- Confirm the selection using the 6 key.

Main menu	
Language	English
Communication	→
Measurement	→
System	→
Display	→
Colors	→
Extensions	→
esc	▼ ▲ enter

Colors		
	Voltage	Current
L1		
L2		
L3		
L4		
esc	▼ ▲ enter	

Extensions

Under "Extensions", you can subsequently activate functions that are subject to purchase (activation) and display the status of the Jasic programs (Jasic status).

Activation

The UMG 512 contains functions that are subject to purchase and can be subsequently activated.

List of the functions that can be activated:

- BACnet

You receive the activation codes from the manufacturer. The manufacturer requires the serial number of the device and the name of the function to be activated.

To activate the function, enter the 6-digit activation code in the corresponding line.

Make sure that the activation code is only valid for one device.

Main menu	
Language	English
Communication	->
Measurement	->
System	->
Display	->
Colors	->
Extensions	->
esc	▼ ▲ enter

Extensions	
Activation	->
Jasic-state	->
esc	▼ ▲ enter

Jasic status

Up to 7 customer-specific Jasic programs (1-7) and a recording can run in the UMG 512.

The Jasic programs can have the following statuses:

- Stopped
- Running

You cannot change the status of the Jasic programs on the device.

Extensions	
Activation	->
Jasic-state	->
esc	▼
	▲
	enter

Extensions	
Jasic-state	
Jasic-state 1	stopped
Jasic-state 2	stopped
Jasic-state 3	stopped
Jasic-state 4	stopped
Jasic-state 5	stopped
Jasic-state 6	stopped
Jasic-state 7	stopped
Records	running
esc	

Commissioning the unit

Connecting the supply voltage

- The supply voltage level for the UMG 512 is specified on the rating plate.
- After connecting the supply voltage, a display appears. Approximately 15 seconds later, the UMG 512 switches to the first measured value display.
- If no display appears, check whether the power supply voltage is within the rated voltage range.



Please note!

If the supply voltage does not correspond to the voltage indicated on the rating plate, this may lead to malfunctions and severe damage to the device.



Please note!

The UMG 512 is only suitable for use in networks where overvoltages of overvoltage category 600V CATIII can occur.

Connecting the measured voltage

- Measurement of voltages in networks with over 500VAC to earth must be connected via voltage transformers.
- After connecting the measured voltages, the measured values displayed by the UMG 512 for the L-N and L-L voltages must correspond to those at the voltage measurement input.
- If a voltage transformer factor is programmed, it must be taken into consideration for the comparison.



Prior to commissioning potential production dependant contents of the energy counter, min/max values and records have to be deleted.



Please note!

The UMG 512 is not suitable for measuring DC voltages.

Frequency measurement

The UMG 512 requires the mains frequency for the measurement. The mains frequency can be defined by the user or automatically determined by the device.

- For the UMG 512 to automatically determine the frequency, a voltage L1-N of greater than 10Veff must be applied to voltage measurement input V1.
- The mains frequency must be in the range from 15Hz to 440Hz.
- If there is no sufficiently high measured voltage available, the UMG 512 cannot determine the mains frequency and thus cannot perform any measurements.

Direction of the rotating field

Check the direction of the rotating field voltage in the measured value display of the UMG 512.

A “right” rotation field usually exists.

UL1-UL2-UL3 = right rotation field
 UL1-UL3-UL2 = left rotation field

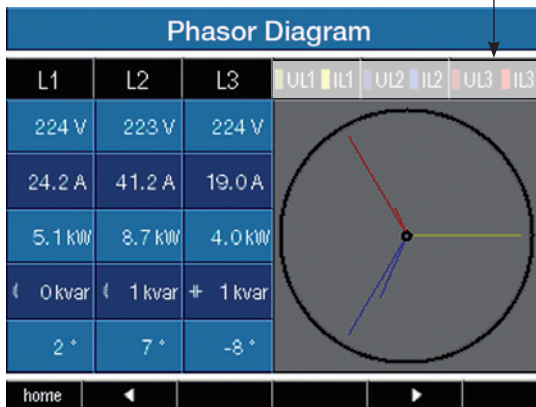

Presentation of the phase sequence according to the direction of the rotating field.

Applying the measuring-circuit voltage

The UMG 512 is designed for the connection of .. /1A and .. /5A current transformers.

Only AC currents can be measured via the current measurement inputs - DC currents cannot.

Short circuit all current transformer outputs except for one. Compare the currents displayed by the UMG 512 with the applied current.

Bearing in mind the current transformer conversion ratio, the current displayed by the UMG 512 must correspond with the input current.

The UMG 512 must display approx. zero amperes in the short circuited current measurement inputs.

The current transformer ratio is factory-set to 5/5A and must be adapted to the current transformer used if necessary.

Phase shift angle sign prefix (U/I):

- Positive (+) for capacitive load
- Negative (-) for inductive load



Please note!

Voltages and currents that are outside the permissible measuring range can damage the device.

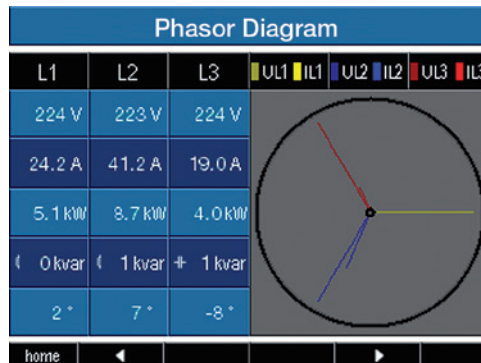

In the Phasor diagram, the voltages are displayed with long pointers and the currents with short pointers.

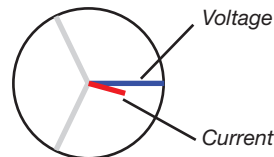

Phasor diagram, example 1

Predominantly ohmic load.

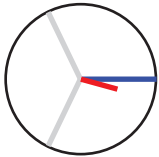

Voltage and current only have a minor deviation in the phase length.

- The current measurement input is assigned to the correct voltage measurement input.

Phasor diagram, example 2

Predominantly ohmic load.

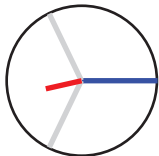

Voltage and current have a deviation of about 180° in the phase position.

- The current measurement input is assigned to the correct voltage measurement input.
- In the current measurement considered here, the **k and l connections are reversed** or there is a return feed in the mains power supply.

Applying the residual current

Connect residual current transformer only to the I5 and I6 inputs with a rated current of 30mA! Both residual current inputs can measure AC currents, pulsing direct currents and DC currents.

Bearing in mind the current transformer ratio, the residual current displayed by the UMG 512 must correspond with the input current.

The current transformer ratio is factory-set to 5/5A and must be adapted to the residual current transformer used if necessary.

Failure monitoring (RCM) for I5, I6

The UMG 512 enables continuous monitoring of the connection to the residual current transformer on inputs I5 and I6.

Activation of failure monitoring is performed using the corresponding menu item or by setting address 13793 for the residual-current measurement input I5 and 13795 for I6.

If there is an interruption in the connection to the current transformer, this state is recorded in certain registers or indicated in the GridVis software.



The UMG 512 requires the mains frequency for residual current monitoring. For this purpose, the measured voltage should be applied or a fixed frequency should be set.



It is not necessary to configure a connection schematic for residual current inputs I5 and I6.

Modbus addr.	Value / Function
13793 (I5)	Failure monitoring for I5 / I6 0 = Deactivate monitoring 1 = Activate monitoring
13795 (I6)	

Modbus addr.	Value / Function
13805 (I5)	0 = Connection to the residual current transformer on to I5 or I6 error-free 1 = Error in the current transformer connection to I5 or I6
13806 (I6)	

Alarm status for I5, I6

Using bit-by-bit coding inside the alarm register (addr. 13921 for I5, 13922 for I6), it is possible to read out different alarm statuses:

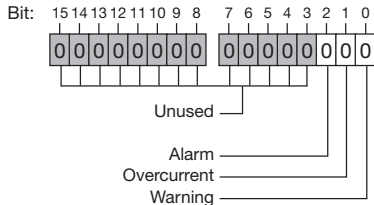

Warning:	The residual current has exceeded the set warning limit value
Overcurrent:	The measurement range has been exceeded
Alarm:	Alarm bit is set for: warning, overcurrent or connection error to the transformer. The alarm bit must be reset or acknowledged manually.

Example:

The measurement range has been exceeded. The alarm bit is also set and must be acknowledged!

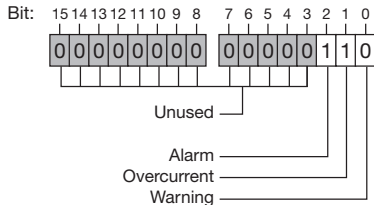

Checking the power measurement

Short-circuit all current transformer outputs except for one and check the displayed power outputs.

The UMG 512 may only display one power output in the phase with a non-short-circuited current transformer input. If this is not the case, check the connection of the measured voltage and the measuring-circuit current.

If the effective power amount is correct but the sign of the power output is negative,

- S1(k) and S2(l) could be inverted at the current transformer
- or they supply effective power back into the network.

Checking the communication

The UMG 512 counts all received (RX), all transmitted (TX) and all faulty data packages.

Ideally, the number of the error displayed in the Error column is zero.

Reset:

You can reset the meters for the data package with the 6 key.

The start time for the new counting process is reset.

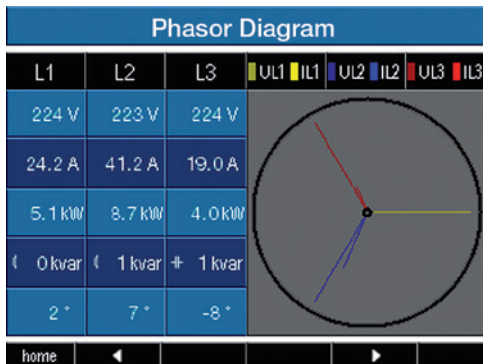

In the Phasor diagram, the voltages are displayed with long pointers and the currents with short pointers.

Communication State

	RX	TX	Error
Ethernet	625363	5728	4
RS485	0 n	0 n	0 n
NTP	0	0	0
DHCP	642	956	0
DNS	0	0	0
E-Mail	-	0	0
Start Time	07-04-2014 15:19:48		

home ◀ ▶ ▶▶ reset

Measurement range exceeded (overload)

If the measurement range is exceeded, it is displayed as long as this persists and cannot be acknowledged. The measurement range is exceeded if at least one of the four voltage or current measurement inputs lies outside their specified measuring range.

Threshold values for exceeding the measurement range (200 ms effective values):

I	=	7 A _{rms}
U _{L-N}	=	600 V _{rms}

Error - Overload		
	Voltage	Current
L1	225.5 V	0.0 A
L2	EEEE	0.0 A
L3	225.4 V	0.0 A
L4	0.5 V	EEEE

Indication of values exceeding the measurement range in voltage circuit L2 and in current path I4

RS485 interface

The MODBUS RTU protocol with CRC check on the RS485 interface can be used to access the data from the parameter and the measured value lists (see RS485 configuration).

Modbus functions (master)

- 01 Read coil status
- 02 Read input status
- 03 Read holding registers
- 04 Read input registers
- 05 Force single coil
- 06 Preset single register
- 15 (0F Hex) Force multiple coils
- 16 (10Hex) Preset multiple registers
- 23 (17Hex) Read/write 4X registers

Modbus functions (slave)

- 03 Read holding registers
- 04 Read input registers
- 06 Preset single register
- 16 (10Hex) Preset multiple registers
- 23 (17Hex) Read/write 4X registers

The sequence of bytes is high before low byte (Motorola format).

Transmission parameters:

Data bits:	8
Parity:	None
Stop bits (UMG 512):	2
External stop bits:	1 or 2

Number format:	short	16 bit (-2^{15} to $2^{15} - 1$)
	float	32 bit (IEEE 754)



Broadcast (address 0) is not supported by the device.



The message length must not exceed 256 bytes.

Example: Reading the L1-N voltage

The L1-N voltage is saved in the measured value list at address 19000. The L1-N voltage is available in the FLOAT format.

Address = 01 is approved as the UMG 512 device address.

The Query Message appears as follows:

Name	Hex	Note
Device address	01	UMG 512, address = 1
Function	03	„Read Holding Reg.“
Start Addr. Hi	4A	19000dez = 4A38hex
Start Addr. Lo	38	
Ind. Value Hi	00	2dez = 0002hex
Ind. Value Lo	02	
Error Check	-	

The "Response" of the UMG 512 can appear as follows:

Name	Hex	Note
Device address	01	UMG 512, address = 1
Function	03	
Byte meter	06	
Data	00	00hex = 00dez
Data	E6	E6hex = 230dez
Error Check (CRC)	-	

The L1-N voltage read by address 19000 is 230V.

Profibus

Profibus profiles

A Profibus profile contains the data to be exchanged between a UMG and a PLC. Four Profibus profiles are preconfigured at the factory.

A Profibus profile can:

- Retrieve measured values from the UMG,
- Set the digital outputs in the UMG,
- Query the status of the digital inputs in the UMG.

Each Profibus profile can hold a maximum of 127 bytes of data. If more data has to be transferred, simply create additional Profibus profiles.

- Every Profibus profile has a profile number. The profile number is sent by the PLC to the UMG.
- Using GridVis, 16 Profibus profiles (profile numbers 0..15) can be edited.
- Additional Profibus profiles (profile numbers 16..255) can be created using Jasic programs.
- Factory pre-configured Profibus profiles cannot be subsequently changed.

Device master file

The device master file, abbreviated as GSD file, describes the Profibus characteristics of the UMG 512. The GSD file is required by the configuration program of the PLC.

The device master file for the UMG 512 has the file name "JAN0EDC.GSD" and is included on the data carrier as part of the scope of the delivery.

Variable definition

All system variables and global variables¹⁾ can be individually scaled and converted into one of the following formats:

- 8, 16, 32 bit integer with and without sign prefix.
- 32 or 64 bit float format.
- Big or little endian.
- *Big endian* = High byte before low byte.
- *Little endian* = Low byte before high byte.

¹⁾ Global variables are variables that are defined by the user in Jasic and are available to each interface in the UMG 512.

Example

Using Profibus to retrieve measured values

At least one Profibus profile must be set up with GridVis software and transferred to the UMG 512.
 A Jasic program is not required.

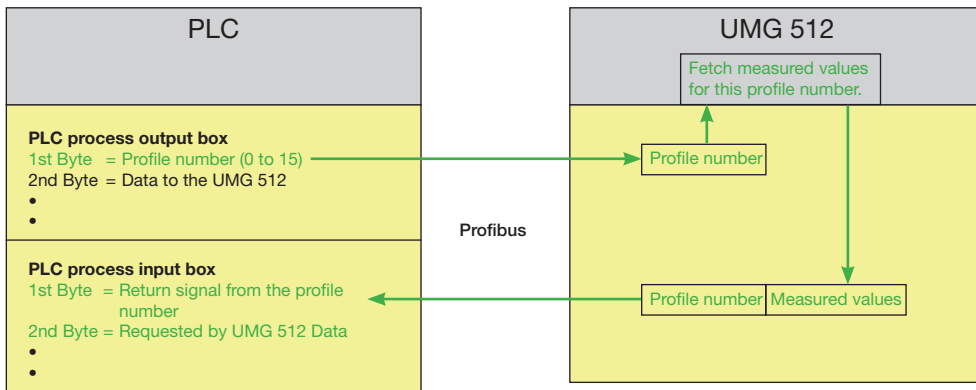

Fig. Block diagram for data exchange between PLC and UMG 512.

Factory pre-configured profiles

Profibus profile number 0

Byte index	Value type	Value format	Scaling
1	1	Voltage L1-N	Float 1
2	5	Voltage L2-N	Float 1
3	9	Voltage L3-N	Float 1
4	13	Voltage L4-N	Float 1
5	17	Voltage L2-L1	Float 1
6	21	Voltage L3-L2	Float 1
7	25	Voltage L1-L3	Float 1
8	29	Current L1	Float 1
9	33	Current L2	Float 1
10	37	Current L3	Float 1
11	41	Current L4	Float 1
12	45	Effective power L1	Float 1
13	49	Effective power L2	Float 1
14	53	Effective power L3	Float 1
15	57	Effective power L4	Float 1
16	61	Cos phi (math.) L1	Float 1
17	65	Cos phi (math.) L2	Float 1
18	69	Cos phi (math.) L3	Float 1
19	73	Cos phi (math.) L4	Float 1
20	77	Frequency	Float 1
21	81	Effective power sum L1-L4	Float 1
22	85	Reactive power sum L1-L4	Float 1
23	89	Apparent power sum L1-L4	Float 1
24	93	Cos phi (math.) sum L1-L4	Float 1
25	97	Effective current sum L1-L4	Float 1
26	101	Active energy sum L1-L4	Float 1
27	105	Ind. Reactive energy sum L1-L4	Float 1
28	109	THD voltage L1	Float 1
29	113	THD voltage L2	Float 1
30	117	THD voltage L3	Float 1

Profibus profile number 1

Byte index	Value type	Value format	Scaling
1	1	Voltage L1-N	Float 1
2	5	Voltage L2-N	Float 1
3	9	Voltage L3-N	Float 1
4	13	Voltage L2-L1	Float 1
5	17	Voltage L3-L2	Float 1
6	21	Voltage L1-L3	Float 1
7	25	Current L1	Float 1
8	29	Current L2	Float 1
9	33	Current L3	Float 1
10	37	Effective power L1	Float 1
11	41	Effective power L2	Float 1
12	45	Effective power L3	Float 1
13	49	Cos phi (math.) L1	Float 1
14	53	Cos phi (math.) L2	Float 1
15	57	Cos phi (math.) L3	Float 1
16	61	Frequency	Float 1
17	65	Effective power sum L1-L3	Float 1
18	69	Reactive power sum L1-L3	Float 1
19	73	Apparent power sum L1-L3	Float 1
20	77	Cos phi (math.) sum L1-L3	Float 1
21	81	Effective current sum L1-L3	Float 1
22	85	Active energy sum L1-L3	Float 1
23	89	Ind. Reactive energy sum L1-L3	Float 1
24	93	THD voltage L1	Float 1
25	97	THD voltage L2	Float 1
26	101	THD voltage L3	Float 1
27	105	THD current L1	Float 1
28	109	THD current L2	Float 1
29	113	THD current L3	Float 1

Profibus profile number 2

Byte index	Value type	Value format	Scaling
1	1	Active energy sum L1-L3	Float 1
2	5	Rel. Active energy sum L1-L3	Float 1
3	9	Deliv. Active energy sum L1-L3	Float 1
4	13	Reactive energy sum L1-L3	Float 1
5	17	Ind. Reactive energy sum L1-L3	Float 1
6	21	Cap. reactive energy sum L1-L3	Float 1
7	25	Apparent energy sum L1-L3	Float 1
8	29	Active energy L1	Float 1
9	33	Active energy L2	Float 1
10	37	Active energy L3	Float 1
11	41	Inductive reactive energy L1	Float 1
12	45	Inductive reactive energy L2	Float 1
13	49	Inductive reactive energy L3	Float 1

Profibus profile number 3

Byte index	Value type	Value format	Scaling
1	1	Effective power L1	Float 1
2	5	Effective power L2	Float 1
3	9	Effective power L3	Float 1
4	13	Effective power sum L1-L3	Float 1
5	17	Current L1	Float 1
6	21	Current L2	Float 1
7	25	Current L3	Float 1
8	29	Current sum L1-L3	Float 1
9	33	Active energy sum L1-L3	Float 1
10	37	Cos phi (math.) L1	Float 1
11	41	Cos phi (math.) L2	Float 1
12	45	Cos phi (math.) L3	Float 1
13	49	Cos phi (math.) sum L1-L3	Float 1
14	53	Reactive power L1	Float 1
15	57	Reactive power L2	Float 1
16	61	Reactive power L3	Float 1
17	65	Reactive power sum L1-L3	Float 1
18	69	Apparent power L1	Float 1
19	73	Apparent power L2	Float 1
20	77	Apparent power L3	Float 1
21	81	Apparent power sum L1-L3	Float 1

Digital in-/outputs

The UMG 512 has two digital outputs and two digital inputs. The inputs and outputs can be configured using the GridVis software (included in the scope of delivery).

The settings of the functions in the configuration menu must be made using the GridVis software.

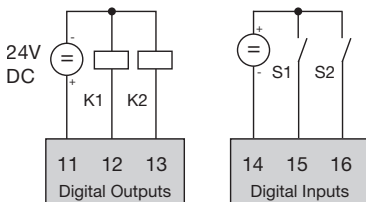

Fig.: Digital inputs and outputs

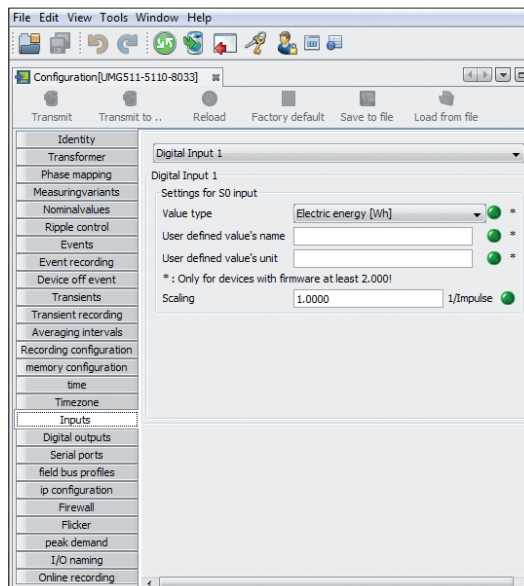

Fig.: GridVis software, configuration menu

Pulse output

The digital outputs can be used for the output of pulses for the computation of power consumption. For this purpose, a pulse of defined length is applied on the output after reaching a certain, adjustable amount of power.

You need to make various adjustments in the configuration menu using the GridVis software to use a digital output as a pulse out.

- Digital output,
- Measured value selection,
- Pulse length,
- Pulse value.

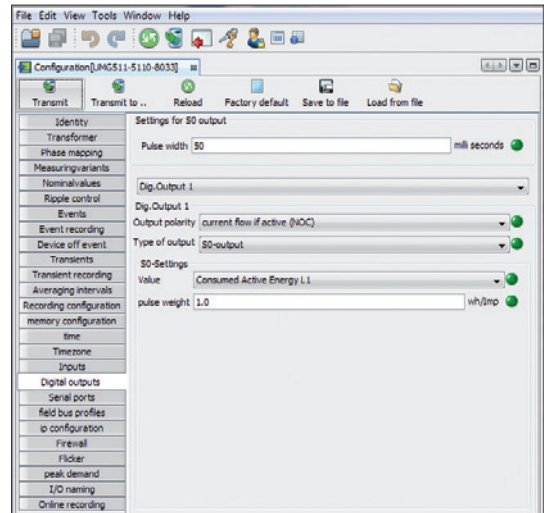

Fig.: GridVis software, configuration menu

Pulse length

The pulse length applies to both pulse outputs and is set using the GridVis software.

The typical pulse length of S0 pulse is 30ms.

Pulse interval

The pulse interval is at least as large as the selected pulse length.

The pulse interval depends on the measured power, for example, and can take hours or days.

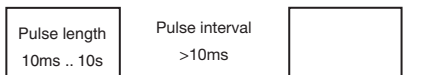

The values in the table are based on the minimum pulse length and the minimum pulse interval for the maximum number of pulses per hour.

Pulse length	Pulse interval	Max. pulse/h
10 ms	10 ms	180 000 pulses/h
30 ms	30 ms	60 000 pulses/h
50 ms	50 ms	36 000 pulses/h
100 ms	100 ms	18 000 pulses/h
500 ms	500 ms	3600 pulses/h
1 s	1 s	1800 pulses/h
10 s	10 s	180 pulses/h

Examples of the maximum possible number of pulses per hour.



Pulse interval

The pulse interval is proportional to the power output within the selected settings.



Measured value selection

When programming with GridVis you have a selection of work values which are derived from the power output values.

Pulse value

The pulse value is used to indicate how much power (Wh or varh) should correspond to a pulse.

The pulse value is determined by the maximum connected load and the maximum number of pulses per hour.

If you check the pulse value with a positive sign, the pulses will only be emitted when the measured value has a positive sign.

If you check the pulse value with a negative sign, the pulses will only be produced when the measured value has a negative sign.

$$\text{Pulse value} = \frac{\text{max. connected load}}{\text{max. number of pulses/h}} \quad [\text{Pulse/Wh}]$$



Since the effective power meter operates with a backstop, pulses will only be generated when drawing electricity.



Since the reactive power meter operates with a backstop, pulses will only be generated with inductive load applied.

Determine the pulse value

Set the pulse length

Set the pulse length in accordance with the requirements of the connected pulse receiver.

At a pulse length of 30 ms, for example, the UMG 512 generates a maximum number of 60,000 pulses (see Table "maximum number of pulses" per hour.

Determining the maximum connected load

Example:

$$\begin{aligned} \text{Current transformer} &= 150/5A \\ \text{Voltage L-N} &= \text{max. } 300 \text{ V} \end{aligned}$$

$$\begin{aligned} \text{Power per phase} &= 150 \text{ A} \times 300 \text{ V} \\ &= 45 \text{ kW} \end{aligned}$$

$$\begin{aligned} \text{Power at 3 phases} &= 45\text{kW} \times 3 \\ \text{Max. connected load} &= 135\text{kW} \end{aligned}$$

Calculating the pulse value

$$\text{Pulse value} = \frac{\text{max. connected load}}{\text{max. number of pulses/h}} \quad [\text{Pulse/Wh}]$$

$$\text{Pulse value} = 135\text{kW} / 60,000 \text{ Imp/h}$$

$$\text{Pulse value} = 0.00225 \text{ pulse/kWh}$$

$$\text{Pulse value} = 2.25 \text{ pulses/Wh}$$

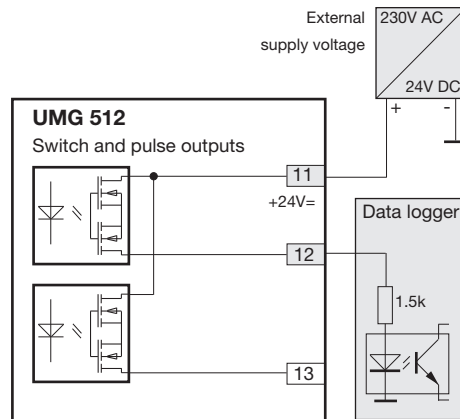

Fig.: Connection example for the circuit as pulse output.



When using the digital outputs as pulse outputs, the auxiliary voltage (DC) must have a max. residual ripple of 5%.

Service and maintenance

The device underwent various safety checks before delivery and is marked with a seal. If a device is open, then the safety checks must be repeated. Warranty claims will only be accepted if the device is unopened.

Repair and calibration

Repair work and calibration can be carried out by the manufacturer only.

Front film

The front film can be cleaned with a soft cloth and standard household cleaning agent. Do not use acids and products containing acid for cleaning.

Disposal

The UMG 512 can be reused or recycled as electronic scrap in accordance with the legal provisions. The permanently installed lithium battery must be disposed of separately.

Service

Should questions arise, which are not described in this manual, please contact the manufacturer directly.

We will need the following information from you to answer any questions:

- Device name (see rating plate),
- Serial number (see rating plate),
- Software release (see measured value display),
- Measured voltage and power supply voltage,
- Precise description of the error.

Device calibration

The devices are calibrated by the manufacturer at the factory - it is not necessary to recalibrate the device providing that the environmental conditions are complied with.

Calibration intervals

We recommend having the device recalibrated by the manufacturer or an accredited laboratory every 5 years approximately.

Firmware update

If the device is connected to a computer via Ethernet, then the device firmware can be updated via the GridVis software.

The new firmware is transferred by selecting a suitable update menu (*Tools/Upgrade Devices* menu) and the device.

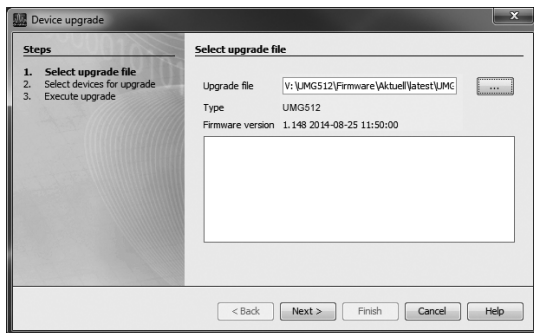

Fig. GridVis firmware update assistant



Firmware may NOT be updated via the RS485 interface.

Battery

The internal clock is fed from the supply voltage. If the supply voltage fails then the clock is powered by the battery. The clock provides date and time information, for the records, min. and max. values and events, for example.

The life expectancy of the battery is at least 5 years with a storage temperature of +45°C. The typical life expectancy of the battery is 8 to 10 years.

The battery (type CR2450 / 3V) can be replaced by the user.

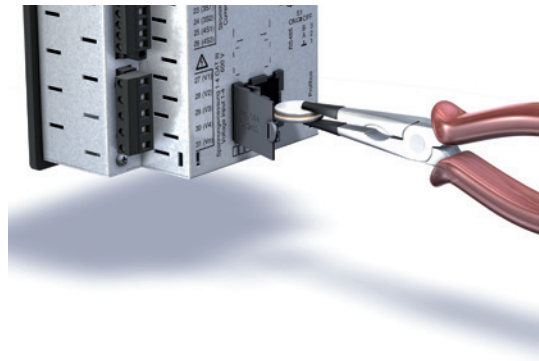

Fig. Replacing the battery using long-nose pliers

Procedure in the event of faults

Possible fault	Cause	Remedy
No display	External fuse for the power supply voltage has tripped.	Replace fuse.
No current display	Measured voltage is not connected.	Connect the measured voltage.
	Measurement current is not connected.	Connect measuring-circuit current.
Current displayed is too large or too small.	Current measurement in the wrong phase.	Check connection and correct if necessary.
	Current transformer factor is incorrectly programmed.	Read out and program the CT ratio at the current transformer.
	The current peak value at the measurement input was exceeded by harmonic components.	Install current transformer with a larger CT ratio.
	The current at the measurement input fell short of.	Install current transformer with a smaller current transformer ratio.
Voltage displayed is too large or too small.	Measurement in the wrong phase.	Check connection and correct if necessary.
	Voltage transformer incorrectly programmed.	Read out and program the voltage transformer ratio at the voltage transformer.
Voltage displayed is too small.	Measurement range exceeded.	Use voltage transformers.
	The peak voltage value at the measurement input has been exceeded by the harmonics.	Please note! Ensure the measurement inputs are not overloaded.
Phase shift ind/cap.	A current path is assigned to the wrong voltage circuit.	Check connection and correct if necessary.
Effective power, consumption/supply reversed.	At least one current transformer connection is mixed up/reversed.	Check connection and correct if necessary.
	A current path is assigned to the wrong voltage circuit.	Check connection and correct if necessary.

Possible fault	Cause	Remedy
Effective power too large or too small.	The programmed CT ratio is incorrect.	Read out and program the CT ratio at the current transformer
	The current path is assigned to the wrong voltage circuit.	Check connection and correct if necessary.
	The programmed voltage transformer ratio is incorrect.	Read out and program the voltage transformer ratio at the voltage transformer.
An output is not responding.	The output was incorrectly programmed.	Check the settings and correct if necessary.
	The output was incorrectly connected.	Check connection and correct if necessary.
Measurement range exceeded display (overload)	Voltage and current measurement input outside the measurement range (See section Measurement range exceeded)	Check connection and correct if necessary.
		Use suitable voltage and current transformers.
		Read out and program the voltage or current transformer ratio at the transformer.
No connection with the device.	RS485 - Device address is incorrect. - Different bus speeds (Baud rate). - Wrong protocol. - Termination missing.	- Adjust the device address. - Adjust speed (baud rate). - Select the correct protocol. - Terminate bus with termination resistor.
	Ethernet - IP Device address is incorrect. - Incorrect addressing mode	- Adjust IP device address. - Adjust the IP address assignment mode
Device still does not work despite the above measures.	Device defective.	Send the device to the manufacturer for inspection and testing along with an accurate fault description.

Technical data

General	
Net weight (with attached connectors)	approx. 1080g
Device dimensions	approx. l = 144mm, w = 144mm, h = 75mm
Battery	Type Li-Mn CR2450, 3V (approval i.a.w. UL 1642)
Clock (in temperature range -40°C to 85°C)	+5ppm (corresponding to approx. 3 minutes p.a.)

Transport and storage	
The following information applies to devices which are transported or stored in the original packaging.	
Free fall	1m
Temperature	-25°C to +70°C

Ambient conditions during operation	
The UMG 512 is intended for weather-protected, stationary use. The UMG 512 must be connected to the protective current connection! Protection class I in acc. with IEC 60536 (VDE 0106, Part 1).	
Working temperature range	-10°C to +55°C
Relative humidity	5 to 95% RH (at 25°C without condensation)
Operating altitude	0 to 2000m above sea level
Pollution degree	2
Mounting position	vertical
Ventilation	Forced ventilation is not required.
Protection against ingress of solid foreign bodies and water - Front side - Rear side	IP40 i.a.w. EN60529 IP20 in acc. with EN60529

Supply voltage	
Installations of overvoltage category	300V CAT III
Protection of the supply voltage (fuse)	6A, type C (approved i.a.w. UL/IEC)
230V option: - Nominal range - Operating range - Power consumption	95V .. 240V (45-65Hz) or DC 80V .. 300V +10% of nominal range max. 7W / 14VA
24V option: - Nominal range - Operating range - Power consumption	48V .. 110V (45-65Hz) or DC 24 .. 150V +10% of nominal range max. 9W / 13VA

Terminal connection capacity (supply voltage)	
Connectable conductors. Only one conductor can be connected per terminal!	
Single core, multi-core, fine-stranded	0.2 - 2.5mm ² , AWG 24 - 12
Terminal pins, core end sheath	0.25 - 2.5mm ²
Tightening torque	0.5 - 0.6Nm
Stripping length	7mm

Current measurement	
Rated current	5A
Resolution	0.1mA
Metering range	0.001 to 7 Arms
Measurement range exceeded (overload)	From 7 Arms
Crest factor	1.41
Overvoltage category	230V option: 300V CAT III 24V option: 300V CAT II
Measurement surge voltage	4kV
Power consumption	approx. 0.2 VA (Ri=5mOhm)
Overload for 1 sec.	120A (sinusoidal)
Sampling frequency	25.6kHz / phase

Voltage measurement	
The voltage measurement inputs are suitable for measurements in the following power supply systems:	
Three-phase 4-conductor systems with rated voltages up to	417V/720V (+10%)
Three-phase 3-conductor systems with rated voltages up to	600V (+10%)
From a safety and reliability perspective, the voltage measurement inputs are designed as follows:	
Overvoltage category	600V CAT III
Measurement surge voltage	6kV
Metering range L-N	0 ¹⁾ to 600Vrms
Metering range L-L	0 ¹⁾ to 1000Vrms
Resolution	0.01V
Crest factor	1.6 (related to 600Vrms)
Impedance	4MΩm/phase
Power consumption	approx. 0.1VA
Sampling rate	25.6kHz / phase
Transients	39μs
U _{din} ²⁾ i.a.w. EN61000-4-30	100 to 250V
Flicker range (dU/U)	27.5%
Frequency range of the fundamental oscillation - Resolution	15Hz to 440Hz 0.001Hz

¹⁾ The UMG 512 can only determine measured values, if at least a voltage L-N greater than 10V_{eff} or a voltage L-L of greater than 18V_{eff} is present at one voltage measurement input.

²⁾ The U_{din} = arranged input voltage according to DIN EN 61000-4-30

Terminal connection capacity (voltage and current measurement)	
Connectable conductors. Only one conductor can be connected per terminal!	
Single core, multi-core, fine-stranded	0.2 - 2.5mm ² , AWG 24-12
Terminal pins, core end sheath	0.25 - 2.5mm ²
Tightening torque	0.5 - 0.6Nm
Stripping length	7mm

Residual current monitoring (RCM)	
Rated current	30mArms
Metering range	0 to 40mArms
Triggering current	100 μ A
Resolution	1 μ A
Crest factor	1.414 (related to 40mA)
Burden	4 Ohm
Overload for 1 sec.	5A
Sustained overload	1A
Overload for 20 ms	50A
Residual current monitoring	i.a.w. IEC/TR 60755 (2008-01), type A 
Maximum external burden	300 Ohm (for cable break detection)

Terminal connection capacity (residual current monitoring)	
Connectable conductors. Only one conductor can be connected per terminal!	
Rigid/flexible	0.14 - 1.5mm ² , AWG 28-16
Flexible with core end sheath without plastic sleeve	0.20 - 1.5mm ²
Flexible with core end sheath with plastic sleeve	0.20 - 1.5mm ²
Stripping length	7mm
Tightening torque	0.20 - 0.25Nm
Cable length	up to 30m unshielded, from 30m shielded

Temperature measurement input 3-wire measurement	
Update time	1 second
Connectable sensors	PT100, PT1000, KTY83, KTY84
Total burden (sensor + cable)	max. 4 kOhm
Cable length	up to 30m unshielded, from 30m shielded

Sensor type	Temperature range	Resistor range	Measurement uncertainty
KTY83	-55°C to +175°C	500Ohm to 2.6kOhm	± 1.5% rng
KTY84	-40°C to +300°C	350Ohm to 2.6kOhm	± 1.5% rng
PT100	-99°C to +500°C	60Ohm to 180Ohm	± 1.5% rng
PT1000	-99°C to +500°C	600Ohm to 1.8kOhm	± 1.5% rng

Terminal connection capacity (temperature measurement input) Connectable conductors. Only one conductor can be connected per terminal!	
Single core, multi-core, fine-stranded	0.08 - 1.5mm ²
Terminal pins, core end sheath	1mm ²

Digital inputs

2 Digital inputs with a joint earth

Maximum counter frequency	20Hz
Response time (Jasic program)	200ms
Input signal present	18V to 28V DC (typical 4mA)
Input signal not present	0 to 5V DC, current less than 0.5mA
Cable length	up to 30m unshielded, from 30m shielded

Digital outputs

2 Digital outputs with a joint earth; opto-coupler, not short-circuit proof

Supply voltage	20V - 30V DC (SELV or PELV supply)
Switching voltage	max. 60V DC
Switching current	max. 50mAeff AC/DC
Response time (Jasic program)	200ms
Switching frequency	max. 20Hz
Cable length	up to 30m unshielded, from 30m shielded

Terminal connection capacity (digital inputs and outputs)

Rigid/flexible	0.14 - 1.5mm ² , AWG 28-16
Flexible with core end sheath without plastic sleeve	0.25 - 1.5mm ²
Flexible with core end sheath with plastic sleeve	0.25 - 0.5mm ²
Tightening torque	0.22 - 0.25Nm
Stripping length	7mm

RS485 interface	
3-wire connection with GND, A, B	
Protocol	Modbus RTU/slave, Modbus RTU/master, Modbus RTU /Gateway
Transmission rate	9.6kbps, 19.2kbps, 38.4kbps, 57.6 kbps, 115.2kbps, 921.6kbps
Termination resistor	Can be activated by micro switch

Profibus interface	
Connection	SUB D 9-pole
Protocol	Profibus DP/V0 as per EN 50170
Transmission rate	9.6k baud to 12 MBaud

Ethernet interface	
Connection	RJ45
Function	Modbus gateway, embedded web server (HTTP)
Protocols	CP/IP, EMAIL (SMTP), DHCP client (BootP), Modbus/TCP, Modbus RTU over Ethernet, FTP, ICMP (Ping), NTP, TFTP, BACnet (option), SNMP,

Function parameters

- Measurement via current transformer ..5A
- Measurements with 50/60 Hz

Function	Symbol	Precision class	Metering range	Display range
Total effective power	P	0.2 ⁵⁾ (IEC61557-12)	0 to 15.3kW	0 W to 9999 GW *
Total reactive power	QA ⁶⁾ , Qv ⁶⁾	1 (IEC61557-12)	0 to 15.3 kvar	0 varh .. 9999 Gvar *
Total apparent power	SA, Sv ⁶⁾	0.2 ⁵⁾ (IEC61557-12)	0 to 15.3 kVA	0 VA to 9999 GVA *
Total effective energy	Ea	0.2S ^{9) 7)} (IEC61557-12)	0 to 15.3 kWh	0 Wh to 9999 GWh *
Total reactive energy	ErA ⁶⁾ , ErV ⁶⁾	1 (IEC61557-12)	0 to 15.3 kvarh	0 varh .. 9999 Gvarh *
Total apparent energy	EapA, EapV ⁶⁾	0.2 ⁵⁾ (IEC61557-12)	0 to 15.3 kVAh	0 VAh to 9999 GVAh *
Frequency	f	0.05 (IEC61557-12)	40 to 70 Hz	40 Hz to 70 Hz
Phase current	I	0.1 (IEC61557-12)	0.001 to 8.5 Arms	0 A to 9999 kA
Measured neutral conductor current	IN	0.1 (IEC61557-12)	0.001 to 8.5 Arms	0 A to 9999 kA
Residual currents I5, I6	IDIFF	1 (IEC61557-12)	0 to 40 mArms	0 A to 9999 kA
Computed neutral conductor current	INc	0.5 (IEC61557-12)	0.001 to 25.5 A	0 A to 9999 kA
Voltage	U L-N	0.1 (IEC61557-12)	10 to 600 Vrms	0 V to 9999 kV
Voltage	U L-L	0.1 (IEC61557-12)	18 to 1000 Vrms	0 V to 9999 kV
Power factor	PFA, PFV	0.5 (IEC61557-12)	0.00 to 1.00	0 to 1
Short-term flicker, long-term flicker	Pst, PIt	Cl. A (IEC61000-4-15)	0.4 Pst to 10.0 Pst	0 to 10
Voltage drops	Udip	0.2 (IEC61557-12)	10 to 600 Vrms	0 V to 9999 kV
Voltage increases	Uswl	0.2 (IEC61557-12)	10 to 600 Vrms	0 V to 9999 kV
Transient overvoltages	Utr	0.2 (IEC61557-12)	10 to 600 Vrms	0 V to 9999 kV
Voltage interruptions	Uint	Duration +- 1 cycle	-	-
Voltage unbalance ¹⁾	Unba	0.2 (IEC61557-12)	10 to 600 Vrms	0 V to 9999 kV
Voltage unbalance ²⁾	Unb	0.2 (IEC61557-12)	10 to 600 Vrms	0 V to 9999 kV
Voltage harmonics	Uh	Cl. 1 (IEC61000-4-7)	up to 2.5 kHz	0 V to 9999 kV

THD of the voltage ³⁾	THDu	1.0 (IEC61557-12)	up to 2.5 kHz	0% to 999%
THD of the voltage ⁴⁾	THD-Ru	1.0 (IEC61557-12)	up to 2.5 kHz	0% to 999%
Current harmonics	Ih	Cl. 1 (IEC61000-4-7)	up to 2.5 kHz	0 A to 9999 kA
THD of the current ³⁾	THDi	1.0 (IEC61557-12)	up to 2.5 kHz	0% to 999%
THD of the current ⁴⁾	THD-Ri	1.0 (IEC61557-12)	up to 2.5 kHz	0% to 999%
Mains signal voltage (interharmonics voltage)	MSV	IEC 61000-4-7 class 1	10% – 200% of IEC 61000-2-4 class 3	0 V to 9999 kV

- Measurements in the range 15 to 440 Hz

Function	Symbol	Precision class	Metering range	Display range
Total effective power	P	2 (IEC61557-12)	0 to 15.3kW	0 W to 9999 GW *
Total reactive power	QA ⁶⁾ , Qv ⁶⁾	2 (IEC61557-12)	0 to 15.3 kvar	0 varh .. 9999 Gvar *
Total apparent power	SA, Sv ⁶⁾	1 (IEC61557-12)	0 to 15.3 kVA	0 VA to 9999 GVA *
Total effective energy	Ea	2 (IEC61557-12)	0 to 15.3 kWh	0 Wh to 9999 GWh *
Total reactive energy	ErA ⁶⁾ , ErV ⁶⁾	2 (IEC61557-12)	0 to 15.3 kvarh	0 varh .. 9999 Gvarh *
Total apparent energy	EapA, EapV ⁶⁾	1 (IEC61557-12)	0 to 15.3 kVAh	0 VAh to 9999 GVAh *
Frequency	f	0.05 (IEC61557-12)	15 to 440 Hz	15 Hz to 440 Hz
Phase current	I	0.5 (IEC61557-12)	0.001 to 8.5 Arms	0 A to 9999 kA
Measured neutral conductor current	IN	0.5 (IEC61557-12)	0.001 to 8.5 Arms	0 A to 9999 kA
Residual currents I5, I6	IDIFF	1 (IEC61557-12)	0 to 40 mArms	0 A to 9999 kA
Computed neutral conductor current	INc	1.5 (IEC61557-12)	0.001 to 25.5 A	0 A to 9999 kA
Voltage	U L-N	0.5 (IEC61557-12)	10 to 600 Vrms	0 V to 9999 kV

Function	Symbol	Precision class	Metering range	Display range
Voltage	U L-L	0.5 (IEC61557-12)	18 to 1000 Vrms	0 V to 9999 kV
Power factor	PFA, PFV	2 (IEC61557-12)	0.00 to 1.00	0 to 1
Short-term flicker, long-term flicker	Pst, Plt	-	-	-
Voltage drops	Udip	0.5 (IEC61557-12)	10 to 600 Vrms	0 V to 9999 kV
Voltage increases	Uswl	0.5 (IEC61557-12)	10 to 600 Vrms	0 V to 9999 kV
Transient overvoltages	Utr	0.5 (IEC61557-12)	10 to 600 Vrms	0 V to 9999 kV
Voltage interruptions	Uint	Duration +- 1 cycle	-	-
Voltage unbalance ¹⁾	Unba	0.5 (IEC61557-12)	10 to 600 Vrms	0 V to 9999 kV
Voltage unbalance ²⁾	Unb	0.5 (IEC61557-12)	10 to 600 Vrms	0 V to 9999 kV
Voltage harmonics	Uh	Cl. 2 (IEC61000-4-7)	up to 2.5 kHz	0 V to 9999 kV
THD of the voltage ³⁾	THDu	2.0 (IEC61557-12)	up to 2.5 kHz	0% to 999%

Declarations

- 1) In relation to the amplitude.
- 2) In relation to phase and amplitude.
- 3) In relation to fundamental oscillation.
- 4) In relation to effective value.
- 5) Precision class 0.2 with.../ 5A converter.
Precision class 0.5 with.../ 1A converter.
- * The display returns to 0 W once the max. total working value range has been reached.
- 6) Calculation from fundamental oscillation.
- 7) Precision class 0.2S according IEC62053-22

UMG512 specifications as per IEC 61000-4-30

Characteristic		Uncertainty	Metering range
5.1	Frequency	± 10 mHz	42.5 Hz – 57.5 Hz, 51Hz – 69 Hz
5.2	Supply voltage level	$\pm 0.1\%$ of U _{din}	10% – 150% of U _{din}
5.3	Flicker	$\pm 5\%$ of measured value	0.2 – 10 Pst
5.4	Drops and excessive increases	Amplitude: $\pm 0.2\%$ of U _{din} Duration: ± 1 period	N/A
5.5	Voltage interruptions	Duration: ± 1 period	N/A
5.7	Unbalance	$\pm 0.15\%$	0.5% – 5% u ₂ 0.5% – 5% u ₀
5.8	Harmonics	IEC 61000-4-7 class 1	10% – 200% of class 3 of IEC 61000-2-4
5.9	Interharmonics	IEC 61000-4-7 class 1	10% – 200% of class 3 of IEC 61000-2-4
5.10	Mains signal voltage	In the range 3%-15% of U _{din} , $\pm 5\%$ of U _{din} . In the range 1%-3% of U _{din} , $\pm 0.15\%$ of U _{din} . There are no uncertainty requirements for values < 1% of U _{din} .	0% – 15% of U _{din}
5.12	Downward/upward deviation	$\pm 0.1\%$ of U _{din}	10% – 150% of U _{din}

The UMG 512 meets the requirements according to IEC 61000-4-30 class A for:

- compensation, time uncertainty, marking concept, transient influence quantities.



To ensure that two measurement devices achieve the same measurement results in a 10 minute compensation interval, we recommend synchronising time measurement in the UMG 512 using an external time signal.

Dimension diagrams

Cut-out size: 138^{+0.8} x 138^{+0.8} mm

Rear side

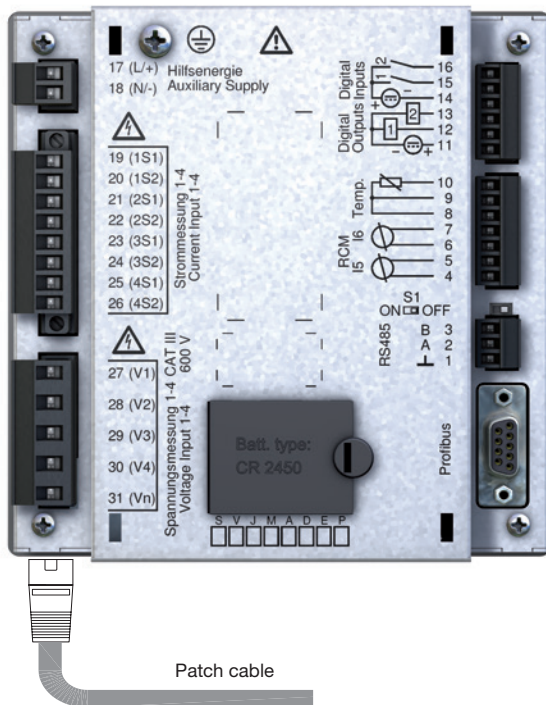

Patch cable

Side view

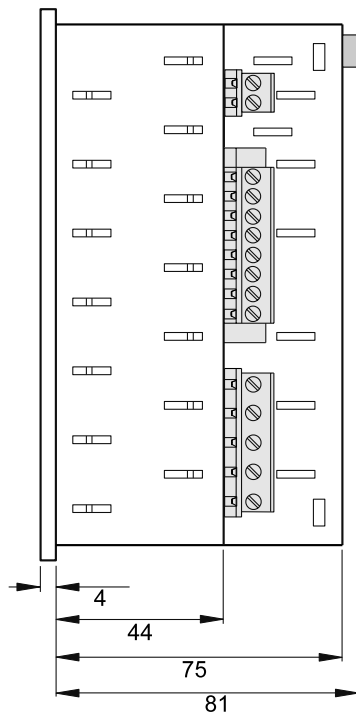

View from below

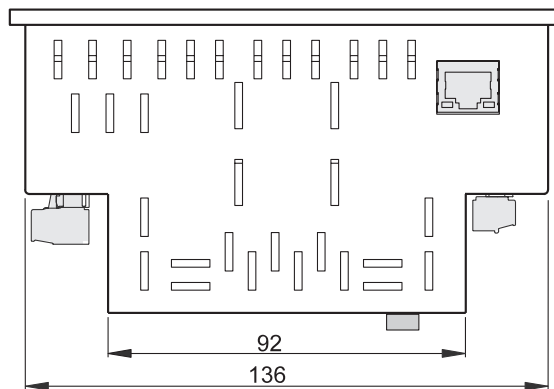

Configuration menu overview

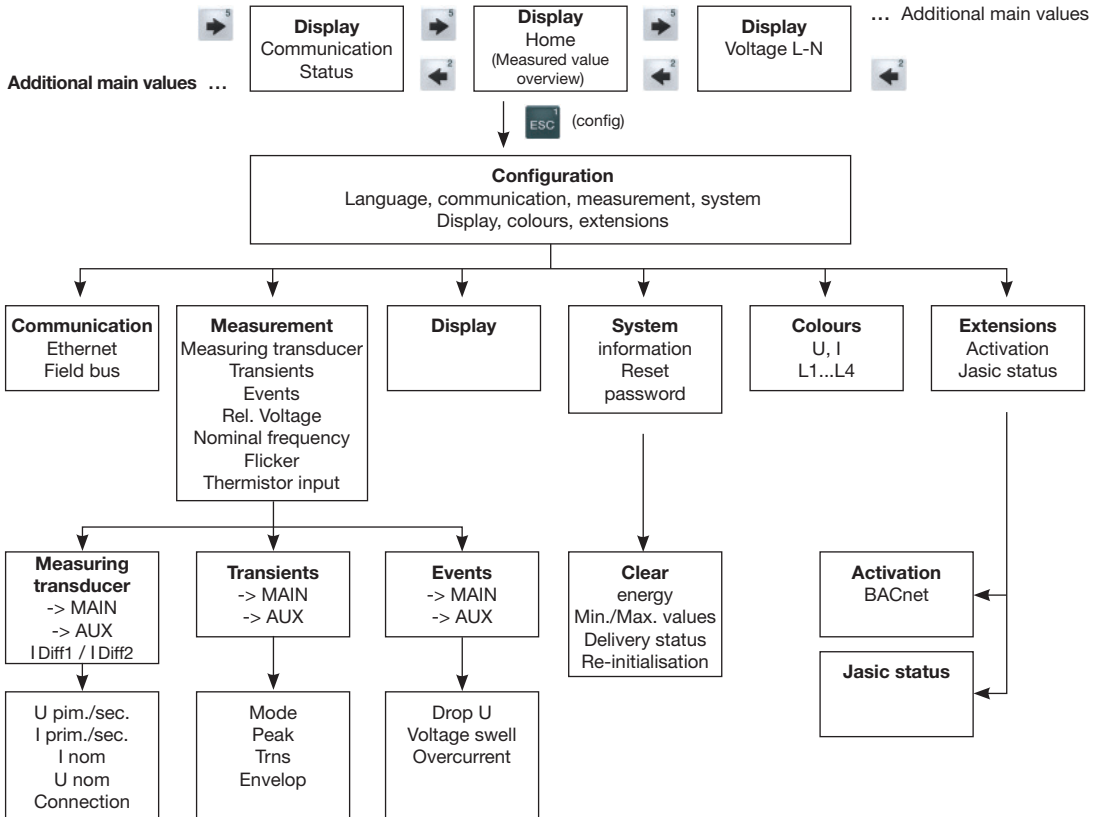

Measured value displays overview

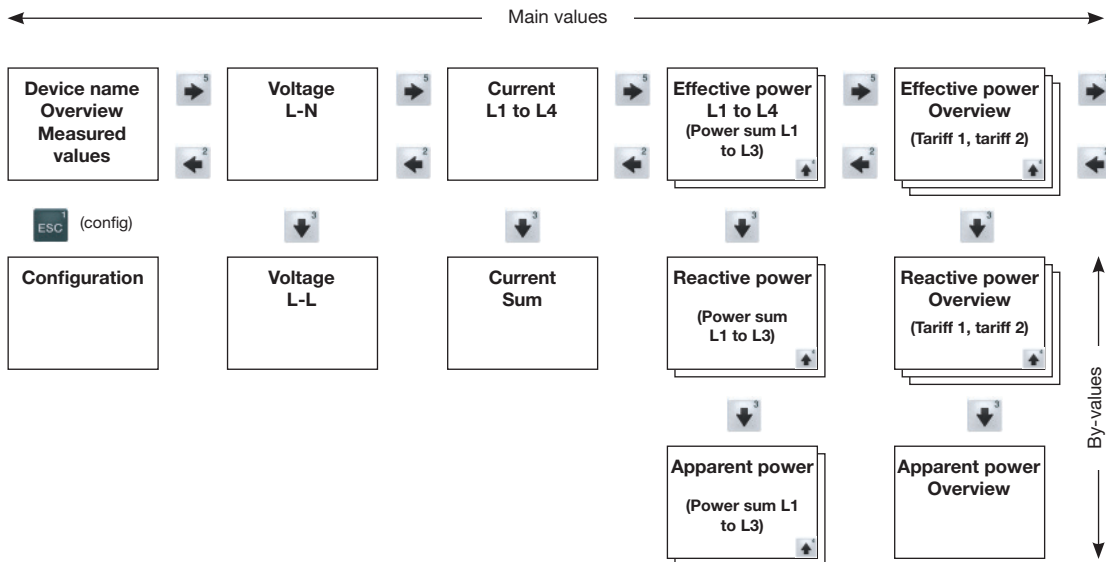

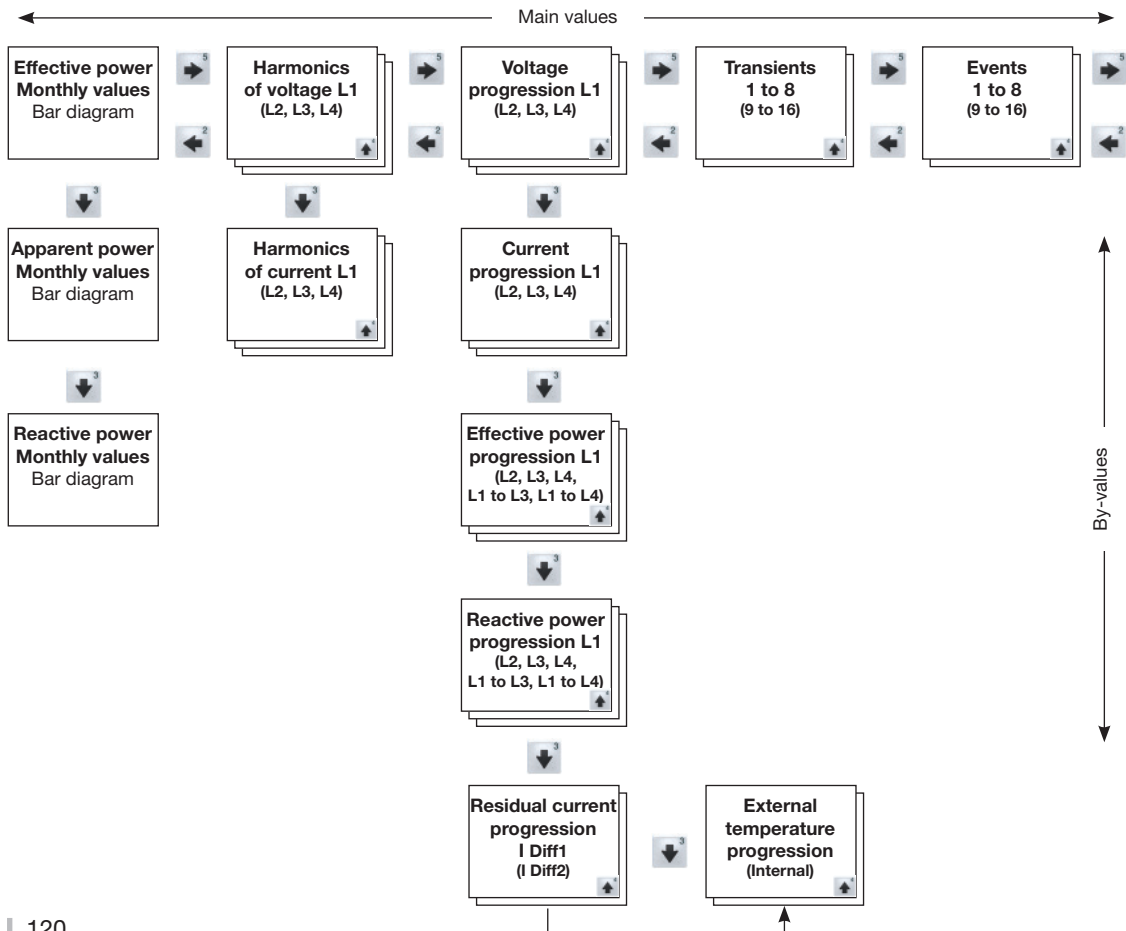

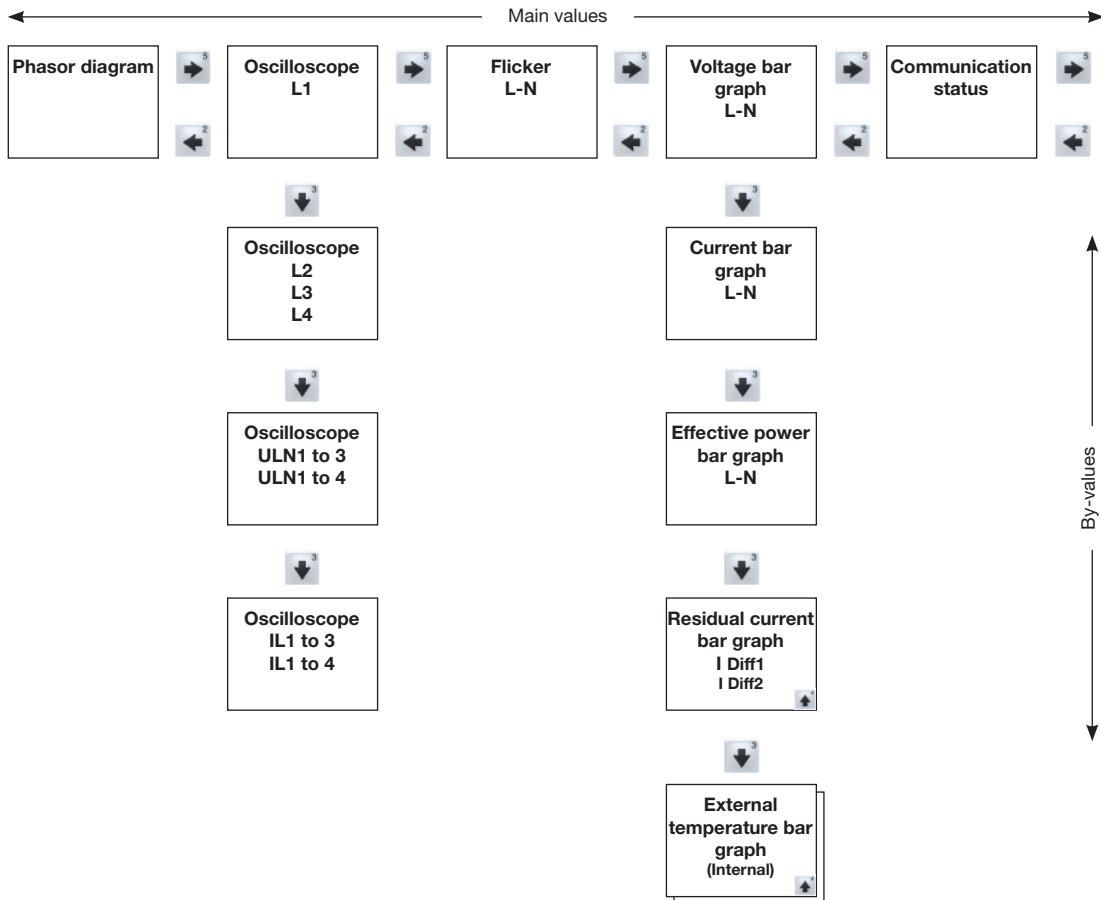

Connection example

