

www.janitza.com

Janitza electronics GmbH
 Vor dem Polstück 6
 D-35633 Lahnau
 Support tel. +49 6441 9642-22
 Fax +49 6441 9642-30
 E-mail: info@janitza.com
 Internet: http://www.janitza.com

Power Analyser

UMG 96RM-P

UMG 96RM-CBM

User manual and
 technical data

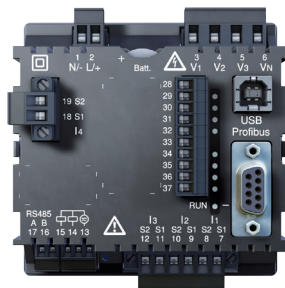

UMG 96RM-P

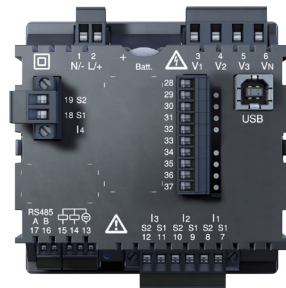

UMG 96RM-CBM

Janitza®

Table of contents

General	4	Configuration	50
Incoming goods inspection	6	Applying the supply voltage	50
Available accessories	7	Current and voltage transformers	50
Product description	8	Programming current transformers	52
Proper use	8	Programming voltage transformers	53
Features of the UMG 96RM-P/-CBM	10	Programming parameters	54
Measuring method	11	“Drag indicator”	66
Operating concept	11	Recordings	67
GridVis network analysis software	12	Commissioning	68
Connection variants	12	Applying the supply voltage	68
Assembly	14	Applying the measured voltage	68
Installation	16	Applying the measured current	68
Supply voltage	16	Rotation field direction	69
Voltage metering	17	Checking the phase assignment	69
Current measurement via I1 to I4	24	Checking the power measurement	69
RS485 interface	33	Checking the measurement	69
USB interface	36	Checking the individual power ratings	69
Profibus interface (only UMG 96RM-P)	37	Check the sum power ratings	70
Digital outputs	39	RS485 interface	71
Digital inputs	42	Installation of USB driver	74
LED status bar	44	Profibus interface (only UMG 96RM-P)	76
Operation	46	Digital outputs	84
Display mode	46	Impulse output	86
Programming mode	46		
Parameters and measured values	48		

Comparators and monitoring threshold values	90
Service and maintenance	92
Service	92
Device calibration	92
Calibration intervals	92
Firmware update	93
Battery	93
Battery monitoring function	94
Replacing the battery	95
Error messages	96
Technical data	102
Parameters of functions	108
Table 1 - Parameter list	110
Table 2 - Modbus address list	114
Number formats	117
Dimension diagrams	118
Overview of measured value displays	121
Connection example	126
Basic functions quick guide	127

General

Copyright

This manual is subject to the laws of copyright protection and may not be mechanically or electronically photocopied, reprinted, reproduced or otherwise reproduced or published in part or as a whole, without the legally binding, written consent of

Janitza electronics GmbH, Vor dem Polstück 1,
D 35633 Lahnau, Germany.

Trademarks

All trademarks and the rights resulting from them remain the property of the trademark holder of these rights.

Disclaimer

Janitza electronics GmbH assumes no responsibility for errors or omissions in this manual and assumes no obligation to keep the contents of this manual up to date.

Comments about the manual

Your comments are welcome. If anything in this manual is unclear, please let us know and send us an e-mail at: info@janitza.com

Meaning of the symbols

The following pictograms are used in this manual:



Dangerous voltage!

Risk of death or serious injury. Disconnect the power before working on the system and device.



Attention!

Please refer to the documentation. This symbol will warn you of possible dangers that could occur during assembly, commissioning and operation.



Note!

Application notes

Please read these operating instructions and all other publications that must be consulted in order to work with this product (particularly for installation, operation or maintenance).

Please observe all safety regulations and warnings. Non-compliance with the instructions can lead to personal injury and/or damage to the product.

Any unauthorised alteration or use of this device which exceeds the specified mechanical, electrical or other operational limits can cause personal injury and/or damage to the product.

Any such unauthorised alterations are grounds for “abuse” and/or “negligence” in terms of the product’s guarantee and thus excludes the warranty for covering any possible resulting damages.

This device must only be operated and maintained by qualified personnel.

Qualified personnel are persons who, due to their respective training and experience, are able to recognise risks and avoid potential hazards that can be caused by operation or maintenance of the device.

When using the device, the legal and safety regulations required for the respective application must also be observed.



Safety is no longer guaranteed and the device may be dangerous if the device is not operated according to the operating instructions.



Conductors consisting of single wires must be provided with ferrules.



Only screw terminals with the same number of poles and the same type may be plugged together.

About these operating instructions

These operating instructions are part of the product.

- Read the operating instructions prior to using the device.
- Keep the operating instructions at hand throughout the entire service life of the product and keep ready for referencing.
- Hand over the operating instructions to each subsequent owner or user of the product.



All supplied screw terminals are attached to the device.

Incoming goods inspection

The proper and safe operation of this device requires appropriate transport, proper storage, installation and assembly as well as careful operation and maintenance. When it is assumed that safe operation is no longer possible, the device must immediately be taken out of operation and secured against accidental start-up.

Unpacking and packing must be carried out with the usual care, without the use of force and only with the use of suitable tools. The devices must be visually inspected for proper mechanical condition.

It can be assumed that safe operation is no longer possible if the device, e.g.

- shows visible damage,
- does not work despite intact power supply,
- and was exposed to unfavourable conditions (e.g. storage outside of the permissible climatic limits without adaptation to the ambient climate, condensation, etc.) or transport stresses (e.g. falling from a great height even without exterior visible damage, etc.) for prolonged periods.
- Please check that the delivery is complete before you begin with installation of the device.

Available accessories

Quantity	Item no.	Designation
2	52.22.251	Mounting brackets
1	10.01.855	Screw terminal, pluggable, 2-pin (auxiliary energy)
1	10.01.849	Screw terminal, pluggable, 4-pin (voltage measurement)
1	10.01.871	Screw terminal, pluggable, 6-pin (current measurement)
1	10.01.875	Screw terminal, pluggable, 2-pole (current measurement I4)
1	10.01.857	Screw terminal, pluggable, 2-pin (RS 485)
1	10.01.865	Screw terminal, pluggable, 10-pole (digital inputs/outputs)
1	10.01.859	Screw terminal, pluggable, 3-pin (digital/pulse output)
1	08.02.434	USB connection cable A/B, 1.8m long
1	52.00.008	RS485, external terminating resistor, 120 ohm
1	21.01.058	Battery 3V, TYP CR2032 (according to UL1642)
1	29.01.065	Silicone seal, 96 x 96
1	15.06.015	Interface converter RS485 <-> RS232
1	15.06.025	Interface converter RS485 <-> USB
1	13.10.539	D-sub Profibus connector

Product description

Proper use

The UMG 96RM-P/-CBM is intended for the measurement and calculation of electrical parameters such as voltage, current, power, energy, harmonics etc. in building installations, on distribution units, circuit breakers and busbar trunking systems.

The UMG 96RM-P/-CBM is suitable for integration into fixed and weatherproof switch panels. Conductive switch panels must be earthed. Can be installed in any attitude.

Measured voltage and measured current must derive from the same network.

The measurement results can be displayed and can be read out and further processed via the interfaces.

The voltage measurement inputs are designed for measurements in low voltage networks, in which rated voltages of up to 300V relative to earth and surges in overvoltage category III can occur.

The current measurement inputs of the UMG 96RM-P/-CBM are connected via external $\dots/1A$ or $\dots/5A$ current transformers.

The measurement in medium and high voltage networks is implemented in principle via current and voltage transformers. The UMG 96RM-P/-CBM can be employed both domestically and in industry.

Device characteristics

- Supply voltage:
 - Option 230V: 90V - 277V (50/60Hz) or DC 90V - 250V; 300V CATIII
 - Option 24V: 24 - 90V AC / DC; 150V CATIII
- Frequency range: 45 - 65Hz

Device functions

	UMG 96RM	
	-P	-CBM
3 voltage measurements, 300V	✓	✓
4 current measurements (via current transformer)	✓	✓
RS 485 interface (Modbus RTU)	✓	✓
Profibus	✓	-
USB	✓	✓
2 + 4 digital outputs	✓	✓
4 digital inputs	✓	✓
Clock, memory	✓	✓

Features of the UMG 96RM-P/-CBM

- General
 - Front panel-mounted with the dimensions 96x96 mm
 - Connection via screw-type terminals
 - LC display with backlighting.
 - Operation via 2 buttons
 - 3 voltage measurements inputs (300V CATIII)
 - 4 current measurement inputs for current transformer
 - RS485 interface (Modbus RTU, slave, to 115 kbps)
 - 6 digital outputs and 4 digital inputs
 - USB interface
 - *Only UMG 96RM-P variant:* Profibus interface (Profibus DP V0)
 - Working temperature range -10°C .. +55°C
 - Storage of minimum and maximum values (with time stamp)
 - 5 MB flash memory
 - Clock and battery (with battery monitoring function)
 - Configurable records, can be read out via RS485 and USB
- Measurement uncertainty
 - Active energy, measuring uncertainty class 0.5 for ../5 A transformer
 - Active energy, measuring uncertainty class 1 for ../1 A transformer
 - Reactive energy, class 2
- Measurement
 - Measurement in IT, TN and TT networks
 - Measurement in networks with nominal voltages up to L-L 480 V and L-N 277 V
 - Current metering range 0 .. 5 Aeff
 - True root mean square measurement (TRMS)
 - Continuous scanning of voltage and current measurement inputs
 - Frequency range of the mains frequency 45 Hz .. 65 Hz
 - Measurement of harmonics 1 to 40 for ULN and I
 - UIn, I, P (import/delivery), Q (ind./cap.).
 - Fourier analyses 1 to 40. Harmonic for U and I.
 - 7 power meter for
 - Active energy (import), Active energy (export), Active energy (without a backstop)
 - Reactive energy (ind.), Reactive energy (capacitive), Reactive energy (without a backstop), Apparent energy, each for L1, L2, L3 and total.
 - 8 tariffs (switching via Modbus)

Measuring method

The UMG 96RM-P/-CBM measures uninterrupted and calculates all root mean squares over a 10/12-period interval. The UMG 96RM-P/-CBM measures the true root mean square (TRMS) of the voltages and currents applied to the measuring inputs.

Operating concept

There are several ways to program the UMG 96RM-P/-CBM and retrieve measured values.

- Directly on the device using two buttons
- Via the programming software of the GridVis
- Through the device's homepage
- Via the RS485 interface with the Modbus protocol.
Data can be changed and retrieved with the help of the Modbus address list (stored on the accompanying data carrier).

These operating instructions only describe the operation of the 96RM-P/-CBM using the 2 buttons.

The programming software of the GridVis has its own "online help".



Additional components that are not included in the scope of deliverables will be required for parameterisation via the RS485 interface.

GridVis network analysis software

The UMG 96RM-P/-CBM can be programmed and read out using the GridVis network analysis software included in the scope of deliverables. A PC must be connected via a serial interface to the USB or RS485 interface of the UMG 96RM-P/-CBM for this (see connection variants).

GridVis features

- Programming the UMG 96RM-P/-CBM
- Graphical representation of measured values

Connection variants

Connecting a UMG 96RM-P or -CBM to a PC via the *USB interface*:

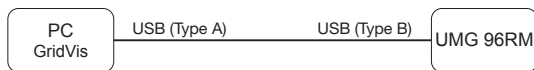

Connecting a UMG 96RM-P or -CBM to a PC via an *interface converter*:

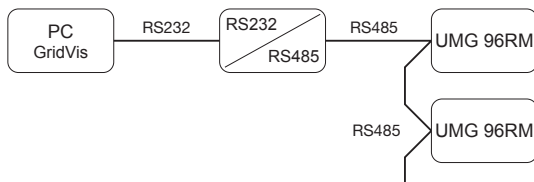

Connecting a UMG 96RM-P or -CBM via a UMG 604 as *gateway*:

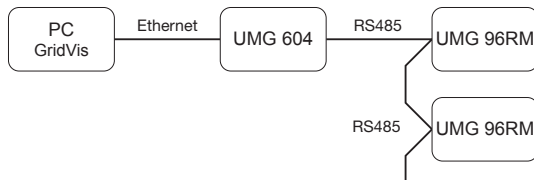

Assembly

Installation location

The UMG 96RM-P/-CBM is suitable for installation in permanent, weatherproof switchboards. Conducting switchboards must be earthed.

Installation position

The UMG 96RM-P/-CBM must be installed vertically in order to achieve sufficient ventilation. The clearance to the top and bottom must be at least 50 mm and 20 mm at the sides.

Front panel cutout

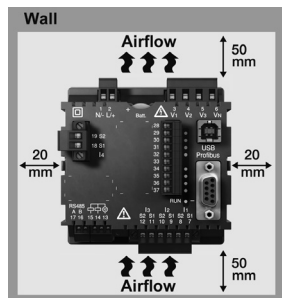

Cutout dimensions:
 $92^{+0.8} \times 92^{+0.8}$ mm.

Fig.
UMG 96RM-P/-CBM
installation location
(rear view)



Failure to comply with the minimum spacing can destroy the UMG 96RM-P/-CBM at high ambient temperatures!

Mounting

The UMG 96RM-P/-CBM is fixed using the mounting clips found on the side of the switch panel. Before inserting the device, they should be moved out of the way in a horizontal lever effect using a screwdriver, for example.

*Fig. side view
UMG 96RM-P/-CBM
with mounting clips.
Loosening the clips is
done using a screwdriver
and a horizontal
lever effect.*

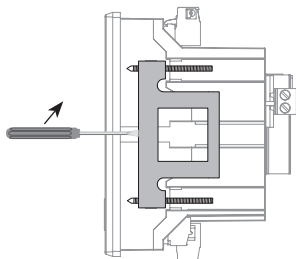

The fastening is then done when the device is pushed in and the clamps lock in place when the screws are tightened.

- Please tight the fixing screws until they contact the mounting plate easily.
- Tighten with two further turns, the clamping screws (are the screws tightened too much, the mounting bracket will be destroyed)

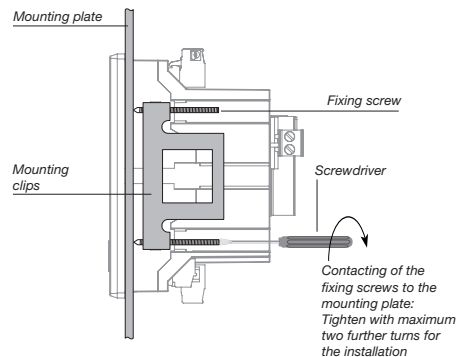

Installation

Supply voltage

A supply voltage is required to operate the UMG 96RM-P/-CBM. The voltage supply is connected via plug-in terminals on the back of the device.

Before applying the supply voltage, ensure that the voltage and frequency correspond with the details on the nameplate!

The supply voltage must be connected via a UL/IEC approved fuse (6A Char. B).



- In building installations, the supply voltage must be provided with a disconnect switch or circuit breaker.
- The disconnect switch must be attached near the device and must be easily accessible by the user.
- The switch must be labelled as a separator for this device.
- Voltages that exceed the permissible voltage range can destroy the device.

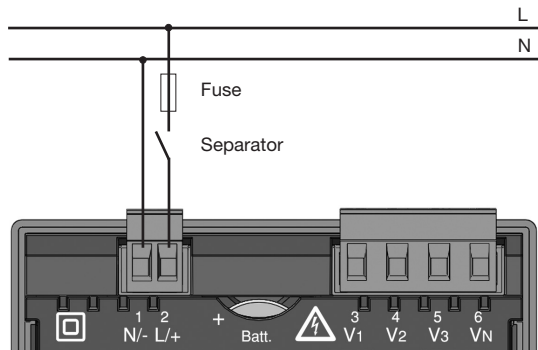

Fig. Connection example of the supply voltage to the UMG 96RM-P/-CBM

Voltage metering

The UMG 96RM-P/-CBM can be used for voltage measurement in TN, TT and IT systems.

Voltage measurement in the UMG 96RM-P/-CBM is designed for the 300 V overvoltage category CATIII (4 kV rated pulse voltage).

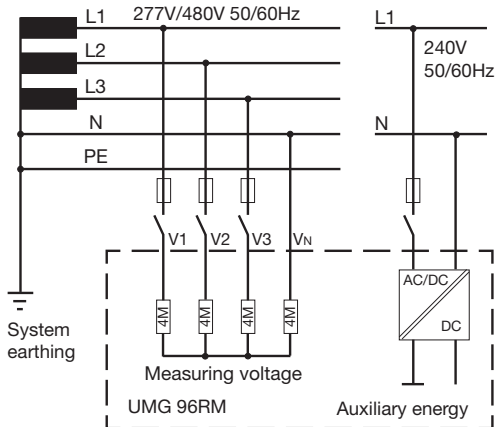

Fig. Principle circuit diagram - Measurement in three-phase 4-wire systems.

In systems without a neutral, measured values that require a neutral refer to a calculated neutral.

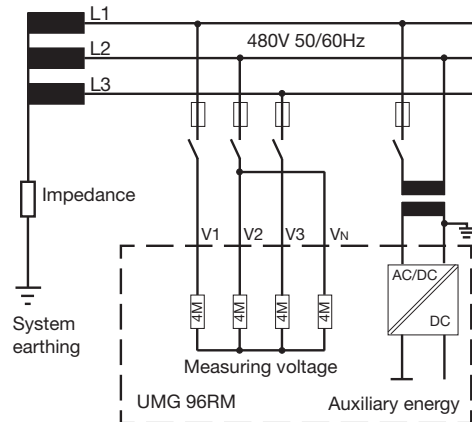

Fig. Principle circuit diagram - Measurement in three-phase 3-wire systems.

Rated mains voltage

Lists of the networks and their rated mains voltage in which the UMG 96RM-P/-CBM can be used.

Three-phase 4-wire systems with earthed neutral conductor.

U_{L-N} / U_{L-L}
66 V/115 V
120 V/208 V
127 V/220 V
220 V/380 V
230 V/400 V
240 V/415 V
260 V/440 V
277 V/480 V

Maximum rated voltage of the network

Fig. Table of the rated mains voltages suitable for the voltage measuring inputs according to EN60664-1:2003.

Unearthed three-phase, 3-wire systems.

U_{L-L}
66 V
120 V
127 V
220 V
230 V
240 V
260 V
277 V
347 V
380 V
400 V
415 V
440 V
480 V

Maximum rated voltage of the network

Fig. Table of the rated mains voltages suitable for the voltage measuring inputs according to EN60664-1:2003.

Voltage measurement inputs

The UMG 96RM-P/-CBM has three voltage measurement inputs (V1, V2, V3).

Overvoltage

The voltage measurement inputs are suitable for measurement in networks in which overvoltages of overvoltage category 300V CATIII (4 kV rated pulse voltage) can occur.

Frequency

The UMG 96RM-P/-CBM requires the mains frequency for the measurement and calculation of measured values.

The UMG 96RM-P/-CBM is suitable for measurements in the frequency range of 45 to 65 Hz.

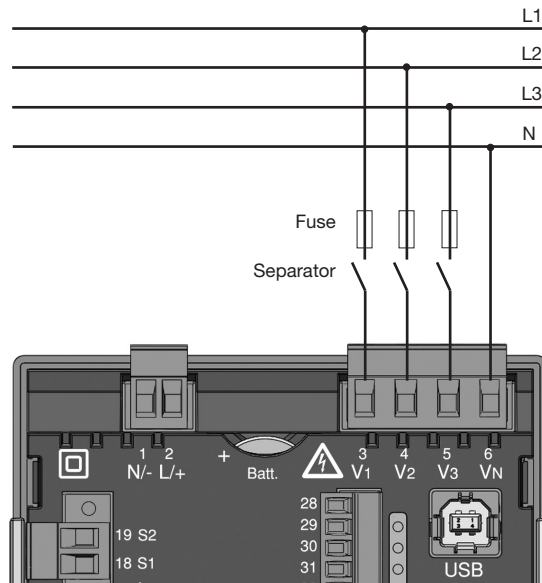

Fig. Connection example for the voltage measurement

When connecting the voltage to be measured, the following must be observed:

Isolation device

- A suitable circuit breaker must be fitted to disconnect and de-energise the UMG 96RM-P/-CBM.
- The circuit breaker must be placed in the vicinity of the UMG 96RM-P/-CBM., be marked for the user and easily accessible.
- The circuit breaker must be UL/IEC certified.

Overcurrent protection device

- An overcurrent protection device must be used for line protection.
- For line protection, we recommend an overcurrent protection device as per the technical specifications.
- The overcurrent protection device must be suitable for the line cross section used.
- The overcurrent protection device must be UL/IEC certified.
- A circuit breaker can be used as an isolating and line protection device. The circuit breaker must be UL/IEC certified.
- Measured voltages and measured currents must derive from the same network.



Attention!

Voltages that exceed the permitted rated mains voltages must be connected via voltage transformers.



Attention!

The UMG 96RM-P/-CBM is not suitable for the measurement of DC voltages.



Attention!

The voltage measurement inputs on the UMG 96RM-P/-CBM are dangerous to touch!

Connection diagram, voltage measurement

- 3p 4w (addr. 509 = 0), factory setting

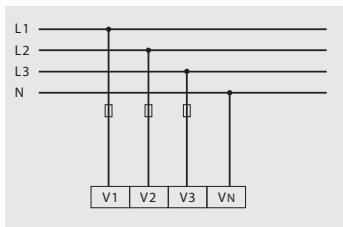

Fig. System with three-phase conductors and a neutral conductor.

- 3p 4u (addr. 509 = 2)

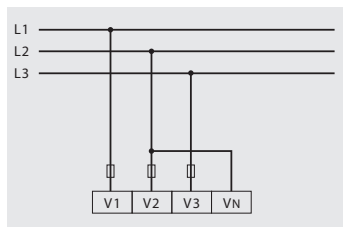

Fig. System with three-phase conductors and no neutral conductor. Measured values that require a neutral refer to a calculated neutral.

- 3p 4wu (addr. 509 = 1)

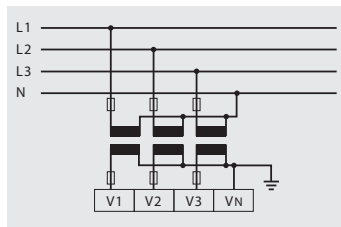

Fig. System with three-phase conductors and a neutral conductor. Measurement via voltage transformer.

- 3p 2u (addr. 509 = 5)

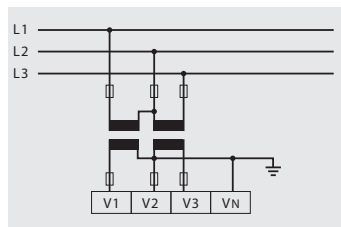

Fig. System with three-phase conductors and no neutral conductor. Measurement via voltage transformer. Measured values that require a neutral refer to a calculated neutral.

- 1p 2w1 (addr. 509 = 4)

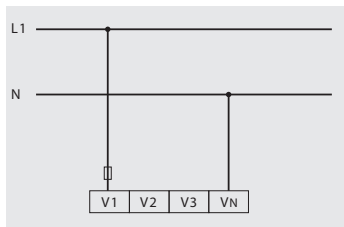

Fig. Measured values derived from the V2 and V3 voltage measurement inputs are assumed to be zero and not calculated.

- 1p 2w (addr. 509 = 6)

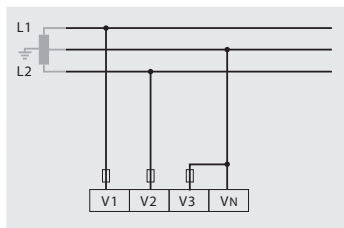

Fig. TN-C system with single-phase, three-wire connection. Measured values derived from the V3 voltage measurement input Zero are assumed to be zero and not calculated.

- 2p 4w (addr. 509 = 3)

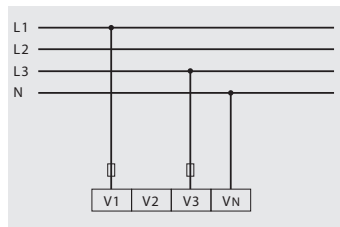

Fig. System with uniform phase loading. The measured values for the V2 voltage measurement input are calculated.

- 3p 1w (addr. 509 = 7)

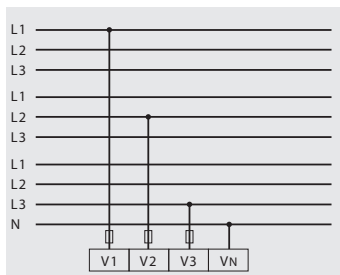

Fig. Three systems with uniform phase loading. The measurement values L2/L3 resp. L1/L3 resp. L1/L2 of the respective system are calculated.

Current measurement via I1 to I4

The UMG 96RM-P/-CBM is designed to have current transformers with secondary currents from $..1A$ and $..5A$ attached via terminals I1-I4. The factory default for the current transformer ratio is $5/5A$ and must be adapted to the current transformer employed if necessary.

Direct measurement without a current transformer is not possible using the UMG 96RM-P/-CBM.

Only AC currents can be measured - DC currents cannot.

Via the **current measurement input I4** only an apparent current measurement is carried out thanks to the lack of a multiplier. Power measurements are therefore not possible using the I4 input.

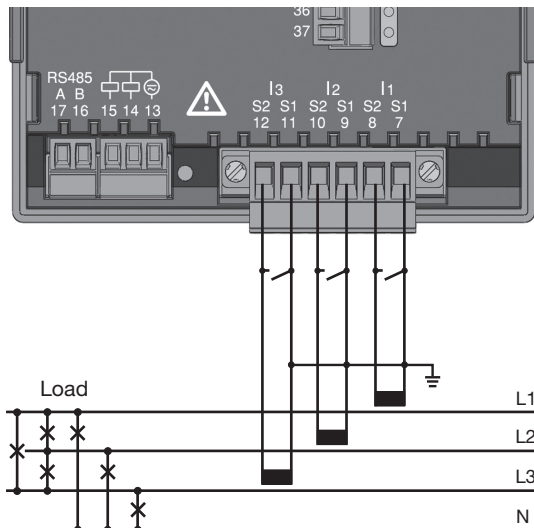

Fig. Current measurement (I1-I3) via current transformers (connection example)



Caution!

The test leads must be designed for an operating temperature of at least $80^{\circ}C$.



Caution!

The current measurement inputs are dangerous to touch.



The attached screw terminal has to be fixed sufficiently with two screws on the device!



Earthing of current transformers!

If a connection is provided for the earthing of secondary windings then this must be connected to the earth.



Caution!

The UMG 96RM-P/-CBM is not suitable for measuring DC voltages.



It is not necessary to configure a connection schematic for the I4 measurement input.

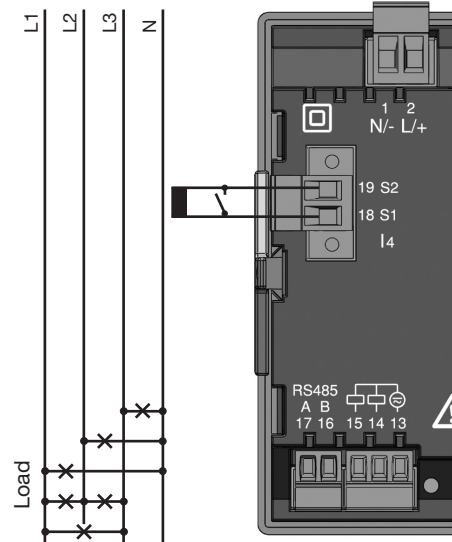

Fig. Current measurement (I4) via current transformer (connection example)

Direction of the current

The current direction can be individually corrected on the device or via the serial interfaces for each phase. In the case of incorrect connection, the current transformer does not need to be subsequently reconnected.



Current transformer connections!

The secondary connection of the current transformer must be short-circuited on this before the current feed to the UMG 96RM-P/-CBM is disconnected!

If a test switch, which automatically short-circuits the secondary wires of the current transformer, is available then it is sufficient to set this to the „Test“ position insofar as the short-circuiting device has been checked beforehand.



Open-circuit current transformers!

High voltage spikes that are dangerous to touch can occur on current transformers that are driven with open-circuit secondary windings!

With „safe open-circuit current transformers“ the winding insulation is rated such that the current transformer can be driven open. However, even these current transformers are dangerous to touch when they are driven open-circuit.



Caution!

The UMG96RM is only approved for a current measurement using the current transformer.

Connection diagram, current measurement

- 3p 4w (addr. 510 = 0), factory setting

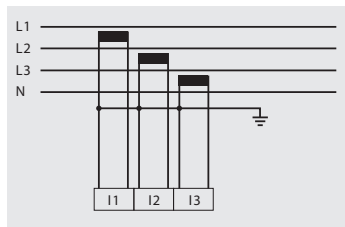

Fig. Measurement in a three-phase net-work with an unbalanced load.

- 3p 2i (addr. 510 = 1)

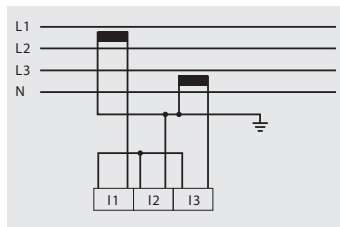

Fig. System with uniform phase loading. The measured values for the I2 current measurement input are measured.

- 3p 2i0 (addr. 510 = 2)

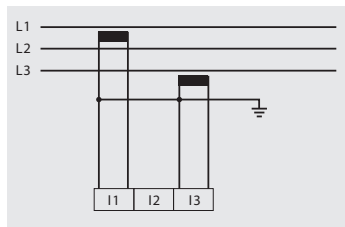

Fig. The measured values for the I2 current measurement input are calculated.

- 3p 3w3 (addr. 510 = 3)

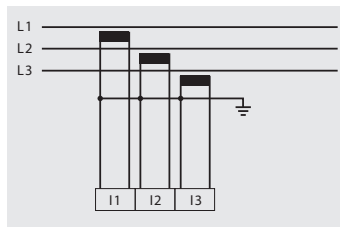

Fig. Measurement in a three-phase net-work with an unbalanced load.

- 3p 3w (addr. 510 = 4)

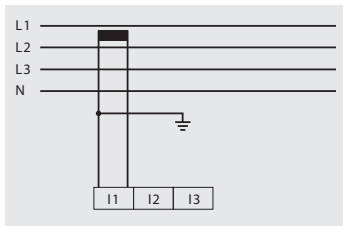

Fig. System with uniform phase loading. The measured values for the I2 and I3 current measurement inputs are calculated.

- 2p 4w (addr. 510 = 5)

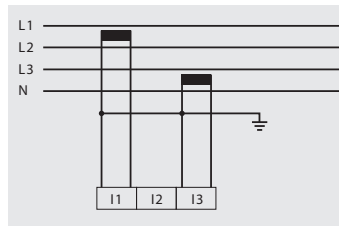

Fig. System with uniform phase loading. The measured values for the I2 current measurement input are calculated.

- 1p 2i (addr. 510 = 6)

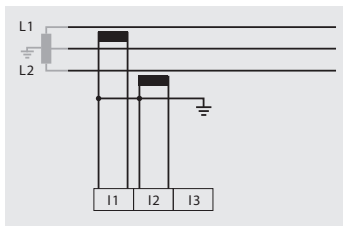

Fig. Measured values derived from the I3 current measurement input are assumed to be zero and not calculated.

- 1p 2w (addr. 510 = 7)

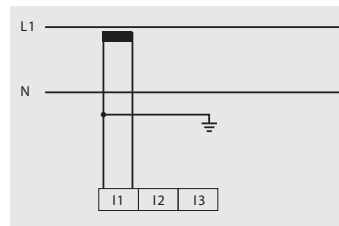

Fig. Measured values derived from the I2 and I3 current measurement inputs are assumed to be zero and not calculated.

Connection diagram, current measurement

- 3p 1w (addr. 510 = 8)

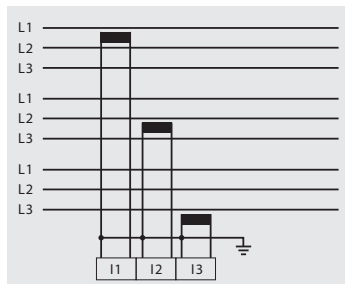

Fig. Three systems with uniform phase loading. The current measurement values of the phases of the respective system where no CTs connected are calculated (I2/I3 resp. I1/I3 resp. I1/I2).

Total current measurement

If the current measurement takes place via two current transformers, the total transformer ratio of the current transformer must be programmed in the UMG 96RM-P/-CBM.

Example: The current measurement takes place via two current transformers. Both current transformers have a transformer ratio of 1000/5 A. The total measurement is performed with a 5+5/5 A total current transformer.

The UMG 96RM-P/-CBM must then be set as follows:

Primary current: $1000 \text{ A} + 1000 \text{ A} = 2000 \text{ A}$
 Secondary current: 5 A

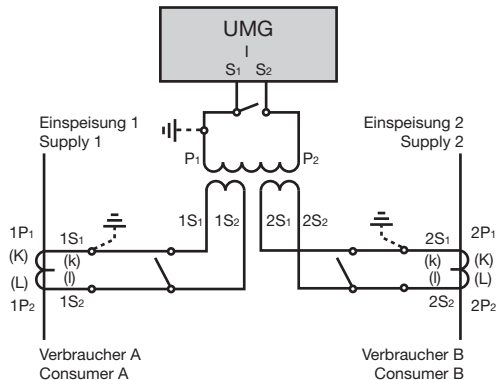

Fig. Current measurement via a total current transformer (example).

Ammeter

If you want to measure the current not only with the UMG 96RM-P/-CBM but also with the ammeter, the ammeter must be connected in series with the UMG 96RM-P/-CBM.

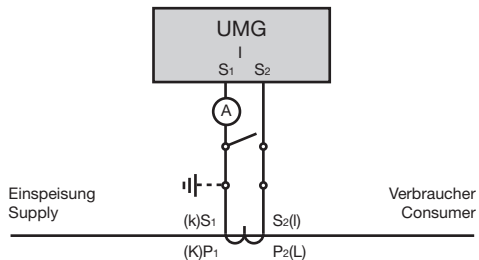
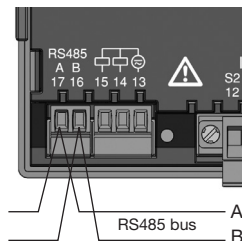

Fig. Current measurement with an additional ammeter (example).

RS485 interface

The RS485 interface is designed with the UMG 96RM-P/-CBM as a 2-pole plug contact and communicates via the Modbus RTU protocol (also see programming parameters).



RS485 interface,
2-pole plug contact

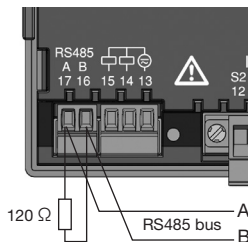

RS485 interface,
2-pole plug contact
with terminating resistor
(Item no. 52.00.008)

Terminating resistors

The cable is terminated with resistors (120 ohm 1/4 W) at the beginning and end of a segment.

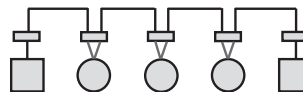

The UMG 96RM-P/-CBM has no terminating resistors.

Correct

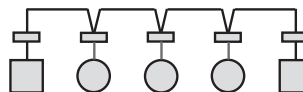

Incorrect



-  Terminal block in the switch cabinet.
-  Device with RS485 interface.
(without a terminating resistor)
-  Device with RS485 interface.
(with terminating resistor on the device)

Shielding

A twisted and shielded cable must be provided for connections via the RS485 interface.

- Ground the shields of all cables that run into the cabinet at the cabinet entry.
- Connect the shield so it has a large contact area and conductively with a low-noise earth.
- Mechanically trap the cable above the earthing clamp in order to avoid damage from cable movement.
- Use the appropriate cable inlets, e.g. PG screw joints, to insert the cable into the switch cabinet.



For the wiring of the Modbus connection, CAT cables are not suitable. Please use the recommended cables.

Cable type

The cable used must be suitable for an ambient temperature of at least 80 °C.

Recommended cable types:

Unitronic Li2YCY(TP) 2x2x0.22 (Lapp cable)

Unitronic BUS L2/FIP 1x2x0.64 (Lapp cable)

Maximum cable length

1200 m with a baud rate of 38.4 k.

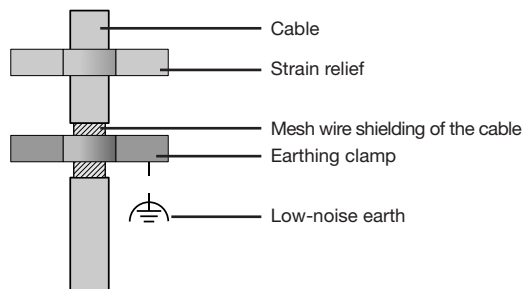

Fig. Shielding design for cabinet entry.

Bus structure

- All devices are connected in a bus structure (line) and each device has its own address within the bus (also see programming parameters).
- Up to 32 stations can be interconnected in one segment.
- The cable is terminated with resistors (bus termination, 120 ohm 1/4 W) at the beginning and end of a segment.
- If there are more than 32 stations, repeaters (line amplifiers) must be used in order to connect the individual segments.
- Devices with activated bus termination must be supplied with power.
- It is recommended to set the master at the end of a segment.
- The bus is inoperative if the master is replaced with an activated bus termination.
- The bus can become unstable if the slave is replaced with an activated bus termination or is dead.
- Devices that are not involved in the bus termination can be exchanged without making the bus unstable.
- The shield has to be installed continuously and needs to be broadly and well conducting connected to an external low voltage (or potential) ground at the end.

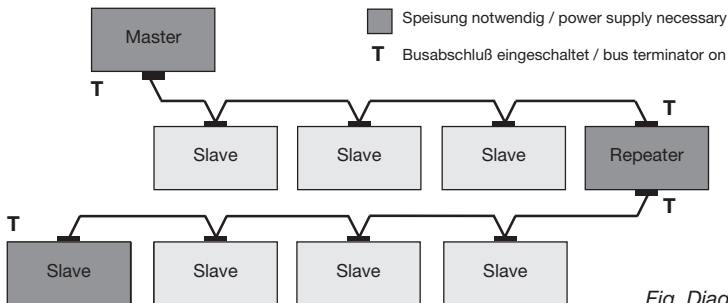
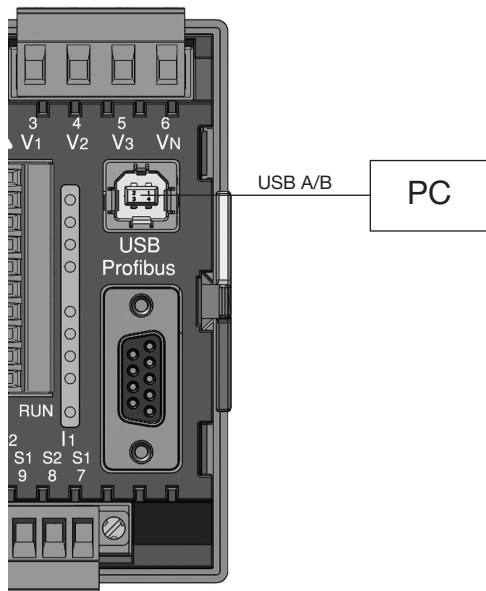

Fig. Diagram of bus structure

USB interface

The Universal Serial Bus (USB) enables a rapid and uncomplicated connection between the device and a computer. After the installation of the USB driver the device data can be read out via the GridVis software and firmware updates can be installed.

The USB2.0 connection cable with A/B connectors included in the scope of deliverables is required for the USB connection of the device to the USB interface of the computer.



The cable length of the USB connection should not exceed 5m.

Profibus interface (only UMG 96RM-P)

This 9-pin D-sub receptacle RS485 interface supports the Profibus DP V0 slave protocol.

For the simple connection of inbound and outbound bus wiring these should be connected to the UMG 96RM-P via a Profibus connector.

For the connection we recommend a 9-pin Profibus connector, e.g. type „SUBCON-Plus-ProfiB/AX/SC“ from Phoenix, item number 2744380. (Janitza item no:13.10.539)



The device address can be configured by using the parameter 000 if the device is used in a Profibus-System.

The baud rate in a Profibus system is detected automatically and must NOT be set via the address 001!

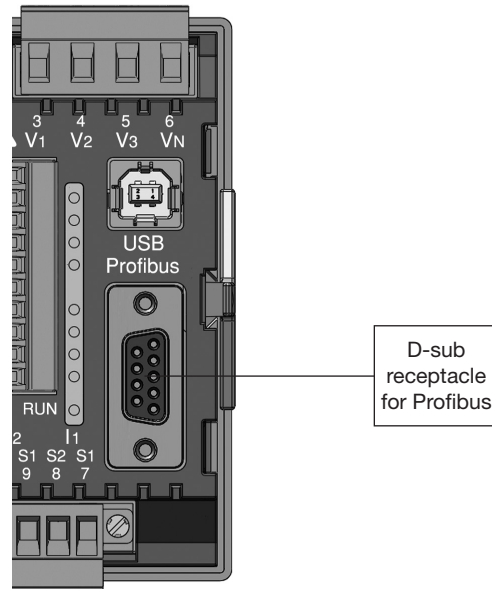

Fig. UMG 96RM-P with D-sub receptacle for Profibus (View on rear).

Connection of the bus wiring

The inbound bus wiring is connected to terminals 1A and 1B of the Profibus connector. The continuing bus wiring for the next device in line should be connected to terminals 2A and 2B.

If there are no subsequent devices in the line then the bus wiring must be terminated with a resistor (switch to ON).

With the switch set to ON terminals 2A and 2B are switched off for further continuing bus wiring.

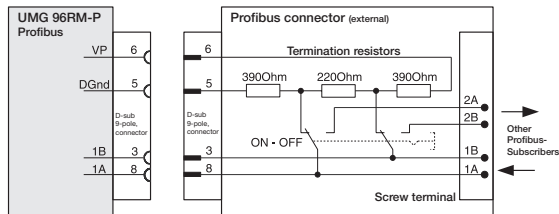

Fig. Profibus connector with termination resistors.

Transfer speeds in Kbit/s	Max. segment length
9.6; 19.2; 45.45; 93.75	1200m
187.5	1000m
500	400m
1500	200m
3000; 6000; 12000	100m

Table: Segment lengths per Profibus specification.

Digital outputs

The UMG 96RM-P and UMG 96RM-CBM have 6 digital outputs, whereby these are split into two groups of 2 and 4 outputs (see illustration on the right).

Digital outputs, Group 1

- The status indicator appears on the display at K1 or K2
- The status indicator on the display is not dependent on an inversion being activated (NC / NO)

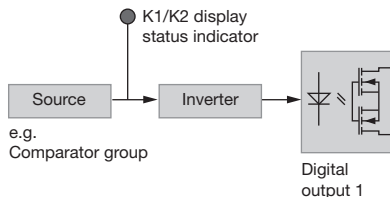

Digital outputs, Group 2

- The status of the inputs and outputs in Group 2 is indicated by the associated LED (cf. chapter LED status bar).

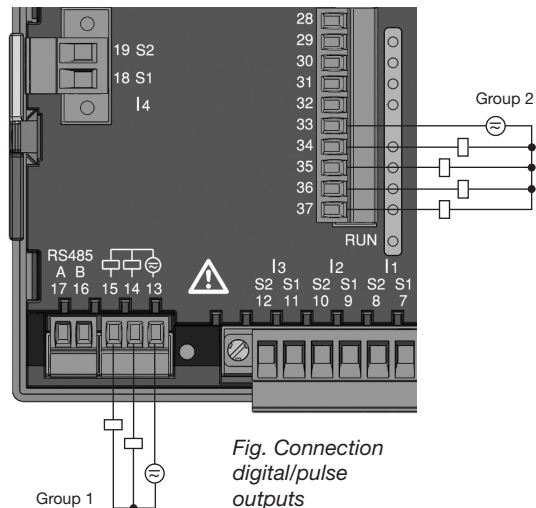

Fig. Connection digital/pulse outputs

These outputs are electrically isolated from the evaluation electronics by optocouplers. The digital outputs have a common reference.

- The digital outputs of group 1 can switch DC and AC loads. The digital outputs of group 2 can **not** switch AC loads.
- The digital outputs are **not** short circuit protected.
- Connected cables longer than 30 m must be shielded.
- An external auxiliary voltage is required.
- The digital outputs can be used as pulse outputs.
- The digital outputs can be controlled via the Modbus.
- The digital outputs can output results from comparators.



When using the digital outputs as pulse outputs the auxiliary voltage (DC) must have a max. residual ripple of 5%.



Functions for the digital outputs can be adjusted clearly in the GridVis software provided in the scope of deliverables. A connection between the UMG 96RM-P/-CBM and the PC via an interface is required for the use of the GridVis software.

DC connection example

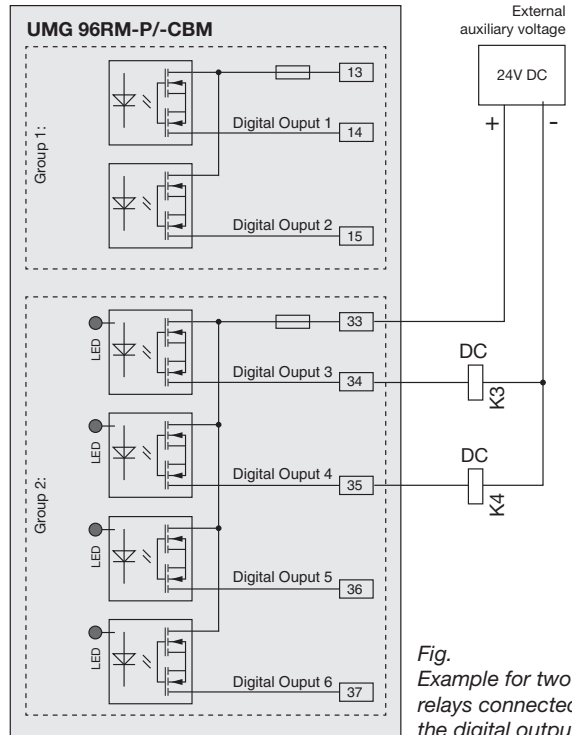

Fig. Example for two relays connected to the digital outputs

Digital inputs

The UMG 96RM-P and UMG96RM-CBM have 4 digital inputs, each of which can have a signal transducer connected.

On a digital input an input signal is detected if a voltage of at least 10V and maximum 28V is applied and where a current of at least 1mA and maximum 6mA flows at the same time. Wiring longer than 30m must be screened.

Note the correct polarity of the supply voltage!

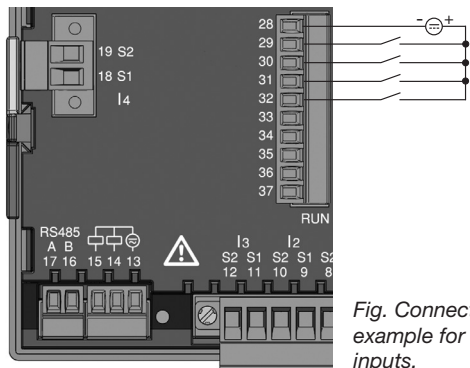

Fig. Connection example for digital inputs.

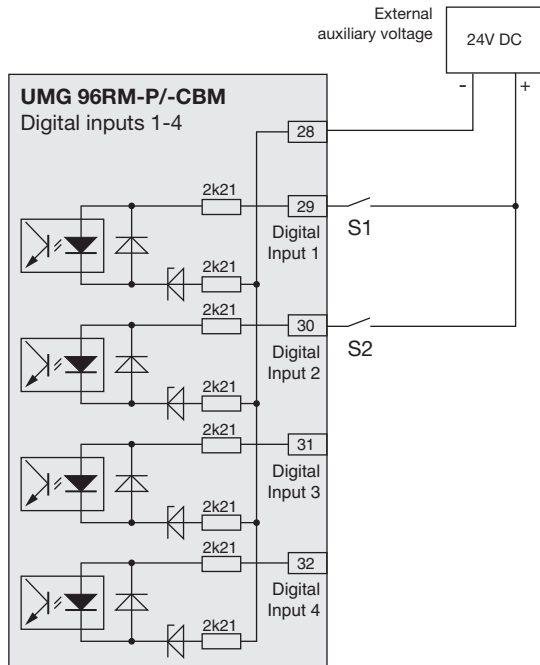

Fig. Example for the connection of external switch contacts S1 and S2 to digital inputs 1 and 2.

S0 pulse input

You can connect an S0 pulse transducer per DIN EN62053-31 to any digital input.

This requires an auxiliary voltage with an output voltage in the range 20 .. 28V DC and a resistor of 1.5kOhm.

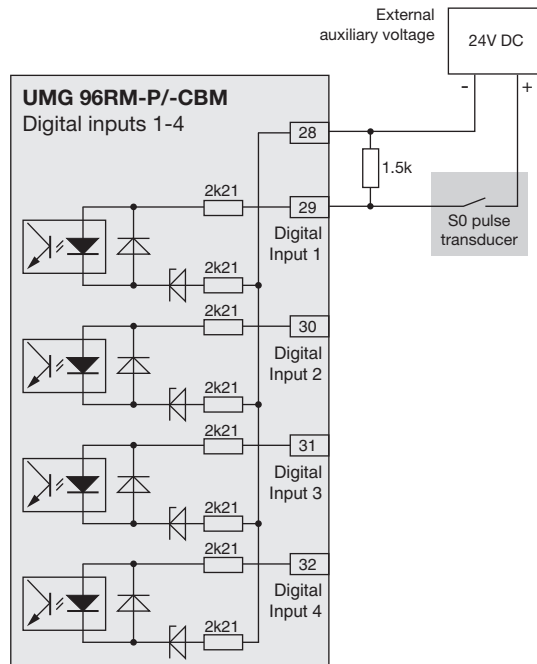

Fig. Example for the connection of an S0 pulse transducer to digital input 1.

LED status bar

The different statuses of the inputs and outputs are displayed via the LED status bar on the rear of the device.

Digital inputs

The LED associated with the respective input illuminates green if there is a signal of at least 1mA flowing through the interface.

Digital outputs

The LED associated with the respective output illuminates green if the output is active - independent of whether there is a connection on the interface.

Profibus (only UMG 96RM-P variant)

The LED associated with the Profibus provides comprehensive information by means of a red or green illumination and a flashing frequency, in accordance with table 5.1.

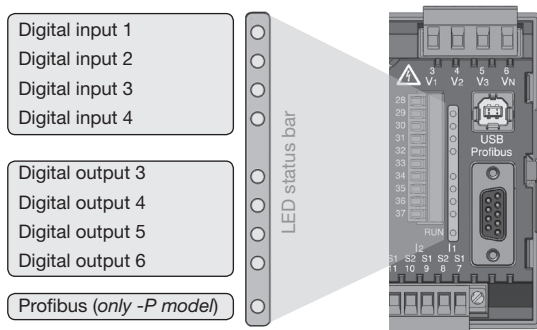

Fig. LED status bar for inputs and outputs

Profibus status LED			
Flashing frequency	Red	Green	Status
Illuminates steadily	x	-	Still no contact with PLC
Slowly (approx. 1x per sec.)	x	-	Fault in the configuration data
Very slowly (approx. 1x per 2 sec.)	x	-	Fault with data exchange
Illuminates steadily	-	x	Data exchange with the PLC
Quickly (approx. 3x per sec.)	-	x	UMG waiting on parameterising data
Slowly (approx. 1x per sec.)	-	x	UMG waiting on configuration data

Table: 5.1. LED status bar for inputs and outputs

x = active - = passive



The status "UMG waiting on configuration data" occurs if there is no PLC connected

Operation

The UMG 96RM-P/-CBM is operated using buttons 1 and 2. Measured values and programming data appears on a liquid crystal display.

A distinction is made between *display mode* and *programming mode*. The accidental changing of programming data is prevented by the entry of a password.

Display mode

In the display mode, you can scroll between the programmed measured value displays using buttons 1 and 2. All factory-set measured value displays listed in section 1 can be called up. Up to three measured values are displayed per measured value display. The measured value relaying allows select measured value displays to be shown alternately after a settable changeover time.

Programming mode

In the programming mode, the settings required for operating the UMG 96RM-P/-CBM can be displayed and changed. Pressing buttons 1 and 2 simultaneously for about one second calls up the programming mode after the password prompt. If no user password was

programmed, the user arrives directly in the first programming menu. Programming mode is indicated by the text "PRG" on the display.

Button 2 can now be used to switch between the following programming menus:

- current transformer,
- voltage transformer,
- parameter list.

If the device is in programming mode and no button has been pressed for approximately 60 seconds or if buttons 1 and 2 are pressed simultaneously for approx. one second, the UMG 96RM-P/-CBM returns to display mode.

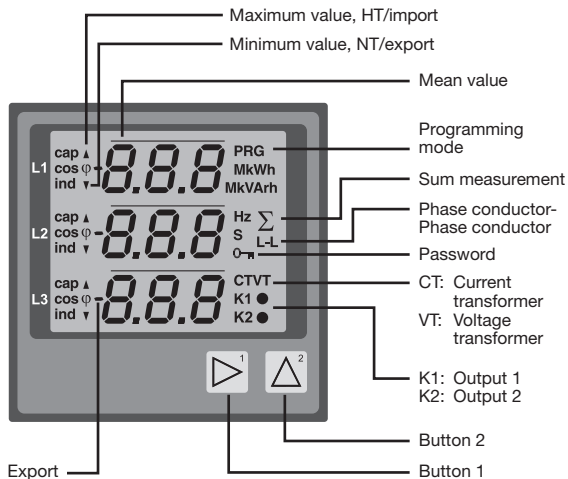

Parameters and measured values

All parameters necessary for operating the UMG 96RM-P/-CBM, e.g. the current transformer data, and a selection of frequently required measured values are stored in the table.

The contents of most addresses can be accessed via the serial interface and the buttons on the UMG 96RM-P/-CBM.

Only the first 3 significant digits of a value can be entered on the device. Values with more digits can be entered using GridVis.

The device always only displays the first 3 significant digits of a value.

Selected measured values are summarised in measured value display profiles and can be shown in display mode using buttons 1 and 2.

The current measured value display profile and the current display change profile can only be read and changed via the RS485 interface.

Example of the parameter display

On the UMG 96RM-P/-CBM display the value “001” is shown as the content of address “000”. This parameter reflects the device address (here “001”) of the UMG 96RM-P/-CBM on a bus in list form.



Example of the measured value display

In this example, the UMG 96RM-P/-CBM display shows the voltages L to N with 230 V each.

The K1 and K2 transistor outputs are conductive and current can flow.

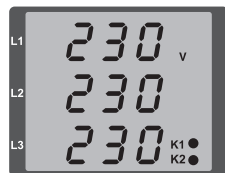

Button functions

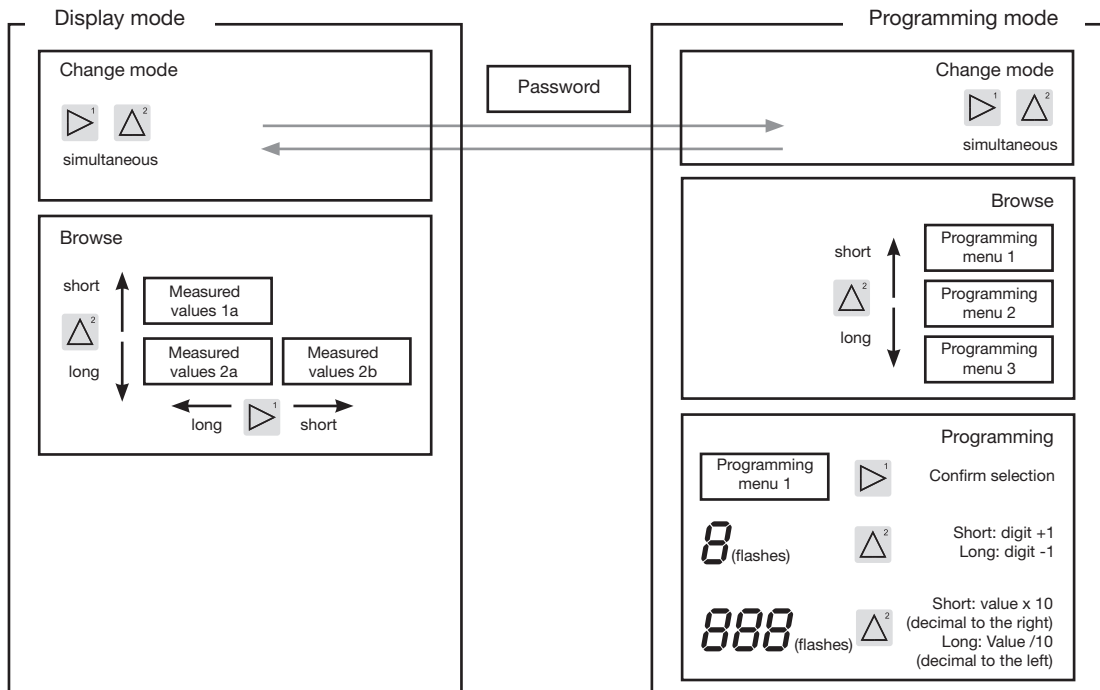

Configuration

Applying the supply voltage

To configure the UMG 96RM-P/-CBM, the supply voltage must be connected.

The level of supply voltage for the UMG 96RM-P/-CBM can be found on the nameplate.

If no display appears, check the operating voltage to determine whether it is within the rated voltage range.

Current and voltage transformers

A current transformer is set to 5/5 A in the factory. The pre-programmed voltage transformer ratio only needs to be changed if voltage transformers are connected.

When connecting voltage transformers, the measurement voltage on the UMG 96RM-P/-CBM nameplate must be observed!



Attention!

Supply voltages that do not correspond to the nameplate information can lead to device malfunction or destruction.



The adjustable value 0 for the primary current transformer does not produce any useful energy values and must not be used.



Devices, which are programmed to automatic frequency detection, need approximately 20 seconds to detect grid frequency. During this period, the measured values do not keep the confirmed measuring accuracy.



Prior to commissioning potential production dependant contents of the energy counter, min/max values and records have to be deleted.



Current and voltage transformers

The transformer ratios for each of the three current and voltage measurement inputs can be individually programmed in the GridVis software included in the scope of delivery. Only the transformer ratio of the respective group of current measurement inputs or voltage measurement inputs is adjustable on the device.

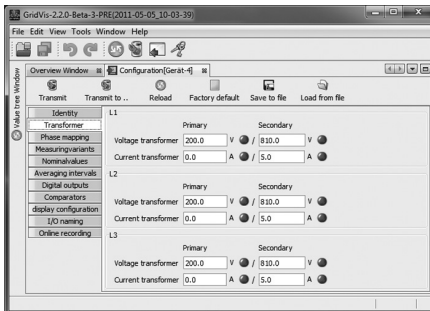

Fig. Display for configuring the current and voltage transformers in the GridVis software.

Programming current transformers

Switching to programming mode

- Simultaneously press buttons 1 and 2 in order to switch to programming mode. If a user password was programmed, the password request will appear with "000". The first digit of the user password flashes and can be changed with button 2. The next digit is selected by pressing button 1 and will begin flashing. If the correct combination was entered or if no user password was programmed, the device will enter programming mode.
- The symbols for the programming mode (PRG) and for the current transformer (CT) appear.
- Confirm the selection with button 1.
- The first digit of the input area for the primary current starts flashing.

Current transformer primary current input

- Change the flashing digit with button 2.
- Select the next digit to be changed with button 1. The selected digit to be changed starts flashing. If the entire number is flashing, the decimal point can be moved with button 2.

Current transformer secondary current input

- Only 1 A or 5 A can be set as the secondary current.
- Select the secondary current with button 1.
- Change the flashing digit with button 2.

Leaving programming mode

- Simultaneously press buttons 1 and 2 to exit the programming mode.

Programming voltage transformers

- Switch to the programming mode as described. The symbols for the programming mode (PRG) and for the current transformer (CT) appear.
- Use button 2 to switch to the voltage transformer setting.
- Confirm the selection with button 1.
- The first digit of the input area for the primary current starts flashing. The ratio of primary to secondary voltage of the voltage transformer can be set in the same way as the assignment of the current transformer ratio of primary to secondary current.

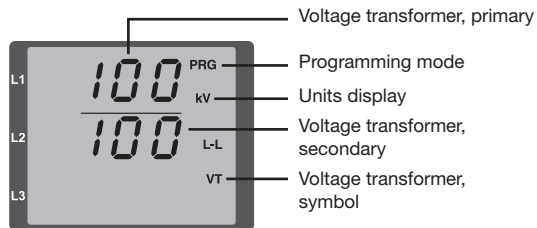
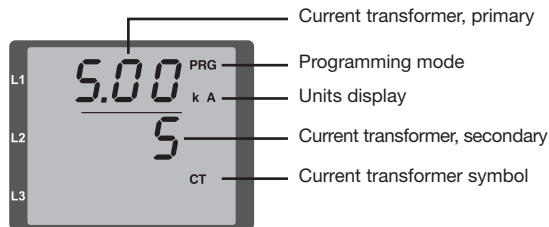

Programming parameters

Switching to programming mode

- Switch to the programming mode as described. The symbols for the programming mode (PRG) and for the current transformer (CT) appear.
- Use button 2 to switch to the voltage transformer setting. The first parameter of the parameter list is shown by repeatedly pressing button 2.

Changing parameters

- Confirm the selection with button 1.
- The most recently selected address is displayed with the associated value.
- The first digit of the address flashes and can be changed using button 2. Button 1 provides a selection of digits that, in turn, can be changed with button 2.

Changing the value

- Once the desired address is set, a digit of the value is selected with button 1 and changed with button 2.

Leaving programming mode

- Simultaneously press buttons 1 and 2 to exit the programming mode.



Fig. Password request
If a password was set, it can be entered using buttons 1 and 2.



Fig. Current transformer programming mode
The primary and secondary currents can be changed using buttons 1 and 2 (cf. page 52).



Fig. Programming mode Voltage transformer
The primary and secondary currents can be changed using buttons 1 and 2 (cf. page 53).



Fig. Programming mode Parameter display
The individual parameters can be changed using buttons 1 and 2 (cf. page 48).

Device address (addr. 000)

If several devices are connected to one another via the RS485 interface, a master device can only differentiate between these devices by means of their device addresses. Therefore, each device in a network must have a different device address. Addresses can be set in the range from 1 to 247.



The adjustable range of the device address is between 0 and 255. The values 0 and 248 to 255 are reserved and may not be used.

Baud rate (addr. 001)

A common baud rate is adjustable for the RS485 interfaces. The baud rate must be chosen to be a uniform value in the network. On address 003 the quantity of stop bits can be set (0=1bit, 1=2bits). Data bits (8) are permanently set.

Setting	Baud rate
0	9.6 kbps
1	19.2 kbps
2	38.4 kbps
3	57.6 kbps
4	115.2 kbps (factory setting)

Mean value

Mean values are formed over an adjustable period for the current, voltage and power measured values. The mean values are identified with a bar above the measured value.

The averaging time can be selected from a list of nine fixed averaging times.

Current averaging time (addr. 040)**Power averaging time (addr. 041)****Voltage averaging time (addr. 042)**

Setting	Averaging time/sec.
0	5
1	10
2	15
3	30
4	60
5	300
6	480 (factory setting)
7	600
8	900

Averaging method

After the set averaging time, the exponential averaging method used achieves at least 95% of the measured value.

Minimum and maximum values

All measured values are measured and calculated every 10/12 periods. Minimum and maximum values are determined for most of the measured values.

The minimum value is the smallest measured value that has been determined since the last reset. The maximum value is the largest measured value that has been determined since the last clearance. All minimum and maximum values are compared with the corresponding measured values and are overwritten if they are undercut or exceeded.

The minimum and maximum values are stored in an EEPROM every 5 minutes, without the date and time. This means that if the operating voltage fails, only the minimum and maximum values of the last 5 minutes are lost.

Clearing minimum and maximum values (addr. 506)

If "001" is written to the address 506, all minimum and maximum values are simultaneously cleared.

Mains frequency (addr. 034)

For automatic ascertainment of the mains frequency, an L1-N voltage larger than 10V_{eff} must be applied to the voltage measurement input V1.

The mains frequency is then used to calculate the sampling rate for the current and voltage inputs.

If there is no measurement voltage, the mains frequency cannot be determined and thus no sampling rate can be calculated. The acknowledgeable error message "500" appears.

The voltage, current and all other resulting values are calculated based on the previous frequency measurement and possible cable-connecting sockets and continue to be displayed. However, these derived measured values are no longer subject to the specified accuracy.

If it is possible to re-measure the frequency, then the error message will disappear automatically after a period of approx. 5 seconds once the voltage has been restored.

The error is not displayed if a fixed frequency has been configured.

Adjustment range: 0, 45 .. 65

0 = automatic frequency determination.
The mains frequency is determined from the measurement voltage.

45..65 = fixed frequency
The mains frequency is preselected.

Energy meter

The UMG 96RM-P/-CBM has energy meters for active energy, reactive energy and apparent energy.

Reading the active energy

Total active energy

The active energy in this example is: 12 345 678 kWh

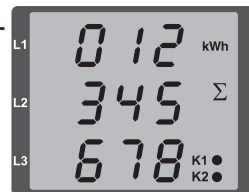

The active energy in this example is: 134 178 kWh

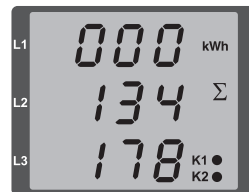

Harmonics

Harmonics are the integer multiple of a mains frequency. The voltage mains frequency for the UMG 96RM-P/-CBM must be in the range between 45 and 65 Hz. The calculated voltage and current harmonics refer to this mains frequency.

Harmonics up to 40x the mains frequency are recorded.

The harmonics for currents are given in amperes and the harmonics for voltages are given in volts.

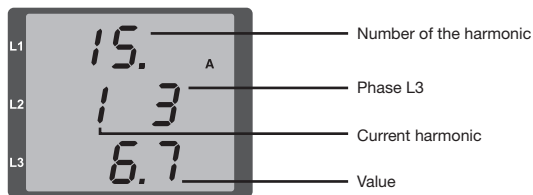

Fig. Display of the 15th harmonic of the current in the L3 phase (example).



Harmonics are not displayed in the factory default setting.

Total Harmonic Distortion (THD)

THD is the ratio of the root mean square value of harmonics to the root mean square value of the mains frequency.

Total Harmonic Distortion of the current (THD_I):

$$THD_I = \frac{1}{|I_{fund}|} \sqrt{\sum_{n=2}^M |I_{n,Harm}|^2}$$

Total Harmonic Distortion of the voltage (THD_U):

$$THD_U = \frac{1}{|U_{fund}|} \sqrt{\sum_{n=2}^M |U_{n,Harm}|^2}$$

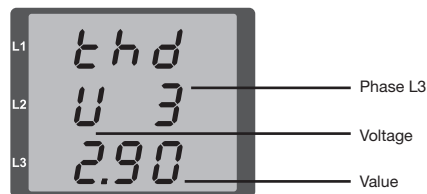

Fig. Display of the total harmonic distortion of the voltage from the L3 phase (example).

Measured value relay

All measured values are calculated every 10/12 periods and can be recalled once per second on the measured value displays. Two methods are available for retrieving the measured value displays:

- The automatically changing display of selected measured values, referred to here as measured value relaying.
- Selection of a measured value display using buttons 1 and 2 from a preselected display profile.

Both methods are simultaneously available. Measured value relaying is active if at least one measured value display is programmed with a changeover time greater than 0 seconds.

If a button is pressed, the measured value displays of the selected display profile can be browsed. If no button is pressed for about 60 seconds, the device switches to the measured value relay and the measured values from the selected display change profile of the programmed measured value displays are shown one after the other.

Changeover time (addr. 039)

Adjustment range: 0 .. 60 seconds

If 0 seconds are set, no changeover takes place between the measured value displays selected for the measured value relay.

The changeover time applies for all display change profiles.

Display change profile (addr. 038)

Adjustment range: 0 .. 3

0 - Display changeover profile 1, by default.

1 - Display changeover profile 2, by default.

2 - Display changeover profile 3, by default.

3 - Customised display changeover profile.

Measured value displays

After return of the power supply, the UMG 96RM-P/-CBM shows the first measured value panel from the current display profile. In order to keep the selection of measured values to be displayed arranged in a clear manner, only one part of the available measured values is pre-programmed for recall in the measured value display by default. A different display profile can be selected if other measured values are required to be shown on the UMG 96RM-P/-CBM display.

Display profile (addr. 037)

Adjustment range: 0 .. 3

- 0 - Display profile 1, default setting.
- 1 - Display profile 2, default setting.
- 2 - Display profile 3, default setting.
- 3 - Customised display profile.



The customised profiles (display change profile and display profile) can only be programmed via the GridVis software.



Profile settings

The profiles (display change profile and display profile) are clearly shown in the GridVis software included in the scope of delivery. The profiles can be adjusted in the software via the device configuration; customised display profiles can also be programmed. A connection between the UMG 96RM-P/-CBM and the PC via the serial interface (RS485) is required for using the GridVis software. This requires an interface converter RS485/232, item no. 15.06.015 or RS485/USB, item no. 15.06.025.

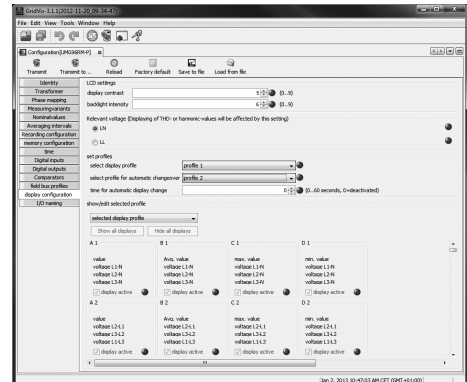

Fig. Display of the profile setting in the GridVis software.

User password (addr. 050)

A user password can be programmed in order to impede any accidental change to programming data. A switch to the next programming menu can only be made after entering the correct user password.

No user password is specified in the factory. In this case, the password menu is skipped and the current transformer menu is reached directly.

If a user password was programmed, the password menu will appear with the display "000".

The first digit of the user password flashes and can be changed with button 2. The next digit is selected by pressing button 1 and will begin flashing.

The programming menu for the current transformer can only be accessed after entering the correct number combination.

Forgotten password

If you have forgotten the password, the password can only be cleared by using the GridVis PC software.

To do this, connect the UMG 96RM-P/-CBM to the PC via a suitable interface. More information can be found in the help section of GridVis.

Clear energy meter (addr. 507)

The active, apparent and reactive energy meters can only be cleared together.

Address 507 must be written with "001" in order to clear the contents of the energy meters.



Prior to commissioning potential production dependant contents of the energy counter, min/max values and records have to be deleted.



Clearing the energy meters means this data in the device is gone. In order to avoid possible data loss, read and save the measured values with the GridVis software before clearing.

Rotation field direction

The rotation field direction of the voltages and the frequency of phase L1 are shown on the display.

The rotation field direction indicates the phase sequence in three-phase systems. Usually there is a "clockwise spinning rotation field".

The phase sequence at the voltage measurement inputs is checked and displayed in the UMG 96RM-P/-CBM. A movement of the character string in the clockwise direction means a "right rotation" and a counter-clockwise movement indicates a "left rotation".

The rotation field direction is determined only if the measurement and operating voltage inputs are fully connected. If one phase is missing or two of the same phases are connected, the rotation field direction will not be determined and the character string does not appear on the display.



Fig. Display of the mains frequency (50.0) and the rotation field direction



Fig. No rotation field direction detectable.

LCD contrast (addr. 035)

The preferred direction of viewing for the LCD is from "below". The user can adjust the LCD contrast of the LCD screen. It is possible to set the contrast in the range from 0 to 9 in steps of 1.

0 = characters are very light

9 = characters are very dark

Factory default setting: 5

Backlight

The LCD backlight allows the display to be read easily even in poor light. The brightness can be controlled by the user in stages from 0 to 9.

The UMG 96RM has two different types of backlight:

- the operation backlight
- the standby backlight

Operation backlight (addr. 036)

The operation backlight is activated by pushing the appropriate button, or with a restart.

Standby backlight (addr. 747)

This backlight is activated after an adjustable period of time (addr. 746). If no button is pressed within this period, then the device switches to the standby backlight. If buttons 1 - 3 are pressed, the device switches to the operation backlight and the defined period of time begins again.

If the brightness settings for the two backlights are set to the same value, then no change is discernible between the operation and standby backlights.

Addr.	Description	Setting range	Default setting
036	Brightness for operation backlight	0 .. 9	6
746	Period of time after which the backlight will switch to standby	60 .. 9999 Sek.	900 Sek.
747	Brightness for standby backlight	0 .. 9	0

0 = min. brightness, 9 = max. brightness

Time recording

The UMG 96RM-P/-CBM records the operating hours and the total running time of each comparator

- where the time of operating hours is measured with a resolution of 0.1 h and is displayed in hours or
- the total running time of the comparator is represented in seconds (when 999999 seconds is reached, the display changes to hours).

For the querying of measured value displays, the times are marked with the numbers 1 to 6:

none = operating hours meter

1 = total running time, comparator 1A

2 = total running time, comparator 2A

3 = total running time, comparator 1B

4 = total running time, comparator 2B

5 = total running time, comparator 1C

6 = total running time, comparator 2C

A maximum of 99999.9 h (= 11.4 years) can be shown on the measured value display.

Operating hours meter

The operating hours meter measures the time for which the UMG 96RM-P/-CBM records and displays measured values.

The time of operating hours is measured with a resolution of 0.1 h and is displayed in hours. The operating hours meter cannot be reset.

Total running time of the comparator

The total running time of a comparator is the sum of all time for which there is a limit value violation in the comparator result.

The total running time of the comparator can only be reset via the GridVis software. The reset is carried out for all total running times.



Fig. Operating hours meter of the measured value display

The UMG 96RM-P/-CBM shows the number 140.8h in the operating hours meter. This corresponds to 140 hours and 80 industrial minutes. 100 industrial minutes correspond to 60 minutes. In this example, 80 industrial minutes therefore represent 48 minutes.

Serial number (addr. 754)

The serial number shown by UMG 96RM-P/-CBM has 6 digits and is part of the serial number displayed on the nameplate.

The serial number cannot be changed.

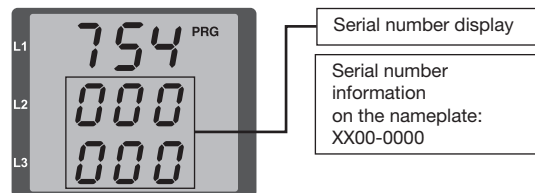

Software release (addr. 750)

The software for UMG 96RM-P/-CBM is continuously improved and expanded. The software version in the device is marked with a 3-digit number, the software release. The user cannot change the software release.

“Drag indicator”**Max. value of the mean value over n minutes**

The “drag indicator” describes a maximum mean value of a measured value over a defined period.

The period duration is set via a parameter, via the GridVis software or via the digital input 1.

In the process, synchronisation is triggered via the internal clock (which can be set via parameter 206 or to a full hour) or optionally via digital input 1. If synchronisation via the digital input is selected, the capture time must be set!

The three highest values of 15 variables with time stamp are saved. The maximum values of the variables can also be viewed in the device display.

Variables:

- Current in the single phases L1.. L3
- Effective power (consumption/export) in the single phases L1.. L3
- Effective power (consumption/export), total.
- Apparent power the single phases L1...L3
- Apparent power, total



Please note that even **before averaging**, the values are divided between positive and negative ones!

During totalisation, first the totals for the single phases are calculated, **then** divided into positive and negative values!

The maximum values are reset via the “Delete min./max. values” function with the GridVis program, via Modbus or on the display by setting the corresponding parameters (parameter 506: set from 0 to 1).

Addr.	Description	Setting range	Presetting
206	Period duration	300 .. 3600 sec.	900
207	Capture time	1 .. 20 sec.	10 sec.
208	Configuration digital input 1	0 .. 2	0
	0 = internal synchronisation 1 = external synchronisation (NO) 2 = external synchronisation (NC)		
506	Resetting	0, 1	0

Recordings

2 recordings are preconfigured in the default factory setting of the UMG 96RM-P and UMG 96RM-CBM. Recordings are adjusted and extended via the software “GridVis”.

- The smallest time base for records is 1 minute.
- A maximum of 4 recordings, each with 100 values are possible.

Recording 1:

The following measured values are recorded with the time base of 15 minutes:

- Voltage effective L1
- Voltage effective L2
- Voltage effective L3
- Current effective L1
- Current effective L2
- Current effective L3
- Current effective Sum L1-L3
- Active Power L1
- Active Power L2
- Active Power L3
- Active Power Sum L1-L3
- Apparent Power L1
- Apparent Power L2
- Apparent Power L3

- Apparent Power Sum L1-L3
- $\cos \phi(\text{math.})$ L1
- $\cos \phi(\text{math.})$ L2
- $\cos \phi(\text{math.})$ L3
- $\cos \phi(\text{math.})$ Sum L1-L3
- Reactive power fundamental L1
- Reactive power fundamental L2
- Reactive power fundamental L3
- Reactive power fundamental Sum L1-L3

The mean value, minimum value and maximum value are also recorded for each measured value.

Recording 2:

The following measured values are recorded with the time base of 1 hour:

- Active Energy Sum L1-L3
- Inductive Reactive Energy Sum L1-L3

Commissioning

Applying the supply voltage

- The level of supply voltage for the UMG 96RM-P/-CBM can be found on the nameplate.
- After applying the supply voltage, the UMG 96RM-P/-CBM switches to the first measured value display.
- If no display appears, the supply voltage must be checked to determine whether it is in the rated voltage range.

Applying the measured voltage

- Voltage measurements in networks with rated voltages above 300V AC to ground must be connected to a voltage transformer.
- After the measured voltages are connected, the measured values for the L-N and L-L voltages displayed by the UMG 96RM-P/-CBM must match those at the voltage measurement input.



Attention!

Voltages and currents outside the permissible metering range can result in personal injury and damage to the device.

Applying the measured current

The UMG 96RM-P/-CBM is designed for connecting $\dots/1$ A and $\dots/5$ A current transformers.

Only AC currents and not DC currents can be measured via the current measurement inputs.

Short circuit all current transformer outputs except for one. Compare the currents displayed on the UMG 96RM-P/-CBM with the applied current.

The current displayed by the UMG 96RM-P/-CBM must match the input current, taking the current transformer ratio into consideration.

In the short circuit current measurement inputs, the UMG 96RM-P/-CBM must show approx. zero amperes.

The factory-set current transformer ratio is 5/5 A and may need to be adapted to the current transformer used.



Attention!

Supply voltages that do not correspond to the nameplate information can lead to device malfunction or destruction.



Attention!

The UMG 96RM-P/-CBM is not suitable for the measurement of DC voltages.

Rotation field direction

Check the direction of the voltage rotation field on the measured value display of the UMG 96RM-P/-CBM. Usually there is a "clockwise" spinning rotation field.

Checking the phase assignment

The assignment of the phase conductor to the current transformer is correct if a current transformer is short circuited at the secondary terminals and the current shown by the UMG 96RM-P/-CBM in the corresponding phase sinks to 0A.

Checking the power measurement

Short circuit all current transformer outputs except for one and check the displayed power. The UMG 96RM-P/-CBM must only show one rating in the phase with the non-short-circuited current transformer input. If this does not apply, check the measured voltage connection and the measured current connection.

If the magnitude of the real power is correct but the sign of the real power is negative, this can be due to two causes:

- The connections S1 (k) and S2 (l) on the current transformer are inverted.
- Active energy is being returned to the network.

Checking the measurement

If all voltage and current measurement inputs are correctly connected, the individual and sum power ratings are accurately calculated and displayed.

Checking the individual power ratings

If the current transformer is assigned to the wrong phase conductor, the associated power rating will be incorrectly measured and displayed.

The assignment of the phase conductor to the current transformer on the UMG 96RM-P/-CBM is correct if there is no voltage between the phase conductor and the associated current transformer (primary).

In order to ensure that a phase conductor on the voltage measurement input is assigned to the correct current transformer, the respective current transformer can be short-circuited at the secondary terminals. The apparent power shown by the UMG 96RM-P/-CBM must then be zero in this phase.

If the apparent power is correctly displayed but the real power is shown with a "-" sign, the current transformer terminals are inverted or power is being fed to the power company.

Check the sum power ratings

If all voltages, currents and power ratings for the respective phase conductor are correctly displayed, the sum power ratings measured by the UMG 96RM-P/-CBM must also be correct. For confirmation, the sum power ratings measured by the UMG 96RM-P/-CBM should be compared with the energy of the active and reactive power meters at the power feed.

RS485 interface

The data from the parameter and measured value list can be accessed via the MODBUS RTU protocol with CRC check to the RS485 interface.

Address range: 1 .. 247

Factory default setting: 1



The system does not support broadcast (addr. 0).



The message length must not exceed 256 bytes.

The device address is set to 1 and the baud rate is set to 115.2 kbps by default.

Modbus Functions (Slave)

04 Read Input Registers

06 Preset Single Register

16 (10Hex) Preset Multiple Registers

23 (17Hex) Read/Write 4X Registers

The sequence of bytes is high before low byte (Motorola format).

Transmission parameters:

Data bits: 8

Parity: None

Stop bits (UMG 96RM-P/-CBM): 2

External stop bits: 1 or 2

Number formats: short 16 bit ($-2^{15}.. 2^{15} - 1$)

float 32 bit (IEEE 754)

Example: Reading the L1-N voltage

The L1-N voltage is stored in the measured value list under the address 19000. The L1-N voltage is stored in FLOAT format.

The UMG 96RM-P/-CBM device address with the address = 01 is adopted here.

The "query message" then appears as follows:

<u>Description</u>	<u>Hex</u>	<u>Note</u>
Device address	01	UMG 96RM, address = 1
Function	03	"Read Holding Reg."
Start address Hi	4A	19000dec = 4A38hex
Start address Lo	38	
Disp. Values Hi	00	2dec = 0002hex
Disp. Values Lo	02	
Error Check	-	

The "response" from the UMG 96RM-P/-CBM can then appear as follows:

<u>Description</u>	<u>Hex</u>	<u>Note</u>
Device address	01	UMG 96RM, address = 1
Function	03	
Byte meter	06	
Data	00	00hex = 00dec
Data	E6	E6hex = 230dec
Error Check (CRC)	-	

The L1-N voltage read back from address 19000 is 230 V.

Installation of USB driver

With internet access or authorisation for automatic updates of the driver library:

With all current operating systems (e.g. Windows 7) the required drivers are automatically installed the first time the device is connected to the USB interface of the computer.

- Connect the power supply voltage for the UMG 96RM-P/-CBM, as a minimum.
- Connect the UMG 96RM-P/-CBM to a suitable USB interface on the computer with the USB cable provided.
- The installation of the system drivers required starts and runs automatically.
- After successful installation the device can be used.

With missing internet access or missing authorisation for automatic updates of the driver library or with Windows XP SP2:

- *Windows system:*
Start the setup program in the UMG96RM/USB drivers/Windows folder on the CD provided. The drivers required will be installed.
- *Linux system:*
Follow the instructions in the Readme file in the UMG96RM/USB drivers/Linux folder.
- Connect the power supply voltage for the UMG 96RM-P/-CBM, as a minimum.
- After successful installation, connect the UMG 96RM-P/-CBM to a suitable USB interface on the computer with the USB cable provided.

Checking the USB installation

- Open the *Devices and printers window in Windows 7 via the control panel, for example.*
- Open the *Properties* of the device FT232 USB UART by double-clicking. Further information about the device can be found in the *General* and *Hardware* tabs.
- Change to *Hardware*. Under device functions a *USB Serial Converter* and a *USB Serial Port (COMx)* should be shown after a successful installation, whereby *x* reflects the virtual COM port.
- In Windows XP this information can be found in the hardware area of the device manager under USB Universal Controller.
- Start the GridVis software and integrate the UMG 96RM-P/-CBM with the assistant (*New file...*). After selecting the connection type (USB) and the interface of the COM port (COMx, see above) the USB connection can be used.

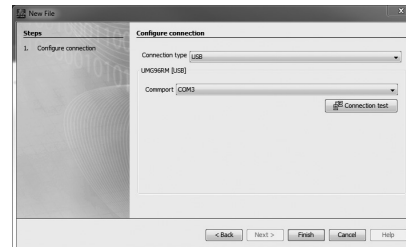
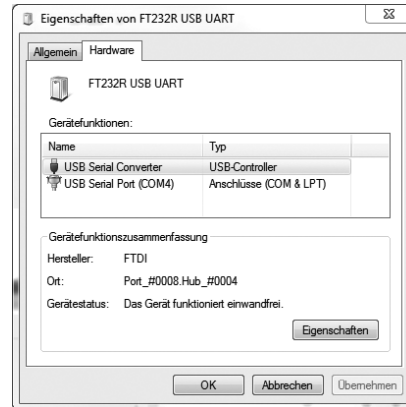

Profibus interface (only UMG 96RM-P)

Profibus profiles

A Profibus profile contains the data to be exchanged between a UMG and a PLC. It is possible to read out measurement values and statuses via eight user-defined and four factory pre-configured Profibus profiles.

A Profibus profile can:

- Retrieve measurement values from the UMG.
- Set the digital outputs in the UMG.
- Query the status of the digital inputs in the UMG.

Each Profibus profile can hold a maximum of 127 bytes of data. If more data has to be transferred, simply create additional Profibus profiles.

- Every Profibus profile has a profile number. The profile number is sent by the PLC to the UMG.
- The 8 user-defined Profibus profiles (profile numbers 0...7) can be edited with the GridVis software.
- Factory pre-configured Profibus profiles (profile numbers 8...11) cannot be changed.

Activate outputs/tariffs via Profibus

To set the outputs or the tariffs an appropriate profile must be selected. Alongside the 1st byte used for the profile selection three further bytes can be used to:

- Switch outputs
- Control tariffs and energy meters

Profile number selection (1st byte):

Byte 1 enables the selection of the Profibus profile number 0 to 11. The output range of the PLC must contain this byte as a minimum. Within the byte, bits 0 to 3 describe the profile number, bits 4 to 7 are unused.

Example:

*Profile number 8 selected
(Binary representation)*



Switching digital outputs (2nd byte):

Setting or clearing the bits in byte 2 ("Profibus remote" type) enables the setting of the digital outputs 1-6. Bits 6 and 7 are not used.

Example:
Output 1-3 set

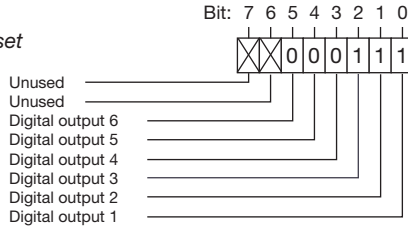

Control tariffs (3rd byte):
Setting or clearing the bits enables the selection of tariffs 1-7. Bit 7 is not used. **If several tariffs are set in the byte then the tariff with the least significant bit is selected.** If byte 3 is used, then byte 4 should be set!

Example:
Tariff 3 selected

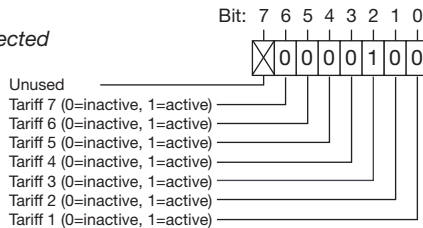

Control tariffs (4th byte):
Setting or clearing bits 0 to 6 of byte 4 enables a selection of energy meters for the tariff set. Each tariff can have up to 7 energy meters allocated to it.

Example:
Apparent energy selected

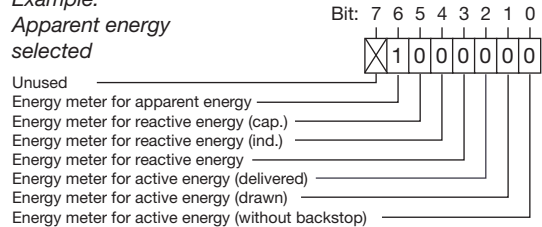

Deactivate energy meters / tariffs via Profibus

If energy meters are assigned to a tariff then these can be deactivated via byte 3 and byte 4 (cf. activate tariffs via Profibus). Here the selection of the desired tariff is implemented in byte 3 and the clearing of the associated bits in byte 4 deactivates the energy meter.

Example:

If the energy meter for active energy (drawn) is set under tariff 3, the deactivation of the energy meter is implemented as follows:

Byte 3: *Tariff 3 selected*

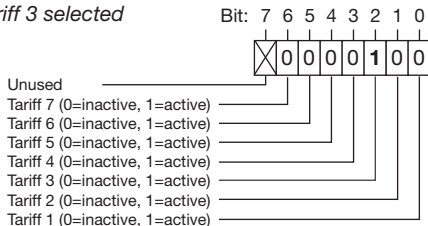

Byte 4:

Deactivating energy meters

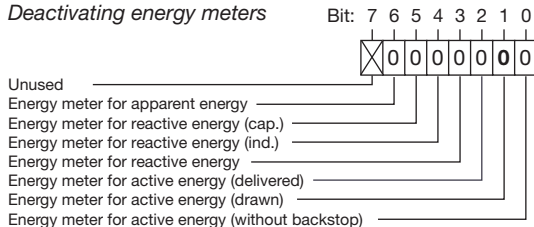

The energy meter is deleted by selecting the tariff (byte 3) and clearing the bits in byte 4 associated with the energy meter.

If the meter is deleted then a new energy meter can be assigned to the tariff.

If the deactivation of a tariff is desired then the energy meters assigned should be deleted first via bytes 3 and 4 and then the tariff should be deactivated via byte 3.

Reading out measurement values via the Profibus

Selected measurement values can be read out via 4 factory-set profiles and an additional 8 user-defined profiles. Here each profile has a unique profile number with which a PLC can read out the configured measurement values of a profile.



The device address can be configured by using the parameter 000 if the device is used in a Profibus-System.

The baud rate in a Profibus system is detected automatically and must NOT be set via the address 001!

Example:

Reading out of measurement values from the factory-preconfigured Profibus profile number 8.

The 1st byte should be set to the profile number 8 (dec.) and sent to the UMG 96RM-P.

The UMG 96RM-P then delivers the profile number 8 and the measured values set in profile 8 back.

*Byte 1:
Profile number 8 selection*



Example: Using Profibus to retrieve measurement values

At least one Profibus profile must be set up with GridVis and transferred to the UMG 96RM-P.

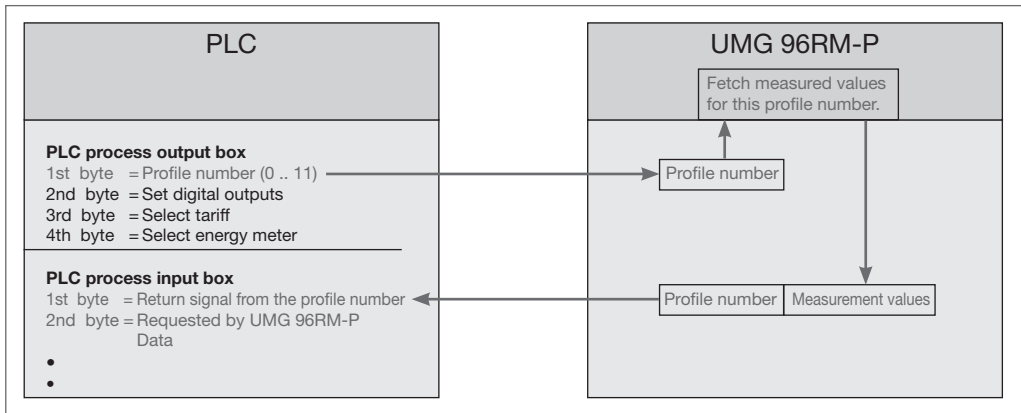

Fig. Block diagram for data exchange between PLC and UMG 96RM-P.

Device master file

The device master file, or GSD file, describes the Profibus characteristics of the UMG 96RM-P. The GSD file is required by the configuration program of the PLC.

The device master file for the UMG 96RM-P has the filename „96RM0D44.GSD“ and is included on the data carrier as part of the scope of deliverables.

System variables

Various system variables (measured values) are available in the formats Float and Integer (byte order: Big and Little Endian).

These variables are clearly defined and listed in the Modbus address list. A customized scaling and conversion to other formats are not possible. In case that a different data type of a variable is required, an alternative representation of the variable (value) must exist (see Modbus address list).

Profile formats

The measuring values in the Profibus profile number 8 till 11 have the format „high byte before low byte“.

For measurements values in the format „low byte before high byte“ must be added to the Profibus profile number 128!

Factory pre-configured profiles

Profibus profile number 8

Byte index	Value type	Value format	Scaling
1	1	Effective voltage L1	Float 1
2	5	Effective voltage L2	Float 1
3	9	Effective voltage L3	Float 1
4	13	Effective voltage L1-L2	Float 1
5	17	Effective voltage L2-L3	Float 1
6	21	Effective voltage L3-L1	Float 1
7	25	Effective current L1	Float 1
8	29	Effective current L2	Float 1
9	33	Effective current L3	Float 1
10	37	Effective current L4	Float 1
11	41	Effective current sum L1..L3	Float 1
12	45	Effective power L1	Float 1
13	49	Effective power L2	Float 1
14	53	Effective power L3	Float 1
15	57	Cos phi (math.) L1	Float 1
16	61	Cos phi (math.) L2	Float 1
17	65	Cos phi (math.) L3	Float 1
18	69	Frequency	Float 1
19	73	Effective power sum L1..L3	Float 1
20	77	Reactive power fundamental oscillation harmonic sum L1..L3	Float 1
21	81	THD voltage L1	Float 1
22	85	THD voltage L2	Float 1
23	89	THD voltage L3	Float 1
24	93	THD current L1	Float 1
25	97	THD current L2	Float 1
26	101	THD current L3	Float 1
27	105	THD current L4	Float 1

Profibus profile number 9

Byte index	Value type	Value format	Scaling
1	1	Effective energy sum L1..L3	Float 1
2	5	Effective energy sum L1..L3 drawn	Float 1
3	9	Effective energy sum L1..L3 delivered	Float 1
4	13	Reactive energy sum L1..L3	Float 1
5	17	Ind. reactive energy sum L1..L3	Float 1
6	21	Cap. reactive energy sum L1..L3	Float 1
7	25	Apparent energy sum L1..L3	Float 1
8	29	Effective energy L1	Float 1
9	33	Effective energy L2	Float 1
10	37	Effective energy L3	Float 1
11	41	Inductive reactive energy L1	Float 1
12	45	Inductive reactive energy L2	Float 1
13	49	Inductive reactive energy L3	Float 1



The configuration/programming is implemented via the GridVis software included in the scope of deliverables. A connection between the UMG 96RM-P and the PC via an interface is required for the use of the GridVis software.

Profibus profile number 10

Byte index	Value type	Value format	Scaling
1	1	Effective power L1	Float 1
2	5	Effective power L2	Float 1
3	9	Effective power L3	Float 1
4	13	Effective power sum L1..L3	Float 1
5	17	Effective current L1	Float 1
6	21	Effective current L2	Float 1
7	25	Effective current L3	Float 1
8	29	Effective current L4	Float 1
9	33	Effective current sum L1..L3	Float 1
10	37	Effective energy sum L1..L3	Float 1
11	41	Cos phi (math.) L1	Float 1
12	45	Cos phi (math.) L2	Float 1
13	49	Cos phi (math.) L3	Float 1
14	53	Cos phi (math.) sum L1..L3	Float 1
15	57	Reactive power fundamental oscillation harmonic L1	Float 1
16	61	Reactive power fundamental oscillation harmonic L2	Float 1
17	65	Reactive power fundamental oscillation harmonic L3	Float 1
18	69	Reactive power fundamental oscillation harmonic sum L1..L3	Float 1
19	73	Apparent power L1	Float 1
20	77	Apparent power L2	Float 1
21	81	Apparent power L3	Float 1
22	85	Apparent power sum L1..L3	Float 1

Profibus profile number 11

Byte index	Value type	Value format	Scaling
1	1	Effective voltage L1	Float 1
2	5	Effective voltage L2	Float 1
3	9	Effective voltage L3	Float 1
4	13	Effective current L1	Float 1
5	17	Effective current L2	Float 1
6	21	Effective current L3	Float 1
7	25	Effective current L4	Float 1
8	29	Effective power L1	Float 1
9	33	Effective power L2	Float 1
10	37	Effective power L3	Float 1
11	41	Effective power sum L1..L3	Float 1
12	45	Counter status digital input 1	Integer (4 Byte) 1
13	49	Counter status digital input 2	Integer (4 Byte) 1
14	53	Counter status digital input 3	Integer (4 Byte) 1
15	57	Counter status digital input 4	Integer (4 Byte) 1
16	61	Status digital output 1	Integer (2 Byte) 1
17	63	Status digital output 2	Integer (2 Byte) 1
18	65	Status digital output 3	Integer (2 Byte) 1
19	67	Status digital output 4	Integer (2 Byte) 1
20	69	Status digital output 5	Integer (2 Byte) 1
21	71	Status digital output 6	Integer (2 Byte) 1



Measured values in **integer format** do not respect the transformer ratio. Measured values in **floating point format** contain the transformer ratio: *value in the UMG 96RM-P display = transformer ratio x value PLC x solution*

Digital outputs

The UMG 96RM-P and UMG 96RM-CBM have 6 digital outputs, whereby these are split into two groups of 2 and 4 outputs (see illustration on the right).

The User can allocate different functions to the digital outputs

The functions can be programmed by using the configuration menu of the GridVis software.

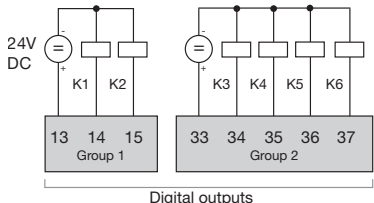

Fig.: Digital outputs of group 1 and group 2

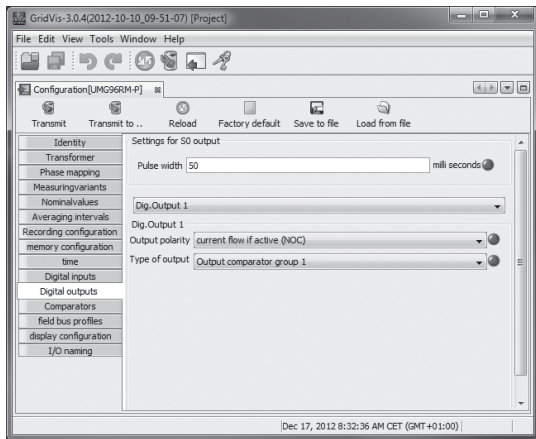

Fig.: Software GridVis, configuration menu

Digital outputs 1 and 2 – Status displays

The status of the switching outputs of group 1 is indicated by circular symbols in the display of the UMG 96RM-P/-CBM.



Since the indication is updated once per second, faster status changes of the outputs can not be displayed.

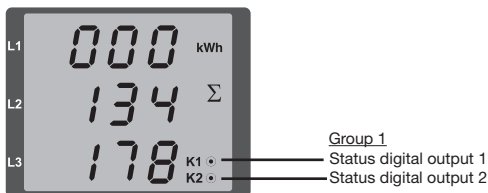

Digital output stati

- The current flow can be <math><1\text{mA}</math>.
 - Digital output 1: Addr. 608 = 0
 - Digital output 2: Addr. 609 = 0
- The current flow can up to 50mA.
 - Digital output 1: Addr. 608 = 1
 - Digital output 2: Addr. 609 = 1

Impulse output

The digital outputs can be used for the output of pulses for the computation of power consumption. For this purpose, a pulse of defined length is applied on the output after reaching a certain, adjustable amount of power.

You need to make various adjustments in the software GridVis (configuration menu) to use a digital output as a pulse one.

- Digital output,
- Selection of measured,
- Selection of measured value,
- Pulse length,
- Pulse value.

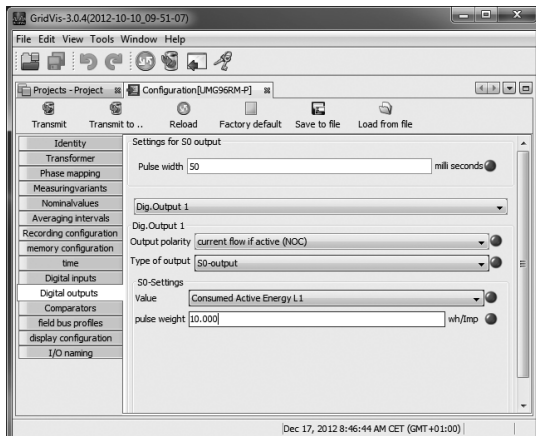

Fig.: Software GridVis, configuration menu

Pulse length (addr. 106)

The pulse length applies for both pulse outputs and is permanently fixed via parameter address 106.

Adjustment range: 1 .. 1000 1 = 10ms

Default: 5 = 50ms

The typical pulse length for S0 pulses is 30 ms.

Pulse pause

The pulse pause is at least as long as the selected pulse length.

The pulse pause depends on the measured energy, for example, and can be hours or days.

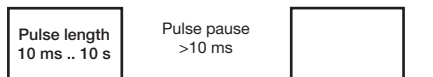

Pulse spacing

The pulse spacing is proportional to the power within the selected setting.

Due to the minimum pulse length and minimum pulse pause, the values in the table are for the maximum number of pulses per hour.

Pulse length	Pulse pause	Maximum pulses/hour
10 ms	10 ms	180,000 pulses/hour
30 ms	30 ms	60,000 pulses/hour
50 ms	50 ms	36,000 pulses/hour
100 ms	100 ms	18,000 pulses/hour
500 ms	500 ms	3,600 pulses/hour
1 s	1 s	1,800 pulses/hour
10 s	10 s	180 pulses/hour

Examples for the maximum possible number of pulses per hour.



Measured value selection

When programming with GridVis, a selection of energy values that are derived from the power values is received.

Pulse value (addr. 102, 104)

The pulse value specifies how much energy (Wh or varh) should correspond to a pulse.

The pulse value is determined by the maximum connected load and the maximum number of pulses per hour.

If the pulse value is specified with a positive sign, pulses will only be issued if the measured value also has a positive sign.

If the pulse value is specified with a negative sign, pulses will only be issued if the measured value also has a negative sign.

$$\text{Pulse value} = \frac{\text{maximum connection power}}{\text{maximum number of pulses per hour}} \text{ [pulse/Wh]}$$



Since the active energy meter works with a return stop, pulses are only issued during import of electrical energy.



Since the reactive energy meter works with a return stop, pulses are only issued under inductive load.

Determining the pulse value

Setting the pulse length

Set the pulse length according to the requirements of the connected pulse receiver.

For a pulse length of 30 ms, for example, the UMG 96RM-P/-CBM can issue a maximum number of 60,000 pulses per hour (see Table "Maximum Pulse Number") per hour.

Determining the maximum connected load

Example:

$$\begin{aligned} \text{Current transformer} &= 150/5 \text{ A} \\ \text{L-N voltage} &= \text{max. } 300 \text{ V} \end{aligned}$$

$$\begin{aligned} \text{Power per phase} &= 150 \text{ A} \times 300 \text{ V} \\ &= 45 \text{ kW} \end{aligned}$$

$$\text{Power for 3 phases} = 45 \text{ kW} \times 3$$

$$\text{Maximum connected load} = 135 \text{ kW}$$

Calculating the pulse value

$$\text{Pulse value} = \frac{\text{maximum connection power}}{\text{maximum number of pulses per hour}} \text{ [pulse/Wh]}$$

$$\text{Pulse value} = 135 \text{ kW} / 60000 \text{ pulses/h}$$

$$\text{Pulse value} = 0.00225 \text{ kWh} / \text{pulses}$$

$$\text{Pulse value} = 2.25 \text{ Wh} / \text{pulses}$$

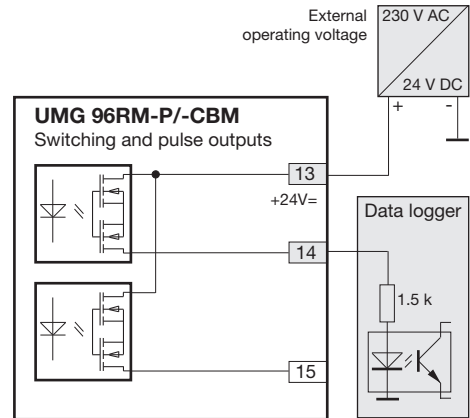

Fig.: Connection example for wiring the pulse output.



When using the digital outputs as a pulse output, the auxiliary voltage (DC) must only have a maximum residual ripple of 5%.

Comparators and monitoring threshold values

Six comparator groups (1 - 6) and three comparators per group (A - C) can be selected in order to monitor/control the thresholds. The results of the comparators A to J can be linked with AND or OR operators.

The result of the AND and OR operator can be allocated to the respective digital output.

The function “display blinking” can be additionally assigned to every comparator group. The effect is the change of the display backlight between maximum and minimum brightness when the comparator output is active.



Abb.: Software GridVis, Konfigurationsmenü

Service and maintenance

The device is subjected to several different safety tests before leaving the factory and is labelled with a seal. If a device is opened then the safety checks must be repeated. Warranty claims will only be accepted if the device is unopened.

Repair and calibration

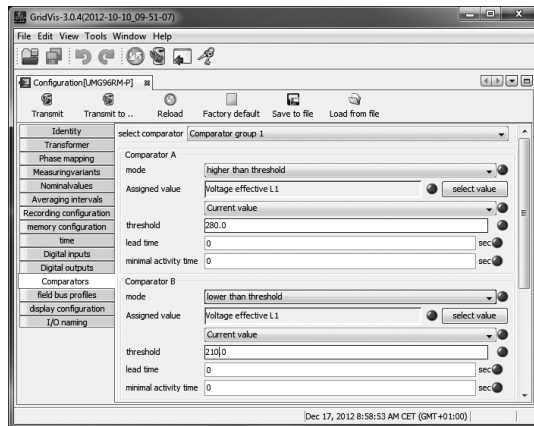
Repair work and calibration can be carried out by the manufacturer only.

Front film

The front film can be cleaned with a soft cloth and standard household cleaning agent. Do not use acids and products containing acid for cleaning.

Disposal

The UMG 96RM-P/-CBM can be reused or recycled as electronic scrap in accordance with the legal provisions. The permanently installed lithium battery must be disposed of separately.

Service

Should questions arise, which are not described in this manual, please contact the manufacturer directly.

We will need the following information from you to answer any questions:

- Device name (see rating plate),
- Serial number (see rating plate),
- Software release (see measured value display),
- Measuring-circuit voltage and power supply voltage,
- Precise description of the error.

Device calibration

The devices are calibrated by the manufacturer at the factory - it is not necessary to recalibrate the device providing that the environmental conditions are complied with.

Calibration intervals

It is recommended to have a new calibration carried out by the manufacturer or an accredited laboratory every 5 years approximately.

Firmware update

If the device is connected to a computer via Ethernet, then the device firmware can be updated via the GridVis software.

Select a suitable update file (menu *Extras / Update device*) and the device and the new firmware will be transferred.



Abb. Firmwareupdate-Assistent der Software GridVis

Battery

The internal clock is fed from the supply voltage. If the supply voltage fails then the clock is powered by the battery. The clock provides date and time information, for the records, min. and max. values and results, for example.

The life expectancy of the battery is at least 5 years with a storage temperature of +45°C. The typical life expectancy of the battery is 8 to 10 years.

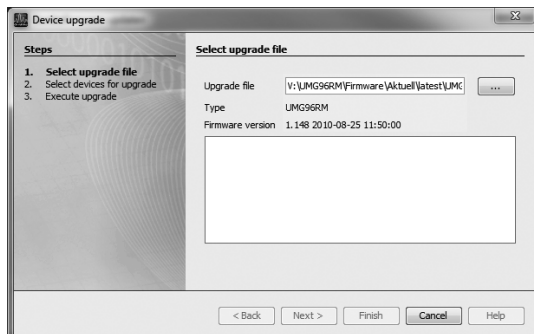
The battery is replaced via the battery insert provided on the rear of the device. Make sure that the correct type of battery is used and correct polarity is observed when inserting the battery (positive pole faces the rear of the device; negative pole faces the front).

See chapter "Changing the battery" for more information.

Battery monitoring function

The device indicates the condition of the battery via the "EEE" symbol followed by "bAt" and the status number. Depending on the status number a confirmation of the information by the operator may be required. It is recommended that the battery be replaced.

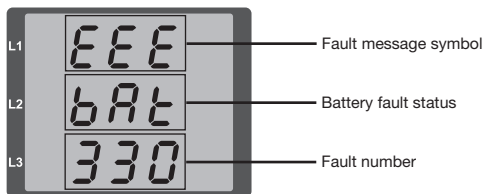

Status	Status description
EEE bAt 321	<ul style="list-style-type: none"> • Battery capacity is <85% • Operator confirmation required • Message appears weekly after confirmation • Battery should be replaced
EEE bAt 322	<ul style="list-style-type: none"> • Battery capacity is <75% • Battery capacity is too low • Can only be detected after resumption of mains power • Battery should be replaced
EEE bAt 330	<ul style="list-style-type: none"> • Battery capacity OK • Message can be acknowledged • Clock is stopped and must be set
EEE bAt 331	<ul style="list-style-type: none"> • Battery capacity is <85% • Clock is stopped and must be set • Operator confirmation required • Message appears weekly after confirmation • Battery should be replaced
EEE bAt 332	<ul style="list-style-type: none"> • Battery capacity is <75% • Clock is stopped and must be set • Operator confirmation required • Message appears daily after confirmation • Battery should be replaced

Replacing the battery

If the battery capacity is shown as < 75 %, we recommend that the battery be replaced.

Procedure

1. Disconnect system and device from power supply before beginning work.
2. Discharge any electrostatic charge in your body, e. g. by touching an earthed cabinet or metal part (radiator) connected to the earth of the building.
3. Remove the battery from the battery compartment, —e.g. using long-nose pliers—. **The device does not need to be opened to do this as the battery compartment can be accessed from the outside (see figure on the right).**
4. Make sure that the polarity is as shown on the insertion opening of the battery compartment and slide the replacement battery into the battery compartment. For this, use a battery compliant with the description in the technical data. The battery must fulfil the safety requirements of UL1642. Otherwise, there is a risk of combustion or explosion.
5. Dispose of the old battery according to the legal regulations.
6. Start up the system and the device again and check the functionality of the UMG 96-RM-P/-CBM. Set the date and time.



Fig. Battery insertion on the rear



Grease or dirt on the contact surfaces form a transfer resistance that will shorten the life of the battery. Only touch the battery at the edges.



Dangerous voltage!

Danger to life or risk of serious injury. Disconnect system and device from power supply before beginning work.



Make sure that the correct type of battery is used and observe correct polarity when changing it.

Error messages

The UMG 96RM-P/-CBM shows three different error messages on the display:

- warnings,
- clock/battery errors,
- serious error and
- metering range exceedances.

If there are warnings and serious errors, the error message is indicated by the symbol "EEE" followed by an error number.

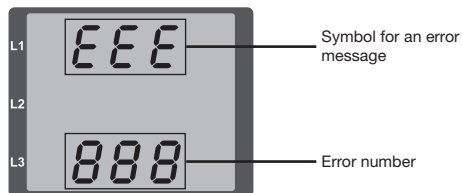

The three-digit error number is composed of the error description and (if detectable by the UMG 96RM-P/-CBM) one or more error causes.

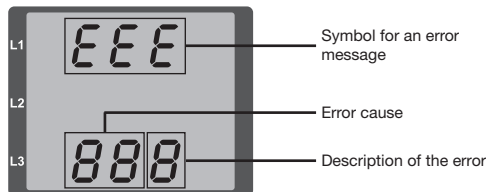

Example of error message 911:

The error number is composed of serious error 910 and internal error cause 0x01.

In this example, an error occurred when reading the calibration from the EEPROM. The device must be sent to the manufacturer for inspection.



Warnings

Warnings are less serious errors and can be acknowledged with buttons 1 or 2. The measured values continue to be recorded and displayed. This error is re-displayed after each voltage recovery.

Error	Description of the error
EEE 500	The mains frequency could not be determined. Possible causes: The voltage at L1 is too small. The mains frequency does not range between 45 and 65Hz. Remedy: Check the mains frequency. Select fixed frequency on the device.

Serious errors

The device must be sent to the manufacturer for inspection.

Error	Description of the error
EEE 910	Error when reading the calibration.

Internal causes of the error

The UMG 96RM-P/-CBM can usually determine the cause of an internal error and then report it with the following error code. The device must be sent to the manufacturer for inspection.

Error	Description of the error
0x01	EEPROM does not answer.
0x02	Address range exceeded.
0x04	Checksum error.
0x08	Error in the internal I2C bus.

Clock/battery errors

Clock or battery errors are displayed together with the „EEE“ symbol followed by „bAt“ and a status number. For a more detailed description please refer to „Battery control function“ and „Replacing the battery“.

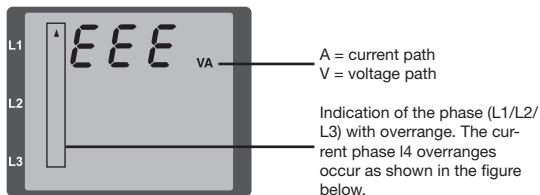

Fig. Clock / battery error number 330 (clock does not run and has to be set).

Overranges

Overranges are displayed as long as they exist and cannot be acknowledged. An overrange exists if at least one of the voltage or current measurement inputs lies outside their specified measuring range.

The "upwards" arrow indicates the phase where the overrange occurred. The appropriate error message for current path I4 is generated as shown below. The "V" and "A" symbols indicate whether the overrange occurred in the current or in the voltage path.



Overrange limits:

I	=	7 A _{eff}
U _{L-N}	=	300 V _{rms}

Examples

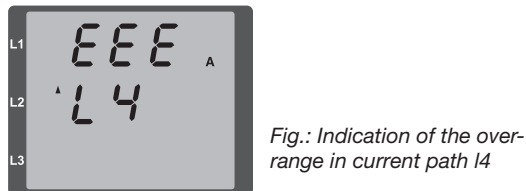
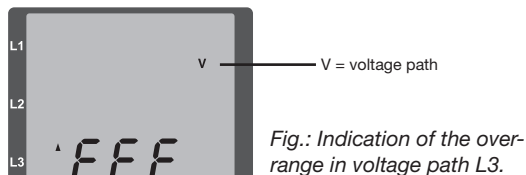
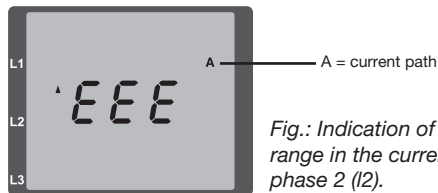

Parameter overrange

A detailed description of the error is coded in the parameter overrange (Addr. 600) in the following format:

0x	F	F	F	F	F	F	F	F
Phase 1:		1		1				
Phase 2:		2		2				
Phase 3:		4		4				
		Current:		U _{L-N}				

Example: Error in phase 2 in the current path:

0xF2FFFFFF

Example: Error in phase 3 in the current path U_{L-N}:

0xFFF4FFFF

Procedure in the event of faults

Possible fault	Cause	Remedy
No display	External fusing for the power supply voltage has tripped.	Replace fuse.
No current display	Measurement voltage is not connected.	Connect the measuring-circuit voltage.
	Measurement current is not connected.	Connect measuring-circuit current.
Current displayed is too large or too small.	Current measurement in the wrong phase.	Check connection and correct if necessary.
	Current transformer factor is incorrectly programmed.	Read out and program the current transformer transformation ratio at the current transformer.
	The current peak value at the measurement input was exceeded by harmonic components.	Install current transformer with a larger transformation ratio.
	The current at the measurement input fell short of.	Install current transformer with a suitable transformation ratio.
Voltage displayed is too large or too small.	Measurement in the wrong phase.	Check connection and correct if necessary.
	Voltage transformer incorrectly programmed.	Read out and program the voltage transformer transformation ratio at the voltage transformer.
Voltage displayed is too small.	Overrange.	Install voltage transformers.
	The peak voltage value at the measurement input has been exceeded by harmonic components.	Caution! Ensure the measurement inputs are not overloaded.
Phase shift ind/cap.	A current path is assigned to the wrong voltage path.	Check connection and correct if necessary.
Effective power, consumption/supply reversed.	At least one current transformer connection is mixed up/reversed.	Check connection and correct if necessary.
	A current path is assigned to the wrong voltage path.	Check connection and correct if necessary.

Possible fault	Cause	Remedy
Effective power too large or too small.	The programmed current transformer transformation ratio is incorrect.	Read out and program the current transformer transformation ratio at the current transformer
	The current path is assigned to the wrong voltage path.	Check connection and correct if necessary.
	The programmed voltage transformer transformation ratio is incorrect.	Read out and program the voltage transformer transformation ratio at the voltage transformer.
An output is not responding.	The output was incorrectly programmed.	Check the settings and correct if necessary.
	The output was incorrectly connected.	Check connection and correct if necessary.
"EEE" in the display	See error messages.	
"EEE bAt" in the display	Battery capacity is too low	See "Battery control function" and "Replacing the battery"
No connection with the device.	RS485 - Device address is incorrect. - Different bus speeds (Baud rate). - Wrong protocol. - Termination missing.	- Adjust the device address. - Adjust speed (baud rate). - Select the correct protocol. - Close bus with termination resistor.
	USB - Driver fault	- Disconnect USB interface briefly - Use another USB port - Reinstall driver
Device still does not work despite the above measures.	Device defective.	Send the device to the manufacturer for inspection and testing along with an accurate fault description.

Technical data

General	
Net weight (with attached connectors)	approx. 358g
Packaging weight (including accessories)	approx. 790g
Battery	Lithium battery CR2032, 3V (approval i.a.w. UL 1642)
Service life of the backlight	40000h (after this period of time the background lighting efficiency will reduce by approx. 50 %)

Transport and storage	
The following information applies for devices that are transported or stored in their original packaging.	
Free fall	1m
Temperature	K55 (-25 °C to +70 °C)
Relative humidity	0 to 90% RH

Ambient conditions during operation	
The UMG 96RM-CBM/-P is intended for use in weather-protected, fixed locations. Protection class II according to IEC 60563 (VDE 0106, part 1).	
Rated temperature range	K55 (-10°C .. +55°C)
Relative humidity	0 to 75 % RH
Operational altitude	0 .. 2000 m above sea level
Degree of pollution	2
Installation position	vertical
Ventilation	Forced ventilation is not required.
Foreign body and water protection - Front - Back - Front with seal	IP40 according to EN60529 IP20 according to EN60529 IP54 according to EN60529

Power supply voltage		
Option 230V	Nominal range	90V - 277V (50/60Hz) or DC 90V - 250V; 300V CATIII
	Power consumption	UMG 96RM-P: max. 7,5VA / 4W UMG 96RM-CBM: 6VA / 3W
Option 24V	Nominal range	24V - 90V AC / DC; 150V CATIII
	Power consumption	UMG 96RM-P: max. 6,5VA / 5W UMG 96Rm-CBM: 5VA / 3W
Operating range	+-10% of nominal range	
Internal fuse, not replaceable	Typ T1A / 250V/277V according IEC 60127	
Recommended overcurrent protection device for line protection (certified under UL)	Option 230V: 6 - 16A Option 24V: 6 - 16A	

Recommendation for a maximum number of devices on a circuit breaker:

Option 230V : Circuit breaker B6A: max. 4 devices / Circuit breaker B16A: max. 11 devices

Option 24V : Circuit breaker B6A: max. 3 devices / Circuit breaker B16A: max. 9 devices

Connection capacity of the terminals (power supply)	
Connectable conductor. Only one conductor may be connected per contact point!	
Single-wire, multi-wire, finely stranded conductor	0.2 - 2.5mm ² , AWG 26 - 12
Pin terminals, ferrules	0.2 - 2.5mm ²
Tightening torque	0.4 - 0.5Nm
Stripping length	7mm

Digital outputs	
6 digital outputs, semi-conductor relay, not short circuit protected.	
Switching voltage	max. 33V AC, 60V DC
Switching current	max. 50mAeff AC/DC
Reaction time	10/12 Perioden + 10ms *
Pulse output (energy pulses)	max. 50Hz

* Reaction time at 50 Hz, for example: 200 ms + 10 ms = 210 ms

Digital inputs	
4 optional digital outputs, semiconductor relays, not short-circuit proof.	
Maximum counter frequency	20Hz
Input signal present	18V .. 28V DC (typical 4mA)
Input signal not present	0 .. 5V DC, current less than 0.5mA

Cable lengths (digital inputs and outputs)	
Up to 30m	Unshielded
More than 30m	Shielded

Connection capacity of the terminals (digital in-/outputs)	
Rigid/flexible	0,14 - 1,5mm ² , AWG 28-16
Flexible with ferrules without plastic sleeve	0,20 - 1,5mm ²
Flexible with ferrules with plastic sleeve	0,20 - 1,5mm ²
Tightening torque	0,20 - 0,25Nm
Stripping length	7mm

Serial interfaces	
RS485 - Modbus RTU/slave	9.6kbps, 19.2kbps, 38.4kbps, 57.6 kbps, 115.2kbps
Stripping length	7mm
USB (receptacle)	USB 2.0, type B, max. transfer rate 921.6 kbps
Profibus (<i>only UMG96RM-P</i>) - Profibus DP/VO - Receptacle	- 9,6kbps to 12Mbps - D-sub, 9-pole

Connection capacity of the terminals (RS485)	
Single-wire, multi-wire, finely stranded conductor	0.20 - 1.5mm ²
Pin terminals, ferrules	0.20 - 1.5mm ²
Tightening torque	0.20 - 0.25Nm
Stripping length	7mm

Voltage metering	
Three-phase, 4-wire systems with nominal voltages up to	277V/480V (+-10%)
Three-phase, 3-wire systems, unearthed, with nominal voltages up to	IT 480V (+-10%)
Overvoltage category	300V CAT III
Rated surge voltage	4kV
Metering range L-N	0 ¹⁾ .. 300 Vrms (max. overvoltage 520 Vrms)
Metering range L-L	0 ¹⁾ .. 520Vrms (max. overvoltage 900Vrms)
Resolution	0.01V
Crest factor	2.45 (relative to the metering range)
Impedance	4MΩm/phase
Power consumption	approx. 0.1VA
Sampling rate	21.33kHz (50Hz), 25.6 kHz (60Hz) per measuring channel
Mains frequency - Resolution	45Hz .. 65Hz 0.01Hz

¹⁾ The UMG 96RM-P/CBM can only detect measurements when a voltage L1-N greater than 20V eff (4-wire measurement) at voltage input V1 or a voltage L1-L2 greater than 34V eff (3-wire measurement) is applied.

Current measurement I1 - I4	
Rated current	5A
Measurement range	0 .. 6Arms
Crest factor	1.98
Resolution	0.1mA (Display 0.01A)
Overvoltage category	300V CAT II
Measurement surge voltage	2kV
Power consumption	ca. 0.2 VA (Ri=5mOhm)
Overload for 1 sec.	120A (sinusoidal)
Sampling frequency	21.33kHz (50Hz), 25.6 kHz (60Hz) per measurement channel

Connection capacity of the terminals (voltage and current measurement)		
Connectable conductor. Only one conductor may be connected per contact point!		
	Current	Voltage
Single-wire, multi-wire, finely stranded conductor	0.2 - 2.5mm ² , AWG 26-12	0.08 - 4.0mm ² , AWG 28-12
Pin terminals, ferrules	0.2 - 2.5mm ²	0.2 - 2.5mm ²
Tightening torque	0.4 - 0.5Nm	0.4 - 0.5Nm
Stripping length	7mm	7mm

Parameters of functions

Function	Symbol	Accuracy class	Metering range	Display range
Total real power	P	0.5 ⁵⁾ (IEC61557-12)	0 .. 5.4 kW	0 W .. 999 GW *
Total reactive power	QA, Qv	1 (IEC61557-12)	0 .. 5.4 kvar	0 varh .. 999 Gvar *
Total apparent power	SA, Sv	0.5 ⁵⁾ (IEC61557-12)	0 .. 5.4 kVA	0 VA .. 999 GVA *
Total active energy	Ea	0.5S ⁵⁾ 6) (IEC61557-12)	0 .. 5.4 kWh	0 Wh .. 999 GWh *
Total reactive energy	ErA, ErV	1 (IEC61557-12)	0 .. 5.4 kvarh	0 varh .. 999 Gvarh *
Total apparent energy	EapA, EapV	0.5 ⁵⁾ (IEC61557-12)	0 .. 5.4 kVAh	0 VAh .. 999 GVAh *
Frequency	f	0.05 (IEC61557-12)	45 .. 65 Hz	45.00 Hz .. 65.00 Hz
Phase current	I	0.2 (IEC61557-12)	0 .. 6 Arms	0 A .. 999 kA
Measured neutral conductor current	IN	-	-	-
Calculated neutral conductor current	INc	1.0 (IEC61557-12)	0.03 .. 25 A	0.03 A .. 999 kA
Voltage	U L-N	0.2 (IEC61557-12)	10 .. 300 Vrms	0 V .. 999 kV
Voltage	U L-L	0.2 (IEC61557-12)	18 .. 520 Vrms	0 V .. 999 kV
Displacement factor	PFA, PFV	0.5 (IEC61557-12)	0.00 .. 1.00	0.00 .. 1.00
Short-term flicker, long-term flicker	Pst, Plt	-	-	-
Voltage dips (L-N)	Udip	-	-	-
Voltage surges (L-N)	Uswl	-	-	-
Transient overvoltages	Utr	-	-	-
Voltage interruptions	Uint	-	-	-
Voltage unbalance (L-N) ¹⁾	Unba	-	-	-
Voltage unbalance (L-N) ²⁾	Unb	-	-	-
Voltage harmonics	Uh	Class 1 (IEC61000-4-7)	up to 2.5 kHz	0 V .. 999 kV
THD of the voltage ³⁾	THDu	1.0 (IEC61557-12)	up to 2.5 kHz	0 % .. 999 %
THD of the voltage ⁴⁾	THD-Ru	-	-	-

Function	Symbol	Accuracy class	Metering range	Display range
Current harmonics	lh	Class 1 (IEC61000-4-7)	up to 2.5 kHz	0 A .. 999 kA
THD of the current ³⁾	THDi	1.0 (IEC61557-12)	up to 2.5 kHz	0 % .. 999 %
THD of the current ⁴⁾	THD-Ri	-	-	-
Mains signal voltage	MSV	-	-	-

1) Referred to amplitude.

2) Referred to phase and amplitude.

3) Referred to mains frequency.

4) Referred to root mean square value.

5) Accuracy class 0.5 with ± 0.5 A transformer.

Accuracy class 1 with ± 1 A transformer.

6) Accuracy class 0.5S according IEC62053-22

* The display returns to 0 W when the maximum total energy values are reached.

Parameter and Modbus address list

The following excerpt from the parameter list contains settings that are necessary for proper operation of the UMG 96RM-P/-CBM, such as current transformers and device addresses. The values in the parameter list can be written and read.



A complete overview of the parameters and measured values as well as explanations regarding the selected measured values is filed in the document “Modbus Address List” on the CD or Internet.

In the excerpt, the measured value list files the measured and calculated measured values, output status data and recorded values so that they can be read.



The addresses contained in the description can be adjusted directly on the device in the range from 0 to 800. The address range above 1000 can only be processed via modbus!

Table 1 - Parameter list

Address	Format	RD/WR	Unit	Note	Adjustment Range	Default
0	SHORT	RD/WR	-	Device address (Modbus/Profibus)	0..255 (*1)	1
1	SHORT	RD/WR	kbps	Baud rate for Modbus (0=9.6kbps, 1=19.2kbps, 2=38.4kbps, 3= 57.6kbps, 4=115.2kbps)	0..7 (5..7 only for internal use)	4
2	SHORT	RD/WR	-	Modbus Master 0=Slave	0, 1	0
3	SHORT	RD/WR	-	Stoppbits 0 = 1 Bit, none parity 1 = 2 Bits, none parity 2 = 1 Bit, even parity 3 = 1 Bit, uneven parity	0..3	0
10	FLOAT	RD/WR	A	Current transformer I1, primary	0..1000000 ^{(*)2}	5
12	FLOAT	RD/WR	A	Current transformer I1, sec.	1..5	5

^{(*)1} The values 0 and 248 to 255 are reserved and must not be used.

^{(*)2} The adjustable value 0 does not produce any sensible energy values and must not be used.

Address	Format	RD/WR	Unit	Note	Adjustment Range	Default
14	FLOAT	RD/WR	V	Voltage transformer V1, prim.	0..1000000 ⁽²⁾	400
16	FLOAT	RD/WR	V	Voltage transformer V1, sec.	100, 400	400
18	FLOAT	RD/WR	A	Current transformer I2, primary	0..1000000 ⁽²⁾	5
20	FLOAT	RD/WR	A	Current transformer I2, sec.	1..5	5
22	FLOAT	RD/WR	V	Voltage transformer V2, prim.	0..1000000	400
24	FLOAT	RD/WR	V	Voltage transformer V2, sec.	100, 400	400
26	FLOAT	RD/WR	A	Current transformer I3, primary	0..1000000	5
28	FLOAT	RD/WR	A	Current transformer I3, sec.	1..5	5
30	FLOAT	RD/WR	V	Voltage transformer V3, prim.	0..1000000	400
32	FLOAT	RD/WR	V	Voltage transformer V3, sec.	100, 400	400
34	SHORT	RD/WR	Hz	Frequency determination 0=Auto, 45 .. 65=Hz	0, 45 .. 65	0
35	SHORT	RD/WR	-	Display contrast 0 (low), 9 (high)	0 .. 9	5
36	SHORT	RD/WR	-	Backlight 0 (dark), 9 (light)	0 .. 9	6
37	SHORT	RD/WR	-	Display profile 0=default display profile 1=default display profile 2=default display profile 3=freely selectable display profile	0 .. 3	0
38	SHORT	RD/WR	-	Display change profile 0..2=default display change profiles 3=freely selectable display change profile	0 .. 3	0
39	SHORT	RD/WR	s	Changeover time	0 .. 60	0
40	SHORT	RD/WR	-	Averaging time, I	0 .. 8*	6
41	SHORT	RD/WR	-	Averaging time, P	0 .. 8*	6
42	SHORT	RD/WR	-	Averaging time, U	0 .. 8*	6

* 0 = 5sec.; 1 = 10sec.; 2 = 15sec.; 3 = 30sec.; 4 = 1min.; 5 = 5min.; 6 = 8min.; 7 = 10min.; 8 = 15min.

Address	Format	RD/WR	Unit	Note	Adjustment Range	Default
45	USHORT	RD/WR	mA	Response threshold of current measuring I1 .. I3	0 .. 200	5
50	SHORT	RD/WR	-	Password	0 .. 999	0 (no password)
100	SHORT	RD/WR	-	Address of the measured value, Digital output 1	0..32000	874
101	SHORT	RD/WR	-	Address of the measured value, Digital output 2	0..32000	882
102	FLOAT	RD/WR	Wh	Pulse value, Digital output 1	-1000000..+1000000	1000
104	FLOAT	RD/WR	Wh	Pulse value, Digital output 2	-1000000..+1000000	1000
106	SHORT	RD/WR	10ms	Minimum pulse length (1=10 ms) Digital output 1/2	1..1000	5 (=50 ms)
206	SHORT	RD/WR	s	"Drag indicator" period duration	300..3600	900
207	SHORT	RD/WR	s	"Drag indicator" capture time	1..20	10
208	SHORT	RD/WR	-	Config. Digital input 1 0= internal synchronisation 1= external synchronisation (NO) 2= external synchronisation (NC)	0 .. 2	0
500	SHORT	RD/WR	-	Terminal assignment, I L1	-3..0..+3 ¹⁾	+1
501	SHORT	RD/WR	-	Terminal assignment, I L2	-3..0..+3 ¹⁾	+2
502	SHORT	RD/WR	-	Terminal assignment, I L3	-3..0..+3 ¹⁾	+3
503	SHORT	RD/WR	-	Terminal assignment, U L1	0..3 ¹⁾	1
504	SHORT	RD/WR	-	Terminal assignment, U L2	0..3 ¹⁾	2
505	SHORT	RD/WR	-	Terminal assignment, U L3	0..3 ¹⁾	3
506	SHORT	RD/WR	-	Clear min. and max. values	0..1	0
507	SHORT	RD/WR	-	Clear energy meter	0..1	0
508	SHORT	RD/WR	-	Force write EEPROM.	0..1	0
Note: Energy values and minimum and maximum values are written to the EEPROM every 5 minutes.						

¹⁾ 0 = No measurement of the current or voltage path.

²⁾ The setting 8 is equal setting 0.

Address	Format	RD/WR	Unit	Note	Adjustment Range	Default
509	SHORT	RD/WR	-	Voltage connection diagram	0..8 ²	0
510	SHORT	RD/WR	-	Current connection diagram	0..8	0
511	SHORT	RD/WR	-	Relative voltage for THD and FFT	0, 1	0
The voltages for THD and FFT can be shown on the display as L-N or L-L values. 0=LN, 1=LL						
512	SHORT	RD/WR	-	Year	0..99 ²	
513	SHORT	RD/WR	-	Month	0..12 ²	
514	SHORT	RD/WR	-	Day	0..31 ²	
515	SHORT	RD/WR	-	Hour	0..24 ²	
516	SHORT	RD/WR	-	Minute	0..59 ²	
517	SHORT	RD/WR	-	Second	0..59 ²	
600	UINT	RD/WR	-	Metering range exceedance	0..0xFFFFFFFF	
750	SHORT	RD	-	Software release		
754	SERNR	RD	-	Serial number		
756	SERNR	RD	-	Production number		
746	SHORT	RD/WR	s	Period of time after which the backlight will switch to standby	60 .. 9999	900
747	SHORT	RD/WR	s	Brightness of the standby backlight	0 .. 9	0



Only the first three positions (###) of a value are shown on the display. Values larger than 1,000 are marked with „k”. Example: 003k = 3000

Table 2 - Modbus address list

(frequently used measured values)



The addresses contained in the description can be adjusted directly on the device in the range from 0 to 800. The address range 800-999 is available for programming comparators on the device. The addresses above 1000 can only be processed via modbus!



A complete overview of the parameters and measured values as well as explanations regarding the selected measured values is filed in the document "Modbus Address List" on the CD or Internet.

Modbus Address	Address Above display	Format	RD/WR	Unit	Note
19000	808	float	RD	V	Voltage L1-N
19002	810	float	RD	V	Voltage L2-N
19004	812	float	RD	V	Voltage L3-N
19006	814	float	RD	V	Voltage L1-L2
19008	816	float	RD	V	Voltage L2-L3
19010	818	float	RD	V	Voltage L3-L1
19012	860	float	RD	A	Current, L1
19014	862	float	RD	A	Current, L2
19016	864	float	RD	A	Current, L3
19018	866	float	RD	A	Vector sum; $I_N=I_1+I_2+I_3$
19020	868	float	RD	W	Real power L1
19022	870	float	RD	W	Real power L2
19024	872	float	RD	W	Real power L3
19026	874	float	RD	W	Sum; $P_{sum3}=P_1+P_2+P_3$
19028	884	float	RD	VA	Apparent power S L1
19030	886	float	RD	VA	Apparent power S L2

Modbus Address	Address Above display	Format	RD/WR	Unit	Note
19032	888	float	RD	VA	Apparent power S L3
19034	890	float	RD	VA	Sum; Ssum3=S1+S2+S3
19036	876	float	RD	var	Fund. reactive power (mains frequ.) Q L1
19038	878	float	RD	var	Fund. reactive power (mains frequ.) Q L2
19040	880	float	RD	var	Fund. reactive power (mains frequ.) Q L3
19042	882	float	RD	var	Sum; Qsum3=Q1+Q2+Q3
19044	820	float	RD	-	Fund.power factor, CosPhi; U L1-N IL1
19046	822	float	RD	-	Fund.power factor, CosPhi; U L2-N IL2
19048	824	float	RD	-	Fund.power factor, CosPhi; U L3-N IL3
19050	800	float	RD	Hz	Measured frequency
19052	-	float	RD	-	Rotation field; 1=right, 0=none, -1=left
19054	-	float	RD	Wh	Real energy L1
19056	-	float	RD	Wh	Real energy L2
19058	-	float	RD	Wh	Real energy L3
19060	-	float	RD	Wh	Real energy L1..L3
19062	-	float	RD	Wh	Real energy L1, consumed
19064	-	float	RD	Wh	Real energy L2, consumed
19066	-	float	RD	Wh	Real energy L3, consumed
19068	-	float	RD	Wh	Real energy L1..L3, consumed, rate 1
19070	-	float	RD	Wh	Real energy L1, delivered
19072	-	float	RD	Wh	Real energy L2, delivered
19074	-	float	RD	Wh	Real energy L3, delivered
19076	-	float	RD	Wh	Real energy L1..L3, delivered
19078	-	float	RD	VAh	Apparent energy L1
19080	-	float	RD	VAh	Apparent energy L2
19082	-	float	RD	VAh	Apparent energy L3
19084	-	float	RD	VAh	Apparent energy L1..L3
19086	-	float	RD	varh	Reactive energy L1
19088	-	float	RD	varh	Reactive energy L2
19090	-	float	RD	varh	Reactive energy L3
19092	-	float	RD	varh	Reactive energy L1..L3

Modbus Address	Address Above display	Format	RD/WR	Unit	Note
19094	-	float	RD	varh	Reactive energy, inductive, L1
19096	-	float	RD	varh	Reactive energy, inductive, L2
19098	-	float	RD	varh	Reactive energy, inductive, L3
19100	-	float	RD	varh	Reactive energy L1..L3, ind.
19102	-	float	RD	varh	Reactive energy, capacitive, L1
19104	-	float	RD	varh	Reactive energy, capacitive, L2
19106	-	float	RD	varh	Reactive energy, capacitive, L3
19108	-	float	RD	varh	Reactive energy L1..L3, cap.
19110	836	float	RD	%	Harmonic, THD, U L1-N
19112	838	float	RD	%	Harmonic, THD, U L2-N
19114	840	float	RD	%	Harmonic, THD, U L3-N
19116	908	float	RD	%	Harmonic, THD, I L1
19118	910	float	RD	%	Harmonic, THD, I L2
19120	912	float	RD	%	Harmonic, THD, I L3

Modbus adress	Address via display	Format	RD/WR	Unit	Note	Adjustment Range	Default
20022	-	float	RD/WR	A	Current transformer I4, primary	0...1000000	5
20024	-	float	RD/WR	A	Current transformer I4, sec.	1..5	5

Number formats

Type	Size	Minimum	Maximum
short	16 bit	-2^{15}	$2^{15} - 1$
ushort	16 bit	0	$2^{16} - 1$
int	32 bit	-2^{31}	$2^{31} - 1$
uint	32 bit	0	$2^{32} - 1$
float	32 bit	IEEE 754	IEEE 754



Notes on saving measurement values and configuration data:

- The following measurement values are saved at least every 5 minutes:
 - Comparator timer
 - S0 meter readings
 - Minimum / maximum / mean values
 - Energy values
- Configuration data is saved immediately!

Dimension diagrams

All dimensions in mm.

Rear view of UMG 96RM-P

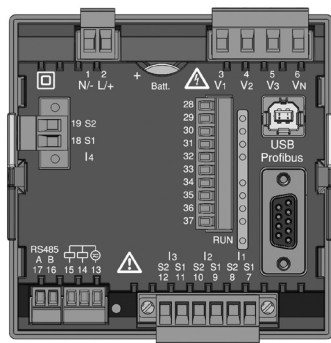

Side view of UMG 96RM-P with USB and Profibus connectors inserted

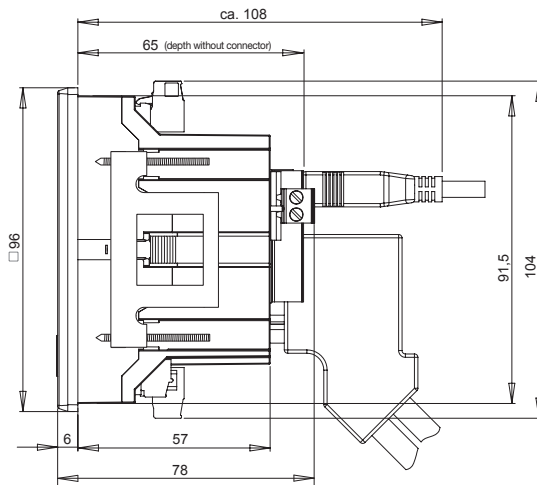

Rear view of UMG 96RM-CBM

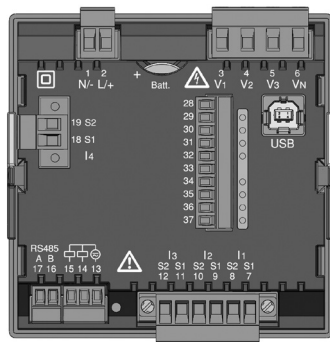
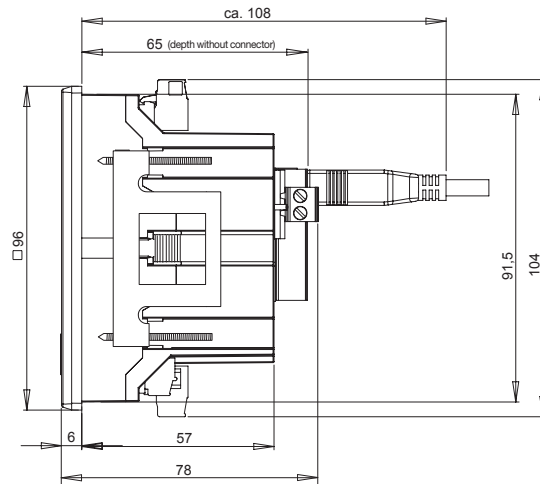
 Side view of UMG 96RM-CBM
with USB connector inserted

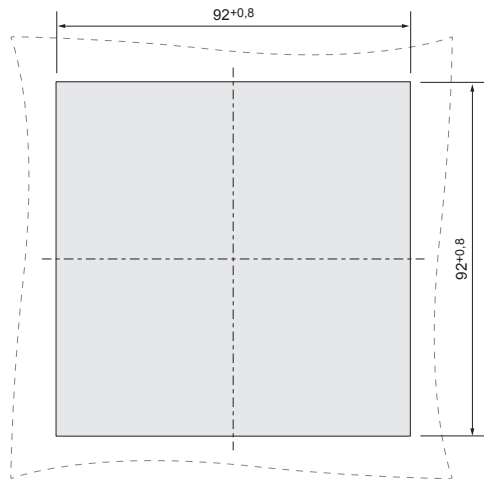
Cutout dimensions

Overview of measured value displays

▲ A01 Measured values L1-N voltage L2-N voltage L3-N voltage	▶ B01 Mean values L1-N voltage L2-N voltage L3-N voltage	▶ C01 Maximum values L1-N voltage L2-N voltage L3-N voltage	▶ D01 Minimum values L1-N voltage L2-N voltage L3-N voltage
▲ A02 Measured values L1-L2 voltage L2-L3 voltage L3-L1 voltage	B02 Mean values L1-L2 voltage L2-L3 voltage L3-L1 voltage	C02 Maximum values L1-L2 voltage L2-L3 voltage L3-L1 voltage	D02 Minimum values L1-L2 voltage L2-L3 voltage L3-L1 voltage
▲ A03 Measured values L1 current L2 current L3 current	B03 Mean values L1 current L2 current L3 current	C03 Maximum values L1 current L2 current L3 current	D03 Max. values (mean value) L1 current L2 current L3 current
▲ A04 Measured value Sum Current in the N line	B04 Mean value Sum Current in the N line	C04 Maximum value Measured value sum Current in the N line	D04 Maximum values Sum mean value Current in the N line
▲ A05 Measured values L1 active power L2 active power L3 active power	B05 Mean value L1 active power L2 active power L3 active power	C05 Maximum values L1 active power L2 active power L3 active power	
▲ A06 Measured value Sum Active power	B06 Mean value Sum Active power	C06 Maximum value Sum Active power	D06 Maximum value Sum Active power mean value
▲ A07 Measured values L1 apparent power L2 apparent power L3 apparent power	B07 Mean values L1 apparent power L2 apparent power L3 apparent power	C07 Maximum values L1 apparent power L2 apparent power L3 apparent power	

△ A08 Measured value Sum Apparent power	▷ B08 Mean value Sum Apparent power	▷ C08 Maximum value Sum Apparent power
△ A09 Measured values L1 reactive power L2 reactive power L3 reactive power	▷ B09 Mean values L1 reactive power L2 reactive power L3 reactive power	▷ C09 Maximum values (ind) L1 reactive power L2 reactive power L3 reactive power
△ A10 Measured value Sum of reactive power	▷ B10 Mean value Sum of reactive power	▷ C10 Maximum value (ind) Sum of reactive power
△ A11 Measured value Distortion factor (THD) U L1	▷ B11 Measured value Distortion factor (THD) U L2	▷ C11 Measured value Distortion factor (THD) U L3
△ A12 Measured value Distortion factor (THD) I L1	▷ B12 Measured value Distortion factor (THD) I L2	▷ C12 Measured value Distortion factor (THD) I L3
△ A13 Maximum value Distortion factor (THD) U L1	▷ B13 Maximum value Distortion factor (THD) U L2	▷ C13 Maximum value Distortion factor (THD) U L3
△ A14 Maximum value Distortion factor (THD) I L1	▷ B14 Maximum value Distortion factor (THD) I L2	▷ C14 Maximum value Distortion factor (THD) I L3







△	A15						
	Measured value L1 cos(phi) L2 cos(phi) L3 cos(phi)						
△	A16	B16					
	Measured value Sum of cos(phi)	Mean value Sum of cos(phi)					
△	A17						
	Measured value Frequency L1 Rotation field display						
△	A18	B18	C18	D18	E18	F18	G18
	Measured value Total active energy (without a backstop)	Measured value Total active energy (import)	Measured value Total active energy (export)	Measured value Sum Apparent energy	Measured value Active energy L1 Import (tariff 1)	Measured value Active energy L2 Import (tariff 1)	Measured value Active energy L3 Import (tariff 1)
△	A19	B19	C19	D19	E19	F19	
	Measured value (ind) Reactive energy	Measured value Sum Reactive energy cap.	Measured value Sum Reactive energy ind.	Measured value Reactive energy L1 ind. (tariff 1)	Measured value Reactive energy L2 ind. (tariff 1)	Measured value Reactive energy L3 ind. (tariff 1)	
△	A20	B20		G20			
	Operating hours meter 1	Comparator 1A* Total running time	...	Comparator 2C* Total running time			
△	A21	B21		H21			
	Measured value 1st. harmonic U L1	Measured value 3rd. harmonic U L1	...	Measured value 15th. harmonic U L1			

Marked menus are not displayed in the factory presetting.

* Only the first 6 comparators are shown.

<p>△ A22</p> <p>Measured value 1st. harmonic U L2</p>	<p>▷ B22</p> <p>Measured value 3rd. harmonic U L2</p>	...	<p>▷ H22</p> <p>Measured value 15th. harmonic U L2</p>
<p>△ A23</p> <p>Measured value 1st. harmonic U L3</p>	<p>B23</p> <p>Measured value 3rd. harmonic U L3</p>	...	<p>H23</p> <p>Measured value 15th. harmonic U L3</p>
<p>△ A24</p> <p>Measured value 1st. harmonic I L1</p>	<p>B24</p> <p>Measured value 3rd. harmonic I L1</p>	...	<p>H24</p> <p>Measured value 15th. harmonic I L1</p>
<p>△ A25</p> <p>Measured value 1st. harmonic I L2</p>	<p>B25</p> <p>Measured value 3rd. harmonic I L2</p>	...	<p>H25</p> <p>Measured value 15th. harmonic I L2</p>
<p>△ A26</p> <p>Measured value 1st. harmonic I L3</p>	<p>B26</p> <p>Measured value 3rd. harmonic I L3</p>	...	<p>H26</p> <p>Measured value 15th. harmonic I L3</p>
<p>△ A27</p> <p>Maximum value 1st. harmonic U L1</p>	<p>B27</p> <p>Maximum value 3rd. harmonic U L1</p>	...	<p>H27</p> <p>Maximum value 15th. harmonic U L1</p>
<p>△ A28</p> <p>Maximum value 1st. harmonic U L2</p>	<p>B28</p> <p>Maximum value 3rd. harmonic U L2</p>	...	<p>H28</p> <p>Maximum value 15th. harmonic U L2</p>

Marked menus are not displayed in the factory presetting.

 A29	 B29		 H29
Maximum value 1st. harmonic U L3	Maximum value 3rd. harmonic U L3	...	Maximum value 15th. harmonic U L3
 A30	B30		H30
Maximum value 1st. harmonic I L1	Maximum value 3rd. harmonic I L1	...	Maximum value 15th. harmonic I L1
 A31	B31		H31
Maximum value 1st. harmonic I L2	Maximum value 3rd. harmonic I L2	...	Maximum value 15th. harmonic I L2
 A32	B32		H32
Maximum value 1st. harmonic I L3	Maximum value 3rd. harmonic I L3	...	Maximum value 15th. harmonic I L3
 A33	B33	C33	D33
Measured values L4 current	Mean values L4 current	Maximum values L4 current	Max. values (mean value) L4 current

Even and **odd** harmonics up to the **40th order** can be called up via the GridVis software and can be viewed in the software.

 Marked menus are not displayed in the factory presetting.

Connection example

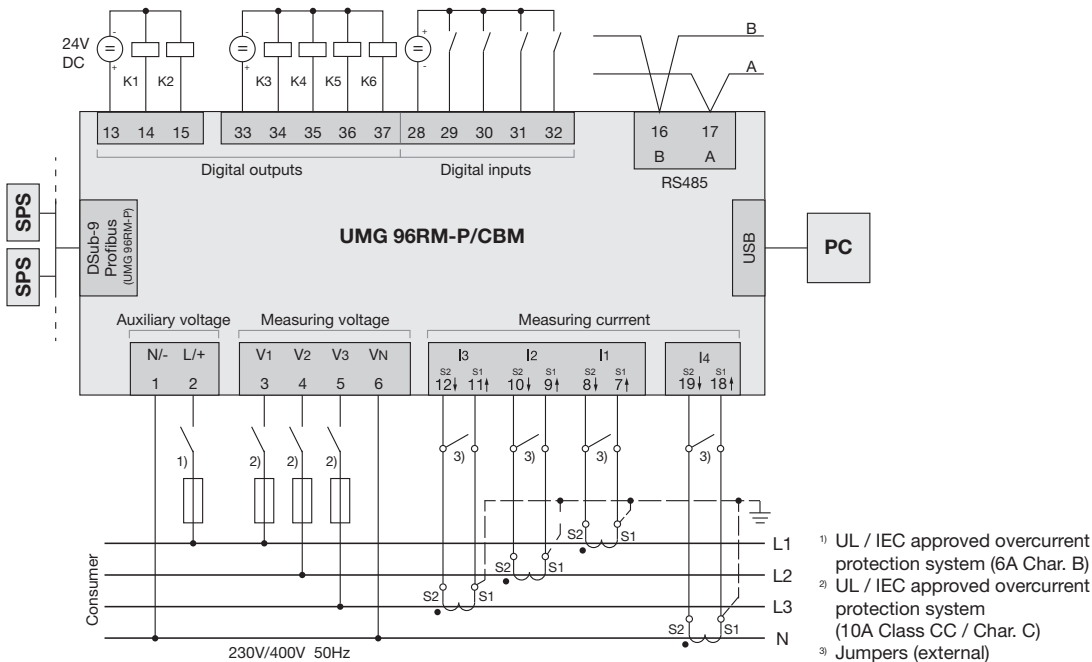

Basic functions quick guide

Adjusting the current transformer

Switch to the programming mode:

- Press button 1 and 2 simultaneously for around 1 second to switch to the programming mode. The symbols for the programming mode PRG and the current transformer mode CT appear on the display.
- Press button 1 to confirm the selection.
- The first digit of the input field for the primary current is flashing.

Adjusting the primary current

- Press button 2 to change the flashing digit.
- Press button 1 to select the next digit to be changed. The selected digit to be changed is flashing. If the entire number is flashing, press button 2 to move the decimal point.

Adjusting the secondary current

- Only 1A or 5A can be set as secondary current.
- Press button 1 to select the secondary current.
- Press button 2 to change the flashing digit.

Exit programming mode

- Press button 1 and 2 simultaneously for around 1 second to switch to the display mode.

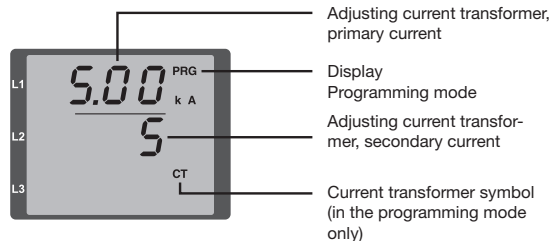

View measured values

Switch to the display mode:

- If you are still in the programming mode (PRG and CT icons displayed on the screen), press button 1 and 2 simultaneously for around 1 second to switch to the display mode.
- A measured value display (e.g. voltage) appears

Button controls

- Press button 2 to change the measured value display for current, voltage, power, etc.
- Press button 1 to change the mean values, max. values etc. associated with the measured value.

