

Janitza electronics GmbH
 Vor dem Polstück 1
 D-35633 Lahnau
 Support tel. 0049 6441 9642-22
 Fax 0049 6441 9642-30
 E-mail: info@janitza.com
 Internet: http://www.janitza.com

Power Analyser

UMG 96 RM

Basic device

Operating instructions and
 technical data

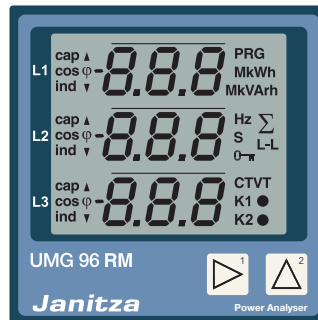

Janitza®

Table of Contents

General	4	Commissioning	54
Incoming goods inspection	6	Applying the supply voltage	54
Scope of delivery of the basic device	7	Applying the measured voltage	54
Available accessories	7	Applying the measured current	54
Product description	8	Rotation field direction	55
Intended use	8	Checking the phase assignment	55
Characteristics of the basic device	9	Checking the power measurement	55
Measuring method	10	Checking the measurement	55
GridVis network analysis software	11	Checking the individual power ratings	55
Connection options	11	Check the sum power ratings	56
Assembly	12	RS485 interface	57
Installation	14	Digital outputs	59
Supply voltage	14	Pulse output	61
Voltage metering	16	Comparator	67
Current measurement	22	Service and maintenance	70
RS485 interface	29	Error messages	71
Digital outputs	32	Technical data	78
Operation	34	Parameters of functions	82
Display mode	34	Table 1 - Parameter list	84
Programming mode	34	Table 2 - Modbus address list	90
Parameters and measured values	36	Dimensional drawings	94
Configuration	38	Overview of measured value displays	96
Applying the supply voltage	38	Declaration of conformity	102
Current and voltage transformers	38	Connection example	103
Programming current transformers	40	Brief instructions	104
Programming voltage transformers	41		
Programming parameters	42		

General

Copyright

This manual is subject to the laws of copyright protection and may not be mechanically or electronically photocopied, reprinted, reproduced or otherwise reproduced or published in part or as a whole, without the legally binding, written consent of

Janitza electronics GmbH, Vor dem Polstück 1,
D 35633 Lahnu, Germany.

Trademarks

All trademarks and the rights resulting from them remain the property of the trademark holder of these rights.

Disclaimer

Janitza electronics GmbH assumes no responsibility for errors or omissions in this manual and assumes no obligation to keep the contents of this manual up to date.

Comments about the manual

Your comments are welcome. If anything in this manual is unclear, please let us know and send us an e-mail at: info@janitza.com

Meaning of the symbols

The following pictograms are used in this manual:



Dangerous voltage!

Risk of death or serious injury. Disconnect the power before working on the system and device.



Attention!

Please refer to the documentation. This symbol will warn you of possible dangers that could occur during assembly, commissioning and operation.



Note!

Application notes

Please read these operating instructions and all other publications that must be consulted in order to work with this product (particularly for installation, operation or maintenance).

Please observe all safety regulations and warnings. Non-compliance with the instructions can lead to personal injury and/or damage to the product.

Any unauthorised alteration or use of this device which exceeds the specified mechanical, electrical or other operational limits can cause personal injury and/or damage to the product.

Any such unauthorised alterations are grounds for "abuse" and/or "negligence" in terms of the product's guarantee and thus excludes the warranty for covering any possible resulting damages.

This device must only be operated and maintained by qualified personnel.

Qualified personnel are persons who, due to their respective training and experience, are able to recognise risks and avoid potential hazards that can be caused by operation or maintenance of the device.

When using the device, the legal and safety regulations required for the respective application must also be observed.



Safety is no longer guaranteed and the device may be dangerous if the device is not operated according to the operating instructions.



Conductors consisting of single wires must be provided with ferrules.



Only screw terminals with the same number of poles and the same type may be plugged together.

About these operating instructions

These operating instructions are part of the product.

- Read the operating instructions prior to using the device.
- Keep the operating instructions at hand throughout the entire service life of the product and keep ready for referencing.
- Hand over the operating instructions to each subsequent owner or user of the product.



All supplied screw terminals are attached to the device.

Incoming goods inspection

The proper and safe operation of this device requires appropriate transport, proper storage, installation and assembly as well as careful operation and maintenance. When it is assumed that safe operation is no longer possible, the device must immediately be taken out of operation and secured against accidental start-up.

Unpacking and packing must be carried out with the usual care, without the use of force and only with the use of suitable tools. The devices must be visually inspected for proper mechanical condition.

It can be assumed that safe operation is no longer possible if the device, e.g.

- shows visible damage,
- does not work despite intact power supply,
- and was exposed to unfavourable conditions (e.g. storage outside of the permissible climatic limits without adaptation to the ambient climate, condensation, etc.) or transport stresses (e.g. falling from a great height even without exterior visible damage, etc.) for prolonged periods.
- Please check that the delivery is complete before you begin with installation of the device.

Scope of delivery of the basic device

Quantity	Item no.	Designation
1	52.22.051	UMG 96RM
2	29.01.036	Mounting brackets.
1	33.03.177	Operating instructions.
1	51.00.116	CD with the following contents. - GridVis programming software - GridVis functional description
1	10.01.855	Screw terminal, pluggable, 2-pin (auxiliary energy)
1	10.01.849	Screw terminal, pluggable, 4-pin (voltage measurement)
1	10.01.871	Screw terminal, pluggable, 6-pin (current measurement)
1	10.01.857	Screw terminal, pluggable, 2-pin (RS 485)
1	10.01.859	Screw terminal, pluggable, 3-pin (digital/pulse output)
1	52.00.008	RS485, external terminating resistor, 120 ohm

Available accessories

Item no.	Designation
29.01.907	Seal, 96 x 96
15.06.015	Interface converter RS485 <-> RS232
15.06.025	Interface converter RS485 <-> USB

Product description

Intended use

The UMG 96RM is provided for the measurement and calculation of electrical parameters such as voltage, current, power, energy, harmonics, etc. for building installations, to distributors, circuit breakers and busbar trunking systems.

The UMG 96RM is suitable for installation in permanent, weatherproof switchboards. Conducting switchboards must be earthed. It can be mounted in any position.

Measurement voltages and measurement currents must originate from the same grid.

The measurement results can be displayed and can be read and processed over the RS485 interface.

The voltage measurement inputs are designed for measuring in low voltage grids in which nominal voltages up to 300V phase can occur in countercurrent with ground and overvoltages of overvoltage category III.

The UMG 96RM current measurement inputs are connected via external $\dots/1A$ or $\dots/5A$ current transformers.

Measurements in medium and high voltage systems generally use current and voltage transformers.

The UMG 96RM can be used in residential and industrial areas.

Device characteristics

- Installation depth: 45 mm
- Supply voltage:
20V - 250V (45..65Hz) or DC 20V - 300V
- Frequency range: 45-65 Hz

Device functions

- 3 voltage measurements, 300 V
- 3 current measurements (via current transformer)
- RS485 interface
- 2 digital outputs

Characteristics of the basic device

- General
 - Front panel-mounted with the dimensions 96x96 mm.
 - Connection via screw-type terminals.
 - LC display with backlighting.
 - Operation via 2 buttons.
 - 3 voltage measurements inputs (300V CATIII).
 - 3 current measurement inputs for current transformer.
 - RS485 interface (Modbus RTU, slave, to 115 kbps).
 - 2 digital outputs.
 - Working temperature range -10°C .. +55°C.
 - Storage of minimum and maximum values (without time stamp).
- Measurement uncertainty
 - Active energy, measuring uncertainty class 0.5 for ..1/5 A transformer.
 - Active energy, measuring uncertainty class 1 for ..1/1 A transformer.
 - Reactive energy, class 2.
- Measurement
 - Measurement in IT, TN and TT networks.
 - Measurement in networks with nominal voltages up to L-L 480 V and L-N 277 V.
 - Current metering range 0 .. 5 Aeff.
 - True root mean square measurement (TRMS).
 - Continuous scanning of voltage and current measurement inputs.
 - Frequency range of the mains frequency 45 Hz .. 65 Hz.
 - Measurement of harmonics 1 to 40 for ULN and I.
 - Uln, I, P (import/delivery), Q (ind./cap.).
 - Recording of more than 800 measured values.
 - Fourier analyses 1 to 40. Harmonic for U and I.
 - 7 power meter for
 - Active energy (import)
 - Active energy (export)
 - Active energy (without a backstop)
 - Reactive energy (ind.)
 - Reactive energy (capacitive)
 - Reactive energy (without a backstop)
 - Apparent energy
 - each for L1, L2, L3 and total.
 - 8 tariffs (switching via Modbus).

Measuring method

The UMG 96RM measures uninterrupted and calculates all root mean squares over a 10/12-period interval. The UMG 96RM measures the true root mean square (TRMS) of the voltages and currents applied to the measuring inputs.

Operating concept

There are several ways to program the UMG 96RM and retrieve measured values.

- Directly on the device using two buttons.
- Via the programming software of the GridVis.
- Via the RS485 interface with the Modbus protocol. Data can be changed and retrieved with the help of the Modbus address list (stored on the accompanying data carrier).

These operating instructions only describe the operation of the UMG 96RM using the 2 buttons.

The programming software of the GridVis has its own "online help".

GridVis network analysis software

The UMG 96RM can be programmed and read with the GridVis network analysis software which is part of the scope of delivery. For this, a PC must be connected to the RS485 interface of the UMG 96RM via a serial interface (RS485/Ethernet).

Characteristics of GridVis

- Programming the UMG 96RM
- Graphic representation of measured values

Connection options

Connection of a UMG 96RM to a PC via an interface converter:

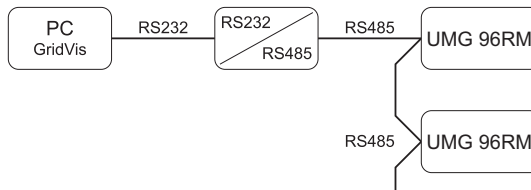

Connection of a UMG 96RM via a UMG 604 as a gateway:

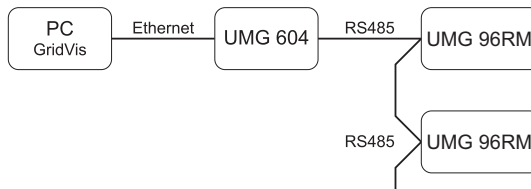

Assembly

Installation location

The UMG 96RM is suitable for installation in permanent, weatherproof switchboards. Conducting switchboards must be earthed.

Installation position

The UMG 96RM must be installed vertically in order to achieve sufficient ventilation. The clearance to the top and bottom must be at least 50 mm and 20 mm at the sides.

Front panel cutout

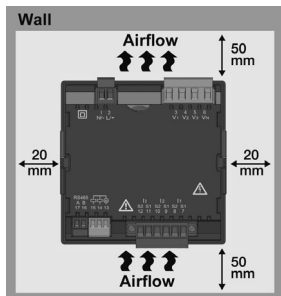

Cutout dimensions:
 $92^{+0.8} \times 92^{+0.8}$ mm.

*Fig. UMG 96RM
 installation location
 (rear view)*

Mounting

The UMG 96RM is mounted on the switchboard by the side mounting brackets. These must be removed before using the device. Mounting is carried out by inserting and engaging the brackets.

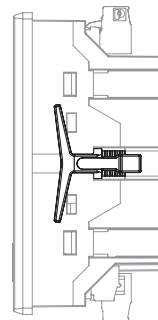

*Fig. UMG 96RM
 mounting bracket
 (side view)*



Failure to comply with the minimum spacing can destroy the UMG 96RM at high ambient temperatures!

Installation

Supply voltage

A supply voltage is required to operate the UMG 96RM.

The voltage supply is connected via plug-in terminals on the back of the device.

Before applying the supply voltage, ensure that the voltage and frequency correspond with the details on the nameplate!

The supply voltage must be connected via an approved UL / IEC circuit breaker (6 A Char. B).

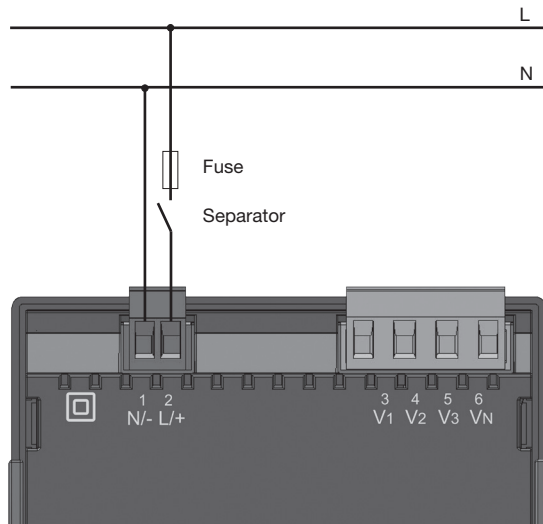

Fig. Connection example of the supply voltage to the UMG 96RM



- In building installations, the supply voltage must be provided with a disconnect switch or circuit breaker.
- The disconnect switch must be attached near the device and must be easily accessible by the user.
- The switch must be labelled as a separator for this device.
- Voltages that exceed the permissible voltage range can destroy the device.

Voltage metering

The UMG 96RM can be used for voltage measurement in TN, TT and IT systems.

Voltage measurement in the UMG 96RM is designed for the 300 V overvoltage category CATIII (4 kV rated pulse voltage).

In systems without a neutral, measured values that require a neutral refer to a calculated neutral.

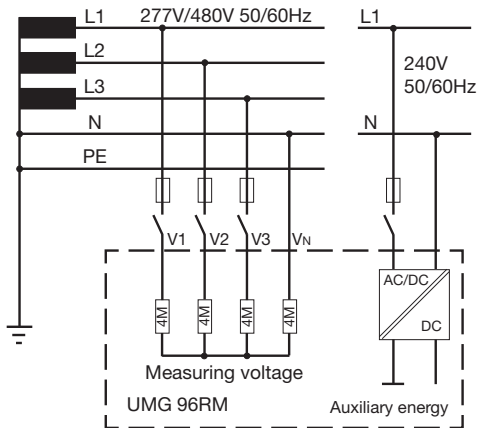

Fig. Principle circuit diagram - Measurement in three-phase 4-wire systems.

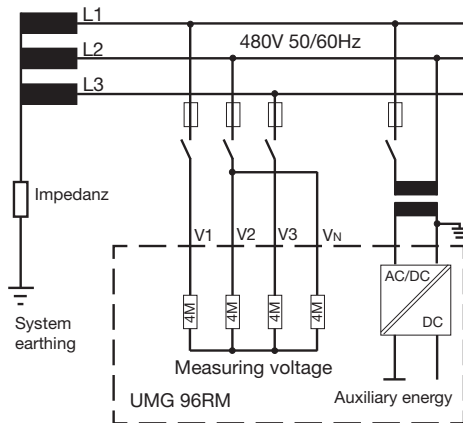

Fig. Principle circuit diagram - Measurement in three-phase 3-wire systems.

Rated mains voltage

Lists of the networks and their rated mains voltage in which the UMG 96RM can be used.

Three-phase 4-wire systems with earthed neutral conductor.

U_{L-N} / U_{L-L}
66 V/115 V
120 V/208 V
127 V/220 V
220 V/380 V
230 V/400 V
240 V/415 V
260 V/440 V
277 V/480 V

Maximum rated voltage of the network

Fig. Table of the rated mains voltages suitable for the voltage measuring inputs according to EN60664-1:2003.

Unearthed three-phase, 3-wire systems.

U_{L-L}
66 V
120 V
127 V
220 V
230 V
240 V
260 V
277 V
347 V
380 V
400 V
415 V
440 V
480 V

Maximum rated voltage of the network

Fig. Table of the rated mains voltages suitable for the voltage measuring inputs according to EN60664-1:2003.

Voltage measurement inputs

The UMG 96RM has three voltage measurement inputs (V1, V2, V3).

Overvoltage

The voltage measurement inputs are suitable for measurement in networks in which overvoltages of overvoltage category 300V CATIII (4 kV rated pulse voltage) can occur.

Frequency

The UMG 96RM requires the mains frequency for the measurement and calculation of measured values.

The UMG 96RM is suitable for measurements in the frequency range of 45 to 65 Hz.

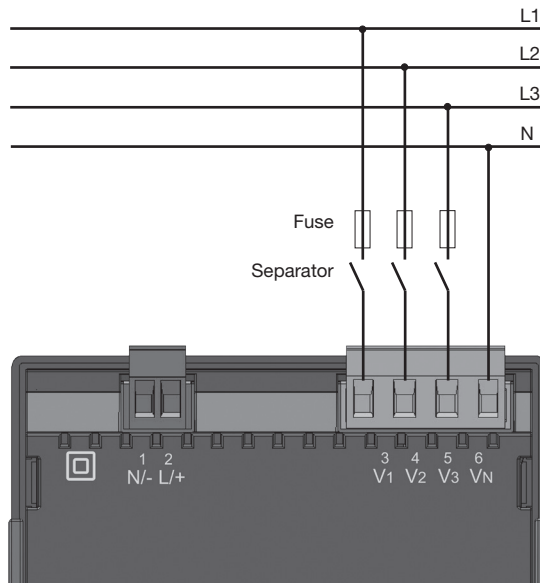

Fig. Connection example for the voltage measurement

When connecting the voltage measurement, the following must be observed:

- A suitable separator must be provided in order to switch off the power to the UMG 96RM.
- The separator must be placed near the UMG 96RM, marked for the user and easily accessible.
- Use an approved UL / IEC cylindrical fuse (10 A Class CC) or circuit breaker (10 A C-Char.) as an overcurrent protection device and separator.
- Measurement voltages and measurement currents must originate from the same grid

**Attention!**

Voltages that exceed the permitted rated mains voltages must be connected via voltage transformers.

**Attention!**

The UMG 96RM is not suitable for the measurement of DC voltages.

**Attention!**

The voltage measurement inputs on the UMG 96RM are dangerous to touch!

Connection diagram, voltage measurement

- 3p 4w (addr. 509 = 0), factory setting

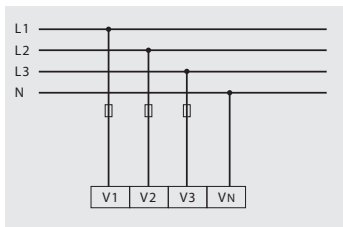

Fig. System with three-phase conductors and a neutral conductor.

- 3p 4u (addr. 509 = 2)

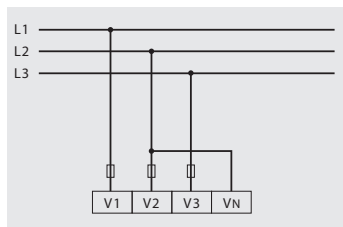

Fig. System with three-phase conductors and no neutral conductor. Measured values that require a neutral refer to a calculated neutral.

- 3p 4wu (addr. 509 = 1)

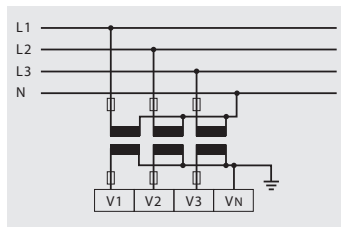

Fig. System with three-phase conductors and a neutral conductor. Measurement via voltage transformer.

- 3p 2u (addr. 509 = 5)

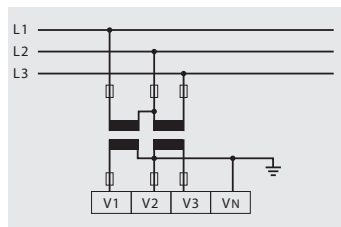

Fig. System with three-phase conductors and no neutral conductor. Measurement via voltage transformer. Measured values that require a neutral refer to a calculated neutral.

- 1p 2w1 (addr. 509 = 4)

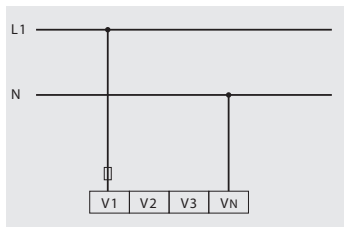

Fig. Measured values derived from the V2 and V3 voltage measurement inputs are assumed to be zero and not calculated.

- 1p 2w (addr. 509 = 6)

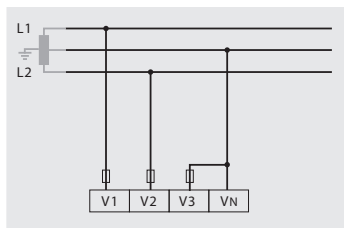

Fig. TN-C system with single-phase, three-wire connection. Measured values derived from the V3 voltage measurement input Zero are assumed to be zero and not calculated.

- 2p 4w (addr. 509 = 3)

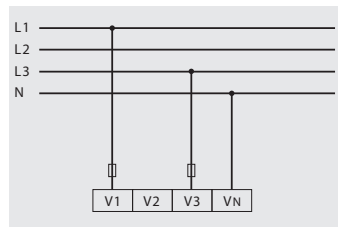

Fig. System with uniform phase loading. The measured values for the V2 voltage measurement input are calculated.

- 3p 1w (addr. 509 = 7)

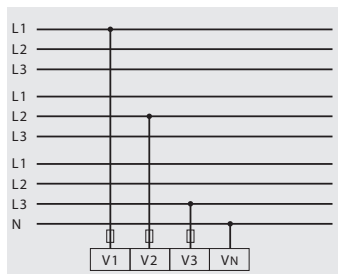

Fig. Three systems with uniform phase loading. The measurement values L2/L3 resp. L1/L3 resp. L1/L2 of the respective system are calculated.

Current measurement

The UMG 96RM is designed for connecting current transformers with secondary currents of $\dots/1\text{A}$ and $\dots/5\text{A}$. The factory set current transformer ratio is $5/5\text{ A}$ and may need to be adapted to the current transformers.

It is not possible to perform a direct measurement without a current transformer with the UMG 96RM.

Only AC currents (and not DC currents) can be measured.

The test leads must be designed for an operating temperature of at least 80°C .

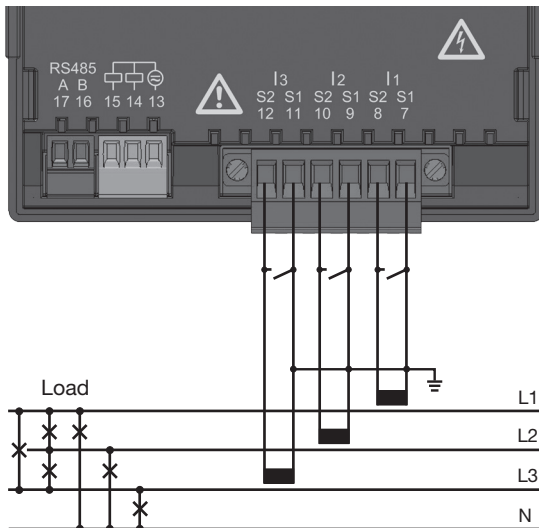

Fig. Current measurement via current transformer (connection example)



Attention!

The current measurement inputs are dangerous to touch.



Attention!

The UMG 96RM is not suitable for the measurement of DC voltages.



Earthing current transformers!

If a connection is provided for earthing the secondary winding, it must be connected to the earth.



The attached screw terminal has to be fixed sufficiently with two screws on the device!

Direction of the current

The current direction can be individually corrected on the device or via the serial interfaces for each phase. In the case of incorrect connection, the current transformer does not need to be subsequently reconnected.



Current transformer terminals!

The secondary terminals of the current transformer must be short-circuited to this before the power supply lines to the UMG 96RM are disconnected!

If a test switch which automatically short-circuits the current transformer secondary leads is available, it is sufficient to put this into the "test" position provided the short-circuiters have been checked beforehand.



Open current transformer!

High voltage peaks that are dangerous to touch can occur on current transformers that are operated in an open state at the secondary terminals.

In "open-safe current transformers", the winding insulation is measured so that the current transformers can operate in an open state. However, these current transformers are also dangerous to touch if they are operated in an open state.

Connection diagram, current measurement

- 3p 4w (addr. 510 = 0), factory setting

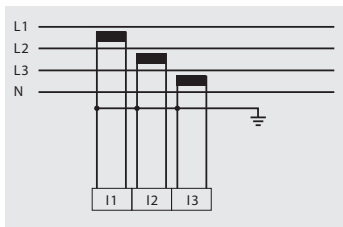

Fig. Measurement in a three-phase net-work with an unbalanced load.

- 3p 2i (addr. 510 = 1)

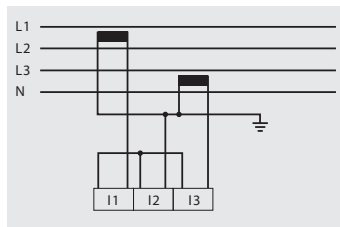

Fig. System with uniform phase loading. The measured values for the I2 current measurement input are measured.

- 3p 2i0 (addr. 510 = 2)

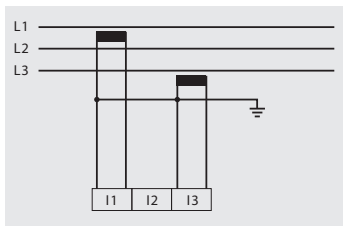

Fig. The measured values for the I2 current measurement input are calculated.

- 3p 3w3 (addr. 510 = 3)

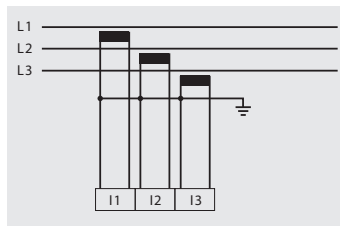

Fig. Measurement in a three-phase net-work with an unbalanced load.

- 3p 3w (addr. 510 = 4)

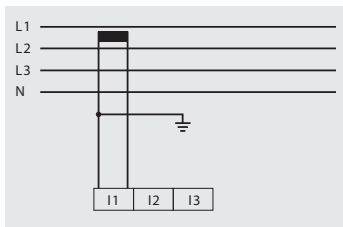

Fig. System with uniform phase loading. The measured values for the I2 and I3 current measurement inputs are calculated.

- 2p 4w (addr. 510 = 5)

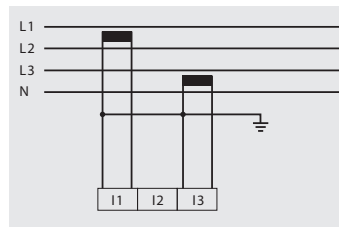

Fig. System with uniform phase loading. The measured values for the I2 current measurement input are calculated.

- 1p 2i (addr. 510 = 6)

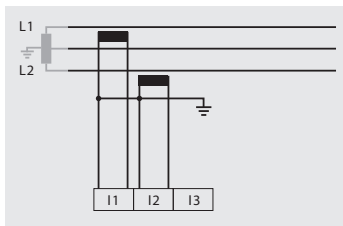

Fig. Measured values derived from the I3 current measurement input are assumed to be zero and not calculated.

- 1p 2w (addr. 510 = 7)

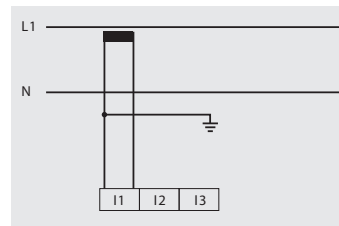

Fig. Measured values derived from the I2 and I3 current measurement inputs are assumed to be zero and not calculated.

Connection diagram, current measurement

- 3p 1w (addr. 510 = 8)

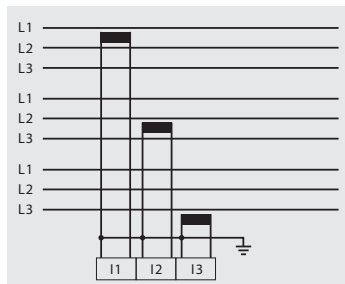

Fig. Three systems with uniform phase loading. The current measurement values of the phases of the respective system where no CTs connected are calculated (I2/I3 resp. I1/I3 resp. I1/I2).

Total current measurement

If the current measurement takes place via two current transformers, the total transformer ratio of the current transformer must be programmed in the UMG 96RM.

Example: The current measurement takes place via two current transformers. Both current transformers have a transformer ratio of 1000/5 A. The total measurement is performed with a 5+5/5 A total current transformer.

The UMG 96RM must then be set as follows:

Primary current: $1000 \text{ A} + 1000 \text{ A} = 2000 \text{ A}$

Secondary current: 5 A

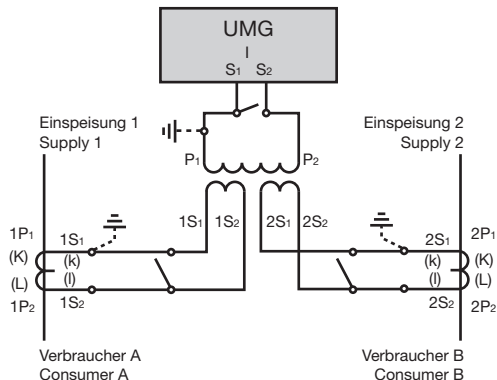

Fig. Current measurement via a total current transformer (example).

Ammeter

If you want to measure the current not only with the UMG 96RM but also with the ammeter, the ammeter must be connected in series with the UMG 96RM.



Caution!

The UMG96RM is only approved for a current measurement using the current transformer.

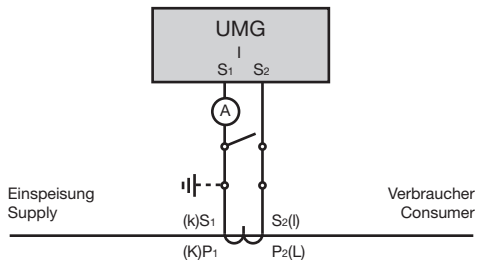
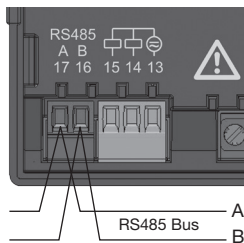

Fig. Current measurement with an additional ammeter (example).

RS485 interface

The RS485 interface is designed with the UMG 96RM as a 2-pole plug contact and communicates via the Modbus RTU protocol (also see programming parameters).



RS485 interface,
2-pole plug contact

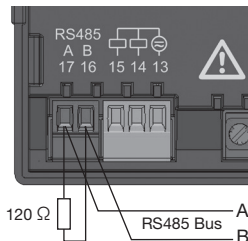

RS485 interface,
2-pole plug contact
with terminating resistor
(Item no. 52.00.008)

Terminating resistors

The cable is terminated with resistors (120 ohm 1/4 W) at the beginning and end of a segment.

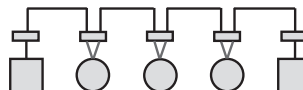

The UMG 96RM has no terminating resistors.

Correct

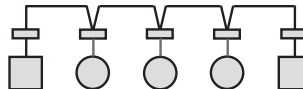

Incorrect



-  Terminal block in the switch cabinet.
-  Device with RS485 interface.
(without a terminating resistor)
-  Device with RS485 interface.
(with terminating resistor on the device)

Shielding

A twisted and shielded cable must be provided for connections via the RS485 interface.

- Ground the shields of all cables that run into the cabinet at the cabinet entry.
- Connect the shield so it has a large contact area and conductively with a low-noise earth.
- Mechanically trap the cable above the earthing clamp in order to avoid damage from cable movement.
- Use the appropriate cable inlets, e.g. PG screw joints, to insert the cable into the switch cabinet.



For the wiring of the Modbus connection, CAT cables are not suitable. Please use the recommended cables.

Cable type

The cable used must be suitable for an ambient temperature of at least 80 °C.

Recommended cable types:

Unitronic Li2YCY(TP) 2x2x0.22 (Lapp cable)

Unitronic BUS L2/FIP 1x2x0.64 (Lapp cable)

Maximum cable length

1200 m with a baud rate of 38.4 k.

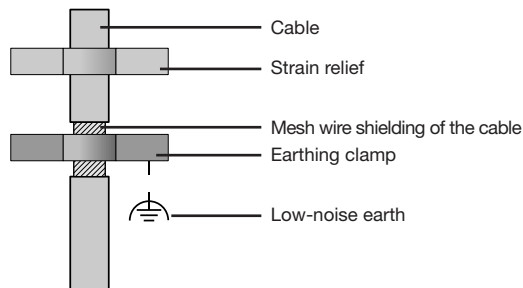

Fig. Shielding design for cabinet entry.

Bus structure

- All devices are connected in a bus structure (line) and each device has its own address within the bus (also see programming parameters).
- Up to 32 stations can be interconnected in one segment.
- The cable is terminated with resistors (bus termination, 120 ohm 1/4 W) at the beginning and end of a segment.
- If there are more than 32 stations, repeaters (line amplifiers) must be used in order to connect the individual segments.
- Devices with activated bus termination must be supplied with power.
- It is recommended to set the master at the end of a segment.
- The bus is inoperative if the master is replaced with an activated bus termination.
- The bus can become unstable if the slave is replaced with an activated bus termination or is dead.
- Devices that are not involved in the bus termination can be exchanged without making the bus unstable.

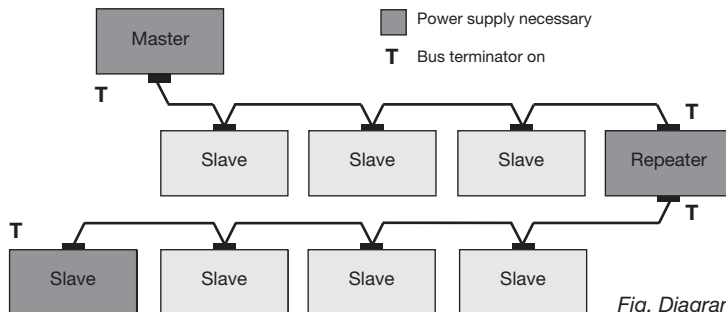

Fig. Diagram of bus structure

Digital outputs

The UMG 96RM has 2 digital outputs. These outputs are electrically isolated from the evaluation electronics by optocouplers. The digital outputs have a common reference.

- The digital outputs can switch DC and AC loads.
- The digital outputs are **not** short circuit protected.
- Connected cables longer than 30 m must be shielded.
- An external auxiliary voltage is required.
- The digital outputs can be used as pulse outputs.
- The digital outputs can be controlled via the Modbus.
- The digital outputs can output results from comparators.

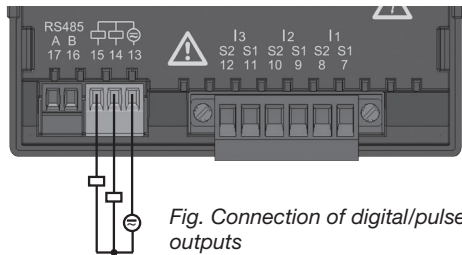

Fig. Connection of digital/pulse outputs

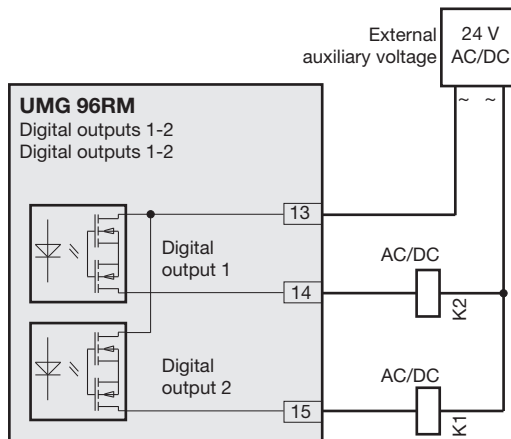

Fig. Connection of two relays to digital outputs 14 and 15.



When using the digital outputs as a pulse output, the auxiliary voltage (DC) must only have a maximum residual ripple of 5%.

Operation

The UMG 96RM is operated using buttons 1 and 2. Measured values and programming data appears on a liquid crystal display.

A distinction is made between *display mode* and *programming mode*. The accidental changing of programming data is prevented by the entry of a password.

Display mode

In the display mode, you can scroll between the programmed measured value displays using buttons 1 and 2. All factory-set measured value displays listed in section 1 can be called up. Up to three measured values are displayed per measured value display. The measured value relaying allows select measured value displays to be shown alternately after a settable changeover time.

Programming mode

In the programming mode, the settings required for operating the UMG 96RM can be displayed and changed. Pressing buttons 1 and 2 simultaneously for about one second calls up the programming mode after the password prompt. If no user password was

programmed, the user arrives directly in the first programming menu. Programming mode is indicated by the text "PRG" on the display.

Button 2 can now be used to switch between the following programming menus:

- current transformer,
- voltage transformer,
- parameter list.

If the device is in programming mode and no button has been pressed for approximately 60 seconds or if buttons 1 and 2 are pressed simultaneously for approx. one second, the UMG 96RM returns to display mode.

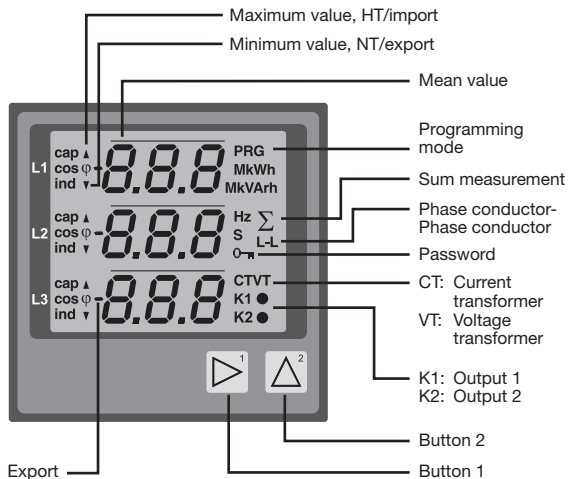

Parameters and measured values

All parameters necessary for operating the UMG 96RM, e.g. the current transformer data, and a selection of frequently required measured values are stored in the table.

The contents of most addresses can be accessed via the serial interface and the buttons on the UMG 96RM.

Only the first 3 significant digits of a value can be entered on the device. Values with more digits can be entered using GridVis.

The device always only displays the first 3 significant digits of a value.

Selected measured values are summarised in measured value display profiles and can be shown in display mode using buttons 1 and 2.

The current measured value display profile and the current display change profile can only be read and changed via the RS485 interface.

Example of the parameter display

On the UMG 96RM display the value "001" is shown as the content of address "000". This parameter reflects the device address (here "001") of the UMG 96RM on a bus in list form.



Example of the measured value display

In this example, the UMG 96RM display shows the voltages L to N with 230 V each.

The K1 and K2 transistor outputs are conductive and current can flow.

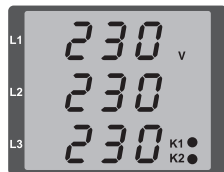

Button functions

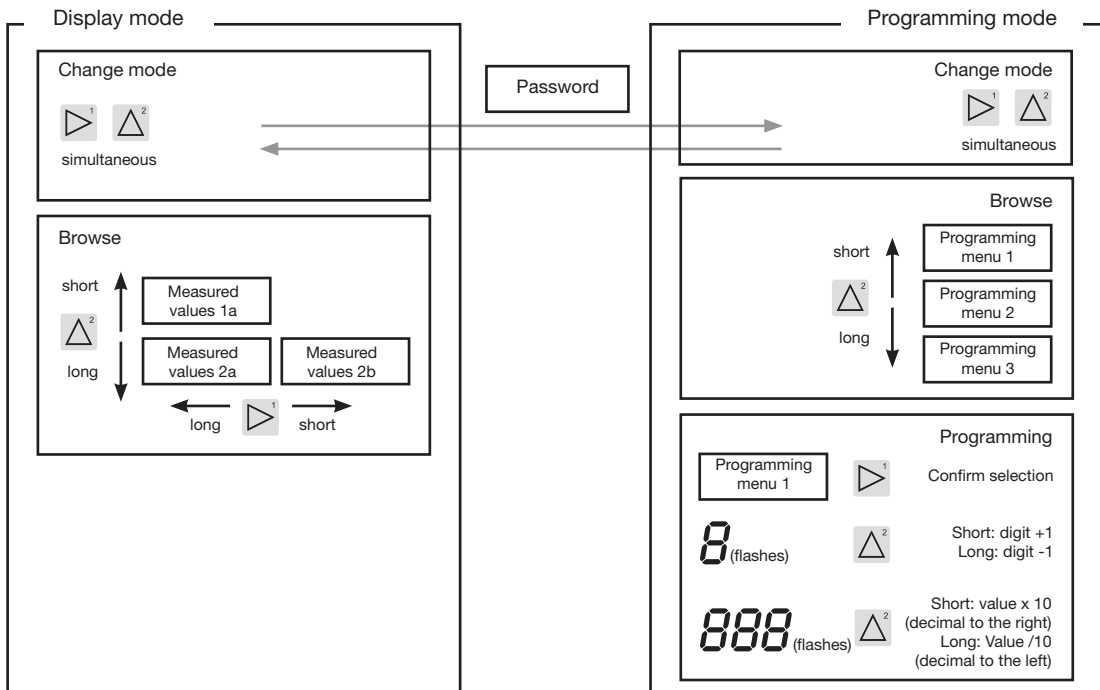

Configuration

Applying the supply voltage

To configure the UMG 96RM, the supply voltage must be connected.

The level of supply voltage for the UMG 96RM can be found on the nameplate.

If no display appears, check the operating voltage to determine whether it is within the rated voltage range.

Current and voltage transformers

A current transformer is set to 5/5 A in the factory. The pre-programmed voltage transformer ratio only needs to be changed if voltage transformers are connected.

When connecting voltage transformers, the measurement voltage on the UMG 96RM nameplate must be observed!



Attention!

Supply voltages that do not correspond to the nameplate information can lead to device malfunction or destruction.



The adjustable value 0 for the primary current transformer does not produce any useful energy values and must not be used.



Devices, which are programmed to automatic frequency detection, need approximately 20 seconds to detect grid frequency. During this period, the measured values do not keep the confirmed measuring accuracy.



Prior to commissioning potential production dependant contents of the energy counter and min/max values have to be deleted.



Current and voltage transformers

The transformer ratios for each of the three current and voltage measurement inputs can be individually programmed in the GridVis software included in the scope of delivery. Only the transformer ratio of the respective group of current measurement inputs or voltage measurement inputs is adjustable on the device.

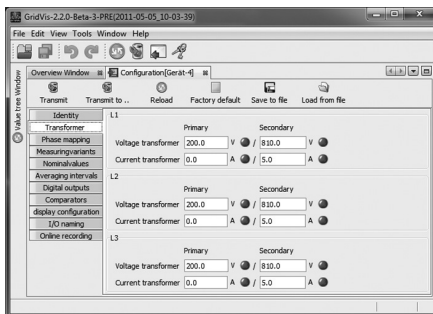

Fig. Display for configuring the current and voltage transformers in the GridVis software.

Programming current transformers

Switching to programming mode

- Simultaneously press buttons 1 and 2 in order to switch to programming mode. If a user password was programmed, the password request will appear with "000". The first digit of the user password flashes and can be changed with button 2. The next digit is selected by pressing button 2 and will begin flashing. If the correct combination was entered or if no user password was programmed, the device will enter programming mode.
- The symbols for the programming mode (PRG) and for the current transformer (CT) appear.
- Confirm the selection with button 1.
- The first digit of the input area for the primary current starts flashing.

Current transformer primary current input

- Change the flashing digit with button 2.
- Select the next digit to be changed with button 1. The selected digit to be changed starts flashing. If the entire number is flashing, the decimal point can be moved with button 2.

Current transformer secondary current input

- Only 1 A or 5 A can be set as the secondary current.
- Select the secondary current with button 1.
- Change the flashing digit with button 2.

Leaving programming mode

- Simultaneously press buttons 1 and 2 to exit the programming mode.

Programming voltage transformers

- Switch to the programming mode as described. The symbols for the programming mode (PRG) and for the current transformer (CT) appear.
- Use button 2 to switch to the voltage transformer setting.
- Confirm the selection with button 1.
- The first digit of the input area for the primary current starts flashing. The ratio of primary to secondary voltage of the voltage transformer can be set in the same way as the assignment of the current transformer ratio of primary to secondary current.

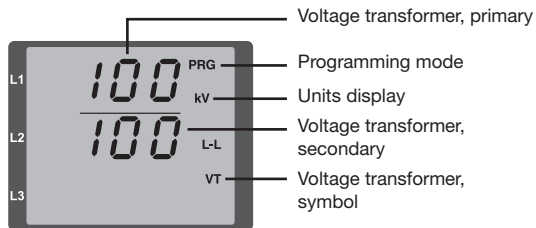
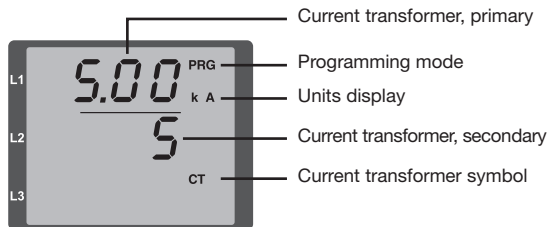

Programming parameters

Switching to programming mode

- Switch to the programming mode as described. The symbols for the programming mode (PRG) and for the current transformer (CT) appear.
- Use button 2 to switch to the voltage transformer setting. The first parameter of the parameter list is shown by repeatedly pressing button 2.

Changing parameters

- Confirm the selection with button 1.
- The most recently selected address is displayed with the associated value.
- The first digit of the address flashes and can be changed using button 2. Button 1 provides a selection of digits that, in turn, can be changed with button 2.

Changing the value

- Once the desired address is set, a digit of the value is selected with button 1 and changed with button 2.

Leaving programming mode

- Simultaneously press buttons 1 and 2 to exit the programming mode.



Fig. Password request
If a password was set, it can be entered using buttons 1 and 2.



Fig. Current transformer programming mode
The primary and secondary currents can be changed using buttons 1 and 2 (cf. page 40).



Fig. Programming mode Voltage transformer
The primary and secondary currents can be changed using buttons 1 and 2 (cf. page 41).



Fig. Programming mode Parameter display
The individual parameters can be changed using buttons 1 and 2 (cf. page 36).

Device address (addr. 000)

If several devices are connected to one another via the RS485 interface, a master device can only differentiate between these devices by means of their device addresses. Therefore, each device in a network must have a different device address. Addresses can be set in the range from 1 to 247.



The adjustable range of the device address is between 0 and 255. The values 0 and 248 to 255 are reserved and may not be used.

Baud rate (addr. 001)

A common baud rate is adjustable for the RS485 interfaces. The baud rate must be chosen to be a uniform value in the network. On address 003 the quantity of stop bits can be set (0=1bit, 1=2bits). Data bits (8) and parity (none) are permanently set.

Setting	Baud rate
0	9.6 kbps
1	19.2 kbps
2	38.4 kbps
3	57.6 kbps
4	115.2 kbps (factory setting)

Mean value

Mean values are formed over an adjustable period for the current, voltage and power measured values. The mean values are identified with a bar above the measured value.

The averaging time can be selected from a list of nine fixed averaging times.

Current averaging time (addr. 040)

Power averaging time (addr. 041)

Voltage averaging time (addr. 042)

Setting	Averaging time/sec.
0	5
1	10
2	15
3	30
4	60
5	300
6	480 (factory setting)
7	600
8	900

Averaging method

After the set averaging time, the exponential averaging method used achieves at least 95% of the measured value.

Minimum and maximum values

All measured values are measured and calculated every 10/12 periods. Minimum and maximum values are determined for most of the measured values.

The minimum value is the smallest measured value that has been determined since the last reset. The maximum value is the largest measured value that has been determined since the last clearance. All minimum and maximum values are compared with the corresponding measured values and are overwritten if they are undercut or exceeded.

The minimum and maximum values are stored in an EEPROM every 5 minutes, without the date and time. This means that if the operating voltage fails, only the minimum and maximum values of the last 5 minutes are lost.

Clearing minimum and maximum values (addr. 506)

If "001" is written to the address 506, all minimum and maximum values are simultaneously cleared.

The maximum value of the current mean value is an exception. The maximum value of the current mean value can also be cleared directly in the display menu by pressing and holding button 2.

Mains frequency (addr. 034)

For automatic ascertainment of the mains frequency, an L1-N voltage larger than 10V_{eff} must be applied to the voltage measurement input V1.

The mains frequency is then used to calculate the sampling rate for the current and voltage inputs.

If there is no measurement voltage, the mains frequency cannot be determined and thus no sampling rate can be calculated. The acknowledgeable error message "500" appears.

The voltage, current and all other resulting values are calculated based on the previous frequency measurement and possible cable-connecting sockets and continue to be displayed. However, these derived measured values are no longer subject to the specified accuracy.

If it is possible to re-measure the frequency, then the error message will disappear automatically after a period of approx. 5 seconds once the voltage has been restored.

The error is not displayed if a fixed frequency has been configured.

Adjustment range: 0, 45 .. 65

0 = automatic frequency determination.
The mains frequency is determined from the measurement voltage.

45..65 = fixed frequency
The mains frequency is preselected.

Energy meter

The UMG 96RM has energy meters for active energy, reactive energy and apparent energy.

Reading the active energy

Total active energy

The active energy in this example is: 12 345 678 kWh

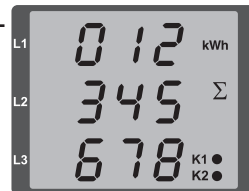

The active energy in this example is: 134 178 kWh

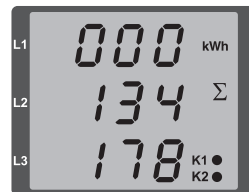

Harmonics

Harmonics are the integer multiple of a mains frequency. The voltage mains frequency for the UMG 96RM must be in the range between 45 and 65 Hz. The calculated voltage and current harmonics refer to this mains frequency.

Harmonics up to 40x the mains frequency are recorded.

The harmonics for currents are given in amperes and the harmonics for voltages are given in volts.

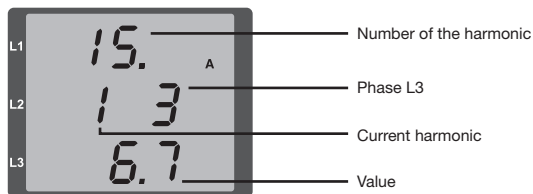

Fig. Display of the 15th harmonic of the current in the L3 phase (example).



Harmonics are not displayed in the factory default setting.

Total Harmonic Distortion (THD)

THD is the ratio of the root mean square value of harmonics to the root mean square value of the mains frequency.

Total Harmonic Distortion of the current (THD_I):

$$THD_I = \frac{1}{|I_{fund}|} \sqrt{\sum_{n=2}^M |I_{n,Harm}|^2}$$

Total Harmonic Distortion of the voltage (THD_U):

$$THD_U = \frac{1}{|U_{fund}|} \sqrt{\sum_{n=2}^M |U_{n,Harm}|^2}$$

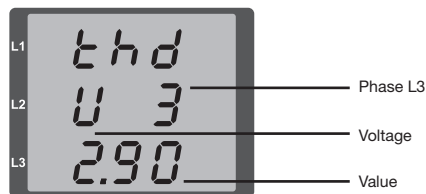

Fig. Display of the total harmonic distortion of the voltage from the L3 phase (example).

Measured value relay

All measured values are calculated every 10/12 periods and can be recalled once per second on the measured value displays. Two methods are available for retrieving the measured value displays:

- The automatically changing display of selected measured values, referred to here as measured value relaying.
- Selection of a measured value display using buttons 1 and 2 from a preselected display profile.

Both methods are simultaneously available. Measured value relaying is active if at least one measured value display is programmed with a changeover time greater than 0 seconds.

If a button is pressed, the measured value displays of the selected display profile can be browsed. If no button is pressed for about 60 seconds, the device switches to the measured value relay and the measured values from the selected display change profile of the programmed measured value displays are shown one after the other.

Changeover time (addr. 039)

Adjustment range: 0 .. 60 seconds

If 0 seconds are set, no changeover takes place between the measured value displays selected for the measured value relay.

The changeover time applies for all display change profiles.

Display change profile (addr. 038)

Adjustment range: 0 .. 3

0 - Display changeover profile 1, by default.

1 - Display changeover profile 2, by default.

2 - Display changeover profile 3, by default.

3 - Customised display changeover profile.

Measured value displays

After return of the power supply, the UMG 96RM shows the first measured value panel from the current display profile. In order to keep the selection of measured values to be displayed arranged in a clear manner, only one part of the available measured values is pre-programmed for recall in the measured value display by default. A different display profile can be selected if other measured values are required to be shown on the UMG 96RM display.

Display profile (addr. 037)

Adjustment range: 0 .. 3

- 0 - Display profile 1, default setting.
- 1 - Display profile 2, default setting.
- 2 - Display profile 3, default setting.
- 3 - Customised display profile.



The customised profiles (display change profile and display profile) can only be programmed via the GridVis software.



Profile settings

The profiles (display change profile and display profile) are clearly shown in the GridVis software included in the scope of delivery. The profiles can be adjusted in the software via the device configuration; customised display profiles can also be programmed.

A connection between the UMG 96RM and the PC via the serial interface (RS485) is required for using the GridVis software. This requires an interface converter RS485/232, item no. 15.06.015 or RS485/USB, item no. 15.06.025.

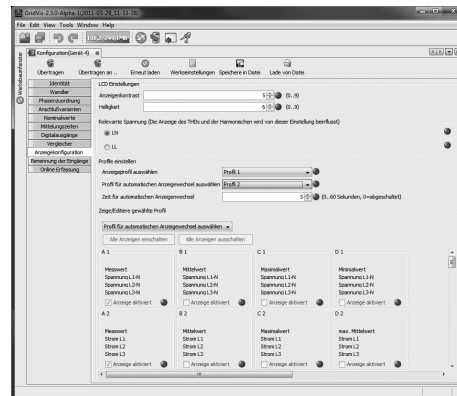

Fig. Display of the profile setting in the GridVis software.

User password (addr. 050)

A user password can be programmed in order to impede any accidental change to programming data. A switch to the next programming menu can only be made after entering the correct user password.

No user password is specified in the factory. In this case, the password menu is skipped and the current transformer menu is reached directly.

If a user password was programmed, the password menu will appear with the display "000".

The first digit of the user password flashes and can be changed with button 2. The next digit is selected by pressing button 1 and will begin flashing.

The programming menu for the current transformer can only be accessed after entering the correct number combination.

Forgotten password

If you have forgotten the password, the password can only be cleared by using the GridVis PC software.

To do this, connect the UMG 96RM to the PC via a suitable interface. More information can be found in the help section of GridVis.

Clear energy meter (addr. 507)

The active, apparent and reactive energy meters can only be cleared together.

Address 507 must be written with "001" in order to clear the contents of the energy meters.



Prior to commissioning potential production dependant contents of the energy counter and min/max values have to be deleted.



Clearing the energy meters means this data in the device is gone. In order to avoid possible data loss, read and save the measured values with the GridVis software before clearing.

Rotation field direction

The rotation field direction of the voltages and the frequency of phase L1 are shown on the display.

The rotation field direction indicates the phase sequence in three-phase systems. Usually there is a "clockwise spinning rotation field".

The phase sequence at the voltage measurement inputs is checked and displayed in the UMG 96RM. A movement of the character string in the clockwise direction means a "right rotation" and a counter-clockwise movement indicates a "left rotation".

The rotation field direction is determined only if the measurement and operating voltage inputs are fully connected. If one phase is missing or two of the same phases are connected, the rotation field direction will not be determined and the character string does not appear on the display.



Fig. Display of the mains frequency (50.0) and the rotation field direction



Fig. No rotation field direction detectable.

LCD contrast (addr. 035)

The preferred direction of viewing for the LCD is from "below". The user can adjust the LCD contrast of the LCD screen. It is possible to set the contrast in the range from 0 to 9 in steps of 1.

0 = characters are very light

9 = characters are very dark

Factory default setting: 5

Backlight

The LCD backlight allows the display to be read easily even in poor light. The brightness can be controlled by the user in stages from 0 to 9.

The UMG 96RM has two different types of backlight:

- the operation backlight
- the standby backlight

Operation backlight (addr. 036)

The operation backlight is activated by pushing the appropriate button, or with a restart.

Standby backlight (addr. 747)

This backlight is activated after an adjustable period of time (addr. 746). If no button is pressed within this period, then the device switches to the standby backlight. If buttons 1 - 3 are pressed, the device switches to the operation backlight and the defined period of time begins again.

If the brightness settings for the two backlights are set to the same value, then no change is discernible between the operation and standby backlights.

Addr.	Description	Setting range	Default setting
036	Brightness for operation backlight	0 .. 9	6
746	Period of time after which the backlight will switch to standby	60 .. 9999 Sek.	900 Sek.
747	Brightness for standby backlight	0 .. 9	0

0 = min. brightness, 9 = max. brightness

Time recording

The UMG 96RM records the operating hours and the total running time of each comparator

- where the time of operating hours is measured with a resolution of 0.1 h and is displayed in hours or
- the total running time of the comparator is represented in seconds (when 999999 seconds is reached, the display changes to hours).

For the querying of measured value displays, the times are marked with the numbers 1 to 6:

none = operating hours meter

1 = total running time, comparator 1A

2 = total running time, comparator 2A

3 = total running time, comparator 1B

4 = total running time, comparator 2B

5 = total running time, comparator 1C

6 = total running time, comparator 2C

A maximum of 99999.9 h (= 11.4 years) can be shown on the measured value display.

Operating hours meter

The operating hours meter measures the time for which the UMG 96RM records and displays measured values. The time of operating hours is measured with a resolution of 0.1 h and is displayed in hours. The operating hours meter cannot be reset.

Total running time of the comparator

The total running time of a comparator is the sum of all time for which there is a limit value violation in the comparator result.

The total running time of the comparator can only be reset via the GridVis software. The reset is carried out for all total running times.

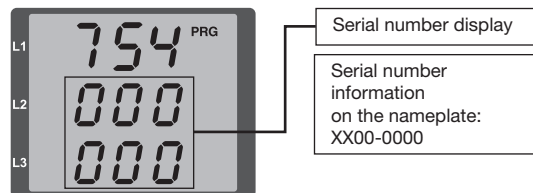

Fig. Operating hours meter of the measured value display
The UMG 96RM shows the number 140.8 h in the operating hours meter. This corresponds to 140 hours and 80 industrial minutes. 100 industrial minutes correspond to 60 minutes. In this example, 80 industrial minutes therefore represent 48 minutes.

Serial number (addr. 754)

The serial number shown by UMG 96RM has 6 digits and is part of the serial number displayed on the nameplate.

The serial number cannot be changed.



Software release (addr. 750)

The software for UMG 96RM is continuously improved and expanded. The software version in the device is marked with a 3-digit number, the software release. The user cannot change the software release.

Commissioning

Applying the supply voltage

- The level of supply voltage for the UMG 96RM can be found on the nameplate.
- After applying the supply voltage, the UMG 96RM switches to the first measured value display.
- If no display appears, the supply voltage must be checked to determine whether it is in the rated voltage range.

Applying the measured voltage

- Voltage measurements in networks with rated voltages above 300V AC to ground must be connected to a voltage transformer.
- After the measured voltages are connected, the measured values for the L-N and L-L voltages displayed by the UMG 96RM must match those at the voltage measurement input.



Attention!

Voltages and currents outside the permissible metering range can result in personal injury and damage to the device.

Applying the measured current

The UMG 96RM is designed for connecting $\dots/1$ A and $\dots/5$ A current transformers.

Only AC currents and not DC currents can be measured via the current measurement inputs.

Short circuit all current transformer outputs except for one. Compare the currents displayed on the UMG 96RM with the applied current.

The current displayed by the UMG 96RM must match the input current, taking the current transformer ratio into consideration.

In the short circuit current measurement inputs, the UMG 96RM must show approx. zero amperes.

The factory-set current transformer ratio is 5/5 A and may need to be adapted to the current transformer used.



Attention!

Supply voltages that do not correspond to the nameplate information can lead to device malfunction or destruction.



Attention!

The UMG 96RM is not suitable for the measurement of DC voltages.

Rotation field direction

Check the direction of the voltage rotation field on the measured value display of the UMG 96RM. Usually there is a "clockwise" spinning rotation field.

Checking the phase assignment

The assignment of the phase conductor to the current transformer is correct if a current transformer is short circuited at the secondary terminals and the current shown by the UMG 96RM in the corresponding phase sinks to 0A.

Checking the power measurement

Short circuit all current transformer outputs except for one and check the displayed power. The UMG 96RM must only show one rating in the phase with the non-short-circuited current transformer input. If this does not apply, check the measured voltage connection and the measured current connection.

If the magnitude of the real power is correct but the sign of the real power is negative, this can be due to two causes:

- The connections S1 (k) and S2 (l) on the current transformer are inverted.
- Active energy is being returned to the network.

Checking the measurement

If all voltage and current measurement inputs are correctly connected, the individual and sum power ratings are accurately calculated and displayed.

Checking the individual power ratings

If the current transformer is assigned to the wrong phase conductor, the associated power rating will be incorrectly measured and displayed.

The assignment of the phase conductor to the current transformer on the UMG 96RM is correct if there is no voltage between the phase conductor and the associated current transformer (primary).

In order to ensure that a phase conductor on the voltage measurement input is assigned to the correct current transformer, the respective current transformer can be short-circuited at the secondary terminals. The apparent power shown by the UMG 96RM must then be zero in this phase.

If the apparent power is correctly displayed but the real power is shown with a "-" sign, the current transformer terminals are inverted or power is being fed to the power company.

Check the sum power ratings

If all voltages, currents and power ratings for the respective phase conductor are correctly displayed, the sum power ratings measured by the UMG 96RM must also be correct. For confirmation, the sum power ratings measured by the UMG 96RM should be compared with the energy of the active and reactive power meters at the power feed.

RS485 interface

The data from the parameter and measured value list can be accessed via the MODBUS RTU protocol with CRC check to the RS485 interface.

Address range: 1 .. 247

Factory default setting: 1

The device address is set to 1 and the baud rate is set to 115.2 kbps by default.

Modbus Functions (Slave)

04 Read Input Registers

06 Preset Single Register

16 (10Hex) Preset Multiple Registers

23 (17Hex) Read/Write 4X Registers

The sequence of bytes is high before low byte (Motorola format).

Transmission parameters:

Data bits: 8

Parity: None

Stop bits (UMG 96RM): 2

External stop bits: 1 or 2

Number formats: short 16 bit ($-2^{15} .. 2^{15} - 1$)

float 32 bit (IEEE 754)



The system does not support broadcast (addr. 0).



The message length must not exceed 256 bytes.

Example: Reading the L1-N voltage

The L1-N voltage is stored in the measured value list under the address 19000. The L1-N voltage is stored in FLOAT format.

The UMG 96RM device address with the address = 01 is adopted here.

The "query message" then appears as follows:

Description	Hex	Note
Device address	01	UMG 96RM, address = 1
Function	03	"Read Holding Reg."
Start address Hi	4A	19000dec = 4A38hex
Start address Lo	38	
Disp. Values Hi	00	2dec = 0002hex
Disp. Values Lo	02	
Error Check	-	

The "response" from the UMG 96RM can then appear as follows:

Description	Hex	Note
Device address	01	UMG 96RM, address = 1
Function	03	
Byte meter	06	
Data	00	00hex = 00dec
Data	E6	E6hex = 230dec
Error Check (CRC)	-	

The L1-N voltage read back from address 19000 is 230 V.

Digital outputs

The UMG 96RM has 2 digital outputs. The following functions can be optionally assigned to the digital outputs:

Digital output 1

Address 200 = 0 Result of the comparator group 1
 Address 200 = 1 Pulse output
 Address 200 = 2 Value from an external source

Digital output 2

Address 202 = 0 Result of the comparator group 2
 Address 202 = 1 Pulse output
 Address 202 = 2 Value from an external source

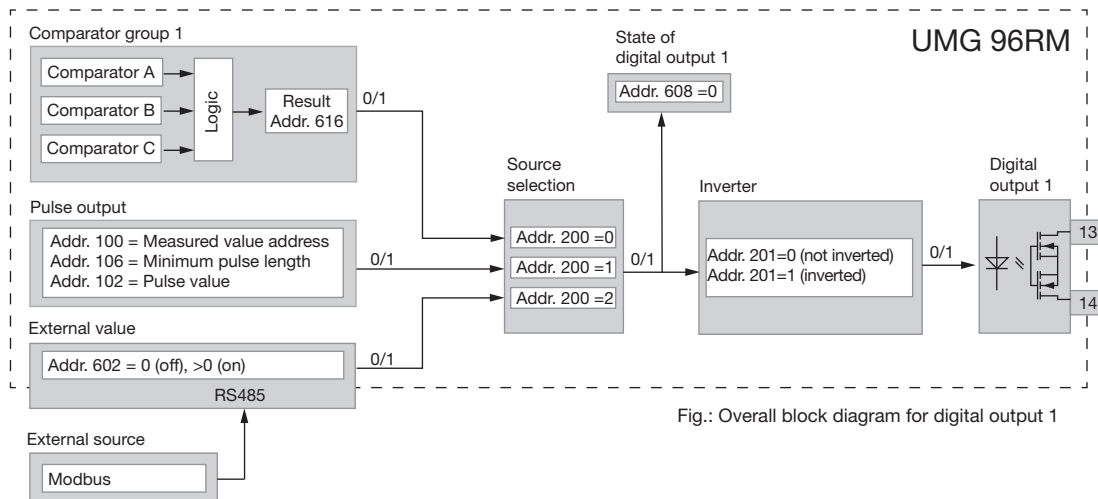

Fig.: Overall block diagram for digital output 1

Digital outputs - status indicators

The status of the switching outputs is represented in the UMG 96RM display by circular symbols.



Since the display is only updated once per second, faster changes of the output states cannot be displayed.

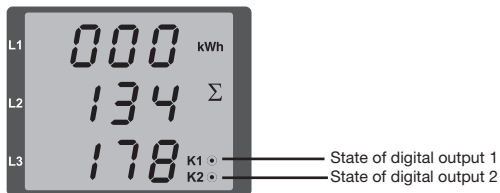

States of the digital output

- A current of <1 mA can flow.
Digital output 1: Address 608 = 0
Digital output 2: Address 609 = 0
- A current of <50 mA can flow.
Digital output 1: Address 608 = 1
Digital output 2: Address 609 = 1

Pulse output

Among other things, the digital outputs can also be used for the output of pulses to meter the energy consumption. After reaching a certain adjustable amount of energy, a pulse of defined length is applied to the output. Various adjustments must be made in order to use a digital output as a pulse output.

- Digital output
- Source selection
- Measured value selection
- Pulse length
- Pulse value

Measured value selection (addr. 100, 101)

Enter the power value here that is to be issued as an energy pulse. See Table 2.

Source selection (addr. 200, 202)

Enter the source that delivers the measured value to be issued at the digital output.

Selectable sources:

- Comparator group
- Pulse
- External source

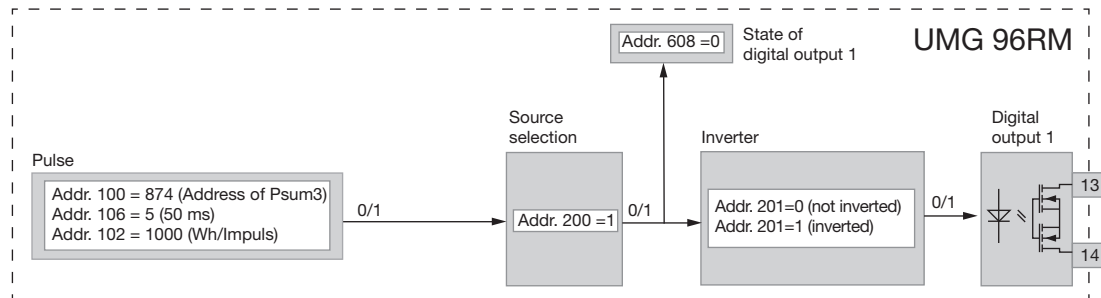

Fig.: Block diagram; Example of digital output 1 as a pulse output.

Pulse length (addr. 106)

The pulse length applies for both pulse outputs and is permanently fixed via parameter address 106.

Adjustment range: 1 .. 1000 1 = 10ms

Default: 5 = 50ms

The typical pulse length for S0 pulses is 30 ms.

Pulse pause

The pulse pause is at least as long as the selected pulse length.

The pulse pause depends on the measured energy, for example, and can be hours or days.

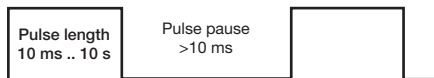

Pulse spacing

The pulse spacing is proportional to the power within the selected setting.



Measured value selection

When programming with GridVis, a selection of energy values that are derived from the power values is received.

Due to the minimum pulse length and minimum pulse pause, the values in the table are for the maximum number of pulses per hour.

Pulse length	Pulse pause	Maximum pulses/hour
10 ms	10 ms	180,000 pulses/hour
30 ms	30 ms	60,000 pulses/hour
50 ms	50 ms	36,000 pulses/hour
100 ms	100 ms	18,000 pulses/hour
500 ms	500 ms	3,600 pulses/hour
1 s	1 s	1,800 pulses/hour
10 s	10 s	180 pulses/hour

Examples for the maximum possible number of pulses per hour.

Pulse value (addr. 102, 104)

The pulse value specifies how much energy (Wh or varh) should correspond to a pulse.

The pulse value is determined by the maximum connected load and the maximum number of pulses per hour.

If the pulse value is specified with a positive sign, pulses will only be issued if the measured value also has a positive sign.

If the pulse value is specified with a negative sign, pulses will only be issued if the measured value also has a negative sign.

$$\text{Pulse value} = \frac{\text{maximum connection power}}{\text{maximum number of pulses per hour}} \text{ [pulse/Wh]}$$



Since the active energy meter works with a return stop, pulses are only issued during import of electrical energy.



Since the reactive energy meter works with a return stop, pulses are only issued under inductive load.

Determining the pulse value

Setting the pulse length

Set the pulse length according to the requirements of the connected pulse receiver.

For a pulse length of 30 ms, for example, the UMG 96RM can issue a maximum number of 60,000 pulses (see Table "Maximum Pulse Number") per hour.

Determining the maximum connected load

Example:

Current transformer = 150/5 A
 L-N voltage = max. 300 V

Power per phase = 150 A x 300 V
 = 45 kW

Power for 3 phases = 45 kW x 3

Maximum connected load = 135 kW

Calculating the pulse value

$$\text{Pulse value} = \frac{\text{maximum connection power}}{\text{maximum number of pulses per hour}} \text{ [pulse/Wh]}$$

Pulse value = 135 kW / 60000 pulses/h

Pulse value = 0.00225 pulses/kWh

Pulse value = 2.25 pulses/Wh

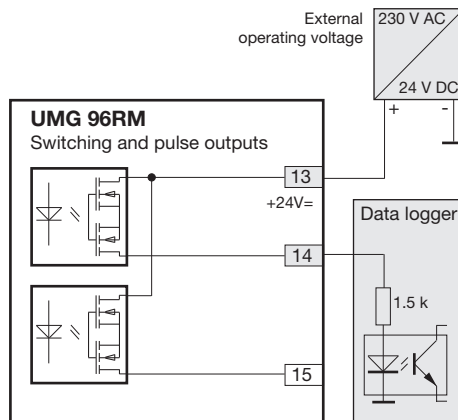

Fig.: Connection example for wiring the pulse output.



When using the digital outputs as a pulse output, the auxiliary voltage (DC) must only have a maximum residual ripple of 5%.

Limit value monitoring

Two comparator groups are available for monitoring a limit value.

Comparator group 1 is assigned to digital output 1 and comparator group 2 is assigned to digital output 2.

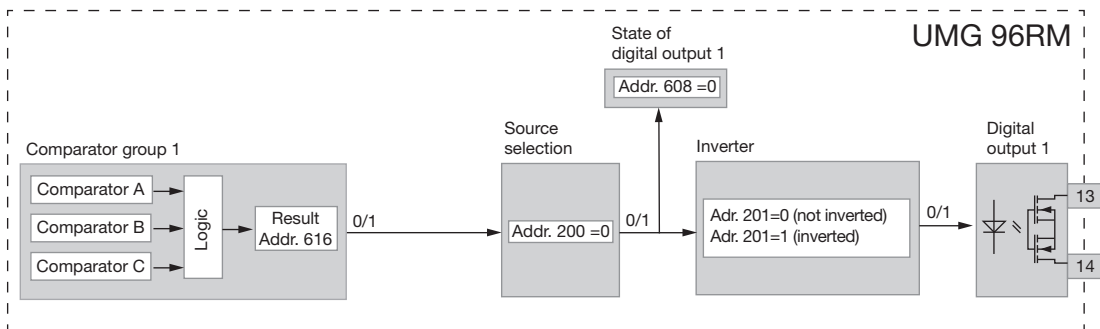

Block diagram: Use of digital output 1 for limit value monitoring.

Example: Current monitoring in the neutral line

If the current in the neutral line is greater than 100 A for 60 seconds, the digital output 1 should trip for at least 2 minutes.

The following must be programmed:

1. Comparator group 1

Select comparator group 1 for the limit value monitoring. The comparator group acts only on digital output 1.

Since only one limit value is monitored, select comparator A and program it as follows:

The address of the measured value to be monitored by comparator A:

Address 110 = 866 (address of the current in the neutral line)

The measured values for the B and C comparators are set to 0.

Address 116 = 0 (the comparator is inactive)

Address 122 = 0 (the comparator is inactive)

The limit value to be observed.

Address 108 = 100 (100 A)

For a minimum exposure time of 2 minutes, digital output 1 should remain switched if the limit value is exceeded.

Address 111 = 120 seconds

For the lead time of 60 seconds, any exceeding should be minimised.

Address 112 = 60 seconds

The operator for comparison between the measured value and the limit value.

Address 113 = 0 (corresponds >=)

2. Source selection

Select comparator group 1 as the source.

Address 200 = 0 (comparator group 1)

3. Inverter

The result from comparator group 1 can also be inverted here. The result is not inverted.

Address 201 = 0 (not inverted)

4. Linking comparators

The B and C comparators have not been set and are equal to zero.

The result of comparator A is issued as a comparator result through the OR link of comparators A, B and C.

Address 107 = 0 (OR link)

Result

Digital output 1 is tripped for at least 2 minutes if the current in the neutral line is greater than 100 A for more than 60 seconds.

Digital output 1 is conductive. Current can flow.

Comparator

Two comparator groups, each with 3 comparators, are available for monitoring limit values. The results from comparators A, B and C can be AND or OR linked.

The linkage result from comparator group 1 can be assigned to digital output 1 and the linkage result from comparator group 2 is assigned to digital output 2.

The function “display blinking” can be additionally assigned to every comparator group. The effect is the change of the display backlight between maximum and minimum brightness when the comparator output is active (addr. 145).

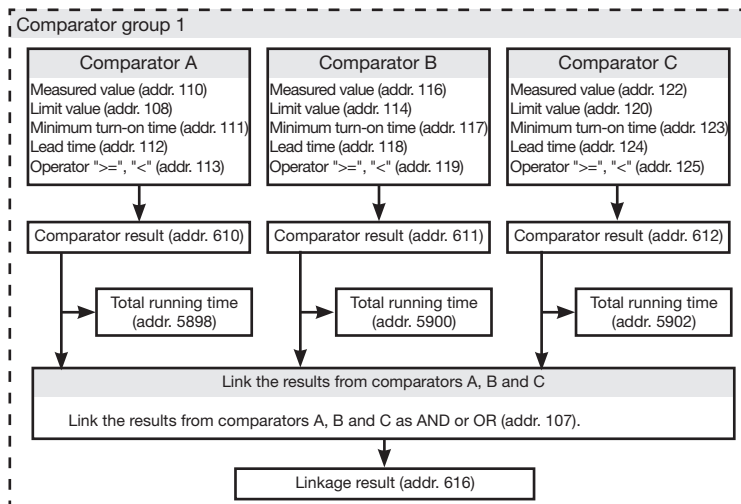

We recommend making settings for limit value monitoring via the GridVis.



Only 3-digit parameter addresses can be entered in the UMG 96RM. 4-digit parameter addresses can be entered in the GridVis.

- **Measured value (addr. 110,116,122,129,135,141)**
The address of the measured value to be monitored is in the measured value.
If measured value = 0, the comparator is inactive.
- **Limit value (addr. 108,114,120,127,133,139)**
Write the value in the limit that is to be compared with the measured value.
- **Minimum turn-on time (addr. 111,117,123,130,136,142)**
The linkage result (e.g. address 610) is maintained for the duration of the minimum turn-on time.
Adjustment range: 1 to 32,000 seconds
- **Lead time (addr. 112,118,124,131,137,143)**
If a limit value violation is present for at least the duration of the lead time, the comparator result is changed.
Times in the range from 1 to 32,000 seconds can be assigned to the lead time.
- **Operator (addr. 113,119,125,132,138,144)**
Two operators are available for comparing the measured value and the limit value.
Operator = corresponds to 0 greater than or equal to (\geq)
Operator = corresponds to 1 less than ($<$)
- **Comparator result (addr. 610,611,612,613,614,615)**
The result from the comparison between the measured value and the limit value is in the comparator result.
Therefore:
0 = there is no limit value violation.
1 = there is a limit value violation.
- **Total running time**
The sum of all times for which there was a limit value violation in the comparator result.
- **Linkage (addr. 107, 126)**
Link the results from comparators A, B and C as AND or OR.
- **Linkage (addr. 107, 126)**
Link the results from comparators A, B and C as AND or OR.
- **Total linkage result (addr. 616,617)**
The linked comparator results from comparators A, B and C are in the total linkage result.

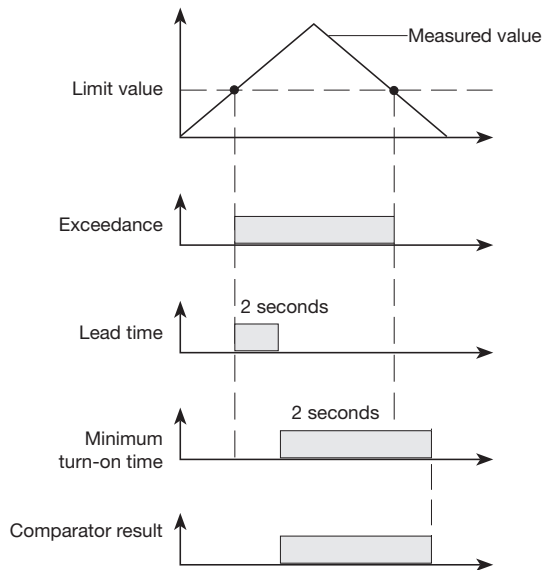

Service and maintenance

The device is subject to various safety tests prior to delivery and is marked with a seal. If a device is opened, the safety tests must be repeated. A warranty is only given for unopened devices.

Repair and calibration

Repairs and calibration can only be carried out by the manufacturer.

Front membrane

The front membrane can be cleaned with a soft cloth and common household cleaning agents. Acids and acidic agents must not be used for cleaning.

Disposal

The UMG 96RM can be disposed of as electronic scrap in accordance with the statutory recycling provisions. The lithium battery must be disposed of separately.

Firmware update

If a firmware update needs to be implemented for your UMG 96RM, it can be implemented using the GridVis software (*included in the delivery*) via the Update Extras/Device menu item.

Service

If questions arise that are not described in this manual, please contact the manufacturer directly.

We require the following information from you in order to deal with questions:

- device designation (see nameplate),
- serial number (see nameplate),
- software release (see measured value display),
- measured voltage and supply voltage,
- precise description of the error.

Error messages

The UMG 96RM shows three different error messages on the display:

- warnings,
- serious error and
- metering range exceedances.

If there are warnings and serious errors, the error message is indicated by the symbol "EEE" followed by an error number.

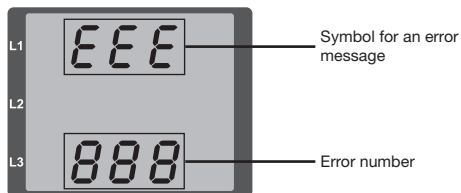

The three-digit error number is composed of the error description and (if detectable by the UMG 96RM) one or more error causes.

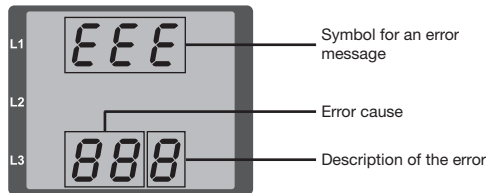

Example of error message 911:

The error number is composed of serious error 910 and internal error cause 0x01.

In this example, an error occurred when reading the calibration from the EEPROM. The device must be sent to the manufacturer for inspection.



Warnings

Warnings are less serious errors and can be acknowledged with buttons 1 or 2. The measured values continue to be recorded and displayed. This error is re-displayed after each voltage recovery.

Error	Description of the error
EEE 500	The mains frequency cannot be determined. Possible causes: The voltage on L1 is too small. The mains frequency is not in the range from 45 to 65Hz.

Serious errors

The device must be sent to the manufacturer for inspection.

Error	Description of the error
EEE 910	Error when reading the calibration.

Internal causes of the error

The UMG 96RM can usually determine the cause of an internal error and then report it with the following error code. The device must be sent to the manufacturer for inspection.

Error	Description of the error
0x01	EEPROM does not answer.
0x02	Address range exceeded.
0x04	Checksum error.
0x08	Error in the internal I2C bus.

Metering range exceedance

Metering range exceedances are displayed as long as they are present and cannot be acknowledged. A metering range is exceeded if at least one of the three voltage or current measuring inputs is outside of its specified metering range.

The phase in which the metering range exceedance occurred is indicated with the "up" arrow. The "V" and "A" symbols show whether the metering range exceedance occurred in the current or voltage circuit.

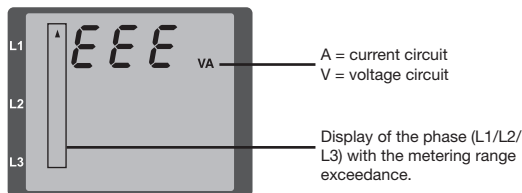

Limit values for metering range exceedance:

$$I = 7 A_{\text{eff}}$$

$$U_{L-N} = 520 V_{L-N}$$

Examples

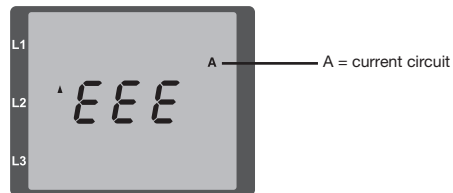

Fig.: Display of the metering range exceedance in the current circuit of the 2nd phase (I2).

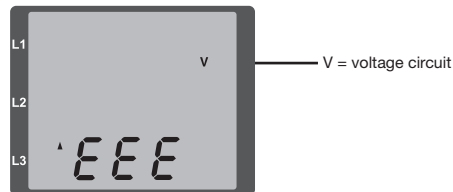

Fig.: Display of the metering range exceedance in the voltage circuit L3.

Parameters of the metering range exceedance

A continuative error description is stored encoded in the parameters of the metering range exceedance (addr. 600) in the following format:

0x	F	F	F	F	F	F	F	F
Phase 1:		1		1				
Phase 2:		2		2				
Phase 3:		4		4				
		Current:		U _{L-N}				

Example: Error in phase 2 in the current circuit:

0xF2FFFFFF

Example: Error in phase 3 in the voltage circuit U_{L-N}:

0xFFF4FFFF

Procedure in case of error

Possibility of error	Cause	Help
No display	External fuse for the power supply has tripped.	Replace fuse.
No current display	Measurement voltage not connected.	Connect measurement voltage.
	Measurement current not connected.	Connect measurement current.
The displayed current is too large or too small.	Current measurement in the wrong phase.	Check and correct the connection if necessary.
	Voltage transformer factor incorrectly programmed.	Read and program the current transformer ratio on the current transformer.
	The peak current value at the measurement input was exceeded by current harmonics.	Install current transformer with a higher current transformer ratio.
	The current at the measurement input was exceeded.	Install current transformer with a lower current transformer ratio.
The displayed voltage is too small or too large.	Measurement in the wrong phase.	Check and correct the connection if necessary.
	Voltage transformer incorrectly programmed.	Read and program the voltage transformer ratio on the voltage transformer.
The displayed voltage is too small.	Metering range exceedance.	Use voltage transformer.
	The peak voltage value at the measurement input was overwritten by harmonics.	Attention! It must be ensured that the measurement inputs are not overloaded.

Possibility of error	Cause	Help
Ind./cap. phase shift	The current circuit is assigned to the wrong voltage circuit.	Check and correct the connection if necessary.
Real power is too small or too large.	The programmed current transformer ratio is incorrect.	Reading and programming the current transformer ratio on the current transformer
	The current circuit is assigned to the wrong voltage circuit.	Check and correct the connection if necessary.
	The programmed voltage transformer ratio is incorrect.	Read and program the voltage transformer ratio on the voltage transformer.
The active energy import/export is inverted.	At least one current transformer connection is inverted.	Check and correct the connection if necessary.
	A current circuit is assigned to the wrong voltage circuit.	Check and correct the connection if necessary.
An output is not reacting.	The output was incorrectly programmed.	Check the programming and correct if necessary.
	The output was incorrectly connected.	Check and correct the connection if necessary.
"EEE" on the display	See error messages.	
No connection to the device.	Incorrect device address	Correct the device address.
	Different bus speeds (baud rate)	Correct the speed (baud rate).
	Incorrect protocol.	Correct the protocol.
	Termination is missing.	Terminate the bus with terminating resistor.
Despite the aforementioned measures the device does not work.	Device is defective.	Send the device to the manufacturer for inspection and include a detailed description of the error.

Technical data

General	
Net weight	265 g
Net weight (with attached connectors)	300 g
Device dimensions	approx. l = 42 mm, b = 97 mm, h = 100 mm
Service life of the backlight	40,000 hours (50% of initial brightness)

Transport and storage	
The following information applies for devices that are transported or stored in their original packaging.	
Free fall	1 m
Temperature	K55 (-25 °C to +70 °C)
Relative humidity	0 to 90% RH

Ambient conditions during operation	
The UMG 96RM is intended for use in weather-protected, fixed locations. Protection class II according to IEC 60563 (VDE 0106, part 1).	
Rated temperature range	K55 (-10 °C .. +55 °C)
Relative humidity	0 to 75 % RH
Operational altitude	0 .. 2000 m above sea level
Degree of pollution	2
Installation position	any
Ventilation	Forced ventilation is not required.
Foreign body and water protection	
- Front	IP40 according to EN60529
- Back	IP20 according to EN60529

Supply voltage	
Installation overvoltage category	300V CAT II
Protection of the power supply (fuse)	6 A Char. B (approved by UL / IEC)
Nominal range	20V - 250V (45..65Hz) or DC 20V - 300V
Working area	+/-10% from the nominal range
Power consumption	max. 13VA / 3W

Connection capacity of the terminals (power supply)	
Connectable conductor. Only one conductor may be connected per contact point!	
Single-wire, multi-wire, finely stranded conductor	0.2 - 2.5mm ² , AWG 26 - 12
Pin terminals, ferrules	0.2 - 2.5mm ²
Tightening torque	0.4 - 0.5Nm
Stripping length	7mm

Outputs	
2 digital outputs, semi-conductor relay, not short circuit protected.	
Switching voltage	max. 33 V AC, 60 V DC
Switching current	max. 50 mAeff AC/DC
Reaction time	10/12 periods + 10 ms *
Pulse output (energy pulses)	max. 50 Hz

* Reaction time at 50 Hz, for example: 200 ms + 10 ms = 210 ms

Connection capacity of the terminals (outputs)	
Rigid/flexible	0.14 - 1.5 mm ² , AWG 28-16
Flexible with ferrules without plastic sleeve	0,20 - 1,5mm ²
Flexible with ferrules with plastic sleeve	0,20 - 1,5mm ²
Tightening torque	0,20 - 0,25Nm
Stripping length	7 mm

Voltage metering	
Three-phase, 4-wire systems with nominal voltages up to	277 V/480 V (+-10%)
Three-phase, 3-wire systems, unearthed, with nominal voltages up to	IT 480 V (+-10%)
Overvoltage category	300V CAT III
Rated surge voltage	4 kV
Metering range L-N	0 ¹⁾ .. 300 Vrms (max. overvoltage 520 Vrms)
Metering range L-L	0 ¹⁾ .. 520Vrms (max. overvoltage 900Vrms)
Resolution	0.01 V
Crest factor	2.45 (relative to the metering range)
Impedance	4 MOhm/phase
Power consumption	approx. 0.1 VA
Sampling rate	21.33 kHz (50 Hz), 25.6 kHz (60 Hz) per measuring channel
Mains frequency - Resolution	45 Hz .. 65 Hz 0.01 Hz

- ¹⁾ The UMG 96RM can only determine measured values if a L-N voltage greater than 10 Veff or a L-L voltage larger than 18 Veff is applied to at least one voltage measurement input.

Current measurement	
Rated current	5A
Metering range	0 .. 6Arms
Crest factor	1.98
Resolution	0.1 mA (display 0.01 A)
Overvoltage category	300V CAT II
Rated surge voltage	2kV
Power consumption	approx. 0.2 VA (Ri=5 mOhm)
Overload for 1 sec.	120 A (sinusoidal)
Sampling rate	21.33 kHz (50 Hz), 25.6 kHz (60 Hz) per measuring channel

Connection capacity of the terminals (voltage and current measurement)		
Connectable conductor. Only one conductor may be connected per contact point!		
	Current	Voltage
Single-wire, multi-wire, finely stranded conductor	0.2 - 2.5mm ² , AWG 26-12	0.08 - 4.0mm ² , AWG 28-12
Pin terminals, ferrules	0.2 - 2.5mm ²	0.2 - 2.5mm ²
Tightening torque	0.4 - 0.5Nm	0.4 - 0.5Nm
Stripping length	7mm	7mm

Serial interface	
RS485 - Modbus RTU/slave	9.6kbps, 19.2kbps, 38.4kbps, 57.6 kbps, 115.2kbps
Stripping length	7mm

Connection capacity of the terminals (serial interface)	
Single-wire, multi-wire, finely stranded conductor	0.20 - 1.5mm ²
Pin terminals, ferrules	0.20 - 1.5mm ²
Tightening torque	0.20 - 0.25Nm
Stripping length	7mm

Parameters of functions

Function	Symbol	Accuracy class	Metering range	Display range
Total real power	P	0.5 ⁵⁾ (IEC61557-12)	0 .. 5.4 kW	0 W .. 999 GW *
Total reactive power	QA, Qv	1 (IEC61557-12)	0 .. 5.4 kvar	0 varh .. 999 Gvarh *
Total apparent power	SA, Sv	0.5 ⁵⁾ (IEC61557-12)	0 .. 5.4 kVA	0 VA .. 999 GVA *
Total active energy	Ea	0.5S ⁵⁾ 6) (IEC61557-12)	0 .. 5.4 kWh	0 Wh .. 999 GWh *
Total reactive energy	ErA, ErV	1 (IEC61557-12)	0 .. 5.4 kvarh	0 varh .. 999 Gvarh *
Total apparent energy	EapA, EapV	0.5 ⁵⁾ (IEC61557-12)	0 .. 5.4 kVAh	0 VAh .. 999 GVAh *
Frequency	f	0.05 (IEC61557-12)	45 .. 65 Hz	45.00 Hz .. 65.00 Hz
Phase current	I	0.2 (IEC61557-12)	0 .. 6 Arms	0 A .. 999 kA
Measured neutral conductor current	IN	-	-	-
Calculated neutral conductor current	INc	1.0 (IEC61557-12)	0.03 .. 25 A	0.03 A .. 999 kA
Voltage	U L-N	0.2 (IEC61557-12)	10 .. 300 Vrms	0 V .. 999 kV
Voltage	U L-L	0.2 (IEC61557-12)	18 .. 520 Vrms	0 V .. 999 kV
Displacement factor	PFA, PFV	0.5 (IEC61557-12)	0.00 .. 1.00	0.00 .. 1.00
Short-term flicker, long-term flicker	Pst, Plt	-	-	-
Voltage dips (L-N)	Udip	-	-	-
Voltage surges (L-N)	Uswl	-	-	-
Transient overvoltages	Utr	-	-	-
Voltage interruptions	Uint	-	-	-
Voltage unbalance (L-N) ¹⁾	Unba	-	-	-
Voltage unbalance (L-N) ²⁾	Unb	-	-	-
Voltage harmonics	Uh	Class 1 (IEC61000-4-7)	up to 2.5 kHz	0 V .. 999 kV
THD of the voltage ³⁾	THDu	1.0 (IEC61557-12)	up to 2.5 kHz	0 % .. 999 %
THD of the voltage ⁴⁾	THD-Ru	-	-	-

Function	Symbol	Accuracy class	Metering range	Display range
Current harmonics	lh	Class 1 (IEC61000-4-7)	up to 2.5 kHz	0 A .. 999 kA
THD of the current ³⁾	THDi	1.0 (IEC61557-12)	up to 2.5 kHz	0 % .. 999 %
THD of the current ⁴⁾	THD-Ri	-	-	-
Mains signal voltage	MSV	-	-	-

1) Referred to amplitude.

2) Referred to phase and amplitude.

3) Referred to mains frequency.

4) Referred to root mean square value.

5) Accuracy class 0.5 with .. /5 A transformer.

Accuracy class 1 with .. /1 A transformer.

6) Accuracy class 0.5S according IEC62053-22

* The display returns to 0 W when the maximum total energy values are reached.

Parameter and Modbus address list

The following excerpt from the parameter list contains settings that are necessary for proper operation of the UMG 96RM, such as current transformers and device addresses. The values in the parameter list can be written and read.



A complete overview of the parameters and measured values as well as explanations regarding the selected measured values is filed in the document "Modbus Address List" on the CD or Internet.

In the excerpt, the measured value list files the measured and calculated measured values, output status data and recorded values so that they can be read.



The addresses contained in the description can be adjusted directly on the device in the range from 0 to 800. The address range above 1000 can only be processed via modbus!

Table 1 - Parameter list

Address	Format	RD/WR	Unit	Note	Adjustment Range	Default
0	SHORT	RD/WR	-	Device address	0..255 ^(*)	1
1	SHORT	RD/WR	kbps	baud rate (0=9.6kbps, 1=19.2kbps, 2=38.4kbps, 3= 57.6kbps, 4=115.2kbps)	0.7 (5..7 only for internal use)	4
2	SHORT	RD/WR	-	Modbus Master 0=Slave, 1=Master (only for version with Ethernet)	0, 1	0
3	SHORT	RD/WR	-	Stopbits (0=1Bit, 1=2Bits)	0, 1	0
10	FLOAT	RD/WR	A	Current transformer I1, primary	0..1000000 ^(*)	5
12	FLOAT	RD/WR	A	Current transformer I1, sec.	1..5	5
14	FLOAT	RD/WR	V	Voltage transformer V1, prim.	0..1000000 ^(*)	400
16	FLOAT	RD/WR	V	Voltage transformer V1, sec.	100, 400	400
18	FLOAT	RD/WR	A	Current transformer I2, primary	0..1000000 ^(*)	5
20	FLOAT	RD/WR	A	Current transformer I2, sec.	1..5	5

^(*) The values 0 and 248 to 255 are reserved and must not be used.

^(*) The adjustable value 0 does not produce any sensible energy values and must not be used.

Address	Format	RD/WR	Unit	Note	Adjustment Range	Default
22	FLOAT	RD/WR	V	Voltage transformer V2, prim.	0..1000000	400
24	FLOAT	RD/WR	V	Voltage transformer V2, sec.	100, 400	400
26	FLOAT	RD/WR	A	Current transformer I3, primary	0..1000000	5
28	FLOAT	RD/WR	A	Current transformer I3, sec.	1..5	5
30	FLOAT	RD/WR	V	Voltage transformer V3, prim.	0..1000000	400
32	FLOAT	RD/WR	V	Voltage transformer V3, sec.	100, 400	400
34	SHORT	RD/WR	Hz	Frequency determination 0=Auto, 45 .. 65=Hz	0, 45 .. 65	0
35	SHORT	RD/WR	-	Display contrast 0 (low), 9 (high)	0 .. 9	5
36	SHORT	RD/WR	-	Backlight 0 (dark), 9 (light)	0 .. 9	6
37	SHORT	RD/WR	-	Display profile 0=default display profile 1=default display profile 2=default display profile 3=freely selectable display profile	0 .. 3	0
38	SHORT	RD/WR	-	Display change profile 0..2=default display change profiles 3=freely selectable display change profile	0 .. 3	0
39	SHORT	RD/WR	s	Changeover time	0 .. 60	0
40	SHORT	RD/WR	-	Averaging time, I	0 .. 8*	6
41	SHORT	RD/WR	-	Averaging time, P	0 .. 8*	6
42	SHORT	RD/WR	-	Averaging time, U	0 .. 8*	6
45	USHORT	RD/WR	mA	Response threshold of current measuring I1 .. I3	0 .. 200	5
50	SHORT	RD/WR	-	Password	0 .. 999	0 (no password)
100	SHORT	RD/WR	-	Address of the measured value, Digital output 1	0..32000	874

* 0 = 5sec.; 1 = 10sec.; 2 = 15sec.; 3 = 30sec.; 4 = 1min.; 5 = 5min.; 6 = 8min.; 7 = 10min.; 8 = 15min.

Address	Format	RD/WR	Unit	Note	Adjustment Range	Default
101	SHORT	RD/WR	-	Address of the measured value, Digital output 2	0..32000	882
102	FLOAT	RD/WR	Wh	Pulse value, Digital output 1	-1000000..+1000000	1000
104	FLOAT	RD/WR	Wh	Pulse value, Digital output 2	-1000000..+1000000	1000
106	SHORT	RD/WR	10ms	Minimum pulse length (1=10 ms) Digital output 1/2	1..1000	5 (=50 ms)
107	SHORT	RD/WR	-	Result from comparator group 1; Link A, B, C (1=and, 0=or)	0,1	0
108	FLOAT	RD/WR	-	Comparator 1A, Limit value	$-10^{12}-1..+10^{12}-1$	0
110	SHORT	RD/WR	-	Comparator 1A, Address of the measured value	0..32000	0
111	SHORT	RD/WR	s	Comparator 1A, Minimum turn-on time	0..32000	0
112	SHORT	RD/WR	s	Comparator 1A, Lead time	0..32000	0
113	SHORT	RD/WR	-	Comparator 1A, Operator "≥"=0, "<"=1	0,1	0
114	FLOAT	RD/WR	-	Comparator 1B, Limit value	$-10^{12}-1..+10^{12}-1$	0
116	SHORT	RD/WR	-	Comparator 1B, Address of the measured value	0..32000	0
117	SHORT	RD/WR	s	Comparator 1B, Minimum turn-on time	0..32000	0
118	SHORT	RD/WR	s	Comparator 1B, Lead time	0..32000	0
119	SHORT	RD/WR	-	Comparator 1B, Operator "≥"=0 "<"=1	0,1	0
120	FLOAT	RD/WR	-	Comparator 1C, Limit value	$-10^{12}-1..+10^{12}-1$	0
122	SHORT	RD/WR	-	Comparator 1C, Address of the measured value	0..32000	0



Only the first three positions (###) of a value are shown on the display. Values larger than 1,000 are marked with „k“. Example: 003k = 3000

Address	Format	RD/WR	Unit	Note	Adjustment Range	Default
123	SHORT	RD/WR	s	Comparator 1C, Minimum turn-on time	0..32000	0
124	SHORT	RD/WR	s	Comparator 1C, Lead time	0..32000	0
125	SHORT	RD/WR	-	Comparator 1C, Operator "≥"=0 "≤"=1	0,1	0
126	SHORT	RD/WR	-	Result from comparator group 2; Link A, B, C (1=and, 0=or)	0,1	0
127	FLOAT	RD/WR	-	Comparator 2A, Limit value	-10 ¹² -1..+10 ¹² -1	0
129	SHORT	RD/WR	-	Comparator 2A, Address of the measured value	0..32000	0
130	SHORT	RD/WR	s	Comparator 2A, Minimum turn-on time	0..32000	0
131	SHORT	RD/WR	s	Comparator 2A, Lead time	0..32000	0
132	SHORT	RD/WR	-	Comparator 2A, Operator "≥"=0 "≤"=1	0,1	0
133	FLOAT	RD/WR	-	Comparator 2B, Limit value	-10 ¹² -1..+10 ¹² -1	0
135	SHORT	RD/WR	-	Comparator 2B, Address of the measured value	0..32000	0
136	SHORT	RD/WR	s	Comparator 2B, Minimum turn-on time	0..32000	0
137	SHORT	RD/WR	s	Comparator 2B, Lead time	0..32000	0
138	SHORT	RD/WR	-	Comparator 2B, Operator "≥"=0 "≤"=1	0,1	0
139	FLOAT	RD/WR	-	Comparator 2C, limit value	-10 ¹² -1..+10 ¹² -1	0
141	SHORT	RD/WR	-	Comparator 2C, Address of the measured value	0..32000	0
142	SHORT	RD/WR	s	Comparator 2C, Minimum turn-on time	0..32000	0
143	SHORT	RD/WR	s	Comparator 2C, lead time	0..32000	0
144	SHORT	RD/WR	-	Comparator 2C, Operator "≥"=0 "≤"=1	0,1	0

Address	Format	RD/WR	Unit	Note	Adjustment Range	Default
145	SHORT	RD/WR	-	„Display blinking“ Bit 1 = 1/0: active/inactive for comparator group output 1 Bit 2 = 1/0: active/inactive for comparator group output 2	0-3	0
200	SHORT	RD/WR	-	Select the source for Digital output 1	0..4 ^{*1}	1
201	SHORT	RD/WR	-	Digital output 1 inverter	0..1 ^{*2}	0
202	SHORT	RD/WR	-	Select the source for Digital output 2	0..4 ^{*1}	1
203	SHORT	RD/WR	-	Digital output 2 inverter	0..1 ^{*2}	0
500	SHORT	RD/WR	-	Terminal assignment, I L1	-3..0..+3 ^{*3}	+1
501	SHORT	RD/WR	-	Terminal assignment, I L2	-3..0..+3 ^{*3}	+2
502	SHORT	RD/WR	-	Terminal assignment, I L3	-3..0..+3 ^{*3}	+3
503	SHORT	RD/WR	-	Terminal assignment, U L1	0..3 ^{*3}	1
504	SHORT	RD/WR	-	Terminal assignment, U L2	0..3 ^{*3}	2
505	SHORT	RD/WR	-	Terminal assignment, U L3	0..3 ^{*3}	3
506	SHORT	RD/WR	-	Clear min. and max. values	0..1	0
507	SHORT	RD/WR	-	Clear energy meter	0..1	0
508	SHORT	RD/WR	-	Force write EEPROM.	0..1	0
Note: Energy values and minimum and maximum values are written to the EEPROM every 5 minutes.						
509	SHORT	RD/WR	-	Voltage connection diagram	0..8 ^{*4}	0
510	SHORT	RD/WR	-	Current connection diagram	0..8	0
511	SHORT	RD/WR	-	Relative voltage for THD and FFT	0, 1	0
The voltages for THD and FFT can be shown on the display as L-N or L-L values. 0=LN, 1=LL						

*1 0 = comparator group, 1=pulse output, 2=value from an external source (Modbus), 3=reserved, 4=reserved

*2 0=not inverted, 1=inverted *3 0 = No measurement of the current or voltage path. *4 The setting 8 is equal setting 0.

Address	Format	RD/WR	Unit	Note	Adjustment Range	Default
512	SHORT	RD/WR	-	Year	0..99 ^{*2}	
513	SHORT	RD/WR	-	Month	0..12 ^{*2}	
514	SHORT	RD/WR	-	Day	0..31 ^{*2}	
515	SHORT	RD/WR	-	Hour	0..24 ^{*2}	
516	SHORT	RD/WR	-	Minute	0..59 ^{*2}	
517	SHORT	RD/WR	-	Second	0..59 ^{*2}	
600	UINT	RD/WR	-	Metering range exceedance	0..0xFFFFFFFF	
602	SHORT	RD/WR	-	Modbus value for output 1	0, 1	
605	SHORT	RD/WR	-	Modbus value for output 2	0, 1	
608	SHORT	RD	-	State of output 1		
609	SHORT	RD	-	State of output 2		
610	SHORT	RD	-	Comparator result 1 Output A		
611	SHORT	RD	-	Comparator result 1 Output B		
612	SHORT	RD	-	Comparator result 1 Output C		
613	SHORT	RD	-	Comparator result 2 Output A		
614	SHORT	RD	-	Comparator result 2 Output B		
615	SHORT	RD	-	Comparator result 2 Output C		
616	SHORT	RD	-	Linkage result of comparator group 1		
617	SHORT	RD	-	Linkage result of comparator group 2		
750	SHORT	RD	-	Software release		
754	SERNR	RD	-	Serial number		
756	SERNR	RD	-	Production number		
746	SHORT	RD/WR	s	Period of time after which the backlight will switch to standby	60 .. 9999	900
747	SHORT	RD/WR	s	Brightness of the standby backlight	0 .. 9	0

*1 - = rotate connections , digit 1..3 = phase assignment, digit 0 = channel disabled.

*2 - = Value settings only for the UMG96RM extensions with battery and clock.

Table 2 - Modbus address list

(frequently used measured values)



The addresses contained in the description can be adjusted directly on the device in the range from 0 to 800.

The address range 800-999 is available for programming comparators on the device. The addresses above 1000 can only be processed via modbus!



A complete overview of the parameters and measured values as well as explanations regarding the selected measured values is filed in the document "Modbus Address List" on the CD or Internet.

Modbus Address	Address Above display	Format	RD/WR	Unit	Note
19000	808	float	RD	V	Voltage L1-N
19002	810	float	RD	V	Voltage L2-N
19004	812	float	RD	V	Voltage L3-N
19006	814	float	RD	V	Voltage L1-L2
19008	816	float	RD	V	Voltage L2-L3
19010	818	float	RD	V	Voltage L3-L1
19012	860	float	RD	A	Current, L1
19014	862	float	RD	A	Current, L2
19016	864	float	RD	A	Current, L3
19018	866	float	RD	A	Vector sum; $IN=I1+I2+I3$
19020	868	float	RD	W	Real power L1
19022	870	float	RD	W	Real power L2
19024	872	float	RD	W	Real power L3
19026	874	float	RD	W	Sum; $Psum3=P1+P2+P3$
19028	884	float	RD	VA	Apparent power S L1
19030	886	float	RD	VA	Apparent power S L2

Modbus Address	Address Above display	Format	RD/WR	Unit	Note
19032	888	float	RD	VA	Apparent power S L3
19034	890	float	RD	VA	Sum; Ssum3=S1+S2+S3
19036	876	float	RD	var	Fund. reactive power (mains frequ.) Q L1
19038	878	float	RD	var	Fund. reactive power (mains frequ.) Q L2
19040	880	float	RD	var	Fund. reactive power (mains frequ.) Q L3
19042	882	float	RD	var	Sum; Qsum3=Q1+Q2+Q3
19044	820	float	RD	-	Fund.power factor, CosPhi; U L1-N IL1
19046	822	float	RD	-	Fund.power factor, CosPhi; U L2-N IL2
19048	824	float	RD	-	Fund.power factor, CosPhi; U L3-N IL3
19050	800	float	RD	Hz	Measured frequency
19052	-	float	RD	-	Rotation field; 1=right, 0=none, -1=left
19054	-	float	RD	Wh	Real energy L1
19056	-	float	RD	Wh	Real energy L2
19058	-	float	RD	Wh	Real energy L3
19060	-	float	RD	Wh	Real energy L1..L3
19062	-	float	RD	Wh	Real energy L1, consumed
19064	-	float	RD	Wh	Real energy L2, consumed
19066	-	float	RD	Wh	Real energy L3, consumed
19068	-	float	RD	Wh	Real energy L1..L3, consumed, rate 1
19070	-	float	RD	Wh	Real energy L1, delivered
19072	-	float	RD	Wh	Real energy L2, delivered
19074	-	float	RD	Wh	Real energy L3, delivered
19076	-	float	RD	Wh	Real energy L1..L3, delivered
19078	-	float	RD	VAh	Apparent energy L1
19080	-	float	RD	VAh	Apparent energy L2
19082	-	float	RD	VAh	Apparent energy L3
19084	-	float	RD	VAh	Apparent energy L1..L3
19086	-	float	RD	varh	Reactive energy L1
19088	-	float	RD	varh	Reactive energy L2
19090	-	float	RD	varh	Reactive energy L3
19092	-	float	RD	varh	Reactive energy L1..L3

Modbus Address	Address Above display	Format	RD/WR	Unit	Note
19094	-	float	RD	varh	Reactive energy, inductive, L1
19096	-	float	RD	varh	Reactive energy, inductive, L2
19098	-	float	RD	varh	Reactive energy, inductive, L3
19100	-	float	RD	varh	Reactive energy L1..L3, ind.
19102	-	float	RD	varh	Reactive energy, capacitive, L1
19104	-	float	RD	varh	Reactive energy, capacitive, L2
19106	-	float	RD	varh	Reactive energy, capacitive, L3
19108	-	float	RD	varh	Reactive energy L1..L3, cap.
19110	836	float	RD	%	Harmonic, THD, U L1-N
19112	838	float	RD	%	Harmonic, THD, U L2-N
19114	840	float	RD	%	Harmonic, THD, U L3-N
19116	908	float	RD	%	Harmonic, THD, I L1
19118	910	float	RD	%	Harmonic, THD, I L2
19120	912	float	RD	%	Harmonic, THD, I L3

Number formats

Type	Size	Minimum	Maximum
short	16 bit	-2 ¹⁵	2 ¹⁵ -1
ushort	16 bit	0	2 ¹⁶ -1
int	32 bit	-2 ³¹	2 ³¹ -1
uint	32 bit	0	2 ³² -1
float	32 bit	IEEE 754	IEEE 754



Notes on saving measurement values and configuration data:

- The following measurement values are saved at least every 5 minutes:
 - Comparator timer
 - S0 meter readings
 - Minimum / maximum / mean values
 - Energy values
- Configuration data is saved immediately!

Dimensional drawings

All dimensions in mm.

Rear view

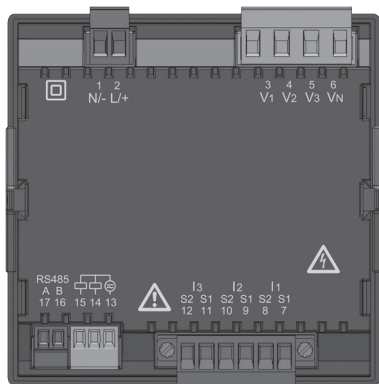

Side view

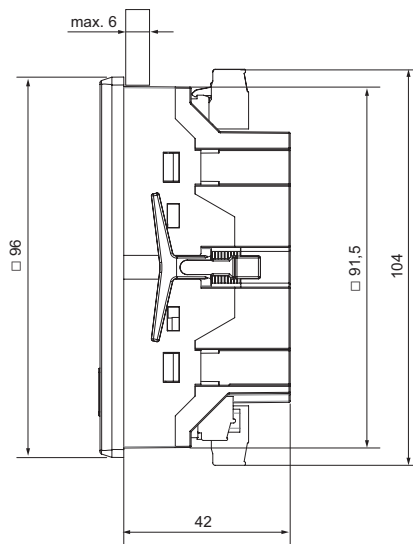

Bottom view

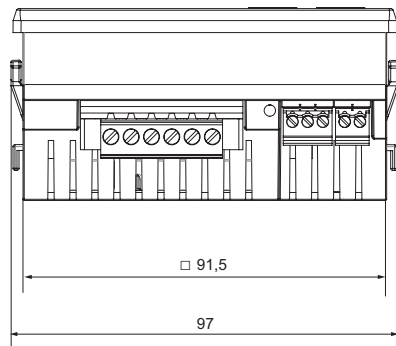

Cutout dimensions

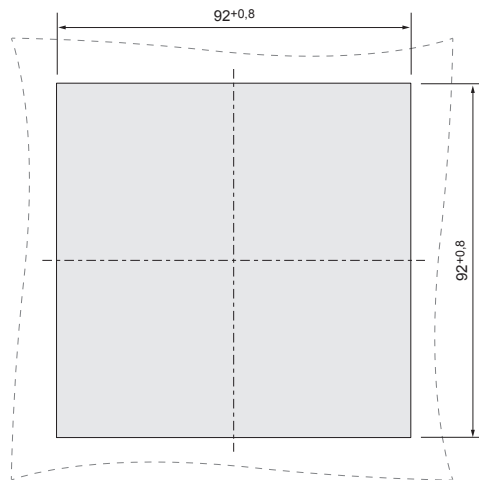

Overview of measured value displays

<p>△ A01</p> <p>Measured values L1-N voltage L2-N voltage L3-N voltage</p>	<p>▷ B01</p> <p>Mean values L1-N voltage L2-N voltage L3-N voltage</p>	<p>▷ C01</p> <p>Maximum values L1-N voltage L2-N voltage L3-N voltage</p>	<p>▷ D01</p> <p>Minimum values L1-N voltage L2-N voltage L3-N voltage</p>
<p>△ A02</p> <p>Measured values L1-L2 voltage L2-L3 voltage L3-L1 voltage</p>	<p>B02</p> <p>Mean values L1-L2 voltage L2-L3 voltage L3-L1 voltage</p>	<p>C02</p> <p>Maximum values L1-L2 voltage L2-L3 voltage L3-L1 voltage</p>	<p>D02</p> <p>Minimum values L1-L2 voltage L2-L3 voltage L3-L1 voltage</p>
<p>△ A03</p> <p>Measured values L1 current L2 current L3 current</p>	<p>B03</p> <p>Mean values L1 current L2 current L3 current</p>	<p>C03</p> <p>Maximum values L1 current L2 current L3 current</p>	<p>D03</p> <p>Maximum values (mean value) L1 current L2 current L3 current</p>
<p>△ A04</p> <p>Measured value Sum Current in the N line</p>	<p>B04</p> <p>Mean value Sum Current in the N line</p>	<p>C04</p> <p>Maximum value Measured value sum Current in the N line</p>	<p>D04</p> <p>Maximum values Sum mean value Current in the N line</p>
<p>△ A05</p> <p>Measured values L1 active power L2 active power L3 active power</p>	<p>B05</p> <p>Mean value L1 active power L2 active power L3 active power</p>	<p>C05</p> <p>Maximum values L1 active power L2 active power L3 active power</p>	
<p>△ A06</p> <p>Measured value Sum Active power</p>	<p>B06</p> <p>Mean value Sum Active power</p>	<p>C06</p> <p>Maximum value Sum Active power</p>	<p>D06</p> <p>Maximum value Sum Active power mean value</p>

<p>△ A07 ▷</p> <p>Measured values L1 apparent power L2 apparent power L3 apparent power</p>	<p>△ B07 ▷</p> <p>Mean values L1 apparent power L2 apparent power L3 apparent power</p>	<p>△ C07 ▷</p> <p>Maximum values L1 apparent power L2 apparent power L3 apparent power</p>
<p>△ A08</p> <p>Measured value Sum Apparent power</p>	<p>B08</p> <p>Mean value Sum Apparent power</p>	<p>C08</p> <p>Maximum value Sum Apparent power</p>
<p>△ A09</p> <p>Measured values L1 reactive power L2 reactive power L3 reactive power</p>	<p>B09</p> <p>Mean values L1 reactive power L2 reactive power L3 reactive power</p>	<p>C09</p> <p>Maximum values (ind) L1 reactive power L2 reactive power L3 reactive power</p>
<p>△ A10</p> <p>Measured value Sum of reactive power</p>	<p>B10</p> <p>Mean value Sum of reactive power</p>	<p>C10</p> <p>Maximum value (ind) Sum of reactive power</p>
<p>△ A11</p> <p>Measured value Distortion factor (THD) U L1</p>	<p>B11</p> <p>Measured value Distortion factor (THD) U L2</p>	<p>C11</p> <p>Measured value Distortion factor (THD) U L3</p>
<p>△ A12</p> <p>Measured value Distortion factor (THD) I L1</p>	<p>B12</p> <p>Measured value Distortion factor (THD) I L2</p>	<p>C12</p> <p>Measured value Distortion factor (THD) I L3</p>

<p>△ A13</p> <p>Maximum value Distortion factor (THD) U L1</p>	<p>▷ B13</p> <p>Maximum value Distortion factor (THD) U L2</p>	<p>▷ C13</p> <p>Maximum value Distortion factor (THD) U L3</p>					
<p>△ A14</p> <p>Maximum value Distortion factor (THD) I L1</p>	<p>B14</p> <p>Maximum value Distortion factor (THD) I L2</p>	<p>C14</p> <p>Maximum value Distortion factor (THD) I L3</p>					
<p>△ A15</p> <p>Measured value L1 cos(phi) L2 cos(phi) L3 cos(phi)</p>							
<p>△ A16</p> <p>Measured value Sum of cos(phi)</p>	<p>B16</p> <p>Mean value Sum of cos(phi)</p>						
<p>△ A17</p> <p>Measured value Frequency L1 Rotation field display</p>							
<p>△ A18</p> <p>Measured value Total active energy (without a backstop)</p>	<p>B18</p> <p>Measured value Total active energy (import)</p>	<p>C18</p> <p>Measured value Total active energy (export)</p>	<p>D18</p> <p>Measured value Sum Apparent energy</p>	<p>E18</p> <p>Measured value Active energy L1 Import (tariff 1)</p>	<p>F18</p> <p>Measured value Active energy L2 Import (tariff 1)</p>	<p>G18</p> <p>Measured value Active energy L3 Import (tariff 1)</p>	

△ A19 Measured value (ind) Reactive energy	▷ B19 Measured value Sum Reactive energy cap.	▷ C19 Measured value Sum Reactive energy ind.	▷ D19 Measured value Reactive energy L1 ind. (tariff 1)	▷ E19 Measured value Reactive energy L2 ind. (tariff 1)	▷ F19 Measured value Reactive energy L3 ind. (tariff 1)
△ A20 Operating hours meter 1	B20 Comparator 1 Total running time	...	G20 Comparator 6 Total running time		
△ A21 Measured value 1st. harmonic U L1	B21 Measured value 3rd. harmonic U L1	...	H21 Measured value 15th. harmonic U L1		
△ A22 Measured value 1st. harmonic U L2	B22 Measured value 3rd. harmonic U L2	...	H22 Measured value 15th. harmonic U L2		
△ A23 Measured value 1st. harmonic U L3	B23 Measured value 3rd. harmonic U L3	...	H23 Measured value 15th. harmonic U L3		
△ A24 Measured value 1st. harmonic I L1	B24 Measured value 3rd. harmonic I L1	...	H24 Measured value 15th. harmonic I L1		

Marked menus are not displayed in the factory presetting.

<p>△ A25</p> <p>Measured value 1st. harmonic I L2</p>	<p>B25</p> <p>Measured value 3rd. harmonic I L2</p>	...	<p>▷ H25</p> <p>Measured value 15th. harmonic I L2</p>
<p>△ A26</p> <p>Measured value 1st. harmonic I L3</p>	<p>B26</p> <p>Measured value 3rd. harmonic I L3</p>	...	<p>H26</p> <p>Measured value 15th. harmonic I L3</p>
<p>△ A27</p> <p>Maximum value 1st. harmonic U L1</p>	<p>B27</p> <p>Maximum value 3rd. harmonic U L1</p>	...	<p>H27</p> <p>Maximum value 15th. harmonic U L1</p>
<p>△ A28</p> <p>Maximum value 1st. harmonic U L2</p>	<p>B28</p> <p>Maximum value 3rd. harmonic U L2</p>	...	<p>H28</p> <p>Maximum value 15th. harmonic U L2</p>
<p>△ A29</p> <p>Maximum value 1st. harmonic U L3</p>	<p>B29</p> <p>Maximum value 3rd. harmonic U L3</p>	...	<p>H29</p> <p>Maximum value 15th. harmonic U L3</p>
<p>△ A30</p> <p>Maximum value 1st. harmonic I L1</p>	<p>B30</p> <p>Maximum value 3rd. harmonic I L1</p>	...	<p>H30</p> <p>Maximum value 15th. harmonic I L1</p>

Marked menus are not displayed in the factory presetting.

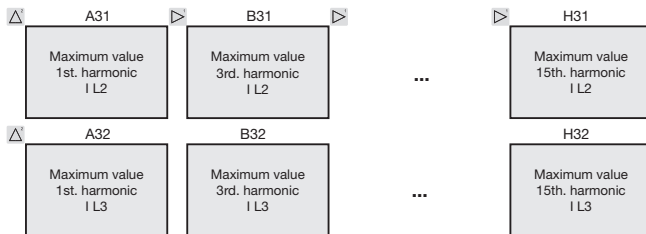

Even and odd harmonics up to the 40th order can be called up via the GridVis software and can be viewed in the software.

Marked menus are not displayed in the factory presetting.

Declaration of conformity

The product fulfils the following EC Directives:	
2004/108/EG	Electromagnetic compatibility of electrical equipment.
2006/95/EG	Electrical equipment for use within certain voltage limits.
Considered standards:	
Noise immunity IEC/EN 61326-1:2013 IEC/EN 61000-4-2:2009 IEC/EN 61000-4-3:2011 IEC/EN 61000-4-4:2013 IEC/EN 61000-4-5:2007 IEC/EN 61000-4-6:2009 IEC/EN 61000-4-8:2010 IEC/EN 61000-4-11:2005	Class A: Industrial environment Electrostatic discharge Electromagnetic RF Field 80-2700MHz Burst Surge Conducted disturbances 0,15-80MHz Power frequency magnetic field Voltage dips, short interrupts, voltage variations and frequency changes
Noise emission IEC/EN 61326-1:2013 IEC/CISPR11/EN 55011:2011 IEC/CISPR11/EN 55011:2011	Class B: Residential environment Radio disturbance field strength 30-1000MHz Radio disturbance voltage 0.15-30MHz
Equipment safety IEC/EN 61010-1:2011 UL61010-1:2012 3rd Edition CAN/CSA-C22.2 No. 61010-1:2012 3rd Edition IEC/EN 61010-2-030:2011	Safety requirements for electrical equipment for Measurement, control and laboratory use – Part 1: General requirements Particular requirements for testing and measuring circuits

Connection example

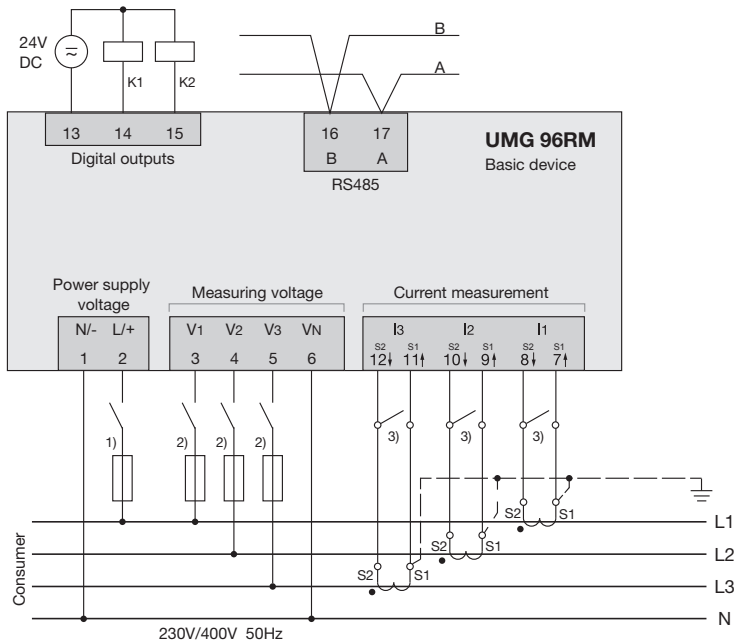

- 1) UL / IEC approved overcurrent protection device (6 A Char. B)
- 2) UL / IEC approved overcurrent protection device (10 A Class CC / Char. C)
- 3) Jumpers (external)

Brief instructions

Changing the current transformer setting

Switch to programming mode:

- Simultaneously press buttons 1 and 2 for approximately 1 second in order to switch to programming mode. The symbols for the programming mode (PRG) and for the current transformer (CT) appear.
- Confirm the selection with button 1.
- The first digit of the input area for the primary current starts flashing.

Changing the primary current

- Change the flashing digit with button 2.
- Select the next digit to be changed with button 1. The selected digit to be changed starts flashing. If the entire number is flashing, the decimal point can be moved with button 2.

Changing the secondary current

- Only 1 A or 5 A can be set as the secondary current.
- Select the secondary current with button 1.
- Change the flashing digit with button 2.

Leaving the programming mode

- Simultaneously press buttons 1 and 2 for approx. 1 second again in order to switch to display mode.

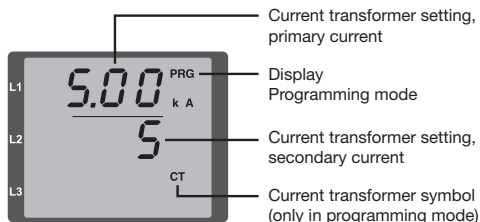

Retrieving measured values

Switch to display mode:

- If programming mode is still active (the PRG and CT symbols appear on the display), simultaneously press buttons 1 and 2 for approximately 1 second in order to switch to display mode.
- A measured value display will appear, e.g. for the voltage

Button control

- Pressing button 2 causes the measured value displays to change from current, voltage, power, etc.
- Pressing button 1 causes the mean values, maximum values, etc. associated with the measured value to change.

