

Universal Measuring Device UMG 96

Operating instructions
Brief instructions see last page

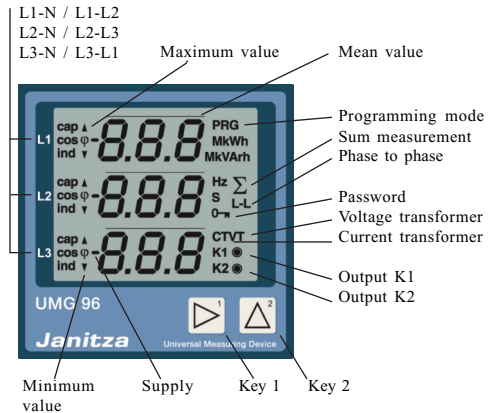

Janitza electronics GmbH
Vor dem Polstück 1
D-35633 Lahnau
Support Tel. +49 6441 9642-22
Fax +49 6441 9642-30
e-mail: info@janitza.com
Internet: http://www.janitza.com

Table of contents

Receipt control	3	Programming mode	12
Product description	4	Key functions	13
Intended use	4	Table 1, Measured value indications	14
Hints for the user	4	Password	16
Functional description	4	Current transformer	16
Hints for Maintenance	5	Programming	16
Repairs and calibration	5	Voltage transformer	17
Front foil	5	Programming	17
Waste management	5	Outputs K1 and K2	18
Installation	6	Usage as switching output	19
Mounting place	6	Programming as switching output	19
Measurement and supply voltage	6	Usage as pulse output	20
Current measurement	6	Programming as pulse output	20
Sum current measurement	6	Pulse valency	21
Connection diagrams	7	Minimum pulse width	22
Installation and putting into service	8	Programming of minimum pulse width	22
Program current and voltage transformers	8	Averaging times (Bimetal function)	23
Connect current transformers	8	Method of taking the mean	23
Check phase assignment	9	Programming of averaging times	23
Check current flow	9	Measured value rotation	24
Removal of errors	10	Programming of rotation time	24
Service	11	Measured value selection	25
Usage and display	12	Programming of the measured value selection	25
Indication mode	12	Delete minimum and maximum values	26
Measured values	12	Delete	26
Mean values	12	Delete energy	26
Energying hours meter	12	Delete	26
		LCD contrast	27
		Programming of LCD contrast	27
		Software Release	27
		User password	27
		Indicating range and accuracy	28
		Configuration data	29
		Technical data	30
		Ambient conditions	30
		Measurement	30
		Outputs	30
		Connectable cables	30
		Back side	31
		Side view	31
		Brief instructions	32
		Programming of current transformer	32
		Call up measured values	32

Receipt control

In order to ensure a perfect and safe use of the device, a proper transport, expert storage, erection and mounting and careful usage and maintenance are required. When it may be supposed, that a safe operation is no longer possible, the device has to be put out of service and be protected against unintentional putting into service.

A safe operation can no longer be assumed, when the device

- shows visible damage,
does not energy in spite of intact net supply,
has been exposed to disadvantageous conditions for a longer time (e.g. storage out of the allowed climate without adaption to the room climate, dew etc.) or transport use (e.g. falling from great height, even without visible damage).

Please test the contents of delivery for completion, before starting the installation of the device. All delivered options are listed on the delivery papers. The operating instructions also describe those options, which are not delivered, and, therefore, do not belong to the contents of delivery.

The following items always belong to the contents of delivery:

- The UMG96,
A packing (item code 52.07.103) with 2 mounting clamps and
The operating instructions.

A seal is available as an option with item code 2901907.

All rights reserved. No part of this manual may be reproduced or duplicated without the written permission of the author. Any contraventions are punishable and will be prosecuted with all legal means.

No liability can be taken for the faultless condition of the manual or damage caused by the use of it. As failures cannot be avoided completely, we shall be very grateful for any advice. We will try to remove any failures as soon as possible. The mentioned software and hardware descriptions are registered trademarks in the most cases and are subjected to the regulations by law. All registered trademarks are property of the corresponding companies and are fully recognized by us.

Product description

Intended use

The UMG96 is suited for fixed mounting and the measurement of voltage, current, power etc. in low voltage switchgear. The measurement is designed for 3 phase systems with neutral conductor (TN and TT-mains). Measurement and supply voltages (50Hz/60Hz) up to 275VAC against earth and 476VAC phase to phase can be connected directly. The measurement and supply voltages must be connected to the UMG 96 via a separation (switch or power switch) and an overcurrent protection fuse (2-10A) in the building installation. The connection of the measurement and supply voltage is carried out on the back side of the UMG 96 via spring power clamps, which are all-insulated. To the current measuring inputs, either $\cdot/5A$ or $\cdot/1A$ current transformers can be connected.

Hints for the user

This device may be installed and used by qualified personnel only, according to the safety regulations. Please mention the legal and safety regulations for the corresponding application, while using the device.

Qualified personnel are persons, who are familiar to installation, mounting, putting into service and operation of the product and have qualifications according to their occupation, for example:

- Education or instruction or the right to switch on or off, ground or characterize current circuits or devices according to the standards of safety techniques.
- Education or instruction in care and use of safety equipment according to the standard safety techniques.

Functional description

The electrical three phase measurement system determines and digitalizes the effective values of voltages and currents in 50/60 Hz netenergy.

The auxiliary voltage needed for operation of UMG 96 is taken from the measurement voltages L1-N, L2-N and L3-N. For devices for measurement in 230V/400V netenergy, at least one phase must be within the rated voltage range. For devices measuring in 58V/100V or 63V/110V netenergy, at least two phases must be in the rated voltage range.

For each random test one period is scanned. From those sampled values the microprocessor calculates the electric magnitudes. These measured values are indicated within the programmable display. The programming data and the minimum and maximum values are saved all 15 minutes in a non-volatile storage (EEPROM).

The transistor outputs K1 and K2 can be used as switching or pulse outputs. The scanning frequency is calculated for all measuring inputs from the net frequency of phase one. For a net frequency of 50Hz the scanning frequency is 2,5kHz and for 60Hz it is 3,0kHz. If the voltage in L1 is smaller than 50V, the UMG 96 uses the last measured net frequency for the determination of the scanning frequency.

In order to achieve a constant quality while reading the display over the whole temperature range, the inner temperature is measured and the contrast is changed automatically.

Attention!

There is no possibility for a measurement in systems with pulsed measurement signals, as no continuous scanning of the measurement signals is carried out.

Hints for Maintenance

Before delivery the device is tested in various safety checks and marked with a seal. If the device is opened, these checks must be repeated.



Attention!

The guarantee is void if the seals are broken.

Repairs and calibration

Repairs and calibration can only be carried out by the manufacturing.

Front foil

The cleaning of the front foil must be done with a soft cloth using a common cleansing agent. Acid or acidic agents may not be used for cleaning.

Waste management

The UMG96 can be disposed as electrical waste according to the legal regulations and recycled.

Installation

Mounting place

The UMG96 is suitable for a fixed installation into low and medium voltage switchgear. Any mounting position is possible.

Measurement and supply voltage

The measurement is laid out for three phase systems with neutral conductor (TN and TT mains). The measurement and supply voltages must be connected to the UMG 96 via a separation (switch or power switch) and an overcurrent protection (2-10A) within the building installation. The connection of the measurement and supply voltages is carried out at the back side of the UMG 96 via shock protected spring clamps.



As the supply voltage is taken from the measurement voltage, at least one measurement input (L-N) must be in the rated range of voltage for operation.

- Devices with a voltage of 196 .. 275V (L-N) or 98 .. 140V (L-N) need a measurement input in the rated voltage range.
- Devices with a measurement and supply voltage of 49 .. 76V (L-N) need two inputs at least in the rated voltage range.

Current measurement

The current measurement is carried out via $\dots/5A$ or $\dots/1A$ current transformers. If the current must be measured additionally to the UMG96, with an Amperemeter, it must be connected in series to the UMG96.



Attention!

The current transformer inputs of the UMG96 are live.

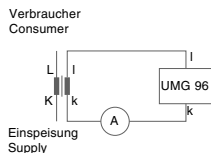

Sum current measurement

If the current measurement is carried out via two current transformers, the total transformer ratio must be set to the UMG96.

Example: Sum current transformer

A current measurement is carried out via one current transformer with a ratio of 1000/5A and one with a ratio of 200/5A. The sum measurement is carried out with a sum transformer 5+5/5A.

The UMG96 must be programmed as follows:

Primary current: $1000A + 200A =$ **1200A**

Secondary current: **5A**

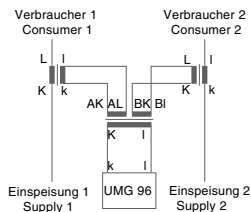

Connection diagrams

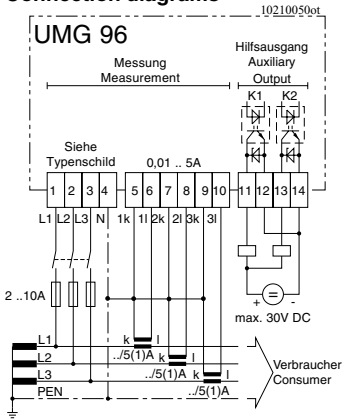

Diagr.: Connection example 1
Four wire measurement with three current transformers

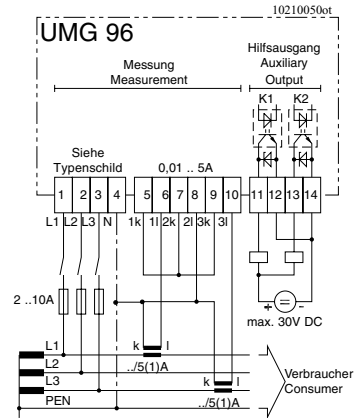

Diagr.: Connection example 2. Four wire measurement with two transformers.

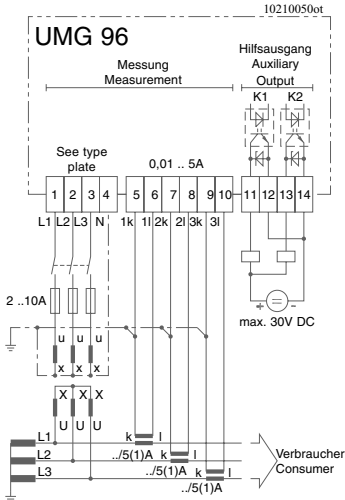

Diagr.: Connection 3
Three wire measurement with voltage transformers and three current transformers.

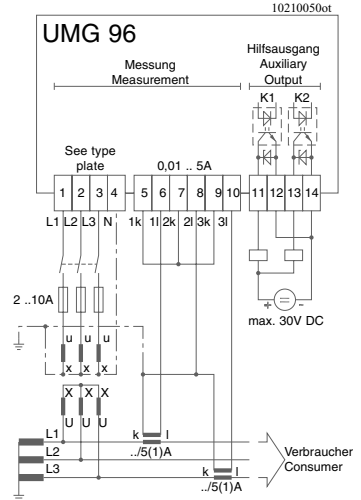

Diagr.: Connection example 4
Three wire measurement with voltage transformers and two current transformers.

Installation and putting into service

The installation and putting into service of the UMG96 should be carried out as follows:

- Mount the device

- Connect measurement and supply voltage

Before connection of the measurement and supply voltage to UMG96, please ensure, that the net conditions match the information on type plate.

The UMG96 can be delivered in three voltage varieties:

Type plate	L-N	Voltage range L-L	Phases, required for operation
196 .. 275V		340 .. 476V	1 Phase + N
98 .. 140V		170 .. 242V	1 Phase + N
49 .. 76V		85 .. 132V	2 Phases + N

To ensure, that the connected measurement and supply voltage is within the allowed range, this must be checked with an AC voltmeter before connecting the UMG96.

The connection wires for measurement voltage to the UMG96 must be suitable for voltages up to 300V against ground and 520V phase to phase.

After switching on the measurement and supply voltage, shown on type plate, all segments on display appear. If no indication appears, please check, if at least one (two) phase are within the rated voltage range. At devices for the measurement in 230V/400V mains, at least one phase must be within the rated voltage range.

Program current and voltage transformers

When the device is delivered, a current transformer ratio of 5/5A is entered.

The voltage transformer ratio must be changed, if a voltage transformer is connected only.



While connecting a voltage transformer, please note the measurement and supply voltage of UMG96, mentioned on type plate.

The program only allows current and voltage transformer ratios, which can lead to sum power of a maximum of 99.9MW.

Connect current transformers

The current transformers (..5A or ..1A) are connected to the clamps k and l from the corresponding outer conductors L1, L2 and L3. The current can be measured with an Amperemeter and compared with the indicated current at the UMG96 to check. Please note, that the current transformer ratio is preset with 5/5A and must be adapted to the used current transformers.



Attention!

The current transformer inputs of the UMG96 are live.

Check phase assignment

The assignment of the outer conductors to the current transformer is correct, if a current transformer is short circuited on the secondary, and the indicated current in the corresponding phase decreases to 0A at the UMG96.

Check current flow

Short circuit two current transformers on the secondary. The real power in the connected phase must be:

Positive (+) for consumption of real power and

negative (-) for supply of real power (power station service).

If no real power is indicated, the assignment of voltages and currents can be wrong.

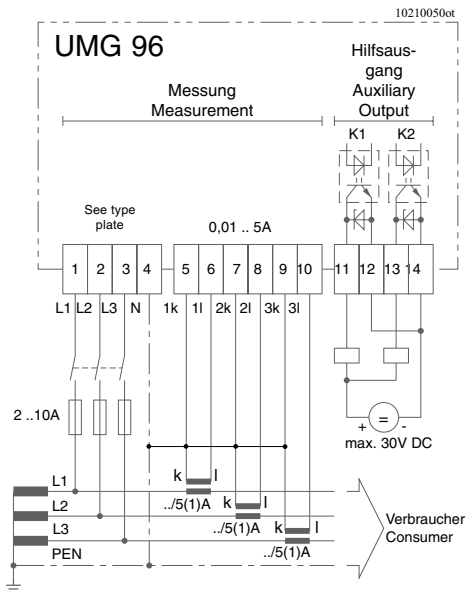

Diagr: Connection example, four wire measurement with three current transformers



Attention!

Voltages, which exceed the allowed voltage range, can damage the device.



Attention!

Current transformer clamps, which are not earthed can be dangerous to touch.

Removal of errors

Fault	Reason	Removal
Display dark.	Fuse released. Device defective.	Insert Fuse. Send the device to the manufacturer for repair.
Measured value cannot be called up.	The indication has been deleted in measured value selection.	Add the required measured value indication to the measured value selection.
No current indication.	Corresponding voltage is not connected.	Connect corresponding voltage.
Current too small.	Current measurement in wrong phase	Check and correct connection.
Current incorrect.	Current measurement in wrong phase Current transformer programmed incorrectly. Measuring range exceeded.	Check and correct connection. Read ratio of current transformer and program accordingly. Insert a current transformer with a higher ratio.
	The current peak at measuring input was exceeded caused by harmonic waves.	Insert a current transformer with a higher ratio. Attention! Please ensure, that the measuring inputs are not overloaded. Insert a current transformer with a smaller ratio.
	The current at measuring input was exceeded.	Check and correct connection.
Voltage L-N incorrect.	Measurement in wrong phase.	Check and correct connection. Attention! Please ensure, that the measuring inputs are not overloaded.
Voltage L-L too small / too high.	Outer conductors exchanged. N not connected.	Check and correct connection. Check and correct connection.

Fault	Reason	Removal
Phase shift ind/cap.	Current path is assigned to the wrong voltage path.	Check and correct connection.
Programmed data get lost.	The device was under electro-magnetical disturbance, which was higher than those mentioned in the technical data.	Improve external protection measures such as protection, filtering, earthing and local separation.
Real power too small / too high.	Current transformer ratio is programmed incorrectly. Current path is assigned to the wrong voltage path.	Read current transformer ratio and program accordingly. Check and correct connection.
Real power generation / consumption exchanged.	At least one current transformer connection is exchanged. Current path is assigned to the wrong voltage path.	Check and correct connection. Check and correct connection.
One output does not react.	The device was programmed incorrectly. The device was connected incorrectly.	Check and correct programming. Check and correct connection.
The device does not operate in spite of the above.	Device defective.	Please send the device back to the manufacturer with a detailed description of the error.

Service

If there are questions, which are not described in this manual, please contact us directly.

For a better conversation we need the following information:

- Device description (see type plate),
- Serial number (see type plate),
- Software Release,
- Measurement and supply voltage and
- Detailed error description.

You can reach us: Monday until Thursday between 07:00 and 15:00
and Friday between 07:00 and 12:00

Janitza electronics GmbH
Vor dem Polstück 1
D-35633 Lahnau
Support: Tel. (0 64 41) 9642-22
Fax (0 64 41) 9642-30
e-mail: info@janitza.de

Usage and display

The usage of the UMG 96 is carried out via the keys one and two. Measured values and programming data are indicated on the liquid crystal display. You must distinguish between

- Indication mode and
- Programming mode.

By entering a password, you can avoid unintentional change of programming data.

Indication mode

In indication mode you can scroll through the programmed measured value indications by using the keys 1 and 2. When the device is delivered, you can call up all measured values shown in table 1. For each measured value indication, up to three measured values are indicated. The measured value rotation allows to indicate all selected measured values one after the other with a selectable changing time.

Measured values

One measurement is carried out each second. The average is built from the detected values and indicated. By taking the mean of the measured values, a large change of the input signals of the indicated measured values appears after 4 second, and can be reduced to 95% of the input signal. The indicated measured value for reactive power can reach 95% of the input signal after 8 seconds at large changes!

Mean values

For currents and power, additional averaging times in the range of 5 to 900 seconds can be set. These measured value are marked with a horizontal bar above the measured value.

Energying hours meter

The energying hours meter detects the time, which the UMG96 is under operation. The time can be measured with a resolution of 15 minutes and indicate in hours.

The energying hours meter cannot be deleted.

Programming mode

In programming mode the settings, which are necessary for the operation of the UMG 96, can be indicated and changed. Pressing the keys 1 and 2 simultaneously for about 1 second, you reach programming mode via the password indication. If no user password is programmed, you reach the first programming menu directly. The programming menu is marked with the text „**PRG**“ in the display.

With key 2 you can change over between the following programming menus:

- Current transformers,
- Voltage transformers,
- Output K1, switching output / pulse output,
- Output K2, switching output / pulse output,
- Minimum pulse width,
- Averaging times (bimetallic function),
- Rotation time of measured value rotation,
- Measured value rotation and measured value selection,
- Delete minimum and peak values,
- Delete energy,
- LCD contrast,
- Software Release,
- User password.

If you are in the menu programming mode, and no keys are pressed within 60 seconds, or you press the keys 1 or 2 simultaneously for about 1 second, you return to the indication mode.

Key functions

	Indication mode	Password	Programming mode
Change mode	<p>simultaneous</p>		
Scroll			
Programming			<p>Programming menu Confirm selection</p> <p> short number +1 long number -1</p> <p> short value *10 (dec. point to the right)</p> <p> long value/10 (dec. point to the left)</p>

Table 1, Measured value indications

▲	Measured values L1-N Voltage L2-N Voltage L3-N Voltage	▷	▷	Maximum values L1-N V, meas. value L2-N V, meas. value L3-N V, meas. value	▷	Minimum values L1-N V, meas. value L2-N V, meas. value L3-N V, meas. value	
▲	Measured values L1-L2 Voltage L2-L3 Voltage L3-L1 Voltage	▷	▷	Maximum values L1-L2 V, meas. value L2-L3 V, meas. value L3-L1 V, meas. value	▷	Minimum values L1-L2 V, meas. value L2-L3 V, meas. value L3-L1 V, meas. value	
▲	Measured values L1 Current L2 Current L3 Current	▷	Mean values L1 Current L2 Current L3 Current	▷	Maximum values L1 Current L2 Current L3 Current	▷	Maximum values L1 cur. mean values L2 cur. mean values L3 cur. mean values
▲	Measured values Σ Current in N	▷	Mean value Σ Current in N	▷	Maximum value Σ Measured value current in N	▷	Maximum values Σ Mean value current in N
▲	Measured values L1 Real power L2 Real power L3 Real power	▷	Mean values L1 Real power L2 Real power L3 Real power	▷	Maximum values L1 Real power, meas. L2 Real power, meas. L3 Real power, meas.	▷	
▲	Measured value Sum real power	▷	Mean value Sum real power	▷	Maximum value (Consumption) Sum real power meas.	▷	Maximum value (Consumption) Sum real power, mean
▲	Measured values L1 Apparent power L2 Apparent power L3 Apparent power	▷	Mean values L1 Apparent power L2 Apparent power L3 Apparent power	▷	Maximum values L1 App. power, meas. L2 App. power, meas. L3 App. power, meas.	▷	
▲	Measured value Sum apparent power	▷	Mean value Sum apparent power	▷	Maximum value Sum App. power, meas.	▷	

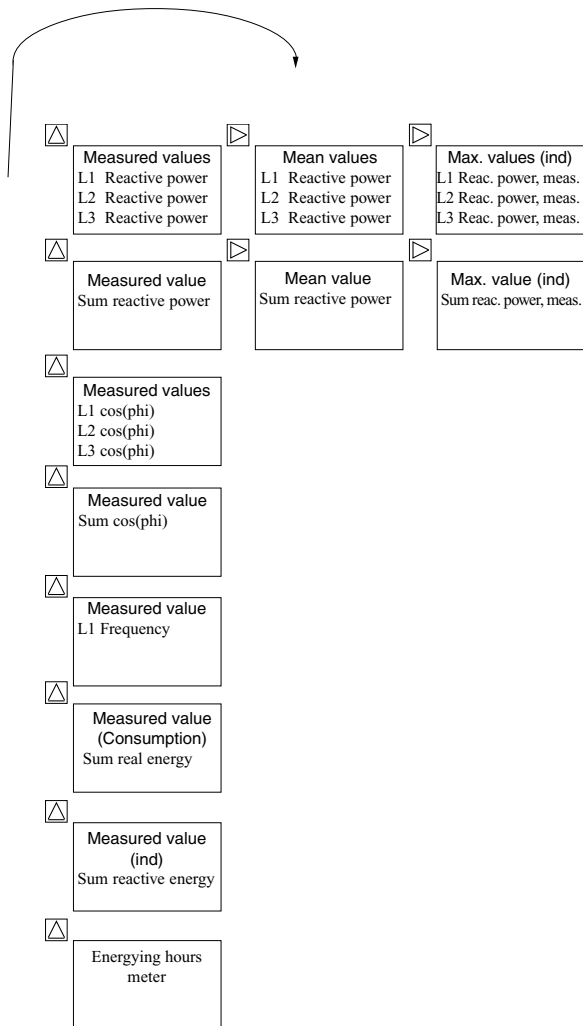

Password

To avoid an unintentional change of programming data, a user password can be entered. If the correct user password is entered, a change into the following programming menus is possible.

In delivery condition, no user password is given (000). In this case, the user password is skipped and you reach the current transformer menu immediately.

If a user password was programmed, the password menu appears in display with the indication „000“.

The first cipher of the user password is flashing and can be changed with key 2. Pressing key 1, the next cipher is selected and flashes.

After entering the correct cipher combination, you reach the programming menu for the current transformer.

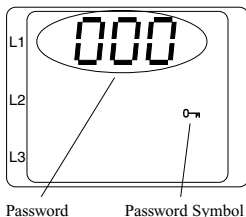

Current transformer

Current transformers with a secondary current of 1A or 5A can be connected to the UMG 96 by choice.

The presetting is a current transformer ratio of 5A/5A. As the secondary current, only 1A or 5A can be set.

In programming mode the current transformer setting is marked with the symbol „CT“.

Primary current (5.00kA = 5000A)

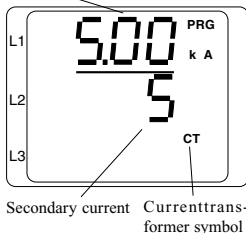

Programming

In programming mode you scroll to the current transformer ratio by pressing key 2. Confirm the selection by pressing key 1.

The first cipher of the primary current is flashing and can be changed by pressing key 2. Pressing key 1, you select the next cipher, which is flashing now.

If the complete number is flashing, the decimal point can be moved. Press key 2 shortly - The decimal point moves to the right.

Press key 2 longer - The decimal point moves to the left.

If no cipher is flashing anymore, you can go to the indication of the voltage transformer.

Example: Sum current transformer

A current measurement is carried out via two current transformers, each with a ratio of 1000/5A and one transformer with a ratio of 200/5A. The sum measurement is carried out with a sum current transformer 5+5/5A.

The UMG96 must be programmed with the following values:

Primary current: $1000A + 200A = 1200A$

Secondary current: $5A$



Attention!

The program only allows current and voltage transformer ratios, if the single phase power can be 33.3kW maximum and the sum power 99.9kW maximum.

Voltage transformer

Only voltages with a secondary voltage, which is marked on type plate of the UMG 96, can be connected.

Type plate UMG96	Input voltage UMG96 L-L (Secondary voltage)
196 .. 275V	400V (Standard version)
98 .. 140V	220V und 200V (Option)
49 .. 76V	110V und 100V (Option)

As secondary and primary voltage, the **phase to phase voltage (L/L)** is given in the display of UMG96. When the device leaves our factory, the primary voltage is set the same as the secondary voltage. This means a transformer ratio of 1:1.

In programming mode, the voltage transformer is marked with the symbol „VT“.

Programming

In programming mode, please scroll to the voltage transformer setting by pressing key 2. Confirm with key 1.

The first cipher of the primary voltage is flashing and can be changed by pressing key 2. If you confirm with key 1, the next cipher is flashing and can be changed.

If the complete number is flashing, you can move the decimal point. If no cipher is flashing anymore, you can go to the programming of the outputs by pressing key 2.



Attention!

The program only allows current and voltage transformer ratios, if the single phase power can be 33.3kW maximum and the sum power 99.9kW maximum.

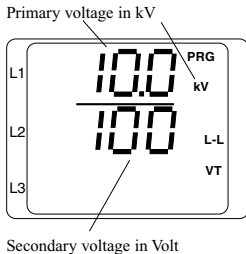
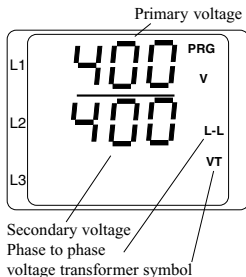

Outputs K1 and K2

The UMG96 has got two outputs. Each output can either be used as a switching output or pulse output.

The presetting for the outputs is:

Output 1 = Pulse output for real energy

Output 2 = Pulse output for reactive energy

Outputs, which are assigned to a energy, energy as a pulse output.

Outputs, which are assigned to a measured value, energy as a switching output.

The real energy can only be assigned to output 1 and reactive energy can only be assigned to output 2.

One measured value can be assigned to each switching output. If necessary, you can activate each single phase. A switching output switches, when a set limit is exceeded or underscored.

Therefore it is possible to supervise only the current in L1 and L2 with one threshold, for instance.

The condition of the outputs is marked by a cyclic symbol.

- Output is off, no current flowing.
- Output is on, a current can flow.

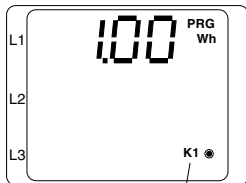

Output K1



Output K2

Usage as switching output

If a measured value, but not energy, is assigned to the outputs K1 or K2, the output energises as a switching output. The following values for programming are at your disposal:

- Limit
- Decimal point
- Measured value
- Sign
- Exceeding / underscoring
- Mean value
- Phase

The selected measured value is compared to the set limit. If this limit is exceeded or underscored, depending on your programming, the corresponding output switches.

In order to avoid a too frequent switching, a minimum connection time of one second is fixely programmed.

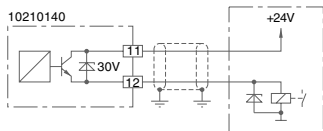
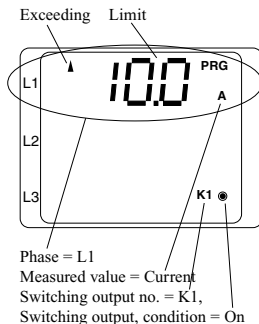

Diagr. Switching output with external relay in minus.

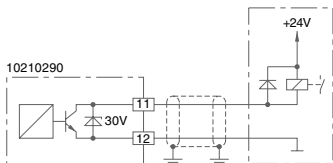

Diagr. Switching output with external relay in plus..

Programming as switching output

In programming mode, scroll to output **K1** or **K2** by pressing key 2.

Confirm selection with key 1.

The first cipher of the selected limit flashes.

Scroll to the next symbol or value with key 1. Flashing symbols or values can be changed using key 2.

If the symbol **PRG** is flashing, a selection of the phases can be carried out.

If the complete number is flashing, the decimal point can be moved.

If the flashing symbols for the sign and mean value are longer on than off, they are selected and remain on after proceeding with key 1.

If no symbol is flashing anymore, you can change over to the next menu by using key 2.

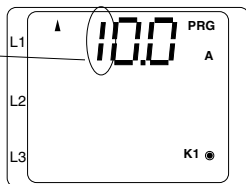

Attention! The programmed values for the outputs can only partially be checked, if they are plausible.

Usage as pulse output

If real energy is assigned to output K1 or reactive energy to K2, the respective output energys as a pulse output. For each pulse output, a pulse valency can be defined (Wh/pulse, VARh/pulse). The pulses, sampled within one second, are given out with a minimum duration of 50ms and a maximum frequency of 10Hz. The pulse distances are **not** proportional to the power.

If the measured energy exceeds the set pulse valency, so that the maximum frequency for the pulse output is exceeded, the remaining pulses are stored and given out later. Saved pulses get lost in case of a net breakdown.

Attention!

As the real energy meter operates with reverse running stop, there will only be pulses given out, when electrical energy is consumed.

As the reactive power meter operates with reverse running stop, there will only be pulses given out at inductive load.

Pulse valency=100VARh/pulse

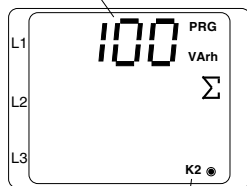

Output K2

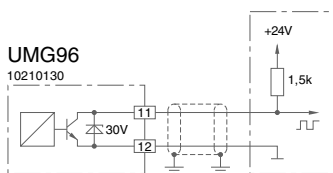

Diagr.: Usage as pulse output.

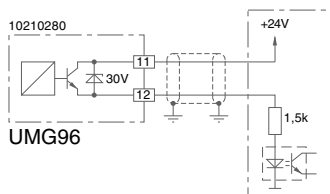

Diagr. Usage as pulse output for optic coupling.

Programming as pulse output

In programming mode scroll to output K1 or k2 with key 2. Confirm selection with key 1.

The first number of the pulse valency flashes and can be changed with key 2. Confirming with key 1, the next cipher is selected and flashing.

If the whole number is flashing, the decimal point can be moved by using key 2.

If no cipher is flashing anymore, you can change over to the next programming menu using key 2.

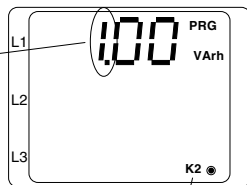

Output K2

Pulse valency

The pulse valency is given in Wh per pulse.

$$\text{Pulse valency} = \text{Energy per pulse}$$

The pulse valency may not be confused with the kW-meter-constant. The kW-meter-constant is given in

$$\text{kW-meter-constant} = \text{Rotations per kWh}$$

The context between pulse valency and kW-meter- constant can be seen in the following correlations:

$$\text{kW-meter-constant} = 1/\text{pulse valency}$$

$$\text{Pulse valency} = 1/\text{kW-meter-constant}$$

Example

For an AC mains with connected consumers, which have a real power consumption of 400kW, the pulse valency must be calculated.

The energy, which can be consumed in one our, is:

$$\text{Energy} = \text{Real power} * \text{time}$$

$$\text{Energy} = 400\text{kW} * 1\text{h}$$

$$\text{Energy} = 400\text{kWh}$$

The result is a pulse valency of:

$$\text{Pulse valency} = \text{Energy/pulse}$$

$$\text{Pulse valency} = 400\text{kWh/pulse}$$

This means, that the pulse valency must be equivalent or higher than 400kWh/pulse, and must be set at UMG 96. Now one pulse per hour appears at the output at a power of 400kW.

If at a power of 400kW more pulses per time are required, 1 pulse per minute, for instance, the pulse valency must be set to:

$$\text{Pulse valency} = 400\text{kWh/pulse} : 60$$

$$\text{Pulse valency} = 67\text{kWh/pulse}$$

If at a power of 400kW even more pulses are required, 1 pulse per second, for instance, the pulse valency is:

$$\text{Pulse valency} = 400\text{kWh/pulse} : 3600$$

$$\text{Pulse valency} = 112\text{Wh/pulse}$$

Minimum pulse width

If one of the outputs K1 or K2 is used as pulse output, a programmable minimum pulse width is assigned. The minimum pulse width cannot be set separately for the outputs K1 and K2, but is valid for both pulse outputs.

The minimum pulse width can be set in the range of 0.05 seconds up to 2.00 seconds in 0.05 second steps. The presetting of minimum pulse width is set to 0.05 seconds.

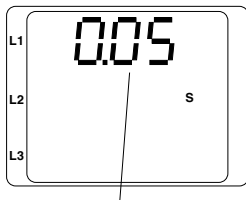

Minimum pulse width = 0.05s.

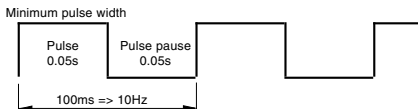

Diagr. Maximum pulse frequency at minimum pulse width of 0.05 seconds.

At minimum pulse width the maximum pulse frequency is 10Hz. If less pulses must be sent, the pulse pauses become longer. The preset pulse width of 0.05, for example, remains constantly.

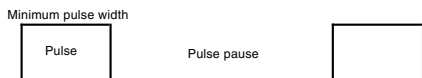

The outputs of UMG96 are equipped with semiconductor switches. If a pulse appears, the output transistor becomes conductive and a current can flow.

Programming of minimum pulse width

Go to minimum pulse width in programming mode using key 2.

Confirm selection with key 1.

The minimum pulse width flashes and can be changed with key 2.

Confirming with key 1, it stops flashing.

Using key 2 you can now change to next programming menu.

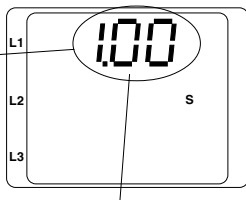

Minimum pulse width= 1.00 sec.

Averaging times (Bimetal function)

For the most current and power values, a mean value is built. You can program a common averaging time for the current measured values L1, L2, L3 and N, and one for power measured values, real power, apparent power and reactive power is programmable.

Presettings:

Averaging time of currents = 900 seconds

Averaging time power = 900 seconds

The following averaging times are selectable:

5, 10, 30, 60, 300, 480, 900 seconds

Method of taking the mean

The used exponential method reaches at least 95% of the measured value after the set averaging time.

$$ME_n = ME_{n-1} + (MA - ME_{n-1}) / N$$

ME_n = indicated mean value

MA = measured value

n = running number

N = number of measured values, whose mean values shall be built.

Programming of averaging times

Real power

In programming mode scroll to the averaging time of power with key 2. Confirm using key 1.

The averaging time flashes and can be changed by pressing key 2. Confirming with key 1, the averaging time stops flashing. Using key 2 you can now change to programming menu „Averaging time for current“.

Currents

In programming menu scroll to the averaging time for currents with key 2. Confirm selection with key 1.

The averaging time is flashing and can be changed using key 2. Confirming with key 1, the averaging time stops flashing. Using key 2 you can now change to programming menu „Rotation time“.

Symbol for mean value

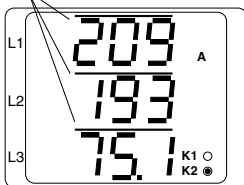

Diagr: Indication of the mean values for the currents in L1, L2 and L3.

Mean value=real power

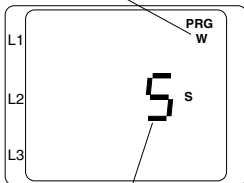

Averaging time= 5 seconds

Mean value= Current

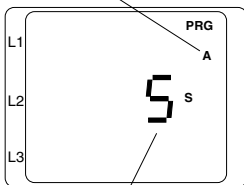

Averaging time = 5 seconds

Measured value rotation

Once in a second all measured values are calculated and can be shown on the display. For calling up the measured value indications, two methods are available:

- The automatic rotating indications of selected measured value indications, in the following called measured value rotation.
- The selection of measured value indications via the keys 1 and 2.

Both methods are available simultaneously. The rotation is programmed, when at least one measured value indication and one rotation time bigger than 0 seconds are programmed. If no key was pressed for about 60 seconds, an automatic change over to rotation, and all programmed measured values are indicated one after the other.

Setting range of rotation time: 0 .. 250 seconds

If 0 seconds have been programmed, no rotation is carried out. Measured value indications, which are not programmed in the *measured value selection*, can nevertheless be user for rotation.

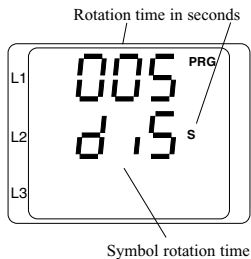

Programming of rotation time

In programming mode scroll to the menu measured value rotation, using key 2. Confirm selection with key 1.

The first cipher of the rotation time is flashing and can be changed by pressing key 2. Confirming with key 1, the next cipher is selected and flashes.

If no cipher is flashing anymore, you can change to programming menu „*Measured value selection*“ pressing key 2.

Measured value selection

In programming menu „measured value selection“, the measured value indications can be selected via the two keys for automatic rotation.

All listed measured values from table 1 can be called up via the keys 1 and 2, when the device is delivered. The selection for automatic rotation is programmed together with the value selection.

The condition of the choice is indicated by the output symbols. Those symbols have the following meaning:

Measured value selection

- K1 This indication can be reached via the two keys.
- K1 This indication cannot be reached via the two keys.

Measured value rotation

- K2 This indication is in automatic rotation.
- K2 This indication is not in automatic rotation.

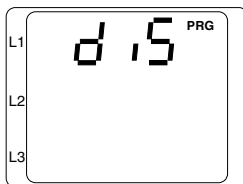

Programming of the measured value selection

With key 1 you change to measured value selection. The first indicated measured value indication is the current in the outer conductors. In the example, the measured value indication of currents is programmed for the measured value selection and for the automatic rotation. The selection of a measured value indication is carried out by a short pressing of the keys.

- Key 1 - Scroll to the right within the measured value indications.
- Key 2 - Scroll downwards within the measured value indications.

For the selected measured value indication, you can fix, if it is available for measured value selection or automatic rotation.

The selection is carried out by a long press of the buttons 1 or 2.

- Key 1 - Change over the measured value selection.
- Key 2 - Change over the automatic rotation.

If the programming is finished, you return to indication mode by pressing key 1 and 2 simultaneously.

Measured value indication of currents

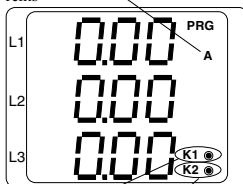

Measured value selection

Measured value selection

Delete minimum and maximum values

In programming mode, the menu „delete minimum and maximum values“ is marked with an arrow up- and downwards. All minimum and maximum values can only be deleted simultaneously.

One exception is the maximum value of current mean value. The maximum value of current mean value can be deleted directly in indication menu by pressing key 2 for a long time.

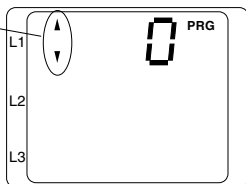

Delete

In programming mode go to *deletion of minimum and maximum values* by pressing key 2.

With key 1 you can change over between the indicated numbers 0 and 1. These numbers have the following meaning:

- 0 = Do not delete the minimum and maximum values.
- 1 = Delete all minimum and maximum values.

After selection, you leave the menu by pressing key 2 and the minimum and maximum values are deleted, if the number 1 was selected.

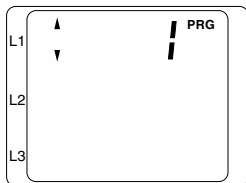

Delete energy

The real and reactive energy can only be deleted simultaneously via the keys.

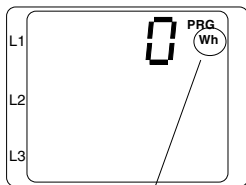

Symbol for the deletion of energy

Delete

In programming mode you scroll to the menu *delete energy* by using key 2.

Pressing key 1 you can change over between the numbers 0 and 1. These numbers have the following meaning:

- 0 = Do not delete real and reactive energy.
- 1 = Delete real and reactive energy.

After selection, you leave the menu by pressing key 2, and real and reactive energy are deleted, if the number 1 was selected.

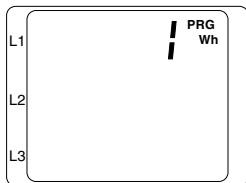

LCD contrast

The favoured view for the LCD display is from below. This favoured view can be adapted by the user. The contrast setting is possible in steps from 0 to 15.

0 = Very light

15 = Very dark

In order to achieve an optimum contrast over the whole temperature range, the inner temperature of the device is measured and the contrast setting is corrected automatically. This correction is not indicated in the display *contrast setting*.

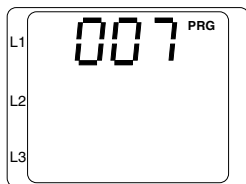

Programming of LCD contrast

In programming mode go to LCD contrast by pressing key 2. Confirm with key 1.

The first cipher of the contrast setting is flashing. Go to the right cipher with key 1.

Now you can change the cipher with key 2. You can move to programming menu „user password“ by pressing key 2 afterwards.

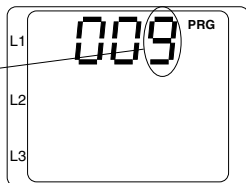

Software Release

The software for the UMG 96 is improved and expanded continuously. The software release is marked with a number. The software release cannot be changed by the user.

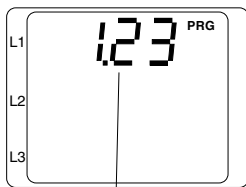

Example: Software Rel. 1.23

User password

With a three digit user password you can protect the device from unintentional changing of the programming. In delivery condition, the user password is "000".

If a changed user password is not known anymore, the user password can only be reset by the master password „758“.

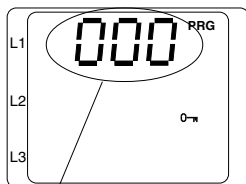

User password

Indicating range and accuracy

Quantity	Indicating range	Measuring range ¹⁾	Accuracy ⁵⁾
Meas. and supply voltage 196 .. 275V			
Voltage L-N	0 .. 34kV	196 .. 275V	+,-1,0% rng
Voltage L-L	0 .. 60kV	340 .. 476V	+,-2,0% rng
Current	0,00 .. 9,99kA	0,02 .. 5,00A	+,-1,0% rng
Current in N	0,00 .. 9,99kA	0,03 .. 15,00A	+,-3,0% rng
Real power consumption, sum	0,00W .. 99,9MW	3,2W .. 1,375kW	+,-1,5% rng
Real power, supply, sum	-0,00W .. -99,9MW	-3,2W .. -1,375kW	+,-1,5% rng
Apparent power, sum	0,00VA .. 99,9MVA	3,2VA .. 1,375kVA	+,-1,5% rng
Reactive power (Q ₀), sum	0,00var .. 99,9Mvar	3,2var..1,375kvar	+,-1,5% rng
Meas. and auxiliary voltage 98 .. 140V			
Voltage L-N	0 .. 34kV	98 .. 140V	+,-1,0% rng
Voltage L-L	0 .. 60kV	170 .. 242V	+,-2,0% rng
Current	0,00 .. 9,99kA	0,02 .. 5,00A	+,-1,0% rng
Current in N	0,00 .. 9,99kA	0,03 .. 15,00A	+,-3,0% rng
Real power, consumption, sum	0,00W .. 99,9MW	1,6W .. 700W	+,-1,5% rng
Real power, supply, sum	-0,00W .. -99,9MW	-1,6W .. -700W	+,-1,5% rng
Apparent power, sum	0,00VA .. 99,9MVA	1,6VA .. 700VA	+,-1,5% rng
Reactive power (Q ₀), sum	0,00var .. 99,9Mvar	1,6var .. 700var	+,-1,5% rng
Meas. and auxiliary voltage 49 .. 76V			
Voltage L-N	0 .. 34kV	49 .. 76V	+,-1,0% rng
Voltage L-L	0 .. 60kV	85 .. 132V	+,-2,0% rng
Current	0,00 .. 9,99kA	0,02 .. 5,00A	+,-1,0% rng
Current in N	0,00 .. 9,99kA	0,03 .. 15,00A	+,-3,0% rng
Real power, consumption, sum	0,00W .. 99,9MW	0,8W .. 380W	+,-1,5% rng
Real power, supply, sum	-0,00W .. -99,9MW	-0,8W .. -380W	+,-1,5% rng
Apparent power, sum	0,00VA .. 99,9MVA	0,8VA .. 380VA	+,-1,5% rng
Reactive power (Q ₀), sum	0,00var .. 99,9Mvar	0,8var .. 380var	+,-1,5% rng
cos(phi)	0,00i .. 1.00 .. 0,00k		2)
Frequency (voltage)	45,0 .. 65,0Hz		+,-1,5% rdg
Reactive energy, inductive			
v ⁴⁾ < 10	0..999 999 9,99kvarh		class 2 ³⁾
v ⁴⁾ < 100	0..999 999 99,9kvarh		class 2 ³⁾
v ⁴⁾ >= 100	0..999 999 999kvarh		class 2 ³⁾
Real energy, consumption			
v ⁴⁾ < 10	0..999 999 9,99kWh		class 2 ³⁾
v ⁴⁾ < 100	0..999 999 99,9kWh		class 2 ³⁾
v ⁴⁾ >= 100	0..999 999 999kWh		class 2 ³⁾
Energying hours counter	0..999 999 999h		+,-2minutes/day

¹⁾ Measuring range with scale factor = 1, (Current transformer = 5/5A, 1/1A)

²⁾ If the measured apparent power is in the range of 1% .. 100% of the measuring range, the cos(phi) is displayed with an accuracy of +/- 3%.

³⁾ Accuracy class according to DIN EN61036:2001-01, VDE0418part 7, IEC61036:1996 + A1:2000

⁴⁾ v = v⁴⁾ * vi, vi = Current transformer ratio. Example: 200/5A -> vi = 40

vu = Voltage transformer ratio. Example: 1000/100V -> vu = 10

⁵⁾ In the range of -10..18°C and 28..55°C an additional inaccuracy of +,-0,5% omv per K must be mentioned.

Configuration data

Description	Display	Setting range	Presettings
Current transformer, primary	CT	1A .. 10,0kA (../5A) 1A .. 2,0kA (../1A)	5A
Current transformer, secondary	CT	1A, 5A	5A
Voltage transformer, primary			
Type plate, 196 .. 275V	VT	100V .. 60,0kV	400V
Typeplate, 98 .. 140V	VT	100V .. 60,0kV	200V
Type plate, 49 .. 76V	VT	100V .. 60,0kV	100V
Current transformer secondary			
Type plate, 196 .. 275V	VT	400V (cannot be changed)	400V
Type plate, 98 .. 140V	VT	200V, 220V	200V
Type plate, 49 .. 76V	VT	100V, 110V	100V
Outputs (by choice)	Kx		
Pulse output		K1, K2	K1, K2
Measured values		Reactive and real energy	K1=Real., K2=React.
Pulse valency		0,00(W/var)h .. 99,9k(W/var)h	K1=1,00Wh, K2=1,00varh
Switching output		K1, K2	-
Measured value		All values except energy	-
Exceeding	▲	0,01 .. 20,0M	-
Underscoring	▼	0,01 .. 20,0M	-
Minimum pulse width		0.05...2.00 sec.	0.05 sec.
Averaging time current		5, 10, .. 900 sec.	900 sec.
Averaging time power		5, 10, .. 900 sec.	900 sec.
Rotation time		0 .. 255	0=no rotation
Measured value rotation		see table	No measured value rotation
Measured value selection		see table	All measured value indicat.
LCD contrast		0 .. 15	7
Software Release		x.xx	x.xx
User password	0-9	000 .. 999	„000“ = no password

These specifications presuppose a yearly calibration and a warm up time of 10 minutes.

Used abbreviations:

 rng = of measuring range

 rdg = of measured value

Technical data

Weight	: 250g
Calorific value	: 2,2MJ (610Wh)

Ambient conditions

Overvoltage class	: CATIII
Pollution degree	: 2
Ambient temperature	: -10°C .. +55°C
Storage temperature	: -20°C .. +70°C
Humidity	: 15% up to 95% without dew
Protection class	
Front	: IP40 according to IEC529
Front with seal (option)	: IP42 according to IEC529
Back side	: IP20 according to IEC529
Protection class	: II = without protective wire
Installation place	: any
Height	: 0 .. 2000m over NN
Resistance against interf. (Industr. areas)	: EN50082-2:1995; IEC1000-4-3, 10V/m : IEC1000-4-4, 2kV; IEC1000-4-2, 8kV
Interference radiation (residential areas)	: EN55011 10.1997
Safety guidelines	: EN61010-1 03.1994 + A2 05.1996; IEC1010-1

Measurement

Measurement and supply voltage	: see type plate
Measuring inputs	
Scanning frequency	: 1 Measurement/sec.
Rated pulse voltage	: 4kV
Signal frequency	: 45Hz .. 1000Hz
Current measurement	: max. 300VAC against earth
Power consumption	: about 0,2 VA
Rated current at ..5A (../1A)	: 5A (1A)
Min. energizing current	: 20mA
Current limit at ../1A	: 1,2A (sinus shape)
Current limit at ../5A	: 6A (sinus shape)
Overload	: 180A for 2 Sek.
Voltage measurement	: max. 300VAC against earth
Power consumption	
196 .. 275V (see type plate)	: max. 13,4VA / Phase
98 .. 140V (see type plate)	: max. 7,4VA / Phase
49 .. 76V (see type plate)	: max. 2,6VA / Phase
Fuse	: 2A..6A (medium time-lag type)
Frequency of fundamental	: 45Hz .. 65Hz

Outputs

Type	: NPN-Transistor
Switching frequency	: max. 10Hz (50ms pulse width)
Operating current	: max. 50 mA (not short-circuit-proof)
Permissible rest current	: < 1mA
Operating voltage	: 5.. 24VDC, max. 30VDC

Connectable cables

One wire, multiple-wire, fine wire	: 0,08 - 2,5mm ²
Pin contacts	: 1,5mm ²
Only one wire may be connected at one clamp!	

Back side

Cut out: $92^{+0,8} \times 92^{+0,8}$ mm

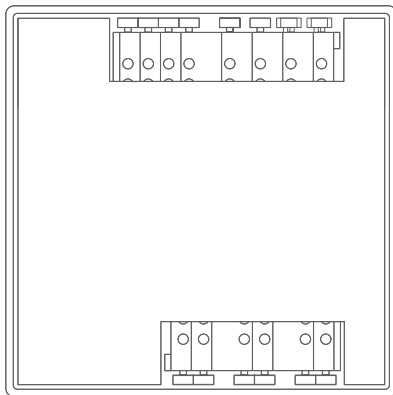

10210060b

Side view

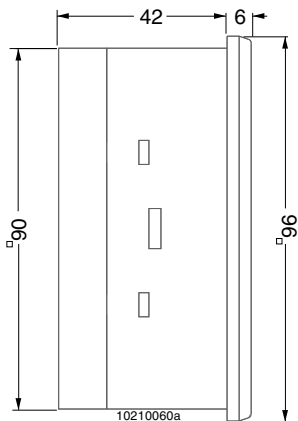

10210060a

Dimensions in mm

▲ = Peak value ▼ = Minimum value - = Supply

Brief instructions

Pressing the keys 1 and 2 for about 1 second, you reach programming mode.

If you are in programming mode, you return to indicating mode by pressing keys 1 and 2 for about 1 second.

Programming of current transformer

Select current transformer menu:

Press both keys simultaneously for about 1 second. The symbols for programming mode **PRG** and the current transformer **CT** appears. Confirm with key 1.

The first cipher of primary current is flashing.

Programming mode

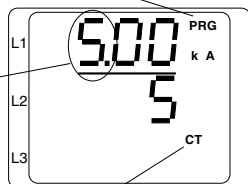

Current transformer symbol



Change primary current:

Change the flashing cipher with key 2.

Select the next cipher to be changed with key 1.

The selected cipher is flashing.

If the whole number is flashing, the decimal point can be moved.

Primary current

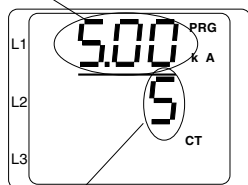

Secondary current



Change secondary current:

Only 1A or 5A can be set as secondary current.

Select secondary current with key 1.

Change cipher with key 2.

Leave programming mode:

Press both keys for about 1 second.

The current transformer setting is saved and you return to indication menu.

Call up measured values

The measured values indications can only be called up, when the symbol **PRG** for programming mode is not in the display.

With the keys 1 and 2 you can leave through the measured values.

When the device is delivered, all measured values you find in table 1 can be called up.

If you are in programming mode and do not press a key within 60 seconds, the device returns to indication mode automatically.

