

銅スリーブ入絶縁付丸形端子(ストレート形)

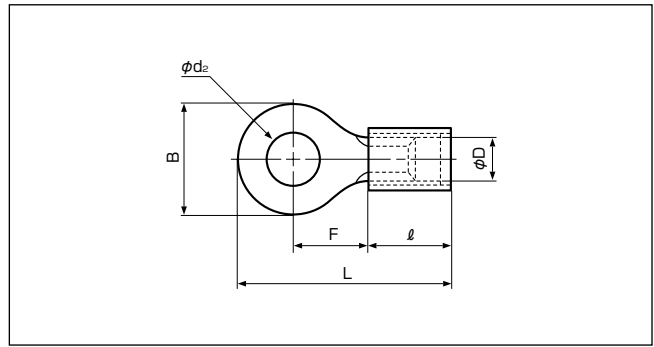









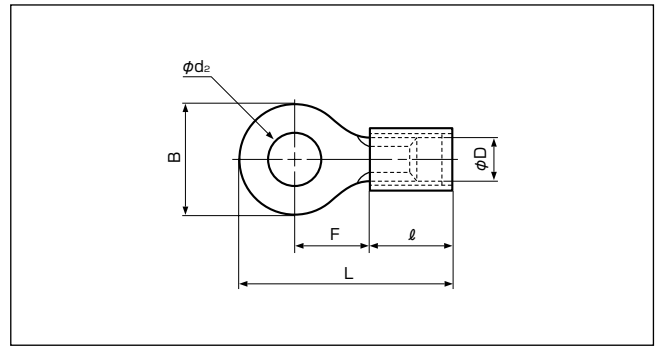























UL LISTED E42024 SF LR20812

形番	規格	寸法(mm)							色	適用電線範囲	適用圧着工具			1箱 入数 (個)	
		ϕd_2	B	L	F	l	ϕD	板厚		撚線(mm ²)	手動	空気圧式	油圧式		
VD0.5-2		2.2	5.2	16.4	5.8	8.0	2.2	0.5	黄	0.2~0.5 (0.2 (AWG#24) 0.3 (AWG#22) 0.5)	YNT-2622	YA-1,YAT-1A YA-2,YAT-2A YAD-1A YAD-2A	BCT-0514L	1,000	
VD0.5-3		3.2			7.7										
VD0.5-4		4.3			19.0										7.0
VD0.5-5		5.3			8.0										7.0
VD1.25-2		2.2	5.5	16.3	4.0	9.6	3.5	0.8	赤	0.25~1.65 (0.3 (AWG#22) 0.5 (AWG#20) 0.75 (AWG#18) 0.9 1.25 (AWG#16)	YNT-2216	YA-1 YA-2 YAT-1A YAT-2A YAD-1A YAD-2A YA-4 YAT-4A YAD-4A	BCT-0514L	1,000	
VD1.25-3		3.2			5.6										
VD1.25-MS3		3.2	18.0	5.6											
VD1.25-L3			8.0	20.6	7.0										
VD1.25-3.7		3.7	5.5	16.3	4.0										
VD1.25-M3			6.6	19.2	6.3										
VD1.25-M4		4.3	8.0	20.6	7.0										
VD1.25-4			5.3	8.0	20.6										7.0
VD1.25-5		6.4	11.6	26.5	11.1										
VD1.25-6		8.4													
VD1.25-8		8.4	13.6	30.3	13.9										
VD1.25-10		10.5													
VD2-S2		2.2	6.4	17.1	4.3	9.6	4.1	0.8	青	1.04~2.63 (1.25 (AWG#16) 2.0 (AWG#14)	YNT-1614	YA-1 YA-2 YAT-1A YAT-2A YAD-1A YAD-2A YA-4 YAT-4A YAD-4A	BCT-0514L	1,000	
VD2-MS3		3.2	5.5	18.0	5.6										
VD2-S3.3			6.4	17.1	4.3										
VD2-3		3.7	8.5	21.6	7.8										
VD2-S3			6.4	17.1	4.3										
VD2-P3.5		4.3	7.0	20.8	7.7										
VD2-M3			6.6	19.2	6.3										
VD2-M4		5.3	7.0	20.8	7.7										
VD2-P4			8.5	21.6	7.8										
VD2-4		5.3	9.5	7.3											
VD2-M5			6.4	12.0	26.6										11.0
VD2-5		8.4													
VD2-6		6.4	12.0	26.6	11.0										
VD2-8		8.4													
VD2-10		10.5	13.6	30.3	13.9										
VD2-12		13.0	19.0	35.8	16.7										
VD2-14		15.0	27.0	44.3	21.2										
VD2-16		17.0													
VD2-20		21.0													

注1) 本製品の中には多少納期を要するものもあります。

注2) VD0.5-()におけるUL登録の適用電線はAWG#26~AWG#22です。



形番	規格	寸法(mm)							色	適用電線範囲		適用圧着工具			1箱 入数 (個)
		φd2	B	L	F	ℓ	φD	板厚		燃線(mm ²)	手動	空気圧式	油圧式		
VD5.5-3	 	3.2	9.5	27.0	8.3	14.0	5.7	1.0	黄	2.63~6.64 〔3.5(AWG#12) 5.5(AWG#10)〕	YNT-1210S	YA-4 YAT-4A YAD-4A	BCT-0514L	500	
VD5.5-S3	 	3.7	7.2	23.5	5.9										
VD5.5-S4	 	4.3	9.5	27.0	8.3										
VD5.5-4	 														
VD5.5-5	 	5.3	13.2	29.6	9.0										
VD5.5-S5	 														
VD5.5-6	 	6.4	12.0	33.0	13.0										
VD5.5-S6	 														
VD5.5-S8	 	8.4	13.2	29.6	9.0										
VD5.5-8	 														
VD5.5-10	 	10.5	15.0	35.2	13.7										
VD5.5-12	 	13.0	19.2	39.6	16.0										
VD5.5-14	 	15.0	32.0	55.3	25.3										
VD5.5-16	 	17.0													
VD5.5-18	 	19.0													
VD5.5-20	 	21.0													
														250	

注) 本製品の中には多少納期を要するものもあります。



銅スリーブ入絶縁付丸形端子 (F形)

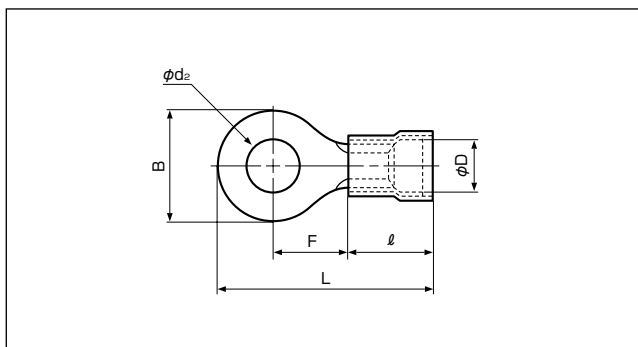









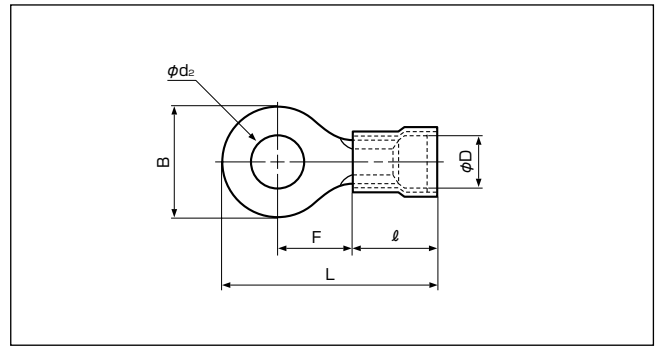























UL LISTED E42024 SF LR20812

形番	規格	寸法(mm)							色	適用電線範囲	適用圧着工具			1箱 入数 (個)												
		φd2	B	L	F	ℓ	φD	板厚		燃線(mm ²)	手動	空気圧式	油圧式													
FVDO.5-2	UL SF	2.2	5.2	16.7	5.8	8.3	2.5	0.5	黄	0.2~0.5 { 0.2 (AWG#24) 0.3 (AWG#22) 0.5 }	YNT-2622	YA-1,YAT-1A YA-2,YAT-2A YAD-1A YAD-2A	BCT-0514L	1,000												
FVDO.5-3		3.2			7.7																					
FVDO.5-4		4.3			19.3										7.0											
FVDO.5-5		5.3			7.0																					
FVD1.25-2	UL SF	2.2	5.5	16.3	4.0	9.6	4.0	0.8	赤	0.25~1.65 { 0.3 (AWG#22) 0.5 (AWG#20) 0.75 (AWG#18) 0.9 1.25 (AWG#16) }	YNT-2216	YA-1 YA-2 YAT-1A YAT-2A YAD-1A YAD-2A YA-4 YAT-4A YAD-4A	BCT-0514L	1,000												
FVD1.25-3		3.2			5.6																					
FVD1.25-MS3		3.2	18.0	5.6																						
FVD1.25-L3			8.0	7.0																						
FVD1.25-3.7		3.7	5.5	16.3	4.0																					
FVD1.25-M3			6.6	19.2	6.3																					
FVD1.25-M4		4.3	8.0	20.6	7.0																					
FVD1.25-4			8.0	20.6	7.0																					
FVD1.25-5		5.3	11.6	26.5	11.1																					
FVD1.25-6		6.4	13.6	30.3	13.9																					
FVD1.25-8		8.4																								
FVD1.25-10		10.5	3.2	17.1	4.3										9.6	4.7	0.8	青	1.04~2.63 { 1.25 (AWG#16) 2.0 (AWG#14) }	YNT-1614	YA-1 YA-2 YAT-1A YAT-2A YAD-1A YAD-2A YA-4 YAT-4A YAD-4A	BCT-0514L	1,000			
FVD2-S2		2.2																						6.4	17.1	4.3
FVD2-MS3		3.2																						5.5	18.0	5.6
FVD2-S3.3	6.4					17.1	4.3																			
FVD2-3	3.7	8.5				21.6	7.8																			
FVD2-S3		6.4				17.1	4.3																			
FVD2-P3.5	4.3	7.0				20.8	7.7																			
FVD2-M3		6.6				19.2	6.3																			
FVD2-M4	5.3	7.0				20.8	7.7																			
FVD2-P4		8.5				21.6	7.8																			
FVD2-4	5.3	9.5				7.3																				
FVD2-M5		6.4				12.0	26.6	11.0																		
FVD2-5	6.4	13.6				30.3	13.9																			
FVD2-6	8.4																									
FVD2-8	8.4	19.0	35.8	16.7																						
FVD2-10	10.5																									
FVD2-12	13.0	27.0	44.3	21.2																						
FVD2-14	15.0																									
FVD2-16	17.0	21.0																								
FVD2-20	21.0																									

注1) 本製品の中には多少納期を要するものもあります。

注2) FVDO.5-()におけるUL登録の適用電線はAWG#26~AWG#22です。



形番	規格	寸法(mm)							色	適用電線範囲			1箱 入数 (個)	
		φd2	B	L	F	ℓ	φD	板厚		燃線(mm ²)	手動	空気圧式		油圧式
FVD5.5-3	 	3.2	9.5	27.0	8.3	14.0	6.5	1.0	黄	2.63~6.64 〔3.5(AWG#12) 5.5(AWG#10)〕	YNT-1210S	YA-4 YAT-4A YAD-4A	BCT-0514L	500
FVD5.5-S3	 	3.7	7.2	23.5	5.9									
FVD5.5-S4	 	4.3	9.5	27.0	8.3									
FVD5.5-4	 													
FVD5.5-5	 	5.3	13.2	29.6	9.0									
FVD5.5-S5	 													
FVD5.5-6	 	6.4	12.0	33.0	13.0									
FVD5.5-S6	 													
FVD5.5-S8	 	8.4	13.2	29.6	9.0									
FVD5.5-8	 													
FVD5.5-10	 	10.5	15.0	35.2	13.7									
FVD5.5-12	 	13.0	19.2	39.6	16.0									
FVD5.5-14	 	15.0	32.0	55.3	25.3									
FVD5.5-16	 	17.0												
FVD5.5-18	 	19.0												
FVD5.5-20	 	21.0												
														250

注) 本製品の中には多少納期を要するものもあります。