

CLD-1020-X

Dual Directional Coupler

COBHAM

Data Sheet Revision Date: 12/18/2015

The most important thing we build is trust

DESCRIPTION:

Cobham Signal & Control Solutions' forward and reverse dual directional stripline couplers, are available in 6dB, 10dB, 20dB, and 30dB coupling values. These units feature high directivity and low VSWR and are conservatively rated to ensure the most reliable service and performance. The directional couplers on this page are unequalled in terms of size and performance. The volume of these couplers makes them ideally suited for applications involving high density packaging.

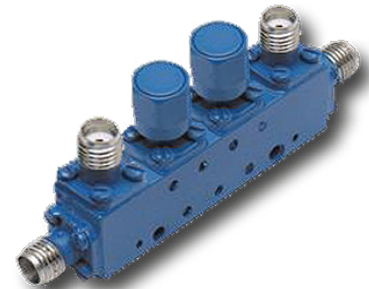

SPECIFICATIONS:

Parameter	Specification	Unit of Measure
Frequency Range (Min)	1.0 – 2.0	GHz
Directivity (Min)	23	dB
Primary / Secondary VSWR (Max)	1.15	Ratio
Insertion Loss Above Coupling Loss (Max)	0.40	dB
"L"	7.6 (193.0)	Inches (mm)
"H"	0.5 (12.7)	Inches (mm)

OUTLINE DRAWING:

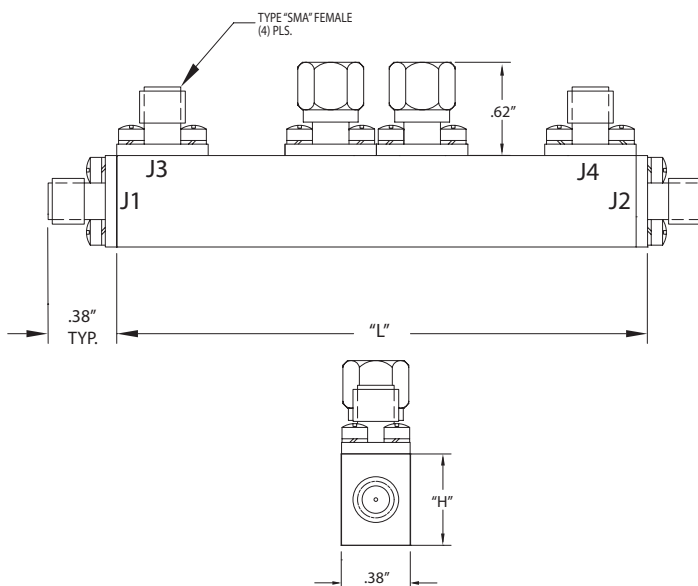

OUTLINE CASE STYLE CLD

FEATURES:

- Rugged 4 hole connector construction insures superiority
- 50 Ohm termination is supplied on each unit delivered. Power rating is 1 Watt at 25 °C
- Coupling includes frequency flatness & coupling measurement in reference to the input port. Coupling is standard on these units

NOTES:

Please Contact the Factory for Custom Specifications

MECHANICAL SPECIFICATIONS:

Case Style: CLD Outline
Connectors: SMA Female per MIL-C-39012
Weight: 19g max

SCREENING:

Internal Visual per MIL-STD-883, Method 2017
Temperature Cycle: -65 °C to +100 °C, 10 cycles
Hermetically-sealed units are fine and gross leak checked per MIL-STD-883, Method 1014.
Optional High-Rel screening available upon request. Contact the factory to discuss your screening requirements.

ENVIRONMENTAL SPECIFICATIONS*:

MIL-E-5400, MIL-STD-202, MIL-E-16400
Operating Temp: -55°C to +85°C
Storage Temp: -65°C to +150°C
Humidity: MIL-STD-202F, M103, Cond B
Shock: MIL-STD-202F, M213, Cond B
Altitude: MIL-STD-202F, M105, Cond B
Vibration: MIL-STD-202F, M204, Cond B
Thermal Shock: MIL-STD-202F, M107, Cond A

* Compliant by design, verification optional

ISO 9001:2008 and AS9100 certified

Aeroflex Control Components, DBA Cobham Signal & Control Solutions (CSCS) reserves the right to make changes to any products and services herein at any time without notice. Consult CSCS or an authorized sales representative to verify that the information in this data sheet is current before using this product. CSCS does not assume any responsibility or liability arising out of the application or use of any product or service described herein, except as expressly agreed to in writing by CSCS; nor does the purchase, lease, or use of a product or service from CSCS convey a license under any patent rights, copyrights, trademark rights, or any other of the intellectual rights of CSCS or of third parties.

Copyright 2015, Cobham Signal & Control Solutions. All rights reserved.

For further information please contact:

Cobham Signal & Control Solutions
40 Industrial Way East
Eatontown , NJ 07724 [USA]
Phone: (732) 460-0212
Fax: (732) 460-0214
ASCS-sales@aeroflex.com