

INTEGRITY SERIES 32 AIR-COOLED PANEL-MOUNTED AIR CONDITIONERS

Products in red are legacy products. Legacy products are no longer in normal production. Consult factory for availability.
Recommended replacement: See *Guardian/GuardianX* or *SlimKool* Series.



Model	BTU/H Capacity	95/95 Rating BTU/H	Ambient Temp. °F Max./Min.	Volts	Hz	* Running Amps	Approx. Weight (lbs.)
KNA4C4P32L	4000	2650	125/0	115/100	60/50	13.0/12.0	105
K2NA4C4P32L	4000	2650	120/0	230/200	60/50	6.0	105

* Rating shown is for operation at maximum ambient temperature.

STANDARD FEATURES

- CFC-Free Refrigerant
- Filters (2)
- Head Pressure Control Switch
- Internal Corrosion Protection
- Low Ambient Kit
- Low Temperature Control Thermostat
- NEMA4/4X Rating Maintained (UL50)
- Stainless Steel Shell
- UL/CUL Listed

ACCESSORIES AND OPTIONS

- Compressor Short Cycle Protector
- Filter Re-coating Adhesive
- Lead-Lag Controller
- Lifting Eyes
- Remote Thermostat Relay
- Replacement Filters
- Special materials or finishes
- Temperature Alarm

Find additional information on this model at kooltronic.com, or use the Technical Documents QR code below.

Technical Documents



NEMA TYPE 4/4X MAINTAINED



PERFORMANCE

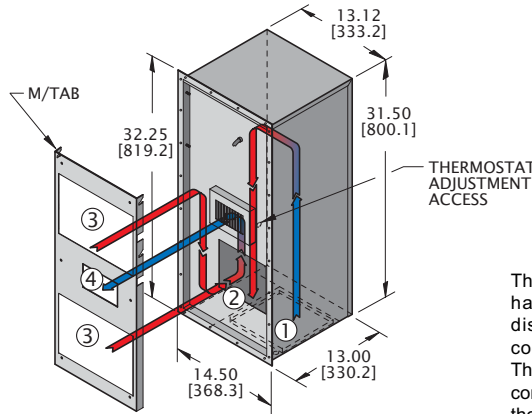
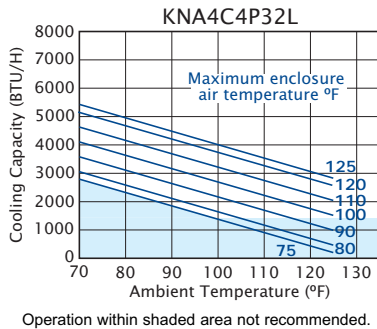

- ① FILTERED CONDENSER AIR INLET (Ambient Air In)
- ② CONDENSER OUTLET (Warm Ambient Air Out)
- ③ WARM AIR RETURN FROM ENCLOSURE
- ④ COOL AIR OUTLET TO ENCLOSURE

The Series 32 NEMA 4/4X Air Conditioner group has the added feature of a center cool air discharge ④ which can be adjusted to direct the cool air either upward or downward. The hot cabinet air ③ can be returned to the air conditioner by either a top or bottom return port in the M/TAB, which determines the cutout location required in the enclosure.

MOUNTING PLAN UNIT

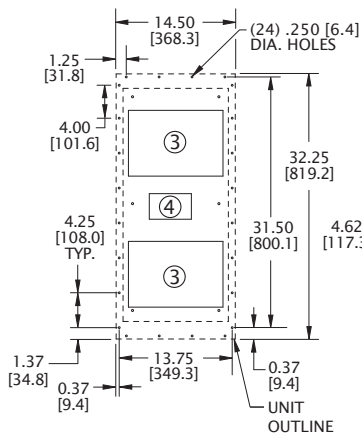

MOUNTING PLAN M/TAB & CUTOUTS

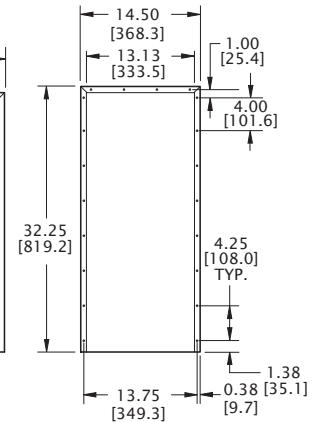
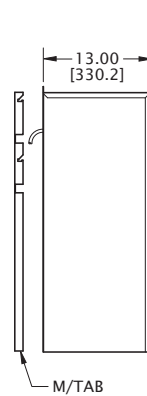
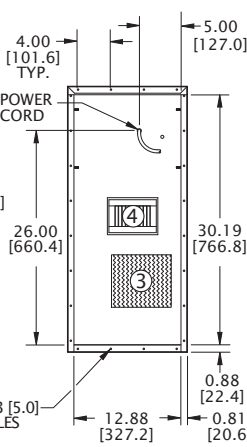
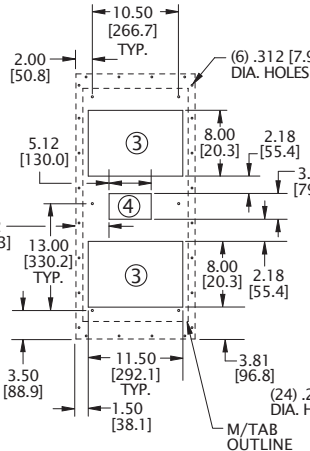

UNIT MUST BE 12" [300mm] MINIMUM ABOVE FLOOR FOR FILTER ACCESS



Many popular units are available as 3D solid models for customer system integration. Please contact Kooltronic for details.

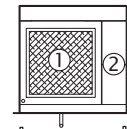

Dimensions, inches [mm], are for reference only and subject to change.



INTEGRITY SERIES 32 AIR-COOLED PANEL-MOUNTED AIR CONDITIONERS

DESCRIPTION

Designed specifically for NEMA 4 and 4X Enclosure applications that require washdown or are subject to outdoor storm conditions, KOOLTRONIC *Integrity NEMA 4/4X Air Conditioners* protect the ratings of NEMA 4 or 4X Enclosures.

These exclusive **patented** UL/CUL Listed Panel-Mounted Air Conditioners provide superior closed-loop cooling and also protect against the hazards specified for both Indoor and Outdoor NEMA 4 and 4X Enclosures. Tested and rated by universally recognized Underwriters Laboratories, these uniquely-designed **304-2B Stainless Steel** Air Conditioners prevent unwanted environmental penetration of NEMA 4 and 4X Enclosures as they provide a clean, cool internal environment.

These units can be mounted interchangeably with same series KOOLTRONIC *Integrity NEMA 4/4X Heat Exchangers* for maximum flexibility in the event that cooling requirements change.

For extreme ambient temperatures and/or severely contaminated environments, the use of *Water-Cooled Air Conditioners* is recommended.

KOOLTRONIC also designs and manufactures a variety of Air Conditioners to meet unique specifications. We invite your inquiries about our modification and custom-design capabilities.

STANDARD FEATURES

BALL-BEARING MOTORS: All blower motors are UL/CSA Recognized and include automatic-reset thermal overload protection and double-sealed or double-shielded precision ball bearings. Special permanent lubricants perform over a broad temperature range: -20°F [-28.9°C] to 250°F [121.1°C].

BLOWERS: All centrifugal blowers are Kooltronic-designed and built, to provide optimum airflow and pressure for each Air Conditioner design.

CLOSED-LOOP COOLING: The enclosure interior airflow system is isolated from the ambient airflow system. Ambient air can not invade the cool, dehumidified sensitive component compartment.

CONDENSATE REMOVAL: Condensate drain fitting and hose are included.

FILTERS: Multi-layer grid of sturdy, corrugated aluminum in an aluminum frame. May be reused after washing off accumulations and spraying with A-16 Recoating Adhesive.

GASKETING: All units are fully gasketed for tight, leakproof installation, in compliance with the NEMA 4/4X Enclosure Rating.

INSULATION: All cold components, lines and the evaporator compartment are insulated with high-performance insulation for maximum efficiency.

INTERNAL CORROSION PROTECTION: For corrosive or other hostile environments, special coating material is applied to copper lines, coils and other parts subject to damage.

LOW TEMPERATURE CONTROL: Thermostatic Low Temperature Control prevents over-cooling and provides energy-efficient operation.

POWER: Available in 115 VAC, 60 Hz or 50/60 switchable and 230 VAC, 50 Hz or 60 Hz.

POWER CORD: All models have six foot [1.8m] 3-wire power cord.

QUALITY ASSURANCE: Refrigeration system components are kept sealed until charged with refrigerant; all brazed joints are thoroughly leak-tested; each unit is functionally tested before shipment.

REFRIGERANT: CFC-free R134a Refrigerant is used in all *Integrity NEMA 4/4X Series* Air Conditioners.

RUGGED CONSTRUCTION: Precision-engineered heavy gauge steel construction of all cabinets and blowers insures Air Conditioners will stand up under tough applications.

UL/CUL LISTED: All *Integrity NEMA 4/4X P32 Series* are **UL/CUL Listed**.

ACCESSORIES AND OPTIONS**

FACTORY-INSTALLED OPTIONS:

COMPRESSOR SHORT CYCLE PROTECTOR: Protects the compressor from possible damage due to harmful short cycling.

Append letter "Y" to Part No.

LIFTING EYES: Heavy-gauge steel lifting eyes, attached to the side panels, assist in positioning units.

Append letter "K" to Part No.

SPECIAL MATERIALS OR FINISHES**

SPECIAL MOTORS, LINE CORDS OR CONNECTORS**

TEMPERATURE ALARM: A thermostat is mounted inside the cabinet and attached to a sensor in the warm air return. When the air temperature increases to the set point, a signal is sent to a terminal block. User-installed wiring from the terminal block to local and/or remote warning devices (*light, bell, siren, etc.*) can be for normally open or closed operation.

Append letter "B" to Part No.

****Contact KOOLTRONIC for information.**



INTEGRITY SERIES 32 AIR-COOLED PANEL-MOUNTED AIR CONDITIONERS

CUSTOMER-INSTALLED OPTIONS

FILTER RECOATING ADHESIVE: This compound is a superior product for recoating filters after washing. The adhesives penetrate dirt layers to keep the filter surface tacky for longer effective performance between washings. Part No. A-16.

REPLACEMENT FILTERS: All KOOLTRONIC filters consist of a multi-layer grid of sturdy corrugated aluminum, securely held in a one-piece aluminum frame. Filters are required wherever air is drawn into an electronics enclosure or related cooling equipment to keep internal parts as clean as possible.

A non-drying adhesive coating traps a high percentage of particulate matter. These filters are reuseable, they may be washed and recoated with the appropriate filter recoating adhesive. Replacements are available for those which become damaged or otherwise non-serviceable.

(1) Part No. 650F (8.38" x 8.38" x 0.50" [213mm x 213mm x 13mm]) and

(1) Part No. 8751F (16.63" x 8.38" x 0.50" [422mm x 213mm x 13mm])

****Contact KOOLTRONIC for information.**

HOW TO ORDER

Specify model number. NOTE: Accessories and Options may affect model number, contact KOOLTRONIC for information.

For assistance in model selection, refer to the Air Conditioner Sizing and Selection Guide, contact KOOLTRONIC, or use one of our design aid software programs, available FREE.

**CALL 1-800-321-KOOL (5665)
or FAX 609-466-1114**

**POPULAR MODELS ARE
STOCKED AND READY TO SHIP**