



# Vandal Resistant Switch $\Phi$ 19mm(Short)

**Anti-Vandal IK09/ Sealed IP65**

**Normal Open/ Normal Closed**

**Domed/ Flat/ High Flat**

**Stainless Steel/ Brass**

**1,000,000 Cycles Momentary**

### Order Code

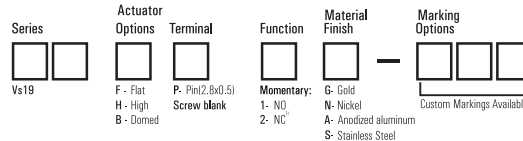

### Function

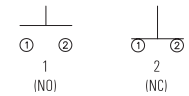

1): Screw terminal available.



### Technical Data

Type	Vs19-F	Vs19-B	Vs19-H
Actuator Options	Flat	Domed	High Flat
Terminal	Screw/ Pin (2.8X0.5)		
Max.Switch Rating	2A 48VDC		
Contact Resistance	≤50mΩ		
Insulation Resistance	≥1000mΩ		
Dielectric Strength	2000VAC		
Operation Temp	-20 °C ~ +55 °C		
Mechanical Life	1,000,000 Cycles		
Electrical Life	200,000 Cycles		
Contact Material	Silver Alloy		
Torque	5 ~ 14Nm		
Operation Pressure	approx. 5N		
Protection	IP65/ IK09		
Material			
Actuator	Stainless steel/ Gold or Nickel plated brass/ Anodized aluminum		
Body	Stainless steel/ Gold or Nickel plated brass/ Anodized aluminum		
Base	PBT		

### Suggested Panel Cutout

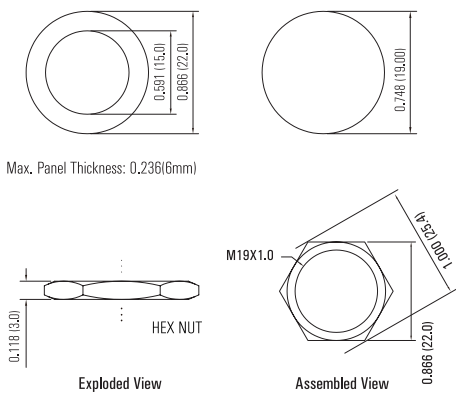

### Dimension

#### Screw

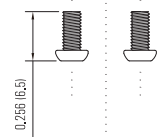
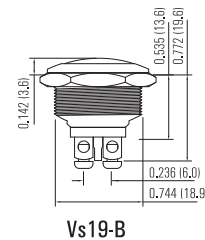
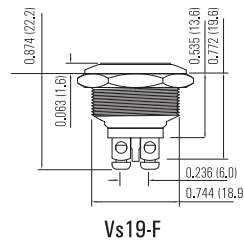
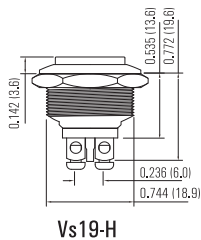

#### Solder

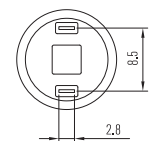
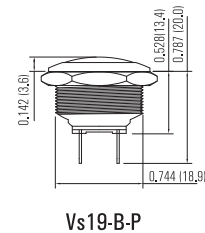
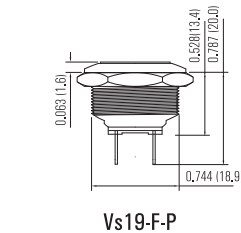
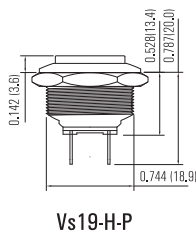

© Copyright Yueqing LANGIR Electric Co.,Ltd. All Right Reserved.

Disclaimer: The appearance of the products listed on this catalogue, color, parameters are for reference only, issued a kind of LANGIR Electric Company shall prevail.

LANGIR Electric Company reserves the right to modify or cancel the relevant parameters of this catalogue does not advance notice. If in doubt, please contact your sales representative.



**YUEQING LANGIR ELECTRIC CO., LTD**

ADD: 4th, No. 188 Liuqing North Rd, Lishi, Yueqing, Zhejiang China 325604

FAX: 86 (577) 62737671

TEL: 86 (577) 62737672 62737670

E-mail: [sunshine@sunshinele.com](mailto:sunshine@sunshinele.com)

Http://[www.anti-vandal-switch.com](http://www.anti-vandal-switch.com) [www.piezo-switch.com](http://www.piezo-switch.com)