

## RF Power MOSFET Transistor 40 W, 2 - 175 MHz, 28 V

Rev. V1

### Features

- N-Channel enhancement mode device
- DMOS structure
- Lower capacitances for broadband operation
- High saturated output power
- Lower noise figure than bipolar devices
- RoHS Compliant

### ABSOLUTE MAXIMUM RATINGS AT 25° C

Parameter	Symbol	Rating	Units
Drain-Source Voltage	$V_{DS}$	65	V
Gate-Source Voltage	$V_{GS}$	20	V
Drain-Source Current	$I_{DS}$	8	A
Power Dissipation	$P_D$	125	W
Junction Temperature	$T_J$	200	°C
Storage Temperature	$T_{STG}$	-55 to +150	°C
Thermal Resistance	$\theta_{JC}$	1.4	°C/W

### TYPICAL DEVICE IMPEDANCE

F (MHz)	$Z_{IN}$ ( $\Omega$ )	$Z_{LOAD}$ ( $\Omega$ )
30	12.0 - j6.8	6.5 - j1.5
50	10.0 - j6.5	6.0 - j1.8
100	6.0 - j5.5	5.5 - j1.8
200	1.1 - j3.0	3.5 - j1.8

$V_{DD} = 28V, I_{DQ} = 200mA, P_{OUT} = 40 W$

$Z_{IN}$  is the series equivalent input impedance of the device from gate to source.

$Z_{LOAD}$  is the optimum series equivalent load impedance as measured from drain to ground.

### Package Outline

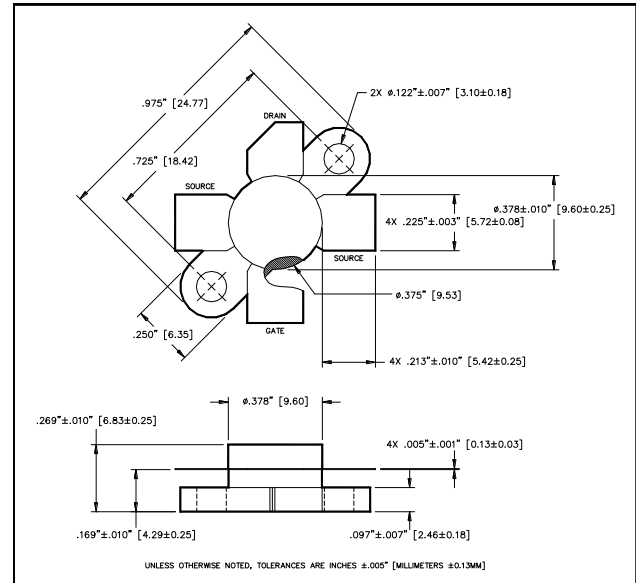

LETTER DIM	MILLIMETERS		INCHES	
	MIN	MAX	MIN	MAX
A	24.64	24.89	.970	.980
B	18.29	18.54	.720	.730
C	20.07	20.83	.790	.820
D	9.47	9.73	.373	.383
E	6.22	6.48	.245	.255
F	5.64	5.79	.222	.228
G	2.92	3.30	.115	.130
H	2.29	2.67	.090	.105
J	4.04	4.55	.159	.179
K	6.58	7.39	.259	.291
L	.10	.15	.004	.006

### ELECTRICAL CHARACTERISTICS AT 25°C

Parameter	Symbol	Min	Max	Units	Test Conditions
Drain-Source Breakdown Voltage	$BV_{DSS}$	65	-	V	$V_{GS} = 0.0 V, I_{DS} = 10.0 mA$
Drain-Source Leakage Current	$I_{DSS}$	-	2.0	mA	$V_{GS} = 28.0 V, V_{DS} = 0.0 V$
Gate-Source Leakage Current	$I_{GSS}$	-	2.0	$\mu A$	$V_{GS} = 20.0 V, V_{DS} = 0.0 V$
Gate Threshold Voltage	$V_{GS(TH)}$	2.0	6.0	V	$V_{DS} = 10.0 V, I_{DS} = 200.0 mA$
Forward Transconductance	$G_M$	1	-	S	$V_{DS} = 10.0 V, I_{DS} = 2000.0 mA, \Delta V_{GS} = 1.0V, 80 \mu s$ Pulse
Input Capacitance	$C_{ISS}$	-	90	pF	$V_{DS} = 28.0 V, F = 1.0 MHz$
Output Capacitance	$C_{OSS}$	-	80	pF	$V_{DS} = 28.0 V, F = 1.0 MHz$
Reverse Capacitance	$C_{RSS}$	-	16	pF	$V_{DS} = 28.0 V, F = 1.0 MHz$
Power Gain	$G_P$	13	-	dB	$V_{DD} = 28.0 V, I_{DQ} = 200 mA, P_{OUT} = 40 W F = 175 MHz$
Drain Efficiency	$\eta_D$	60	-	%	$V_{DD} = 28.0 V, I_{DQ} = 200 mA, P_{OUT} = 40 W F = 175 MHz$
Load Mismatch Tolerance	VSWR-T	-	30:1	-	$V_{DD} = 28.0 V, I_{DQ} = 200 mA, P_{OUT} = 40 W F = 175 MHz$

M/A-COM Technology Solutions Inc. (MACOM) and its affiliates reserve the right to make changes to the product(s) or information contained herein without notice. Visit [www.macom.com](http://www.macom.com) for additional data sheets and product information.

**Typical Broadband Performance Curves**

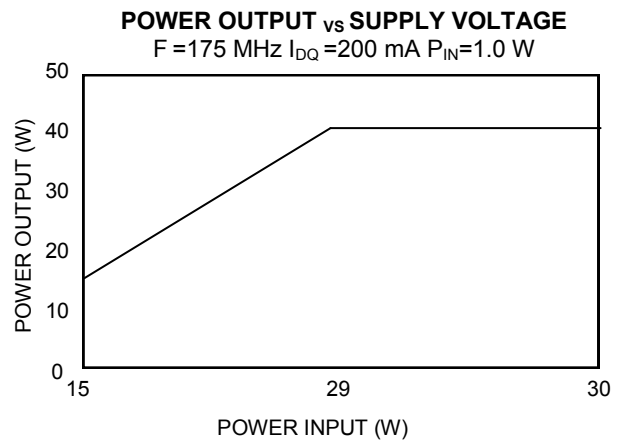
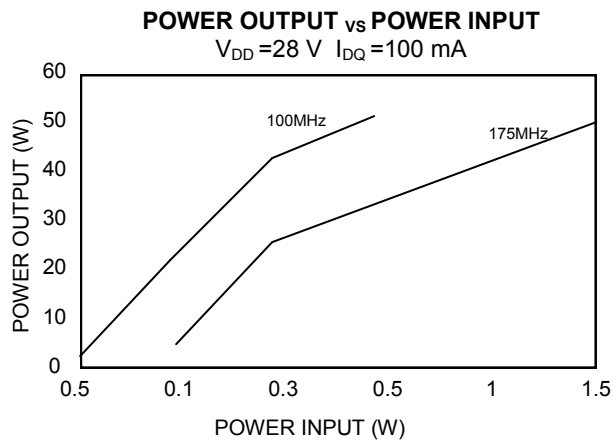
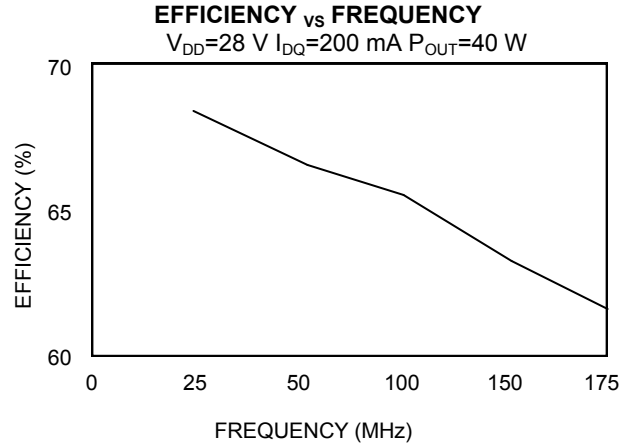
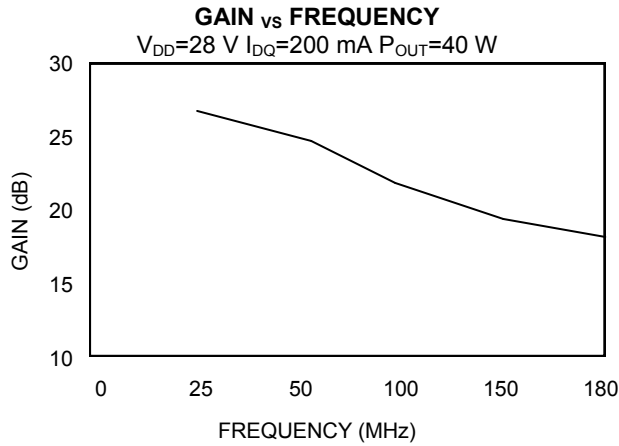

## RF Power MOSFET Transistor 40 W, 2 - 175 MHz, 28 V

Rev. V1

### TEST FIXTURE SCHEMATIC

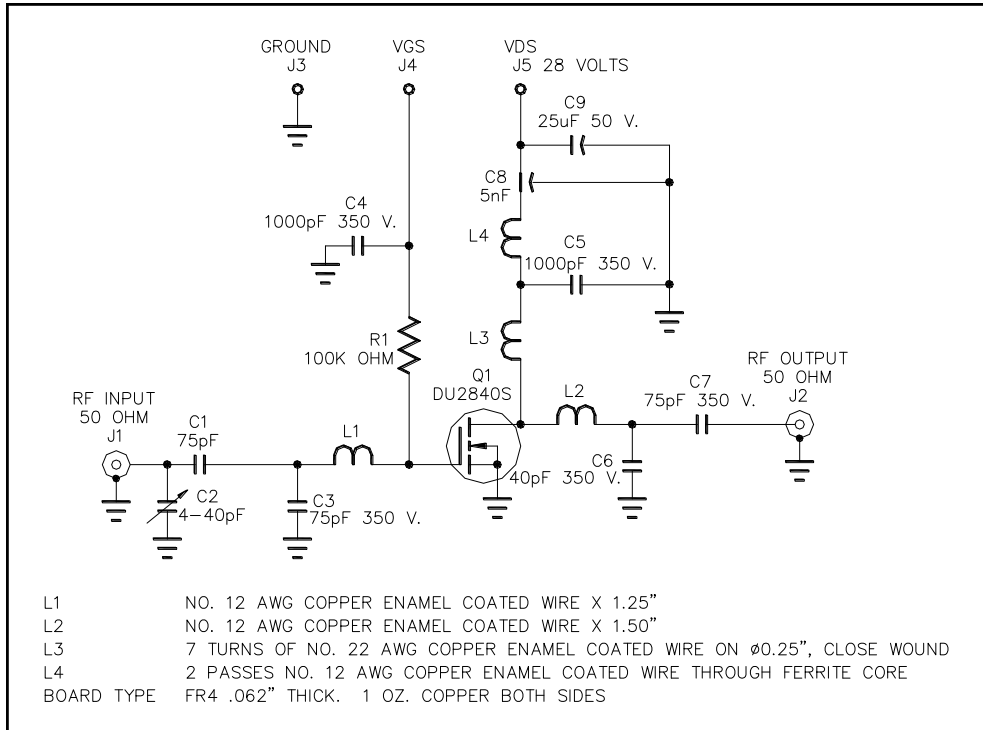

### TEST FIXTURE ASSEMBLY

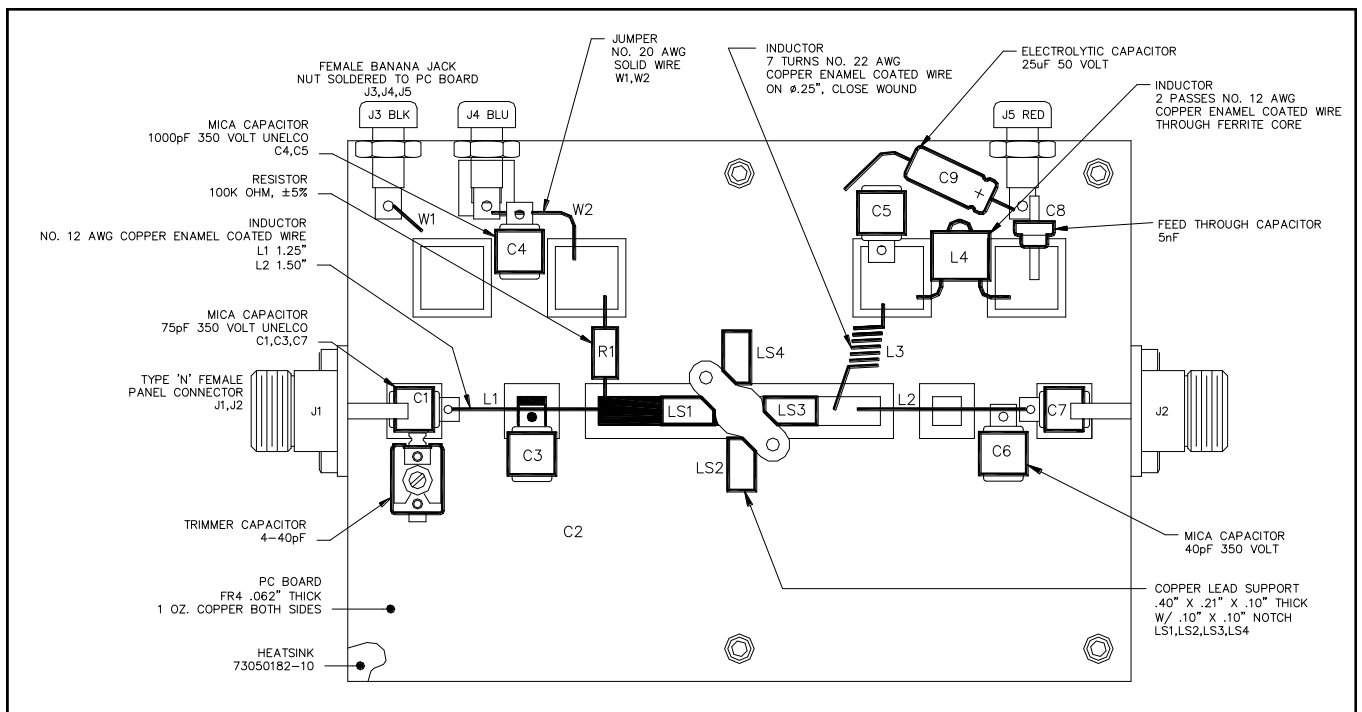

M/A-COM Technology Solutions Inc. All rights reserved.

Information in this document is provided in connection with M/A-COM Technology Solutions Inc ("MACOM") products. These materials are provided by MACOM as a service to its customers and may be used for informational purposes only. Except as provided in MACOM's Terms and Conditions of Sale for such products or in any separate agreement related to this document, MACOM assumes no liability whatsoever. MACOM assumes no responsibility for errors or omissions in these materials. MACOM may make changes to specifications and product descriptions at any time, without notice. MACOM makes no commitment to update the information and shall have no responsibility whatsoever for conflicts or incompatibilities arising from future changes to its specifications and product descriptions. No license, express or implied, by estoppel or otherwise, to any intellectual property rights is granted by this document.

THESE MATERIALS ARE PROVIDED "AS IS" WITHOUT WARRANTY OF ANY KIND, EITHER EXPRESS OR IMPLIED, RELATING TO SALE AND/OR USE OF MACOM PRODUCTS INCLUDING LIABILITY OR WARRANTIES RELATING TO FITNESS FOR A PARTICULAR PURPOSE, CONSEQUENTIAL OR INCIDENTAL DAMAGES, MERCHANTABILITY, OR INFRINGEMENT OF ANY PATENT, COPYRIGHT OR OTHER INTELLECTUAL PROPERTY RIGHT. MACOM FURTHER DOES NOT WARRANT THE ACCURACY OR COMPLETENESS OF THE INFORMATION, TEXT, GRAPHICS OR OTHER ITEMS CONTAINED WITHIN THESE MATERIALS. MACOM SHALL NOT BE LIABLE FOR ANY SPECIAL, INDIRECT, INCIDENTAL, OR CONSEQUENTIAL DAMAGES, INCLUDING WITHOUT LIMITATION, LOST REVENUES OR LOST PROFITS, WHICH MAY RESULT FROM THE USE OF THESE MATERIALS.

MACOM products are not intended for use in medical, lifesaving or life sustaining applications. MACOM customers using or selling MACOM products for use in such applications do so at their own risk and agree to fully indemnify MACOM for any damages resulting from such improper use or sale.