

Features

- Single Stage, Differential Amplifier
- 5 V, 290 mA Operation
- 19 dB Flat Gain
- Low Noise
- Low Distortion Performance
- ESD Class 1B for HBM
- Lead-Free SOIC-8EP Plastic Package
- Halogen-Free “Green” Mold Compound
- RoHS* Compliant

Description

The MAAM-011163 is high gain, high linearity and low noise differential RF amplifier assembled in a SOIC-8EP plastic package. This amplifier provides 19 dB of flat gain with very low noise figure. The differential push-pull topology provides superior 2nd order intermodulation performance.

The MAAM-011163 provides high gain, low noise and low distortion making it ideally suited for 75 Ω infrastructure applications.

The MAAM-011163 is fabricated using GaAs pHEMT technology.

Ordering Information^{1,2}

Part Number	Package
MAAM-011163	Bulk Packaging
MAAM-011163-TR1000	1000 Part Reel
MAAM-011163-TR3000	3000 Part Reel
MAAM-01163-001SMB	Sample Board, 45 - 1218 MHz
MAAM-01163-002SMB	Sample Board, 5 - 300 MHz

1. Reference Application Note M513 for reel size information.
2. All sample boards include 5 loose parts.

Functional Schematic

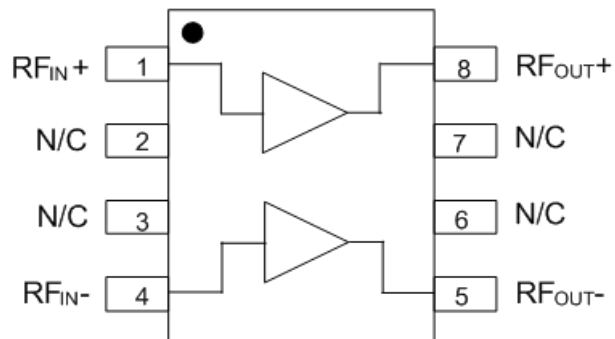

Pin Configuration

Pin No.	Pin Name	Function
1	RF _{IN+}	RF Input +
2	N/C	No Connection
3	N/C	No Connection
4	RF _{IN-}	RF Input -
5	RF _{OUT-}	RF Output - / V _{DD}
6	N/C	No Connection
7	N/C	No Connection
8	RF _{OUT+}	RF Output + / V _{DD}
9	Pad ³	RF and DC Ground

3. The exposed pad centered on package bottom must be connected to RF and DC ground.

* Restrictions on Hazardous Substances, European Union Directive 2011/65/EU.

75 Ω , Differential RF Amplifier 5 - 1218 MHz

Rev. V2

Electrical Specifications: $T_A = 25^\circ\text{C}$, $V_{DD} = 5\text{ V}$, $Z_0 = 75\ \Omega$

Performance specified with input/output balun MABA-009210-CT1760.

Parameter	Test Conditions	Units	Min.	Typ.	Max.
Gain	1218 MHz	dB	18.0	19.0	21.5
Tilt	45 - 1218 MHz	dB	—	0	—
Reverse Isolation	45 - 1218 MHz	dB	—	22	—
Input Return Loss	45 - 1218 MHz	dB	—	20	—
Output Return Loss	45 - 1218 MHz	dB	—	20	—
Noise Figure	45 MHz 1218 MHz	dB	—	1.4 2.4	—
Output IP2	45 - 1218 MHz, tone spacing 6 MHz P_{OUT} per tone = +13 dBm	dBm	—	62	—
Output IP3	45 - 1218 MHz, tone spacing 6 MHz P_{OUT} per tone = +13 dBm	dBm	—	42	—
P1dB	45 - 1218 MHz	dBm	—	25	—
Composite Triple Beat, CTB	79 channels, 0 dB Tilt, 39 dBmV per channel output, QAM to 1000 MHz	dBc	—	-72	—
Composite Second Order, CSO	79 channels, 0 dB Tilt, 39 dBmV per channel output, QAM to 1000 MHz	dBc	—	-75	—
I_{DD}	$V_{DD} = 5\text{ V}$	mA	—	290	345

Absolute Maximum Ratings^{4,5,6}

Parameter	Absolute Maximum
Max Input Power	10 dBm
Operating Voltage	8 V
Operating Temperature	-40°C to +85°C
Storage Temperature	-65°C to +150°C
Junction Temperature ⁷	150°C

- Exceeding any one or combination of these limits may cause permanent damage to this device.
- MACOM does not recommend sustained operation near these survivability limits.
- Operating at nominal conditions with $T_J < 150^\circ\text{C}$ will ensure $MTTF > 1 \times 10^6$ hours.
- Junction Temperature (T_J) = Case Temperature (T_C) + $\Theta_{JC} \cdot (V \cdot I)$
Typical thermal resistance (Θ_{JC}) = 29°C/W.
 - For $T_C = 25^\circ\text{C}$,
 $T_J = 67^\circ\text{C}$ @ 5V, 290 mA
 - For $T_C = 85^\circ\text{C}$,
 $T_J = 127^\circ\text{C}$ @ 5 V, 290 mA

Handling Procedures

Please observe the following precautions to avoid damage:

Static Sensitivity

Integrated Circuits are sensitive to electrostatic discharge (ESD) and can be damaged by static electricity. Proper ESD control techniques should be used when handling these (HBM) Class 1B devices.

Recommended PCB Layout

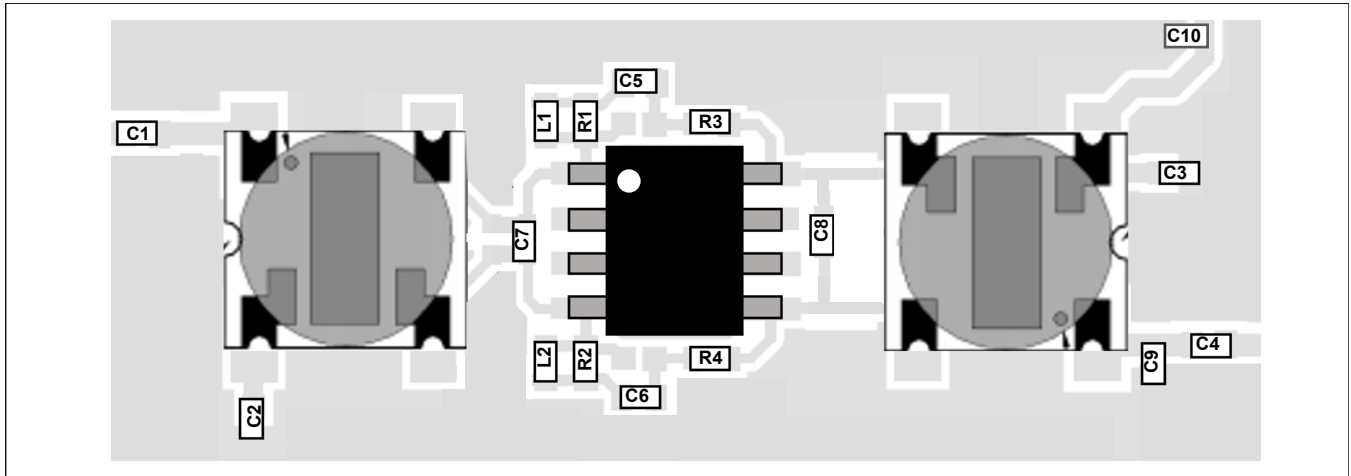

Schematic Including Off-Chip Components

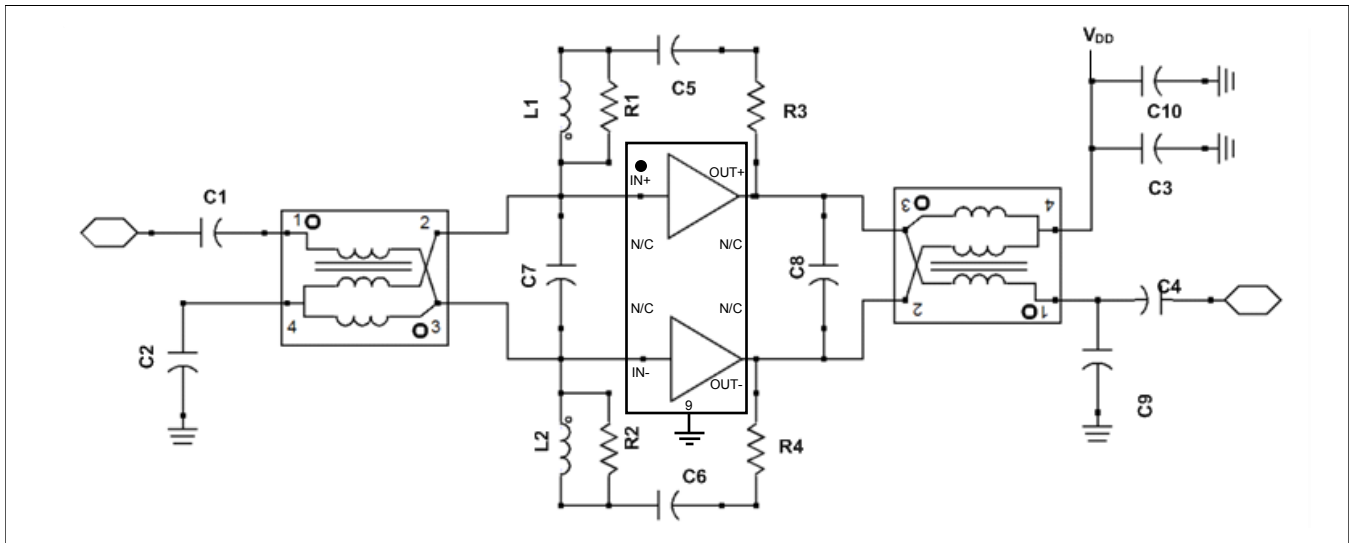

Parts List

Component	Value	Package	Component	Value	Package
C1, C4	270 pF	0402	L1, L2	33 nH	0402
C2, C3, C5, C6, C10	10 nF	0402	R1, R2	82 Ω	0402
C7	0.5 pF	0402	R3, R4	374 Ω	0402
C8	1.2 pF	0402	T1, T2	1:1 Balun ⁸	—
C9	Do Not Install	0402			

8. MABA-009210-CT1760

75 Ω , Differential RF Amplifier 5 - 1218 MHz

Rev. V2

Typical Performance Curves: $V_{DD} = 5\text{ V}$

Gain

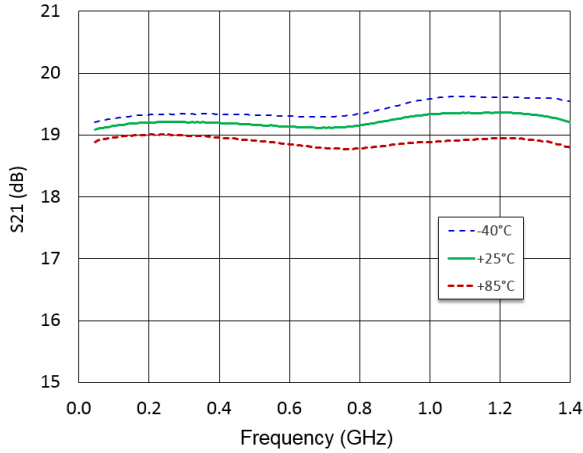

Gain to 3 GHz

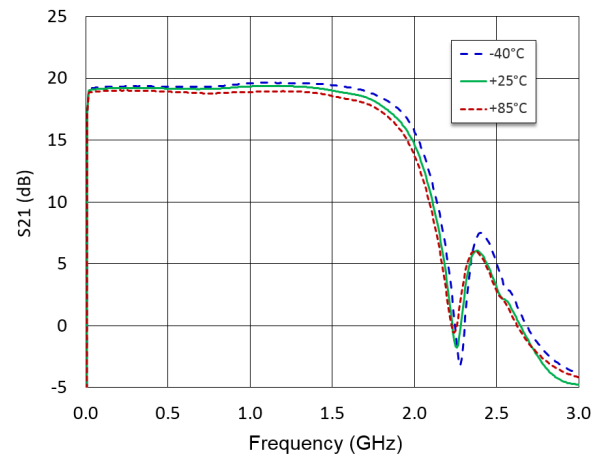

Input Return Loss

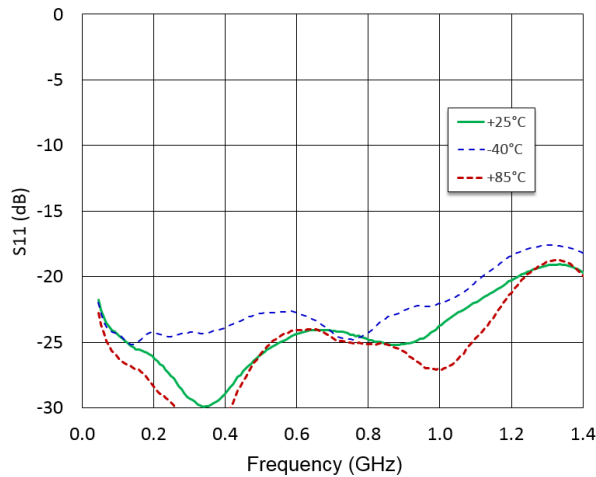

Output Return Loss

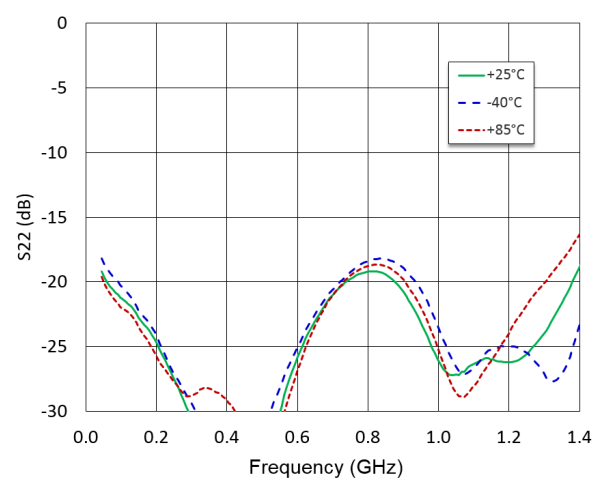

Reverse Isolation

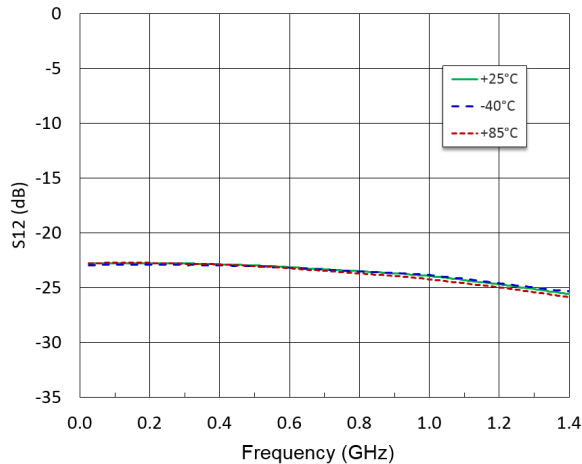

Noise Figure

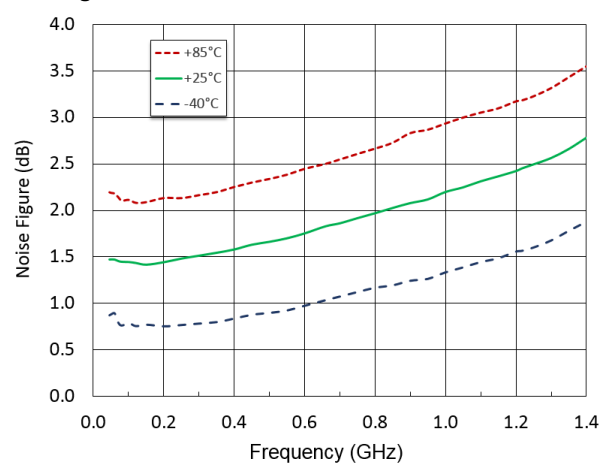

75 Ω , Differential RF Amplifier 5 - 1218 MHz

Rev. V2

Typical Performance Curves: $V_{DD} = 5\text{ V}$

OIP3, $P_{OUT} = +13\text{ dBm/tone}$

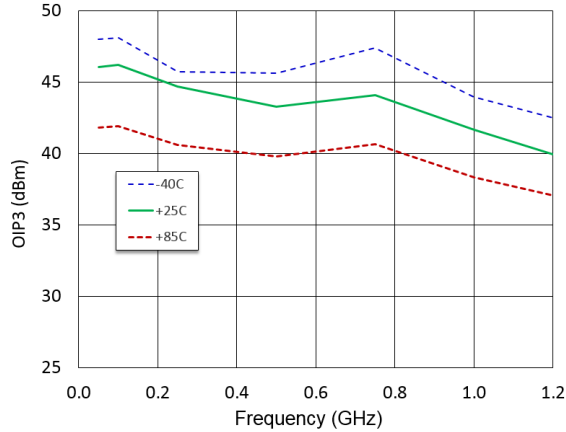

OIP2, $P_{OUT} = +13\text{ dBm/tone}$

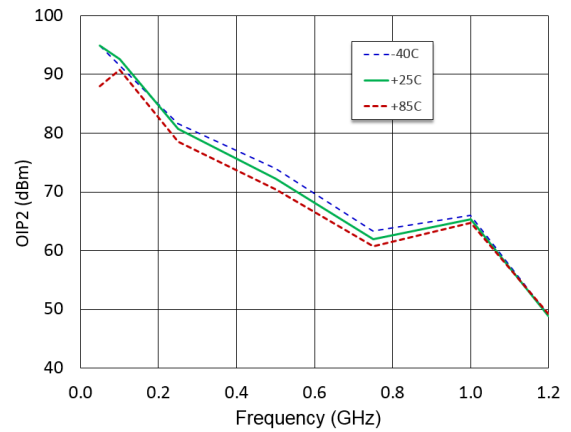

**CSO Lower, 79 channels + QAM to 1 GHz,
0 dB tilt, 39 dBmV per channel**

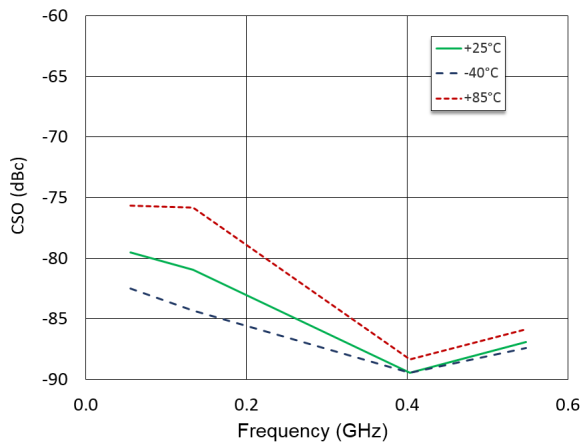

**CSO Upper, 79 channels + QAM to 1 GHz,
0 dB tilt, 39 dBmV per channel**

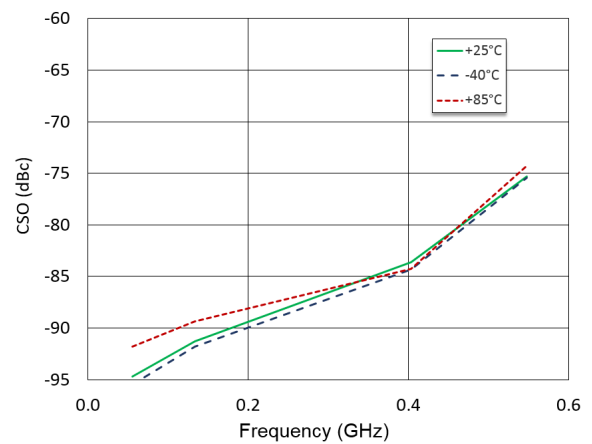

**CTB, 79 channels + QAM to 1 GHz,
0 dB tilt, 39 dBmV per channel**

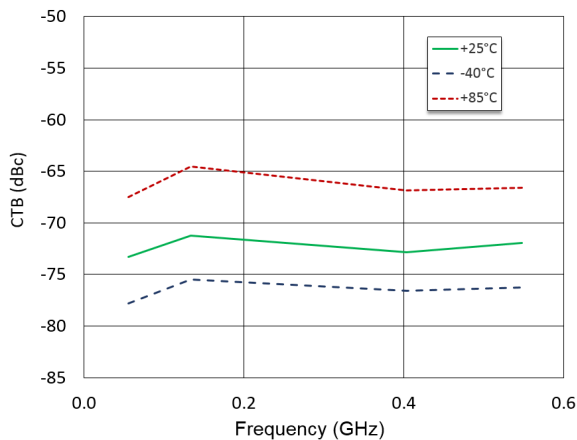

P1dB

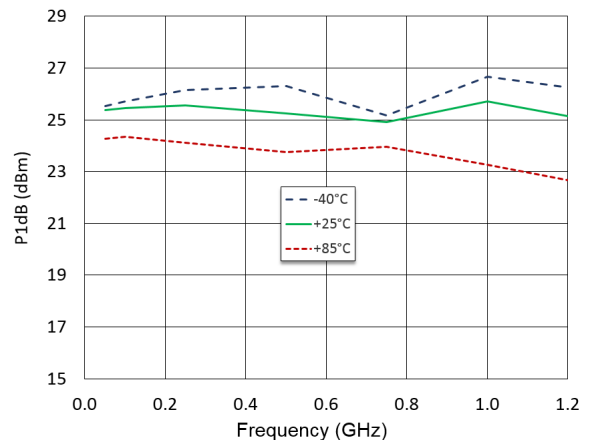

Applications Section: 5 - 300 MHz Application

The MAAM-011163 may be tuned for operation in the 5 - 300 MHz band for CATV reverse path (upstream) applications using an alternate balun and other external tuning components as identified in the table below. The recommended PCB layout and schematic are the same as identified on page 3.

Recommended PCB Layout for Upstream

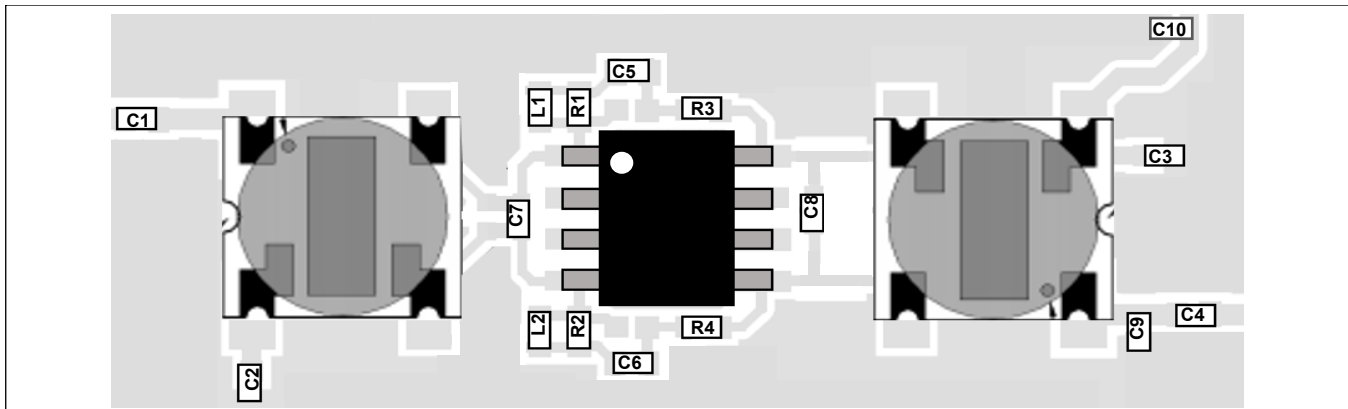

Parts List : 5 - 300 MHz Tune

Component	Value	Package	Component	Value	Package
C1 ,C2,C5,C6	10 nF	0402	C10	2.2 nF	0402
C3	100 nF	0402	L1, L2	33 nH	0402
C4	6.8 nF	0402	R1, R2	82 Ω	0402
C7	0.5 pF	0402	R3, R4	392 Ω	0402
C8	1.2 pF	0402	T1, T2	1:1 Balun ⁹	—
C9	Do Not Install	0402			

9. MABA-011085

Electrical Specifications: 5 - 300 MHz Tune, $T_A = 25^\circ\text{C}$, $V_{DD} = 5\text{ V}$, $Z_0 = 75\ \Omega$

Parameter	Test Conditions	Units	Min.	Typ.	Max.
Gain	5 - 300 MHz	dB	—	19.5	—
Reverse Isolation	5 - 300 MHz	dB	—	22	—
Input Return Loss	5 - 300 MHz	dB	—	22	—
Output Return Loss	5 - 300 MHz	dB	—	22	—
Noise Figure	5 - 10 MHz 20 - 300 MHz	dB	—	2.5 1.5	—
Output IP2	5 - 300 MHz, tone spacing 6 MHz P_{OUT} per tone = +13 dBm	dBm	—	75	—
Output IP3	5 - 300 MHz, tone spacing 6 MHz P_{OUT} per tone = +13 dBm	dBm	—	45	—
P1dB	5 - 300 MHz	dBm	—	25	—
I_{DD}	$V_{DD} = 5\text{ V}$	mA	—	290	—

7

MACOM Technology Solutions Inc. (MACOM) and its affiliates reserve the right to make changes to the product(s) or information contained herein without notice. Visit www.macom.com for additional data sheets and product information.

75 Ω , Differential RF Amplifier 5 - 1218 MHz

Rev. V2

Typical Performance Curves: 5 - 300 MHz Tune, $V_{DD} = 5\text{ V}$, $+25^\circ\text{C}$

Gain

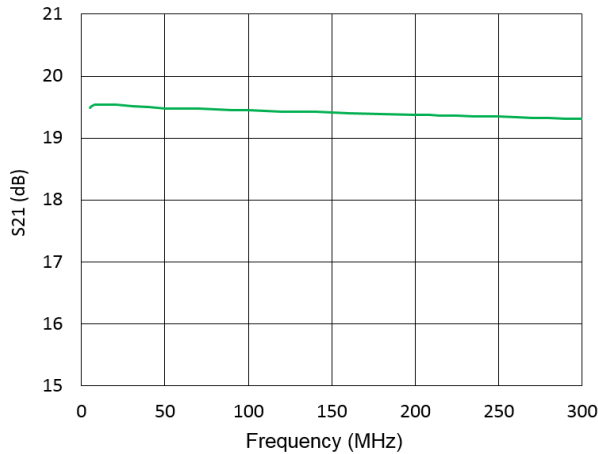

Noise Figure, 10 - 300 MHz

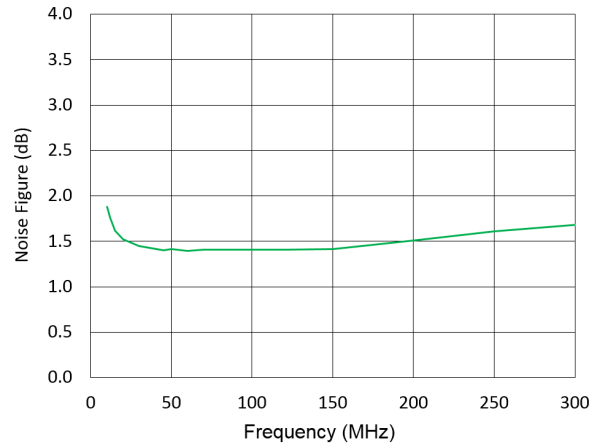

Input Return Loss

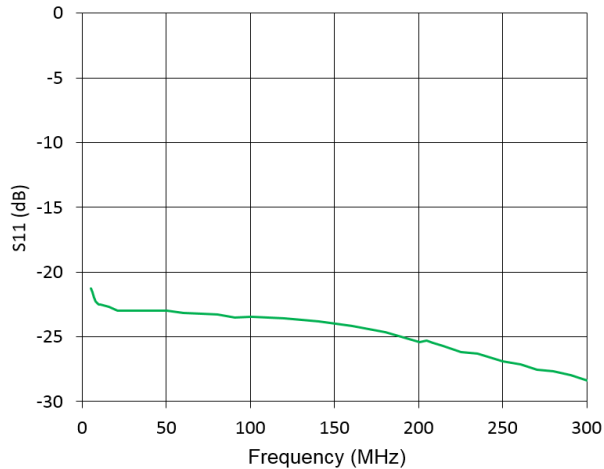

Output Return Loss

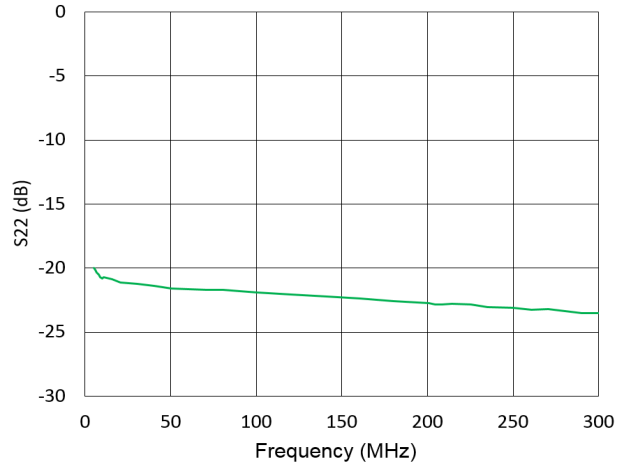

NPR

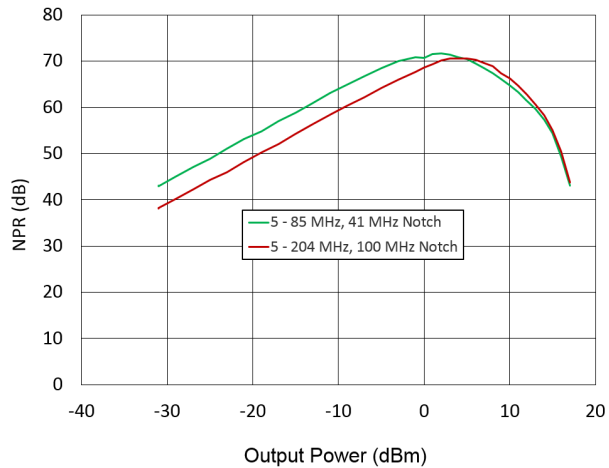

OIP3

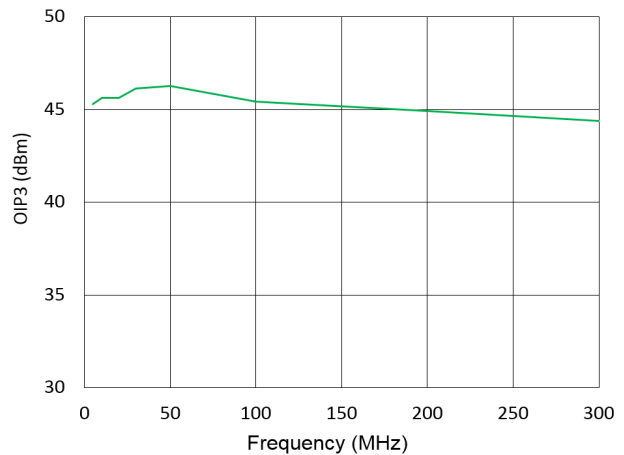

MACOM Technology Solutions Inc. All rights reserved.

Information in this document is provided in connection with MACOM Technology Solutions Inc ("MACOM") products. These materials are provided by MACOM as a service to its customers and may be used for informational purposes only. Except as provided in MACOM's Terms and Conditions of Sale for such products or in any separate agreement related to this document, MACOM assumes no liability whatsoever. MACOM assumes no responsibility for errors or omissions in these materials. MACOM may make changes to specifications and product descriptions at any time, without notice. MACOM makes no commitment to update the information and shall have no responsibility whatsoever for conflicts or incompatibilities arising from future changes to its specifications and product descriptions. No license, express or implied, by estoppels or otherwise, to any intellectual property rights is granted by this document.

THESE MATERIALS ARE PROVIDED "AS IS" WITHOUT WARRANTY OF ANY KIND, EITHER EXPRESS OR IMPLIED, RELATING TO SALE AND/OR USE OF MACOM PRODUCTS INCLUDING LIABILITY OR WARRANTIES RELATING TO FITNESS FOR A PARTICULAR PURPOSE, CONSEQUENTIAL OR INCIDENTAL DAMAGES, MERCHANTABILITY, OR INFRINGEMENT OF ANY PATENT, COPYRIGHT OR OTHER INTELLECTUAL PROPERTY RIGHT. MACOM FURTHER DOES NOT WARRANT THE ACCURACY OR COMPLETENESS OF THE INFORMATION, TEXT, GRAPHICS OR OTHER ITEMS CONTAINED WITHIN THESE MATERIALS. MACOM SHALL NOT BE LIABLE FOR ANY SPECIAL, INDIRECT, INCIDENTAL, OR CONSEQUENTIAL DAMAGES, INCLUDING WITHOUT LIMITATION, LOST REVENUES OR LOST PROFITS, WHICH MAY RESULT FROM THE USE OF THESE MATERIALS.

MACOM products are not intended for use in medical, lifesaving or life sustaining applications. MACOM customers using or selling MACOM products for use in such applications do so at their own risk and agree to fully indemnify MACOM for any damages resulting from such improper use or sale.