

## Features

- Single Stage, Single Ended
- 5 V, 110 mA Operation
- 18 dB Flat Gain
- Low Noise
- Low Distortion Performance
- ESD Class 1C, HBM
- Lead-Free SOT-89 Plastic Package
- Halogen-Free “Green” Mold Compound
- RoHS\* Compliant

## Description

The MAAM-011162 is an RF amplifier assembled in a SOT-89 plastic package. This amplifier provides 18 dB of flat gain in both forward and reverse path applications. This amplifier provides excellent noise figure.

The MAAM-011162 provides high gain, low noise and low distortion making it ideally suited for 75  $\Omega$  infrastructure applications.

The MAAM-011162 is fabricated using GaAs pHEMT technology.

## Ordering Information<sup>1,2</sup>

Part Number	Package
MAAM-011162-TR1000	1000 piece reel
MAAM-011162-TR3000	3000 piece reel
MAAM-011162-DSBSMB	Sample Board, 45 - 1218 MHz
MAAM-011162-USBSMB	Sample Board, 5 - 300 MHz

1. Reference Application Note M513 for reel size information.
2. All production sample boards include 5 loose parts.

\* Restrictions on Hazardous Substances, European Union Directive 2011/65/EU.

## Functional Schematic

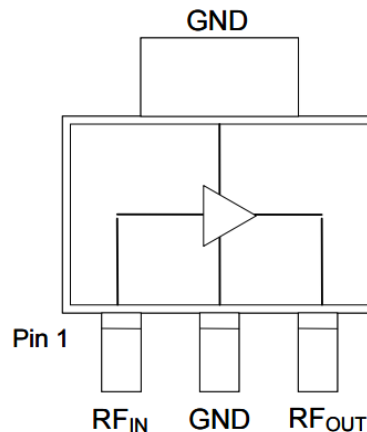

## Pin Configuration

Pin No.	Pin Name	Function
1	RF <sub>IN</sub>	RF Input
2	GND	RF and DC Ground
3	RF <sub>OUT</sub>	RF Output / Drain Supply

## 75 $\Omega$ , High Linearity, Low Noise, CATV Amplifier 5 - 1218 MHz

Rev. V1

Electrical Specifications:  $T_A = 25^\circ\text{C}$ ,  $V_{DD} = 5\text{ V}$ ,  $Z_0 = 75\ \Omega$

Parameter	Test Conditions	Units	Min.	Typ.	Max.
Gain	45 - 1218 MHz	dB	17	18	19
Tilt	45 - 1218 MHz	dB	—	0.1	—
Reverse Isolation	45 - 1218 MHz	dB	—	20	—
Input Return Loss	45 - 1218 MHz	dB	—	20	—
Output Return Loss	45 - 1218 MHz	dB	—	20	—
Noise Figure	45 MHz 1218 MHz	dB	—	1.5 2.1	2.6
Output IP2	45 - 1218 MHz, tone spacing 6 MHz, $P_{OUT}$ per tone = 2 dBm	dBm	—	48	—
Output IP3	45 - 1218 MHz, tone spacing 6 MHz, $P_{OUT}$ per tone = 2 dBm	dBm	—	36	—
P1dB	—	dBm	—	19	—
Composite Triple Beat, CTB	79 channels, 0 dB Tilt, 32 dBmV per channel output, QAM to 1000 MHz	dBc	—	-74	—
Composite Second Order, CSO	79 channels, 0 dB Tilt, 32 dBmV per channel output, QAM to 1000 MHz	dBc	—	-61	—
$I_{DD}$	$V_{DD} = 5\text{ V}$	mA	—	110	125

### Absolute Maximum Ratings<sup>3,4,5,6</sup>

Parameter	Absolute Maximum
Max Input Power	7 dBm
Operating Voltage	7 V
Operating Temperature	-40°C to +85°C
Storage Temperature	-65°C to +150°C
Junction Temperature	150°C

- Exceeding any one or combination of these limits may cause permanent damage to this device.
- MACOM does not recommend sustained operation near these survivability limits.
- Operating at nominal conditions with  $T_C \leq 150^\circ\text{C}$  will ensure  $MTTF > 1 \times 10^6$  hours.
- Junction Temperature ( $T_J$ ) =  $T_C + \Theta_{JC} \cdot (V \cdot I)$   
Typical thermal resistance ( $\Theta_{JC}$ ) = 44.2°C/W.
  - For  $T_C = 25^\circ\text{C}$ ,  
 $T_J = 49.3^\circ\text{C} @ 5\text{ V}, 110\text{ mA}$
  - For  $T_C = 85^\circ\text{C}$ ,  
 $T_J = 105.1^\circ\text{C} @ 5\text{ V}, 110\text{ mA}$

### Handling Procedures

Please observe the following precautions to avoid damage:

### Static Sensitivity

Integrated Circuits are sensitive to electrostatic discharge (ESD) and can be damaged by static electricity. Proper ESD control techniques should be used when handling these HBM Class 1C devices.

## Recommended PCB Layout

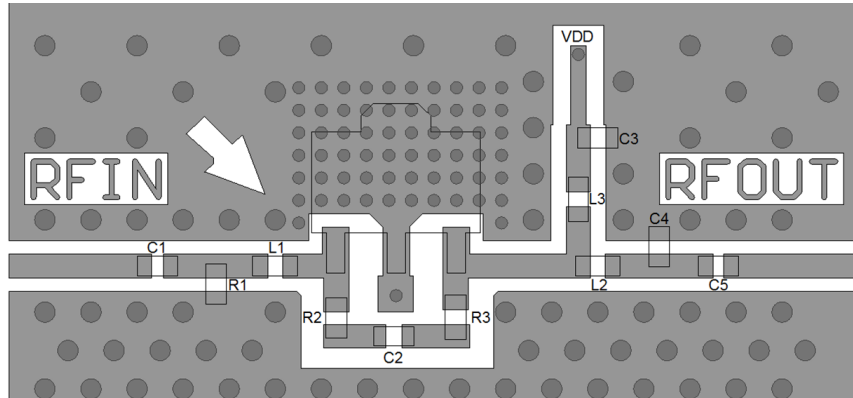

## Application Schematic

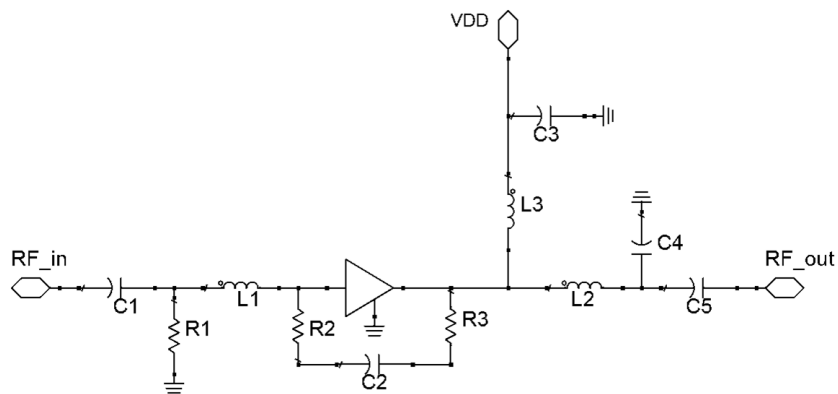

## Parts List

Component	Value	Package
C1 - C3	10 nF	0402
C4	0.5 pF	0402
C5	180 pF	0402
L1	7.5 nH	0402
L2	6.2 nH	0402
L3	Ferrite Bead <sup>7</sup>	0402
R1	51 k $\Omega$	0402
R2	270 $\Omega$	0402
R3	430 $\Omega$	0402

## PCB Land Pattern<sup>8</sup>

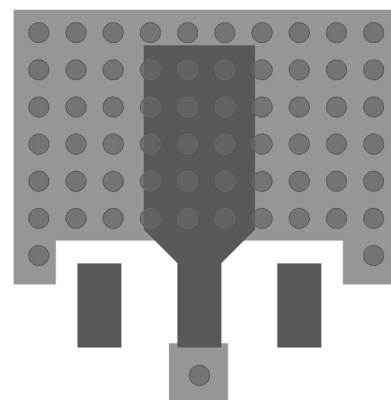

8. 60 vias beneath package, 0.012" via diameter

7. Ferrite Bead from Murata, part number BLM15HD182SN.

## 75 $\Omega$ , High Linearity, Low Noise, CATV Amplifier 5 - 1218 MHz

Rev. V1

### Typical Performance Curves: $V_{DD} = 5\text{ V}$

#### Gain

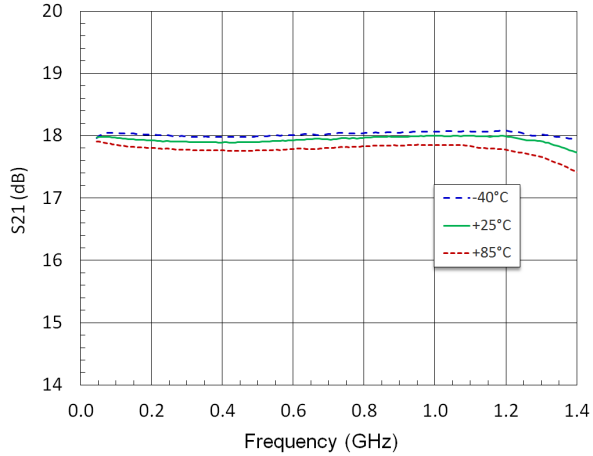

#### Gain to 3 GHz

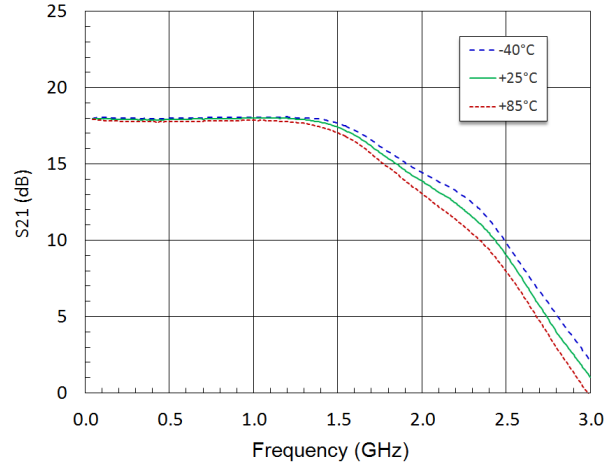

#### Input Return Loss

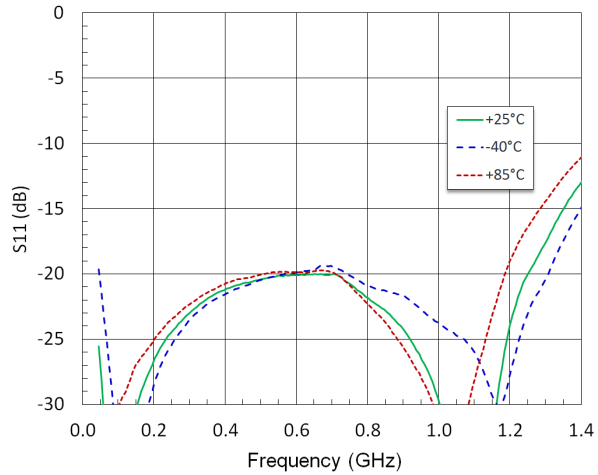

#### Output Return Loss

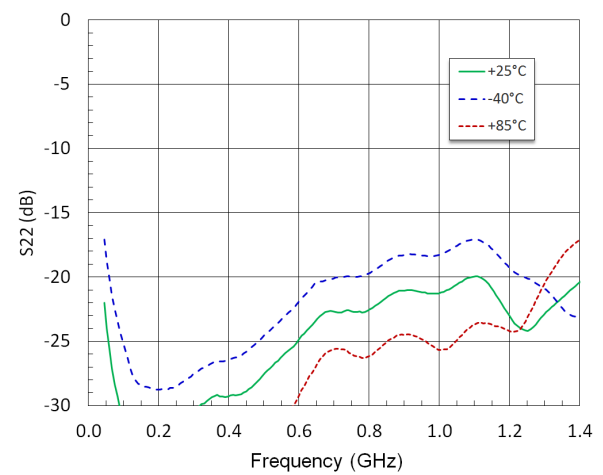

#### Reverse Isolation

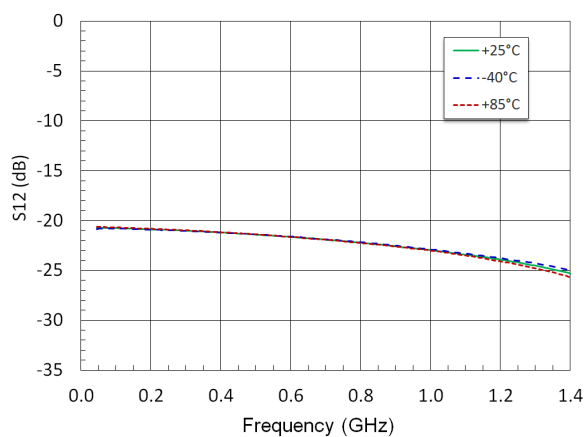

#### Noise Figure

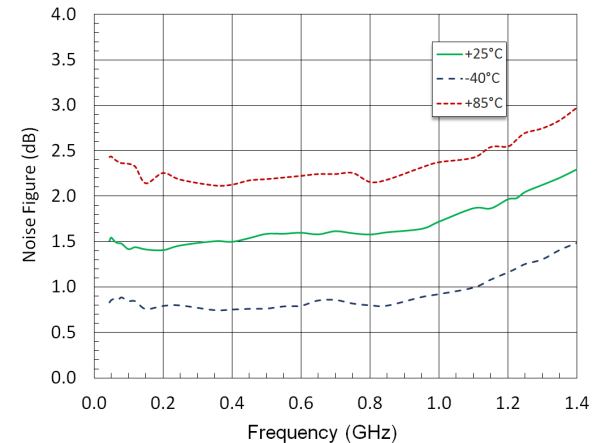

## 75 $\Omega$ , High Linearity, Low Noise, CATV Amplifier 5 - 1218 MHz

Rev. V1

### Typical Performance Curves: $V_{DD} = 5\text{ V}$

#### OIP2

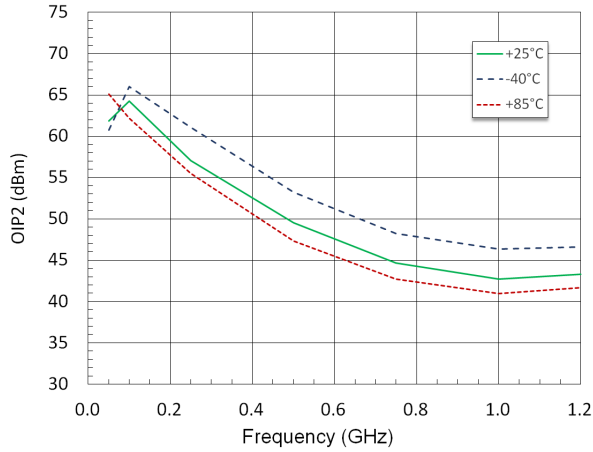

#### OIP3

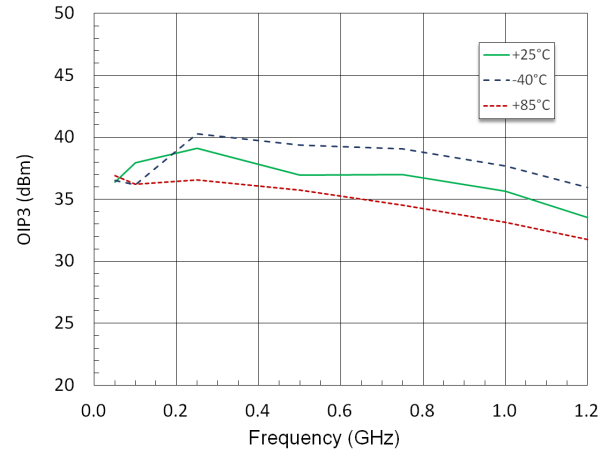

#### P1dB

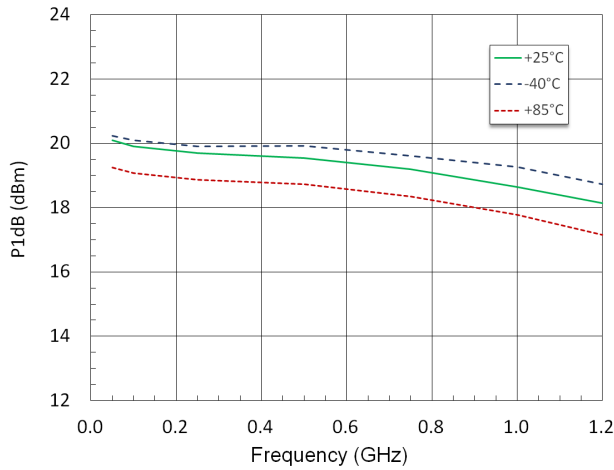

#### CTB

79 analog ch + QAM, 0 dB tilt,  $P_{OUT} = 32\text{ dBmV per ch}$

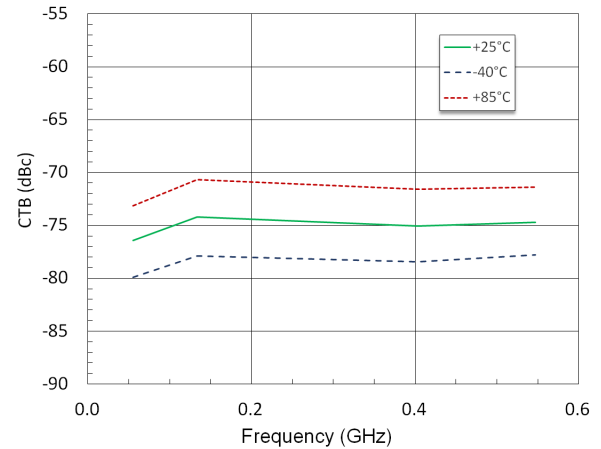

#### CSO Lower

79 analog ch + QAM, 0 dB tilt,  $P_{OUT} = 32\text{ dBmV per ch}$

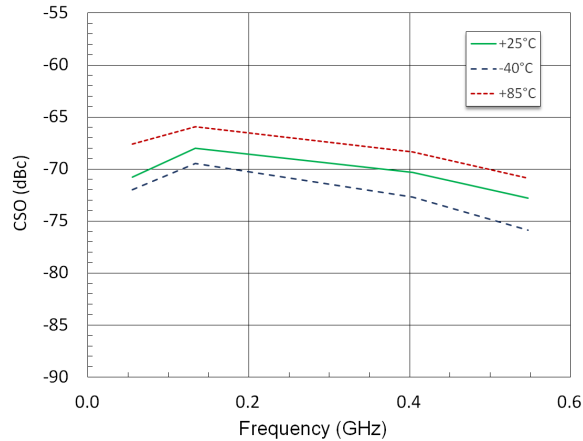

#### CSO Upper

79 analog ch + QAM, 0 dB tilt,  $P_{OUT} = 32\text{ dBmV per ch}$

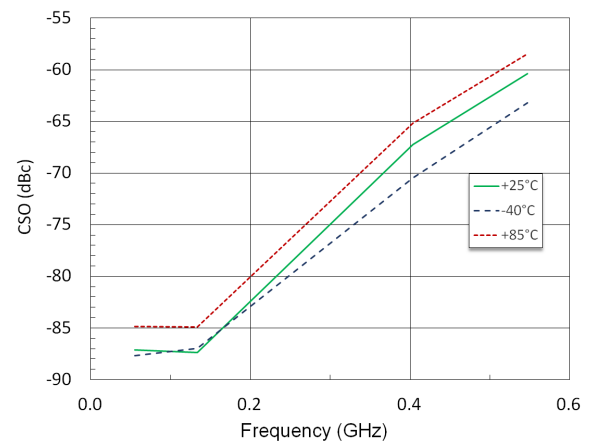

## Lead Free SOT-89<sup>†</sup>

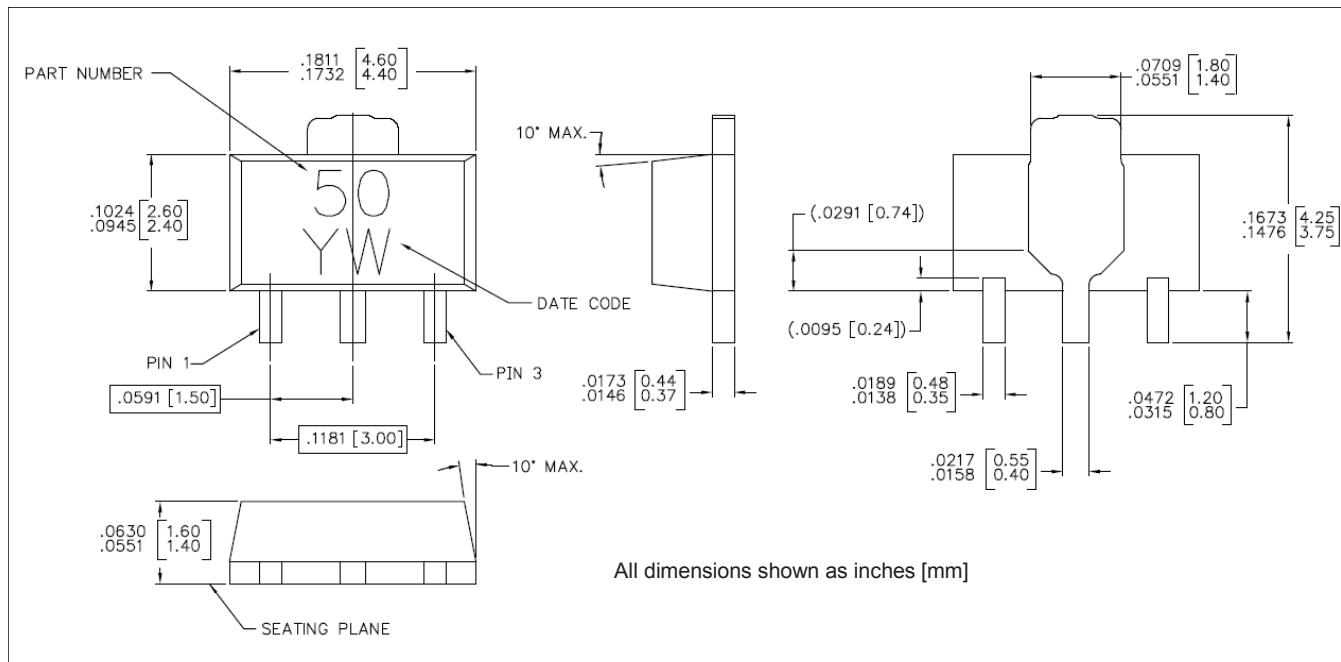

<sup>†</sup> Reference Application Note S2083 for lead-free solder reflow recommendations.  
 Meets JEDEC moisture sensitivity level 1 requirements.  
 Plating is 100% matte tin over copper.

## Applications Section - 5 - 300 MHz Application

The MAAM-011162 may be tuned for operation in the 5 - 300 MHz band for CATV reverse path (upstream) applications using alternate external tuning components.

**Typical Performance:  $T_A = 25^\circ\text{C}$ ,  $V_{DD} = 5\text{ V}$ ,  $Z_0 = 75\ \Omega$**

Parameter	Test Conditions	Units	Min.	Typ.	Max.
Gain	5 - 300 MHz	dB	—	18	—
Tilt	5 - 300 MHz	dB	—	0	—
Reverse Isolation	5 - 300 MHz	dB	—	20.5	—
Input Return Loss	5 - 300 MHz	dB	—	25	—
Output Return Loss	5 - 300 MHz	dB	—	27	—
Noise Figure	10 - 50 MHz 50 - 300 MHz	dB	—	2.4 1.4	—
Output IP2	5 - 300MHz, tone spacing 6 MHz, $P_{OUT}$ per tone = 2 dBm	dBm	—	60	—
Output IP3	5 - 300MHz, tone spacing 6 MHz, $P_{OUT}$ per tone = 2 dBm	dBm	—	39	—
P1dB	5 - 300 MHz	dBm	—	19	—
$I_{DD}$	$V_{DD} = 5\text{ V}$	mA	—	110	—
Noise Power Ratio	5 - 85 MHz, 41 MHz Notch, Peak NPR 5 - 204 MHz, 100 MHz Notch, Peak NPR	dB	—	71 66	—

### Recommended PCB Layout

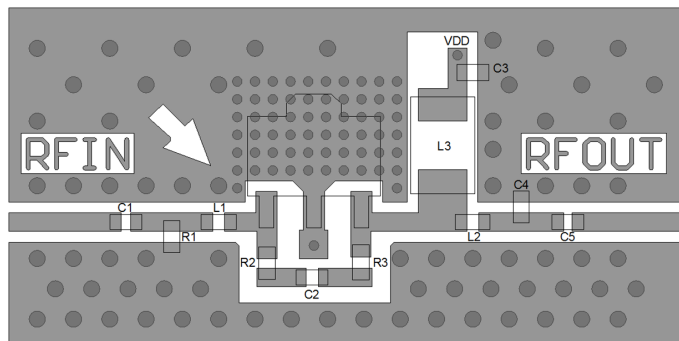

### Parts List

Component	Value	Package
C1-C3	10 nF	0402
C4	Do Not Place	-
C5	2200 pF	0402
L1	0 $\Omega$ Resistor	0402
L2	5.6 nH	0402
L3	22 $\mu\text{H}^9$	0806
R1	51 k $\Omega$	0402
R2	270 $\Omega$	0402
R3	430 $\Omega$	0402

9. Inductor from Murata, part number LQH2MCN220K02

## 75 $\Omega$ , High Linearity, Low Noise, CATV Amplifier 5 - 1218 MHz

Rev. V1

### Typical Performance Curves: 5 - 300 MHz, $V_{DD} = 5\text{ V}$ , $+25^\circ\text{C}$

**Gain**

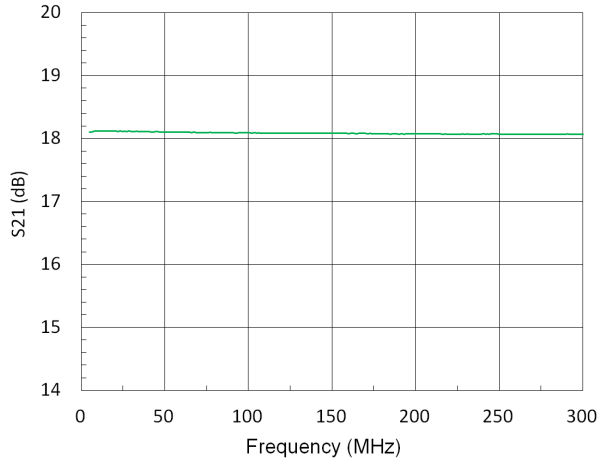

**Reverse Isolation**

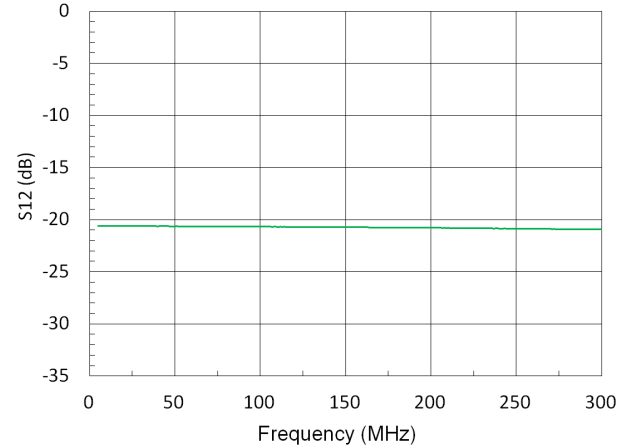

**Input Return Loss**

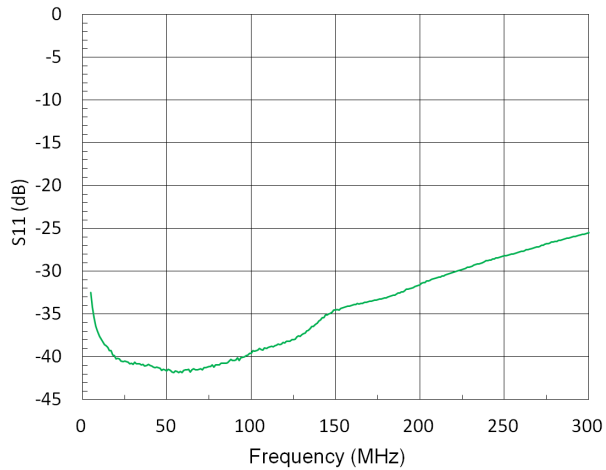

**Output Return Loss**

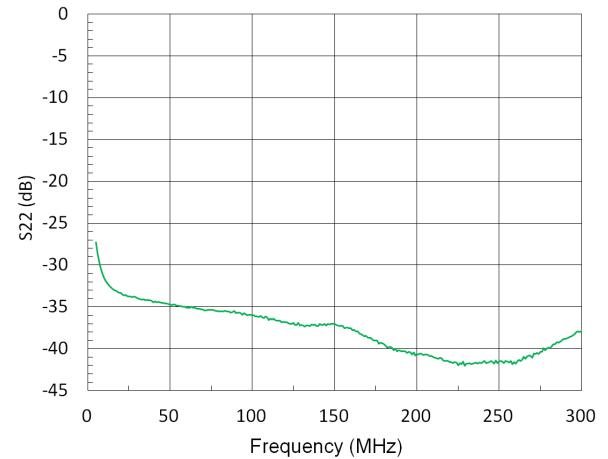

**Noise Figure 10 - 300 MHz**

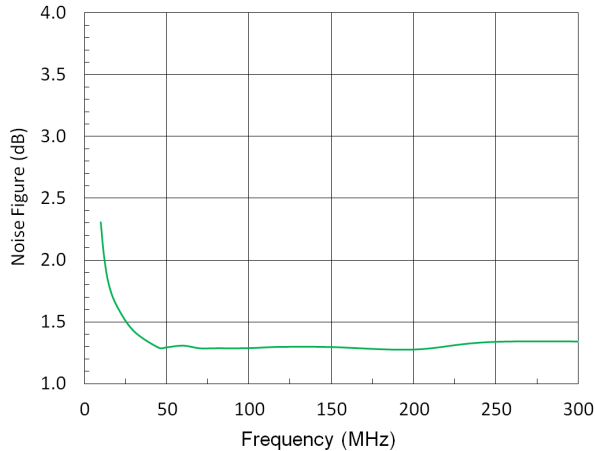

**P1dB**

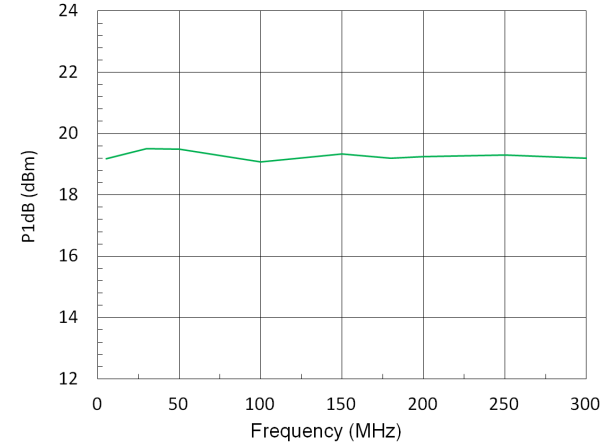



## 75 $\Omega$ , High Linearity, Low Noise, CATV Amplifier 5 - 1218 MHz

Rev. V1

### Typical Performance Curves: 5 - 300 MHz, $V_{DD} = 5\text{ V}$ , $+25^\circ\text{C}$

**OIP3**

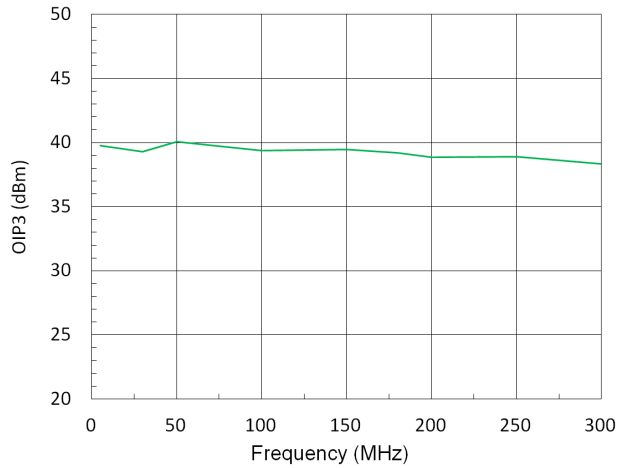

**OIP2**

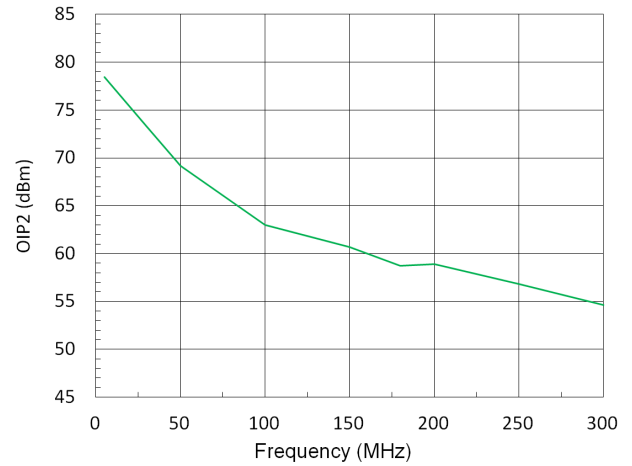

**Noise Power Ratio (NPR)**

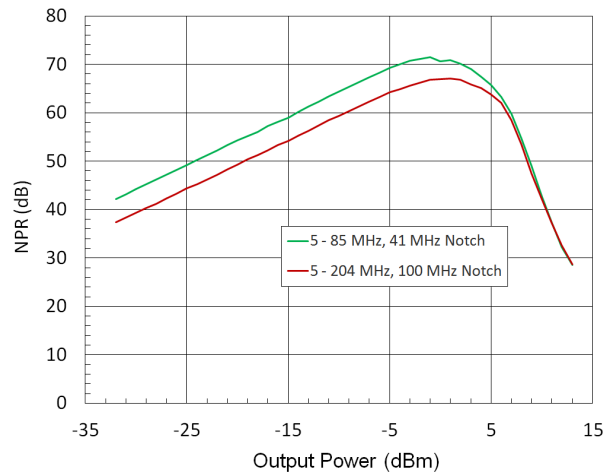

MACOM Technology Solutions Inc. All rights reserved.

Information in this document is provided in connection with MACOM Technology Solutions Inc ("MACOM") products. These materials are provided by MACOM as a service to its customers and may be used for informational purposes only. Except as provided in MACOM's Terms and Conditions of Sale for such products or in any separate agreement related to this document, MACOM assumes no liability whatsoever. MACOM assumes no responsibility for errors or omissions in these materials. MACOM may make changes to specifications and product descriptions at any time, without notice. MACOM makes no commitment to update the information and shall have no responsibility whatsoever for conflicts or incompatibilities arising from future changes to its specifications and product descriptions. No license, express or implied, by estoppel or otherwise, to any intellectual property rights is granted by this document.

THESE MATERIALS ARE PROVIDED "AS IS" WITHOUT WARRANTY OF ANY KIND, EITHER EXPRESS OR IMPLIED, RELATING TO SALE AND/OR USE OF MACOM PRODUCTS INCLUDING LIABILITY OR WARRANTIES RELATING TO FITNESS FOR A PARTICULAR PURPOSE, CONSEQUENTIAL OR INCIDENTAL DAMAGES, MERCHANTABILITY, OR INFRINGEMENT OF ANY PATENT, COPYRIGHT OR OTHER INTELLECTUAL PROPERTY RIGHT. MACOM FURTHER DOES NOT WARRANT THE ACCURACY OR COMPLETENESS OF THE INFORMATION, TEXT, GRAPHICS OR OTHER ITEMS CONTAINED WITHIN THESE MATERIALS. MACOM SHALL NOT BE LIABLE FOR ANY SPECIAL, INDIRECT, INCIDENTAL, OR CONSEQUENTIAL DAMAGES, INCLUDING WITHOUT LIMITATION, LOST REVENUES OR LOST PROFITS, WHICH MAY RESULT FROM THE USE OF THESE MATERIALS.

MACOM products are not intended for use in medical, lifesaving or life sustaining applications. MACOM customers using or selling MACOM products for use in such applications do so at their own risk and agree to fully indemnify MACOM for any damages resulting from such improper use or sale.