

## Surface Mounting Instructions

Rev. V6

### Footprint Guidelines

Surface mount board layout is a critical portion of the total design. The footprint must be the correct size to ensure proper solder connection interface between the board and the package. With the correct pad geometry, the package will self-align when subjected to a solder reflow process and will also allow for just enough excess surface area for adequate solder filleting. The following recommended footprints are suggested guidelines only and may require ground plane modifications for electrical and/or thermal considerations. When an increase in ground plane size is necessary, solder mask over bare copper (SMOBC) should be utilized to contain solder and eliminate alignment problems during solder reflow. Electrical and/or thermal considerations may also require the board to contain plated vias located under the surface mount package. When this is necessary, the recommended via diameter is 0.3mm with a pitch of 1.0mm. To prevent solder wicking inside the via during reflow, solder mask pads are recommended over all vias located under the package. The solder mask diameter should be 100 microns larger than the via diameter. Blind or filled vias also work well as an alternative to solder mask to further enhance thermal conduction.

### Package Style Footprints

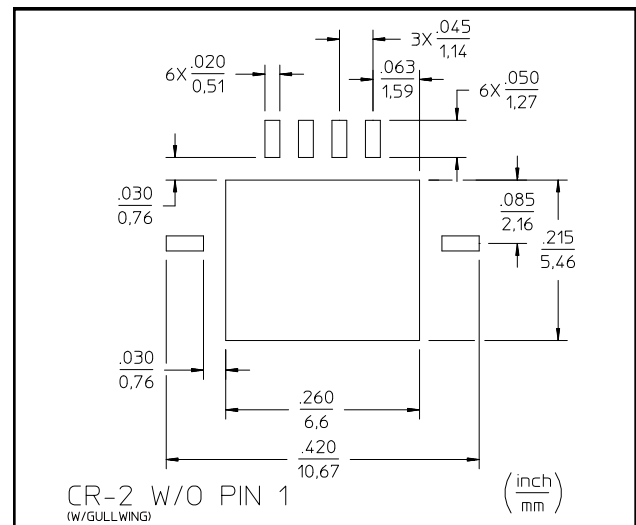
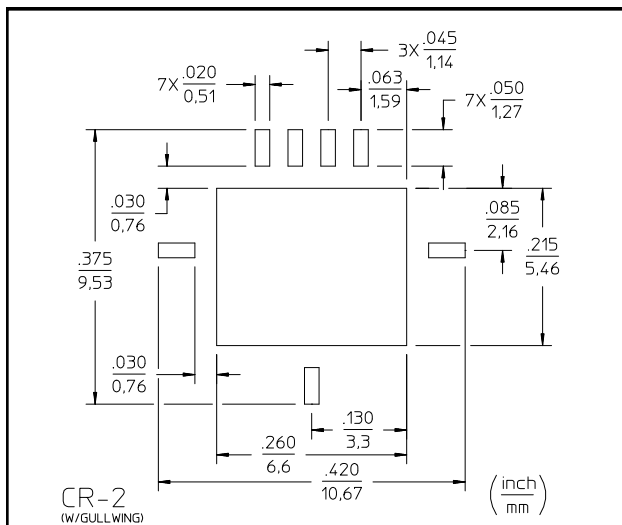

**Surface Mounting Instructions**

Rev. V6

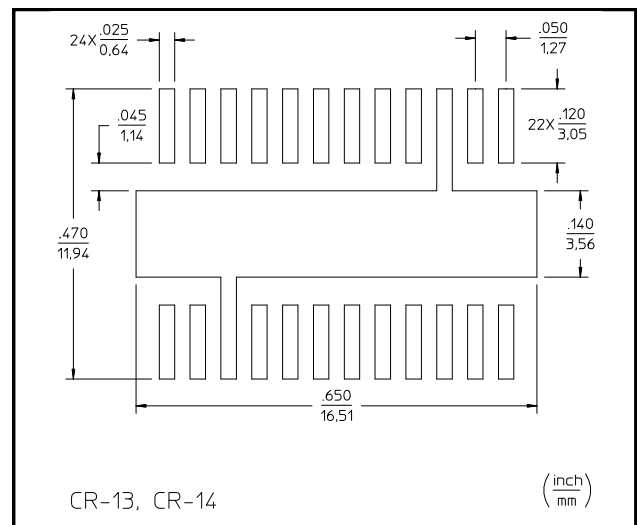
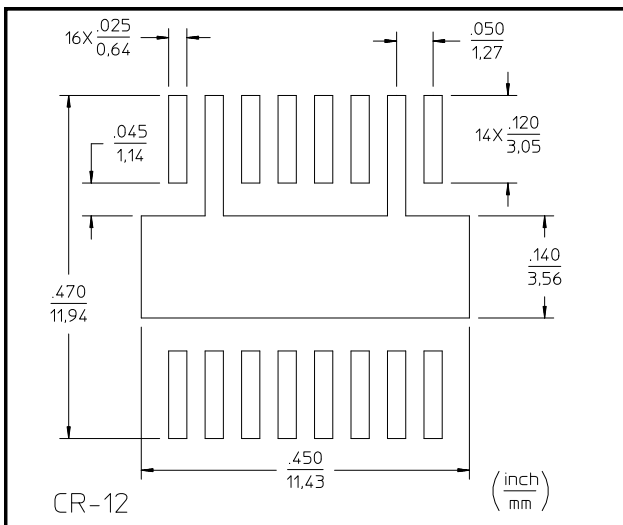
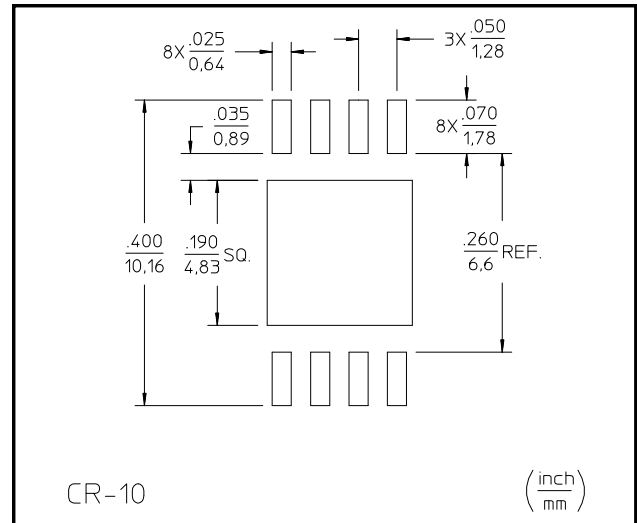
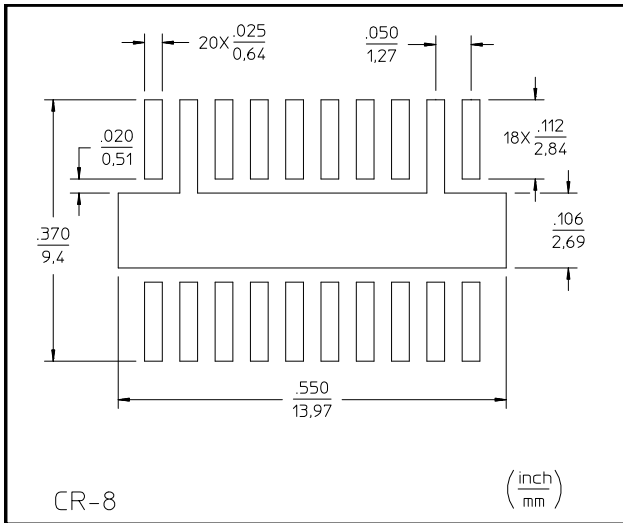
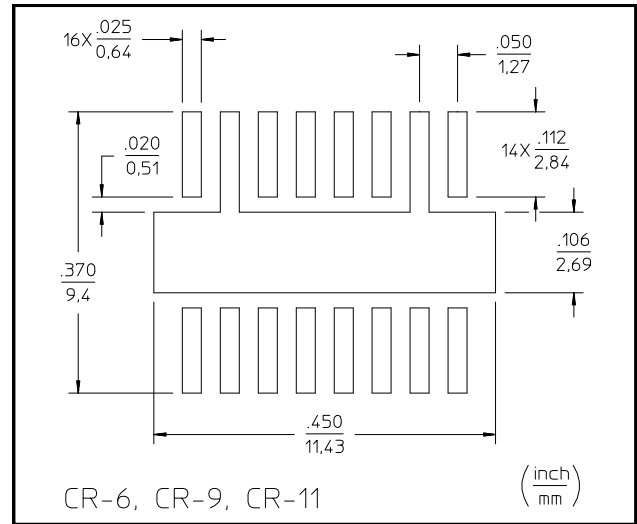
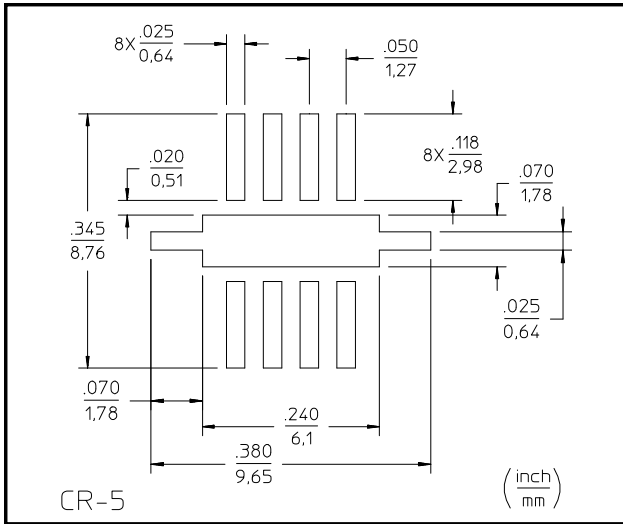

**ADVANCED:** Data Sheets contain information regarding a product M/A-COM Technology Solutions is considering for development. Performance is based on target specifications, simulated results, and/or prototype measurements. Commitment to develop is not guaranteed.  
**PRELIMINARY:** Data Sheets contain information regarding a product M/A-COM Technology Solutions has under development. Performance is based on engineering tests. Specifications are typical. Mechanical outline has been fixed. Engineering samples and/or test data may be available. Commitment to produce in volume is not guaranteed.

• **North America** Tel: 800.366.2266 • **Europe** Tel: +353.21.244.6400  
 • **India** Tel: +91.80.43537383 • **China** Tel: +86.21.2407.1588  
 Visit [www.macontech.com](http://www.macontech.com) for additional data sheets and product information.

M/A-COM Technology Solutions Inc. and its affiliates reserve the right to make changes to the product(s) or information contained herein without notice.

**Surface Mounting Instructions**

Rev. V6

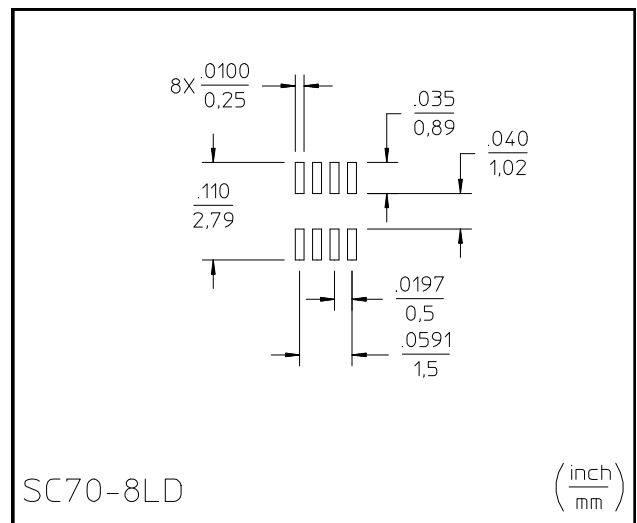
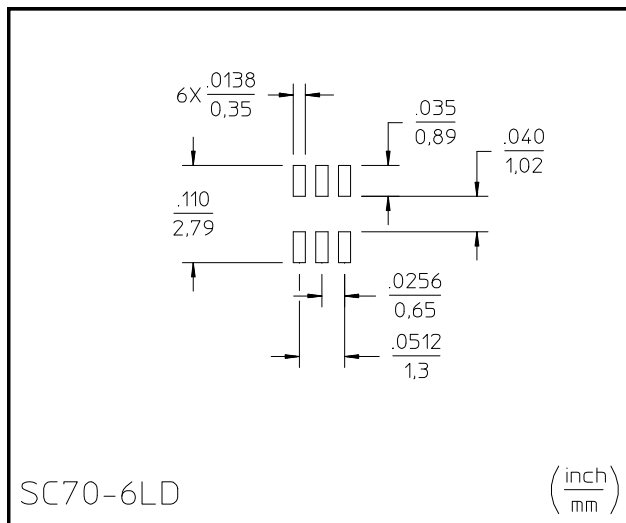
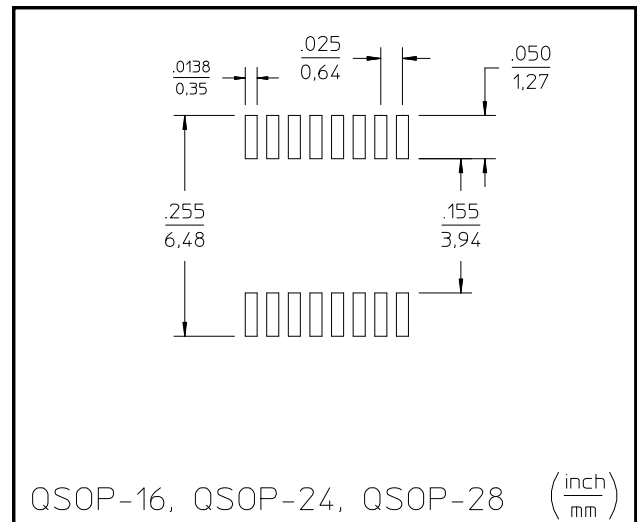
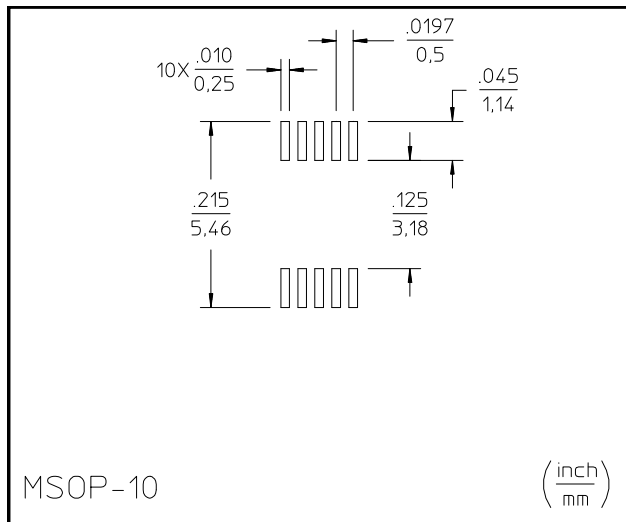
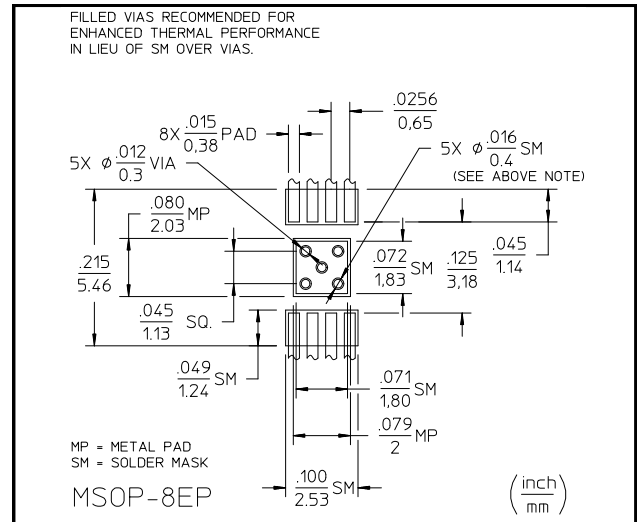
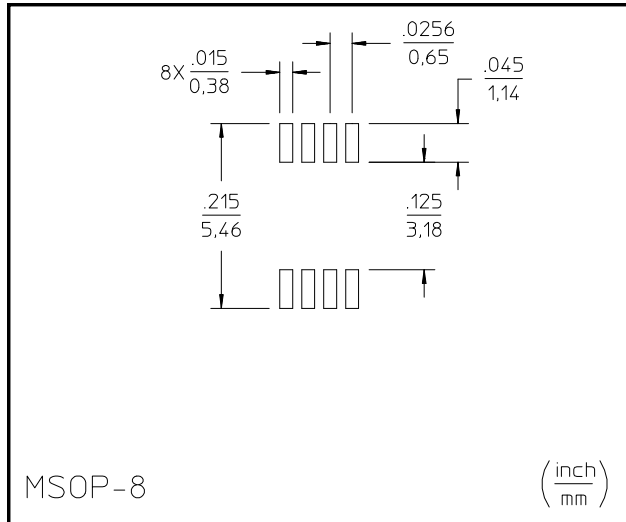

**ADVANCED:** Data Sheets contain information regarding a product M/A-COM Technology Solutions is considering for development. Performance is based on target specifications, simulated results, and/or prototype measurements. Commitment to develop is not guaranteed.  
**PRELIMINARY:** Data Sheets contain information regarding a product M/A-COM Technology Solutions has under development. Performance is based on engineering tests. Specifications are typical. Mechanical outline has been fixed. Engineering samples and/or test data may be available. Commitment to produce in volume is not guaranteed.

• **North America** Tel: 800.366.2266 • **Europe** Tel: +353.21.244.6400  
 • **India** Tel: +91.80.43537383 • **China** Tel: +86.21.2407.1588  
 Visit [www.macontech.com](http://www.macontech.com) for additional data sheets and product information.

M/A-COM Technology Solutions Inc. and its affiliates reserve the right to make changes to the product(s) or information contained herein without notice.

**Surface Mounting Instructions**

Rev. V6

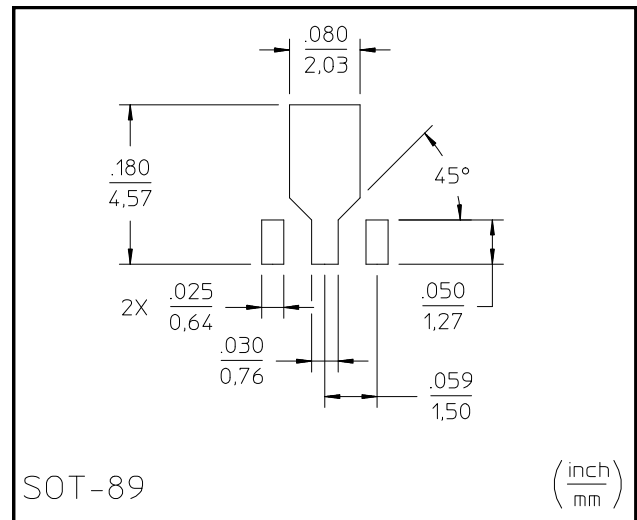
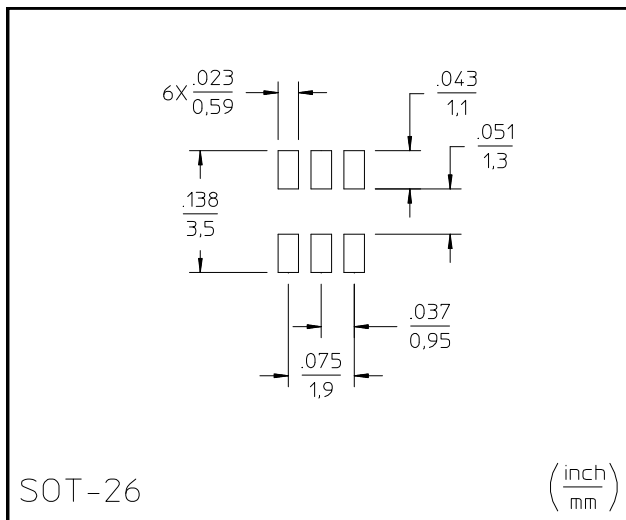
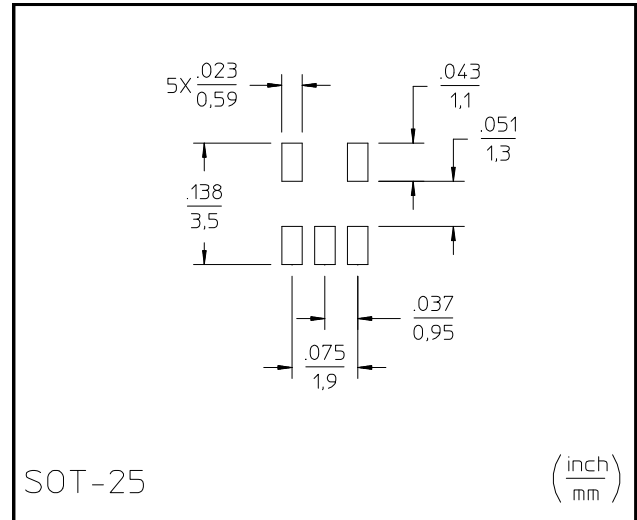
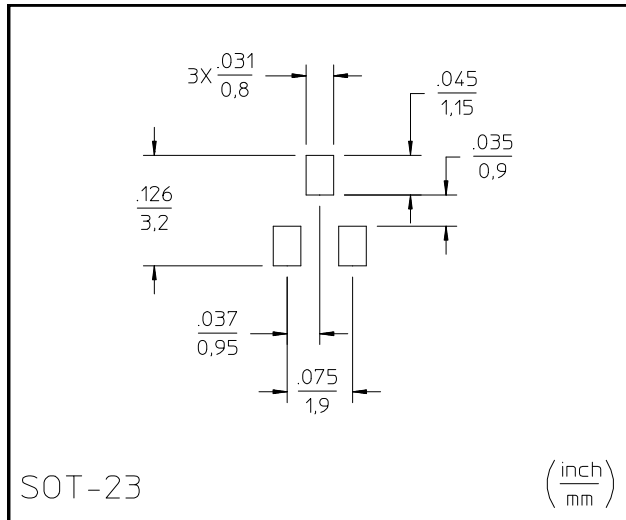
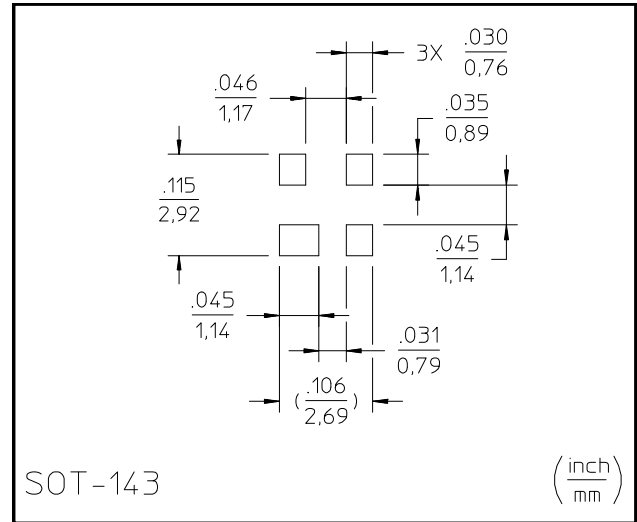
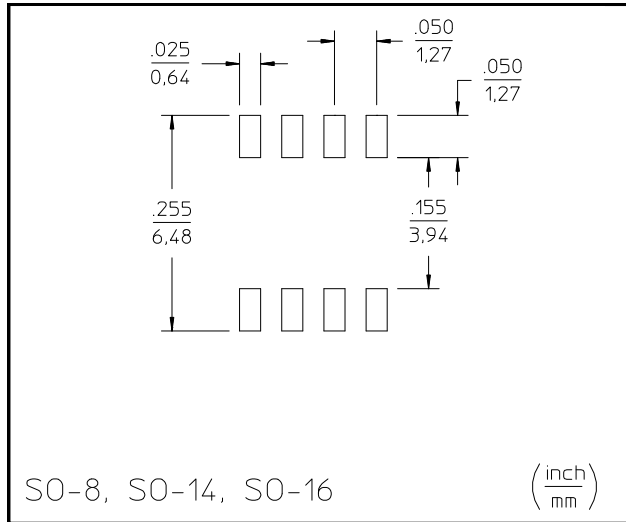

**Surface Mounting Instructions**

Rev. V6

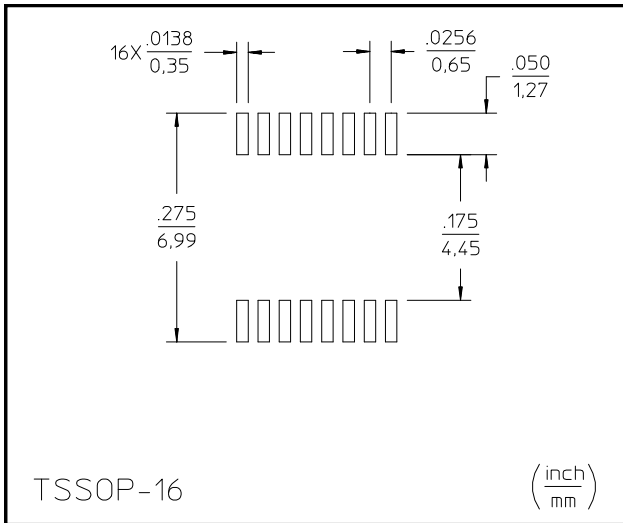
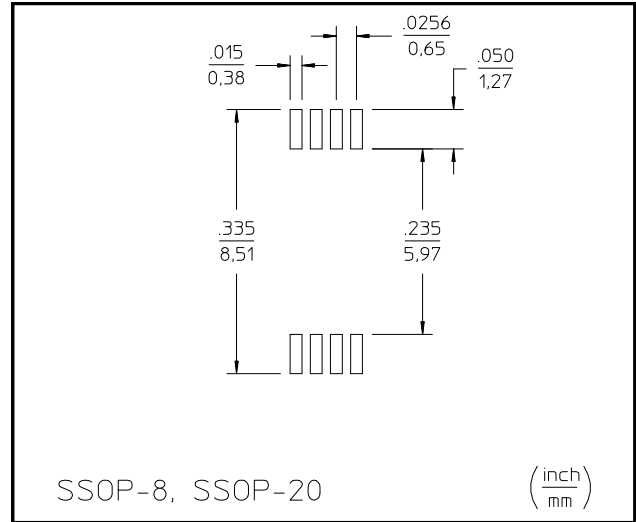
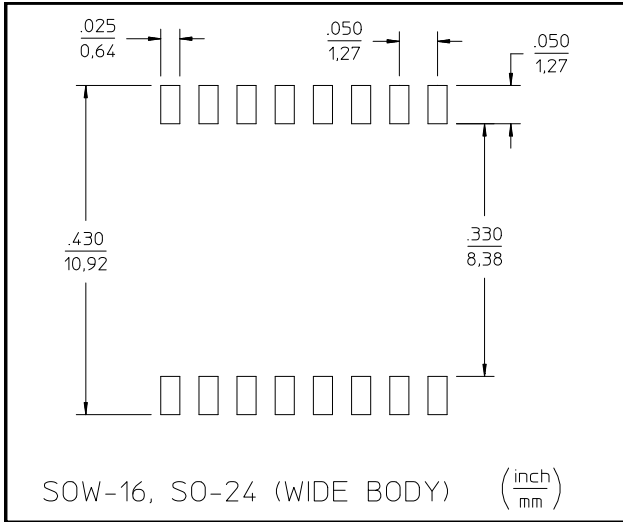

## Surface Mounting Instructions

Rev. V6

### General Thermal Considerations

Thermal resistance will be a function of the following:

- Thermal conductivity of the substrate or board material
- Footprint size available for heat spreading
- Circuit board copper foil weight (2 oz minimum recommended for power applications)
- Via hole quantity and location
- Substrate or board thickness
- Proximity of additional thermal loads on board
- Velocity of air flow (forced air cooling)

Thorough testing of the prototype is the only way to prove the adequacy of a thermal design.

### Solder Selection

A typical solder for a tin-lead soldering process is Sn63 (63%Sn, 37%Pb), which clearly is the industry standard for a number of reasons. Sn63 is a eutectic compound with a melting point (+183°C) high enough to exceed the standard operating temperature limit of most components (+150°C) and low enough so that internal component materials are not damaged during proper solder reflow. The one drawback of Sn63 solder when used in combination with gold plated components is a phenomenon called "scavenging." This occurs when gold plating migrates into the solder joint during reflow, which may cause embrittlement of the solder joint. Pretinning the package leads with Sn63 solder paste with RMA flux reduces the gold concentration and produces a stronger joint.

A typical solder for a lead-free soldering process is Tin-Silver-Copper. 95.5Sn-3.8Ag-0.7Cu is one typical solder alloy composition that can be used for a lead free soldering process.

### Solder Screen Guidelines

A solder stencil is required to apply the optimal amount of solder paste onto the pads of the footprint. The amount and thickness will directly affect the quality of the joint and are critical to ensure proper solder connection between the base of the package and the board. A .004 to .007 inch thick stainless steel stencil is recommended for most applications. The stencil opening should be the

same size as the footprint PCB pads (1:1 registration), excluding SMOBC areas. However, if fine pitch components on the same board require a thinner stencil, aperture modification may be necessary.

### Reflow Profile

The most common solder reflow method is accomplished in a belt furnace using convection heat transfer. Tables 1 thru 3 along with Figure 1 show a typical convection reflow profile of temperature versus time. The profile reflects the three distinct heating stages, or zones (preheat, reflow, and cooling) recommended in automated reflow processes to ensure reliable, finished solder joints. The profile will vary among soldering systems and is intended as an example to use as a starting point. Other factors that can affect the profile include the density and types of components on the board, type of solder used and type of board or substrate material being used.

Thermocouples should be securely attached to the top surface of a representative component to insure the temperature exposure is met. Profile should be recorded by data acquisition for future reference.

### General Soldering Precautions

The melting temperature of solder generally exceeds the recommended maximum operating temperature of the device. When the entire device is heated to a high temperature, failure to complete soldering within a short time could result in device failure. Therefore, always observe the following instructions to minimize the thermal stress to the devices.

- Always preheat the device (failure to do so can cause excessive thermal shock and stress that can result in damage to the device).
- Limit the temperature in the reflow stage to peak temperature indicated in Tables 1 thru 3.
- After completing the soldering process, allow the devices to cool naturally for at least 3 minutes. Gradual cooling should be used, as the use of forced cooling will increase the temperature gradient and may result in latent failure due to mechanical stress.
- Avoid any mechanical stress or shock to the solder joints and devices during cooling.

## Surface Mounting Instructions

Rev. V6

**Table 1. Reflow Conditions**

Profile Feature	Sn-Pb Eutectic Assembly	Pb-Free Assembly
<b>Preheat/Soak</b> Temperature Min ( $T_{S_{min}}$ ) Temperature Max ( $T_{S_{max}}$ ) Time ( $t_s$ ) from ( $T_{S_{min}}$ to $T_{S_{max}}$ )	100°C 150°C 60 - 120 seconds	150°C 200°C 60 - 120 seconds
Ramp-Up Rate ( $T_L$ to $T_p$ )	3°C/second max.	3°C/second max.
Liquidous temperature ( $T_L$ ) Time ( $t_L$ ) maintained above $T_L$	183°C 60 - 150 seconds	217°C 60 - 150 seconds
Peak package body temperature ( $T_p$ )	For users $T_p$ must not exceed the Classification temperature in Table 2  For suppliers $T_p$ must not exceed the Classification temperature in Table 2	For users $T_p$ must not exceed the Classification temperature in Table 3  For suppliers $T_p$ must not exceed the Classification temperature in Table 3
Time ( $t_p$ )* within 5 °C of the specified Classification temperature ( $T_C$ ), see reflow profile	20* seconds	30* seconds
Ramp-Down Rate ( $T_p$ to $T_L$ )	6°C/second max.	6°C/second max.
Time 25°C to Peak Temperature	6 minutes max.	8 minutes max.

\* Tolerance for peak profile temperature ( $T_p$ ) is defined as a supplier minimum and a user maximum

**Note 1:** All temperatures refer to the center of the package, measured on the package body surface that is facing up during assembly reflow (e.g., live-bug). If parts are reflowed in other than the normal live-bug assembly reflow orientation (i.e., dead-bug),  $T_p$  shall be within  $\pm 2$  °C of the live-bug  $T_p$  and still meet the  $T_C$  requirements, otherwise, the profile shall be adjusted to achieve the latter. To accurately measure actual peak package body temperatures refer to JEP140 for recommended thermocouple use.

**Note 2:** Reflow profiles in this document are for classification/preconditioning and are not meant to specify board assembly profiles. Actual board assembly profiles should be developed based on specific process needs and board designs and should not exceed the parameters in Table 1

For example, if  $T_C$  is 260 °C and time  $t_p$  is 30 seconds, this means the following for the supplier and the user.

For a supplier: The peak temperature must be at least 260 °C. The time above 255 °C must be at least 30 seconds.

For a user: The peak temperature must not exceed 260 °C. The time above 255 °C must not exceed 30 seconds.

**Note 3:** All components in the test load shall meet the classification profile requirements.

**Note 4:** SMD packages classified to a given moisture sensitivity level by using Procedures or Criteria defined within any previous version of J-STD-020, JESD22-A112 (rescinded), IPC-SM-786 (rescinded) do not need to be reclassified to the current revision unless a change in classification level or a higher peak classification temperature is desired.

**Table 2. SnPb Eutectic Process - Classification Temperature ( $T_C$ )**

Package Thickness	Volume mm <sup>3</sup> <350	Volume mm <sup>3</sup> ≥350
<2.5 mm	235°C	220°C
≥2.5 mm	220°C	220°C

Surface Mounting Instructions

Rev. V6

Table 3 Pb-Free Process - Classification Temperature ( $T_c$ )

Package Thickness	Volume mm <sup>3</sup> <350	Volume mm <sup>3</sup> 350-2000	Volume mm <sup>3</sup> >2000
<1.6 mm	260°C	260°C	260°C
1.6 mm-2.5 mm	260°C	250°C	245°C
>2.5 mm	250°C	245°C	245°C

**Note 1:** At the discretion of the device manufacturer, but not the board assembler/user, the maximum peak package body temperature ( $T_p$ ) can exceed the values specified in Tables 2 or 3. The use of a higher  $T_p$  does not change the classification temperature ( $T_c$ ).

**Note 2:** Package volume excludes external terminals (e.g., balls, bumps, lands, leads) and/or nonintegral heat sinks.

**Note 3:** The maximum component temperature reached during reflow depends on package thickness and volume. The use of convection reflow processes reduces the thermal gradients between packages. However, thermal gradients due to differences in thermal mass of SMD packages may still exist.

**Note 4:** Moisture sensitivity levels of components intended for use in a Pb-free assembly process **shall** be evaluated using the Pb-free classification temperatures and profiles defined in Tables 1 and 3, whether or not Pb-free.

**Note 5:** SMD packages classified to a given moisture sensitivity level by using Procedures or Criteria defined within any previous version of J-STD-020, JESD22-A112 (rescinded), IPC-SM-786 (rescinded) do not need to be reclassified to the current revision unless a change in classification level or a higher peak classification temperature is desired

Figure 1. Reflow Profile

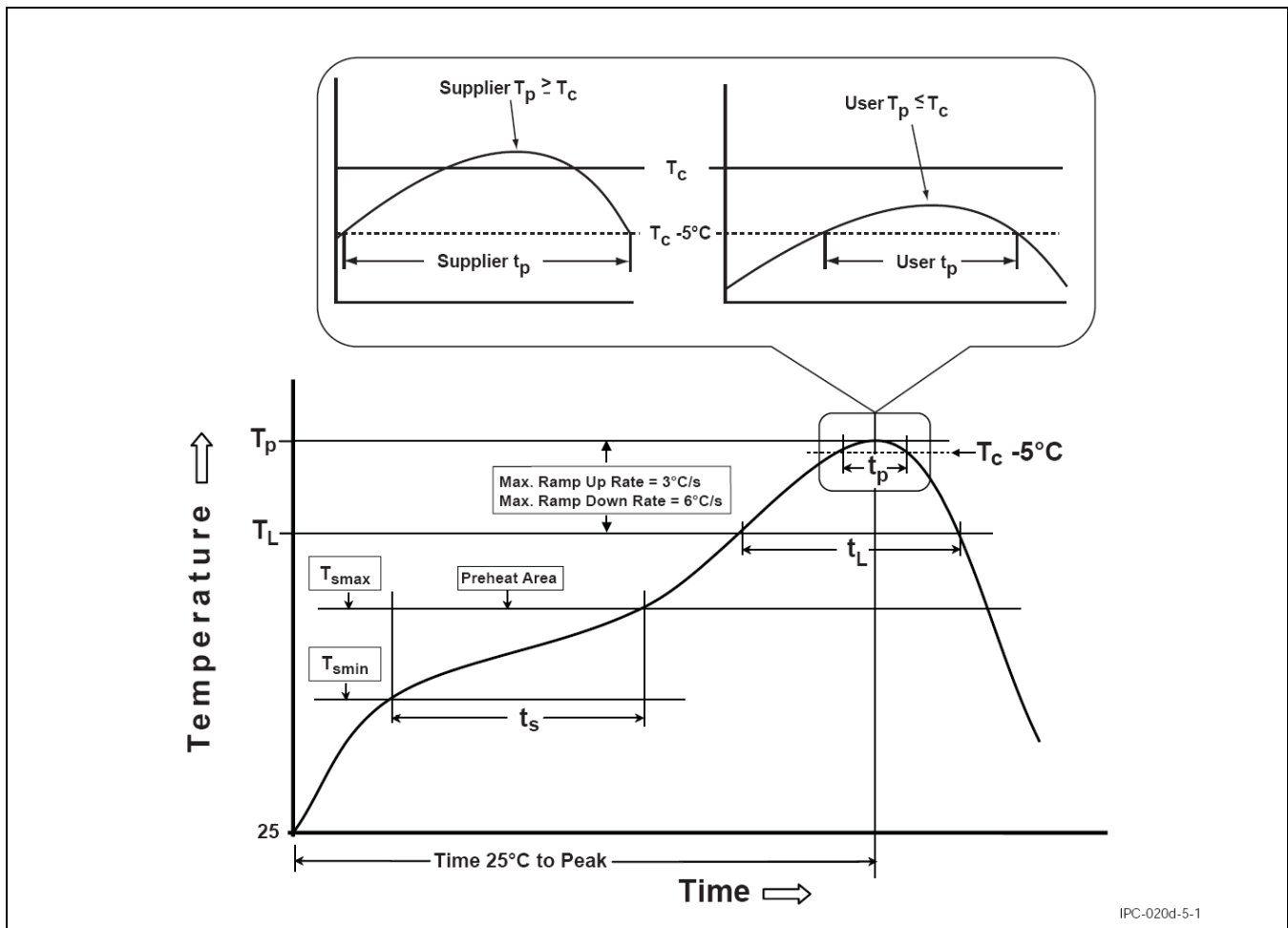

IPC-020d-5-1