

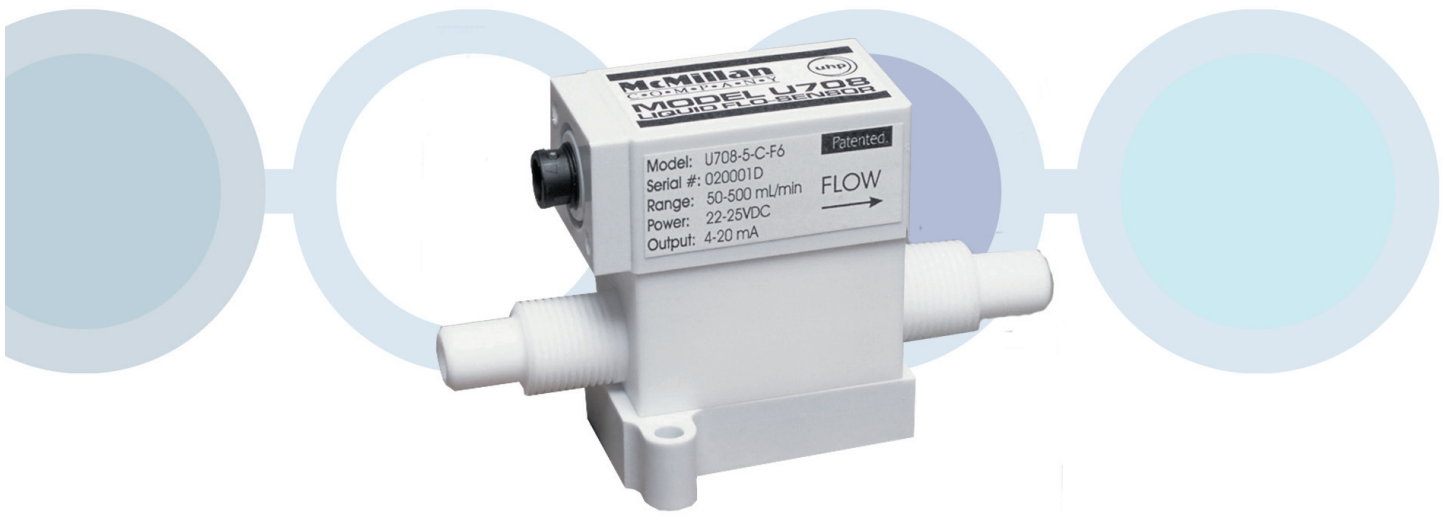

Compact Liquid Flow Rate Meters for UHP Applications

Model U707 & U708 MICROTURBINE LIQUID FLO-SENSORS®



UHP LIQUID

APPLICATION IDEAS

Flow rate monitoring to improve management of consumables

CMP slurry delivery closed-loop control

High and low flow rate alarm systems

Injection and dispensing systems



PRODUCT DESCRIPTION

McMillan Model U707 & U708 UHP FLO-SENSORS® will precisely measure flow rates of virtually any fluid as low as 15 mLpm or as high as 10 Lpm. Repeatable results are achieved by using a patented* microturbine flow sensor design. This design, unlike traditional paddlewheel designs, provides accurate flow measurement with no particle generation. PTFE, perfluoroelastomers, and sapphire wetted parts ensure compatibility with chemicals commonly found in microelectronics manufacturing processes, including deionized water, CMP slurries, acids, solvents, and photoresist.

These UHP FLO-SENSORS integrate the sensing element with advanced electronics to provide output signals proportional to flow rate. Each unit is individually calibrated before shipment, and a certificate of calibration accompanies all FLO-SENSORS. A repeatability specification of $\pm 0.2\%$ full scale reassures process engineers of consistent results.

PRINCIPLE OF OPERATION

The Model U707 Liquid FLO-SENSOR for UHP applications provides a proportional pulse output based on volumetric flow rate. The Model U708 Liquid FLO-SENSOR provides an analog output.

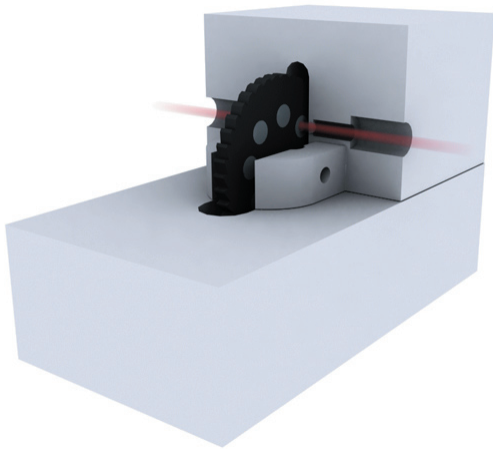

Figure 1. Cutaway of sensor technology.

McMillan's patented* microturbine wheel technology utilizes the Pelton turbine wheel concept. This design allows for use of a miniature microturbine wheel about 0.8 inches (20 mm) in diameter. The wheel is supported on a very small sapphire shaft, held in position by two sapphire bearings. Due to the low mass of both the wheel and the shaft, the microturbine wheel virtually floats in the liquid. This flotation effect causes the turbine wheel to be suspended in the middle of the bearings and thus eliminates shaft and bearing wear. Therefore, no particles are generated

As flow passes through the FLO-SENSOR, it is directed onto the very small teeth of the wheel using a precision-machined nozzle. This nozzle is sized according to the flow range of the unit. The rotational speed of the turbine wheel increases proportionally to the volumetric flow rate.

The microturbine wheel features 8 small windows, evenly spaced around the center of the wheel. As the wheel rotates, a light beam is projected through a PTFE window and onto the wheel. A light detector on the other side of the wheel detects each window and translates those signals into pulses. As the wheel spins faster, pulse rate increases. When the wheel stops (under zero flow conditions), no pulses are generated. Consequently, zero drift is not possible and zero adjustments are never required. Processing circuitry provides analog or pulse outputs that are linearly proportional to the flow rate.

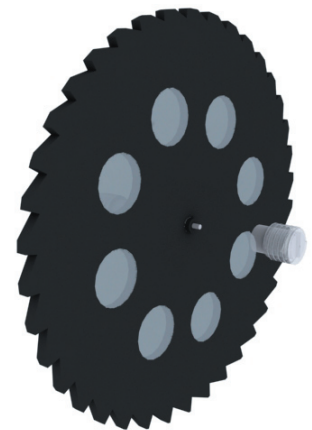

Figure 2: Wheel and bearing assembly.



* US Patents 4,467,660; 5,542,302; 5,728,949. Other patents pending.

FEATURES AND OPTIONS

FLOW RANGES

Flow ranges from 15-100 mLpm up to 1,000-10,000 mLpm are available. Consult the factory for custom requirements.

POWER

Units may be specified to operate with either 12 VDC or 24 VDC power. Various power adapters are available for use with 12 VDC versions.

SIGNAL OUTPUTS

The Model U707 features a pulse output, typically 0-400 Hz (consult calibration certificate for exact frequency output). The Model U708 can be ordered with a 4-20 mA, 0-5 VDC, or 0-10 VDC output.

ACCURACY/LINEARITY

Analog output models have an accuracy specification of $\pm 1.0\%$ full scale (including linearity). Pulse output models have an accuracy specification of $\pm 3.0\%$ full scale (including linearity).

CALIBRATION

All units are calibrated at the factory using deionized water. Calibration curves may be requested for fluids with viscosities differing from water.

FLUID CONNECTIONS

All units have male Flaretek[®]-compatible connections. Non-standard connection types may be available upon request.

ELECTRICAL CONNECTIONS

All units have an integrated 7-pin connector. Several mating cable options are available.

WETTED MATERIALS

All units have only PTFE, perfluoroelastomers, and sapphire as wetted parts.

DISPLAYS

McMillan has a comprehensive range of remote displays for use with UHP FLO-SENSORS. Please request further information from the factory.

GANGS OF MULTIPLE UNITS

To reduce overall footprint in multiple-channel applications, McMillan can assemble custom gangs of U707/U708 FLO-SENSORS and assign a custom part number for the entire assembly. Please request details from the factory.

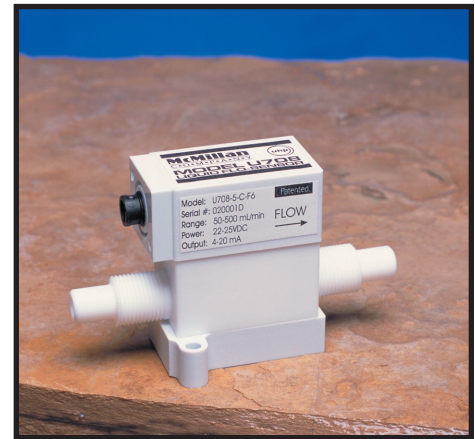

Model U708 FLO-SENSOR

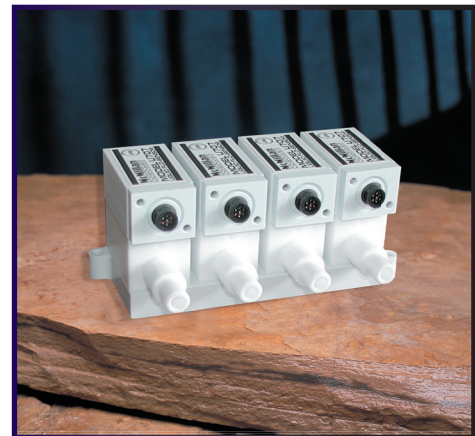

Gang of Multiple U707 FLO-SENSORS (custom)

SPECIFICATIONS

	U707	U708
Accuracy (including linearity, best fit straight line)	±3.0% Full Scale	±1.0% Full Scale
Repeatability	±0.2% Full Scale	
Pressure Rating	80 psig (5.4 bar) working 100 psig (6.8 bar) overpressure	
Temperature Rating (Fluid)	Standard: 0 to 55°C "HT" Suffix: 0 to 90°C	
Temperature Rating (Environmental)	Operating: 0 to 50°C Storage: 0 to 70°C	
Wetted Materials	PTFE Sapphire	
O-Ring Material	Perfluoroelastomer*	
Exterior Surfaces	PTFE Polypropylene Epoxy Viton® Polyester	
Fitting Material (Optional)	Perfluoroelastomer*	
Recommended Filtration	20 microns or less	
Compatible Fluids	Low viscosity (<10 cS) Translucent or Transparent Minimum amount of entrained air	
Pulse Output	Square-wave Collector output Pulls up to V+	N/A
0-5 VDC Output	N/A	Optional 0 VDC at zero flow 2.5 Kohm or greater load output Not isolated
0-10 VDC Output	N/A	Optional 0 VDC at zero flow 5 Kohm or greater load output Not isolated
4-20 mA Output Signal	N/A	Optional 4 mA at zero flow 500 ohm maximum current loop Not isolated
Zero Drift	None	
Warm-Up Time	None	
Calibration Interval	Calibration should typically be verified once every 12 months	
Power Requirements	12-15 VDC Units: 12-15 VDC, 50 mA typical 15-25 VDC Units: 15-25 VDC, 75 mA typical 22-25 VDC Units: 22-25 VDC, 50 mA typical	
Electrical Connections	7-pin connector PTFE housing when used with CFx cables Nylon housing when used with CPx cables	
Response Time	Typically <300 milliseconds for 97% of final value	Typically <1 second for 97% of final value
Reliability	100,000 Hours MTBF (testing ongoing)	
Certifications	CE Approved 89/336/EEC (EN 55011 & EN 50082-1) 73/23/EEC Low Voltage Directive	
Ratings	IP64 (NEMA 4X)	

* contact factory for current compound



ORDERING INFORMATION

Form part number: (Model Code) - (Flow Range)-(Power/Signal) - (Fittings) - (Options) - (Mating Cable).	Code	U707	U708
U707 UHP Liquid FLO-SENSOR® U708 UHP Liquid FLO-SENSOR®	U707 U708	✓	✓
Flow Range (mLpm of H ₂ O) Code 15-100 20-200 50-500 100-1000 200-2000 500-5000 1000-10000	3 4 5 6 7 8 9	✓ ✓ ✓ ✓ ✓ ✓ ✓	✓ ✓ ✓ ✓ ✓ ✓ ✓
Power / Signal Configuration 12-15 VDC Power / Pulse Output 22-25 VDC Power / Pulse Output 12-15 VDC Power / 0-5 VDC Output 22-25 VDC Power / 0-5 VDC Output 12-15 VDC Power / 0-10 VDC Output 22-25 VDC Power / 0-10 VDC Output 15-25 VDC Power / 4-20 mA Output	A E D B K J C	✓ ✓ ✓	 ✓ ✓ ✓ ✓ ✓
Fittings (see Fitting Chart for available sizes based on flow range) 1/4" male flare (Flaretek® compatible) 3/8" male flare (Flaretek® compatible)	F4 F6	✓ ✓	✓ ✓
Options High Temperature Operation Include Pair of PVDF Flare Nuts	HT FN	✓ ✓	✓ ✓
Mating Cable None (not recommended) FEP-jacketed, splashproof, 3 feet long (0.92 m) FEP-jacketed, splashproof, 6 feet long (1.85 m) FEP-jacketed, splashproof, 12 feet long (3.7 m) FEP-jacketed, splashproof, 25 feet long (7.7 m) PVC-jacketed, 6 feet long (1.85 m) PVC-jacketed, 12 feet long (3.7 m)	C0 CF3 CF6 CF12 CF25 CP6 CP12	✓ ✓ ✓ ✓ ✓ ✓ ✓	✓ ✓ ✓ ✓ ✓ ✓ ✓
ACCESSORIES Power Adapters (Order Separately) 115 VAC Power Adapter for 15 VDC models 230 VAC Power Adapter for 15 VDC models	108-10-08 108-10-18	✓ ✓	✓ ✓
Displays (Order Separately, More Information Available) 210R Rate Display, 3½ digit, 5-30 VDC Power 220 Rate/Total Display, 8 digit, battery powered 250 Multi-Function Display, 115 VAC Power 250E Multi-Function Display, 230 VAC Power 251 Multi-Function Display, 115 VAC Power 251E Multi-Function Display, 230 VAC Power	210R 220 250 250E 251 251E	 ✓ ✓ ✓	 ✓ ✓ ✓

Example #1:

U707-3-A-F4-HT-CF6 would give you a U707 FLO-SENSOR rated for 15-100 mLpm. The power required would be 12-15VDC, and the output would be pulse. Fluid connections would be ¼" male flare fittings. The maximum fluid operating temperature would be 90°C, and a FEP-jacketed 6 foot (1.85 m) cable would be included.

Example #2:

U708-9-C-F6-CF3 would include a U708 FLO-SENSOR rated for 1,000-10,000 mLpm. 15-25 VDC power would be required, and a 4-20 mA output would be provided. Fluid connections would be 3/8" male flare. A FEP-jacketed 3 foot (0.92 m) cable would be included.



FITTING CHART

Flow Range	F4	F6
3	✓	✓
4	✓	✓
5	✓	✓
6	✓	✓
7		✓
8		✓
9		✓

PRESSURE DROP

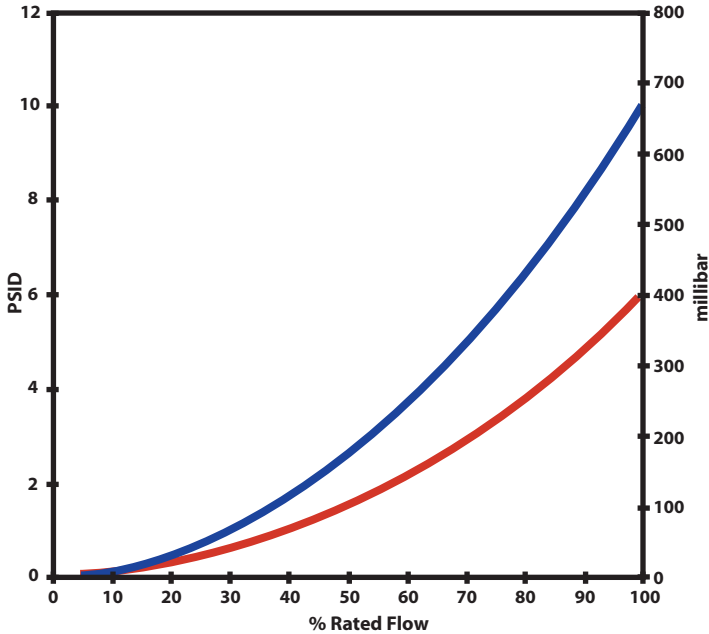

■ Typical Pressure Drop, all other ranges
■ Typical Pressure Drop, range 6

DIMENSIONS

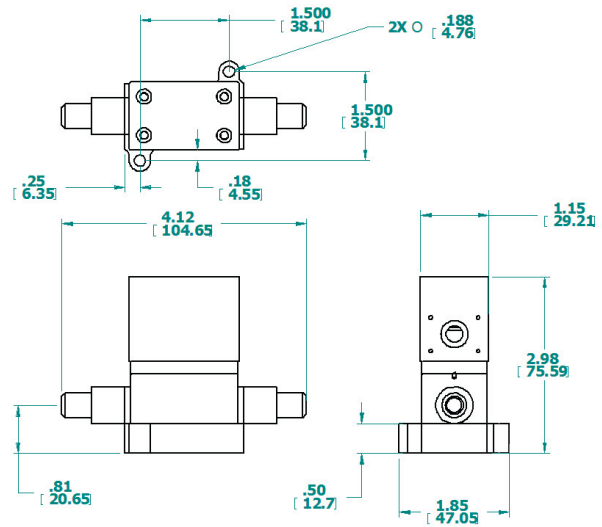

Dimensions shown are in inches(mm). All dimensions shown are for Model U708 FLO-SENSOR with 3/8" male flare fittings (F6) and are similar for other models. Please note that U707 units are shorter (less height) than U708 units. Specific model dimensional drawings may be requested from the factory.

McMillan Company
P.O. Box 1340
Georgetown, Texas 78627

Toll-Free: 800.861.0231 (U.S.A. only)
Direct: 512.863.0231
Fax: 512.863.0671



Viton – Reg TM E.I. DuPont Dow Elastomers LLC
 FLO-SENSOR – Reg TM McMillan Co
 Flaretek – Reg TM Entegris, Inc.

Bulletin U707-S001

Specifications subject to change without notice.

© Copyright 2004 McMillan Company. All rights reserved. Printed in the U.S.A.

Email: sales@mcmflow.com
Website: www.mcmflow.com

