

# SG-Link<sup>®</sup>-LXRS<sup>®</sup>

Wireless 2 Channel Analog Input Sensor Node

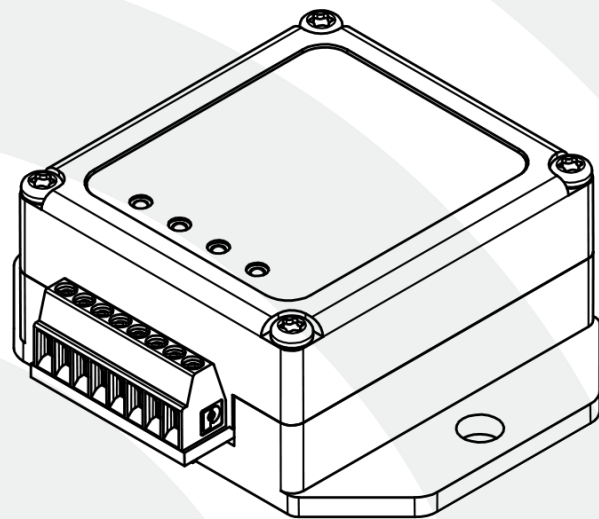



**LORD MicroStrain®**  
SENSING SYSTEMS

MicroStrain® Sensing Systems  
459 Hurricane Lane  
Suite 102  
Williston, VT 05495  
United States of America

**Phone:** 802-862-6629

**Fax:** 802-863-4093

<http://www.microstrain.com>  
[sensing\\_support@LORD.com](mailto:sensing_support@LORD.com)  
[sensing\\_sales@LORD.com](mailto:sensing_sales@LORD.com)

Copyright © 2015 LORD Corporation

3DM®, 3DM-DH®, 3DM-DH3™, 3DM-GX1®, 3DM-GX2®, 3DM-GX3®, 3DM-GX4-15™, 3DM-GX4-25™, 3DM-GX4-45™, 3DM-GX4™, 3DM-RQ1™, 3DM-GQ4™, AIFP®, Ask Us How™, Bolt-Link®, DEMOD-DC®, DVRT®, DVRT-Link™, DEMOD-DVRT®, EH-Link®, EmbedSense®, ENV-Link™, FAS-A®, G-Link®, G-Link2™, HS-Link®, IEPE-Link™, Inertia-Link®, Little Sensors, Big Ideas.®, Live Connect™, LXRS®, MathEngine®, MicroStrain®, MVEH™, MXRS®, Node Commander®, PVEH™, RHT-Link®, RTD-Link™, SensorCloud™, SG-Link®, Shock-Link™, Strain Wizard®, TC-Link®, Torque-Link™, V-Link®, Watt-Link™, Wireless Simplicity, Hardwired Reliability™, and WSDA® are trademarks of LORD Corporation.

Document 8500-0003 Revision E

Subject to change without notice.

## Table of Contents

<b>1. Wireless Sensor Network Overview</b> .....	<b>7</b>
<b>2. Node Overview</b> .....	<b>8</b>
2.1 Components List .....	9
2.2 Interface and Indicators .....	10
2.3 Node Operational Modes .....	11
<b>3. System Operational Overview</b> .....	<b>12</b>
3.1 Software Installation .....	13
3.2 System Connections .....	14
3.3 Gateway USB Communication .....	15
3.4 Connect to Nodes .....	16
3.4.1 Adding a Node by Address .....	16
3.4.2 Using Node Discovery .....	17
3.5 Channel Configuration .....	18
3.6 Sampling Settings .....	20
3.7 Data Acquisition .....	21
3.8 Data Handling .....	26
3.8.1 Connecting to SensorCloud™ .....	27
3.8.2 Sensor Data Files .....	30
<b>4. Node Installation</b> .....	<b>31</b>
4.1 Mounting Recommendations .....	31
4.2 Optimizing the Radio Link .....	32
4.2.1 Range Test .....	33
<b>5. Connecting Sensors</b> .....	<b>34</b>
5.1 Sensor Requirements .....	34

5.2	Wiring Recommendations .....	35
5.3	Sensor Power .....	36
5.4	Node Channels Designations .....	36
5.5	Terminal Block Connections .....	37
5.6	Pin Descriptions .....	38
5.7	Differential Input Channels .....	39
5.7.1	<i>Differential Sensors</i> .....	40
5.7.2	<i>Measuring Small Voltages</i> .....	42
5.8	Single-Ended Input Channels .....	43
5.8.1	<i>0 to 3 V dc Voltage Measurements</i> .....	44
5.8.2	<i>Measuring Voltages over Three Volts</i> .....	45
5.8.3	<i>Measuring Small Currents (4 to 20mA Sensors)</i> .....	46
5.9	Using the Excitation Output as a Switch .....	47
5.10	Thermocouples .....	47
5.11	On-board Temperature Sensor .....	48
<b>6.</b>	<b>Sensor Settings</b> .....	<b>49</b>
6.1	Measurement Units .....	51
6.2	Sensor Conversion Values .....	52
6.2.1	<i>Calculating a Linear Slope</i> .....	55
6.2.2	<i>Differential Input Gain and Offset</i> .....	57
6.2.2.1	<i>Example Gain and Offset Calculations</i> .....	58
6.3	Sensor Calibration .....	59
6.3.1	<i>EXAMPLE: Lab or Field Calibration</i> .....	61
6.3.2	<i>EXAMPLE: Manufacturer Calibration</i> .....	65
6.3.3	<i>EXAMPLE: Internal Shunt Calibration</i> .....	67

---

<b>7. Powering the Node</b>	<b>72</b>
7.1 Selecting the Power Source	73
7.2 Using the Internal Node Battery	74
7.3 Charging the Node Battery	75
7.4 Connecting an External Power Supply	76
<b>8. Troubleshooting</b>	<b>77</b>
8.1 Troubleshooting Guide	77
8.2 Device Status Indicators	82
8.3 Using the Node Tester Board	83
8.4 Updating Node Firmware	91
8.5 Repair and Calibration	93
8.6 Technical Support	94
<b>9. Maintenance</b>	<b>95</b>
<b>10. Parts and Configurations</b>	<b>96</b>
10.1 Standard Nodes	96
10.2 Node Accessories	97
10.3 Wireless System Equipment	98
10.4 Product Ordering	99
<b>11. Specifications</b>	<b>100</b>
11.1 Physical Specifications	100
11.2 Operating Specifications	101
11.3 Power Profile	103
11.4 Radio Specifications	104
<b>12. Safety Information</b>	<b>105</b>
12.1 Battery Hazards	105

---

12.2	User Configurable Power Settings .....	106
12.3	Power Supply .....	107
12.4	ESD Sensitivity .....	107
12.5	Disposal and Recycling .....	108
<b>13.</b>	<b>References</b> .....	<b>109</b>
13.1	Reference Information .....	109
13.2	Glossary .....	110

## 1. Wireless Sensor Network Overview

The LORD MicroStrain® Wireless Sensor Network is a high-speed, scalable, sensor data acquisition and sensor networking system. Each system consists of wireless sensor interface nodes, a data collection gateway, and full-featured user software platforms based on the LORD MicroStrain® Lossless Extended Range Synchronized (LXRS®) data communications protocol. Bidirectional wireless communication between the node and gateway enables sensor data collection and configuration from up to two kilometers away. Gateways can be connected locally to a host computer or remotely via local and mobile networks. Some gateways also feature analog outputs for porting sensor data directly to standalone data acquisition equipment.

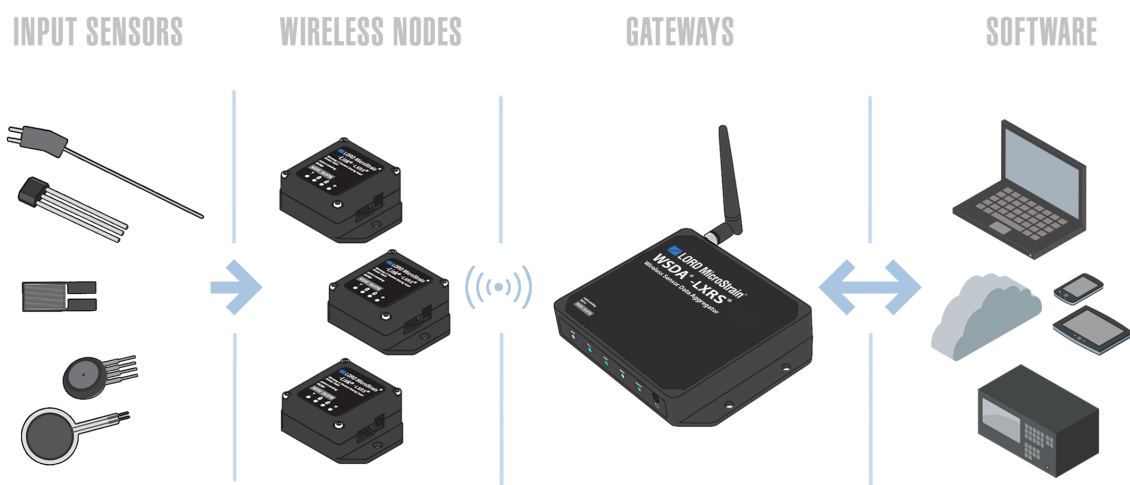

The selection of available nodes allows interface with many types of sensors, including accelerometers, strain gauges, pressure transducers, load cells, torque and vibration sensors, magnetometers, 4 to 20mA sensors, thermocouples, RTD sensors, soil moisture and humidity sensors, inclinometers, and orientation and displacement sensors. Some nodes come with integrated sensing devices such as accelerometers. System sampling capabilities are IEEE 802.15.4-compliant and include lossless synchronized sampling, continuous and periodic burst sampling, and data logging. A single gateway can coordinate many nodes of any type, and multiple gateways can be managed from one computer with the Node Commander® and SensorCloud™ software platforms. Integration to customer systems can be accomplished using OEM versions of the sensor nodes and leveraging the LORD MicroStrain® data communications protocol.

Common wireless applications of LORD MicroStrain® Sensing Systems are strain sensor measurement, accelerometer platforms, vibration monitoring, energy monitoring, environmental monitoring, and temperature monitoring.

## 2. Node Overview

The SG-Link<sup>®</sup>-LXRS<sup>®</sup> wireless sensor node features two analog input channels designed to accommodate a wide range of Wheatstone bridge and analog sensors including, strain, load cell, torque, pressure, acceleration, vibration, magnetic field, displacement, and geophones. There is one channel for single-ended sensor measurement, one channel for differential sensor measurement, and an on-board internal temperature sensor.

SG-Link<sup>®</sup>-LXRS<sup>®</sup> inputs are 12-bit resolution with  $\pm 0.1\%$  full scale measurement accuracy. The node can log data to internal memory, transmit real-time synchronized data, and it supports event driven triggers with both pre- and post- event buffers.

To acquire sensor data, the SG-Link -LXRS is used with a LORD MicroStrain data gateway such as the WSDA<sup>®</sup>-Base or WSDA<sup>®</sup> -1500 - LXRS<sup>®</sup>.



Figure 1 - SG-Link<sup>®</sup>-LXRS<sup>®</sup> Wireless Sensor Node



## 2.1 Components List

The SG-Link®-LXRS® features an internal antenna and an integrated terminal block for attaching sensors. There are no removable parts. For a complete list of available configurations, accessories, additional system products and ordering information [see Parts and Configurations on page 96](#).



Item	Description	Quantity
A	SG-Link®-LXRS® Wireless Sensor Node	1
--	User Manual, Quick Start Guide and Calibration Certificate	1 each

Table 1 - Components List

## 2.2 Interface and Indicators

The SG-Link®-LXRS® includes a power input jack for charging the internal battery or externally powering the node, a power on/off switch, a power source selector switch, terminal blocks for connecting sensing devices and power, and mounting holes for device installation. The radio frequency (RF) antenna is internal to the node.

The indicators on the SG-Link®-LXRS® include a device status indicator, a battery charging indicator, a completed charge indicator, and a charge source indicator. The following table describes basic indicator behavior. During data acquisition, the device status indicator has other sequences (*see Device Status Indicators on page 82*).

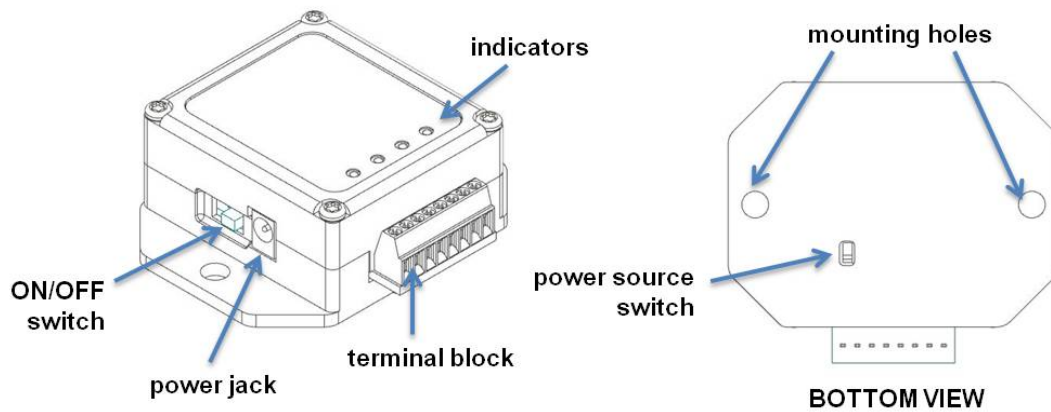

Figure 2 - Interface and Indicators





Indicator	Symbol	Behavior	Node Status
Battery charge source indicator		OFF	No power source detected
		ON green	Charging source detected
Battery charging indicator		OFF	Node not charging
		ON bright red	Node battery charging
Completed charge indicator		OFF	Node charge status unknown
		ON green	Battery fully charged
Device status indicator		OFF	Node OFF
		Rapid flashing	Node booting up
		1 second pulse	Node idle

Table 2 - Indicator Behaviors

### 2.3 Node Operational Modes

Sensor nodes have three operational modes: *active*, *sleep*, and *idle*. When the node is sampling it is in active mode. To stop sampling, the node is put into idle mode. Idle mode is used for configuring node settings (such as frequency and sampling rates) and is the only way to stop sampling or go between active and sleep modes. Sleep mode is an ultra low power mode. The node will automatically go into sleep mode after a user-settable period of inactivity. The node will not go into sleep mode while sampling.

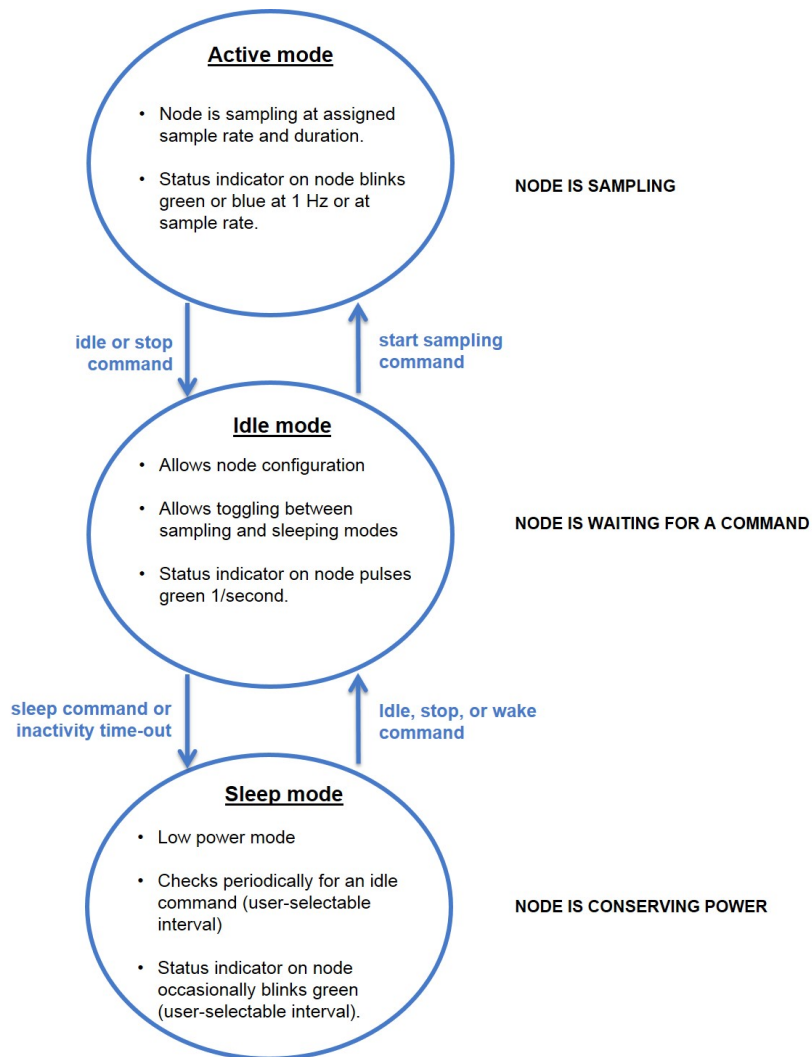

Figure 3 - Node Operational Modes

### 3. System Operational Overview

#### **WARNING**

The SG-Link®-LXRS® contains an internal, rechargeable Lithium Polymer (Li-Po) battery. For important precautions [see Safety Information on page 105](#).

#### **CAUTION**

The SG-Link®-LXRS® is susceptible to damage and/or disruption of normal operation from Electrostatic Discharge (ESD). For important precautions [see Safety Information on page 105](#).

To acquire sensor data, nodes are used with any LORD MicroStrain® data gateway, such as the WSDA®-Base-10x-LXRS® or WSDA®-1500-LXRS®, and a software interface.

LORD MicroStrain® has two software programs available for data acquisition from the wireless sensor network: SensorCloud™ and Node Commander®. SensorCloud™ is an optional web-based data collection, visualization, analysis, and remote management platform based on cloud computing technology. Node Commander® is used for configuring gateways and nodes, selecting sampling modes and parameters, initializing data acquisition, and viewing and saving data.

The operational overview describes system hardware and software setup, and the basic navigation of Node Commander® used to configure the node and begin data acquisition. A brief overview of porting data to SensorCloud™ is also included. This section is included as a quick start guide and is not a complete demonstration of all system and software capabilities.

- For an example of sensor configuration and a calibration routine, or for verification of system functionality, [see Using the Node Tester Board on page 83](#).
- For instructions on connecting specific sensors, [see Connecting Sensors on page 34](#).

**NOTE**

To maximize operating time, it is recommended that the SG-Link®-LXRS® internal battery be fully charged before installation. If fully discharged, it can take up to 8 hours. For charging instructions [see \*Charging the Node Battery on page 75\*](#).

**3.1 Software Installation**

To install Node Commander® Software Suite on the host computer, run the installer executable file and follow the on-screen prompts. The software is provided with all gateways and is available on the LORD MicroStrain® website ([see \*References on page 109\*](#)).

**NOTE**

The Node Commander® software includes hardware drivers required for use with USB gateways. Once installed, the software will automatically detect and configure any USB gateways that are plugged into the host computer.

The suite includes the following programs:

- **Node Commander** is used for configuring nodes and acquiring, viewing, and saving data.
- **Live Connect™** is a TCP/IP-to-serial conversion tool that translates the communications between Node Commander and an Ethernet gateway.
- **WSDA® Data Downloader** is used to download acquired data from the flash memory card embedded in an applicable gateway, to a host computer.

**SensorCloud™** is an optional data collection, visualization, analysis, and remote management tool. It is based on cloud computing technology and is accessed directly from a web connection. Automatic, real-time data collection is available through Ethernet gateways, such as the WSDA® -1500 - LXRS®. Data files can also be easily uploaded. For more information [see \*Data Handling on page 26\*](#).

Users can also design custom programs with the open source data communications protocol ([see \*References on page 109\*](#)).

### 3.2 System Connections

To acquire sensor data the following components are needed: user-supplied external sensors (as applicable), a LORD MicroStrain<sup>®</sup> wireless sensor node, a LORD MicroStrain<sup>®</sup> data gateway and a local or networked host computer with access to the data acquisition software (such as Node Commander<sup>®</sup> and SensorCloud<sup>™</sup>). For a connections overview refer to [Figure 4 - System Connections](#).

Nodes will communicate with any LORD MicroStrain<sup>®</sup> data gateway. The sensor, node, gateway, and software selection are application-dependent, but the basic interfaces are the same. Communication protocols between the gateway and host computer vary depending on which model gateway is used, but they all require interface to a host computer or network. The WSDA<sup>®</sup> -Base -10x-LXRS<sup>®</sup> gateway utilizes local serial connections to the host computer, such as RS232 and USB, and interfaces with the Node Commander<sup>®</sup> software. The WSDA<sup>®</sup> -1500 - LXRS<sup>®</sup> gateway utilizes Ethernet communications and can be used with Node Commander<sup>®</sup> and SensorCloud<sup>™</sup>, although system configuration is completed using Node Commander<sup>®</sup>. Gateways with analog outputs can be connected directly to stand-alone data acquisition devices for data collection, however system configuration will still occur through a USB interface to Node Commander<sup>®</sup>.

Users can also write custom programs by utilizing the LORD MicroStrain<sup>®</sup> Wireless Sensors Network Software Development Kit ([see References on page 109](#)).

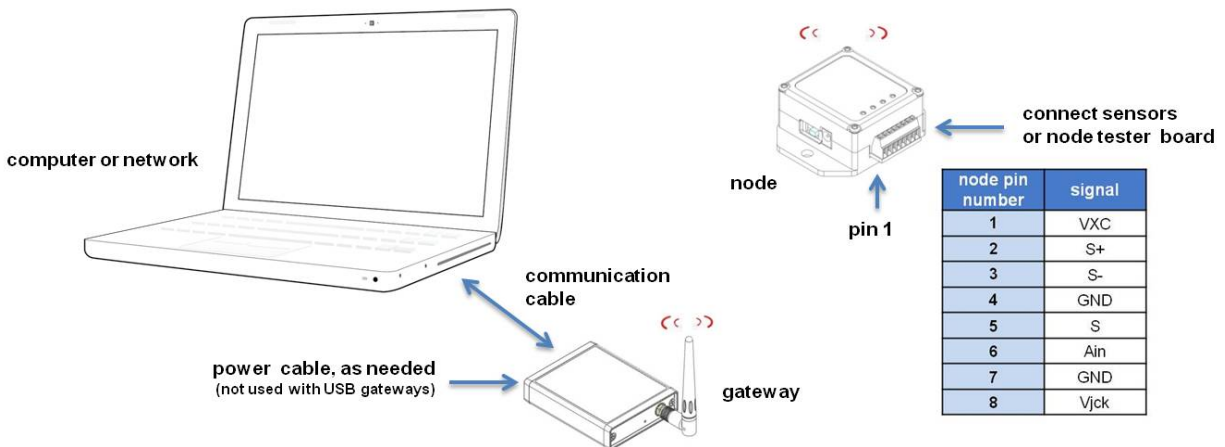

Figure 4 - System Connections

### 3.3 Gateway USB Communication

The WSDA-Base USB gateway is used as an example in this quick start guide. For information on how to use other gateways, refer to the gateway or Node Commander® user manual ([see References on page 109](#)).

Drivers for the USB gateways are included in the Node Commander® software installation. With the software installed, the USB gateway will be detected automatically whenever the gateway is plugged in.

1. Power is applied to the gateway through the USB connection. Verify the gateway status indicator is illuminated, showing the gateway is connected and on.

2. Open the Node Commander software.



3. The gateway should appear in the Controller window automatically with a communication port assignment ([Figure 5 - USB Gateway Communication](#)). If it is not automatically discovered, verify the port is active on the host computer, and then remove and re-insert the USB connector.

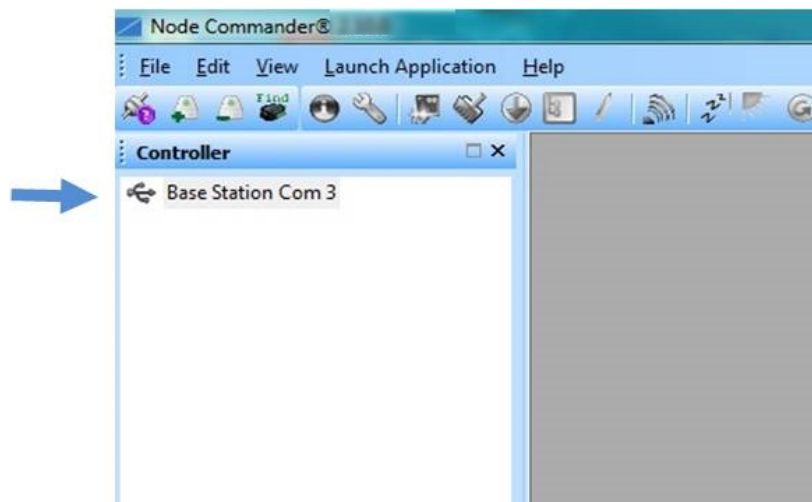

Figure 5 - USB Gateway Communication

### 3.4 Connect to Nodes

Several methods can be used in Node Commander® to establish communication with the nodes. This quick start section covers the two simplest methods; adding a node by address and by using the node discovery feature.

#### 3.4.1 Adding a Node by Address

Adding a node by address requires the node to be on the same communication frequency as the gateway. The node address and frequency are indicated in the documentation included with the node when it is purchased.

1. To add a node by address, right-click on the gateway name in the Controller window, and select Add Node > Add Single Node (*Figure 6 - Adding a Node by Address*).
2. The node address and frequency are indicated in the documentation included with the node. Enter the node address, and select OK. If the node is not found, a message will appear and provide the option to scan for the node on other frequencies. Alternately, the Node Discovery feature can be used.

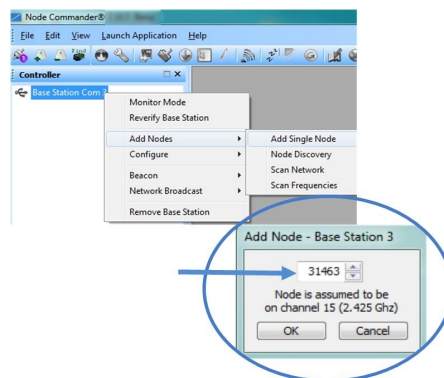

Figure 6 - Adding a Node by Address



### 3.4.2 Using Node Discovery

The Node Discovery feature allows connection between the gateway and node to occur even if they are on different frequencies. To connect to nodes using node discovery, begin by making sure the node is powered off.

#### NOTE

Automatic node discovery may not work in some boot-up modes. If the node is not in normal boot up mode, the assigned one can be bypassed to enable node discovery. For more information [see \*Troubleshooting Guide on page 77\*](#).

1. Right-click on the gateway name and select Add Node > Node Discovery ([Figure 7 - Using Node Discovery](#)).
2. Using the power switch, turn on the node. Within a few seconds, the node will transmit a message with its operating frequency.
3. When the device status indicator on the node ends the rapid flash sequence and begins pulsing at one-second intervals, the node has completed the normal boot-up sequence and is running in idle mode. At this point the node should be listed in the Controller window; scanning can be stopped by selecting the Stop button in the Node Discovery window.

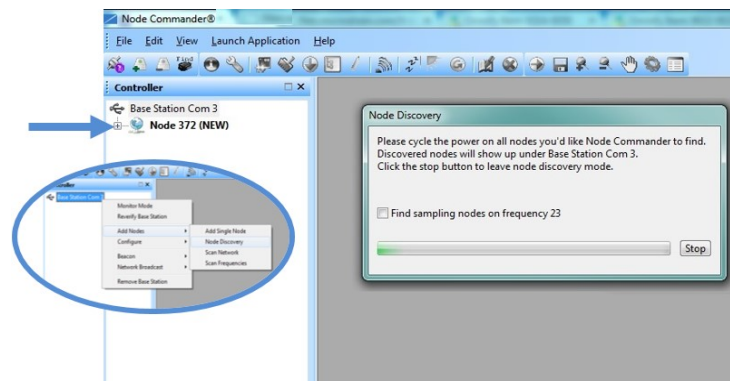

Figure 7 - Using Node Discovery

### 3.5 Channel Configuration

The sensor settings are stored in the node memory, and each sensor is assigned a corresponding channel number. The configuration menus will only show the channels and configuration options that are available for the type of node being used.

1. To enter the configuration menu, right-click on the node name, and select Configure > Configure Node. The Channels tab displays channel options available for the node.
  - a. **Channel Enabled:** indicates the sensor channel number. The check box is used to enable the channel and select it for sampling. The icon next to the check box describes the channel type inherent to the node being used. In the following example (*Figure 8 - Node Channels Menu*): a1) analog differential channel icon, a2) analog single ended channel icon, and a3) temperature channel icon.
  - b. **Current channel configuration:** The Data Output, Units, Input Range, and Label fields describe how the channel is currently configured.
  - c. **Configure:** The Configure button changes the channel parameters, such as measurement units, gain and offset settings, and calibration values. The channel must be enabled first by selecting the adjacent check box.

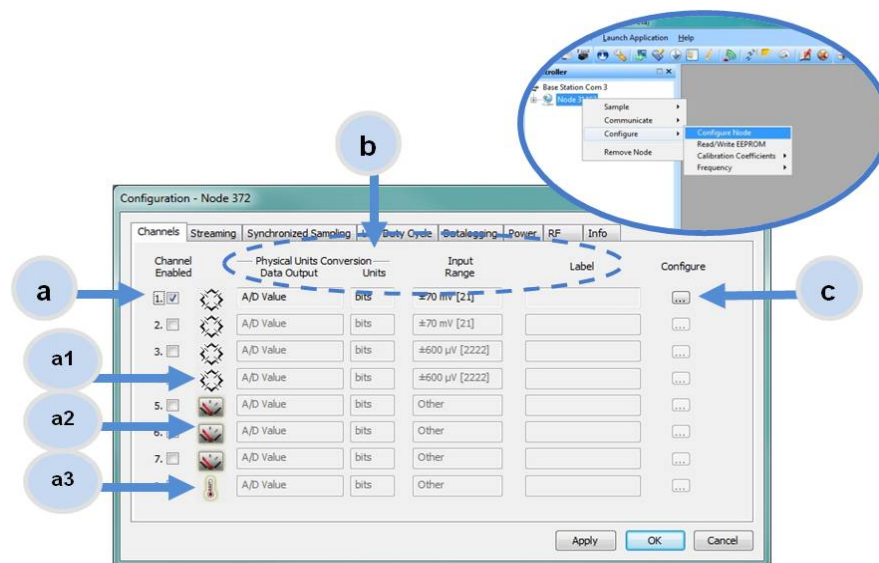

Figure 8 - Node Channels Menu

2. To enter the channel configuration menu, select the Configure button as shown in [Figure 8 - Node Channels Menu](#). The channel configuration menu options change depending on the sensor type selected.
  - a. **Channel Label:** names the channel
  - b. **Channel diagram:** shows channel electronics and data flow
  - c. **Conversion Coefficients:** defines the type and units of the measurement being made
  - d. **PGA Settings:** These settings determine what gain is applied to the sensor measurement and set the position of the no-load baseline measurement for the sensor signal. It is only available for differential input channels with gain amplifiers.
  - e. **Calibration values:** includes the slope, offset, scale, and formula used to convert the sensor reading to engineering units. The slope and offset can be determined from the sensor manufacturer calibration data or through a calibration process.

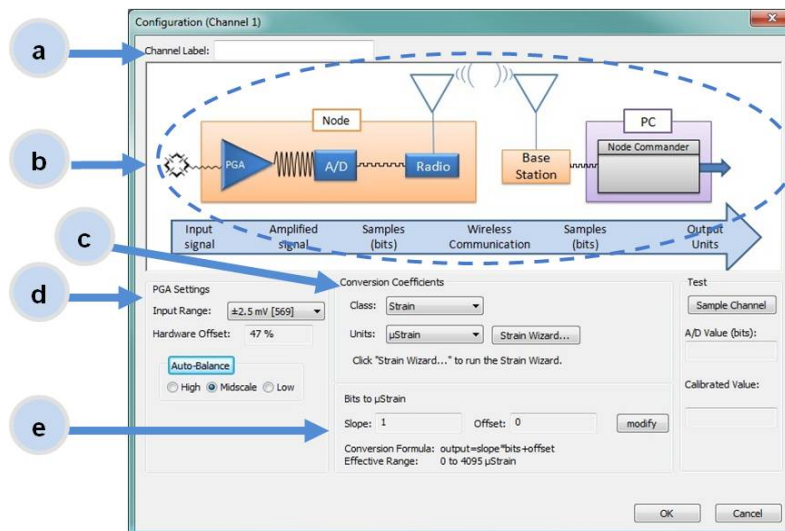
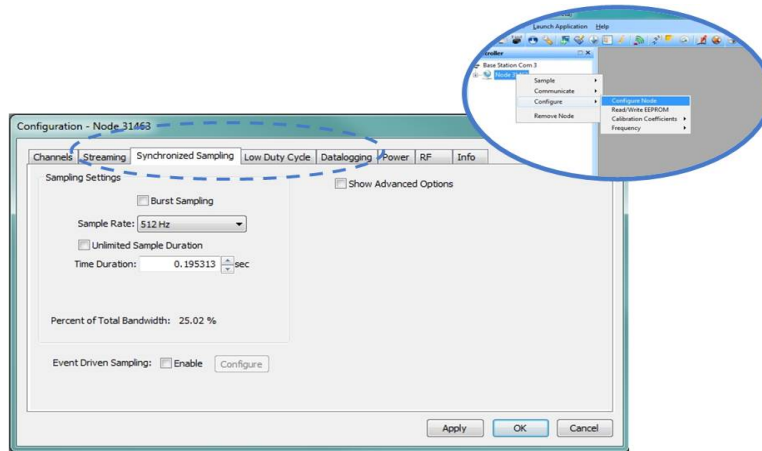

Figure 9 - Channel Setup

### 3.6 Sampling Settings

Sampling settings are accessed through the Configure Node menu. There is a tab for each sampling mode available for the particular node (*Figure 10 - Sample Settings Menu*). The SG-Link®-LXRS® has four primary sampling modes: Synchronized Sampling, Low Duty Cycle Sampling, Streaming, and Datalogging. Some modes have user-configurable settings for sample rate, sample duration, and datalogging. Other settings are automatic, depending on number of active channels and other variables. For more information on sampling modes, refer to the Node Commander user manual (*see References on page 109*).



**Figure 10 - Sample Settings Menu**

In general, when determining what sample mode and rate is most suitable for the application, refer to the following guidelines;

- Use a sample rate at least twice the value of the target measurement frequency. This is the minimum sample rate required to produce an accurate digital representation of the measured signal. The higher the sample rate, the more accurate the digital representation.
- Using the minimum required sample rate will increase battery life and minimize the allocated network bandwidth.
- Using periodic burst sampling in place of continuous sampling will increase battery life, and the longer the sample interval, the more power and network bandwidth will be saved.

For synchronized sampling, use the online calculator to evaluate network bandwidth at different sampling settings :

<http://www.microstrain.com/configure-your-system>

### 3.7 Data Acquisition

When data acquisition is started, each of the sampling modes has different menu options and views. Some open a settings menu before data acquisition begins and may include a data list view and/or a graph view. The following is an example of Synchronized Sampling ([Figure 11 - Starting a Sampling Session](#)). For more information about synchronized sampling and using the gateway beacon [see Data Acquisition on page 21](#). For more information about other sampling modes, refer to the Node Commander® user manual. ([see References on page 109](#)).

To start a sampling session, nodes can be selected individually or as a group. When selected as a group, they will all be set to the same sampling mode. Right-click on the nodes and select Sample > Synchronized Sampling.

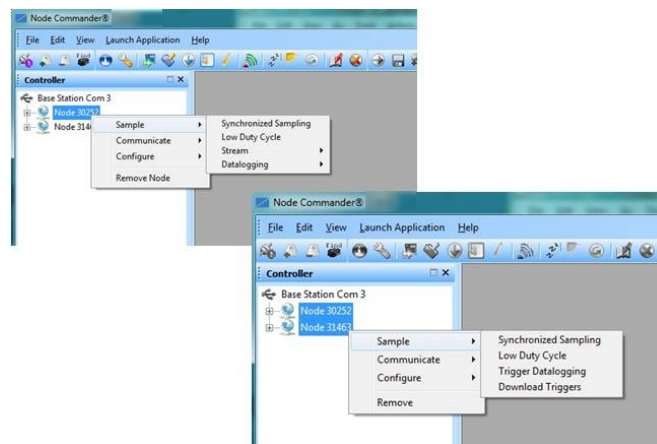

**Figure 11 - Starting a Sampling Session**

When a synchronized sampling session is started, the sampling menu appears and includes settings to enable optional sampling features, configure nodes, and to specify where the data will be saved. The built-in bandwidth calculator displays the total bandwidth used by the nodes selected for synchronized sampling ([Figure 12 - Synchronized Sampling Menu](#)).

- a. **Save Location:** indicates where the data file will be saved on the host computer. Use the Browse button to select a location.
- b. **Node configuration:** includes the node serial number, sampling settings, bandwidth calculation, and current status. Highlight any node or group of nodes, and the Remove, Configure, and Refresh buttons become active. The Configure

button opens the node configuration menus to adjust settings as needed and recalculates the node bandwidth. Multiple nodes can be configured together by using the Shift or Ctrl key to select them.

- c. **Lossless:** enables the lossless data protocol. The protocol enables buffering and retransmission of data in order to provide 100% data collection success. Using this feature may increase data display latency.

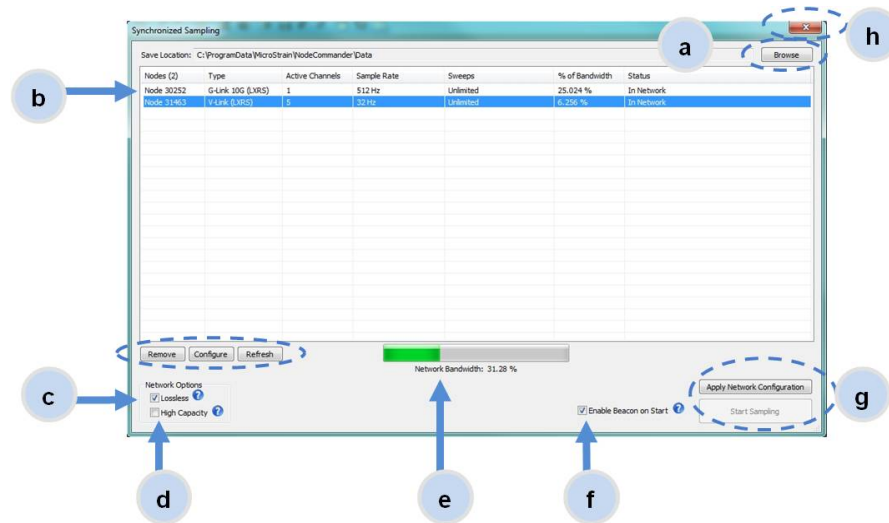
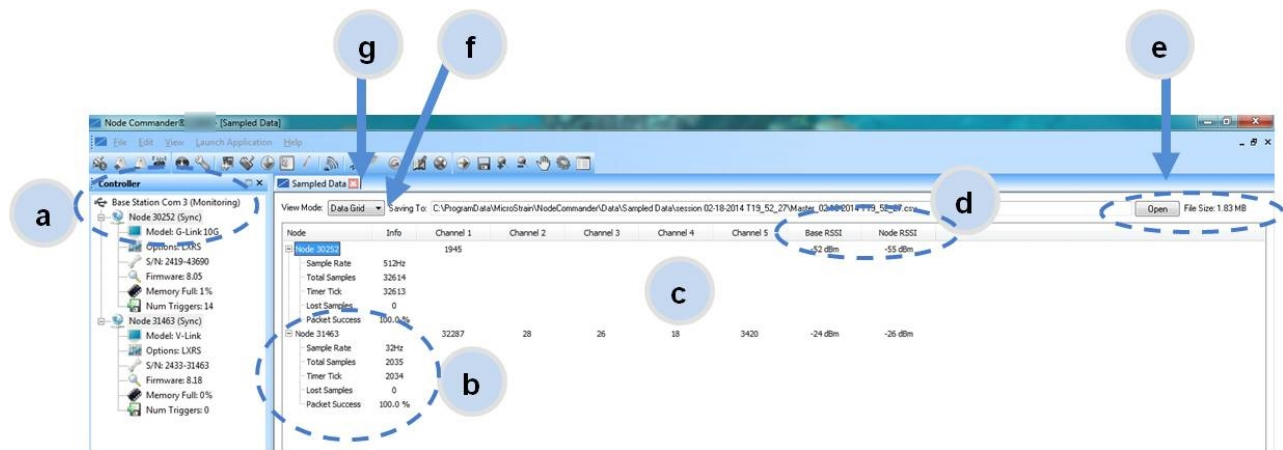

**Figure 12 - Synchronized Sampling Menu**

- d. **High Capacity:** optimizes bandwidth and power use for nodes with slower sample rates by reducing the transmit rates. May increase data latency.
- e. **Network Bandwidth:** is the total calculated bandwidth used by all the nodes. The bandwidth changes as nodes are added, removed. and settings changed.
- f. **Enable Beacon on Start:** When synchronized sampling is started the nodes wait for the first beacon transmission to initiate sampling. When this option is selected (default), the gateway beacon is enabled and will begin transmitting at a fixed interval when sampling is started. Disabling the beacon on start (unchecking the box) will set the nodes to wait for the beacon, but it does not actually start the beacon when sampling is started. This can be used if there is a need for sampling to be initiated later, or if the beacon is being received from another source than the gateway. Enabling the beacon in this way is the same as enabling the beacon in the gateway menu Refer to the Node Commander® User Manual for more information.

- g. **Apply settings and start sampling:** Before acquisition can begin, use the Apply Network Settings to save the session settings to the node. When completed, select Start Sampling to begin.
- h. **Close sampling window** (with the red "X") to exit sampling or, once the sampling has been started, to view the data window behind it.

Synchronized sampling features two data views: Grid view and Graph view. Once sampling has started, the data grid view is the default view ([Figure 13 - Synchronized Sampling Data View](#)).



**Figure 13 - Synchronized Sampling Data View**

- a. **Device status:** Node sampling mode and gateway status are displayed in parentheses next to the device name.
- b. **Node information:** includes node serial number and sampling statistics. Right-click on the node name for more menu options such as Stop Nodes.
- c. **Data:** is a display of the sampled data with each channel in its own column.
- d. **Radio strength:** indicates the strength of the communication between the gateway and node. [See Range Test on page 33.](#)
- e. **Data file:** the location and size of the data file, as data is added. View the data in .CSV format with the Open File button.
- f. **View menu:** Select between Data Grid and Graph views.
- g. **End sampling:** The red "X" is used to exit the sampling window and/or end sampling.

**NOTE**

When synchronized sampling is set to slower sample rates it may take several seconds after sampling is initiated for the first sample to appear.

Use the view menu to select the Graph view of the data (*see Synchronized Sampling Graph View on page 24*). Click on the node name to view the graph for that node. Click again to hide it.

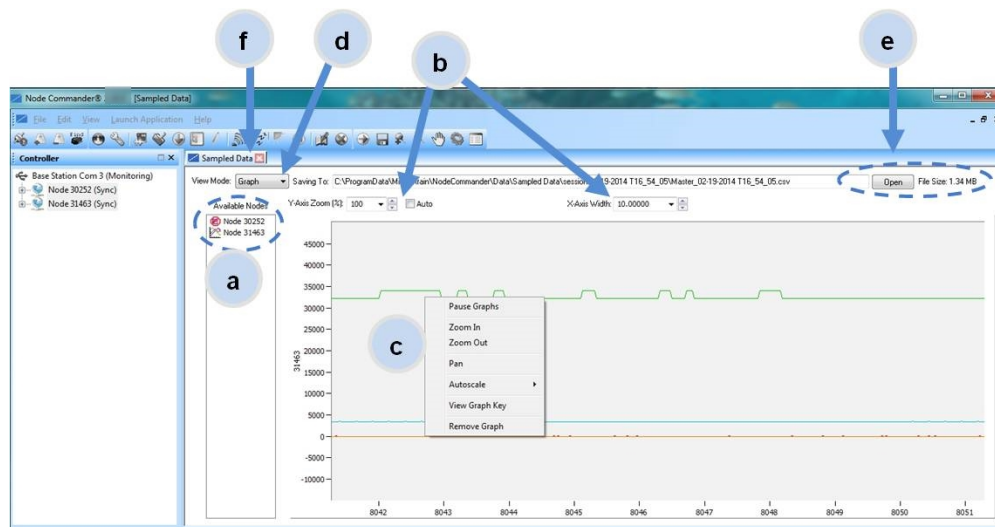

**Figure 14 - Synchronized Sampling Graph View**

- Available Nodes:** Click on the node to display the graph for that node. Click again to hide it. Right-click on the node name for more menu options such as Stop Nodes and Save Stream.
- Axis range:** Select the x-axis width and y-axis zoom percentage, or use the Auto check box for automatic scaling.
- Graph:** The node graph shows the sampled data. Each active channel is displayed in a different color. The x-axis is time in seconds and the y-axis is the A/D value (bits). Right-click on the graph for additional menu options such as View Graph Key, Pan, Zoom, Pause, and Remove Graph.
- View menu:** Select between Data Grid and Graph views.



- e. **Data file:** The location and size of the data file as data is added. View the data in .CSV format with the Open File button.
- f. **End sampling:** The red "X" is used to exit the sampling window and/or end sampling.

**NOTE**

Once sampling has started it will continue as configured without the need to leave Node Commander® open. However, if the node is powered off and is not configured to sample on boot-up, data acquisition will end and must be restarted in Node Commander®.

### 3.8 Data Handling

Data acquired through Node Commander® is automatically saved on the host computer ( [see Sensor Data Files on page 30](#) ) and can also be viewed from the web-based SensorCloud™ portal. Saved data can be uploaded to SensorCloud™ and Ethernet gateways provide the option to automatically port the data to SensorCloud™ during data acquisition for near real-time display and aggregation. Ethernet gateways can also be configured to save data locally to internal memory for future upload to the host computer or SensorCloud™.

SensorCloud™ is based on cloud computing technology and is designed for long term collecting and preservation of data. Features include time series and visualization graphing, automated alerts, and data interpretation tools such as data filtering, statistical analysis, and advanced algorithm development with the integrated MathEngine® interface. Leveraging the open source API, SensorCloud™ can also be used to collect data from other LORD MicroStrain® sensor products or third-party systems. Basic SensorCloud™ services are available to all users free of charge ( [see Connecting to SensorCloud™ on page 27](#) ).



Figure 15 - Data Storage, Display and Processing

### 3.8.1 Connecting to SensorCloud™

To connect to SensorCloud go to the SensorCloud website log-in page, and enter the log-in credentials. Register as a new user if needed.

<http://sensorcloud.com/log-in/>

**Figure 16 - SensorCloud™ Log-in or Register**

The SensorCloud interface has **six main views**. When logging in as a registered user, the Device view is the default. Navigate to other views by clicking the view name at the top of the page (*Figure 17 - SensorCloud™ Menu Views*). The Data and Settings views are only available once a device is selected from the device list.

**Main menus**

SensorCloud® DEVICES ACCOUNT CSV UPLOADER MATHENGINE®

**Device lists – select a device to access Data and Settings menus**

Owned Devices

DEVICE	PLAN	CONFIGURATION	LAST HEARD FROM	DATA (JUN 18 - JUL 18) USAGE	TOTAL STORAGE
New Device OAP1002RECHN7H7H	Basic <b>UPGRADE</b>	Configuration		Transactions: 0.00K/25K Monthly Storage: 0.00/10 MDP	0.00 MDP
W063140205021034	Basic <b>UPGRADE</b>	Configuration	7/21/14 11:30	Transactions: 0.00K/25K Monthly Storage: 0.00/10 MDP	1.88 MDP

Shared Devices

DEVICE	CONFIGURATION	LAST HEARD FROM
MSTest (andy) FFFF015C91C7480	Configuration	7/15/15 12:02
CalFrac - Heavy Loading Run Up 9-4-13 OAP100C358X4URZ	Configuration	

Demo Devices

DEVICE	LAST HEARD FROM
Demo Structure OAP10039TZK5FD6X	7/14/15 14:36

**Figure 17 - SensorCloud™ Menu Views**

**Device** - The device list shows every Ethernet gateway and API device associated with the SensorCloud account, including owned, shared, and demo devices. This view provides links to each device's SensorCloud subscription plan, configuration options, and a summary of last communications and data transactions.

**Account** - The account view is for logistic management of the SensorCloud account, such as changing the log-in password, accessing user email, and reviewing billing information.

**CSV Uploader** - The data upload feature enables data from any source (such as non-Ethernet LORD MicroStrain gateways, or third-party sensor) to be uploaded to the SensorCloud platform. The data must be in the LORD MicroStrain CSV format.

**Data** - This view is only available after a device is selected. It displays data that is collected from sensor nodes or uploaded from files. Data selections are listed by node channel or a user-defined label, and can be enabled for display in the graph window. The interactive graph has navigational features such as panning, zooming, and an overview graph for single-click access to data points or ranges. There are also use and management features such as viewing the meta-data and downloading, embedding, and tagging data graphs.



**Figure 18 - SensorCloud™ Data View**

**Settings** - The settings view provides options for adding meta-data, configuring the data displays for each channel, creating alerts based on data thresholds, setting the data timezone, and more.

**MathEngine®** - is used to analyze sensor data. Functions include the ability to filter out frequencies, smooth out noisy data, perform math operations such as Fast Fourier Transforms

(FFTs), and more (*Figure 19 - MathEngine® View*). MathEngine® interfaces with the SensorCloud graphing view for faster processing. Users can write their own algorithms for custom applications. Refer to the MathEngine® website for more information.

<http://sensorcloud.com/mathengine>

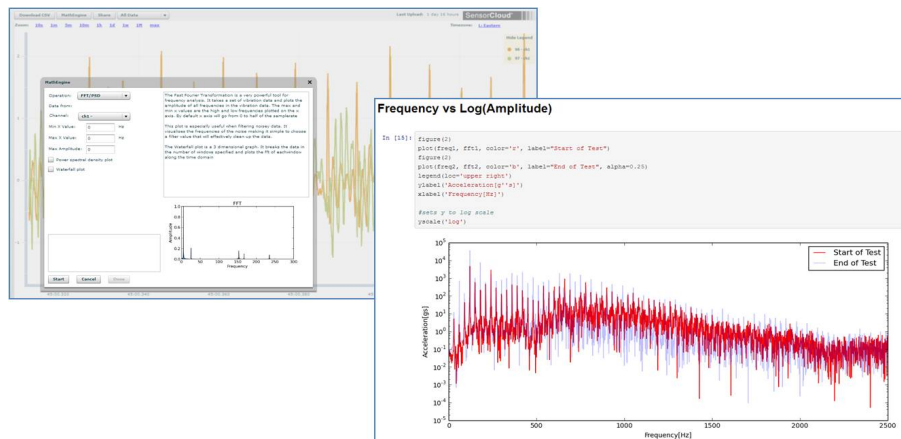

Figure 19 - MathEngine® View

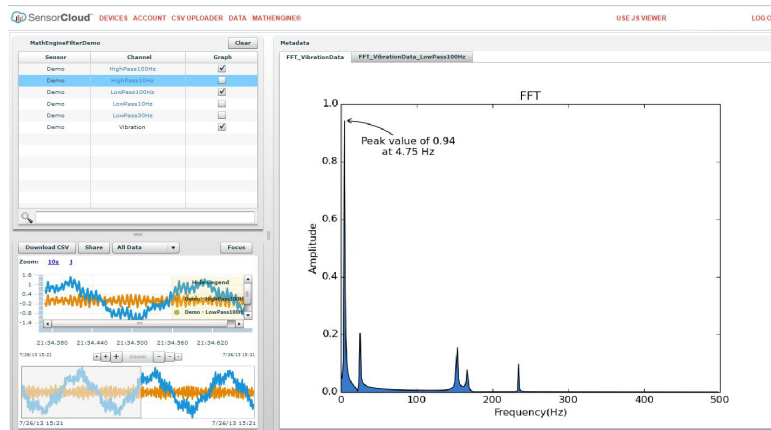

Figure 20 - FFT Graph in SensorCloud™

For more information about SensorCloud features and navigation, refer to the SensorCloud website or contact LORD MicroStrain Technical Support.

<http://sensorcloud.com>

### 3.8.2 Sensor Data Files

Data acquired in Node Commander is stored in .CSV format and can be opened with Microsoft Excel, Quattro Pro, Open Office, or another CSV editors/spreadsheet program. Data in this format is easily uploaded to SensorCloud™ using the CSV Uploader. The data files can be found on the host computer in the default directory or the location specified at the beginning of the sampling session (as applicable). The files are organized in separate folders by mode and then further categorized by date, session, and/or node serial number.

The default directory is: **C:\ProgramData\Microstrain\NodeCommander\Data**

**Synchronized sampling and low duty cycle files** are found in the Sampled Data folder, and **streaming data** is stored in the Streaming folder. **Datalogging files** need to be downloaded from the node to be available for viewing. They are accessed through datalogging menus as well as the File menu, and are saved in the Downloaded Triggers folder.

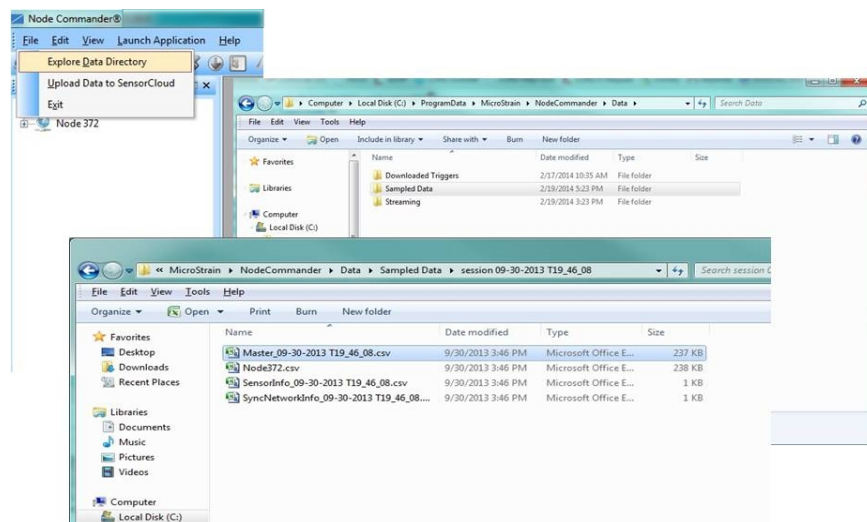

Figure 21 - Exploring Data

#### NOTE

The Microsoft Excel the Time data column in the data file may have to be changed to "m/d/yyyy h:mm:ss:000" format to make it more readable.

## 4. Node Installation

### 4.1 Mounting Recommendations

The SG-Link<sup>®</sup>-LXRS<sup>®</sup> is rated for indoor use only, unless housed in a ruggedized outdoor enclosure. Enclosures for the SG-Link<sup>®</sup>-LXRS<sup>®</sup> are available from LORD MicroStrain<sup>®</sup>. Some also accommodate D cell batteries, extending the battery operating capacity and duration. For more information [see Node Accessories on page 97](#).

There are two mounting tabs on the node, with holes for fastening.

The node can be mounted in any orientation, but it is recommended that it is mounted in a way that optimizes wireless communications. . For more information [see Optimizing the Radio Link on page 32](#).

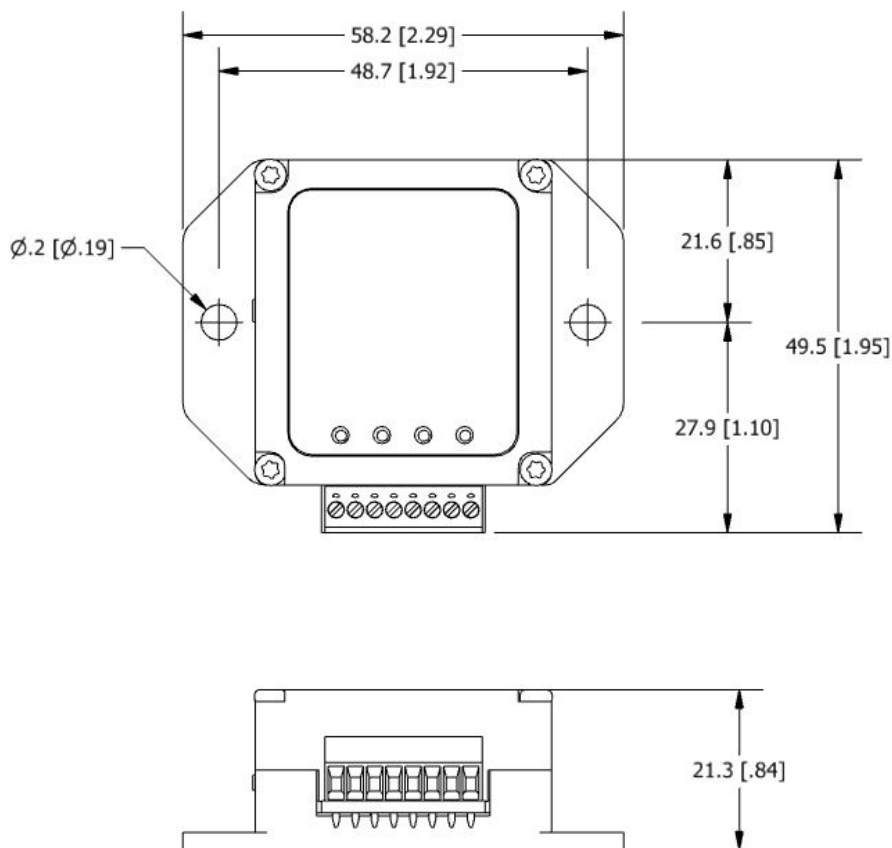

Figure 22 - Mounting the Node

## 4.2 Optimizing the Radio Link

In ideal conditions, the nodes and gateway can communicate up to two kilometers apart. In order to accomplish this, the node and gateway must be installed in a manner that optimizes the wireless transmission. The SG-Link®-LXRS® operates at a 2.4GHz transmission frequency. The internal antenna has an omni-directional radiation pattern. Using any other antenna with the node will void FCC compliance.

The best method for ensuring optimal radio communication is to conduct an RF survey of the installation site. This is easily accomplished in Node Commander® by using the range test feature to quantify the radio signal strength (RSSI) in various scenarios. [See Range Test on page 33](#) for instructions on using Node Commander® for measuring RSSI. The following are general guidelines for maximizing transmission range:

- **Establish Line of Sight (LOS)** between the node and gateway antenna as best as possible. Try to avoid obstructions between the antennas, such as buildings, terrain, vegetation, or other physical barriers. Increase the mounting height of the node to allow a clearer LOS path to the gateway. Height above the ground is also important because reflections off of the ground can interfere at the receiver. Generally, the higher above the ground the better.
- **Minimize Radio Frequency Interference (RFI)** such as other equipment antennas, especially those operating in the same frequency range. This includes other nodes. If other antennas are required nearby, mount them at different heights to minimize interference. Additionally, the specific node frequency is selectable within its operational range using the Node Commander® software. Set the devices to different transmission frequencies.
- **Minimize Electromagnetic Interference (EMI)** such as that which is generated by power transmission equipment, microwaves, power supplies, and other electromagnetic sources.
- **Metal Objects** in close proximity to either antenna, particularly ferrous metals such as steel and iron, can be problematic for wireless communications. The larger the object, the greater the influence.



### 4.2.1 Range Test

After establishing communication between node and gateway, use the range test feature in Node Commander® to monitor the signal strength and to optimally position the nodes, gateway, and antennas for installation. Maximum achievable range is determined by the gateway and node power settings (found in the device Configure menu) and is highly dependent on the physical environment surrounding the devices.

1. Right-click on the node header, and select Communicate > Range Test.

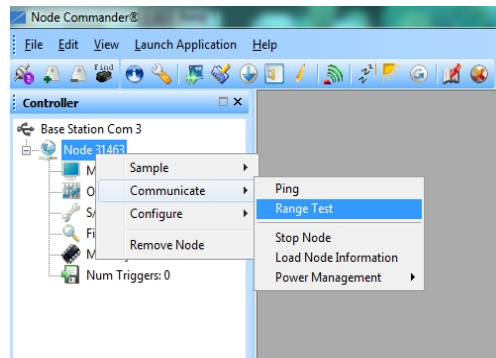

Figure 23 - Range Test Menu

2. The total RSSI range for the node and gateway is -90 to 0dBm. The higher the value (closer to zero), the better, but reliable communication can be achieved between -75 dBm and 0 dBm. The devices is still able to communicate between -90 dBm and -75 dBm, but it could be intermittent or result in data loss. Position the node and gateway antennas where the best RSSI value is observed.

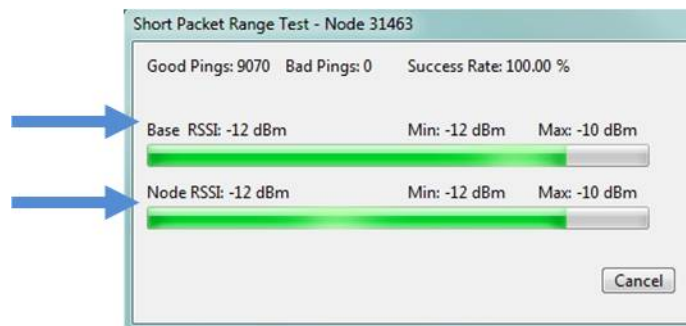

Figure 24 - Range Test Statistics

## 5. Connecting Sensors

### **WARNING**

The SG-Link<sup>®</sup>-LXRS<sup>®</sup> contains an internal, rechargeable Lithium Polymer (Li-Po) battery. For important precautions [see Safety Information on page 105](#).

### **CAUTION**

The SG-Link<sup>®</sup>-LXRS<sup>®</sup> is susceptible to damage and/or disruption of normal operation from Electrostatic Discharge (ESD). For important precautions [see Safety Information on page 105](#).

The SG-Link<sup>®</sup>-LXRS<sup>®</sup> wireless sensor node features two analog input channels that interface with a wide range of available sensor technologies, essentially converting them into wireless sensors. The node accommodates Wheatstone Bridge and analog sensors for applications in wireless strain gauge monitoring, such as torque, force, and pressure measurement, as well as sensors for other applications like wireless accelerometers, vibration sensors, magnetic field and displacement sensors. Environmental sensing can be achieved with wireless RTD and wireless thermocouple monitoring.

The SG-Link<sup>®</sup>-LXRS<sup>®</sup> includes one channel for single ended sensor measurement, one channel for differential sensor measurement, and an additional channel dedicated to the on-board internal temperature sensor. Differential channels may need to be factory-set to work for specific types of sensors. For information about channel configurations [see Differential Input Channels on page 39](#). For ordering information [see Parts and Configurations on page 96](#).

### 5.1 Sensor Requirements

Below are guidelines for selecting sensors for use with the SG-Link<sup>®</sup>-LXRS<sup>®</sup>. For interfacing with sensors outside of these parameters, or not included in the examples in the following sections, contact Technical Support ([see Technical Support on page 94](#)).

#### Sensor Impedance:

- Differential input sensors for a standard SG-Link<sup>®</sup>-LXRS<sup>®</sup> should have an impedance of either 350  $\Omega$  or 1000  $\Omega$ . Sensors that are 120 $\Omega$  are not recommended. For half-bridge and quarter-bridge configurations, the node impedance value is set to

match the sensor when the node is manufactured and must be specified at the time of order. For more information [see \*Parts and Configurations on page 96\*](#). Custom bridge completion impedance values are available on request.

- Single ended sensor inputs must have impedance that is less than 5K $\Omega$ .

#### **Sensor Signal Voltage:**

- Differential sensor inputs include a hardware gain and offset stage before the sensor input signal is processed by the analog to digital voltage converter within the node. The combination of the gain, offset, and sensor signal voltage cannot exceed the 0 to 3 V dc input range of the analog to digital converter. For more information [see \*Differential Input Gain and Offset on page 57\*](#).
- Single-ended sensor signal voltages can only be positive voltages with respect to the system ground and must be between 0 and 3 V dc. For single-ended sensor signal voltages outside of that range [see \*Measuring Voltages over Three Volts on page 45\*](#).

#### **Sensor Power:**

- When using the internal node battery as the node power source, the total current use for all connected sensors must be less than 50mA. If more current is required, a higher capacity external power source can be used for the node or the sensor. [See \*Sensor Power on page 36\*](#) for information about sensor power requirement considerations and options, and [see \*Powering the Node on page 72\*](#) for information regarding node power options.

## **5.2 Wiring Recommendations**

It is good practice that all sensor wiring be done with shielded cable. The shield is connected to the system ground only at one end to avoid ground loops. For sensitive small voltage signals (such as strain gauges) sensor wire leads should be of matched lengths so the lead resistance for each connection is as close to the other as possible. For long lengths of wire, a system calibration is recommended over a sensor calibration. [See \*Sensor Calibration on page 59\*](#).

### 5.3 Sensor Power

#### CAUTION

When using the internal node battery to power the node, total sensor current draw of more than 50mA can cause permanent damage to the node and should be avoided.

Sensors can be powered by the node or with an external power supply. The node sensor excitation voltage is 3 V dc and can provide up to 50 mA total on all channels. If a higher voltage or more current is required for the sensor, an appropriately sized external power supply can be used. For example, using the node battery for current intensive devices such as 4 to 20mA sensors will drain the battery quickly. For these applications, an external source is recommended for the sensor or the node. [See 0 to 3 V dc Voltage Measurements on page 44](#) for an example of using an external source for the sensor, and [see Powering the Node on page 72](#) for node power information.

Drain on the battery can also be limited by selecting low resource sampling modes and low duty sampling rates, which automatically switch the node excitation voltage off after sampling. This feature can also be utilized to turn switches on and off to further control resource use. [See Using the Excitation Output as a Switch on page 47](#).

External battery holders and ruggedized outdoor housings that accommodate D cell batteries are available for the SG-Link®-LXRS® and can be used to extend battery operating capacity and duration. [See Node Accessories on page 97](#).

### 5.4 Node Channels Designations

Channel	Description	Pin Nomenclature
1	differential channel	S
2	(reserved)	--
3	on-board temperature sensor channel	--
4	single ended channel	Ain

**Table 1 - Channel Designations**

### 5.5 Terminal Block Connections

When inserting the sensor leads into the terminal block, ensure the lead wire is being clamped under the terminal screw and not the lead insulation. If the sensor wires are a very fine gauge, folding and tinning them may be useful to provide more area for the terminal screw to make contact. Failure to provide adequate connection may result in erroneous data.

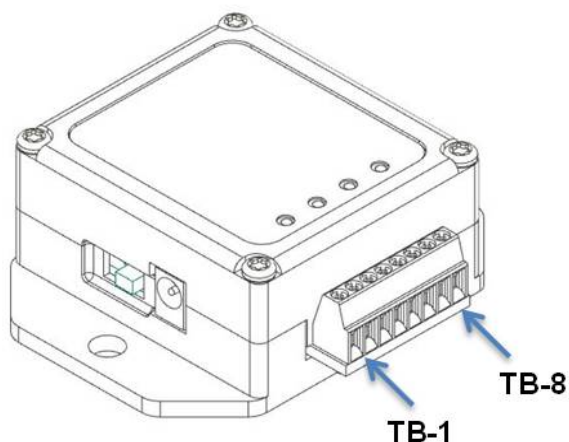

Figure 25 - Terminal Block Numbering

Node Pin Number	Signal
1	VXC
2	S+
3	S-
4	GND
5	S
6	Ain
7	GND
8	Vjck

Table 3 - Terminal Block Connections

## 5.6 Pin Descriptions

Signal	Description	Pin Type	Range
<b>VXC</b>	<b>Sensor excitation</b> Power to external sensors. At sampling rates under 32Hz, it is only active when the node is sampling the sensors.	output	+3 V dc maximum combined load on all excitation pins is 50 mA.
<b>S+</b>	<b>Differential sensor input +</b> Positive input to the node programmable gain amplifier (PGA). Used with S-.	input	0 to +3 V dc including gain and offset Wheatstone Bridge compatible sensor with 350 $\Omega$ or 1000 $\Omega$ input impedance recommended
<b>S-</b>	<b>Differential sensor input -</b> Negative input to the node programmable gain amplifier (PGA). Used with S+.		
<b>GND</b>	<b>Return</b> For node power and sensor excitation	power return	return
<b>S</b>	<b>Three wire input</b> Used only for three wire configuration of quarter bridge strain gauge bridges. Leave unconnected for non quarter strain gauge bridge applications.	input	0 to +3 V dc including gain and offset Wheatstone Bridge compatible sensor with 350 $\Omega$ or 1000 $\Omega$ input impedance recommended
<b>Ain</b>	<b>Single ended sensor input</b> Routed directly to the node analog to digital (A/D) converter. Return is node GND.	input	0 to +3 V dc Less than 5 K $\Omega$
<b>Vjck</b>	<b>Node external power supply</b> An alternate to the node power jack. <i>See <a href="#">Powering the Node on page 72</a>.</i>	power input	+3.6 to +9 V dc sufficient current capacity for sensors

**Table 4 - Node Pin Descriptions**

### 5.7 Differential Input Channels

**NOTE**

Differential channels are configured at the time of manufacture with optional Wheatstone Bridge configurations and impedance values and must be connected accordingly. For available options [see Parts and Configurations on page 96](#).

The differential channels provide an input for sensors with a separate analog return. The measurements are taken with respect to the analog return, instead of the system ground, in order to provide better protection for small measurements from EMI, RFI, and other sources of signal noise. The primary use of these channels is for strain gauges, pressure transducers, load cells and other devices that can utilize a Wheatstone Bridge configuration. The SG-Link®-LXRS® is available in standard configurations for full, half, or quarter Wheatstone Bridge operation, at various impedances. [See Differential Sensors on page 40](#). Custom configurations are also available. For configuration and ordering options [see Parts and Configurations on page 96](#).

The differential measurement channels provide a +3 V dc excitation voltage to the sensor and measures the resulting sensor signal output. The sensor signal goes through a programmable gain amplifier (PGA) and is then processed in the node by a 12-bit analog to digital (A/D) converter over the 3 V dc range. The resolution of the sensor measurement is dependent on the operating range of the sensor. If the application is such that only a small portion of the 3 V dc range is being utilized, better resolution can be achieved by increasing signal amplification and by zeroing the sensor baseline in the appropriate offset biasing range.

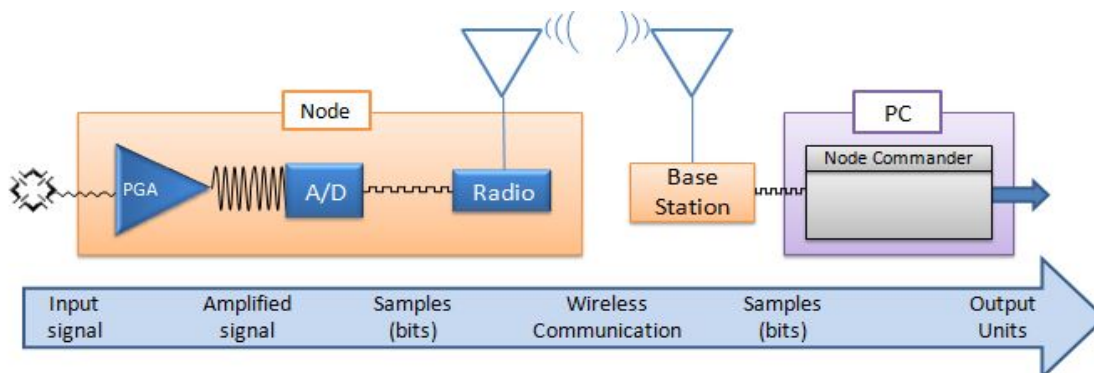

**Figure 26 - Differential Channel Signal Processing**

### 5.7.1 Differential Sensors

Sensors that are classified as differential sensors often utilize a Wheatstone Bridge configuration. These sensors are essentially a resistive load that use the bridge configuration to detect very small resistive changes and produce a precise voltage output as a result. Some examples include strain gauge elements or strain gauge-based sensors, such as some load cells and pressure transducers, as well as some soil moisture, temperature, and other sensors. For use with the SG-Link<sup>®</sup>-LXRS<sup>®</sup>, sensors with an impedance of 350Ω or 1000Ω are recommended.

Calibration in the Node Commander<sup>®</sup> software for these devices varies depending on the type of sensor and includes using the a calibration wizard for strain gauges. The following diagrams show how to connect these types of sensors. [See Sensor Calibration on page 59](#) for more information.

**KEY**  
 x = channel number  
 Rx = sensor element or resistor  
 → = variable value

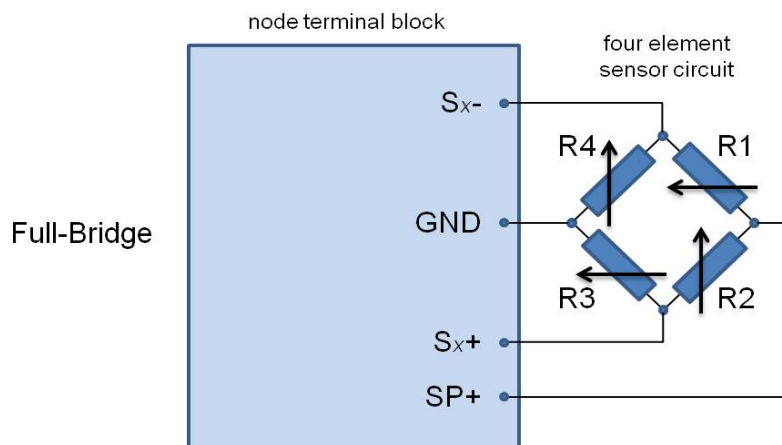
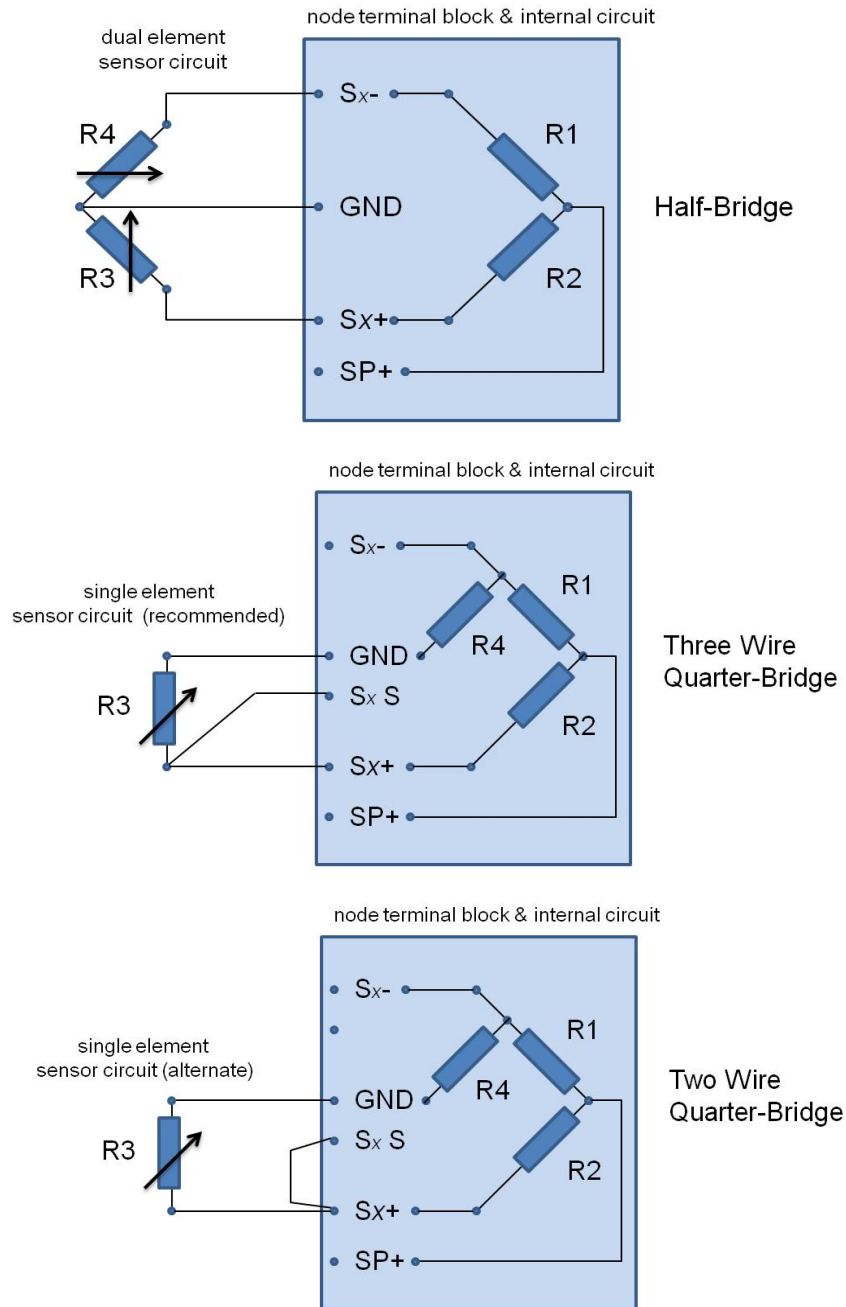

Figure 27 - Full Bridge Wiring



**KEY**

x = channel number  
 Rx = sensor element or resistor  
 → = variable value

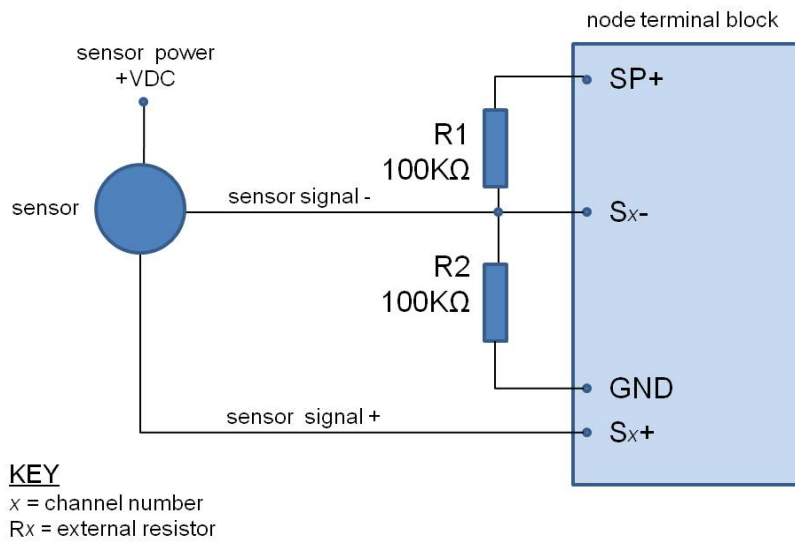

**Figure 28 - Half and Quarter-Bridge Wiring**

### 5.7.2 Measuring Small Voltages

Some sensor types that have small signal voltages (around 20mV or less) may be better measured by biasing the sensor signal to the mid range of the node input range with a voltage divider, as shown in *Figure 29 - Small Voltage Measurement*.

Channel configuration will include adjusting the gain setting accordingly in the Node Commander® software.



**Figure 29 - Small Voltage Measurement**

### 5.8 Single-Ended Input Channels

Single-ended channels are designed to measure voltages with reference to the system ground and can accommodate many analog sensors types including accelerometers, pressure transducers, geophones, temperature sensors, inclinometers, and more. These channels can also be used to measure reference voltages.

Sensors that operate on 3 V dc can be powered with the node excitation voltage. Alternately sensors can be powered with an external source. For an example of how to connect an external supply [see 0 to 3 V dc Voltage Measurements on page 44](#).

The single-ended channels can measure signals from 0 to +3 V dc with reference to the system ground. Sensor output must be positive going voltage in order to operate correctly with the SG-Link®-LXRS®. If the sensors output is greater than 3 V dc a voltage divider can be used to decrease the scale. [See Measuring Voltages over Three Volts on page 45](#). The impedance of the sensor must be less than 5 KΩ.

The sensor output signal is processed in the node by a 12-bit analog to digital (A/D) converter, over the 3 V dc range. The resolution of the sensor measurement is dependent on the full scale output range of the sensor. The closer it is to three volts, the more resolution will be achieved.

The following sections provide examples of how various sensors can be connected to the node. For other applications or those outside of the operating parameters listed above, contact LORD MicroStrain® Technical Support ([see Technical Support on page 94](#) for contact information).

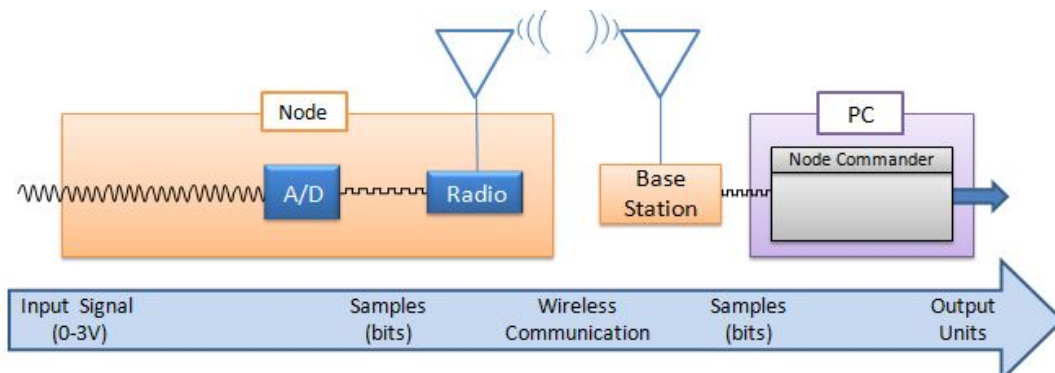

Figure 30 - Single Ended Signal Processing

### 5.8.1 0 to 3 V dc Voltage Measurements

Sensors that operate in the 0 to 3 V dc range are ideal for the node inputs. Resistive loads that are not differentially measured, such as string potentiometers, are easily measured by the node single-ended channels. Power is provided by the node excitation voltage and measured on a single-ended input, as shown below.

Reference power supply signals between 0 and 3 V dc can be measured by connecting directly between the signal input pin (Ainx) and ground (GND).

Sensors that have voltage requirements outside of the range of the node excitation voltage can be powered externally with another source. The sensor output can still be connected directly to the node input as long as it is between 0 and 3 V dc. For sensor outputs over 3 V dc [see Measuring Voltages over Three Volts on page 45](#).

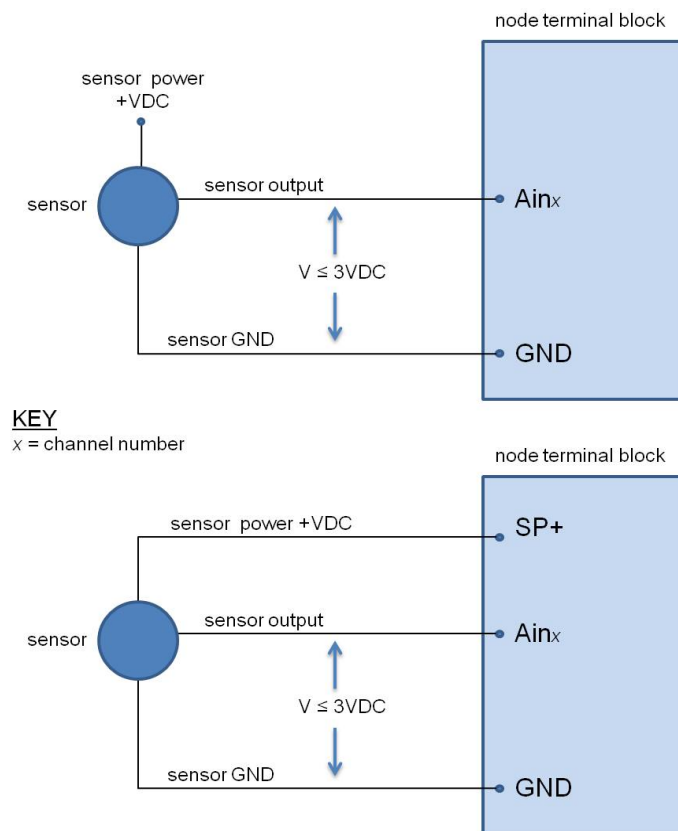
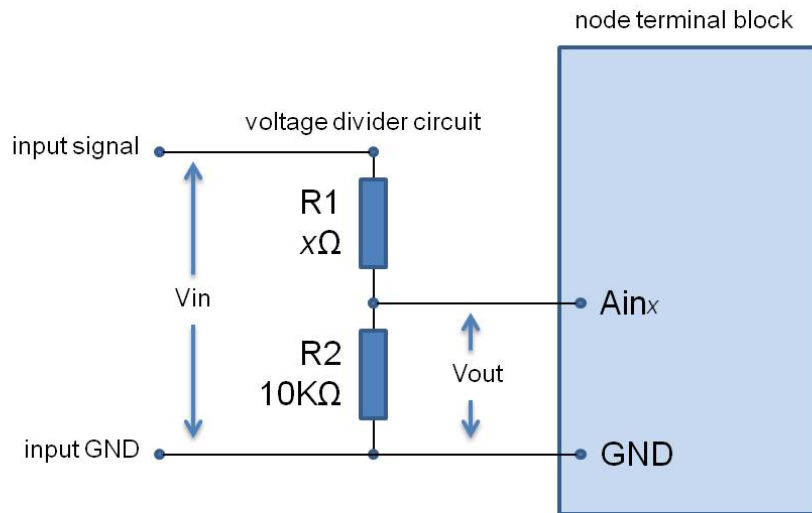

Figure 31 - 0 to 3 V dc Measurements

### 5.8.2 Measuring Voltages over Three Volts

Voltages over three volts can be measured with the use of a voltage divider circuit. This may be necessary if a sensor is powered from an external source. The same circuit can also be used to measure reference power supplies over +3 V dc.

The value of the voltage divider resistors will need to be determined, as required for the application. A 10KΩ resistor is recommended for the input to the node channel, leaving only one resistor to calculate.



#### CALCULATIONS:

$V_{in}$  = maximum sensor output  
 $V_{out} \leq 3$   
 $R2 = 10K\Omega$

by Ohms Law;

$$V_{out} = V_{in} \left[ \frac{R2}{(R1 + R2)} \right] \quad \text{or} \quad R1 = \left[ \left( \frac{V_{in} * R2}{V_{out}} \right) - R2 \right]$$

#### EXAMPLE:

$V_{in} = 0$  to 9VDC

$$R1 = \left[ \left( \frac{9V * 10000\Omega}{3V} \right) - 10000\Omega \right] = 20K\Omega$$

#### KEY

x = channel number  
 Rx = external resistor

### 5.8.3 Measuring Small Currents (4 to 20mA Sensors)

Sensors with small currents, such as 4 to 20mA sensors, can be used with the nodes by adding a precision sampling resistor across a single-ended input channel to the node. An example circuit is shown in [Figure 32 - Small Current Measurements](#).

Because the sensor output can be as much as 20mA it is recommended that an external source be used to power the sensor. When running on the internal node battery, the node excitation can only supply 50mA to all sensors, so 20mA would be a significant portion and would drain the battery quickly. For battery life and current draw information [see Using the Internal Node Battery on page 74](#). The current limitations can be mitigated by using an external power source for the sensor or the node. If using node excitation power is the best for the application, drain on the battery life can be limited by only switching the node excitation voltage on just before sampling and then turning it off afterward. This happens automatically at low duty sampling rates (32Hz or lower) and can be set up for other sample rates with external circuitry. For more information [see Using the Excitation Output as a Switch on page 47](#).

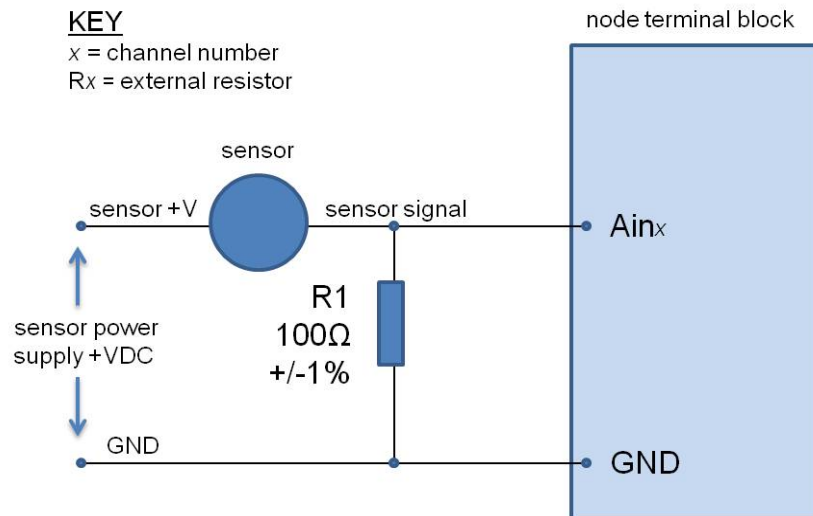

Figure 32 - Small Current Measurements

## 5.9 Using the Excitation Output as a Switch

At low sampling rates (under 32Hz) the node automatically switches the excitation voltage output off when the sensor is not being sampled, in order to conserve battery life. This feature can also be used in applications where a switch is desired, such as for turning sensor power on and off when the sensor is powered by the node but has a large current draw. It can also be used as a general purpose switch, such as for controlling a relay or transistor. The same limitations apply as to a sensor; the device must operate on 3 V dc and not require more than 50mA when combined with all other sensor current draw. To use the excitation output in this way, connect the control line of the device (example: relay coil or NPN transistor base) to the excitation pin on the node terminal block (SP+) and reference (example: other side of the relay coil or the NPN transistor emitter) to the node ground pin (GND).

## 5.10 Thermocouples

Thermocouples can be used on the differential input channels by simply adding a high-impedance resistor to the input. An example circuit is shown in [Figure 33 - Connecting a Thermocouple](#).

Thermocouples should be calibrated by first selecting the appropriate baseline offset range, output range, or gain and then applying known loads and calculating the slope and offset values. Using water as the known load medium (submerging the thermocouple in ice and hot water baths) is a simple method that can be used for calibration.

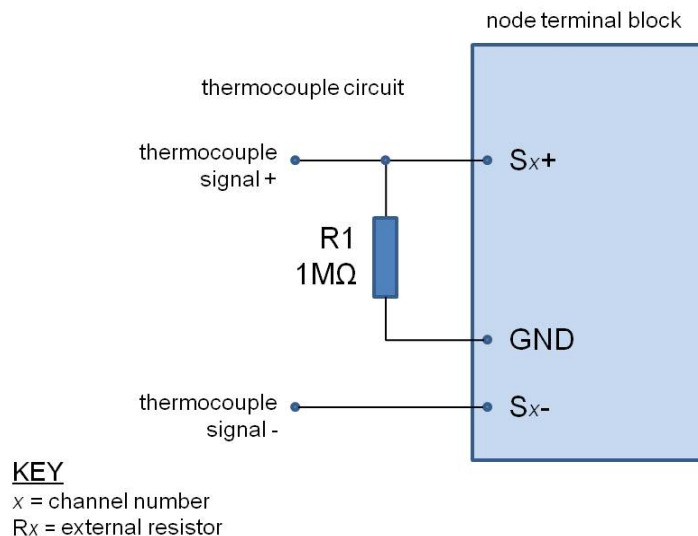

**Figure 33 - Connecting a Thermocouple**

### 5.11 On-board Temperature Sensor

- The SG-Link®-LXRS® has an on-board, solid state temperature sensor mounted on the surface of the circuit board.
- The temperature sensor output is connected to channel 3 of the SG-Link®-LXRS®
- The temperature sensor has a measurement range of -25°C to +70°C range with an accuracy of  $\pm 0.5^{\circ}\text{C}$  @ 25°C.
- The sensor is made by Texas Instruments (part number LM60). Specifications may be found on the manufacturer's website.



## 6. Sensor Settings

LORD MicroStrain® sensor nodes are designed to accept many sensor types. The node configuration interface includes settings for measurement units, gain settings, and conversion values. For more information [see \*Sensor Calibration on page 59\*](#). There are preset measurement units, as well as a user-defined field. Because the wireless sensor system is digital, the analog voltage readings from the sensors are converted into a digital equivalent value based on the volt-to-bit scale of the internal analog-to-digital voltage converter (A/D converter). Sensor readings can be displayed and recorded in volts and A/D value (bits) directly or further converted to engineering units by applying conversion values and a conversion formula. For more information [see \*Sensor Conversion Values on page 52\*](#), and for instruction of adjusting units [see \*Measurement Units on page 51\*](#).

Some sensors require calibration to determine more accurate conversion values. Calibration incorporates coefficients that normalize the sensor output to a known reference device and guarantee accuracy of conversions.

External sensors can be attached to any channel that is suitable for sensor type. [Table 5 - Example External Sensor Types](#), describes example sensors, units, and calibration options.

channel type	example external sensors	units	calibration options
analog differential input	strain gauges in full, half, quarter/custom Wheatstone Bridge configurations	strain volts A/D value custom	calibration wizard  user entry from manufacturer data, lab or field calibration
	other Wheatstone Bridge sensors such as:  some pressure sensors  some force sensors  some mass sensors  some displacement sensors  some accelerometers	g-force A/D value volts custom  English and metric measurements for; mass, pressure, force, distance, and	user entry from manufacturer data, lab or field calibration

channel type	example external sensors	units	calibration options
	some temperature sensors 4-20mA sensors	temperature.	
<b>analog single ended input</b>	sensors with voltage outputs referenced to the system ground.	volts A/D value custom	user entry from manufacturer data, lab or field calibration
<b>thermocouple</b>	thermocouples	temperature A/D value custom	user entry from manufacturer data, lab or field calibration

**Table 5 - Example External Sensor Types**

### 6.1 Measurement Units

Sensor measurement units are set in the channel Configuration menu.

1. To enter the Configuration menu, right-click on the Node heading, and select Configure > Configure Node. The Channels tab displays channel options available for the current node.

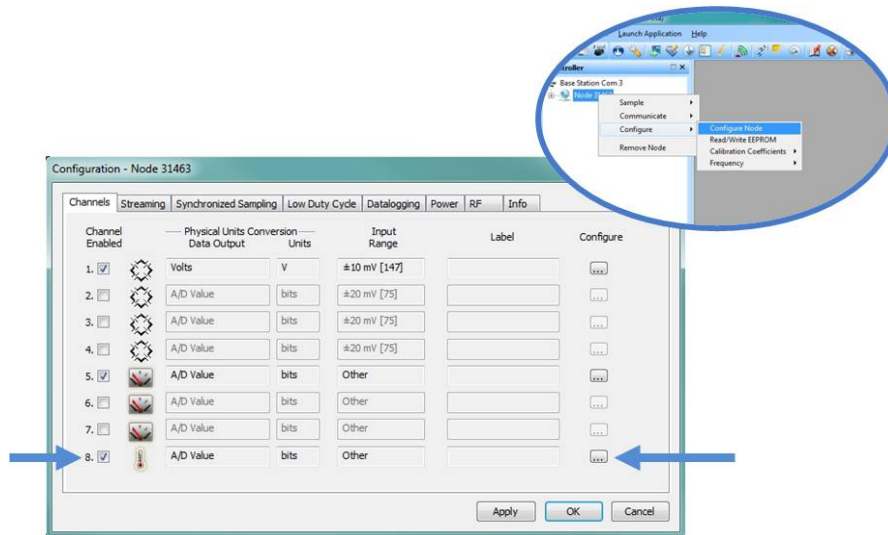

Figure 34 - Channel Configuration Menu

2. Select the type of measurement from the Class menu, and then select Units.

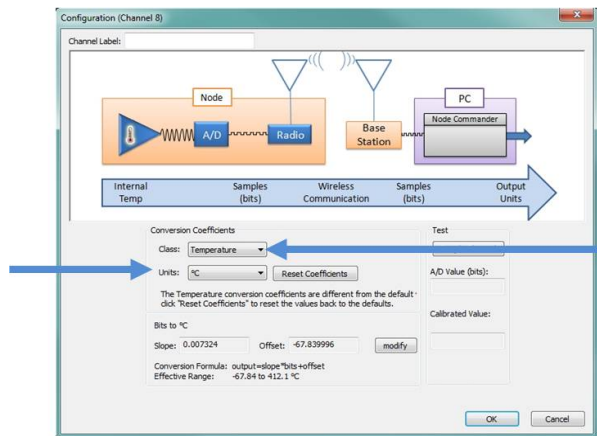

Figure 35 - Select Sensor Units

## 6.2 Sensor Conversion Values

The conversion values include the slope, offset, gain, scale, and formula for converting the sensor A/D value (bits) to engineering units. The bits are the digital representation of the sensor voltage output. The type of sensor, channel, and desired engineering units determine what conversion values are available. The conversion values are entered through Node Commander<sup>®</sup> and saved in the node memory for the applicable channel.

Conversion values for the SG-Link<sup>®</sup>-LXRS<sup>®</sup> are determined mathematically from the sensor sensitivity specifications, from the sensor manufacturer calibration data, or through a calibration process. Calibration incorporates coefficients that normalize the sensor output to a known reference device in order guarantee accuracy of the sensor readings, especially when making small or precise measurements. *See Sensor Calibration on page 59* for more information. Not all sensors require calibration

The conversion values can be entered in two menus. The channel Configuration menu has more options than the Calibration Coefficients menu, but both are acceptable ways to enter the values and formulas.

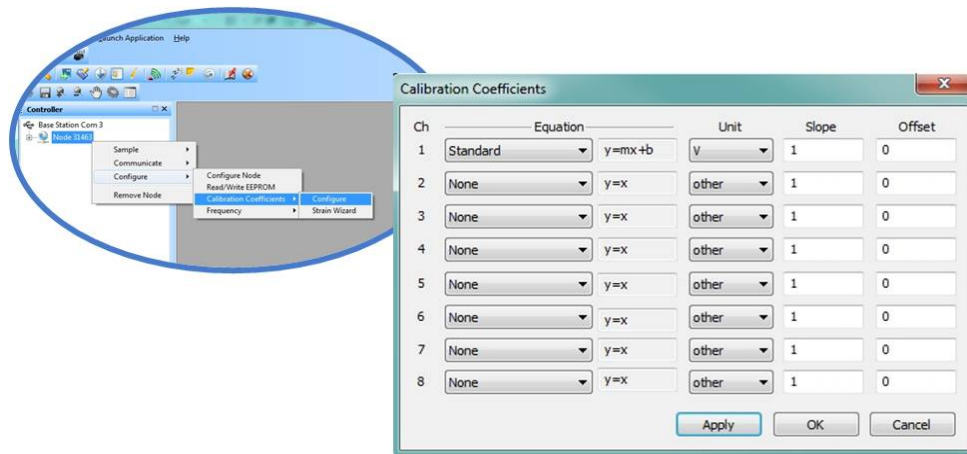

Figure 36 - Abbreviated Conversion Values Menu

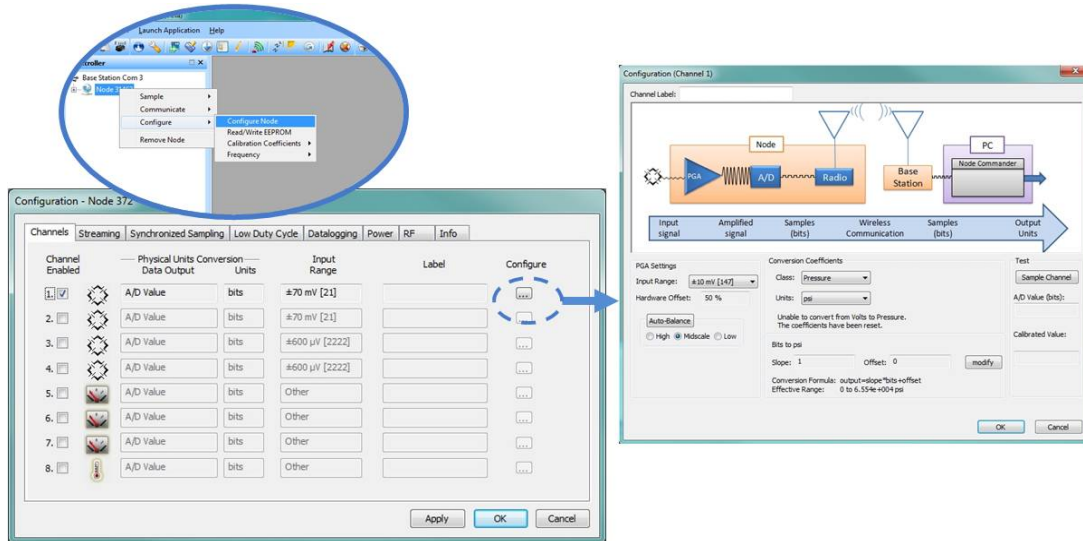

Figure 37 - Advanced Conversion Values Menu

**NOTE**

In order to report accurate readings, many sensors require calibration. Calibration coefficients normalize the sensor output to a known reference device and are often expressed in the measurement unit conversion values; the only difference being the use of a traceable reference. Calibration can be used to account for the variations between individual sensors, wiring, system electronics, sensor mounting and environmental conditions.

**Conversion Formula:** The conversion formula assumes a linear relationship between the original units (such as volts or A/D bits) and new engineering units (such as strain), and it is expressed mathematically as  $y=mx+b$ , where  $y$  is the engineering units at a given point (measurement),  $m$  is the slope of the line that represents the linear ratio,  $x$  is the original unit value at a given point, and  $b$  is a unit conversion offset (in the case of unit conversions) or the fixed zero load offset of the sensor (in the case of measurement calibration coefficients). Negative values may be entered for any coefficient.

**Slope:** is the linear scaling slope coefficient. The slope is the ratio of original units to new engineering units (EU), and it is used to convert the sensor measurements. The slope conversion value will vary depending on the engineering units desired. For example if the original unit is A/D values (bits), and the desired engineering units are acceleration in g-

force, the slope conversion would describe how many bits equal one unit of  $g$ -force (bits/ $g$ ). Mathematically, the slope is  $m$  in the formula  $y = mx + b$ .

**Offset:** is the linear scaling offset coefficient, and it is typically the starting output value of the sensor with no load applied (in the original units). Mathematically, the offset is  $b$  in  $y = mx + b$ .

**Effective Range:** the effective range is the calculated sensor measurement range in engineering units (EU). The effective range is dependent on the slope, offset and resolution of the node. The effective range is the number of bits per EU unit (slope) multiplied by the total number of bits, minus the offset (if applicable).

**Input Range (Gain):** This sets the amplification of the signal within the node and is only available for channels with differential inputs and gain amplifiers.

**Offset Scale (with Auto Balance):** This feature is only available for channels with differential inputs, and assigns the position and value of the no load measurement of the sensor. The offset scale level adjusts the operating window of the sensor measurements in reference to the entire range. For example, in mid scale the sensor no load measurement will be placed in the middle of the range, providing 50% of the range for positive readings and 50% of the range for negative readings. Once the scale level is selected, the Auto Balance procedure is used to assign the actual sensor no-load measurement to the designated scale.

- Low is for positive-going signals (zero at 25% of total range).
- High is for negative-going signals (zero at 75% of total range).
- Midscale is for positive and negative-going signals (zero at 50% of range).

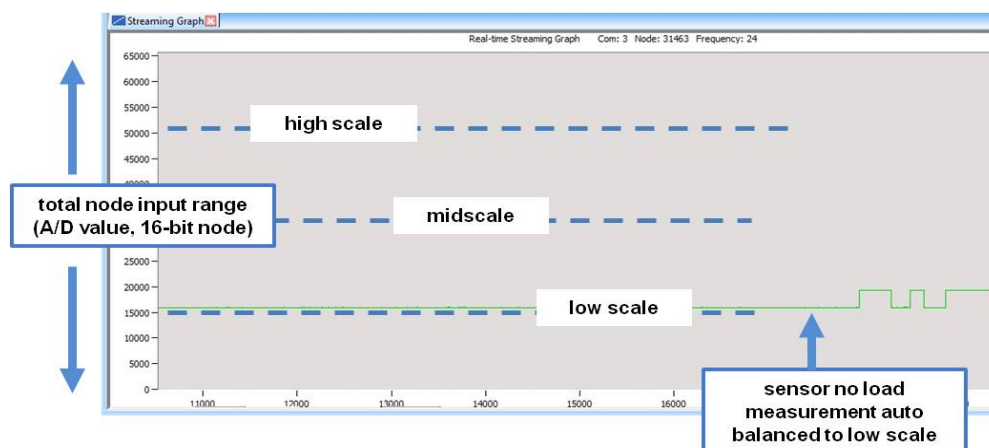

Figure 38 - Offset Scale Setting

## 6.2.1 Calculating a Linear Slope

A data analysis tool such as Microsoft Excel can be used determine the slope of a linear relationship between sensor output A/D value (bits) and engineering units. This is not a calibration unless a calibrated reference device is used to measure the applied loads. For information and examples for determining calibrations coefficients [see \*Sensor Calibration\* on page 59](#).

Here is an example, using Excel:

1. Open a blank spreadsheet.
2. Enter the A/D value (bits) measurements and applied load in the desired engineering units in two columns. Enter A/D value in the left column (x-axis value) and the applied load in the right (y-axis value).
3. From the Insert menu, select Chart > Scatter. Select the preferred format.

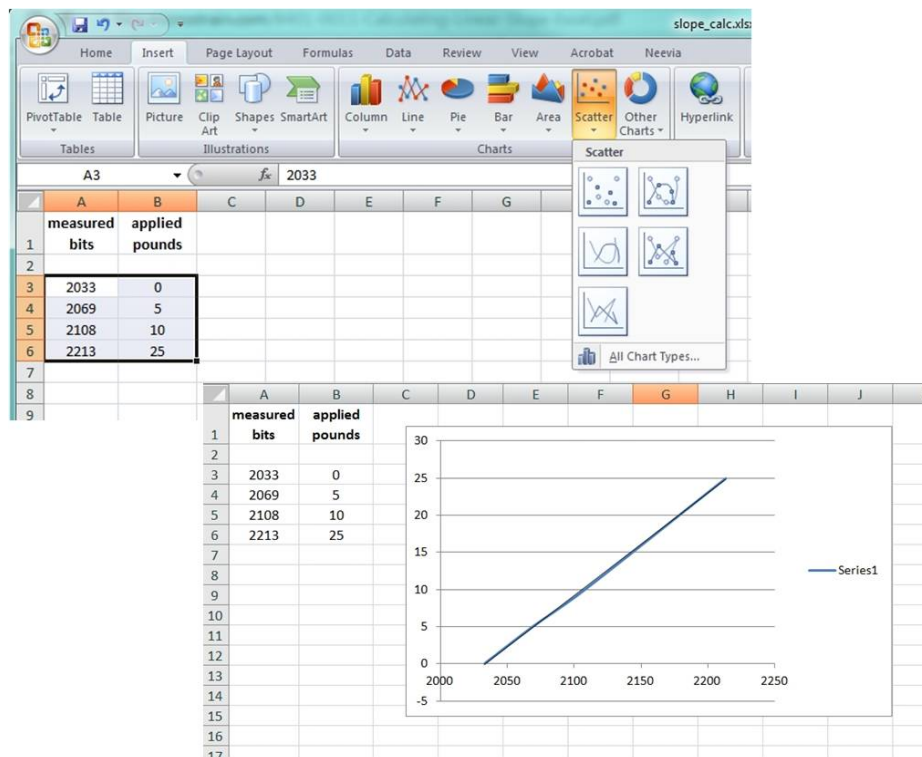

Figure 39 - Generate a Scatter Chart

- Right-click on the graphed line, and select Add Trendline .
- Designate the line as Linear, and check the option to Display the Equation on the chart (*Figure 40 - Plot Trendline*).

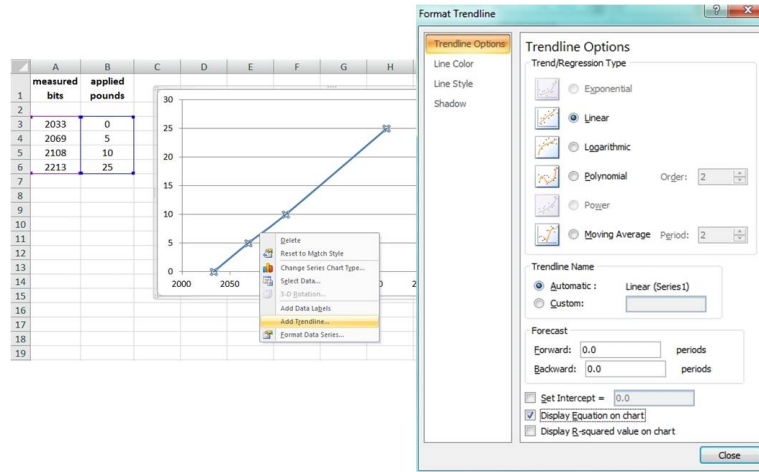

Figure 40 - Plot Trendline

- The formula of the line is  $y=mx+b$ , where  $y$  is the engineering units at a given point (measurement),  $m$  is the slope of the line that represents the linear ratio,  $x$  is the A/D value at a given point, and  $b$  is the fixed zero load offset of the sensor. Enter the slope and offset as the conversion values for the sensor channel under the applicable engineering units. In this example, enter 0.1388 for the slope and -282.36 for the offset for the units conversion values on the measured channel.

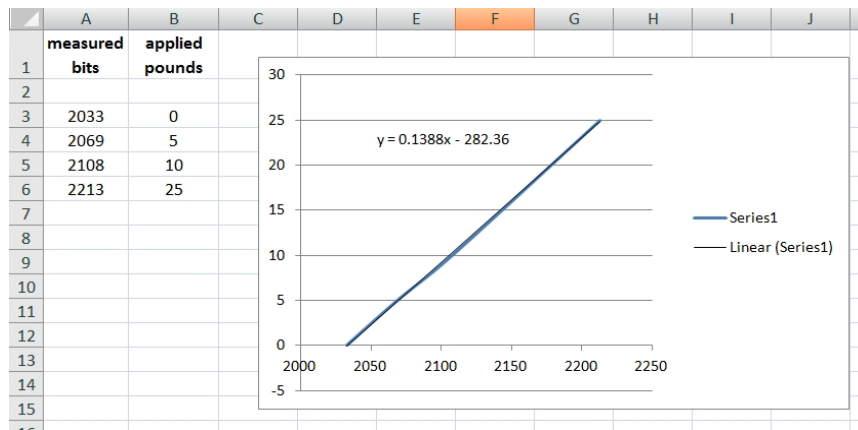

Figure 41 - Slope and Offset Values



### 6.2.2 Differential Input Gain and Offset

The combination of the gain, offset, and sensor signal cannot exceed the 0 to 3 V dc input of the analog to digital converter within the node. [See Example Gain and Offset Calculations on page 58.](#)

**Resolution:** Applying gain to the sensor signal can be used to maximize the measurement resolution. The more of the range that is used, the more digital counts are available to measure the signal, which typically means higher resolution measurements. Limitations to the gain adjustment are the sensor's measurement capabilities and the 0 to 3V input range of the node. The signal produced after gain is applied to the sensor at full scale must not exceed the input range of the node.

**Offset Scale:** The scale setting positions the no-load measurement of the connected sensor within the 0 to 3V range of the node input. The range of A/D counts that corresponds with the 0 to 3V node input depends on the resolution of the node. For example, a 12-bit node will have a full scale bit range of 4096 and a 16-bit node will have a full scale bit range of 65535. A mid-range setting positions the baseline offset in the middle of the range (1.5 V or full scale bits\*1/2) and is used for sensors with negative and positive going signals. The low-range setting positions the baseline offset in the bottom quarter range (750 mV or full scale bits\*1/4) and is used for sensors with mostly positive going signals. The high-range setting positions the baseline offset in the top quarter of the range (2.25 V or full scale bits \*3/4) and is used for mostly negative going signals.

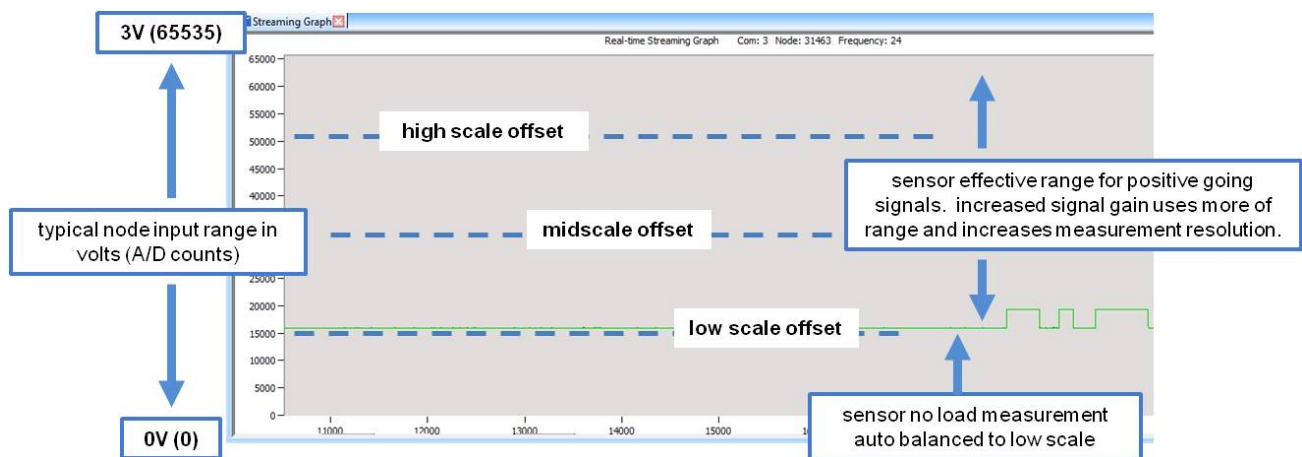

Figure 42 - Differential Input Resolution and Offset (16-bit Node)

### 6.2.2.1 Example Gain and Offset Calculations

#### EXAMPLE 1:

**Sensor signal range:** 0 to 50 mV

**Gain setting:** 21

**Baseline offset range setting:** Mid-range

#### Calculations:

$50 \text{ mV} * 21 = 1.05 \text{ V}$  (maximum voltage of sensor signal with gain)

$1.05 \text{ V} + 1.5 \text{ V} = 2.55 \text{ V}$  ( maximum input voltage to node with gain and offset)

**Calculated node input over sensor range:** 1.5 to 2.55 V

This is a good setting because the node input voltage is within the 0 to 3 V range.

#### EXAMPLE 2:

**Sensor signal range:** 0 to 50 mV

**Gain setting:** 30

**Baseline offset range setting:** Low-range

#### Calculations:

$50 \text{ mV} * 30 = 1.5 \text{ V}$  (maximum voltage of sensor signal with gain)

$1.5 \text{ V} + 750 \text{ mV} = 2.25 \text{ V}$  ( maximum input voltage to node with gain and offset)

**Calculated node input over sensor range:** 750 mV to 2.25 V

This may be a better setting than in Example 1 because the gain is higher, which could increase the resolution of the measurement. The node input voltage is still within the 0 to 3 V range.

#### EXAMPLE 3:

**Sensor signal range:** 0 to 50 mV

**Gain setting:** 75

**Baseline offset range setting:** Low-range

#### Calculations:

$50 \text{ mV} * 75 = 3.75 \text{ V}$  (maximum voltage of sensor signal with gain)

$3.75 \text{ V} + 750 \text{ mV} = 4.5 \text{ V}$  ( maximum input voltage to node with gain and offset)

**Calculated node input over sensor range:** 750 mV to 4.5 V

This setting will not work because the node input voltage is outside of the 0 to 3 V range.

### 6.3 Sensor Calibration

Many sensors require calibration coefficients to accurately report measurements. Methods for determining the calibration coefficients depend on the type of sensor measurement and application. The Node Commander® software facilitates multiple calibration methods. Calibration calculators for some applications are also available by contacting LORD MicroStrain® Technical Support. [See Technical Support on page 94.](#)

- **Sensor manufacturer's specifications or calibration:** The slope and offset values, or the data to derive them, are provided with the sensor by the manufacturer to prove its accuracy and describe expected voltage output. Some sensors are calibrated individually, while others are manufactured to a standard sensitivity value (plus or minus some tolerance), which is provided in the device specifications.
- **Sensor lab calibration:** If the manufacturer's calibration is not available or outdated, calibration of the sensor can be performed with calibrated equipment in a controlled environment. The calibration equipment and process will typically be traceable to an industry standard, such as NIST or ASTM in the United States. Fixed loads are applied to the sensor while the sensor output is recorded. The load is applied or measured by a calibrated reference device. The known load value from the calibrated device is then plotted against the measured output of the sensor to determine the calibration slope and offset. In Node Commander® this can be accomplished by taking sensor readings while applying the known loads.

Sensor wiring, tolerances in system electronics, and differences in mounting techniques are examples of systemic variables that can influence the sensor readings. Sensors that are making small measurements or are otherwise sensitive to these slight differences may benefit from a system calibration. The following techniques are system calibrations:

- **System shunt calibration (internal and external):** This option is only available for Wheatstone bridge-type sensors (such as strain gauges) and utilizes a calibration wizard in Node Commander®. In the shunt calibration process, an internal or external precision resistor is used to load part of the sensor bridge while the sensor remains unloaded. The bridge output is measured and used as a loaded calibration point for the sensor. In addition to the no-load value it can be used to derive the calibration slope and offset. The internal shunt resistor is suitable for most applications, however an external shunt may be beneficial in high gain scenarios.

- **System field calibration:** The field calibration is a similar methodology to the sensor lab calibration. Known loads are applied to the sensor while the sensor output is recorded. The load is applied or measured by a reference device. In this scenario, the sensor may be installed in final field configuration, and the load may be applied with the actual stimulus that the sensor will be monitoring. The known load value from the reference device is then plotted against the measured output of the sensor to determine the calibration slope and offset. In Node Commander<sup>®</sup> this can be accomplished by taking sensors readings while applying the known loads.

### 6.3.1 EXAMPLE: Lab or Field Calibration

The lab and field calibrations use similar methodology. [See Sensor Calibration on page 59.](#) The primary difference is the traceability and calibration environment. Lab calibrations are performed in controlled environments with traceable equipment and procedures. Field calibrations are more improvised, although calibrated equipment can still be used to improve accuracy.

**NODE:** V-Link®-LXRS®, 16 bit (65535 A/D values)

**CHANNEL TYPE:** differential analog input, 0 to 3 V dc input range

**SENSOR TYPE:** load cell

**SENSOR PARAMETERS:** application voltage range: +/-20 mV

This is the expected output voltage of the sensor based on the range of force being measured in the application and the sensitivity of the sensor (V/engineering units)

**DESIRED OUTPUT:** engineering units (EU), force (lbs)

#### PROCEDURE:

1. Open Node Commander®, and establish communication with the gateway and node ([see System Operational Overview on page 12](#)).
2. Right-click on the node heading and select Configure > Configure Node. Select the check-box for Channel 1, which is where the strain gauge is connected, and then select the Configure button.

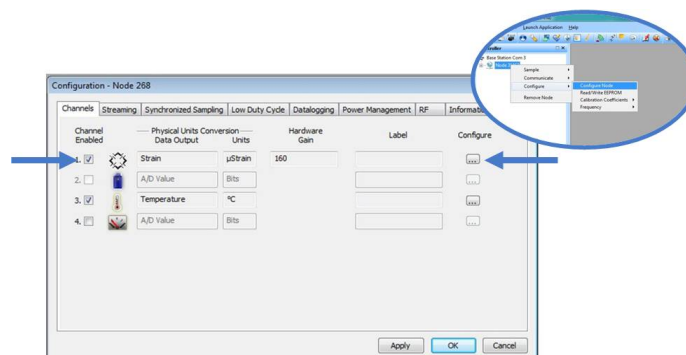
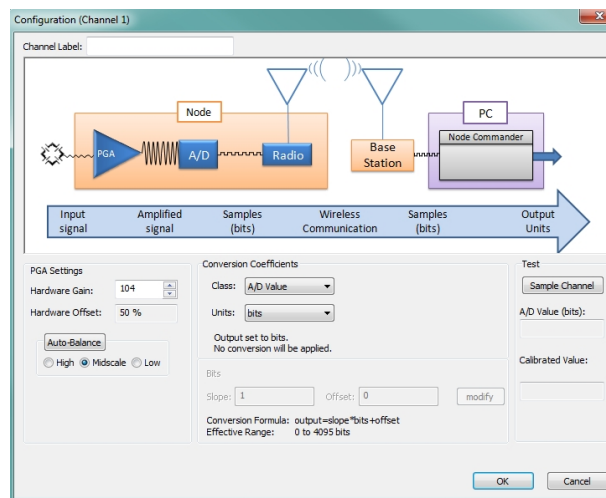

Figure 43 - Node Configuration Menu

3. Use the following settings (*Figure 44 - Channel Settings*):
  - a. **Conversion Coefficients, Class:** A/D value
  - b. **Conversion Coefficients, Units:** bits
  - c. **PGA Settings, Hardware Gain:** 104
  - d. **PGA Setting:** Midscale (for positive and negative going signals)
4. Select the Auto Balance button to tare the no-load value of the strain gauge. Click OK to apply the node settings and exit configuration.



**Figure 44 - Channel Settings**

5. Right-click on the node heading, and then Sample > Stream > Start.

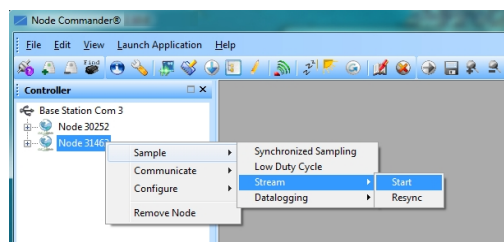

**Figure 45 - Start Node Streaming**

6. The streaming graph shows the bit output of the channel.
7. Using a calibrated tool (or some other way of applying and measuring a known load) and apply loads to the sensor at a number of intervals over the expected range of use. At each of the calibration intervals, record the applied force and the corresponding sweep value on the y-axis of the graph (the A/D value output of the sensor).
  - a. Zoom in and out on the graph by un-checking the Auto Y-Axis Zoom box, and then right clicking on the graph and selecting Zoom In. Draw a box around the desired area to zoom in on.
  - b. Adjust the Y-Axis Width from the field next to the Y-Axis Zoom.
  - c. End sampling by clicking the red X box on the Streaming Graph tab.

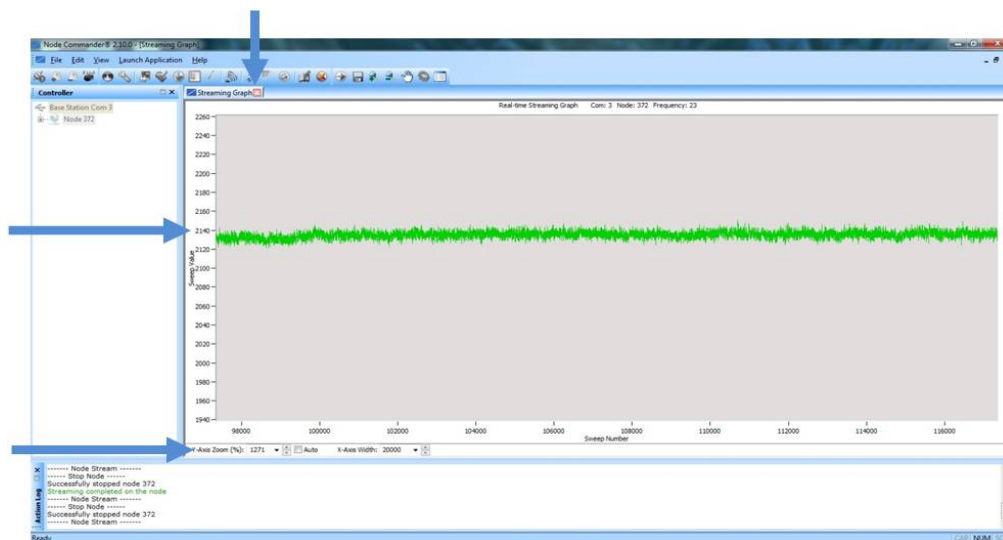
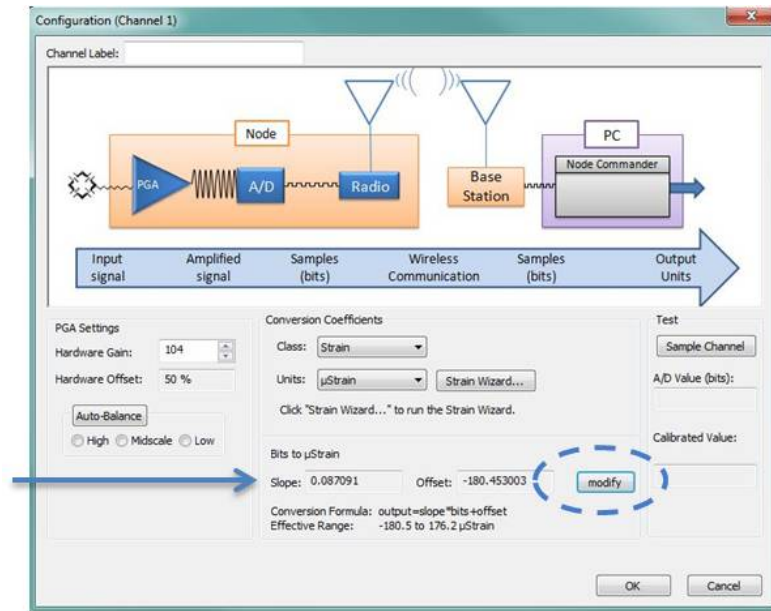

Figure 46 - Node Sampling

8. After making all measurements, calculate a slope from the data using the formula  $y=mx+b$  in a data analysis program, such as Microsoft Excel. [See Calculating a Linear Slope on page 55.](#)
9. Return to the Node Configuration screen for the sensor channel, and select the Conversion Coefficients Class and Units, and enter the Slope and Offset values derived in the data analysis program.



**Figure 47 - Enter Calibration Values**

10. Save the values, and exit configuration. This is the end of a lab calibration.
11. For field calibrations, begin node data streaming again with no load on the sensor.
12. Observe the value in the stream graph. If the stream is not at zero, return to the channel configuration menu, and adjust the offset by increasing or decreasing the value.
13. Once the offset has been zeroed, verify the calibration by applying known loads on the sensor throughout the load range, observing and verifying the measurement in engineering units.



### 6.3.2 EXAMPLE: Manufacturer Calibration

**NODE:** V-Link<sup>®</sup>-LXRS<sup>®</sup>, 16 bit (65535 A/D values)

**CHANNEL TYPE:** differential analog input, 0 to 3 V dc input range

**SENSOR TYPE:** pressure transducer, voltage output, positive going

**SENSOR PARAMETERS:**

From the manufacturer calibration sheet included with the sensor;

sensor range: 0-250 psi

sensor zero load output: 0.0032 V dc

sensor full scale output (FSO) with 10V excitation: 86.07 mV

From the application parameters;

sensor excitation in application: 3V supply from the node

**DESIRED OUTPUT:** engineering units (EU), psi

**CALCULATIONS:**

Because the sensor will be powered from the node with 3 V, and the sensor manufacturer calibrated it a 10V, the manufacturer full scale output (FSO) value needs to be scaled to 3V.

$$(3 \text{ V}/10 \text{ V}) * 86.07 \text{ mV} = 25.82 \text{ mV}$$

Select a gain and offset scale value appropriate for the sensor. Because the signal is positive going in this example application, the low offset scale will provide the largest range. With the low offset selected, the effective input range of the node is 750 mV to 3 V (2.25 V) ([see Differential Input Gain and Offset on page 57](#)). Calculate the highest gain possible by dividing the actual input range by the sensor FSO.

$$2.25 \text{ V}/25.82 \text{ mV} = 87$$

The closest gain setting below optimal gain for a V-Link<sup>®</sup>-LXRS<sup>®</sup> is 75 (+/-20 mV). Using a higher gain value would exceed the input voltage capacity of the node when the sensor is at higher pressures. This selection makes sense because the approximate input range designation for a gain of 75 is +/-20 mV (a 40 mV delta minus 10 mV for the low offset), which is close to the FSO range of the sensor.

Multiply the sensor FSO by the gain setting to get the sensor voltage after amplification.

$$75 * 25.82 \text{ mV} = 1.9365 \text{ V}$$

Scale the (gained) sensor input voltage/EU ratio to the node input voltage/EU ratio to determine the equivalent node FSO value ( $x$ ).

$$1.9365 \text{ V}/250 \text{ psi} = 3 \text{ V}/x$$
$$(250 \text{ psi} * 3 \text{ V})/1.9365 \text{ V} = x = 387.3 \text{ psi}$$

The node converts voltage inputs to A/D values. For a 16-bit node, there are 65536 A/D values over the 3 V input range. Divide the node EU FSO by the A/D value to get the ratio, or slope, of EU to A/D value.

$$387.3 \text{ psi}/65536 \text{ bits} = 0.00591 = \text{slope}$$

Once the slope is entered, the sensor offset value can be measured in a data sampling session, such as streaming. Sample the sensor channel with no load applied, and read the EU value. Enter this as a negative value for the offset in order to have it subtracted from readings.

**6.3.3 EXAMPLE: Internal Shunt Calibration**

**NODE:** V-Link® -LXRS®, 16 bit (65535 A/D values)

**CHANNEL TYPE:** differential analog input, 0 to 3 V dc input range

**SENSOR TYPE:** strain gauge, Wheatstone Bridge, full bridge configuration

**SENSOR PARAMETERS:** application voltage range: +/-2 mV

This is the expected output voltage of the strain gauge based on the range of strain being measured in the application and the sensitivity of the gauge (volts/strain).

**DESIRED OUTPUT:** engineering units, microstrain

**PROCEDURE:**

1. Open Node Commander®, and establish communication with the gateway and node. (*See System Operational Overview on page 12.*)
2. Right-click on the node name, and select Configure > Configure Node.
3. Select the check-box for Channel 1, which is where the strain gauge is connected, and then select the Configure button.

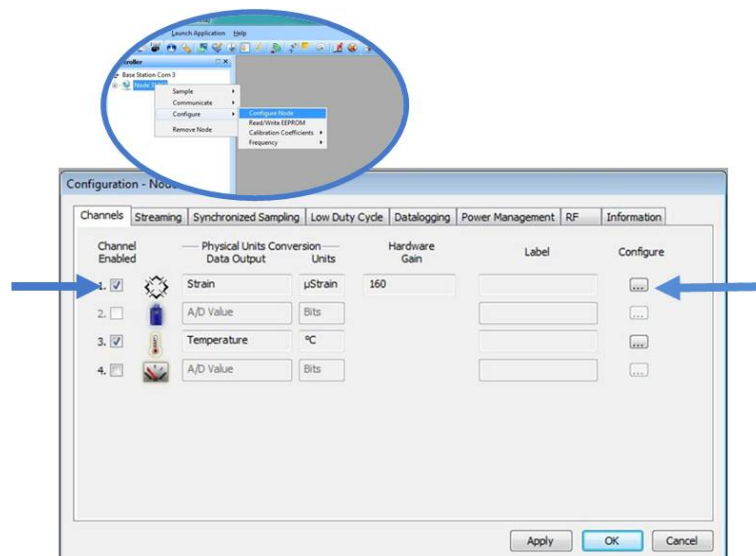

**Figure 48 - Node Configuration Menu**

4. Use the following settings;
  - a. **Conversion Coefficients, Class:** Strain
  - b. **Conversion Coefficients, Units:**  $\mu$ Strain
  - c. **PGA Settings, Hardware Gain:** 104
  - d. **PGA Setting:** Midscale (for positive and negative going signals)
5. Select the Auto Balance button to tare the no-load value of the strain gauge. Observe the value returned for the Auto Balance value.

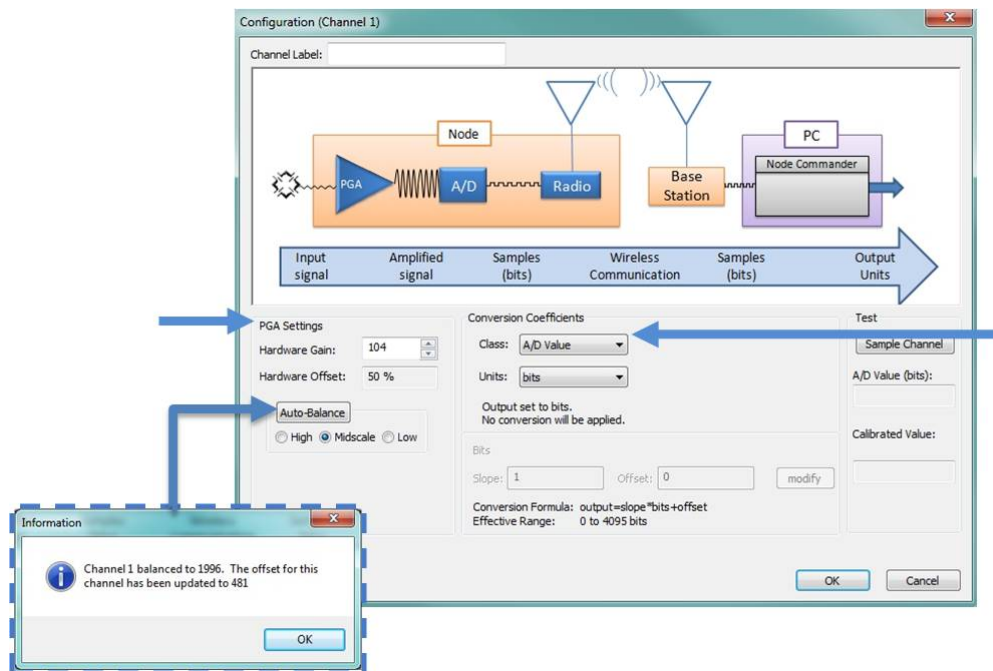
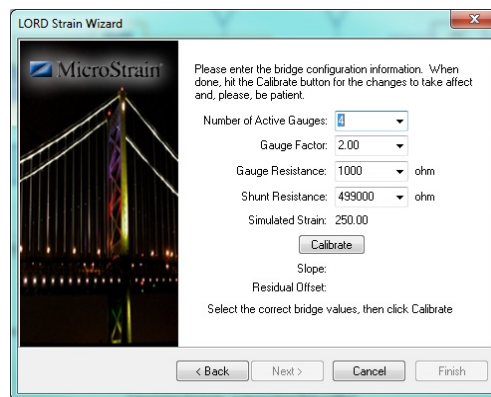

Figure 49 - Channel Settings

6. Select the Strain Wizard.
7. Select the appropriate Bridge Type and click Next.
8. Select Use the Strain Measurement Wizard and click Next.
9. Set the following parameters:
  - a. **Number of Active Gauges:** number of a strain elements connected (for example: 4 for a full-bridge, and 2 for a half-bridge)
  - b. **Gauge Factor:** ratio of mechanical strain to electrical output (a gauge specification).
  - c. **Gauge Resistance:** Enter the strain gauge ohm value (a gauge specification).
  - d. **Shunt Resistance:** 499000 ohms



**Figure 50 - Strain Wizard Settings**

**NOTE**

Touching sensors and test boards or charging the node battery while acquiring data may induce noise on sensitive sensor signals and is not recommended.

10. Select Calibrate.
11. Verify the calibration looks as shown in [Figure 51 - Strain Gauge Calibration](#). The green line represents the output of the strain gauge. With no load applied it should sit near the Auto Balance baseline value, represented by the red dashed line. During calibration, a shunt resistance (selected on the Parameters page) is applied across the strain bridge, shown by the square pulse on the output. The Offset value, shown with the dashed blue line, is the average output value of the pulse and should sit across the top of the pulse. If the gauge has not had time to equilibrate before sampling, or if varying environmental factors exist, spikes in the gauge output may occur and affect the Baseline and Offset values. If this occurs, the Offset and Baseline values can be adjusted to clip the spikes in the output values. Adjust them as needed, and select Accept when completed.

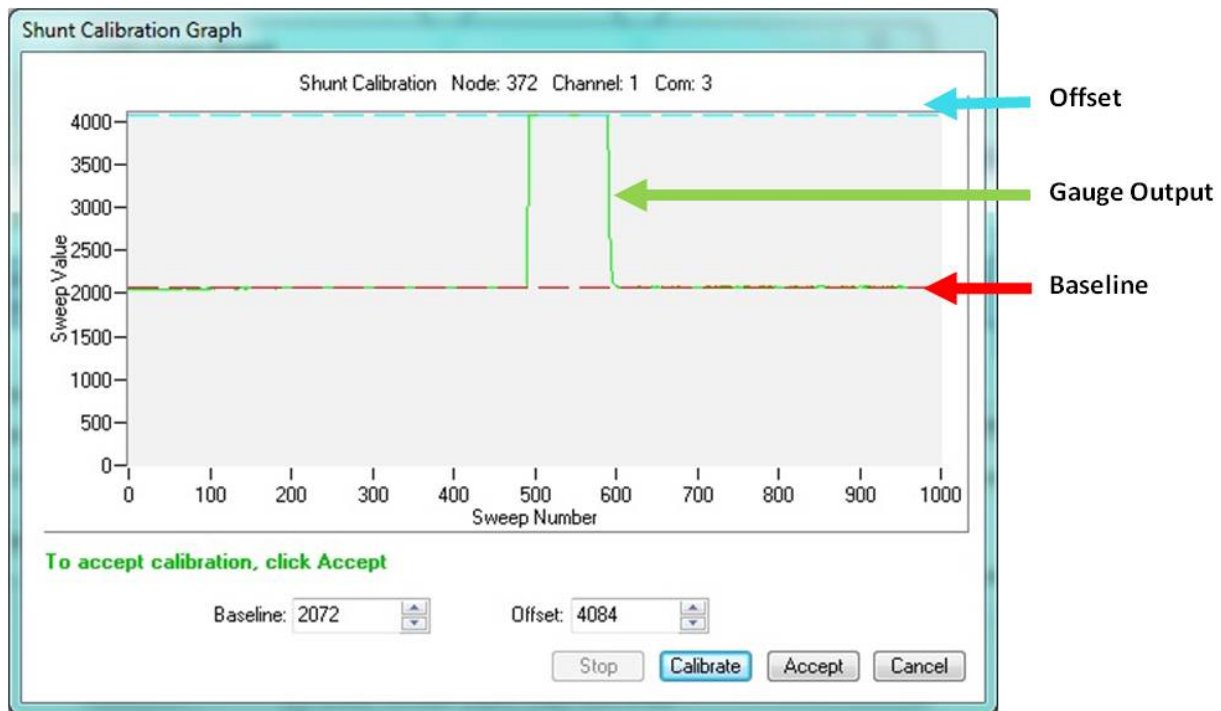

Figure 51 - Strain Gauge Calibration

12. Select Finish to end the Strain Wizard. Note the slope and offset values have been calculated automatically.

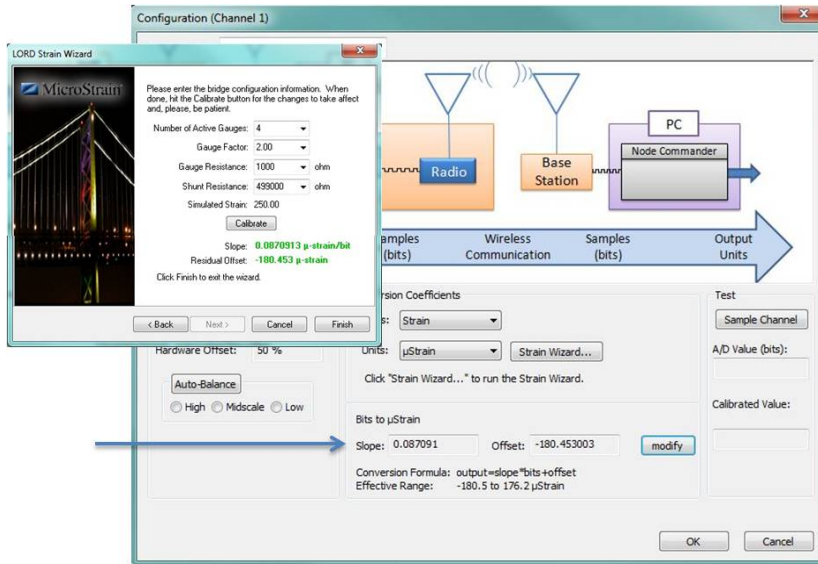

Figure 52 - Completed Strain Wizard

13. Select OK to exit the Channel Configuration window.
14. In the Node Configuration window, select Apply to write the configuration and calibration values to the node.
15. Select OK to exit.

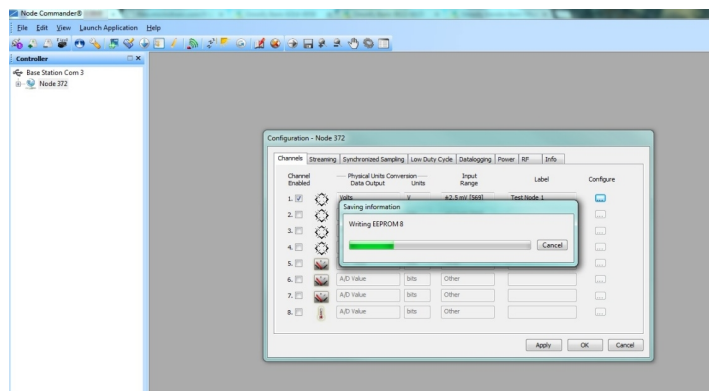

Figure 53 - Apply Node Settings

## 7. Powering the Node



Apply only the input voltage range specified for the node in the polarity indicated. Failure to do so could result in personal injury and permanent damage to the node ([see Safety Information on page 105](#)).

The node can be powered with either the internal battery or an external source. These sources cannot be used simultaneously; there is a switch on the node to select which source to use. When the node is manufactured, the switch is set to operate using the internal battery.

External battery holders and a ruggedized outdoor housing that accommodates two D cell batteries are also available for the SG-Link<sup>®</sup>-LXRS<sup>®</sup> and can be used to extend battery operating capacity and duration. For more information [see Node Accessories on page 97](#).



## 7.1 Selecting the Power Source

### **⚠ WARNING**

The SG-Link®-LXRS® contains an internal, rechargeable Lithium Polymer (Li-Po) battery. For important precautions see [Safety Information on page 105](#).

There is user-accessible switch to select the power source.

1. Verify the node power switch is in the OFF position and no external power is applied.
2. Use a small flat-head screwdriver to push the recessed switch fully to the desired position, as indicated in [Figure 54 - Power Source Selection](#). The figure shows the node configured for an internal power source.

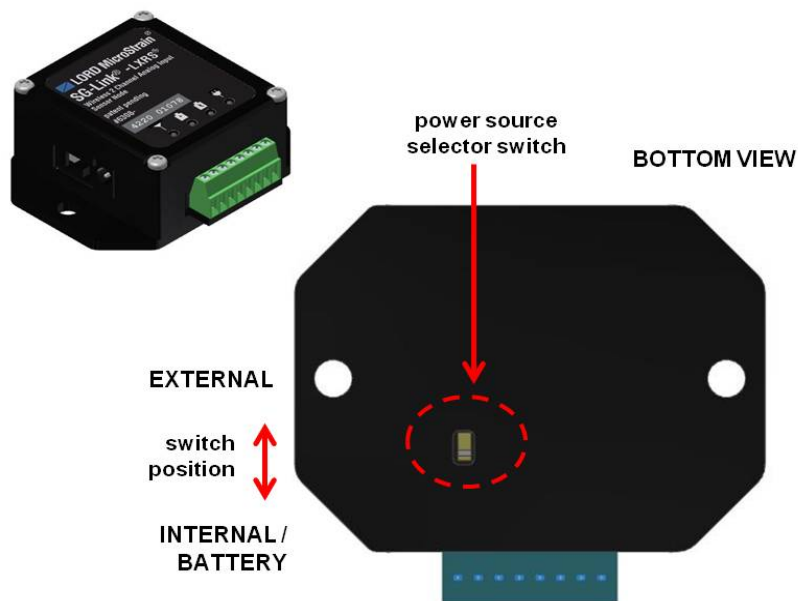

**Figure 54 - Power Source Selection**

## 7.2 Using the Internal Node Battery



**WARNING**

The SG-Link<sup>®</sup>-LXRS<sup>®</sup> contains an internal, rechargeable Lithium Polymer (Li-Po) battery. For important precautions see [Safety Information on page 105](#).

When the internal node switch is set for internal power, the node is powered by a rechargeable, 250 mAH lithium polymer battery. This battery is not user-serviceable.

Node battery life is highly dependent on the type of sensor connected, as well as operational parameters such as sample mode and rate. Higher sample rates equate to decreased battery life. The following graph shows an example approximation of the battery life for a SG-Link<sup>®</sup>-LXRS<sup>®</sup> with different strain gauge sensor configurations over a range of sample rates operating in Synchronized Sampling mode. For additional SG-Link<sup>®</sup>-LXRS<sup>®</sup> power specifications see [Power Profile on page 103](#).

Battery life approximation for the SG-Link<sup>®</sup> - LXRS<sup>®</sup> 250mAH internal battery

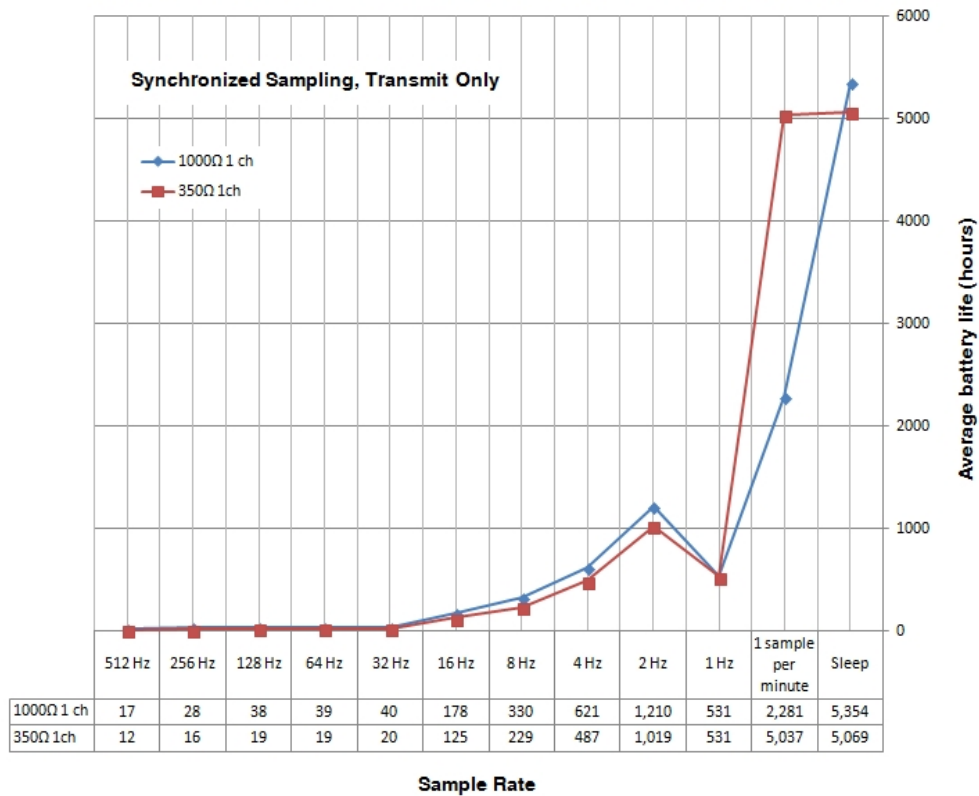

### 7.3 Charging the Node Battery

**⚠ WARNING**

Use only the power supply specified for the node to charge the battery. Using a power supply above the rated voltage could cause personal injury and permanent damage to the node. For important safety considerations [see Safety Information on page 105](#).

**NOTE**

Touching sensors and test boards or charging the node battery while acquiring data may induce noise on sensitive sensor signals and is not recommended.

1. Turn the node power switch off, and plug the node power supply into the node and then into a 120/240VAC, 50/60Hz AC power source. Use only the power supply specified for the node. Use the supplied power plug adapters, as needed.
2. Monitor the status of the charge indicators. For indicator meaning [see Device Status Indicators on page 82](#). Continue charging until the indicator turns green to indicate a completed charge. Charging takes approximately 6-8 hours from a full depletion.

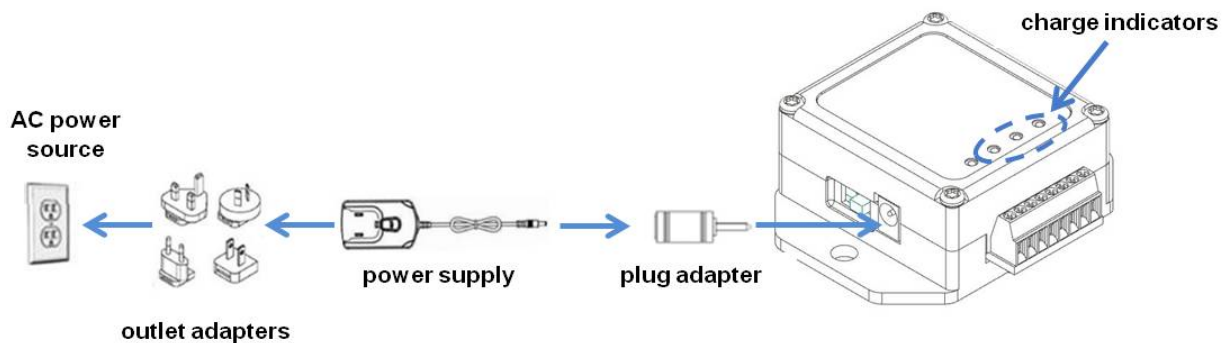

Figure 55 - Node Charging

### 7.4 Connecting an External Power Supply



Apply only the input voltage range specified for the node in the polarity indicated. Failure to do so could result in personal injury and permanent damage to the node ([see Safety Information on page 105](#)).

When the internal node switch is set for external power, the node may be directly powered by the power supply specified for charging the node (or another regulated AC to DC power supply with the appropriate output parameters, [see Operating Specifications on page 101](#)). It can also be powered by an external battery or other regulated DC supply. The supply must deliver a stable voltage between 3.2 and 9.0 V dc and be capable of sourcing at least 100 mA. Power supplies over 9 V dc, such as vehicle batteries, can be used by installing a step-down regulator (for SG-Link®-LXRS® power use specifications [see Power Profile on page 103](#)). External battery holders and ruggedized outdoor housings that accommodate D cell batteries are available for the SG-Link®-LXRS® ([see Node Accessories on page 97](#)).

External power is applied through either the power supply jack, or the terminal block connectors. Do not connect both. Observe connection polarities, or the node may be damaged.

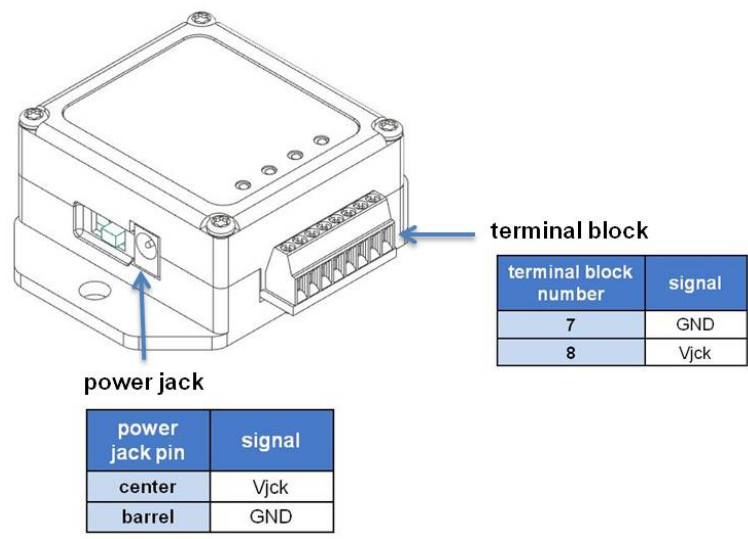
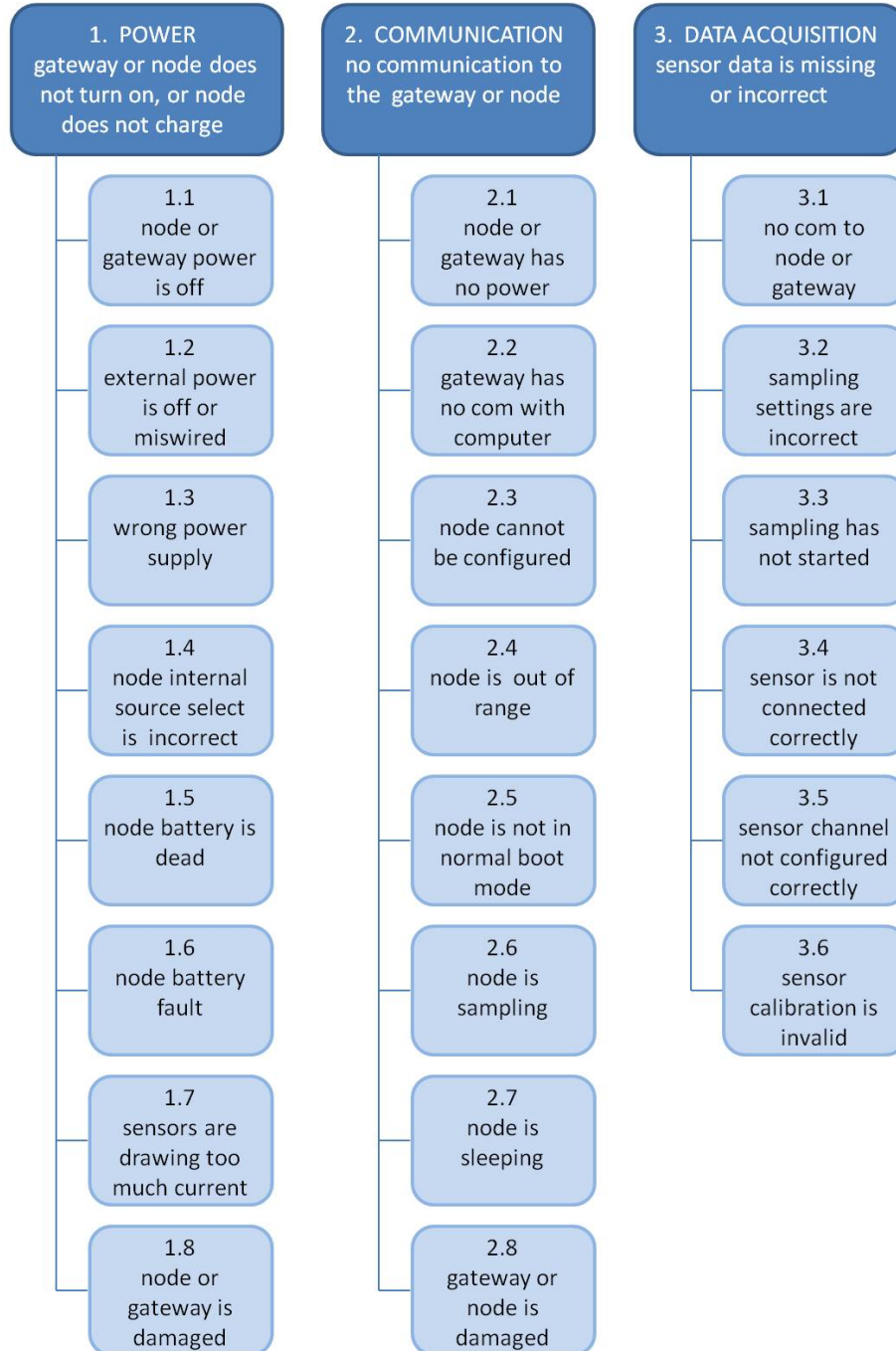

Figure 56 - External Power Connections

## 8. Troubleshooting

### 8.1 Troubleshooting Guide



Problem	Possible cause and recommended solution
<p><b>1. POWER</b></p> <p><b>gateway or node does not turn on, or node does not charge</b></p>	<p><b>1.1 node or gateway power is off</b></p> <p>The status indicator LED on the device may be off. Turn the device on, and the status indicator LED should illuminate.</p>
	<p><b>1.2 external power is off or miswired</b></p> <p>Verify the device power source is connected correctly and powered on.</p>
	<p><b>1.3 wrong power supply</b></p> <p>Using a power supply other than the one specified for the device (or an external supply that is outside of the device operating range) could result in permanent damage to the device or cause it to not work properly.</p>
	<p><b>1.4 node internal source select switch is incorrect</b></p> <p>When the node is manufactured, it is set to internal battery operation, but it can be configured to accept an external source. When set to accommodate an external source, the battery cannot be charged.</p>
	<p><b>1.5 node battery is dead</b></p> <p>If the node power source selector is set to internal, and the node will not power on or charge, the node battery may need to be replaced. Contact LORD MicroStrain® Technical Support (<a href="#">See Technical Support on page 94</a>).</p>
	<p><b>1.6 node battery fault</b></p> <p>If the battery charge indicator on the node is only dimly illuminated when charging is attempted, a battery fault condition has occurred. Unplug power, and then plug it back in. The indicator should turn on brightly, indicating charging.</p>
	<p><b>1.7 sensors are drawing too much current</b></p> <p>The node battery can only supply a limited amount of power to the connected sensors. If an over-current condition occurs, the node will shut down. Consider powering the node or sensors with an external source.</p>

Problem	Possible cause and recommended solution
	<p><b>1.8 node or gateway is damaged</b></p> <p>If all power settings and connections have been verified, and the node is still unresponsive, contact LORD MicroStrain® Technical Support (<i>See Technical Support on page 94</i>).</p>
<p><b>2. COMMUNICATION</b></p> <p><b>no communication to the gateway or node</b></p>	<p><b>2.1 node or gateway has no power</b></p> <p>Verify the node and gateway have power applied and that applicable power switches are on. Power is indicated on both devices by a status indicator LED.</p>
	<p><b>2.2 gateway has no communication with the computer</b></p> <p>Verify gateway communication in the software. Check, remove, and reconnect communications and power cables as applicable.</p> <ul style="list-style-type: none"> <li>• For serial gateways, verify that the COM port setting.</li> <li>• For USB gateways, verify that the drivers are installed on the computer (included with Node Commander®) and that the software has had sufficient time to detect it.</li> <li>• For Ethernet gateways, use Live Connect™ to verify communications on a DHCP network. Check that the extended timeouts are enabled in the Node Commander® Edit &gt; Preferences menu, under Devices. Once communication has been established, the network configuration can be changed.</li> </ul>
	<p><b>2.3 node cannot be configured</b></p> <p>Observe the node status indicator LED to determine the device's state: boot, idle, sample, or sleep. If the node is sampling or sleeping, it cannot be configured. In Node Commander®, execute the Stop Node command to put the node in idle state, allowing configuration to occur.</p> <p>If the user inactivity timeout is set very low, the configuration menu will have to be entered quickly, before the timeout occurs, putting the node back in a sample or sleep state.</p>

Problem	Possible cause and recommended solution
	<p><b>2.4 node is out of range</b></p> <p>Perform a bench test with the node in close proximity to the gateway to verify they are operational. For range test and installation recommendations <a href="#">see Range Test on page 33</a>. The system has been tested to operate with the node and gateway up to 2 km apart with clear line of sight.</p>
	<p><b>2.5 node is not in normal boot mode</b></p> <p>If the node status indicator shows the node booting in a mode other than the normal boot mode, it can be bypassed by toggling the node ON/OFF switch rapidly three times, then leaving it in the ON position for normal power up. In normal boot mode the communication can be established with automatic node discovery (or manually) once the boot process is complete and the node is in idle state. Start-up mode can then be changed in the software.</p>
	<p><b>2.6 node is sampling</b></p> <p>Observe the node status indicator LED to determine the device's state: boot, idle, sample, or sleep. If the node is sampling, it cannot be configured. In Node Commander®, execute the Stop Node command to put the node in idle state, allowing configuration to occur.</p>
	<p><b>2.7 node is sleeping</b></p> <p>Observe the node status indicator LED to determine what state it is: boot, idle, sample, or sleep. If the node is sleeping, it cannot be configured. In Node Commander®, execute the Stop Node command to put the node in idle state, allowing configuration to occur.</p>
	<p><b>2.8 gateway or node is damaged</b></p> <p>Verify all connections, power, and settings. If available, try installing alternate nodes and gateways one at a time to see if the faulty device can be identified. If no conclusion can be determined or to send a device in for repair, contact LORD MicroStrain® Technical Support (<a href="#">See Technical Support on page 94</a>).</p>
	<p><b>3.1 no communication to node or gateway</b></p>



Problem	Possible cause and recommended solution
<p><b>3. DATA ACQUISITION</b> <b>sensor data is missing or incorrect</b></p>	<p>Verify connections and power to the node and gateway. Verify they are powered on and communicating with the software. Enter a configuration menu to verify that the node can be accessed.</p>
	<p><b>3.2 sampling settings are incorrect</b></p> <p>If the sampling mode, rate, or duration are not performing as expected, enter the node configuration menu, and verify the sampling settings.</p>
	<p><b>3.3 sampling has not started</b></p> <p>If sampling is occurring, the sampling mode will be displayed next to the node name in Node Commander®. The node device status indicator will also be flashing the sampling mode code. If the node is not sampling, activate it in the software or with a sample on start up boot sequence.</p>
	<p><b>3.4 sensor is not connected correctly</b></p> <p>Verify sensors connections and wiring. For non-standard connections contact LORD MicroStrain® Technical Support (<a href="#">See Technical Support on page 94</a>).</p>

## 8.2 Device Status Indicators

The following is a complete list of the SG-Link®-LXRS® status indicators.





Indicator	Symbol	Behavior	Node Status
Battery charge source indicator		OFF	No power source detected
		ON green	Charging source detected
Battery charged indicator		OFF	Node not charging
		ON bright red	Node battery charging
Completed charge indicator		OFF	Node charge status unknown
		ON green	Battery fully charged
		ON green and battery charging indicator ON red	Battery fault condition. Reset by unplugging power and then plugging it back in
Device status indicator		OFF	Node OFF or sleeping
		OFF, with occasional flash	Node sleeping with radio check intervals enabled (default is every 5 seconds)
		Ten rapid flashes when power is initially applied	Node booting normally and sending out a status message
		1 second pulse	Node idle
		Continuously ON	Node datalogging or streaming data
		1 Hz pulse green	Node is sampling in low duty cycle or synchronized sampling
		Pulses for each ping	Node is sending out communication requests (such as in ping command, range test, or EEPROM read/write)
		Four to seven slow pulses when power is initially applied	Fault condition

Table 6 - Device Status Indicators

### 8.3 Using the Node Tester Board

The node tester board is used to verify node and network functions before sensors are connected, or for diagnostic purposes. The node tester board provides a fixed load so system functions can be verified including basic operations not related to the sensor, such as communication and sampling. A fixed load is applied to the differential input by pressing the load button. The SG-Link<sup>®</sup>-LXRS<sup>®</sup> also features a photo cell that can be used to apply a variable load the single-ended channel. Adjust the load by changing the amount of light on the face of the photo cell.

There are various impedance value node tester boards available, depending on the node it is being used with. *See Parts and Configurations on page 96* for configuration options and part numbers. Each is configurable to emulate full, half and quarter bridge strain gauges. *Table 7 - Tester Board Configuration* describes the strain gauge load settings available. This setting must match the type of node channel that is being tested. For example if the node is a quarter-bridge node, the setting on the tester board must be the same. The configuration chart is also printed on the underside of the board.

**NOTE**

The switches may come with a protective film covering them. Simply peel the film off to access the switches.

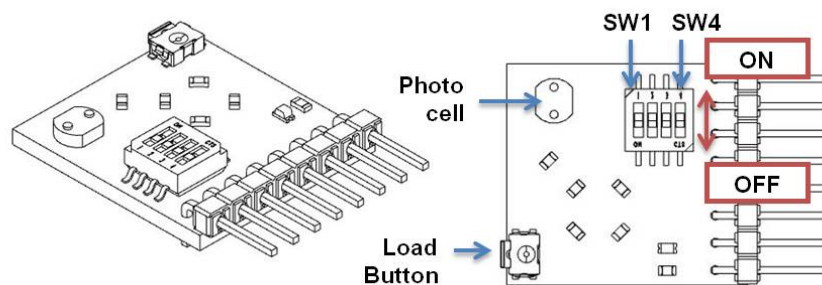

Configuration	SW 1 position	SW 2 position	SW 3 position	SW 4 position
Full Bridge	ON	ON	ON	OFF
Half Bridge	OFF	OFF	ON	OFF
Quarter Bridge	OFF	OFF	OFF	ON

**Table 7 - Tester Board Configuration**

The following steps describe an example of how to use the tester board to sequence through the primary functions of the node and the wireless system. If the results indicated in the final steps are achieved, the system is fully operational for measuring a full bridge strain gauge. Other scenarios can be tested as needed.

1. Set the jumpers for Full Bridge operation, using a small flat head screw driver to fully push the switch into the desired position.
2. Verify the node is powered off and unplugged.
3. Plug the node tester board into the node in the orientation shown, and screw the board in place.

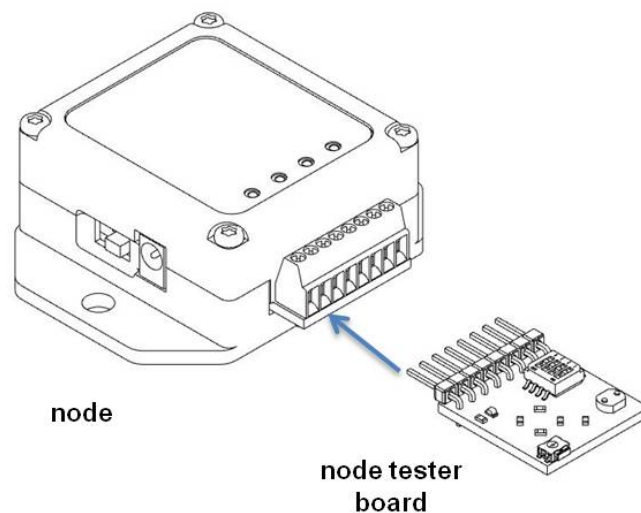

**Figure 57 - Node Tester Board Installation**

4. If not already completed, set up the Wireless Sensor Network equipment and install the Node Commander® software. [See System Operational Overview on page 12.](#)
5. Launch the Node Commander® software, and establish communications with the gateway and node.

- Enter the node channel configuration menu by right-clicking on the node heading in Node Commander® and selecting Configure > Configure Node, and then the Channels tab.

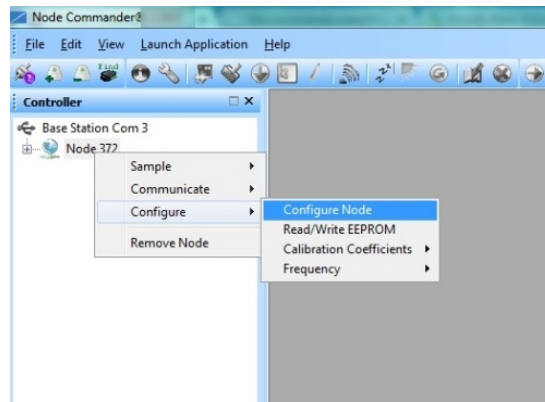

**Figure 58 - Node Configuration Menu**

- Select the check box for Channel 1, which is where the Node Tester Board is installed, and then select Configure.

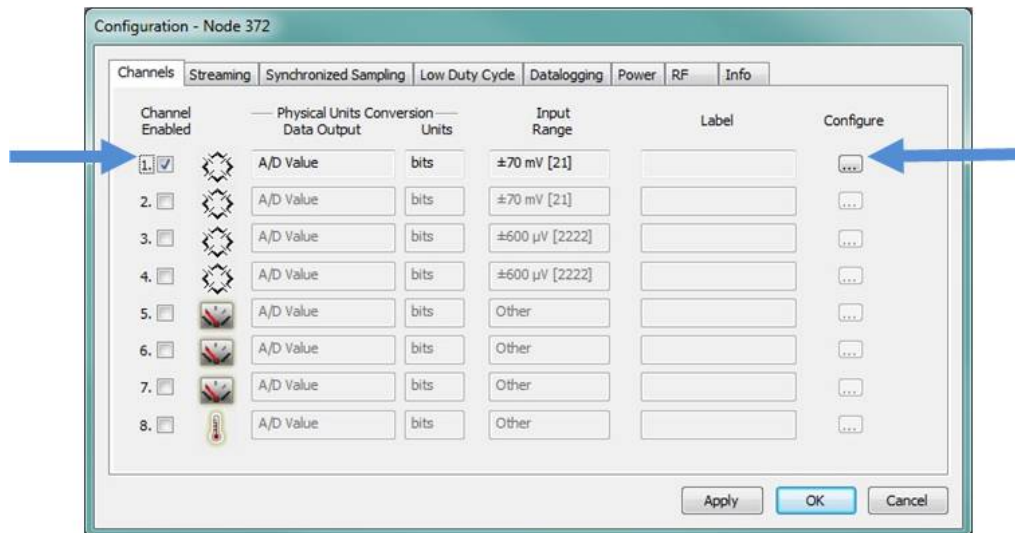

**Figure 59 - Node Channel Configuration**

8. Use the following settings for the node tester board.
  - a. **Conversion Coefficients, Units:**  $\mu$ Strain
  - b. **Conversion Coefficients, Class:** Strain
  - c. **PGA Settings, Input Range:**  $\pm 2.5\text{mV}$
  - d. **PGA Setting:** Midscale
9. Select the Auto Balance button to tare the no load value of the tester board.

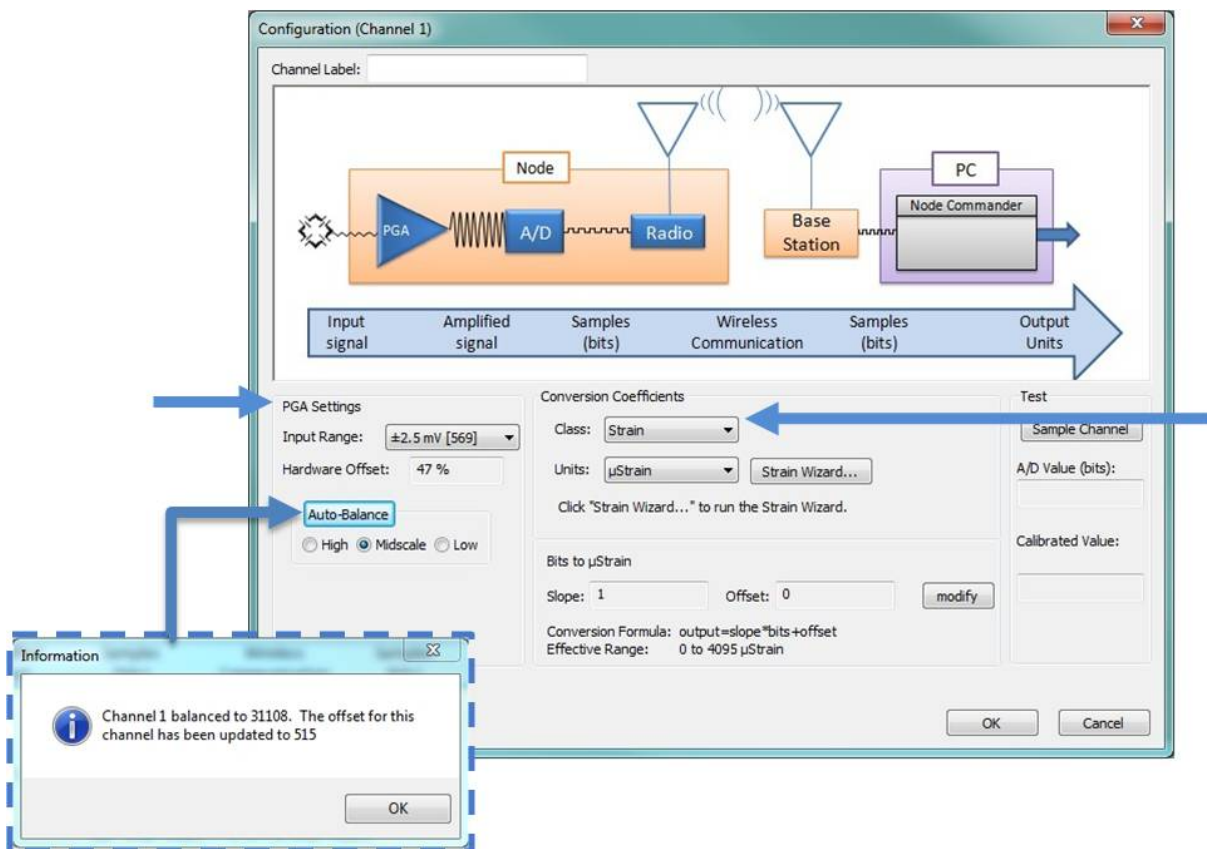
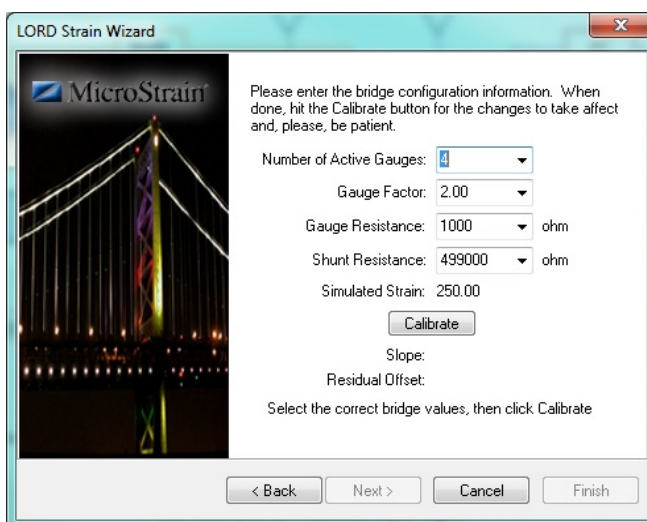

Figure 60 - Channel Settings

10. Select the Strain Wizard.
11. Select Full Bridge for the Bridge Type and click Next.
12. Select Use the Strain Measurement Wizard, and click Next.
13. Set the following for the Node Tester Board
  - a. **Number of Active Gauges:** 4
  - b. **Gauge Factor:** 2
  - c. **Gauge Resistance:** Enter the node tester board ohm value.
  - d. **Shunt Resistance:** 499000 ohms



**Figure 61 - Strain Wizard Settings**

14. Select Calibrate.
15. Verify the calibration looks as shown in *Figure 62 - Strain Gauge Calibration*. The green line represents the output of the strain gauge. With no load applied it should sit near the Auto Balance baseline value, as shown, and is represented by the red dashed line. During calibration, a shunt resistance (selecting on the Parameters page) is applied across the strain bridge, shown by the square pulse on the output. The Offset value, shown with the dashed blue line, is the average output value of the pulse and should sit across the top of the pulse. If the gauge has not had to time to equilibrate before sampling, or varying environmental factors exist, spikes in the gauge output may occur and affect the Baseline and Offset values. If this occurs, the Offset and Baseline values can be adjusted to clip the spikes in the output values. Adjust them as needed, and select Accept when completed.



Figure 62 - Strain Gauge Calibration



16. Select Finish to end the Strain Wizard. Note that the slope and offset values have been calculated.

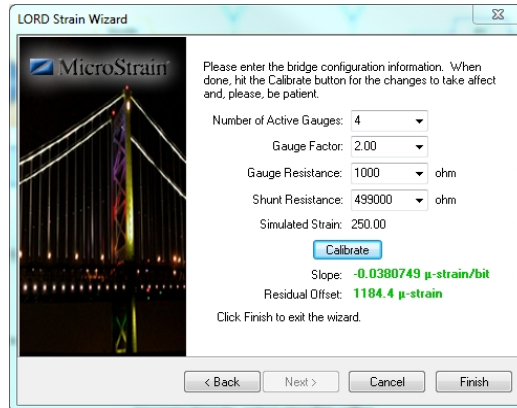

**Figure 63 - Completed Strain Wizard**

17. Select OK to exit the channel Configuration window.
18. In the Node Configuration window, select the Streaming tab. Uncheck Continuous Streaming, and set the Time Duration to 15 seconds.
19. Select Apply to write configuration and calibration values to the node. Select OK to exit.

**NOTE**

Touching sensors and test boards or charging the node battery while acquiring data may induce noise on sensitive sensor signals and is not recommended.

**NOTE**

There are many sampling options available in the Node Commander® software. The following describes just one option, for illustrative purposes.

20. Right-click on the Node heading and then select Sample > Stream > Start.
21. As soon as Start is selected, the node will start collecting data for a duration of 15 seconds. During that time, press and release the load button on the node tester board to shunt the resistive load on and off. Verify the result is as shown in the figure below. The pulse value should equal tester board ohm value. Testing is complete.

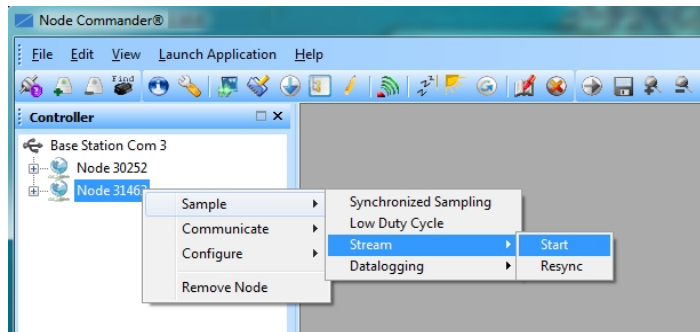

**Figure 64 - Node Sampling Menu**

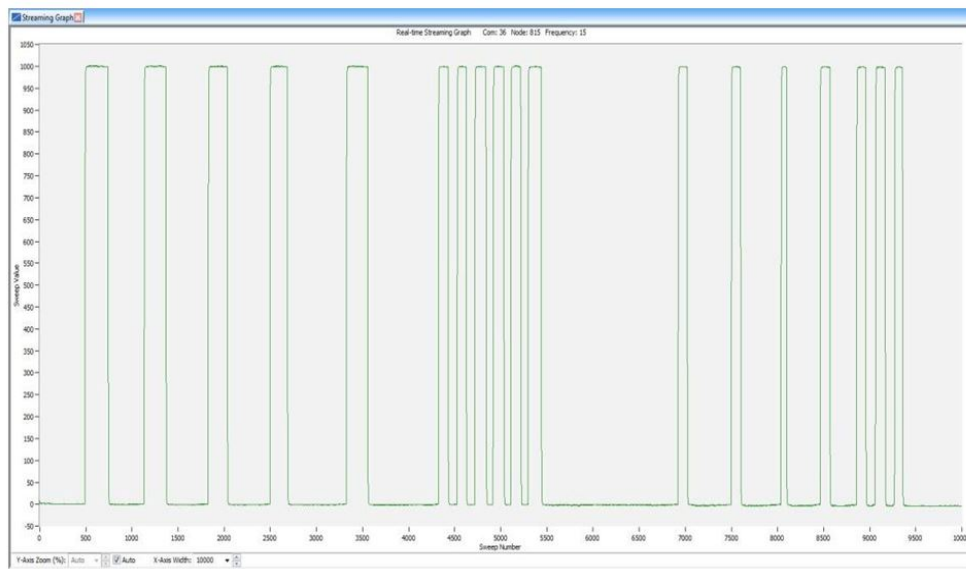

**Figure 65 - Node Tester Output Stream**

## 8.4 Updating Node Firmware

Under the recommendation of LORD MicroStrain® Technical Support Engineers, nodes can be upgraded to the latest available firmware to take advantage of new features or correct operating issues. Node Commander® version 2.7.0 or greater can be used to update any mXRS® or LXRS® node or gateway firmware to the most current version. Updates are found on the LORD MicroStrain® website. [See Technical Support on page 94](#) for contact and website information.

1. Download the LXRS® Firmware Upgrade file from the LORD MicroStrain® website.
2. Once downloaded, extract the contents of the .zip file into a folder on the computer. Verify there is a file with a .zhex extension.
3. Launch Node Commander®, and establish communication between the node and gateway as normal.
4. While holding F1 button on the keyboard, right-click the node name, and a drop-down menu will appear.

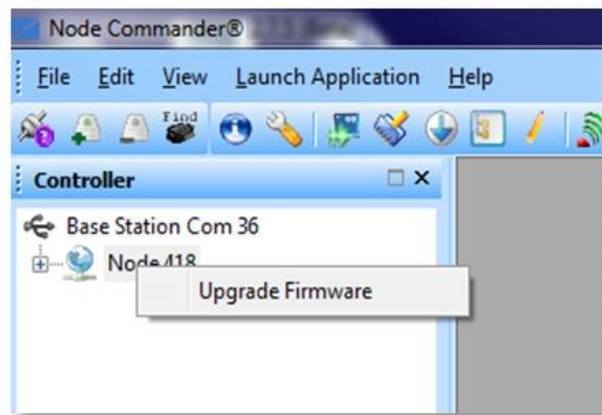

Figure 66 - Update Node Firmware



## 8.5 Repair and Calibration

The SG-Link®-LXRS® has no components which require factory calibration and certification.



### General Instructions

In order to return any LORD MicroStrain® product, you must contact LORD MicroStrain® Sales or Technical Support to obtain a Return Merchandise Authorization number (RMA). All returned merchandise must be in the original packaging including manuals, accessories, cables, etc. with the RMA number clearly printed on the outside of the package. Removable batteries should be removed and packaged in separate protective wrapping. Please provide the LORD MicroStrain® model number and serial number as well as your name, organization, shipping address, telephone number, and email. Normal turn-around for RMA items is seven days from receipt of item by LORD MicroStrain®.



### Warranty Repairs

LORD MicroStrain® warrants its products to be free from defective material and workmanship for a period of one (1) year from the original date of purchase. LORD MicroStrain® will repair or replace, at its discretion, a defective product if returned to LORD MicroStrain® within the warranty period. This warranty does not extend to any LORD MicroStrain® products which have been subject to misuse, alteration, neglect, accident, incorrect wiring, misprogramming, or use in violation of operating instructions furnished by us. It also does not extend to any units altered or repaired for warranty defect by anyone other than LORD MicroStrain®.



### Non-Warranty Repairs

All non-warranty repairs/replacements include a minimum charge. If the repair/replacement charge exceeds the minimum, LORD MicroStrain® will contact the customer for approval to proceed beyond the minimum with the repair/replacement.

## 8.6 Technical Support

There are many resources for product support found on the LORD MicroStrain® website, including technical notes, FAQs, and product manuals.

[http://www.microstrain.com/support\\_overview.aspx](http://www.microstrain.com/support_overview.aspx)

For further assistance our technical support engineers are available to help with technical and applications questions.

### Technical Support

[sensing\\_support@LORD.com](mailto:sensing_support@LORD.com)

**Phone:** 802-862-6629

**Fax:** 802-863-4093

**SKYPE:** microstrain.wireless.support

Live Chat is available from the website during business hours:  
9:00 AM to 5:00 PM (Eastern Time US & Canada)

## 9. Maintenance

There are no user-serviceable parts on the SG-Link®-LXRS®. For device service and repair contact LORD MicroStrain® Technical Support ([see \*Technical Support on page 94\*](#)). Opening the device will void the product warranty.

## 10. Parts and Configurations

### 10.1 Standard Nodes

For the most current product information, custom, and OEM options not listed below, refer to the LORD MicroStrain® website or contact the LORD MicroStrain® Sales Department.

Model Number	Description	LORD MicroStrain® Part Number
SG-LINK-LXRS	<ul style="list-style-type: none"> <li>• One differential analog channel</li> <li>• One single ended analog channel</li> <li>• Internal temperature sensor</li> </ul>	6308-3000

#### Configuration Options (Required for use. Specify at time of order)

- **Full-bridge configuration** on differential channels.
- **350Ω or 1000Ω half-bridge** completion on differential channels.
- **350Ω or 1000Ω quarter-bridge** completion on differential channels.
- **High g-force** option. Node operates in gravitational forces in excess of 550 g.



## 10.2 Node Accessories

The following parts are available for use with the SG-Link®-LXRS®. For the most current product information, custom, and OEM options not listed below, refer to the LORD MicroStrain® website or contact the LORD MicroStrain® Sales Department. [See Product Ordering on page 99.](#)

Description	LORD MicroStrain® Part Number
Charging power supply for SG-Link®-LXRS® with international plug adapters	6302-1000
IP66/NEMA4 rated rugged outdoor enclosure for SG-Link®-LXRS®	6309-3000
IP66/NEMA4 rated rugged outdoor enclosure for SG-Link®-LXRS® with two D cell battery capacity	6309-4000
IP66/NEMA4 rated rugged outdoor enclosure for SG-Link®-LXRS® with three D cell battery capacity	6309-5000
Magnetic mounting strips for outdoor enclosure	6302-4000
350Ω node tester board	6309-6000
1000Ω node tester board	6309-7000
Inductive remote power starter for nodes	6303-0300
D cell battery tray for use with wireless nodes (indoor use)	6302-0200
AA cell battery tray for use with wireless nodes (indoor use)	6302-0300
Lithium D cell battery 19 Ah capacity	6302-0000
Lithium AA cell battery 2 Ah capacity	6302-0100

**Table 8 - Node Accessories**

### 10.3 Wireless System Equipment

The following system parts are available for use with the SG-Link®-LXRS®. For the most current standard, custom, and OEM product options, refer to the LORD MicroStrain® website or contact the LORD MicroStrain® Sales Department. [See Product Ordering on page 99.](#)

Model	Description	LORD MicroStrain® Part Number
WSDA-1500-SK	Ethernet Data Gateway Starter Kit	6314-1501
--	Node Commander® Software	6301-0300
--	SensorCloud™ Software Subscription (contact LORD MicroStrain® Sales)	--
WSDA-BASE-104-SK	USB Gateway Starter Kit	6307-1041
WSDA-BASE-102-SK	RS232 Gateway Starter Kit.	6307-1021
WSDA-BASE-101-SK	Analog Gateway Starter Kit	6307-1011
--	Replacement USB cable	9022-0029
--	USB Gateway cable extender	6307-0900
--	Replacement serial cable	4005-0005
WSDA-1500	Ethernet Data Gateway	6314-1500
WSDA-BASE-104	USB Gateway	6307-1040
WSDA-BASE-102	RS232 Serial Output Gateway	6307-1020
WSDA-BASE-101	Analog Output Gateway	6307-1010
G-Link-LXRS	Wireless Accelerometer Node	various models
G-Link2-LXRS	Wireless Accelerometer Node	various models
SG-Link-OEM	Wireless 2-Channel Analog Input Sensor Node	various models
SG-Link-RGD	Ruggedized Wireless Analog Sensor Input Node	various models
V-Link-LXRS	Wireless 7-Channel Analog Input Sensor Node	various models
TC-Link-LXRS	Wireless Thermocouple Node	various models
DVRT-Link-LXRS	Wireless Displacement Sensor Node	various models
ENV-Link-Pro	Wireless Environmental Sensor Node	various models
Watt-Link-LXRS	Wireless Energy Monitoring Sensor Node	various models
RTD-Link-LXRS	Wireless RTD Sensor Node	various models
IEPE-Link -LXRS	Wireless IEPE Accelerometer Node	various models

**Table 9 - Wireless System Equipment**

## 10.4 Product Ordering

Products can be ordered directly from the LORD MicroStrain® website by navigating to the product page and using the Buy feature.

<http://www.microstrain.com/wireless>

For further assistance, our sales team is available to help with product selection, ordering options, and questions.

### Sales Support

[sensing\\_sales@LORD.com](mailto:sensing_sales@LORD.com)

**Phone:** 802-862-6629

**Fax:** 802-863-4093

9:00 AM to 5:00 PM (Eastern Time US & Canada)

## 11. Specifications

### 11.1 Physical Specifications

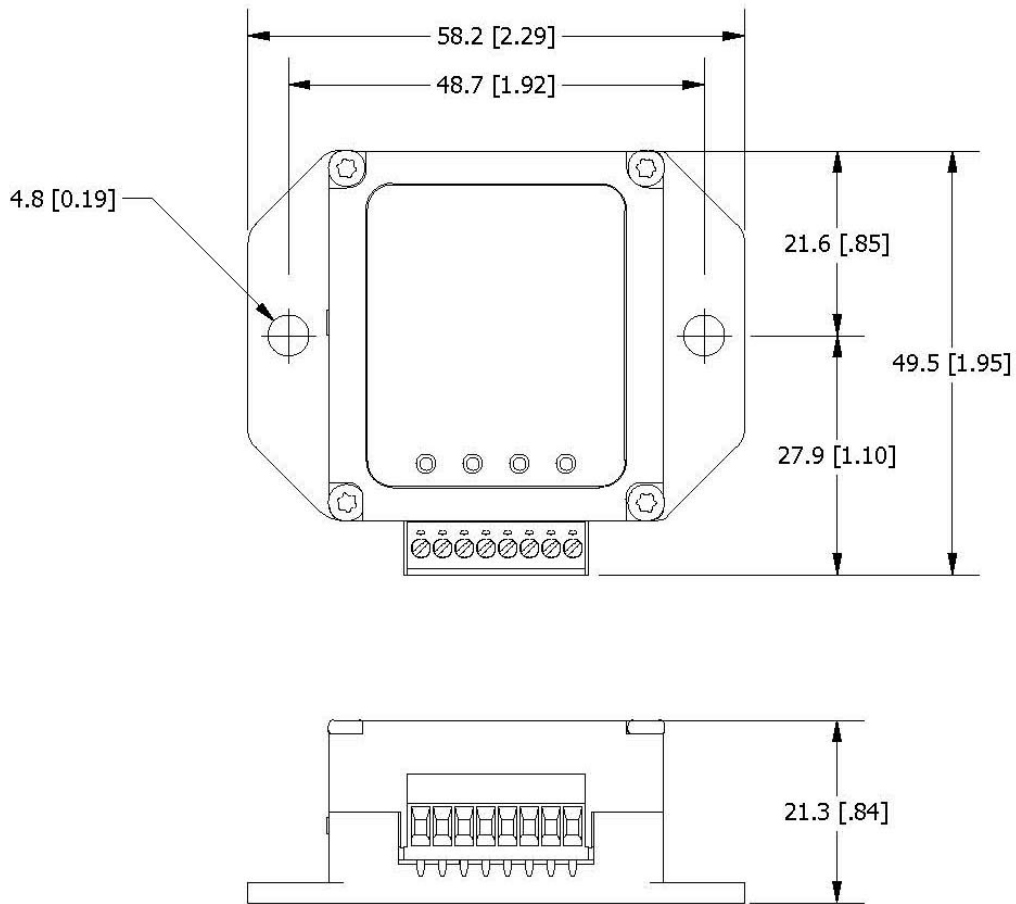

**Dimensions:** 58 mm x 50 mm x 21 mm

**Weight:** 42 grams

**Enclosure Environmental Rating:** General purpose indoor  
(IP67/NEMA4X rated enclosure available)

## 11.2 Operating Specifications

Parameter	Specifications
<b>General</b>	
Sensor input channels	<b>Differential analog</b> , 1 channel <b>Single-ended analog</b> , 1 channel
Integrated sensors	<b>Internal temperature</b> , 1 channel
Options	Half and 1/4 bridge, 350 Ω or 1000 Ω completion on any or all channels, custom gain, custom anti-aliasing filter, extended operating temperature, g-force, and environmental packaging, low RF radiated power
Data storage capacity	2 M bytes (up to 1,000,000 data points, data type dependent)
<b>Analog Input Channels</b>	
Measurement range	Differential: full-bridge, ≥ 350 Ω (factory configurable) Single-ended: 0 to 3 V dc
Accuracy	± 0.1% full scale typical
Resolution	12 bit
Anti-aliasing filter bandwidth	Single-pole Butterworth -3 dB cutoff @ 250 Hz (factory configurable)
Bridge excitation voltage	+3 V dc, 50 mA total for all channels (pulsed @ sample rates ≤ 16 Hz to conserve power)
Measurement gain and offset	User-selectable in software on differential channels, gain values from 104 to 1800
<b>Integrated Temperature Channel</b>	
Measurement range	-40 °C to 85 °C
Accuracy	± 2 °C (at 25 °C) typical
Resolution	12 bit
<b>Sampling</b>	
Sampling modes	Synchronized, low duty cycle, datalogging
Sampling rates	<b>Continuous sampling:</b> 1 sample/hour to 512 Hz <b>Periodic burst sampling:</b> 32 Hz to 4096 Hz <b>Datalogging:</b> 32 Hz to 4096 Hz
Sample rate stability	±3 ppm
Network capacity	Up to 2000 nodes per RF channel (and per gateway) depending on the number of active channels and sampling settings. Refer to the system bandwidth calculator: <a href="http://www.microstrain.com/configure-your-system">http://www.microstrain.com/configure-your-system</a>
Synchronization between nodes	± 32 μsec
Event driven monitoring	User-definable threshold trigger (synchronized and low duty cycle modes), 200K bytes pre- event recording
<b>Operating Parameters</b>	
Wireless communication range	Outdoor/line-of-sight: 2 km (ideal) *, 800 m (typical)** Indoor/obstructions: 50 m (typical)**
Radio frequency (RF) transceiver carrier	2.405 to 2.470 GHz direct sequence spread spectrum over 14 channels, license free worldwide, radiated power programmable from 0 dBm (1 mW) to 16 dBm (39 mW); low power option available for use outside the U.S. - limited to 10dBm (10mW)
RF communication protocol	IEEE 802.15.4
RF data downloading	4.5 minutes to download full memory
Power source	Internal: 3.7 V dc, 250 mAh Lithium ion rechargeable battery External: +3.2 to +9.0 V dc
Power consumption	See power profile : <a href="http://files.microstrain.com/SG-Link-LXRS-Power-Profile.pdf">http://files.microstrain.com/SG-Link-LXRS-Power-Profile.pdf</a>
Operating temperature	-20 °C to +60 °C (extended temperature range available with custom battery/enclosure, -40 °C to +85 °C electronics only)
Status LED's	AC power, battery charging, battery charged, node activity
Acceleration limit	500 g standard (high g option available)

Parameter	Specifications
<b>Physical Specifications</b>	
Dimensions	58 mm x 50 mm x 21 mm
Weight	42 grams
Environmental rating	Indoor use (IP65/66 enclosures available)
Enclosure material	ABS plastic
<b>Integration</b>	
Compatible gateways	All WSDA® base stations and gateways
Compatible sensors	Bridge type analog sensors, 0 to 3 V dc analog sensors
Connectors	Screw terminal block
Shunt calibration	Internal shunt calibration resistor 499 KΩ, differential channel
Software	SensorCloud™, SensorConnect™, Node Commander®, Windows XP/Vista/7
Software development kit (SDK)	Data communications protocol available with EEPROM maps and sample code (OS and computing platform independent) <a href="http://www.microstrain.com/wireless/sdk">http://www.microstrain.com/wireless/sdk</a>
Regulatory compliance	FCC (U.S.), IC (Canada), CE, ROHS

\*Measured with antennas elevated, no obstructions, and no RF interferers.

\*\*Actual range varies depending on conditions such as obstructions, RF interference, antenna height, & antenna orientation.

### 11.3 Power Profile

Node power use is highly dependent on the number and type of sensors connected and operational parameters such as sample mode and rate. More active channels and higher sample rates equate to increased power use. Below is an example approximation of the power use of a SG-Link<sup>®</sup>-LXRS<sup>®</sup> with different strain gauge sensor configurations over a range of sample rates operating in Synchronized Sampling mode. This chart can be used to approximate external node power source requirements. For SG-Link<sup>®</sup>-LXRS<sup>®</sup> internal battery life specifications [see Using the Internal Node Battery on page 74](#).

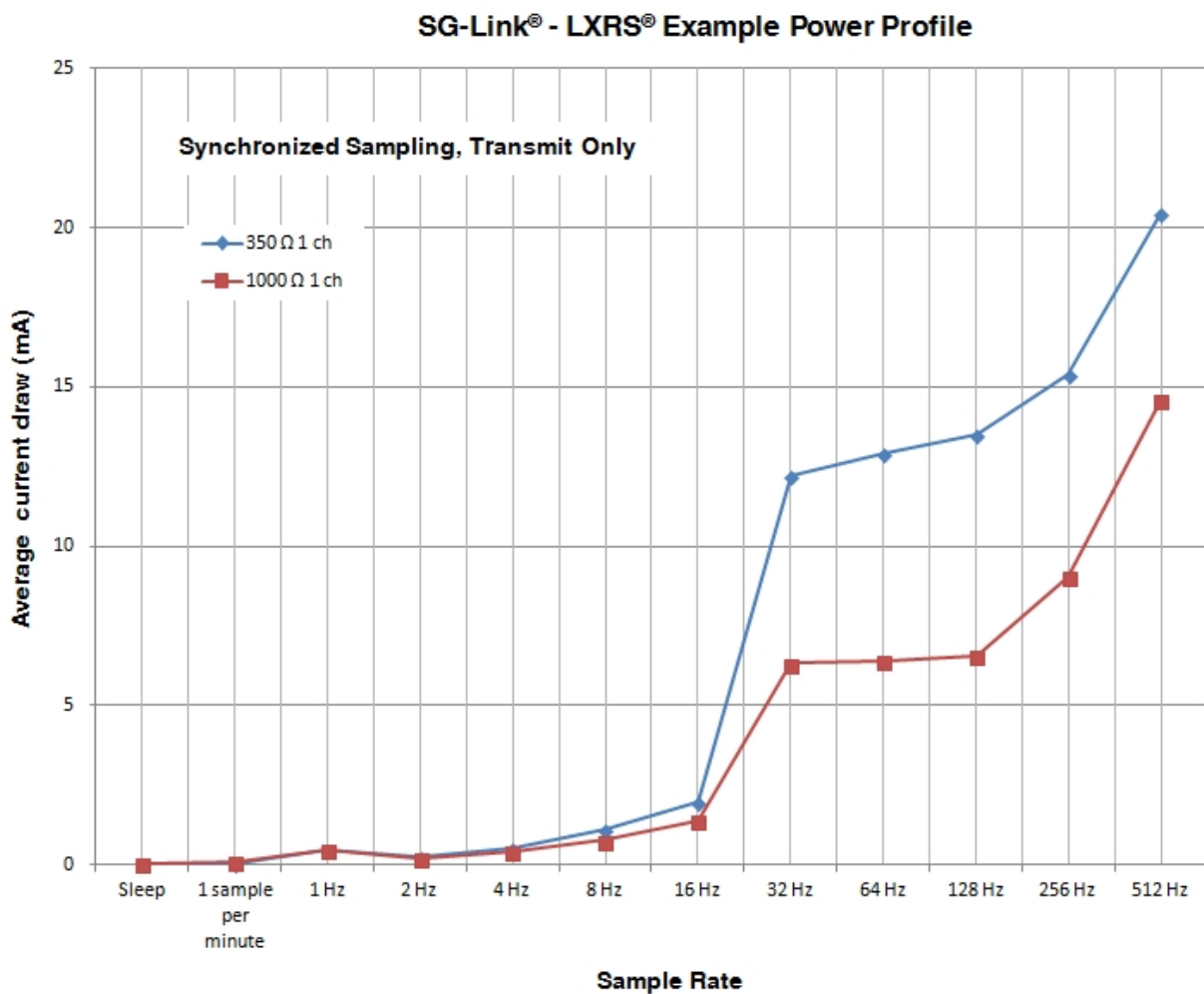

Figure 68 - Example SG-Link<sup>®</sup>-LXRS<sup>®</sup> Power Profile

## 11.4 Radio Specifications

The SG-Link®-LXRS® Wireless Sensor Node employs a 2.4GHz IEEE 802.15.4 compliant radio transceiver for wireless communication. The radio is a direct-sequence spread spectrum radio and can be configured to operate on 14 separate frequencies ranging from 2.405 GHz to 2.470 GHz. Following the 802.15.4 standard, these frequencies are aliased as channels 11 through 24. For all newly manufactured nodes, the default setting is 2.425 GHz (channel 15).

For standard models, radiated transmit power is programmable from 0 dBm (1 mW) to 16 dBm (39 mW). A low-transmit power option is available (for use in Europe and elsewhere) and is limited to 10 dBm (10 mW).

The radio complies with FCC Part 15 (USA) and IC (Canada) regulations. The radio is license-free worldwide. Using antennas and transmission equipment other than what is provided may void FCC compliance.

### NOTE

- The gateway can automatically manage nodes operating on different frequencies by using the Node Discovery feature in Node Commander®. In this routine, the gateway listens for node broadcasts on the frequency channel to which it is set. If the node is in normal boot-up mode, it will provide the broadcast when it is initially powered-on, and it will broadcast on all channels. As long as the node is powered-on after activating the Node Discovery feature, the gateway will link to it and remember the channel setting for future node queries.
- Manually matching the node and gateway frequency channels is required in some applications. For example, when sending broadcast messages from the gateway to multiple nodes (including the synchronized sampling beacon) all nodes must be on the same channel as the gateway in order to receive the broadcast. Assigning channels is also a good idea when multiple gateways are attached to one host computer or when other wireless equipment is nearby and frequency or transmission interference may occur.



## 12. Safety Information

This section provides a summary of general safety precautions that must be understood and applied during operation and maintenance of components in the LORD MicroStrain<sup>®</sup> Wireless Sensor Network. Throughout the manual, ANSI Z535 standard safety symbols are used to indicate a process or component that requires cautionary measures.

### 12.1 Battery Hazards



The SG-Link<sup>®</sup>-LXRS<sup>®</sup> contains an internal, rechargeable Lithium Polymer battery. Lithium Polymer batteries are a fire and explosion hazard. Do not store or operate the node at temperatures above 212°F (100°C). Do not disassemble, short circuit, crush, puncture, or otherwise misuse the battery.



When recharging the node internal battery, use only the power supply specified for node charging, and follow the instructions. [See \*Charging the Node Battery\* on page 75.](#) Applying a voltage above the input range may result in dangerous battery conditions and cause permanent damage to the node.



Lithium Polymer batteries contain toxic chemicals that are harmful to humans and the environment. Disposal is subject to federal and local laws. Do not discard the battery or the node in the trash. Follow proper battery disposal protocol, or contact LORD MicroStrain<sup>®</sup> Technical Support for information on extracting the battery or returning the product for proper recycling and disposal.

## 12.2 User Configurable Power Settings

The SG-Link®-LXRS® Wireless Sensor Node can be powered by either the internal battery or an external source. There is user-accessible switch to select the source. The default setting for this switch is for internal battery operation and charging. [See \*Selecting the Power Source on page 73\*](#).



### NOTICE



Connecting an external power source when the node is set to internal power could result in injury or permanent node damage. For details on how to adjust the switch setting [see \*Connecting an External Power Supply on page 76\*](#).

- If the node is set to use an external source, and the charging power supply is plugged in, it will power the node from the power supply and not charge the battery. It will continue to use the internal battery.
- If the node is set to internal, and an external power supply other than the one used for charging is plugged in, several things could happen. If it is a power supply that is in the operating range of the charging circuit, it may charge the battery. If it is below the range of the charging circuit, nothing will happen. If the applied voltage is above the range of the charging circuit, damage to the node will likely occur and personal injury may result.
- When under battery operation there is a limit to how much current the node can provide to sensors. If the node is in an over-current condition it will shut off until the cause is removed. Using an external power source for the node or sensor can mitigate this issue.

### 12.3 Power Supply

The SG-Link<sup>®</sup>-LXRS<sup>®</sup> Wireless Sensor Node can be powered by an external source.

**! WARNING**

**! CAUTION**

**NOTICE**



Apply only the input voltage range specified for the SG-Link<sup>®</sup>-LXRS<sup>®</sup>. Connect to a power source that is near the device, is accessible, and adheres to all national wiring standards. Compliance with wiring standards is assumed in the installation of the power source and includes protection against excessive currents, short circuits, and ground faults. Failure to do so could result in personal injury and permanent damage to the device. For details on how to connect the power supply *see [Connecting an External Power Supply](#) on page 76.*

### 12.4 ESD Sensitivity

The SG-Link<sup>®</sup>-LXRS<sup>®</sup> is susceptible to damage and/or disruption of normal operation from Electrostatic Discharge (ESD), particularly during data acquisition.

**! CAUTION**

**NOTICE**



ESD damage can occur when the device is touched, especially at the device interfaces such as the antenna and connectors. Use proper grounding techniques when handling. If an ESD event occurs, and operation has been interrupted, reset the device by cycling power to it and/or restarting the operational mode in the system software.

## 12.5 Disposal and Recycling

**⚠ WARNING****⚠ CAUTION****NOTICE**

The SG-Link®-LXRS® contains internal batteries, printed circuit boards, and electronic components. These items are known to contain toxic chemicals and heavy metals that are harmful to human health and the environment. Disposal is subject to federal and local laws. Do not discard the device or batteries in the trash. Follow proper electronic and battery waste disposal protocol, as dictated by federal and local authorities. Some states also have programs for extracting reusable parts for recycling.

## 13. References

### 13.1 Reference Information

Many references are available on the LORD MicroStrain® website including product user manuals, technical notes, and quick start guides. These documents are continuously updated, and new applications are added. They may provide more accurate information than printed or file copies.

Document	Where to find it
Online Wireless Network Calculator	<a href="http://www.microstrain.com/configure-your-system">http://www.microstrain.com/configure-your-system</a>
Node Commander® Software User Manual	<a href="http://www.microstrain.com/support/docs">http://www.microstrain.com/support/docs</a>
SensorCloud™ Overview	<a href="http://www.sensorcloud.com/system-overview">http://www.sensorcloud.com/system-overview</a>
MathEngine® Overview	<a href="http://www.sensorcloud.com/mathengine">http://www.sensorcloud.com/mathengine</a>
LORD MicroStrain® Wireless Sensors Network Software Development Kit	<a href="http://www.microstrain.com/wireless/sdk">http://www.microstrain.com/wireless/sdk</a>
Product Datasheets	<a href="http://www.microstrain.com/wireless/sensors">http://www.microstrain.com/wireless/sensors</a>
Product Manuals and Technical Notes	<a href="http://www.microstrain.com/support/docs">http://www.microstrain.com/support/docs</a>
Product Application Notes	<a href="http://www.microstrain.com/applications">http://www.microstrain.com/applications</a>
NIST Calibration Procedures	<a href="http://www.nist.gov/calibrations/">http://www.nist.gov/calibrations/</a>
ASTM Testing Procedures	<a href="http://www.astm.org/Standard/standards-and-publications.html">http://www.astm.org/Standard/standards-and-publications.html</a>

Table 10 - Related Documents

## 13.2 Glossary

These terms are in common use throughout the manual:

**A/D Value:** the digital representation of the analog voltages in an analog-to-digital (A/D) conversion. The accuracy of the conversion is dependent on the resolution of the system electronics; higher resolution produces a more accurate conversion. Also referred to as "bits".

**ASTM:** The Association of Standards and Testing is a nationally-accepted organization for the testing and calibration of technological devices.

**Base Station:** The base station is the transceiver that attaches to the host computer and provides communication between the software and the node(s). It is also referred to as a "gateway".

**Bits:** the digital equivalent of voltage on the node. See 'A/D Value'.

**Burst Sampling:** a mode of operation in which the node is sampled for a fixed window of time (burst), and then repeats that window at set intervals. The burst duration and time between bursts is configurable. Same as periodic burst sampling.

**Calibration:** to standardize a measurement by determining the deviation standard and applying a correction (or calibration) factor

**Configuration:** a general term applied to the node indicating how it is set up for data acquisition. It includes settings such as sampling mode and rate, number of active channels, channel measurement settings, offsets, hardware gain, and calibration values.

**Continuous Sampling:** a mode of operation in which the node is sampled continuously until stopped, or continuously for a fixed amount of time.

**Coordinated Universal Time (UTC):** the primary time standard for world clocks and time. It is similar to Greenwich Mean Time (GMT).

**Cycle Power:** a command transmitted to the node to reboot it, either through a hardware or software switch

**Data Acquisition:** the process of collecting data from sensors and other devices

**Data Logging:** the process of saving acquired data to the system memory, either locally on the node or remotely on the host computer

**DHCP (network):** Dynamic Host Configuration Protocol is the standardized networking protocol used on Internet Protocol (IP) networks, which automatically configures devices that are attached to it by assigning and configuring the device IP address.

**Differential (signal):** is a method of transmitting electrical signals in which they are paired together as a differential pair and measured with reference to each other only. This method makes the pair less susceptible to electrical noise.

**EMI:** Electromagnetic Interference is an inductive or radiated disturbance that can create signal degradation on electrical signals, including loss of data.

**ESD:** Electrostatic Discharge is the sudden flow of electricity that can occur between two charged objects of different potential that come in contact or in close proximity of each other. Static electricity is a common source of ESD.

**Event-Based Sampling:** a mode of operation in which the node sampling is started when a sensor measurement value (threshold) is achieved.

**Firmware:** the code that is programmed onto a microcontroller or similar device in an embedded system. It includes device operation commands, conditions, memory allocation, and many other tasks.

**Gateway:** The gateway is a transceiver that attaches to the host computer and provides communication between the software and the node(s). It is also known as a “base station”.

**Host (computer):** The host computer is the computer that orchestrates command and control of the attached devices or networks.

**LED:** Light Emitting Diode is an indicator light that is used in electronic equipment.

**LOS (Line of Sight):** is used in radio communications to describe the ideal condition between transmitting and receiving antennas in a radio network. As stated, it means the antennas are in view of each other with no obstructions.

**LXRS®:** Lossless Extended Range Synchronized is the proprietary LORD MicroStrain® data communications protocol used in the wireless sensor network.

**NIST:** The National Institute of Standards and Testing is a nationally-accepted organization for testing and calibration of technological devices.

**Note:** The node is the wireless transceiver that the sensor(s) is connected to, providing communication with the gateway. The G-Link® -LXRS®, V-Link® -LXRS®, and SG-Link® -LXRS® are examples of nodes manufactured by LORD MicroStrain®.

**Node Tester board:** The Node Tester board is a device designed by LORD MicroStrain® that can be plugged into nodes to test their functionality.

**Offset:** When describing a mathematically-linear relationship, the offset is the value where the line that represents the relationship in a graph crosses the y-axis. The equation of a straight line is:  $y = mx + b$ , where  $x$  is the x-axis coordinate,  $y$  is the y-axis coordinate,  $m$  is the slope and  $b$  is the offset.

**Oversampling:** In signal processing, oversampling is a technique used to achieve increased signal resolution and better noise immunity by recording readings at a higher frequency than the output of the device being measured. In analog-to-digital conversion, the higher the oversampling rate, the better the recreated analog signal.

**Packet:** unit of sampled data

**Periodic Burst Sampling:** a mode of operation in which the node is sampled for a fixed window of time (burst), and then repeats that window at set intervals. The burst duration and time between bursts is configurable. Same as burst sampling.

**Ping:** a byte transmitted by the gateway to the node. The node responds by echoing the byte, indicating communication exists between the node and gateway.

**PGA:** A Programmable Gain Amplifier is an electronic device used to amplify small electrical signals.

**Range Test:** a continuous string of pings used to validate communication between the gateway and the node over distance and obstruction

**Read/Write EEPROM:** commands transmitted to the node to read or write parameters stored in the node's operating system

**Real Time Clock (RTC):** a computer clock that keeps track of the current time

**Resolution:** in digital systems, the resolution is the number of bits or values available to represent analog values or information. For example, a 12-bit system has 4,096 bits of resolution and a 16-bit system has 65,536 bits.



**RFI:** Radio Frequency Interference is a disturbance in an electrical circuit due to electromagnetic induction or radiation.

**RSSI:** Received Signal Strength Indication is a measurement of the transmission power in a radio signal. It is measured in decibels with reference to 1 milliwatt (dBm).

**RS232:** a serial data communications protocol

**Sensor:** a device that physically or chemically reacts to environmental forces and conditions, producing a predictable electrical signal

**Sleep:** a command transmitted to the node to put it into sleep configuration

**Sampling:** the process of taking measurements from a sensor or device

**Sampling Mode:** the type of sampling that is being utilized, such as event-triggered, continuous, or periodic. The nodes have several sampling modes that employ these types of sampling.

**Sampling Rate:** the frequency of sampling

**Single Ended:** electrical signals that are measured with reference to a system ground

**Slope:** When describing a mathematically linear relationship, the slope is the steepness of the line that represents that relationship on a graph. The equation of a straight line is:  $y = mx + b$ , where  $x$  is the x-axis coordinate,  $y$  is the y-axis coordinate,  $m$  is the slope, and  $b$  is the offset.

**Streaming:** Streaming is a sampling mode in which all active channels (and the sensors attached to them) are measured, and the acquired data is transmitted to the gateway and software. The data is not written to non-volatile memory during streaming. Streaming can either be finite (have a user defined start and end time) or continuous (continued until the power is cycled on the node).

**Synchronized Sampling:** a sampling mode that automatically coordinates all incoming node data to a particular gateway. This mode is designed to ensure data arrival and sequence.

**Transmission rate:** the number of data packets per transmission window, measured in seconds. Depending on the sampling mode and settings it will be between 1 and 64 packets/second.

**Transmission window:** the time allowed for one data transmission at the automatically determined transmission rate

**USB:** Universal Serial Bus, a serial data communications protocol

**Wheatstone Bridge:** an electrical circuit used to measure unknown electrical resistances

**WSN:** Wireless Sensor Network describes a distribution of sensors and data acquisition equipment that autonomously monitors environmental characteristics, such as temperature, pressure, and strain.