



# Hardware Specifications

---

## MONITOUCH V806



## Record of Revisions

Reference numbers are shown at the bottom left corner on the back cover of each manual.

Printing Date	Reference No.	Revised Contents
April, 2008	2017NE0	First edition
December, 2012	2017NE1	Second edition

---

# Preface

---

Thank you for selecting the V806 series.

For correct set-up of the V806 series, you are requested to read through this manual to understand more about the product.

The manuals shown below are related manuals for the V806. Refer to them as necessary.

Manual Name	Contents	Reference No.
V8 Series Reference Manual	The functions and instructions of the V8 series are explained.	1055NE
V Series Macro Reference	An overview of macros as well as macro editor operations and macro command descriptions are explained in detail.	1056NE
V8 Series Introductory Manual	The basic operating procedure of V-SFT version 5 is explained in detail.	1057NE
V8 Series Operation Manual	The information related to the operations of V-SFT version 5, such as software composition, editing procedure or limitations, is explained in detail.	1058NE
V8 Series Reference: Additional Functions	The additional functions and instructions of the V8 series for the V-SFT version 5.1.0.0 and later are explained.	1060NE
V8 Series Connection Manual	The connection and communication parameters for the V8 series and controllers are explained in detail.	2201NE
M-CARD SFT Operation Manual	Memory Card Editor (M-CARD SFT) is explained in detail.	1023NE
V Series DLL Function Specifications	An overview and contents of DLL files used for Ethernet (HKEtn20.DLL) and CF card (VCFAcS.DLL) are explained in detail.	1059NE
V8 Series Ladder Monitor Specifications	Ladder Monitor of the V8 series is explained in detail.	1062NE

For further details about controllers (PLCs, temperature controllers, etc.), refer to the manual issued by each controller manufacturer.

## Notes:

1. This manual may not, in whole or in part, be printed or reproduced without the prior written consent of Hakko Electronics Co., Ltd.
2. The information in this manual is subject to change without prior notice.
3. Windows and Excel are registered trademarks of Microsoft Corporation in the United States and other countries.
4. All other company names or product names are trademarks or registered trademarks of their respective holders.
5. If the specifications of the software do not correspond with the contents of this manual, the software specifications have priority.

---

# Notes on Safe Usage of MONITOUCH

---

In this manual, you will find various notes categorized under the following levels with the signal words "DANGER," and "CAUTION."



## **DANGER**

Indicates an imminently hazardous situation which, if not avoided, will result in death or serious injury.



## **CAUTION**

Indicates a potentially hazardous situation which, if not avoided, may result in minor or moderate injury and could cause property damage.

Note that there is a possibility that the item listed with  **CAUTION** may have serious ramifications.



## **DANGER**

- Never use the output signal of MONITOUCH for operations that may threaten human life or damage the system, such as signals used in case of emergency. Please design the system so that it can cope with the malfunctions of a touch switch. A malfunction of a touch switch will result in machine accident or damage.
- Turn off the power supply when you set up the unit, connect new cables or perform maintenance or inspections. Otherwise, electrical shock or damage may occur.
- Never touch any terminals while the power is on. Otherwise, electric shock may occur.
- You must put a cover on the terminals on the unit when you turn the power on and operate the unit. Otherwise, electric shock may occur.
- The liquid crystal in the LCD panel is a hazardous substance. If the LCD panel is damaged, do not ingest the leaked liquid crystal. If the liquid crystal spills on skin or clothing, use soap and wash off thoroughly.
- Never disassemble, recharge, deform by pressure, short-circuit, reverse the polarity of the lithium battery, nor dispose of the lithium battery in fire. Failure to follow these conditions will lead to explosion or ignition.
- Never use a lithium battery that is deformed, leaks, or shows any other signs of abnormality. Failure to follow these conditions will lead to explosion or ignition.
- The power lamp flashes when the backlight is at the end of life or is faulty. However, the switches on the screen are operable at this time. Do not touch the screen when the screen becomes dark and the power lamp flashes. Otherwise, a malfunction may occur and result in machine accident or damage.

## CAUTION

- Check the appearance of the unit when it is unpacked. Do not use the unit if any damage or deformation is found. Failure to do so may lead to fire, damage or malfunction.
- For use in a facility or for a system related to nuclear energy, aerospace, medical, traffic equipment, or mobile installations, please consult your local distributor.
- Operate (or store) MONITOUCH under the conditions indicated in this manual and related manuals. Failure to do so could cause fire, malfunction, physical damage or deterioration.
- Understand the following environmental limits for use and storage of MONITOUCH. Otherwise, fire or damage to the unit may result.
  - Avoid locations where there is a possibility that water, corrosive gas, flammable gas, solvents, grinding fluids or cutting oil can come into contact with the unit.
  - Avoid high temperature, high humidity, and outside weather conditions, such as wind, rain or direct sunlight.
  - Avoid locations where excessive dust, salt, and metallic particles are present.
  - Avoid installing the unit in a location where vibration or physical shock may be transmitted.
- Equipment must be correctly mounted so that the main terminal of MONITOUCH will not be touched inadvertently. Otherwise, an accident or electric shock may occur.
- Tighten the fixtures of MONITOUCH with a torque in the specified range. Excessive tightening may distort the panel surface. Loose tightening may cause MONITOUCH to come off, malfunction or be short-circuited.
- Check periodically that terminal screws on the power supply terminal block and fixtures are firmly tightened. Loosened screws may result in fire or malfunction.
- Tighten terminal screws on the power supply terminal block equally to a torque of 1.2 N•m for the V806 series. Improper tightening of screws may result in fire, malfunction, or trouble.
- When tightening the mounting screws of the fixture on the unit, torque them equally to 0.5 to 0.7 N•m. Excessive tightening may distort the panel surface. Loose tightening may cause MONITOUCH to come off, malfunction or be short-circuited.
- MONITOUCH has a glass screen. Do not drop or give physical shock to the unit. Otherwise, the screen may be damaged.
- Connect the cables correctly to the terminals of MONITOUCH in accordance with the specified voltage and wattage. Over-voltage, over-wattage, or incorrect cable connection could cause fire, malfunction or damage to the unit.
- Be sure to establish a ground of MONITOUCH. The FG terminal must be used exclusively for the unit with the level of grounding resistance less than 100  $\Omega$ . Otherwise, electric shock or a fire may occur.
- Prevent any conductive particles from entering into MONITOUCH. Failure to do so may lead to fire, damage, or malfunction.
- After wiring is finished, remove the paper used as a dust cover before starting to operate MONITOUCH. Operation with the cover attached may result in accident, fire, malfunction, or trouble.
- Do not attempt to repair MONITOUCH at your site. Ask Hakko Electronics or the designated contractor for repair.
- Do not repair, disassemble or modify MONITOUCH. Hakko Electronics Co., Ltd. is not responsible for any damages resulting from repair, disassembly or modification of MONITOUCH that was performed by an unauthorized person.
- Do not use a sharp-pointed tool when pressing a touch switch. Doing so may damage the screen. Doing so may damage the screen.
- Only experts are authorized to set up the unit, connect the cables or perform maintenance and inspection.
- Lithium batteries contain combustible material such as lithium or organic solvent. Mishandling may cause heat, explosion or ignition resulting in fire or injury. Read related manuals carefully and handle the lithium battery correctly as instructed.
- Do not press two or more points on the screen at the same time. If two or more positions are pressed at the same time, the switch located between the pressed positions activates.
- Take safety precautions during such operations as setting change during running, forced output, start, and stop. Any misoperation may cause unexpected machine motions, resulting in machine accident or damage.
- In facilities where a failure of MONITOUCH could lead to accident threatening human life or other serious damage, be sure that the facilities are equipped with adequate safeguards.
- At the time of disposal, MONITOUCH must be treated as industrial waste.
- Before touching MONITOUCH, discharge static electricity from your body by touching grounded metal. Excessive static electricity may cause malfunction or trouble.
- The LED lamp on the CF card interface cover illuminates in red when the power is supplied to the CF card. Never remove the CF card or turn off the power of MONITOUCH while the LED lamp is lit. Doing so may destroy the data on the CF card. Check that the LED lamp has gone off before removing the CF card or turning off the power of MONITOUCH.

---

[General Notes]

- Never bundle control cables nor input/output cables with high-voltage and large-current carrying cables such as power supply cables. Keep these cables at least 200 mm away from the high-voltage and large-current carrying cables. Otherwise, malfunction may occur due to noise.
- When using MONITOUCH in an environment where a source of high-frequency noise is present, it is recommended that the FG shielded cable (communication cable) be grounded at its ends. However, the cable may be grounded only at one end if this is necessary due to unstable communication conditions or for any other reason.
- Plug connectors or sockets of MONITOUCH in the correct orientation. Failure to do so may lead to damage or malfunction.
- If a LAN cable is inserted into the MJ1 or MJ2 connector on MONITOUCH, the counterpart device may be damaged. Check the indication on the unit and insert a cable into the correct position.
- Do not use thinners for cleaning because they may discolor MONITOUCH surface. Use alcohol or benzine commercially available.
- If a data receive error occurs when MONITOUCH and the counterpart (PLC, temperature controller, etc.) are started at the same time, read the manual for the counterpart unit and remove the error correctly.
- Avoid discharging static electricity on the mounting panel of MONITOUCH. Static charges can damage the unit and cause malfunctions. Otherwise, malfunction may occur due to noise.
- Avoid prolonged display of any fixed pattern. Due to the characteristics of the liquid crystal display, an afterimage may occur. If a prolonged display of a fixed pattern is expected, use the auto OFF function of the backlight.

[Notes on LCD]

Note that the following conditions may occur under normal circumstances.

- The response time, brightness and colors of MONITOUCH may be affected by the ambient temperature.
- Tiny spots (dark or luminescent) may appear on the display due to the liquid crystal characteristics.
- There are variations in brightness and colors on each unit.
- In the case of LCD display that uses CCFL (Cold Cathode Fluorescent Lamp), the optical properties (brightness, irregular colors, etc.) change depending on the operating time. Especially, they change in a low-temperature environment.

---

# Contents

---

Preface

Notes on Safe Usage of MONITOUCH

Chapter 1	Product Outline	
	1. Features .....	1-1
	2. Models and Peripheral Equipment .....	1-2
	MONITOUCH Models .....	1-2
	Peripheral Equipment .....	1-3
	3. System Composition .....	1-7
	System Composition of V806i/V806.....	1-7
	System Composition of V806i/V806 + DU-10 .....	1-8
Chapter 2	Specifications	
	1. Specifications .....	2-1
	General Specifications .....	2-1
	Installation Specifications.....	2-4
	Display Specifications .....	2-4
	Touch Switch Specifications .....	2-4
	Function Switch Specifications.....	2-4
	Interface Specifications .....	2-5
	Clock and Backup Memory Specifications .....	2-6
	Drawing Environment.....	2-6
	Display Function Specifications .....	2-6
	Function Performance Specifications.....	2-7
	2. Dimensions and Panel Cut-out.....	2-8
	External Dimensions and Panel Cut-out Dimensions for V806.....	2-8
	External Dimensions and Panel Cut-out Dimensions for V806+DU-10 .....	2-9
	3. Names and Functions of Components .....	2-10
	4. Modular Jack (MJ1 / MJ2) .....	2-12
	Modular Jack 1 (MJ1) / 2 (MJ2) .....	2-12
	5. USB Connector .....	2-14
	USB-A (Master Port) .....	2-14
	USB-B (Slave Port) .....	2-19
	Securing USB Cable .....	2-24
	6. LAN Connector (LAN) .....	2-26
	LAN Connector .....	2-26
	Wiring .....	2-27
	7. Serial Connector (CN1) (Optional) .....	2-28
	Connector for a Controller.....	2-28

8. CF Card (Optional).....	2-29
CF Card Socket.....	2-29
Notes on Handling the CF Card .....	2-30

### Chapter 3 Installation

1. Mounting Procedure.....	3-1
Mounting Procedure.....	3-1
Mounting Angle .....	3-1
2. Power Supply Cable Connection .....	3-2
Power Supply Cable Connection .....	3-2
Grounding .....	3-3

### Chapter 4 Instructions

1. Coin-type Lithium Battery (V7-BT) .....	4-1
Battery Usage .....	4-1
Battery Mounting Procedure .....	4-1
Battery Voltage Drop Detection.....	4-2
Battery Replacement.....	4-3
Notes on Battery: EU Directive 2006/66/EC .....	4-4
2. DIP Switches.....	4-5
V806.....	4-5
DU-10.....	4-6
3. Function Switches.....	4-7
Types .....	4-7
Function of Switches .....	4-7

### Chapter 5 MONITOUCH Operations

1. Before Operation.....	5-1
Procedure before Operation.....	5-1
Transferring Screen Data to MONITOUCH for the First Time .....	5-2
2. Main Menu Screen.....	5-3
Displaying the Main Menu Screen .....	5-3
Main Menu Screen .....	5-3
[Main Menu] Switch.....	5-4
Main Menu Screen Composition .....	5-4
1. RUN.....	5-5
2. Language Selection.....	5-5
3. Communication Parameter.....	5-6
4. Ethernet.....	5-7
4-1. IP Address Setting of the V806 Series.....	5-8
5. SRAM/Clock .....	5-11
5-1. Date and Time Adjustment.....	5-12
5-2. Formatting SRAM.....	5-12
5-3. Japanese FEP Function Learning/User Phrase Area .....	5-13
6. Extension Program Information .....	5-14



---

7.	Card Transfer .....	5-15
7-1.	Folder Configuration in the CF Card .....	5-17
7-2.	Transferring Screen Data .....	5-18
7-3.	Saving Backup Copies of SRAM .....	5-24
7-4.	Deleting Data on the CF Card .....	5-26
7-5.	Transferring Data to the Card Recorder .....	5-27
7-6.	Message Window Displayed during Data Transfer (between V806 and Card) .....	5-29
8.	I/O Test .....	5-30
8-1.	Self-loop Test .....	5-31
8-2.	USB Test .....	5-41
8-3.	Printer Test .....	5-42
8-4.	[SYSTEM] Switch & Function Switch Test .....	5-43
8-5.	Touch Switch Test .....	5-44
8-6.	Keyboard Selection .....	5-47
9.	Extended Function Setting .....	5-48
9-1.	Setting Baud Rate between V806 Series and Modem .....	5-49
9-2.	Setting Local Port Number .....	5-50

## Chapter 6 Error Handling

1.	Error Messages .....	6-1
1.	Communication Error .....	6-1
1-1.	Error Messages for Network Communication .....	6-2
2.	Data Loading .....	6-5
3.	Warning .....	6-5
4.	System Error .....	6-6
5.	Touch Switch Is Active .....	6-6
2.	Troubleshooting .....	6-7
	In the Event of an Error .....	6-7
	Probable Symptoms .....	6-7

## Chapter 7 Inspection and Maintenance

1.	Inspection and Maintenance .....	7-1
	Daily Inspection .....	7-1
	Periodical Inspection .....	7-1
2.	Warranty Policy .....	7-2
	Inquiries about Failure .....	7-2
	Warranty Period .....	7-2
	Free-of-charge Repair .....	7-2
	Chargeable Repair .....	7-2
	Inquiry Form .....	7-3

# 1 Product Outline

---

1. Features
2. Models and Peripheral Equipment
3. System Composition

# 1. Features

The V806 series inherits and heightens the features of the V706 series as described below.

## 1. 8-way communication

A maximum of eight controllers, such as PLCs or peripheral equipment, of different models and manufacturers can be connected to one V806 series via mixed network of Ethernet (max. 8 protocols) and serial communications (max. 3 protocols).

The V806 series can communicate with eight types of devices at one time and can exchange data among connected devices.

\* For the use of the serial 3 ports, the optional unit, "DU-10", is additionally required.

Connection example: serial 3 ports + Ethernet

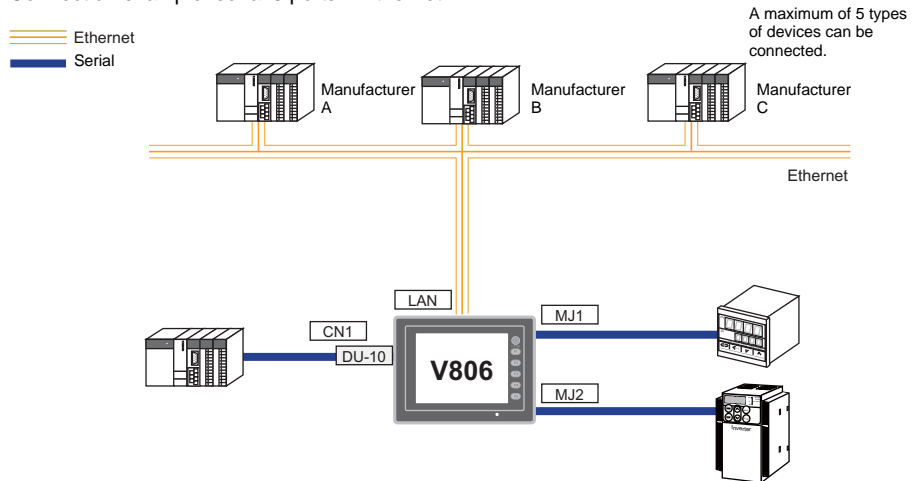

## 2. 65536-color display (V806T/V806C)

A high-definition display of 65,536 colors (without blinks, 32,768 colors with blinks) is possible. Photographs (JPEG) or illustrations (bitmap) are displayed close to the real image. An operator can view operating conditions easily because of the increased viewability.

## 3. Stroke font

Unlike standard bitmap fonts, the font size can be adjusted as desired regardless of the display resolution. Quality expression is possible.

## 4. Process for screen data creation is reduced with use of "component parts".

A "component part" is a part which consists of multiple components having different functions or different macro programs.

Screen data with advanced functions can be created easily and rapidly.

## 5. Two CF-card drives provided

Two CF cards can be used at the same time by connecting a USB-CFREC to the USB-A port and also using the CF card interface of the optional unit, "DU-10".

Data can be transmitted between two CF cards. CF cards can be used for various purposes as required.

## 6. PictBridge-compatible printer available

A PictBridge-compatible printer can be connected.

Simple printing using a USB cable is possible.

## 2. Models and Peripheral Equipment

### MONITOUCH Models

The model name consists of the following information.

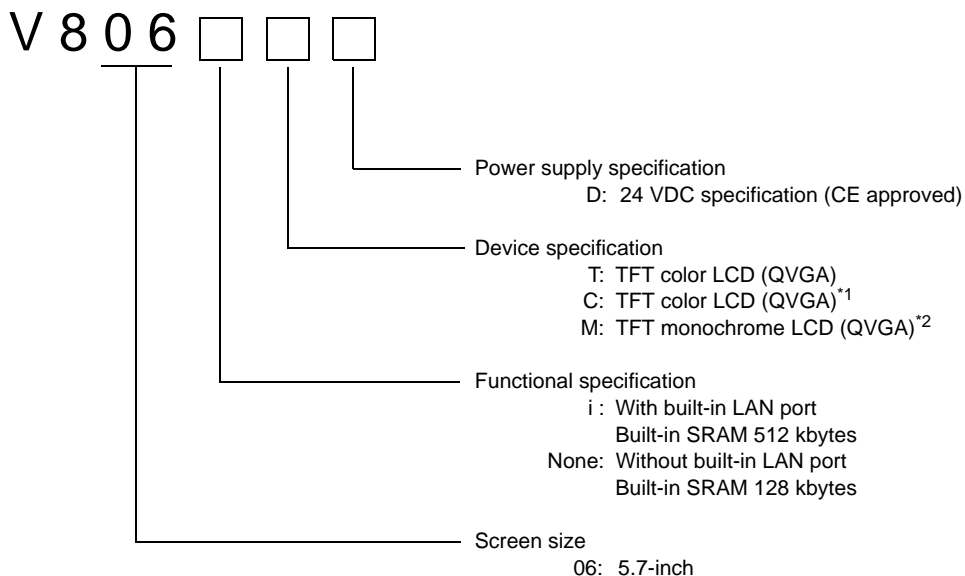

\*1 Hardware version "a" to "q": STN color LCD (QVGA)

\*2 Hardware version "a" to "q": STN monochrome LCD (QVGA)

The following models are available.

Analog resistance film type

Series	Model	Specifications	Remarks
V806 series 5.7-inch	V806TD	TFT color, 320 × 240 dots, without LAN port, DC power supply	CE approved
	V806CD	TFT color <sup>*1</sup> , 320 × 240 dots, without LAN port, DC power supply	
	V806MD	TFT monochrome <sup>*2</sup> , 320 × 240 dots, without LAN port, DC power supply	
	V806iTD	TFT color, 320 × 240 dots, with LAN port, DC power supply	
	V806iCD	TFT color <sup>*1</sup> , 320 × 240 dots, with LAN port, DC power supply	
	V806iMD	TFT monochrome <sup>*2</sup> , 320 × 240 dots, with LAN port, DC power supply	

\*1 Hardware version "a" to "q": STN color

\*2 Hardware version "a" to "q": STN monochrome

## Peripheral Equipment

The following devices are available as options for the V806 series.

### Drawing Tool

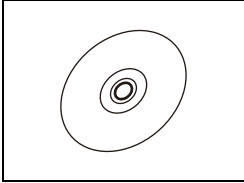

V-SFT-5 (configuration software: English version)

Application software for editing screen data for MONITOUCH.

OS:

Windows 98SE/ NT4.0/ Me/ 2000/ XP/ XP 64 Edition/ Vista 32-bit/ Vista 64-bit/ 7 32-bit/  
7 64-bit

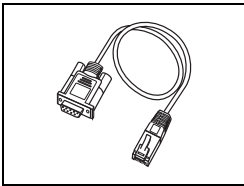

V-CP (screen data transfer cable) 3 m

Used for connection between the V806 series and a computer, or a computer and the card recorder (CREC).

### Communication Interface Unit

\* The following units cannot be used at the same time.

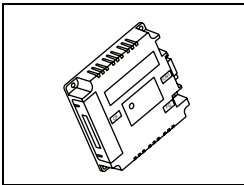

DU-10

D-sub 9-pin provided, CF card usable

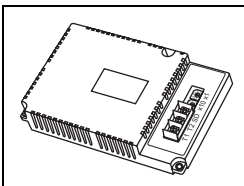

CU-xx

Communication unit used for each network

CU-00 → OPCN-1

CU-01 → T-LINK

CU-02-2 → CC-Link

CU-03-3 → Ethernet

CU-04 → PROFIBUS-DP

CU-06 → SX BUS

CU-07 → DeviceNet

CU-08 → FL-net

### Cable

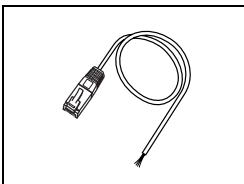

V6-BCD (barcode reader connection cable) 3 m

Used for connection between the V806 series and a barcode reader.

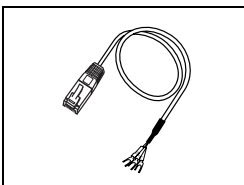

V6-MLT (multi-link 2 master cable) 3 m

Used for multi-link 2 connection between the V806 master station and the V806 slave station.

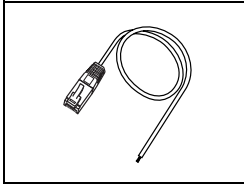
**V6-TMP (connection cable for controllers)**

Used for connection between the V806 series and a controller.

V6-TMP: 3 m

V6-TMP-5M: 5 m

V6-TMP-10M: 10 m

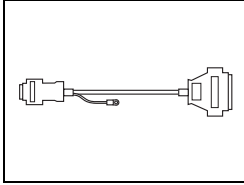
**D9-D25 (D-sub 9 to D-Sub 25 conversion cable) 0.3 m**

Conversion cable for using the communication cable for CN1 (D-sub 25 pin) of the V6/V7 series as for CN1 (D-sub 9 pin) of the V806 series.

The cable is used with communication interface unit, "DU-10".

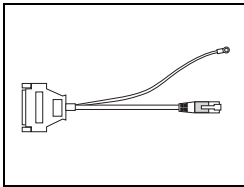
**MJ2-PLC (MJ2-to-D-sub conversion cable) 0.3 m**

Used for connection with V806 (MJ1/2) on RS-232C, or V806 (MJ2) on RS-422 (4-wire).

\* When connecting between V806 (MJ2) and a PLC on RS-485 (2-wire), you can use MJ-D25. (See the following item.)

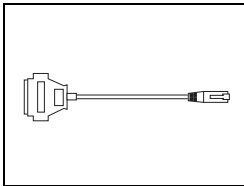
**MJ-D25 (MJ-to-D-sub conversion cable) 0.3 m**

Used for connection with V806 (MJ1/2) on RS-232C, or V806 (MJ2) on RS-485 (2-wire).

The cable is used with the communication cable for CN1 (D-sub 25 pin) of the V6/V7 series.

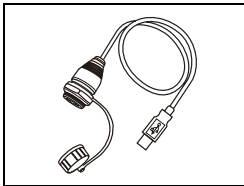
**UA-FR (for USB-A port)**

Cable for USB-A (master), with which connection from the front of the control cabinet is possible.

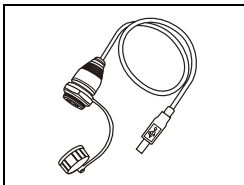
**UB-FR (for USB-B port)**

Cable for USB-B (slave), with which connection from the front of the control cabinet is possible.

## Protective Sheet

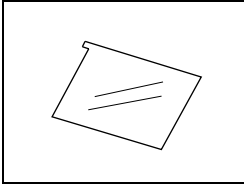

### V806-GS

Used for protecting the operation panel surface (5 pcs./set).

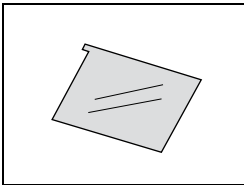

### V806-GSN10

Used for protecting the operation panel surface (5 pcs./set, anti-glare treated). The sheet is colored in light gray and has graininess on its surface to avoid light reflection.

## Other Options

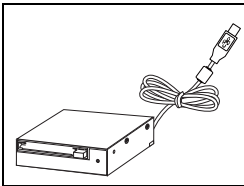

### USB-CFREC

Unit that connects to the USB-A port of the V806 series and makes a CF card available.

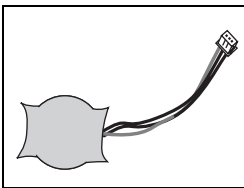

### V7-BT (replacement battery)

Replacement lithium battery for the V806 series, V8 series, V7 series and V606e.

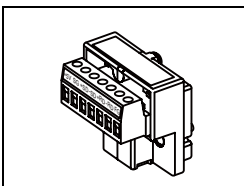

### TC-D9 (terminal converter)

Used for connection between the V806 series and a controller using an RS-422/485 terminal block via the CN1 (D-sub 9-pin) of the optional unit, "DU-10", installed on the V806 series.

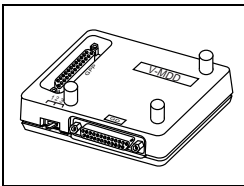

### V-MDD (ACPU/QnACPU/FXCPU dual port interface)

Add-on connector with two ports, specifically designed for the connector on the MITSUBISHI's ACPUs/QnACPU/FXCPU programmer. Operability can be improved when directly connecting the V806 series to the ACPUs/QnACPU/FXCPU programmer.

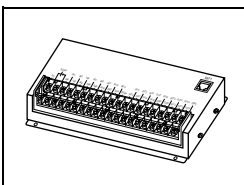

### V-I/O (serial extension I/O)

Used as an external I/O unit. It has 16 inputs and 16 outputs.

## Memory Card

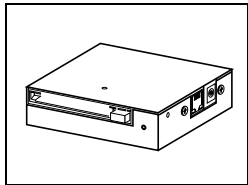

### CREC (card recorder)

Used for creating a backup copy of screen data or works as an external memory storage system for memory manager and data logging functions.

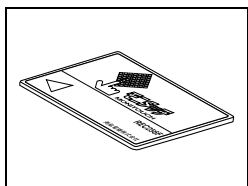

### REC-MCARD (memory card compliant with JEIDA ver. 4.0)

Used with the card recorder (CREC) when making a backup copy of screen data or saving data on an external medium for memory manager and data logging functions.

SRAM 256 K, 512 K, 1 M, 2 M, 4 Mbytes

FLASH ROM 4 Mbytes



### 3. System Composition

#### System Composition of V806i/V806

The following illustration shows possible system configurations using the V806i/V806 series.

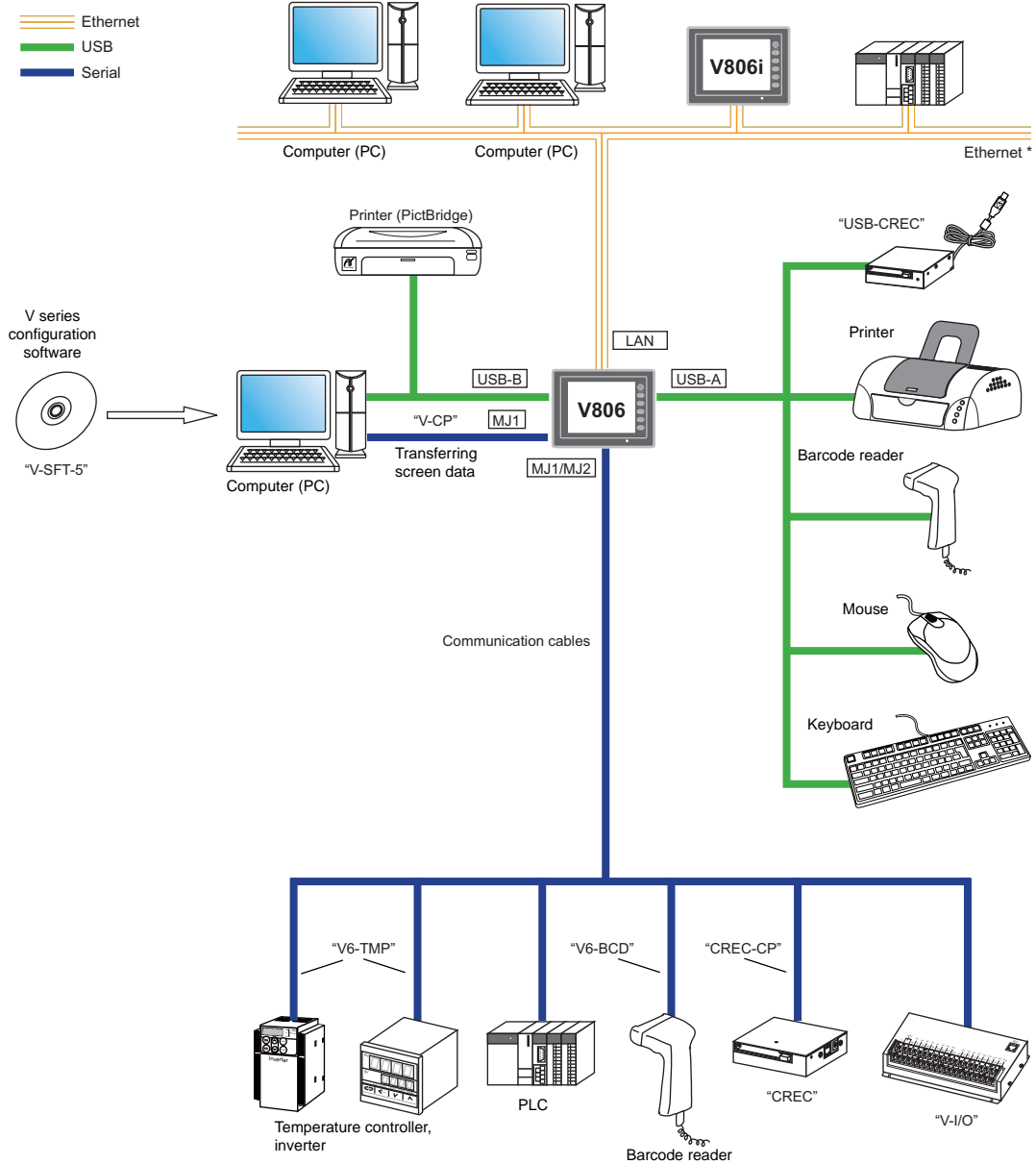

\* For Ethernet connection on V806, a communication unit "CU-03-3" is additionally required.

## System Composition of V806i/V806 + DU-10

The following illustration shows possible system configurations using the V806i/V806 + DU-10.

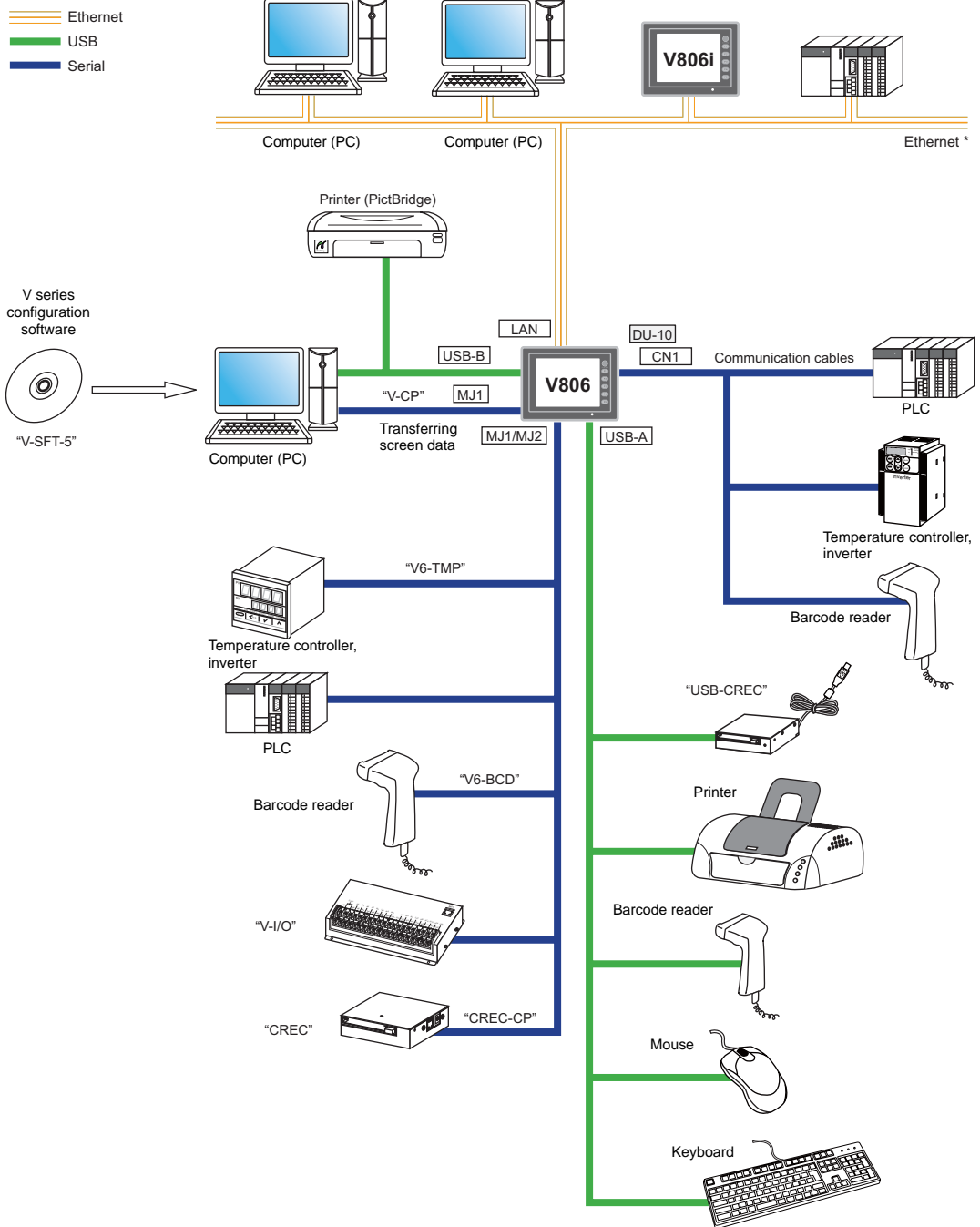

\* For Ethernet connection on V806, a communication unit "CU-03-3" is additionally required. (Using with DU-10 is not supported.)

# 2 Specifications

---

1. Specifications
2. Dimensions and Panel Cut-out
3. Names and Functions of Components
4. Modular Jack (MJ1 / MJ2)
5. USB Connector
6. LAN Connector (LAN)
7. Serial Connector (CN1) (Optional)
8. CF Card (Optional)

# 1. Specifications

## General Specifications

Item		V806	
Standards	CE Marking	EN61000-6-2 EN61000-6-4	
	UL/ c-UL	a to q <sup>*2</sup>	
		r or later <sup>*2</sup>	
Power Supply <sup>*1</sup>	Permissible Range of Voltage	24 VDC ± 10 %	
	Permissible Momentary Power Failure	For 24 VDC: Within 1 ms	
	Power Consumption (Maximum Rating)	15 W or less	
	Rush Current	a to q <sup>*2</sup>	17 A or less, within 2 ms (24 VDC input)
		r or later <sup>*2</sup>	18 A or less, within 2 ms (24 VDC input)
Withstand Voltage	DC external terminals to FG: 500 VAC, 1 minute		
Insulation Resistance		DC external terminals to FG: 500 VDC, 10 MΩ or above	
Physical Environment	Operational Ambient Temperature	0 °C to +50 °C <sup>*3*4</sup>	
	Storage Ambient Temperature	-10 °C to +60 °C <sup>*3</sup>	
	Operational Ambient Humidity	85% RH or less (without dew condensation, max. wet-bulb temperature: 39 °C or less) <sup>*3</sup>	
	Storage Ambient Temperature	85% RH or less (without dew condensation, max. wet-bulb temperature: 39 °C or less) <sup>*3</sup>	
	Altitude	2000 m or less	
	Atmosphere	No corrosive gas, no excessive dust, and no conductive dust	
	Contamination Level <sup>*5</sup>	Contamination level: 2	
Mechanical Working Condition	Vibration Resistance	Vibration frequency: 10 to 150 Hz, acceleration: 9.8 m/s <sup>2</sup> (1.0 G), half-amplitude: 0.075 mm, X, Y, Z: 3 directions for one hour	
	Shock Resistance	Pulse shape: sine half wave, peak acceleration: 147 m/s <sup>2</sup> (15 G), X, Y, Z: 3 directions six times each	
Electrical Working Condition	Noise Resistance	Noise voltage: 1000 Vp-p, pulse width: 1 μs, rising time: 1 ns (Measured by using a noise simulator.)	
	Static Electricity Discharge Resistance	Compliant with IEC61000-4-2, contact: 6 kV, air: 8 kV	
Mounting Conditions	Weight	Approx. 740 g	
	Dimensions W × H × D	182.5 × 138.8 × 50.8 mm	
	Panel Cut-out Dimensions	174.0 <sup>+0.5</sup> <sub>-0</sub> × 131.0 <sup>+0.5</sup> <sub>-0</sub> mm	
Case Color		Gray	
Material		PC/ABS resin	

- \*1 Use the Class 2 power supply.
- \*2 This is the hardware version of the V806 unit. For more information on the hardware version, refer to page 7-3.
- \*3 Use MONITOUCH in the environment that has a wet-bulb temperature of 39 °C or less. Otherwise, MONITOUCH may be damaged.
- \*4 The permissible ambient temperature range will vary, depending on optional units or communication units connected to the V806 series or the angle of the mounted V806.

Optional Unit	Mounting Angle	Operational Ambient Temperature
None	0° to 135°	0 °C to 50 °C
DU-10	0° to 135°	0 °C to 50 °C
CU-02-2	45° to 135°	0 °C to 45 °C
CU-06 (Hardware version "d" or earlier)	90°	0 °C to 50 °C
CU-00 CU-01 CU-03-3 CU-04 CU-06 (Hardware version "e" or later) CU-07 CU-08	45° to 135°	0 °C to 50 °C

- \*5 This is an index that expresses the degree of conductive contamination in the environment where MONITOUCH is used.  
"Contamination level 2" indicates the condition where only non-conductive contamination occurs. However, due to condensation, temporary conductive contamination may occur.

## About UL/cUL Approval

The V806 is UL/cUL-approved. (File No.: E313548 (UL508), File No.: E315977 (UL1604))

The V806 conforms to the following four standards.

- UL 508 : Industrial Control Equipment
- UL1604 : Electrical Equipment for Use in Class I, Division 2 Hazardous Locations
- CSA-C22.2 No. 142-M1987 : Process Control Equipment
- CSA-C22.2 No. 213-M1987 : Non-Incendive Electrical Equipment for Use in Class I, Division 2 Hazardous Locations

## UL1604/CSA-C22.2 No. 213 Compliance and Handling Cautions

- Power, input and output wiring must be in accordance with Class I, Division 2 wiring methods - Article 501 - 10(B) of the National Electrical Code, NFPA 70.
- This product is certified for use in Class I, Division 2, Groups A, B, C or D hazardous location or non-hazardous locations.
- WARNING: Explosion Hazard: Substitution of components may impair compliance to Class I, Division 2.
- WARNING: Explosion Hazard: Do not disconnect the device while the circuit is alive unless area is known to be non-hazardous. Perform system set-up or diagnostics of the CF card port, USB-A and USB-B port only in a non-hazardous location.
- WARNING: Explosion Hazard: For use in a hazardous location, turn off the power before replacing or wiring modules.
- Do not replace a battery in a hazardous location.
- In the case of use in a hazardous location, be sure to check that the externally connected unit and each interface have been secured with screws or have been locked. In a hazardous location, it is impossible to insert or remove a cable from the applicable port. Be sure to check that the location is non-hazardous before inserting or removing it.

### UL Listing Application for a System Equipped with the V806 Series

- The back panel of the V806 series is not approved as an enclosure. For UL listing application, build the V8 series in the system, and configure an enclosure so that the entire system will be UL-approved.
- Use the V806 series indoors only.
- For use on a flat surface of a type 1 enclosure.
- Use naked wires for wiring of the power supply cable.

Screw Size	Tightening Torque	Power Cable
M3.5	7.1 inch-lbf (0.8 N•m)	AWG14 - AWG16, Rated temperature 60 °C, Use copper conductor only.

- Use the Class 2 power supply for the 24-VDC power unit.

### CE Marking

- The V806 series complies with the following EMC Directives: EN61000-6-2, EN61000-6-4
- The V806 series is identified as a class-A product in an industrial environment. In the case of usage in a domestic environment, the V806 series is likely to cause electromagnetic interference. Appropriate preventive measures should be taken.

## Installation Specifications

Item		Specifications
Grounding		Less than 100 Ω, FG/SG separated
Protection Structure	Front Panel <sup>*1</sup>	Compliant with IP65 (when using waterproof gasket) <sup>*2</sup>
	Rear Case	Compliant with IP20
Cooling System		Cooling naturally
Structure		Inserted in a mounting panel
Appropriate Mounting Panel Thickness		1.5 to 5 mm

\*1 Protection structure for the front when the V806 series is mounted on the mounting panel

\*2 It is recommended to use the mounting panel whose thickness (steel, stainless) is 3.0 mm or more to keep the unit compliant with IP65. The strength differs depending on the material of the mounting panel. Check the environment where the V806 series is used.

## Display Specifications

Item		V806T	V806C	V806M
Display Device	a to q <sup>*1</sup>	TFT color	STN color	STN monochrome
	r or later <sup>*1</sup>	TFT color		TFT monochrome
Display Size		5.7-inch		
Colors		65,536 colors (without blinks) / 32,768 colors (with blinks) / 128 colors (with 16-color blinks)		16-grade (with blinks)
Display Resolution (W × H)		320 × 240 dots		
Dot Pitch (W × H)		0.36 × 0.36 mm		
Backlight	a to q <sup>*1</sup>	CCFL (Cold cathode tube)		
	r or later <sup>*1</sup>	LED		
Backlight Life (average life of backlight only) <sup>*2</sup>	a to q <sup>*1</sup>	Approx. 50,000 hours	Approx. 75,000 hours	Approx. 58,000 hours
	r or later <sup>*1</sup>	Approx. 70,000 hours		
Backlight Auto OFF Function		Always ON, random setting		
Brightness Adjustment	a to q <sup>*1</sup>	Function switch: 3 levels Macro: 128 levels	-	
	r or later <sup>*1</sup>	Function switch: 3 levels, Macro: 128 levels		
Contrast Adjustment	a to q <sup>*1</sup>	-	Function switch: F2 to F4	
	r or later <sup>*1</sup>	-		
Surface Sheet Material		Polycarbonate, 0.3 mm thick		
POWER Lamp		ON: Normal (green) Blink: Backlight error		

\*1 This is the hardware version of the V806 unit. For more information on the hardware version, refer to page 7-3.

\*2 It means the time when the surface luminance of the display is 50% of the initial setting, in the ambient temperature of 25 °C.

## Touch Switch Specifications

Item	Analog Resistance Film Type
Switch Resolution	1024 × 1024
Mechanical Life	One million activations or more
Surface Treatment	Hard-coated, anti-glare treatment 5 %

## Function Switch Specifications

Item	Specifications
Number of Function Switches	6 pcs.

Item	Specifications
Method	Matrix resistance film type
Mechanical Life	One million activations or more

## Interface Specifications

Item	Specifications		
Modular jack, 8-pin (MJ1)	Applicable Standards	RS-232C, RS-485 (2-wire connection)	
	Synchronization	Asynchronous type	
	Data Length	7- or 8-bit	
	Parity	None, odd, even	
	Stop Bit	1- or 2-bit	
	Baud Rate	4800, 9600, 19200, 38400, 57600, 76800, 115k bps	
	Applications	Screen data transfer, PLC, temperature controller, CREC, barcode reader, V-I/O, multi-link2, V-Link, etc.	
Modular jack, 8-pin (MJ2)	Applicable Standards*1	RS-232C, RS-485 (2-wire connection), RS-422 (4-wire connection)	
	Synchronization	Asynchronous type	
	Data Length	7- or 8-bit	
	Parity	None, odd, even	
	Stop Bit	1- or 2-bit	
	Baud Rate	4800, 9600, 19200, 38400, 57600, 76800, 115k bps (187500 bps for MPI connection*2)	
	Applications	PLC, temperature controller, CREC, barcode reader, V-I/O, multi-link2, V-Link, etc.	
USB Connector (USB-A/B)	USB-A	Applicable Standards	Compliant with USB version 1.1
		Baud Rate	Low speed: 1.5 Mbps, full speed: 12 Mbps
		Applications	Printer (EPSON STYLUS PHOTO series), USB-CFREC, keyboard, mouse, etc.
	USB-B	Applicable Standards	Compliant with USB version 1.1
		Baud Rate	Low speed: 1.5 Mbps, full speed: 12 Mbps
		Applications	Screen data transfer, PictBridge-compatible printer
Extensional Communication Port (CN5)		"DU-10", SX BUS, OPCN-1, T-Link, Ethernet, CC-Link, PROFIBUS-DP, DeviceNet or FL-net. (The communication interface unit "CU-xx" is additionally required.)	
Ethernet Port 100BASE-TX/10BASE-T (LAN)	Applicable Standards	Compliant with IEEE802.3u (100BASE-TX), IEEE802.3 (10BASE-T)	
	Baud Rate	100 Mbps, 10 Mbps	
	Recommended Cable	100 Ω UTP (unshielded twist-pair cable), category 5, max. 100 m long	
	Applications	PLC connection, etc.	
D-sub 9-pin (CN1)*3	Applicable Standards	RS-232C, RS-422/485	
	Synchronization	Asynchronous type	
	Data Length	7- or 8-bit	
	Parity	None, odd, even	
	Stop Bit	1- or 2-bit	
	Baud Rate	4800, 9600, 19200, 38400, 57600, 76800, 115k bps	
	Applications	PLC, temperature controller, barcode reader, etc.	
CF Card Interface*3	Compliant with CompactFlash™		

\*1 Signal switching for the MJ2 is possible by the slide switch mounted on the side of the V806 series. For more information, refer to "Modular Jack 1 (MJ1) / 2 (MJ2)" (page 2-12).

\*2 For details, refer to the V8 Series Connection Manual.

\*3 Available when the option unit, "DU-10", is mounted.



## Clock and Backup Memory Specifications

Item	Specifications
Battery Specification	Coin-type lithium primary cell
Backup Memory (SRAM)	V806i series: 512 kbyte V806 series: 128 kbyte
Backup Period	5 years (ambient temperature at 25 °C)
Battery Voltage Drop Detection	Provided (internal memory of 167 allocated)
Calendar Accuracy	Monthly deviation $\pm 90$ sec (ambient temperature at 25 °C)*

\* Time loss is approximately 90 seconds a month in an ambient temperature of 25 °C in the non-energized state (backup with battery). Depending on the ambient temperature, the calendar may lose 356 seconds or advance 189 seconds in a month at the maximum. Correct the clock periodically.

## Drawing Environment

Item	Specifications
Drawing Method	Exclusive configuration software
Drawing Tool	Name of exclusive configuration software: V-SFT-5 Personal computer: Pentium III 800 MHz or above (Pentium IV 2.0 GHz or above recommended) OS: Windows98SE/ NT4.0/ Me/ 2000/ XP/ XP64 Edition/ Vista 32-bit/ Vista 64-bit/ 7 32-bit/ 7 64-bit Capacity of hard disk required: Free space of approx. 1 Gbytes or more Memory: 512 Mbytes or more Display: Resolution 1024 × 768 or above Screen color: 16 bits or more

## Display Function Specifications

Item		Specifications				
Interface Language*1		Japanese	English/Western Europe	Chinese (Traditional)	Chinese (Simplified)	Korean
Characters	1/4-size, 1-byte	ANK code	Latin 1	ASCII code	ASCII code	ASCII code
	2-byte 16-dot	JIS #1, 2 levels	–	Chinese (traditional)	Chinese (simplified)	Hangul (without Kanji)
	2-byte 32-dot	JIS #1 level	–	–	–	–
Font		Bitmap font, Gothic font, Stroke font, Windows font				
Character Size	1/4-size	8 × 8 dots				
	1-byte	8 × 16 dots				
	2-byte	16 × 16 dots or 32 × 32 dots				
	Enlargement Factor	X: 1 to 8 times, Y: 1 to 8 times Point*2: 8, 9, 10, 11, 12, 14, 16, 18, 20, 22, 24, 26, 28, 36, 48, 72				
Number of Displayable Characters	Display Resolution	320 × 240				
	1/4-size	40 characters × 30 lines				
	1-byte	40 characters × 15 lines				
	2-byte	20 characters × 15 lines				
Character Properties		Display properties: Normal, reverse, blink, bold, shadow, transparent Colors: 65,536 colors (without blinks) / 32,768 colors (with blinks) 128 colors (with blinks), monochrome 16-grade (with blinks)				
Graphics		Lines: Line, continuous line, box, parallelogram, polygon Circles: Circle, arc, sector, ellipse, elliptical arc Others: Tile patterns				

Item	Specifications
Graphic Properties	Line types: 6 (thin, thick, dot, chain, broken, two-dot chain) Tile patterns: 16 (incl. user-definable 8 patterns) Display properties: Normal, reverse, blink Colors: 65,536 colors (without blinks) / 32,768 colors (with blinks) 128 colors (with blinks), monochrome 16-grade (with blinks) Color selection: Foreground, background, boundary (line)

\*1 In addition, the following fonts are available.

Gothic, English/Western Europe HK Gothic, English/Western Europe HK Times, Central Europe, Cyrillic, Greek, Turkish

For more information, refer to the V8 Series Reference Manual.

\*2 Applicable when Gothic font or Stroke font is used.

When the Windows font is used, the point size of the font can be specified within the setting range of 6 to 999 points. For more information on the point size of the Windows font, refer to the V8 Series Reference Additional Functions.

## Function Performance Specifications

Item	Specifications	
Screens	Max. 4000	
Screen Memory (Flash Memory)	V806i/V806 series: Approx. 4.5 Mbytes (varies depending on the font)	
Switch	192 per screen	
Switch Actions	Set, reset, momentary, alternate, to light (Possible to press a function switch and a switch on the display at the same time)	
Lamp	Reverse, blink, exchange of graphics 192 per screen	
Graph	Pie, bar, panel meter and closed area graph: No limitation <sup>*1</sup> Statistics and trend graphs: Max. 256 per layer <sup>*2</sup>	
Data Setting	Numerical Data Display	No limitation <sup>*1</sup>
	Character Display	No limitation <sup>*1</sup>
	Message Display	No limitation <sup>*1</sup> Display Resolution: Max. 40 characters (1-byte)
Sampling	Sampling display of buffer data (Constant sampling, bit synchronization, alarm logging, time order alarming, alarm function)	
Graphic Library	Max. 2560	
Overlap Library	Max. 4000	
Data Blocks	Max. 1024	
Messages	Max. 32768 lines	
Patterns	Max. 1024	
Macro Blocks	Max. 1024	
Page Blocks	Max. 2048	
Direct Blocks	Max. 1024	
Screen Blocks	Max. 1024	
Data Sheets	Max. 1024	
Screen Library	Max. 4000	
Comments	Max. 32767	
Device Memory Map	Max. 32 × 8 (PLC1 to PLC8)	
Time Display	Provided	
Hard Copy	Provided	
Buzzer	Provided, 2 sounds (short beep, long beep)	
Auto OFF Function	Always ON, random setting	
Self-diagnostic Function	Switch self-test function, Communication parameter setting check function, Communication check function	

\*1 The number of setting memory locations is limited to 256 per screen. For more information, refer to the V8 Series Operation Manual.

\*2 Layer: 5 per screen (base + 4 overlap display including the global overlap display)

## 2. Dimensions and Panel Cut-out

### External Dimensions and Panel Cut-out Dimensions for V806

- Front View

(Unit: mm)

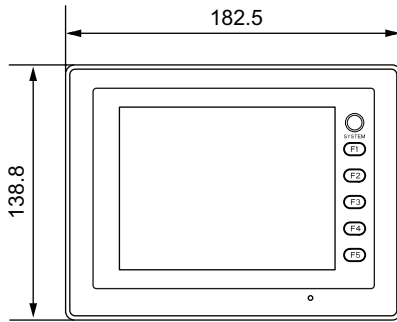

- Rear View

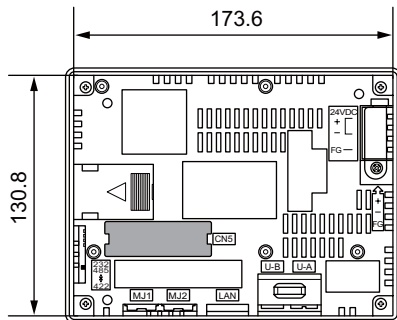

- Side View

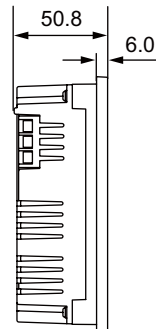

- Bottom View

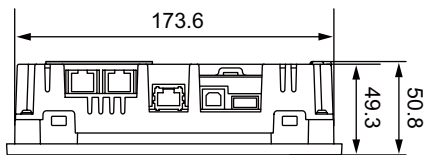

- Panel Cut-out Dimensions

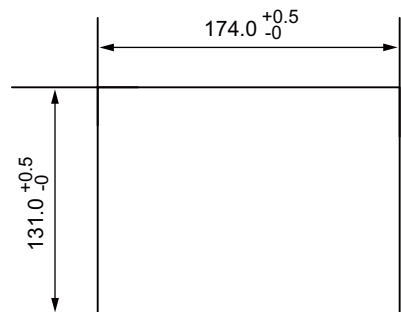

## External Dimensions and Panel Cut-out Dimensions for V806+DU-10

- Front View

(Unit: mm)

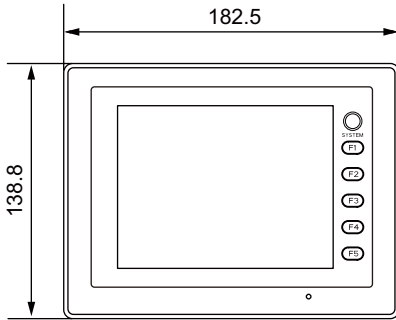

- Rear View

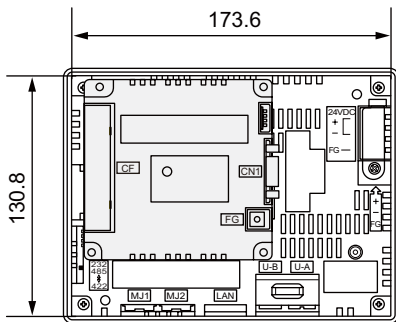

- Side View

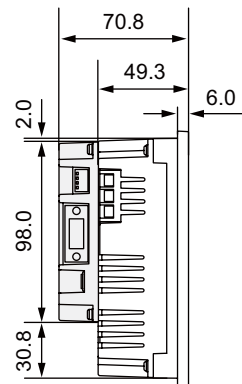

- Bottom View

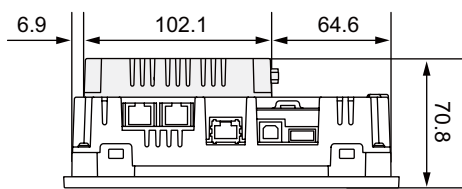

- Panel Cut-out Dimensions

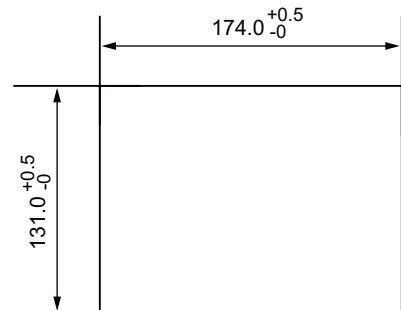

### 3. Names and Functions of Components

#### V806

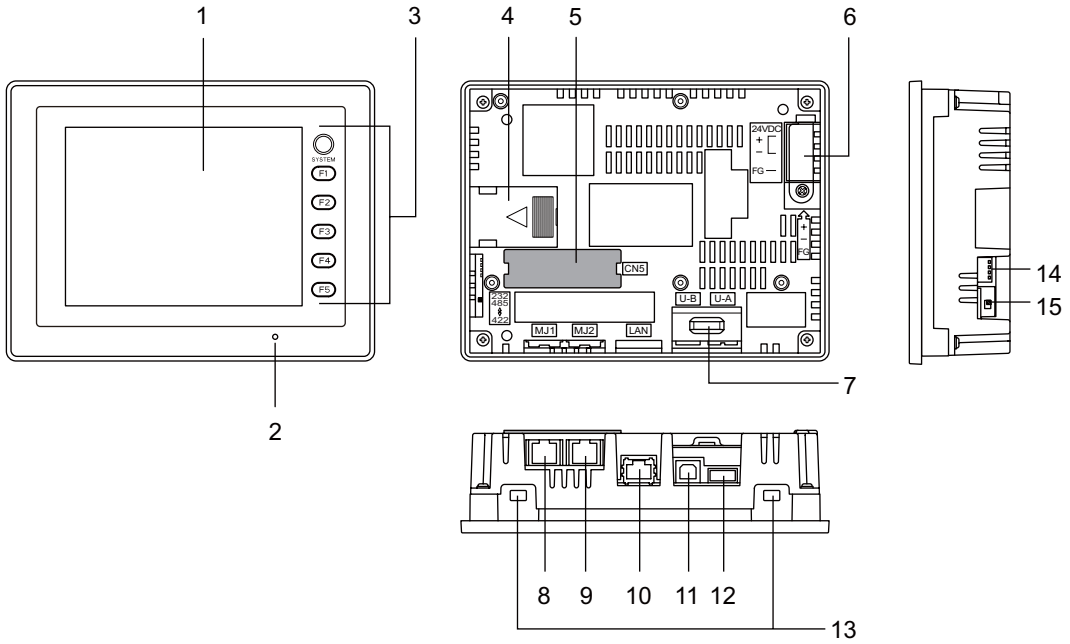

#### V806 + DU-10

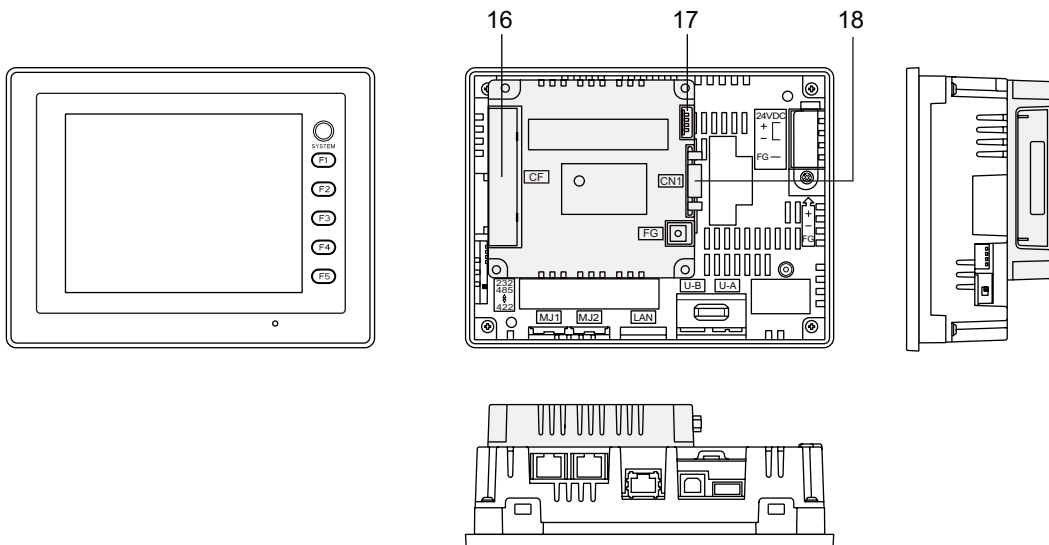

1. Display  
This is the display unit.
2. Power lamp (POWER)  
Illuminates in green when the V806 series is powered on and is operating normally. When an error occurs to the backlight (burned-out backlight, etc.), the power lamp will flash.
3. Function switches  
Used for RUN/STOP selection, brightness adjustment, contrast adjustment and backlight ON/OFF (settings must be made on the V-SFT-5 editor). These switches can be used as user-defined switches in the RUN mode.
4. Battery holder  
Contains a backup battery for SRAM and clock.  
When the battery voltage drops, replace the battery with a new one (V7-BT).
5. Communication interface unit connector (CN5)  
This is the connector where the option unit, "DU-10" or "CU-xx", for SX BUS, OPCN-1, T-LINK, CC-Link, Ethernet, PROFIBUS-DP, DeviceNet or FL-net is mounted.
6. Power supply terminal block  
Supplies the power (24 VDC) to the V806 series.
7. USB cable clamp hole  
Used for attaching a USB cable tie.
8. Modular jack 1 (MJ1)  
Used for screen data transfer and connection with PLCs or other peripheral devices.
9. Modular jack 2 (MJ2)  
Used for connection with PLCs or other peripheral devices.
10. 100BASE-TX/10BASE-T connector (LAN)  
Used for Ethernet connection. Only the V806i series supports it as standard. The V806 series additionally needs an optional unit, "CU-03-3".
11. USB-B (slave port)  
Used for screen data transfer or connection with a PictBridge-compatible printer.
12. USB-A (master port)  
Used for connecting a printer, USB-CFREC, keyboard, mouse or other such devices.
13. Mounting holes  
Used for inserting fixtures when securing the V806 series to the mounting panel.
14. DIP switch  
Used for setting the terminating resistors of the RS-422/RS-485 signal line for the MJ1/MJ2.
15. Slide switch  
Used for switching between the RS-232C and RS-422 ports for the MJ2.  
Slide the switch up for RS-232C/RS-485 signals, or slide it down for RS-422 signals.
16. CF card connector (option unit "DU-10")  
This is the connector where the CF card is inserted. Access to the CF card is enabled when the cover is closed.
17. DIP switch (option unit "DU-10")  
Used for setting the terminating resistance of the CN1 signal line.
18. PLC communication connector (CN1) (option unit "DU-10")  
Used for connection with a controller (PLC, temperature controller, inverter, etc.).

## 4. Modular Jack (MJ1 / MJ2)

### Modular Jack 1 (MJ1) / 2 (MJ2)

A screen data transfer cable (MJ1 only), temperature controller, barcode reader, CREC, or V-I/O can be connected to the modular jack (MJ1 or MJ2).

Bottom View

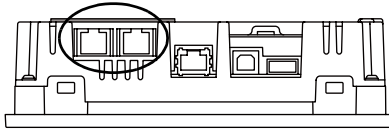

Pins of MJ1 and MJ2 correspond to signals as given below.

MJ1/2					
Pin No.	MJ1		MJ2		
	Signal	Contents	Slide Switch <sup>*1</sup>	Signal	Contents
1	+SD/RD	RS-485 + data	Upper	+SD/RD	RS-485 + data
			Lower	+SD	RS-422 + send data
2	-SD/RD	RS-485 - data	Upper	-SD/RD	RS-485 - data
			Lower	-SD	RS-422 - send data
3	+5 V	Externally supplied +5 V <sup>*2</sup>	-	+5 V	Externally supplied +5 V <sup>*2</sup>
4	+5 V			+5 V	
5	SG	Signal ground		SG	Signal ground
6	SG			SG	
7	RD	RS-232C receive data	Upper	RD	RS-232C receive data
			Lower	+RD	RS-422 + receive data
8	SD	RS-232C send data	Upper	SD	RS-232C send data
			Lower	-RD	RS-422 - receive data

\*1 The slide switch for MJ2 is mounted on the lower side of the V806.

Side View

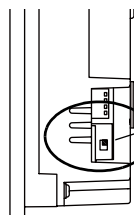

Slide switch (Upon delivery : upper)

Upper: RS-232C/RS-485 (2-wire connection)

Lower: RS-422 (4-wire connection)

- \*2 Allowable current for the external power supply +5 V at MJ1/MJ2/USB-A of the V806 series
- For MJ1 and MJ2, the maximum allowable current is 150 mA in total.
  - When connecting an optional unit, be careful not to exceed the total allowable current for USB-A, MJ1 and MJ2.

Optional Unit	MJ1 + MJ2 + USB-A Allowable Current
None	500 mA
DU-10	250 mA
CU-00 CU-01 CU-02-2 CU-03-3 CU-04 CU-06 CU-07 CU-08	150 mA

### Combined Use of MJ1 and MJ2 Functions

Multi-link 2 and ladder transfer function cannot be used at the same time.



## 5. USB Connector

### USB-A (Master Port)

A printer, USB-CFREC, barcode reader, keyboard, mouse or USB hub can be connected via USB-A port.

The USB port on the V806 unit is compliant with USB 1.1.

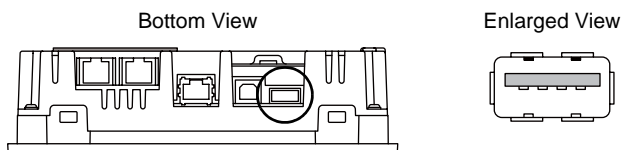

### Printer

Screen hard copy, historical data or data sheet can be printed out from the printer connected to the V806 series.

#### Connection Example

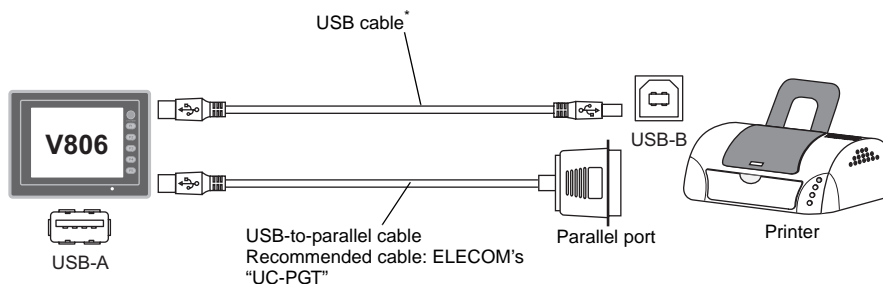

\* Use a cable included as an accessory of the printer.

#### Available Printer

Model*	Port on the Printer Side	Cable
PR-201 ESC-P	Parallel port	UC-PGT
EPSON STYLUS PHOTO EPSON STYLUS C86 EPSON STYLUS C65	Parallel port	UC-PGT
	USB-B	USB cable

\* For more information on the printer that can be connected to the V8 series, refer to the V8 Series Reference Manual separately provided.

#### V-SFT-5 Setting

Select [System Setting] → [Device Connection Setting] → [Others] → [Printer], and select a desired printer type for [Type] and "USB-A" for [Connect to:] in the [Printer] tab window.

## USB-CFREC

By connecting a USB-CFREC to the V806 series, a CF card is made available for screen data transfer or historical data saving.

### Connection Example

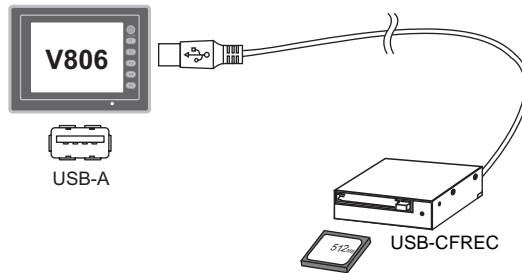

### V-SFT-5 Setting

Select [USB Port] for the CF card connecting port in the [System Setting] → [CF Card Setting] dialog.

## Barcode Reader

Barcode data can be read by connecting a barcode reader to the V806 series.

### Connection Example

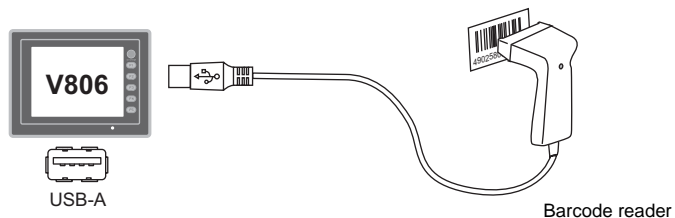

### Available Barcode Reader

- A USB-HID-compliant barcode reader can be connected.
- For details on barcode readers whose operations have been verified, visit our website (<http://www.monitouch.com>).

### V-SFT-5 Setting

Select [System Setting] → [Device Connection Setting] → [PLCn: Barcode], and select [USB A] for [Connect to:] and the desired code type in the [Communication Setting] tab window.

## Keyboard

Entering numerical data or character data is possible by connecting a keyboard or numeric keypad to the V806 series.

### Connection Example

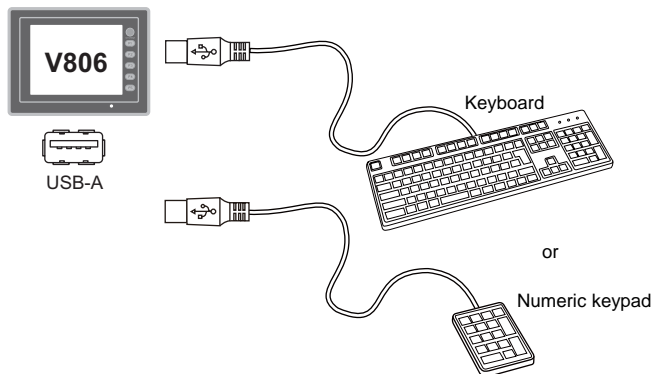

### Available Keyboard

Keyboards	Types
Japanese keyboard	106 keyboard, 109 keyboard, etc.
US standard keyboard	101 keyboard, 104 keyboard, etc.
Numeric keypad	

### V-SFT-5 Setting

An [Entry] icon must be registered on the screen where the keyboard is to be used. In addition, numerical data or character display parts of [Display Function: Entry Target] are required.

For more information, refer to the V8 Series Reference Additional Functions.

### V806 Series Setting

On the Keyboard Selection screen, select a type of the keyboard to be connected.

For more information, refer to "Keyboard Selection" on page 5-47.

## Mouse

Mouse operation on the V806 series screen is possible by connecting a mouse to the V806 series.

### Connection Example

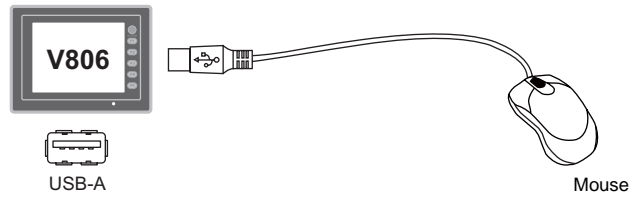

For more information, refer to the V8 Series Reference Additional Functions.

## USB Hub

A printer and a USB-CFREC can be used at the same time by using a USB hub to the V806 series.

### Connection Example

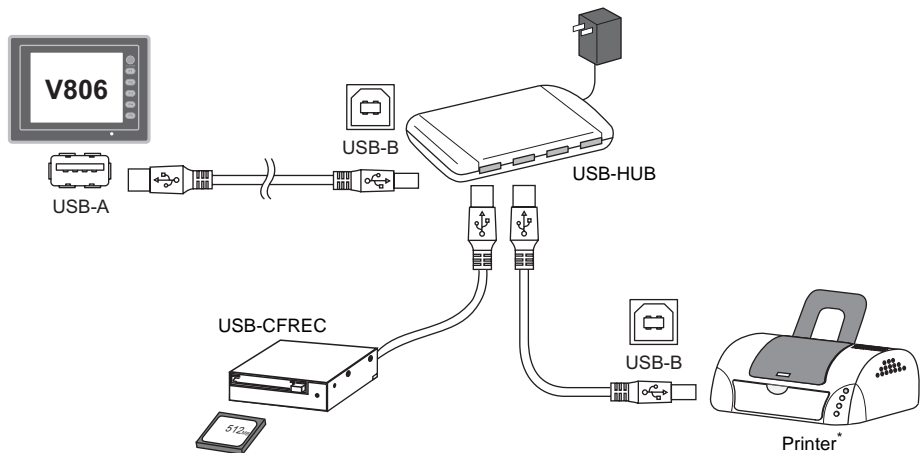

\* The parallel printer can also be connected. (In this case, the parallel printer which can be used on the V806 series and a commercially available parallel-to-USB cable (ELECOM's UC-PGT recommended) must be used. For more information on the printer that can be used on the V8 series, refer to the V8 Series Reference Manual separately provided.)

### Recommended USB Hub (Operations Verified)

The operations of the USB hubs shown below are verified.

Manufacturer	Model	Remarks <sup>*</sup>
ELECOM	U2H-Q4SBS	USB 2.0 compatible
ELECOM	U2H-G4S2 series	USB 2.0 compatible
ELECOM	UH-A4SID	USB 1.1 compatible
Arvel	H415US2-LV	USB 2.0 compatible
Arvel	H413US-BL	USB 1.1 compatible

\* USB2.0-compatible hub can be connected; however, it works as USB 1.1 because the USB port on the V806 unit is compliant with USB 1.1.

### V-SFT-5 Setting

Refer to "V-SFT-5 Setting" on page 2-14 for the printer and page 2-15 for the USB-CFREC.

### Notes

- The barcode reader and the keyboard cannot be connected to the USB hub at the same time.
- Two or more barcode readers or keyboards cannot be connected to the USB hub at the same time.
- Two or more USB-CFREC cannot be used via a USB hub at the same time.  
It is impossible even if they are the ones of different manufactures or models.  
When multiple reader/writers are connected to the USB hub, only the one which has been connected first is recognized.
- A maximum of two USB hubs can be connected (cascaded) to the V806 unit.  
Note that the performance will be decreased more when two USB hubs are connected.
- Do not turn off the power adaptor or disconnect the connector between the power adaptor and the USB hub when the USB hub is connected to the V806 unit and is activated by its power adaptor.  
Doing so may cause insufficient power supply to the V806 unit resulting in faulty operation such as repeated restarting.
- When connecting two USB hubs to the V806 unit, supply the power to the USB hub using the adaptor included with the hub.  
Even if connecting one USB hub, use the power supply adaptor included with the USB hub if provided.
- Disconnect the USB cable from the USB-CFREC while displaying the Main Menu screen or holding down the [CF Card Removal] switch on the screen.

## USB-B (Slave Port)

Screen data can be transferred and the PictBridge-compatible printer can be connected via USB-B.

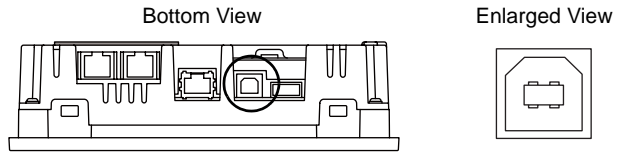

### Printer (PictBridge)

Screen hard copy, historical data or data sheet can be printed out from the PictBridge-compatible printer.

#### Connection Example

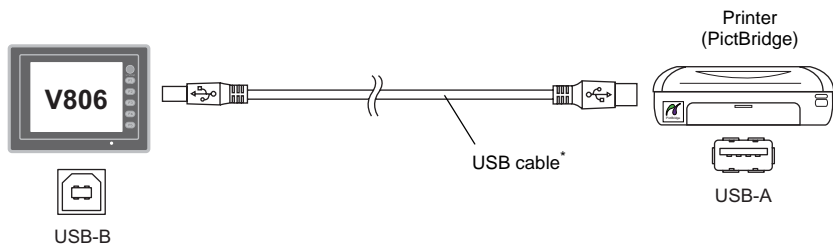

\* Use a commercially available USB cable. It is recommended to use a shielded twist-pair USB cable of 5 m long.

#### Available Printer

Any PictBridge-compatible printer can be connected.

#### V-SFT-5 Setting

Select [System Setting] → [Device Connection Setting] → [Others] → [Printer], and select "PictBridge" for [Type] in the [Printer] tab window.

## Transferring Screen Data

Screen data can be transferred via USB-B (USB slave port).

Be sure to install the dedicated USB driver for the V806 series on the computer. For the installation procedure, refer to "Installation Procedure of the Driver for Screen Data Transfer" on page 2-20.

### Connection Example

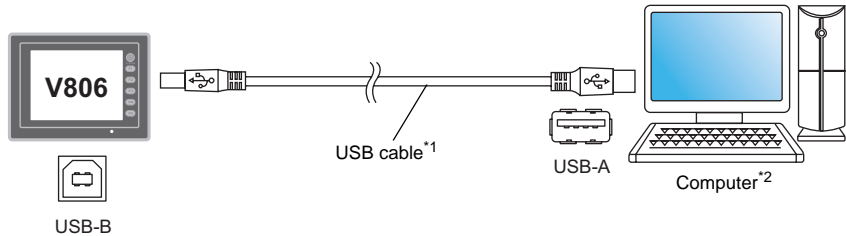

\*1 Use a commercially available USB cable. It is recommended to use a shielded twist-pair USB cable of 5 m long.

\*2 When using USB on Windows 98, Windows 98 Second Edition or later is required.

### Installation Procedure of the Driver for Screen Data Transfer

The installation procedure on Windows XP is described as an example below.

1. Connect the USB-B port of the V806 series (with power on) to the computer (with power on) using a USB cable.
2. The message "Found New Hardware" and then the driver installation wizard appear on the computer. Select [No, not this time] and click the [Next] button.

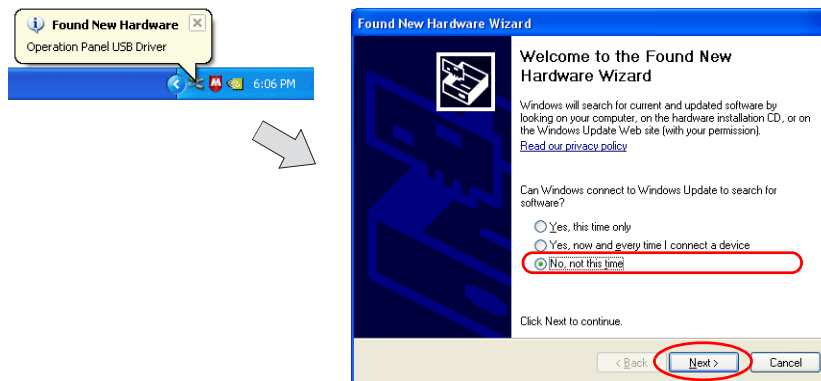

3. The dialog below is displayed. Select [Install from a list or specific location], and click the [Next] button.

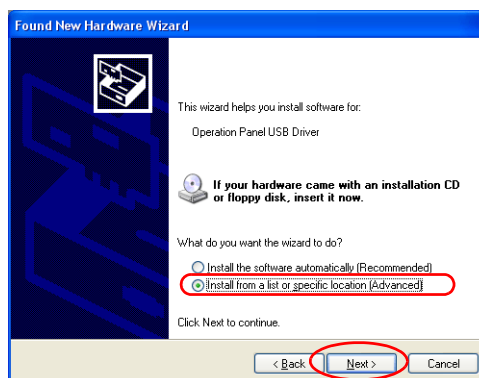

4. The following dialog is displayed. Select [Don't search. I will choose the driver to install.], and click the [Next] button.

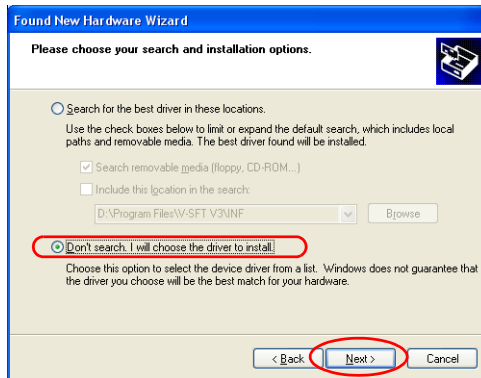

5. The dialog below is displayed. Click the [Next] button.

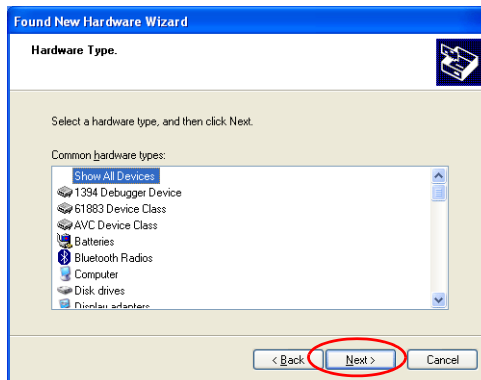

6. The following dialog is displayed. Click [Have Disk] button.

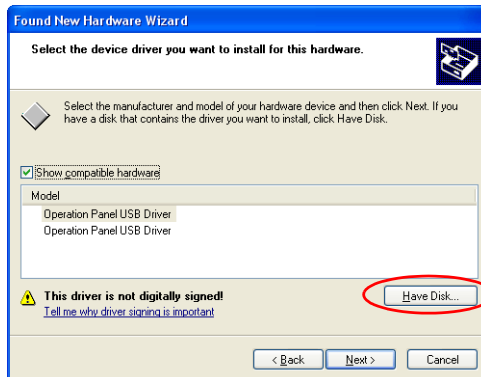

7. The [Install From Disk] dialog is displayed. Click the [Browse] button.

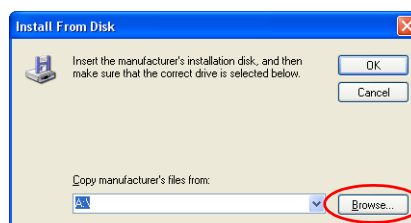



8. The USB driver “OP-U.inf” is automatically stored in the installation folder within the V-SFT-5 editor (“INF” folder in the V-SFT V5 as an example).

**CAUTION**

The USB driver to be installed varies, depending on the OS installed on your computer. Be sure that the driver is correct.

Select the “OP-U.inf” file and click the [Open] button.

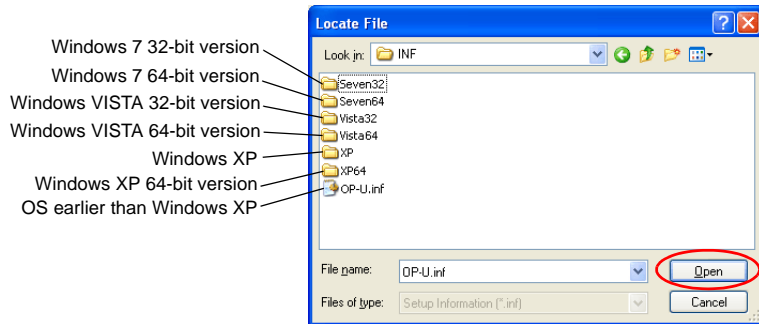

9. The previous dialog is displayed again. Check the path shown under [Copy manufacturer's files from:] and click the [OK] button.

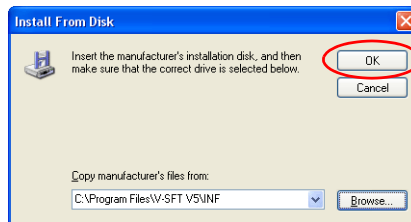

10. The following dialog is displayed. Check that [Operation Panel USB Driver] is shown under [Model]. Click the [Next] button.



11. The driver installation starts.

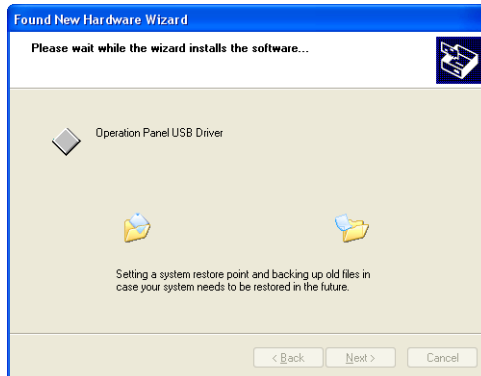

12. The dialog shown below is displayed on completion of installation. Click the [Finish] button.



### Recognition of USB Driver

When the driver has been installed successfully, the [Device Manager] window shows “Operation Panel - Operation Panel USB Driver”.

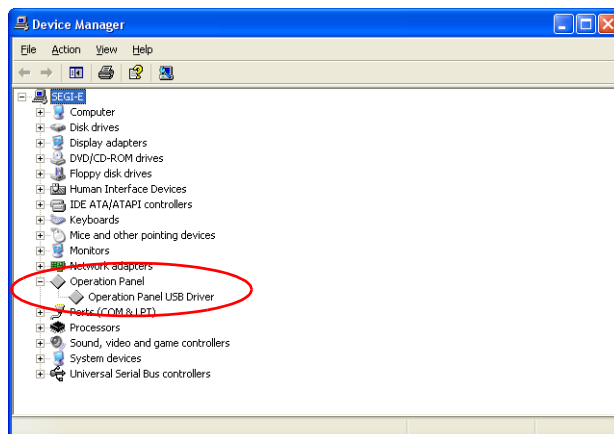

This will disappear when MONITOUCH and computer are disconnected.

If [Other Device] or [?] is shown even while their connection via USB is maintained, the USB driver is not recognized. If this happens, uninstall the USB driver and reinstall it.

## Securing USB Cable

A USB cable may be disconnected from the V806 unit depending on the mounting condition. To avoid disconnection, use the USB cable clamp or cable tie supplied with the unit.

### Components for USB Cable Fixation

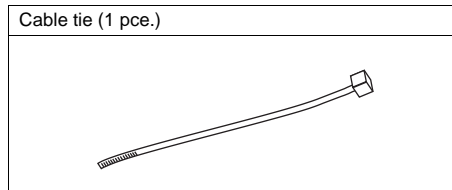

### Securing USB Cable

1. Draw a cable tie through the hole as shown in the figure below.

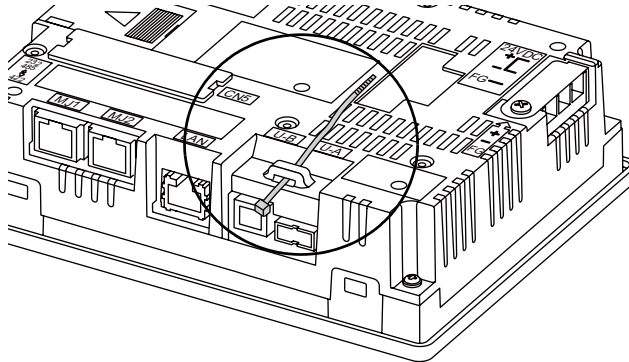

2. Insert a USB cable and secure it using the cable tie.

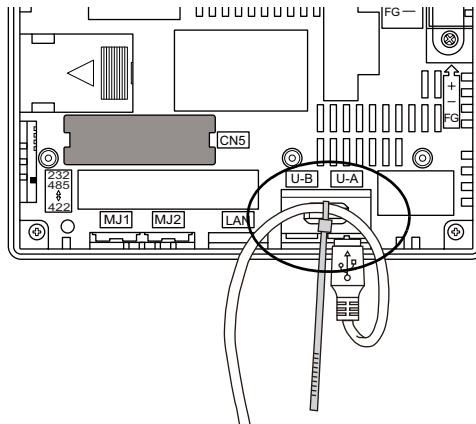

The following figure shows the case where only USB-B is used and the one where both USB-A and USB-B are used.

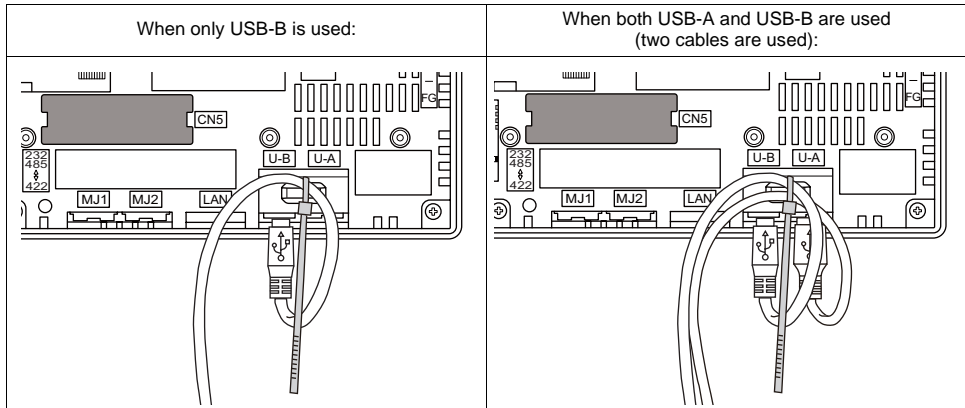

## 6. LAN Connector (LAN)

### LAN Connector

An Ethernet-ready controller and a V806i series can be connected via a LAN connector. The LAN connector supports 100BASE-TX/10BASE-T.

- \* The V806 series needs the additional optional communication unit, "CU-03-3".

Bottom View

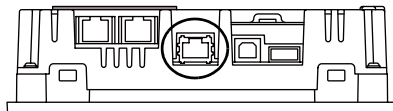

MJ1 (or MJ2) and LAN connector are 8-pin modular jacks. Check the indication on the unit and insert a cable into the correct position. Do not connect any over voltage peripheral device to the LAN connector.

The LAN connector pins correspond to signals as given below.

Specification: IEEE802.3 (u) compliant, supporting UDP and TCP/IP

LAN	Pin No.	Signal	Contents
	1	TX+	Ethernet send signal (+)
	2	TX-	Ethernet send signal (-)
	3	RX+	Ethernet receive signal (+)
	4	NC	Not used
	5	NC	Not used
	6	RX-	Ethernet receive signal (-)
	7	NC	Not used
	8	NC	Not used

## Wiring



When using the LAN port, keep the LAN cable away from the power supply cable as much as possible.

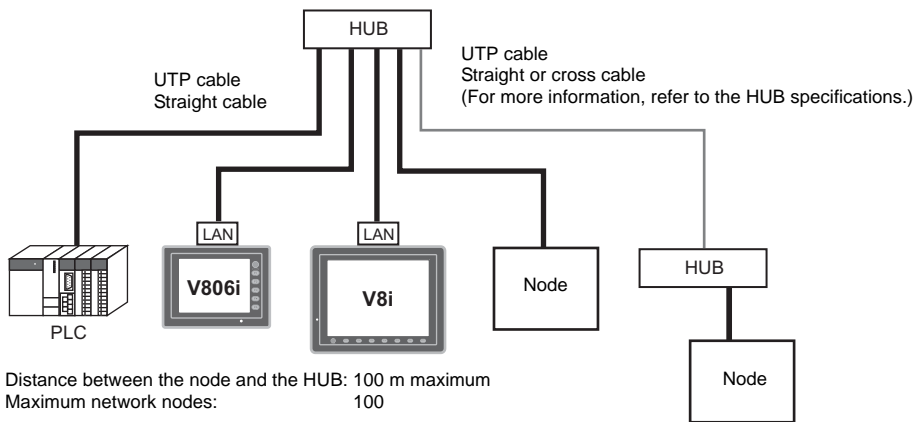

### Cable Connection Diagram

Straight cable  
(with hub)

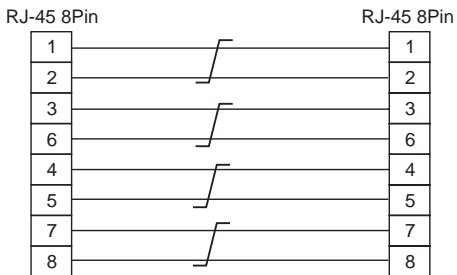

\* Unshielded twist-pair cable

Cross cable  
(without hub)

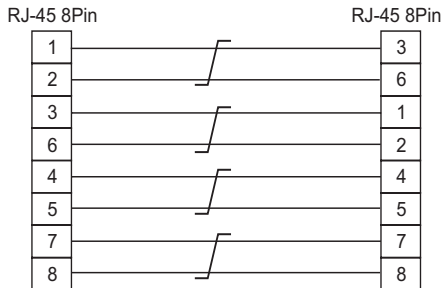

\* Unshielded twist-pair cable

### Recommended Cable

Use a commercially available cable. Using a self-made cable may cause an error in network connection.

Recommended cable: 100 Ω, UTP (unshielded twist-pair) cable, category 5

## 7. Serial Connector (CN1) (Optional)

### Connector for a Controller

When the option unit, "DU-10", is mounted, communication (RS-232C, RS-422/485) with a controller is enabled via the serial connector (CN1).

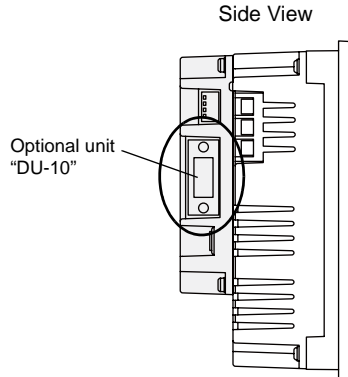

The serial connector pins correspond to signals as given below.

CN1 (D-sub 9-pin, female)				
Pin No.	RS-232C <sup>*1</sup>		RS-422 / RS-485 <sup>*1</sup>	
	Signal	Contents	Signal	Contents
1	NC	Not used	+RD	Receive data (+)
2	RD	Receive data	-RD	Receive data (-)
3	SD	Send data	-SD	Send data (-)
4	NC	Not used	+SD	Send data (+)
5	SG	Signal ground	SG	Signal ground
6	NC	Not used	+RTS	Request to send (+)
7	RTS	Request to send	-RTS	Request to send (-)
8	CTS	Clear to send	NC	Not used
9	NC	Not used	+5 V	Use prohibited <sup>*2</sup>

<sup>\*1</sup> The signal level can be changed between RS-232C and RS-422/485 on the configuration software. When RS-232C is selected, set the DIP switches 1 and 2 to the OFF position. (For more information on the DIP switch, refer to Chapter 4.)

<sup>\*2</sup> When RS-422/485 is selected, +5 V is output from pin No. 9. +5 V is used as the power supply for the external terminating resistance for RS-422/485 communication. It cannot be used as an external power supply.

### Recommended Connector

The following connector is recommended for a self-made cable.

Recommended connector	DDK's 17JE-23090-02(D8C)-CG	D-sub 9-pin / male / inch screw thread (#4-40UNC) type / with hood / lead- and cadmium-free
-----------------------	-----------------------------	---

## 8. CF Card (Optional)

### CF Card Socket

If the optional unit, "DU-10", is mounted on the V806, the CF card interface is usable. You can then use a CF card for transferring screen data or saving historical and image data. The CF card interface is provided on the side of the "DU-10".

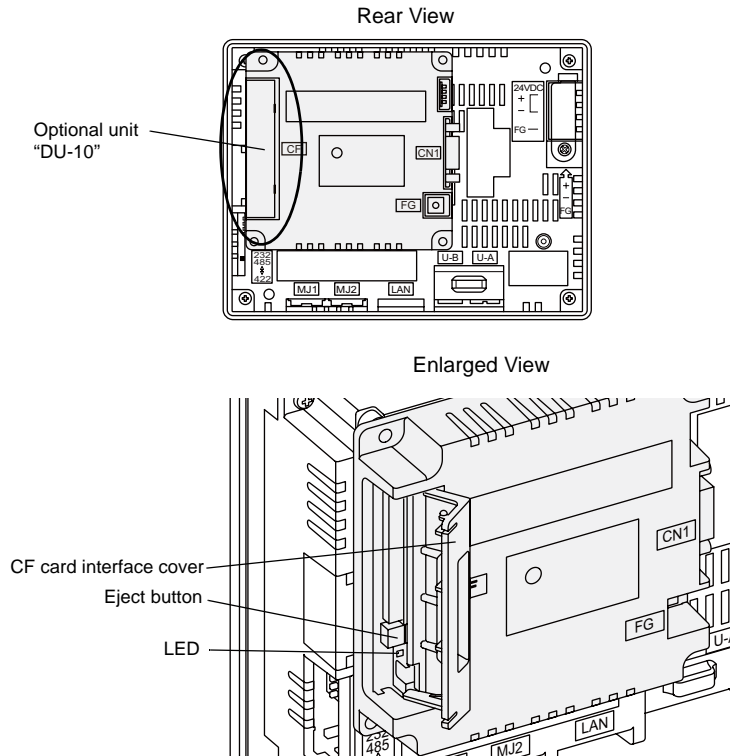

#### LED

With the DIPSW4, the LED status when the CF card interface cover is opened can be set.

DIPSW4	LED	Contents
OFF	Off	The power is not supplied to the CF card. The CF card can be removed.
	Lights up in red	The power is supplied to the CF card. At the completion of access, the LED goes off.
ON	Lights up in red	Access to the CF card is possible at all times.

#### CAUTION

When the DIPSW4 on "DU-10" is set to the ON position, access to the CF card is enabled whether the cover is opened or not. In case access to the CF card is disabled because of damage of the CF card interface cover, set the DIPSW4 to the ON position. Normally keep it in the OFF position.





## Notes on Handling the CF Card

1. The V806 series can recognize a CF card in the file system of FAT or FAT32.
2. The LED lamp on the CF card interface cover illuminates in red when the power is supplied to the CF card. Do not insert or remove the CF card while the LED lamp is illuminating. Doing so may destroy data on the CF card. Check that the LED lamp has gone off before inserting or removing the CF card.
  - \* DIPSW4: OFF (Refer to "LED" on page 2-29.)
3. Do not turn the main unit off during access to the CF card.
4. Make a backup copy of the CF card at regular intervals.
5. If a disk error occurs and data read/write operation is disabled, perform a scan disk on Windows and try to restore the disk. If not restored, format the CF card. Note that data on the CF card will be completely deleted by formatting. (For information on scan disk and Windows operations, refer to the manual for Windows.)
6. The number of writing times per CF card is limited (approx. 300,000 times). Consequently, frequent writing at short intervals may shorten service life of the CF card. When using a CF card to save sampling data, be aware of the sampling time. Also, avoid repeated writing using a CYCLE macro command.

### CF Card Insertion/Removal Procedure

1. Open the CF card interface cover.
2. Insert the card securely into the interface with the card backside outwards viewed from the side of the unit as shown below.

### CAUTION

Insert the CF card into the V806 unit in the correct orientation. Failure to do so may damage the CF card or the socket at the unit.

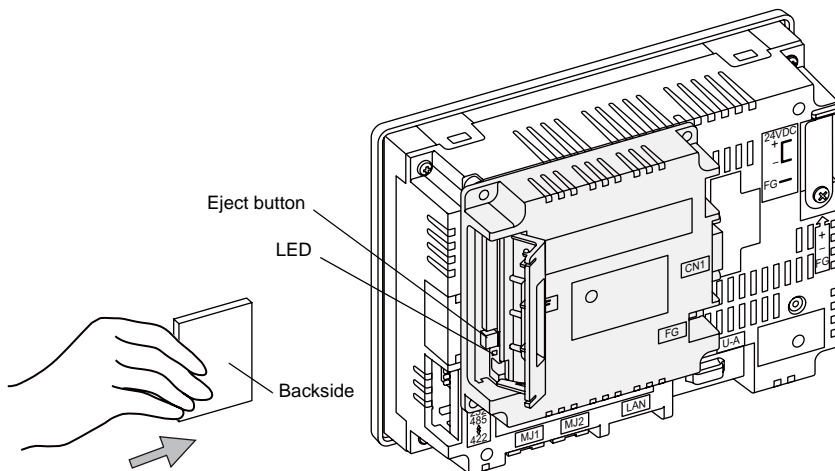

3. Close the CF card interface cover. The LED lamp lights up in red.
4. To remove the card, open the CF card interface cover first. When the LED lamp has gone off, press the eject button. The card pops out.

# 3 Installation

---

1. Mounting Procedure
2. Power Supply Cable Connection

# 1. Mounting Procedure

## Mounting Procedure

1. Insert the V806 unit into the mounting panel (max. thick: 5 mm).

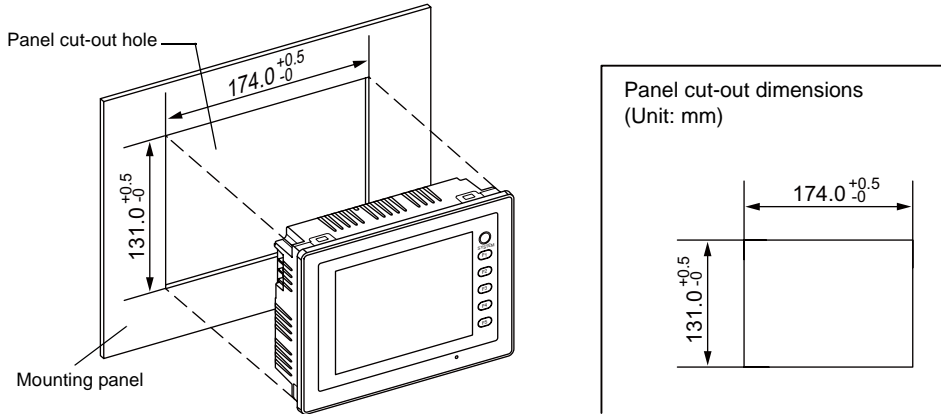

2. Insert four fixtures attached to the V806 series into the mounting holes, and tighten them with the tightening screws.  
Tightening torque: 0.5 to 0.7 N•m

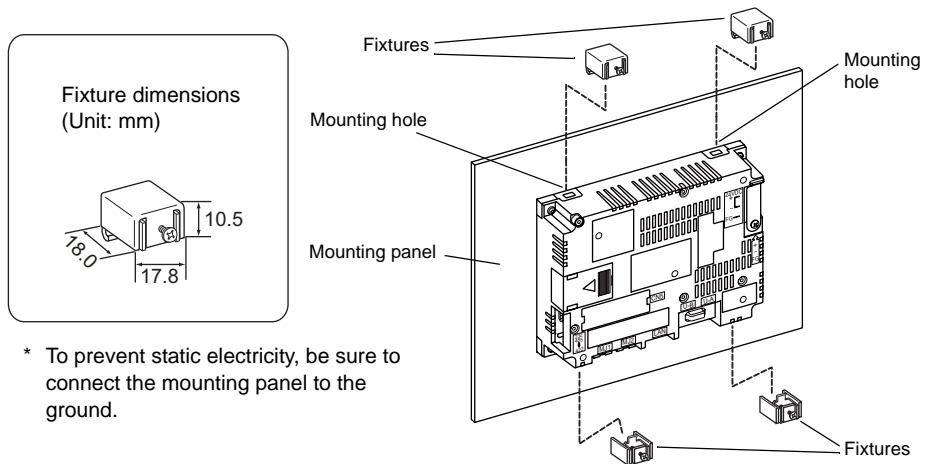

\* To prevent static electricity, be sure to connect the mounting panel to the ground.

3. Mount the gasket so that it will be sandwiched securely between the V806 unit and the mounting panel.

## Mounting Angle

Install the unit between  $0^\circ$  to  $135^\circ$  as shown on the right. When the communication unit, "CU-xx", is mounted, the angle should be adjusted, depending on the model or the operational ambient temperatures. For more information, refer to "Chapter 2 1. Specifications" (page 2-1).

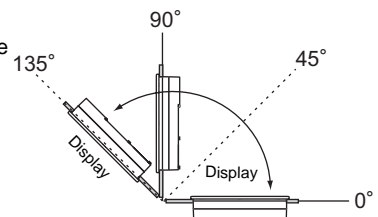

## 2. Power Supply Cable Connection

**DANGER**

Electric shock hazard

Shut the power off before connecting the power supply cable.

### Power Supply Cable Connection

Connect the power supply cable to the terminal on the backside of the unit.

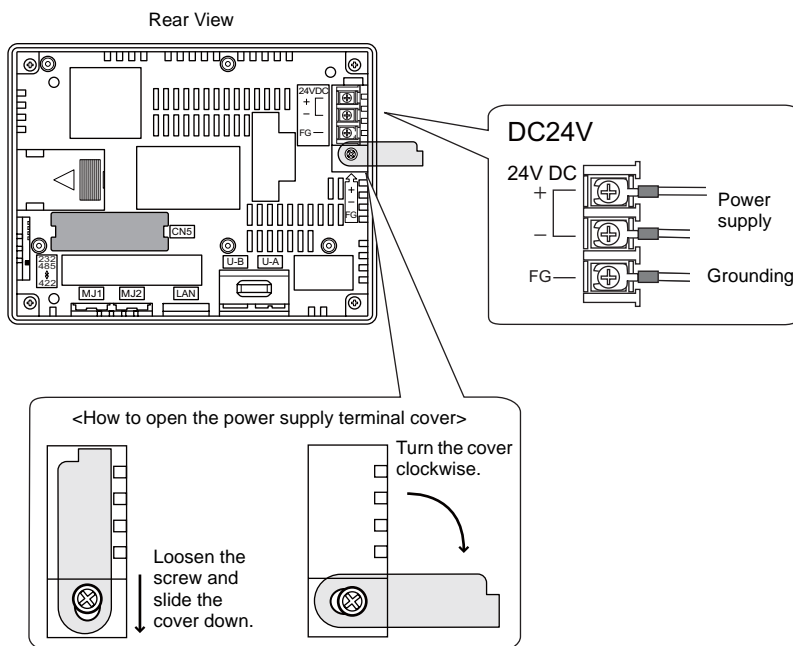

### Power Supply Cable Specifications

For specifications of the power supply cable and the tightening torque of the screws on the power supply terminal block, refer to the following table.

Terminal Screw			Power Cable
Screw Size	Tightening Torque	Crimp-style Terminal	
M3.5	1.2 N•m		AWG14 - 16

### Notes on the Power Supply:

- The power source must be within the allowable voltage fluctuation.
- Use a power source with low noise between the cables or between the ground and the cable.
- Use as thick a power supply cable as possible to minimize drop in voltage.
- Keep power supply cables away from high-voltage, large-current carrying cables.

## Grounding



Be sure to establish a ground of the V806 series.  
(The level of grounding resistance should be less than 100  $\Omega$ .)

- An independent earth pole must be used for MONITOUCH.
- Use a cable which has a nominal cross section of more than 2 mm<sup>2</sup> for grounding.
- Set the grounding point near MONITOUCH to shorten the distance of grounding cables.

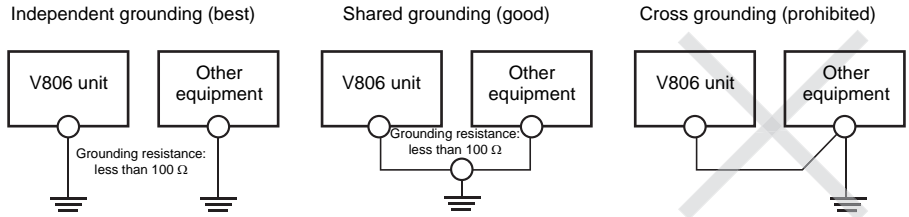

MEMO

Please use this page freely.

# 4 Instructions

---

1. Coin-type Lithium Battery (V7-BT)
2. DIP Switches
3. Function Switches

# 1. Coin-type Lithium Battery (V7-BT)

## CAUTION

MONITOUCH is delivered without inserting the battery connector in the battery holder on the back of the unit.  
Be sure to set the battery when using the calendar function or SRAM.  
Without a battery, the contents in the SRAM or calendar will not be retained.

## Battery Usage

The battery is used for the user memory area (non-volatile memory \$L and \$LD, storing sampling data, etc.) in SRAM, or backup battery for the built-in clock.

## Battery Mounting Procedure

## DANGER

Electric shock hazard  
Steps 2 to 5 must be performed when the power to the V806 series is turned off.

1. Turn the unit off.
2. While holding down the position around the rectangle (<img alt="triangle symbol" data-bbox="408 473 428 488"/>) mark on the battery holder cover (as shown below), slide the cover to the left until it is dislodged.

Rear View

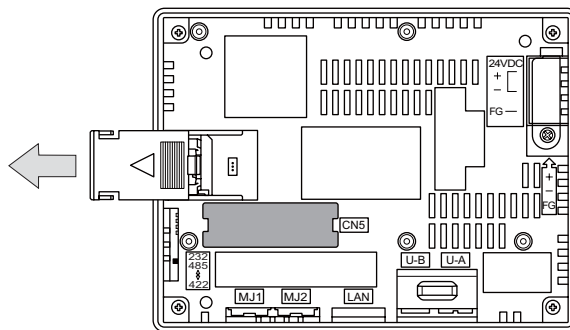

3. Check that the battery is securely mounted, and connect the battery connector.

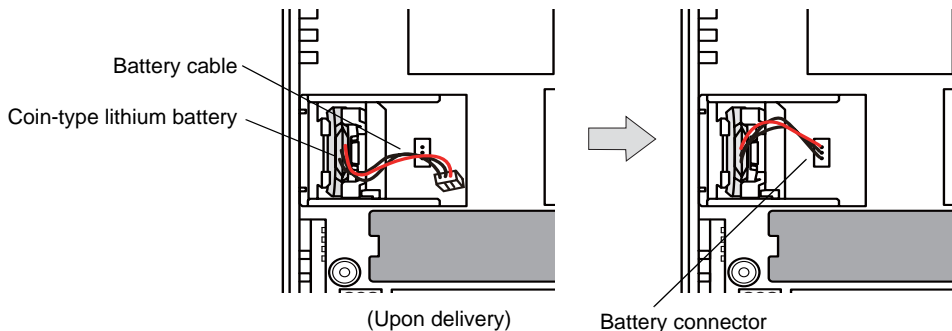



- 4. Reattach the battery holder cover by sliding it until you feel a click.
- 5. Under "Battery replacement" on the sticker above the battery holder cover, enter the date five years from now.

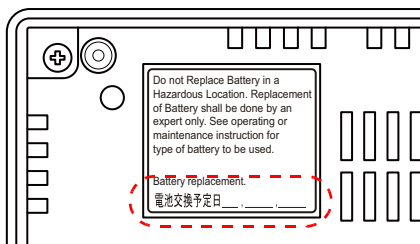

- 6. Turn the V806 unit on. When no battery is set, the message "Battery not set" is displayed, and when the battery voltage has dropped, the message "Brownout Battery" is displayed at the bottom left of the Main Menu screen.

Main Menu screen when the battery is not connected

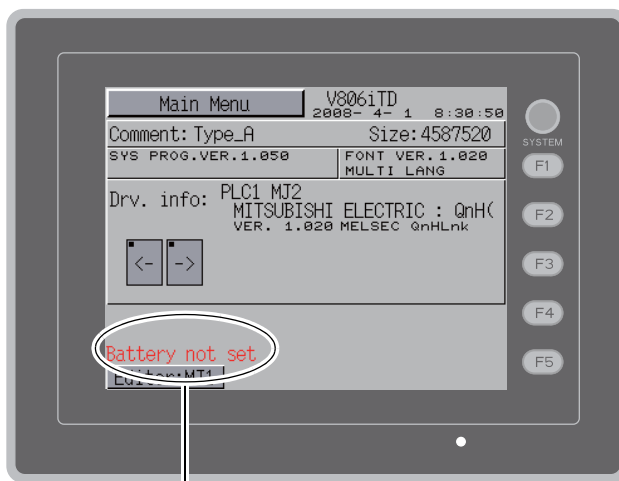

The message "Battery not set"

## Battery Voltage Drop Detection

The battery status is output to the internal memory \$s167 of the V806 series. When the battery voltage is lowered, the message "Brownout Battery" is displayed at the bottom center on the Main Menu screen. If the battery voltage drops before five years has elapsed, replace the battery immediately.

	MSB										LSB					
\$s167	15	14	13	12	11	10	09	08	07	06	05	04	03	02	01	00
	0	0	0	0	0	0	0	0	0	0	0	0	0	0	0	0

└ System reserved (Setting: 0)	0: Battery OK. 1: Battery voltage drop 2: No battery
--------------------------------	--

If the battery voltage drops (4th bit is set) before five years has elapsed, replace the battery immediately.

## Battery Replacement

Replacement batteries are available from Hakko Electronics.

Name	Model	Contents
Battery for replacement	V7-BT	<ul style="list-style-type: none"> <li>Coin-type lithium primary cell 1 pce.</li> <li>Cautions sticker 1 pce.</li> </ul>

### Safety Instructions on Handling the Battery

Lithium batteries contain combustible material such as lithium or organic solvent. Mishandling may cause heat, explosion or ignition resulting in fire or injury. To prevent accidents, pay attention to the following cautions when handling the lithium battery.



#### CAUTION

- Be sure to discharge static electricity from your body before battery replacement.
- Use the battery "V7-BT" (replacement battery) for replacement.
- Rough handling of the battery may cause a fire or chemical burn hazard.
- Do not disassemble, incinerate or heat the battery.
- Observe local and governmental regulations when disposing of waste batteries.
- Keep batteries out of reach of children. (If swallowed, immediately consult a doctor.)
- Never re-charge the battery.
- When the battery leaks or smells, the leaking battery electrolyte may catch fire. Keep from heat or flame.

### SRAM Area Backup Procedure

Replace the battery "V7-BT" within three minutes after the unit is turned off.

If it is not possible to replace within three minutes, use the V-SFT-5 editor or a CF card and make a backup copy of data in the SRAM.

#### When Using the V-SFT-5 Editor:

- 1) Connecting a cable  
Connect the V806 unit and the computer using the transfer cable ("V-CP", USB cable, Ethernet cable)
  - 2) Starting the V-SFT-5 editor  
Start the V-SFT-5 editor on the computer.
  - 3) Displaying the [Transfer] dialog  
Click the [Transfer] icon. The [Transfer] dialog is displayed.
  - 4) Selecting data to be transferred  
Select [Display] for [Transfer Device], and [SRAM Data] for [Transfer Data].  
Do not check [Use Simulator].
  - 5) Starting SRAM data transfer  
Click the [PC <-] button under [Transfer]. Data transfer from the SRAM is started.
  - 6) Saving the SRAM data  
When the SRAM data has been transferred, the [Save As] dialog is displayed on the computer. Save the data as a backup copy. The extension is "\*.RAM".
- \* To transfer the "\*.RAM" data saved as a backup to the V806, click the [PC ->] button under [Transfer] in step 5).

#### When Using a CF Card:

For the backup procedure with a CF card, refer to "Saving Backup Copies of SRAM" in Chapter 5 (page 5-24).

## Battery Replacement Procedure



### DANGER

Electric shock hazard

Steps 1 to 5 must be performed when the power to the V806 series is turned off.

1. Turn off the power to the V806. Dislodge the battery holder cover by sliding it. The battery fit in the socket comes into view.
2. Disconnect the battery connector. Disengage the battery from the socket by pulling the battery toward you.

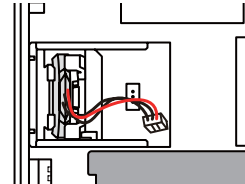

3. Insert a new battery in an upright position. Check that the side with the red cable faces the right, and fit the battery on the protrusions inside the socket.

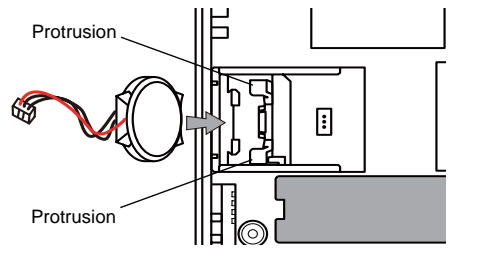
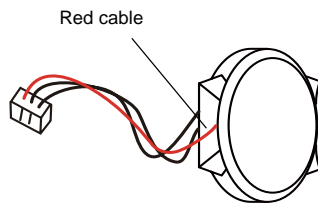

4. Plug in the battery connector and close the battery holder cover.
5. Remove the existing caution sticker. Enter a date five years from now for "Battery replacement" as an expiry date on the new caution sticker, and attach it to the battery holder.
6. Turn on the V806 unit. Be sure that a message "Battery not set" or "Brownout Battery" does not appear at the bottom center of the Main Menu screen.
7. If the backup data "\*.RAM" has been made, transfer it to the V806 series.

## Notes on Battery: EU Directive 2006/66/EC

According to the EU directive 2006/66/EC effective in EU countries, the battery supplied with the V806 series as well as the package box of the V806 series have the marking shown right:



### CAUTION

- The marking shown right above is effective only in EU countries.
- The details on the marking is designated in Article 20 "Information for end-users" and ANNEX II in the EU directive 2006/66/EC.
- The marking indicates that the battery should be disposed of separately from general household waste.
- If element symbols are indicated below the marking, it means that the battery contains the specified heavy metal at a concentration exceeding the control value. The control values of concentration are given below.  
Hg: mercury (0.0005 %), Cd: cadmium (0.002 %), Pb: lead (0.004 %)
- The EU has determined the separating program for used batteries. Dispose of used battery properly at your local waste-disposal/recycling center.

## 2. DIP Switches

The V806 and optional unit, "DU-10", are respectively equipped with four (1 to 4) DIP switches. When setting the DIP switches, turn the power off.

### V806

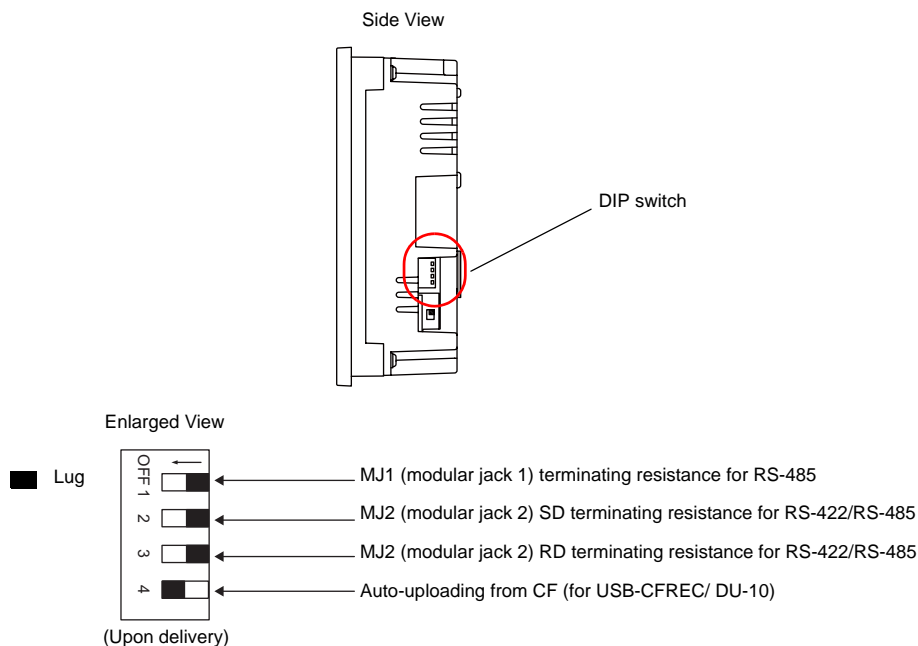

### DIPSW1, 2, 3 (Terminating Resistance Setting)

- MJ1 can be used for RS-232C or RS-485 (2-wire) connection. For the following connections, set DIPSW1 to the ON position.
  - Master station for multi-link2 connection
  - Connection with a controller (PLC, temperature controller, etc.) via RS-485
  - Connection with the card recorder "CREC" (optional)
  - Connection with the serial extension I/O "V-I/O" (optional)
  - Connection to the V806 unit at the termination of V-link connection via RS-485
- MJ2 can be used for RS-232C, RS-422 (4-wire) or RS-485 (2-wire) connection. For connection via RS-485 (2-wire connection), set the DIPSW3 to the ON position. For connection via RS-422 (4-wire connection), set the DIPSW2 and DIPSW3 to the ON positions.

### DIPSW4\* (Auto-uploading from CF)

Set the DIPSW4 to the ON position when auto-loading a screen data file saved on a CF card.

#### Procedure

1. Have a CF card to which the screen data is loaded using the V-SFT-5 editor (for the loading procedure, refer to the V8 Series Reference Manual).
2. Turn off the power to the V806 unit and set the DIPSW4 to the ON position. Open the CF card interface cover, and insert a CF card.

3. Turn the V806 unit on. The screen data is automatically loaded into the FLASH memory of the V806.
  - \* Be sure to set the DIPSW4 to the OFF position if the auto-uploading function is not being used.

## DU-10

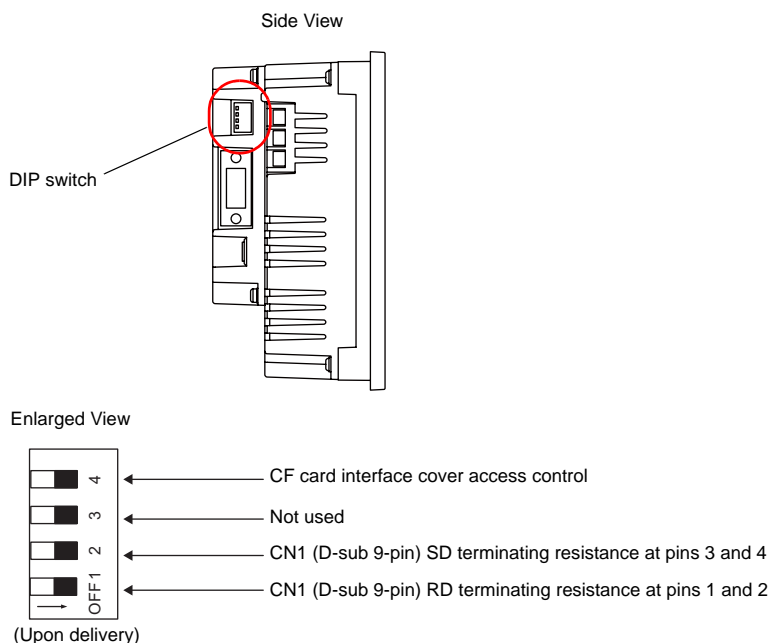

### DIPSW1, 2 (Terminating Resistance Setting)

- When connecting a controller at CN1 via RS-422/RS-485 (2-wire connection), set the DIPSW1 to the ON position.
- When connecting a controller at CN1 via RS-422/RS-485 (4-wire connection), set the DIPSW1 and 2 to the ON position.

### DIPSW3 (Not Used)

Set the DIPSW3 to the OFF position.

### DIPSW4 (CF Card Interface Cover Access Control)



When the DIPSW4 is set to the ON position, access to the CF card is possible whether the cover is opened or not. In the case where access to the CF card is disabled because of damage to the CF card interface cover, set the DIPSW4 to the ON position. Normally keep it in the OFF position.

With the DIPSW4, the LED status when the CF card interface cover is opened can be set.

DIPSW4	LED	Contents
OFF	Not lit	The power is not supplied to the CF card. The CF card can be removed.
	Lights up in red	The power is supplied to the CF card. At the completion of access, the LED goes off.
ON	Lights up in red	Access to the CF card is possible at all times.

## 3. Function Switches

### Types

There are six function switches provided.  
[SYSTEM], [F1], [F2], [F3], [F4], [F5]

### Function of Switches

#### [SYSTEM] Switch

The [SYSTEM] switch works in “alternate” operations.

When the [SYSTEM] switch is pressed once, the switch menu is displayed at the left side of the function switches [F1] to [F5] as shown in the figure below. Each function switch corresponds to the item displayed in the switch menu.

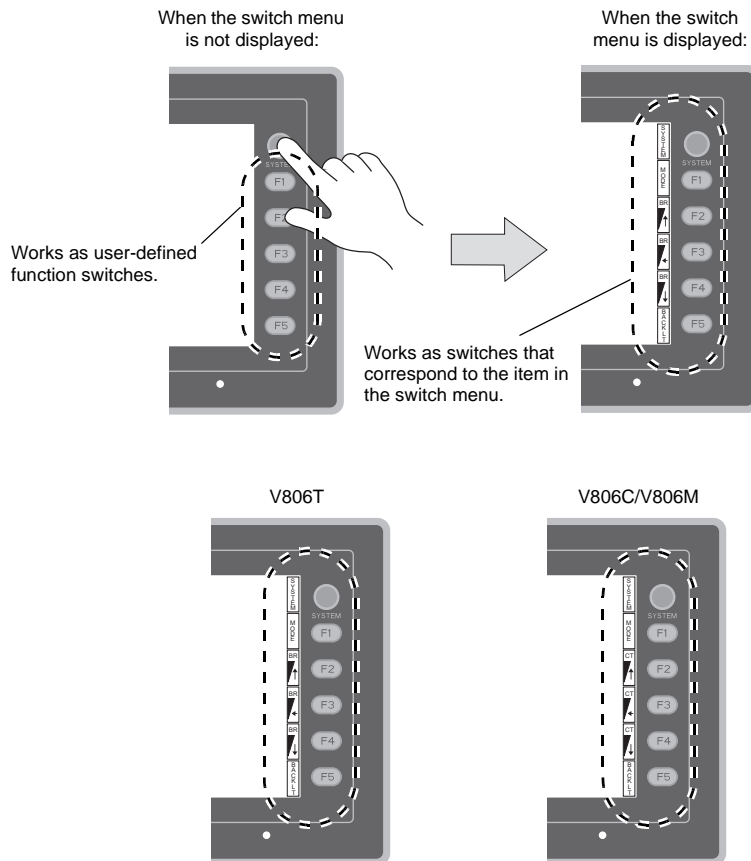

\* If the switch menu is not displayed with the [SYSTEM] switch pressed, the [SYSTEM] switch is disabled. To enable the [SYSTEM] switch, keep pressing the [F5] switch for the time specified for [Change-over Time] (max. 30 seconds) with the [SYSTEM] switch held down. [Change-over Time] is set on the editor.

## [F1] to [F5] Switch Functions with Switch Menu Displayed

	Functions	Specifications	
F1	Mode selection	Selects the operation mode between STOP ↔ RUN.* <sup>3</sup>	
F2	Brightness* <sup>2</sup>	Bright	
F3* <sup>1</sup>		Medium	
F4* <sup>1</sup>		Dark	
F5	Backlight control* <sup>4</sup>	Always ON	-
		Auto 1 Auto 2 Auto 3	<ul style="list-style-type: none"> <li>The [F5] switch turns the backlight off.</li> <li>This is valid when the backlight control bit (bit 11) in the read area "n + 1" in the system memory is reset (OFF: 0).</li> </ul>
		Manual Manual 2	<ul style="list-style-type: none"> <li>Manual The [F5] switch turns the backlight off. To turn it on, press somewhere on the screen or a function switch.</li> <li>Manual 2 The [F5] switch turns the backlight on and off.</li> <li>[Backlight Power ON Time Control] that determines the backlight status at power-up becomes valid. When the power is turned on: ON → Backlight ON OFF → Backlight OFF</li> </ul>

\*1 When a medium or dark brightness is set, the backlight service life may become shorter.

\*2 In the case of the hardware version "r" or later, the brightness of the V806C/M can be adjusted. When the hardware version is "a" to "q", the contrast of the V806C/M can be adjusted.

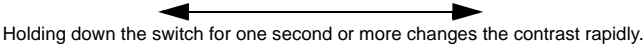
		Adjust the contrast.		
F2 F3 F4	Contrast	F2 Dark	F3 Medium	F4 Pale
				

\*3 If the mode cannot be changed between STOP and RUN using the [MODE] switch, the [F1] (MODE) switch is disabled. To enable the [F1] (MODE) switch, keep pressing the [F5] switch for the time specified for [Change-over Time] (max. 30 seconds) with the [F1] switch held down. [Change-over Time] is set on the editor.

\*4 The backlight can be controlled by the setting in the [Backlight] tab window that is displayed by selecting [System Setting] → [Unit Setting] → [Backlight] on the V-SFT-5 editor.

## User-defined Settings for Function Switches [F1] to [F5]

When the V806 series is in the RUN mode and the switch menu by the [SYSTEM] switch is not displayed\*<sup>1</sup>, the function switches can be defined by the user.

User-defined function switches should be set on the V-SFT-5 editor.

- Settings for each screen  
[Screen Setting] → [Local Function Switch Setting] → [Local Function Switch Setting] dialog
- Setting for all screens\*<sup>2</sup>  
[System Setting] → [Global Function Switch Setting] → [Global Function Switch Setting] dialog

\*1 If the switch menu is not displayed by the [SYSTEM] switch on the Main Menu screen, no function is specified for each function switch.

\*2 If [Local Function Switch Setting] has been made for the screen being displayed now, the setting takes a higher priority than [Global Function Switch Setting].

# 5 MONITOUCH Operations

---

1. Before Operation
2. Main Menu Screen



# 1. Before Operation

## Procedure before Operation

1. Mount the V806 series on the mounting panel, install it and carry out wiring.  
For more information, refer to “Chapter 3”.
2. Install peripheral devices, such as PLCs or temperature controllers, and carry out wiring.  
For information on precautions, refer to the V8 Series Connection Manual separately provided.
3. Turn the power of the V806 series on.

When turning the power on for the first time:



Other cases:

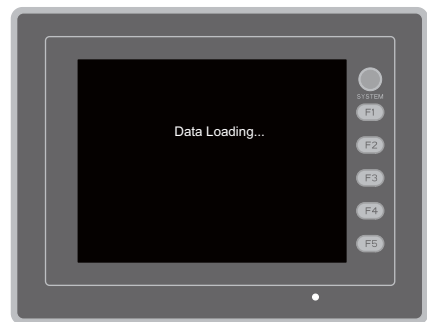

4. Transfer the created screen data.
  - When turning the power on for the first time:  
For details, refer to “Transferring Screen Data to MONITOUCH for the First Time” (page 5-2).
  - Other cases:  
For the procedure to change screen data with another, refer to the V8 Series Operation Manual.

5. Start MONITOUCH operation. To change to the RUN mode, refer to “Main Menu Screen” (page 5-3).

When the connection with controllers has been established, the RUN screen is displayed.

\* If MONITOUCH does not operate normally and shows an error message, eliminate the cause by referring to “Chapter 6” or the V8 Series Reference Manual.

## Transferring Screen Data to MONITOUCH for the First Time

There are five methods for transferring screen data for the first time.

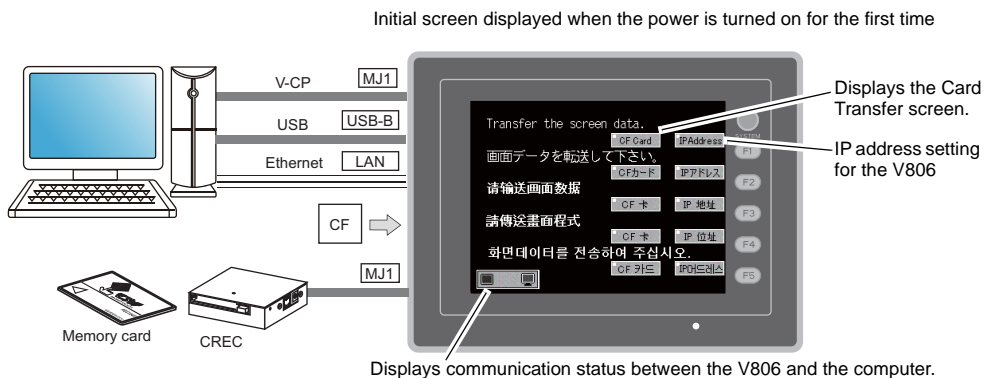

- 1) Serial transfer  
Connect the screen data transfer cable "V-CP" to the modular jack 1 on the V806 series, and transfer screen data from the computer.
- 2) Transfer via USB  
Connect the USB cable to the USB slave port (USB-B) on the V806 series, and transfer screen data from the computer.
- 3) Transfer using a card  
A CF card or card recorder "CREC" (optional) and memory card are required.  
Load screen data from the computer to the card in advance.  
Press the [CF Card] switch on the initial screen. The Card Transfer screen is displayed and data transfer is enabled.
- 4) Transfer using a CF card (auto-loading)  
Load screen data from the computer to the card in advance. When the power of MONITOUCH is turned on, screen data transfer is automatically started.
- 5) Transfer via Ethernet  
Connect an Ethernet cable to the LAN port on the V806i, and transfer screen data from the computer.  
Pressing the [IP Address] switch on the initial screen brings up the Ethernet screen on which you can set the IP address for the V806i.  
\* The V806 series needs the additional optional communication unit, "CU-03-3".



When the screen data has been transferred, the following screen is brought up. For details, refer to "Main Menu Screen" (page 5-3).

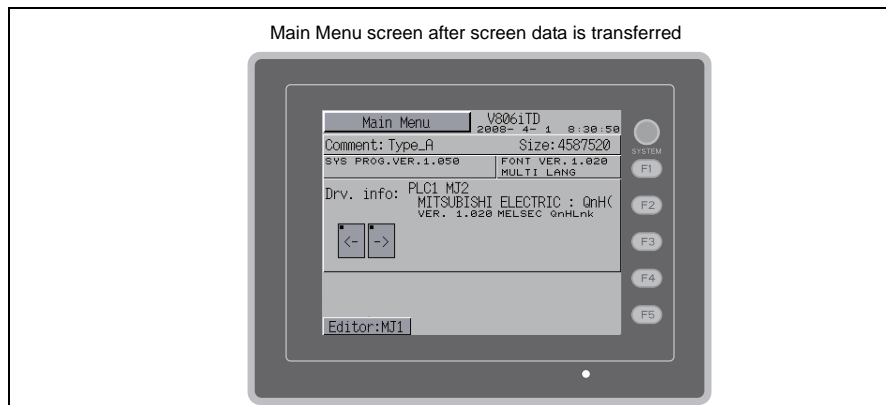

## 2. Main Menu Screen

### Displaying the Main Menu Screen

To bring up the Main Menu screen in the RUN mode, press the [SYSTEM] switch and then the [F1] switch (\*2) while the switch menu is displayed (\*1).

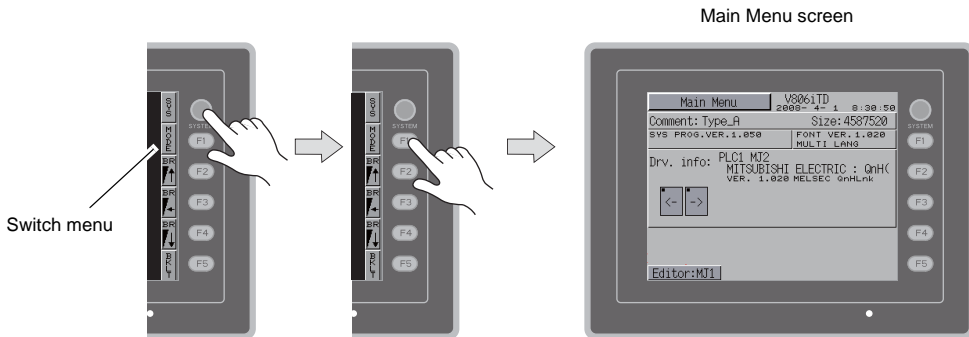

- \*1 If the switch menu is not displayed with the [SYSTEM] switch pressed, the [SYSTEM] switch is disabled. To enable the [SYSTEM] switch, keep pressing the [F7] switch for the time specified for [Change-over Time] (max. 30 seconds) with the [SYSTEM] switch held down. [Change-over Time] is set on the editor.
- \*2 If the Main Menu screen is not brought up with the [F1] switch pressed, the [F1] (= [MODE]) switch is disabled. To enable the [F1] (= [MODE]) switch, keep pressing the [F5] switch for the time specified for [Change-over Time] (max. 30 seconds) with the [F1] switch held down. [Change-over Time] is set on the editor.

### Main Menu Screen

The Main Menu screen indicates the V806 series model, system information, and screen data information.

Also, it works as the system screen when the screen data is transferred between a computer and the V806 series. To transfer screen data from the computer to the V806 series through serial communication, display this Main Menu screen. (However, if [No Connected] is selected for [Modular Jack 1], it is not necessary to bring up the this screen.)

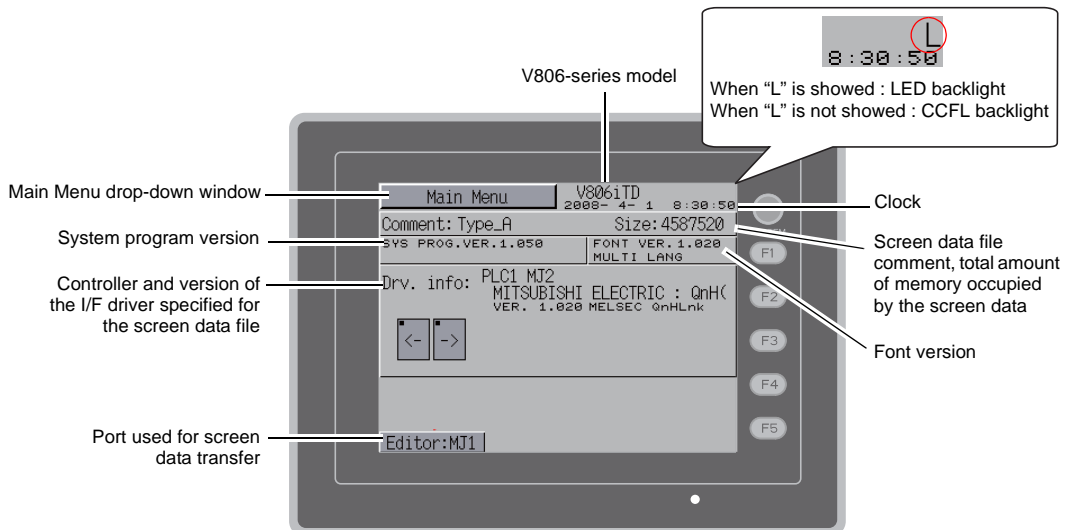

## [Main Menu] Switch

Pressing the [Main Menu] switch brings up the following drop-down window.

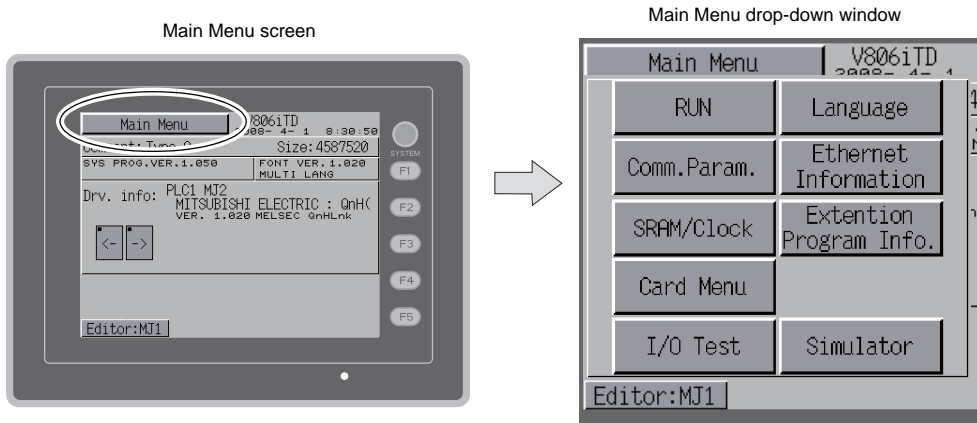

## Main Menu Screen Composition

The Main Menu screen is configured as shown below:

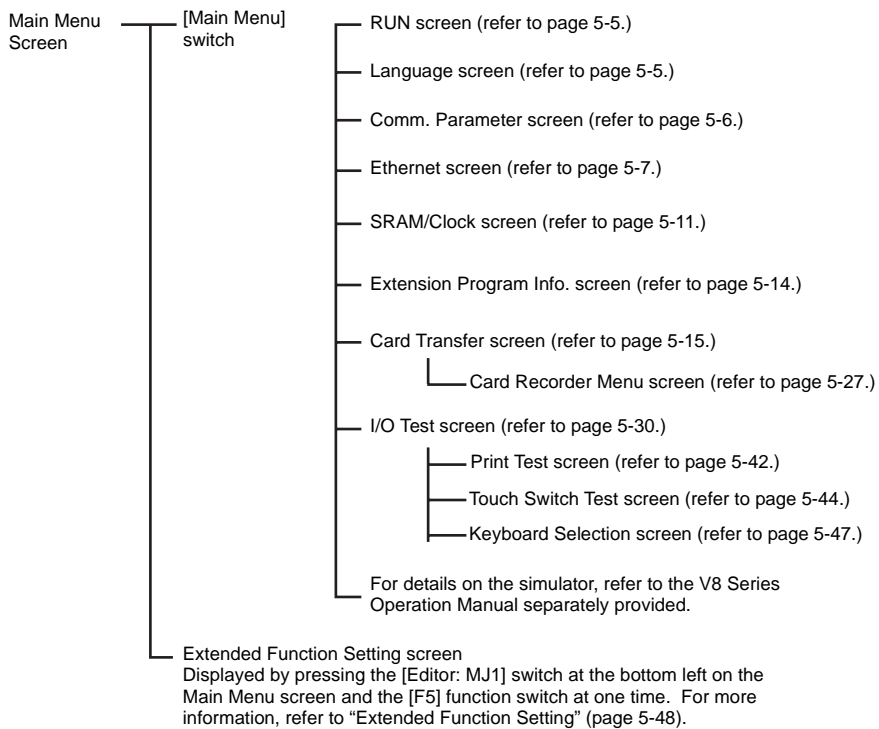

## 1. RUN

Pressing the [RUN] switch on the Main Menu drop-down window switches the screen to the RUN mode.

Main Menu drop-down window

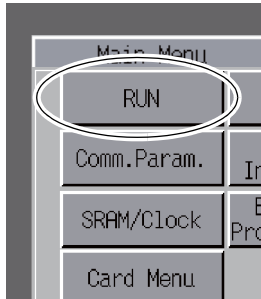

RUN screen



## 2. Language Selection

Pressing the [Language] switch on the Main Menu drop-down window brings up the Language Selection screen.

Languages (\*) selected in the [Font Setting] dialog of the V-SFT-5 editor are displayed on the Language Selection screen that is used for selecting an interface language for the Main Menu screen.

Main Menu drop-down window

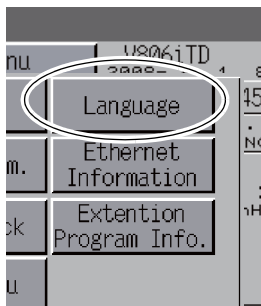

Language Selection screen

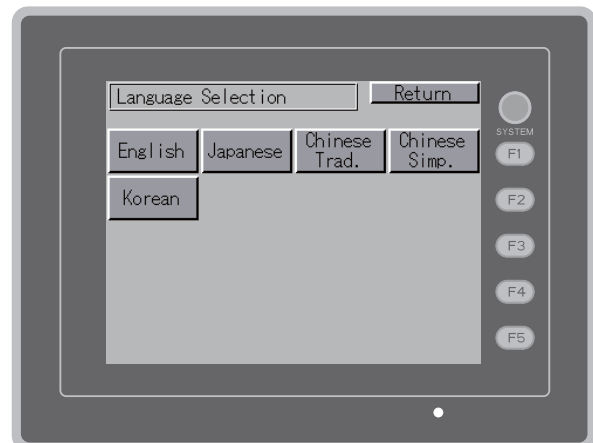

\* The interface language for the Main Menu screen can be selected from English, Japanese, Chinese (simplified), Chinese (traditional) or Korean. English is always displayed.

### 3. Communication Parameter

Pressing the [Comm. Param.] switch on the Main Menu drop-down window brings up the Comm. Param. screen.

Communication parameters of PLC1 to PLC8 that are set on the V-SFT-5 editor can be checked on this screen.

Main Menu drop-down window

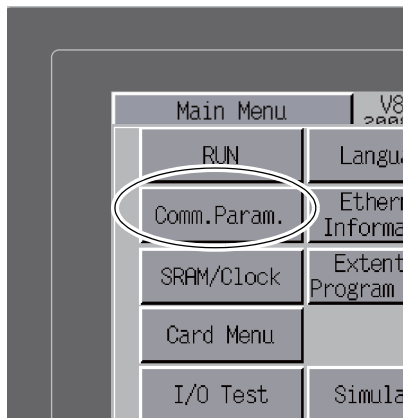

Comm. Param. screen

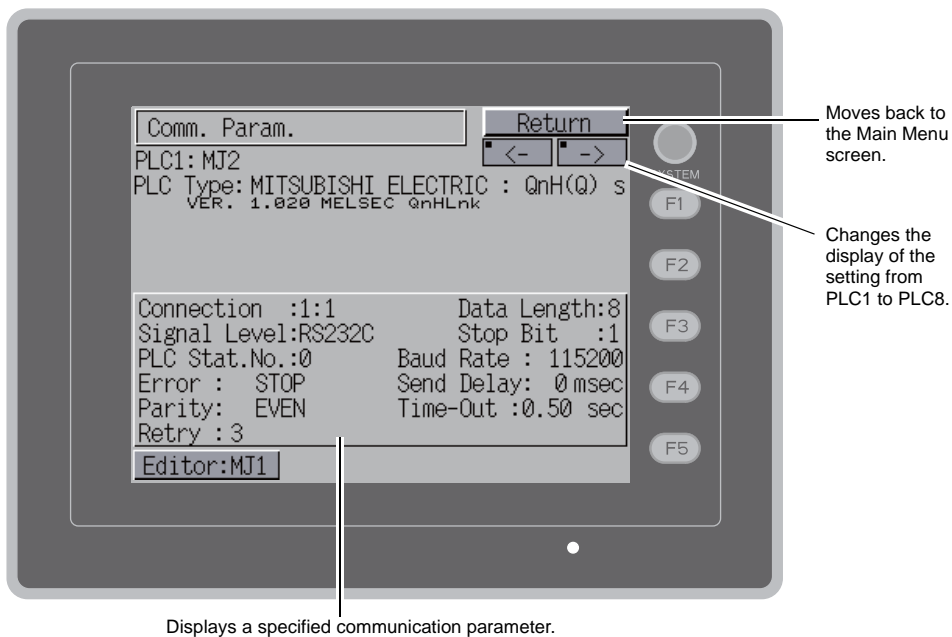

## 4. Ethernet

Pressing the [Ethernet Information] switch on the Main Menu drop-down window brings up the Ethernet Information screen.

This screen allows you to check the information about the Ethernet or set an IP address for the V806 series.

\* The communication unit, "CU-03-3" is additionally required to make the Ethernet available on the V806.

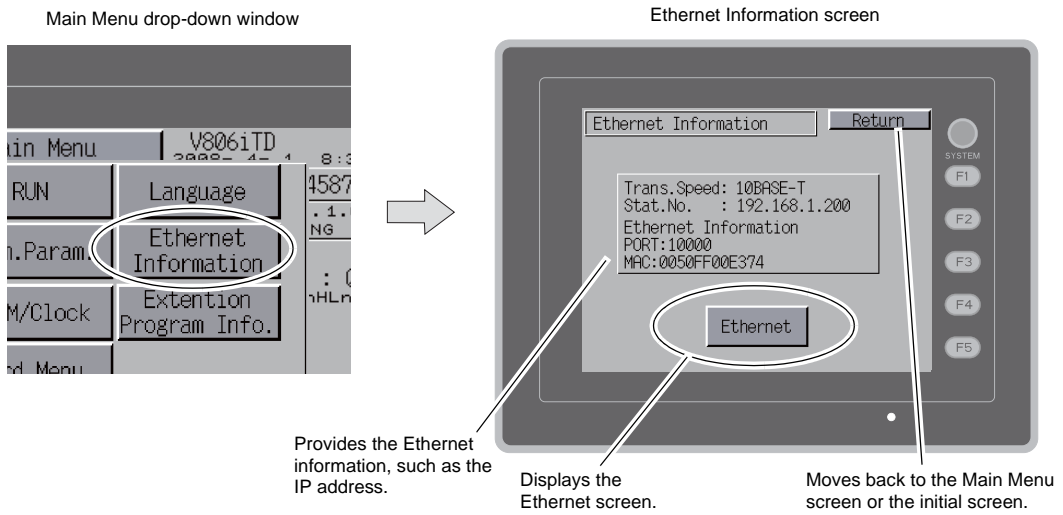

Pressing the [Ethernet] switch on the Ethernet Information screen displays the following screen, on which you can set an IP address for the V806.

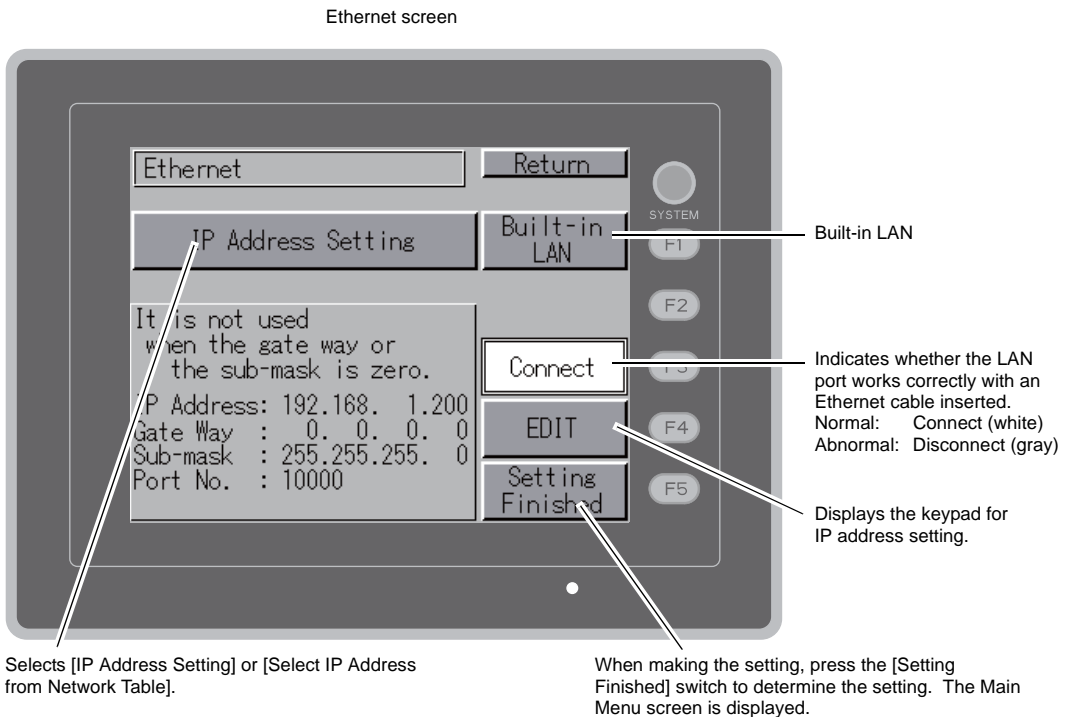

\* Refer to the V8 Series Connection Manual.

## 4-1. IP Address Setting of the V806 Series

When using Ethernet communications, you need to set the IP address of the V806 series. Set the IP address either on the V806 unit or for screen data using the V-SFT editor.

### Setting on the V806 Series

1. Press the [Ethernet Information] switch on the Main Menu drop-down window and press the [Ethernet] switch on the Ethernet Information screen. The Ethernet screen is displayed.
2. Press the [EDIT] switch and set each item.

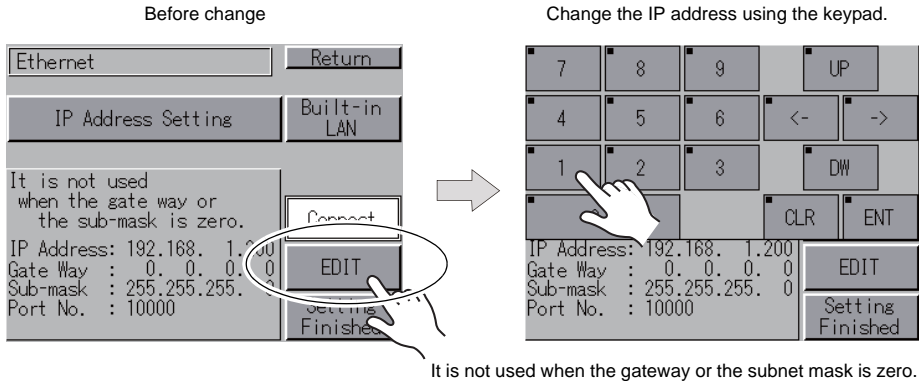

3. Press the [Setting Finished] switch to determine the IP address. Check the set IP address on the Ethernet Information screen.

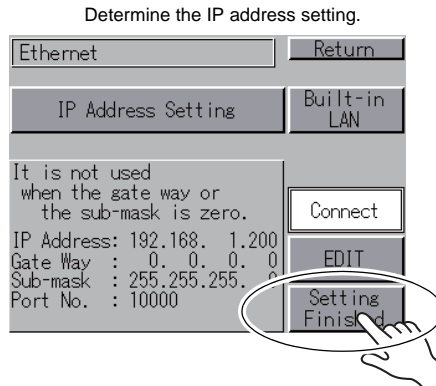



## Setting using the V-SFT editor

1. Select [System Setting] → [Ethernet Communication] → [Local Port IP Address] on the V-SFT editor. The [IP Address Setting] dialog is displayed.
2. Check the  Set IP] check box and set each item.

<input type="checkbox"/> Select IP Address from Network Table	This is valid when the IP address of the V806 has been registered in the network table. Select a network table number from 0 to 99 to set the IP address.
IP Address *	Set the IP address for the V806.
<input type="checkbox"/> Default Gateway *	Set the default gateway.
<input type="checkbox"/> Subnet Mask *	Set the subnet mask. When this box is not checked, the subnet mask is automatically assigned based on the bits at the extreme left of the IP address. Example: When IP address is "172.16.200.185", "255.255.0.0" is set. When IP address is "192.168.1.185", "255.255.255.0" is set.
<input type="checkbox"/> Port No. *	Set a port number from 1024 to 65535 other than 8001.
Send Timeout	Specify the timeout time to send the EREAD/EWRITE command.
Retrials	0 to 255 Set the number of retrials to be performed when a time-out occurs.
Memory Protect <input type="checkbox"/> Internal Memory <input type="checkbox"/> Memory Card Memory	Check either check box to write-protect the memory from computers or other stations.

\* For more information on setting items, refer to page 5-10.

3. Click [OK].
4. Transfer the screen data to the V806 series. Press the [Ethernet Information] switch on the Main Menu screen and check the IP address on the Ethernet Information screen.

IP Address				
This is an address that is used for recognizing each node on the Ethernet and should be unique. The IP address is 32-bit data which consists of the network address and the host address and can be classified into A to C depending on the network size.				
Class A	<table border="1"> <tr> <td>0</td> <td>Network address (7)</td> <td>Host address (24)</td> </tr> </table>	0	Network address (7)	Host address (24)
0	Network address (7)	Host address (24)		
Class B	<table border="1"> <tr> <td>10</td> <td>Network address (14)</td> <td>Host address (16)</td> </tr> </table>	10	Network address (14)	Host address (16)
10	Network address (14)	Host address (16)		
Class C	<table border="1"> <tr> <td>110</td> <td>Network address (14)</td> <td>Host address (8)</td> </tr> </table>	110	Network address (14)	Host address (8)
110	Network address (14)	Host address (8)		
<p>&lt;Notation&gt;            A string of 32-bit data is divided into four, and each segment delimited with a period is in decimal notation.            Example: The IP address in class C shown below is represented as "192.128.1.50".            11000000 10000000 00000001 00110010</p> <p>&lt;Unusable IP addresses&gt;</p> <ul style="list-style-type: none"> <li>• "0" is specified for one byte at the extreme left. Example: 0.x.x.x</li> <li>• "127" is specified for one byte at the extreme left (loop back address). Example: 127.x.x.x</li> <li>• "224" or more is specified for one byte at the extreme left (for multi-cast or experiment). Example: 224.x.x.x</li> <li>• The host address consists of only "0" or "255" (broadcast address). Example: 128.0.255.255, 192.168.1.0</li> </ul>				

Port No.
Multiple applications are running on each node, and communications are carried out for each application between the nodes. Consequently, it is necessary to have a means to identify the application that data should be transferred to. The port number works as this identifier. Each port number is 16-bit data (from 0 to 65535). The V806 series uses the port for screen data transfer (8001), PLC communication (as desired), and the simulator (8020). Set a unique number in the range of 1024 to 65535. For a PLC or a computer, set the port number in the range of 256 to 65535. It is recommended to set a greater number.

Default Gateway
A gateway and a router are used for communication between different networks. The IP address of the gateway (router) should be set to communicate with the node(s) on other network.

Subnet Mask													
A subnet mask is used for dividing one network address into multiple networks (subnet). The subnet is assigned by specifying a part of the host address in the IP address as a subnet address.													
Class B	<table border="1"> <tr> <td>10</td> <td>Network address (14)</td> <td>Host address (16)</td> </tr> </table>	10	Network address (14)	Host address (16)									
10	Network address (14)	Host address (16)											
Subnet mask	<table border="1"> <tr> <td>255.</td> <td>255.</td> <td>255.</td> <td>0</td> </tr> <tr> <td>11111111</td> <td>11111111</td> <td>11111111</td> <td>00000000</td> </tr> <tr> <td>Network address</td> <td>Subnet address</td> <td>Host address</td> <td></td> </tr> </table>	255.	255.	255.	0	11111111	11111111	11111111	00000000	Network address	Subnet address	Host address	
255.	255.	255.	0										
11111111	11111111	11111111	00000000										
Network address	Subnet address	Host address											
<p>&lt;Unusable subnet masks&gt;</p> <ul style="list-style-type: none"> <li>• All bits are set to "0". (0.0.0.0)</li> <li>• All bits are set to "1". (255.255.255.255)</li> </ul>													

## 5. SRAM/Clock

Pressing the [SRAM/Clock] switch on the Main Menu drop-down window brings up the SRAM/Clock screen.

This screen is used for correcting the built-in calendar (date and time), for formatting the SRAM area, and for clearing learning/user phrase area in the Japanese FEP function.

Main Menu drop-down window

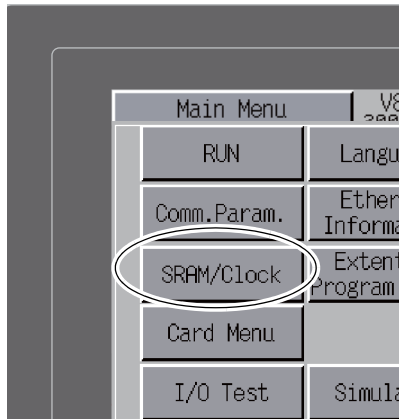

SRAM/Clock screen

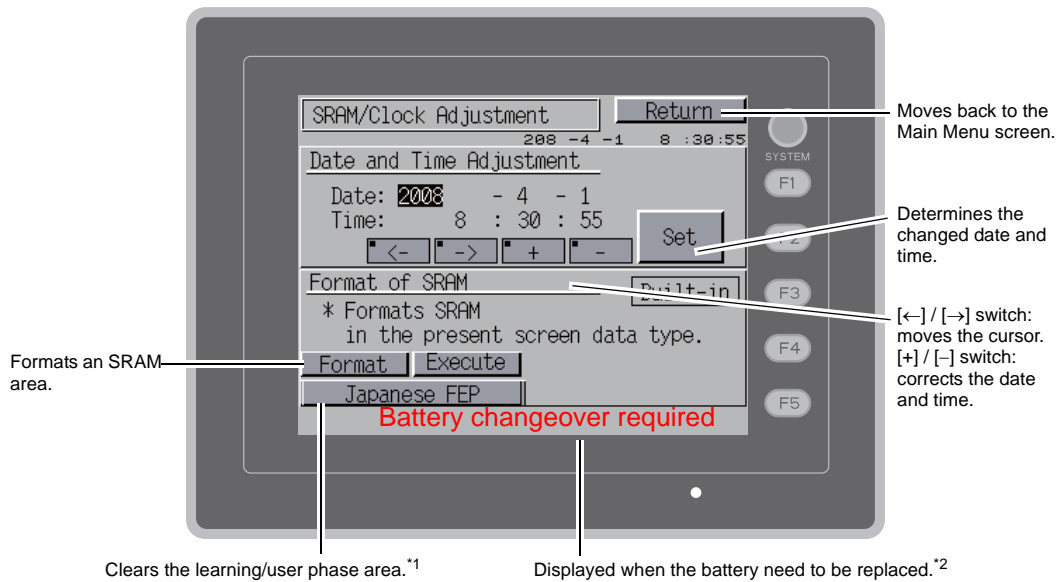

\*1 This option is displayed when [Use Japanese Conversion Function] in the [System Setting] menu is checked on the V-SFT-5 editor. For the setting procedure, refer to the V8 Series Reference Manual.

\*2 Be sure to set the battery. Without the battery, the contents in the SRAM or clock data will not be retained.

## 5-1. Date and Time Adjustment

This screen is used for correcting the built-in clock of the V806 series.

To use the built-in clock of the V806 series, check [Use Built-in Clock] in the [SRAM/Clock Setting] dialog that is displayed by selecting [System Setting] → [Unit Setting] → [SRAM/Clock] on the V-SFT-5 editor.

1. Move the cursor using the [←] and [→] switches. Correct the date and time using the [+] and [-] switches.
2. Press the [Set] switch to determine the setting. The clock displayed at the top right is modified.

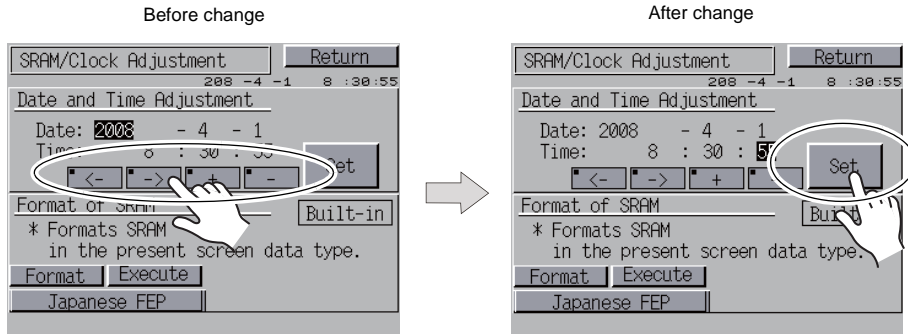

3. Pressing the [Return] switch displays the Main Menu screen again.

## 5-2. Formatting SRAM

An SRAM area can be formatted.

When the SRAM area is formatted, the contained data (historical data saved in SRAM, internal memory \$L, etc.) is cleared. Double-check before formatting the SRAM.

1. Press the [Format] switch and the [Execute] switch.  
The SRAM area is formatted in the current screen data format. When formatting has been completed, the message "\*\*Format Completed\*\*" is displayed.

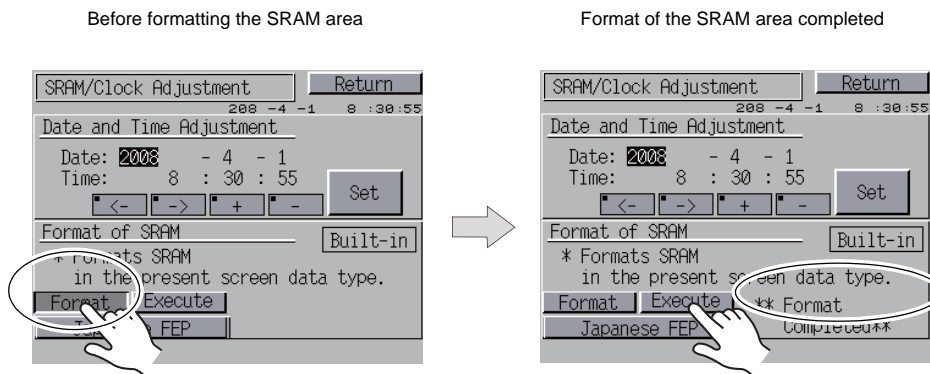

2. Pressing the [Return] switch displays the Main Menu screen again.

### 5-3. Japanese FEP Function Learning/User Phrase Area

The area used by the Japanese FEP function can be cleared.

When the learning/user phrase area is cleared, all of the registered data is deleted. Double-check before clearing the area.

1. Press the [Japanese FEP] switch.

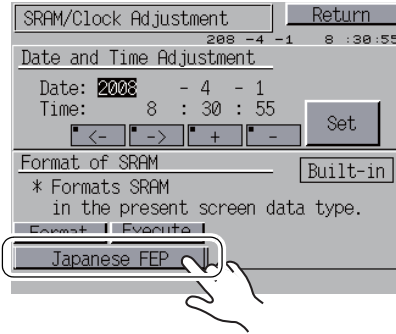

2. The [Japanese FEP Function Learning/User Phrase Area] window is displayed. Press the [Clear] switch and the [Execute] switch. When the area has been completely cleared, the message "\*\*Clear Completed\*\*" is displayed.

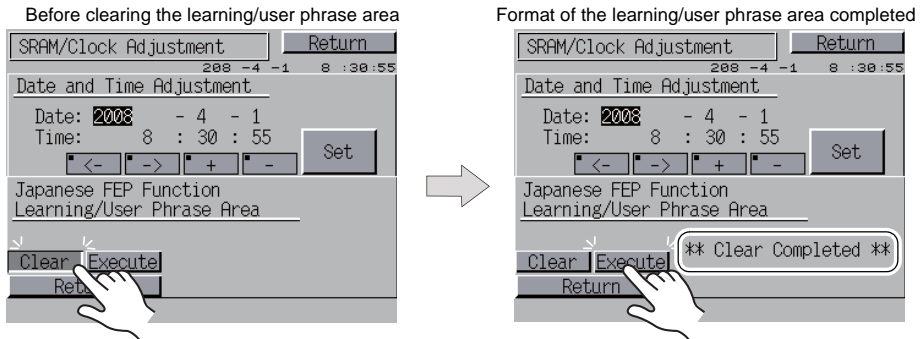

3. Pressing the [Return] switch displays the Main Menu screen again.

## 6. Extension Program Information

Pressing the [Extension Program Info.] switch on the Main Menu drop-down window brings up the Extension Program Info. screen. This screen is used for checking program versions of the ladder transfer function, printer, simulator, etc.

Main Menu drop-down window

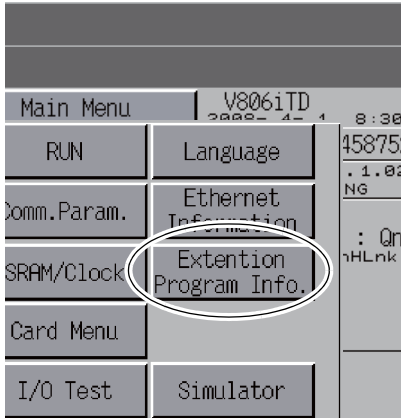

Extension Program Info. screen

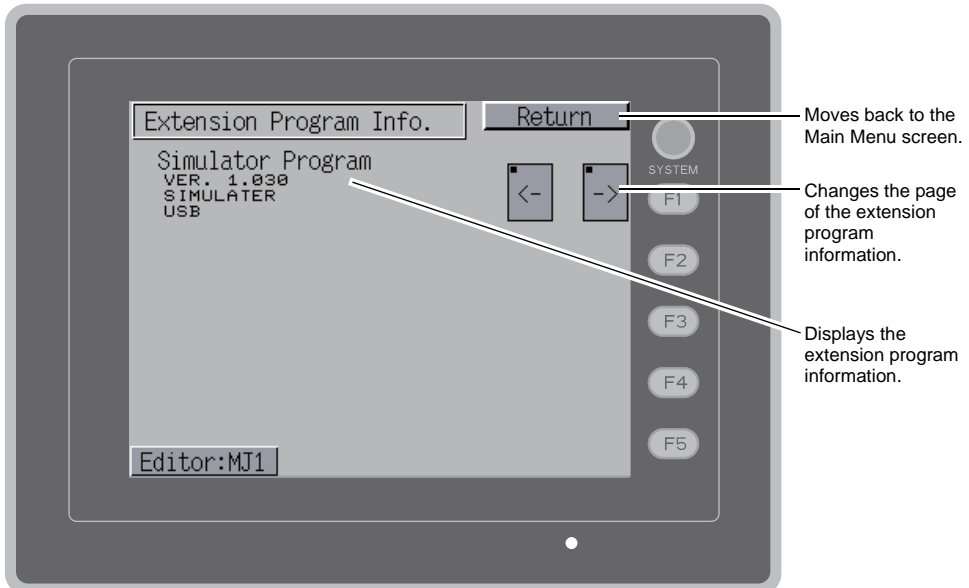

## 7. Card Transfer

Pressing the [Card Menu] switch on the Main Menu drop-down window brings up the Card Transfer screen.

This screen is used to transfer screen data between the V806 unit and a CF card or a memory card.

Main Menu drop-down window

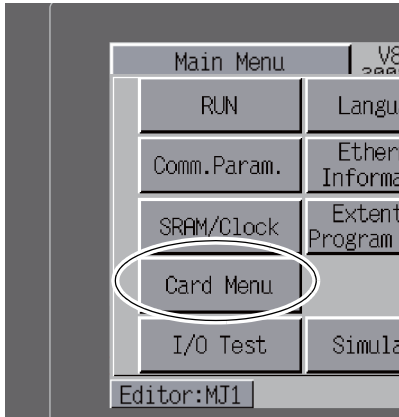

Card Transfer screen

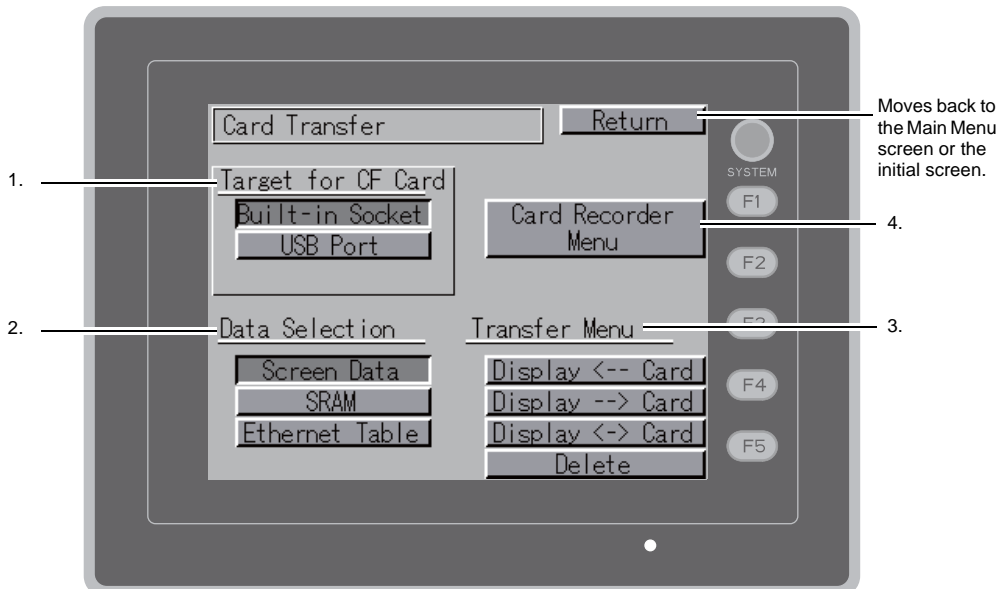

1. [Target for CF Card] field

- [Built-in Socket]

If the optional unit, "DU-10", is installed and you wish to transfer data via the connector for CF card, press this switch.

- [USB Port]

If you wish to perform a data transfer with a USB-CFREC (optional) or a USB memory connected to the USB-A (master) port of the V806, press this switch.

2. [Data Selection] field
  - [Screen Data]  
Press this switch when transferring screen data using a CF card.
  - [SRAM]  
Press this switch when saving backup data in the SRAM memory or when uploading the backup data from the CF card to the V806 series.
3. [Transfer Menu] field
  - [Display <--- Card]  
Transfers data from a CF card to the V806 unit.
  - [Display ---> Card]  
Transfers data from the V806 unit to a CF card.
  - [Display <--> Card]  
Compares data stored in the V806 unit and that stored on the CF card.
  - [Delete]  
Deletes data on the CF card.
4. [Card Recorder Menu] switch  
Press this switch when connecting the card recorder "CREC" (optional) to the MJ port of the V806 unit and transferring screen data between the V806 unit and a memory card.  
For more information, refer to "Transferring Data to the Card Recorder" (page 5-27).



## 7-1. Folder Configuration in the CF Card

The following table shows each folder name, files in the folder, and the contents:  
For more information, refer to the V8 Series Reference Manual.

CF card

 DAT0000 (Access folder: any given name and 32 one-byte alphanumeric characters at the maximum)

Folder Name (Fixed)	Contents	File Name	Data Direction
BITMAP	Pattern (Bitmap) data	BMPxxxx.BIN	V806 ← CF
CARD	Recipe data using the V6 compatible memory manager function	MCMHEAD.BIN MCMxxxx.BIN	V806 ↔ CF
DSP	Screen data	DSP0000.BIN	V806 ↔ CF
FONT	Gothic fonts or multi-language fonts	xxxxxx.FTD	V806 ← CF
HDCOPY	Screen images (JPEG or BIN selectable for 128-color display) *1	HDxxxx.JPG HDxxxx.BIN	V806 → CF *4
JPEG	JPEG files (not supported by some models)	xxxxx.JPG JPxxxxx.JPG	V806 ← CF
LADDER	Ladder data for the ladder monitor *2		V806 ← CF
MEMO	Memo pad data	MEMxxxx.BIN	V806 → CF *5
MSG	Message file	MSGxyyyy.BIN MSGxyyyy.TXT	V806 ← CF
OPELOG	Operation log file *3	OPELOG_hhmmss.BIN	V806 ↔ CF
RECIPE	Recipe data *1	RECxxxx.CSV xxxxxxxx.CSV	V806 ↔ CF
SAMPLE	Historical data by data logging and of alarms	SMPxxxx.BIN SMPxxxx.CSV	V806 → CF *5
	Title file	SMHxxxx.CSV	V806 ← CF
SCRN	Header file	SCHEADER.BIN	V806 ← CF
	Screen fileComponent parts (macro block, sampling message)	SCxxxx.BIN MCRxxxx.BIN MSGxxxx.BIN	
	3D parts file	3Dxxxx.BIN	
	Windows font file (Graphic/message)	WFSxxxx.BIN WFMxxxx.BIN	
SNAP	Video snapshot images	VDxxxxx.JPG	V806 → CF *4 *5
SRAM	Backup data of SRAM data	SRM0000.BIN	V806 ↔ CF
WAV	WAV files for sound output	WAxxxx.WAV	V806 ← CF
WEBSERV	Files accessible from a Web browser	*.SHT, *.HTML, *.TXT, etc	V806 ← CF

\*1 Refer to the Macro Reference Manual.

\*2 Refer to the V8 Series Ladder Monitor Specifications.

\*3 Refer to the V8 Series Reference Additional Functions.

\*4 Only when using on a Web server : V806 ← CF

\*5 Only for the files created on the V806 : V806 ← CF

CF card

 DSPDEF (Folder for auto uploading screen data: fixed folder name)

Folder Name (Fixed)	Contents	File Name	Data Direction
DSP	When setting the DIP switch on the V806 and inserting a CF card, it automatically reads the screen data in this folder.	DSPDEF.BIN	V806 ← CF

(Other folders are the same as the "access folder".)

## 7-2. Transferring Screen Data

If a USB-CFREC is connected to the USB-A port of the V806 series or the optional unit, "DU-10", is connected to the V806, a CF card is usable for data transfer described in the steps below.

1. Inserting a CF card  
Insert a CF card into the USB-CFREC connected to the USB-A port or open the CF card cover of the optional unit, "DU-10", and insert a CF card.  
\* Do not remove or insert the CF card in the later steps.
2. Displaying the Card Transfer screen  
Press the [Card Menu] switch on the Main Menu drop-down window displayed from the Main Menu screen. The Card Transfer screen is displayed.
3. Selecting CF card location and data to be transferred  
Select [USB Port] or [Built-in Socket] in the [Target for CF Card] field and [Screen Data] in the [Data Selection] field.

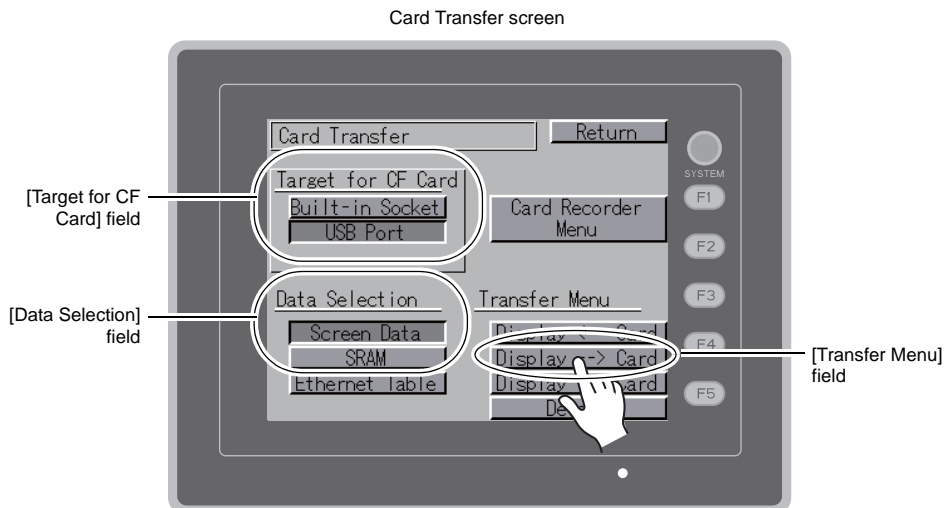

4. Transfer selection
  - For details, refer to "When [Display <-- Card] Is Selected:" (page 5-19).
  - For details, refer to "When [Display --> Card] Is Selected:" (page 5-22).
  - For details, refer to "When [Display <--> Card] Is Selected:" (page 5-23).

**When [Display ← Card] Is Selected:**

1. When [Display ← Card] is selected, the Card Transfer screen is displayed.

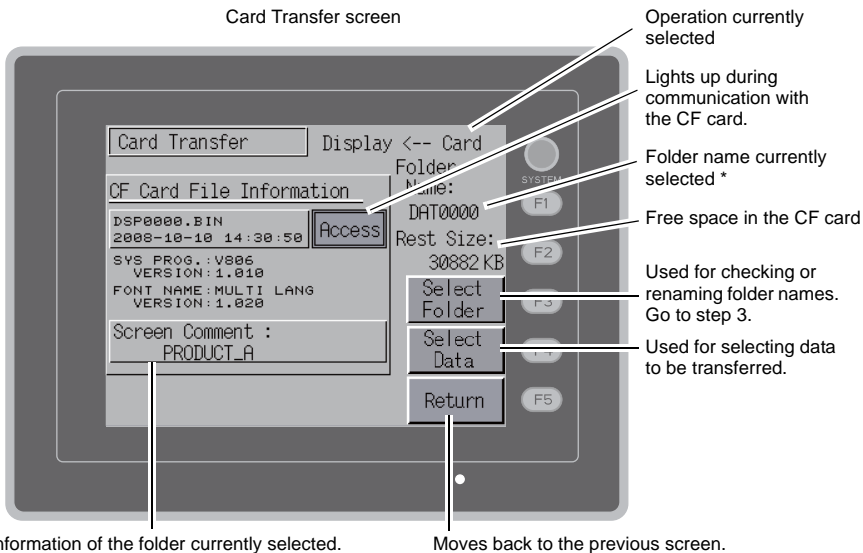

\* The access folder name that is set for screen data is displayed as default. If there is no screen data in the V806 series, "DAT0000" is displayed.

2. Check the contents of [Folder Name], [Rest Size], and [CF Card File Information]. If the correct folder is selected, go to step 4. To change the folder, go to step 3.
3. To change the access folder to another, press the [Select Folder] switch. The Select Folder screen is displayed. Select the desired folder and press the [OK] switch.

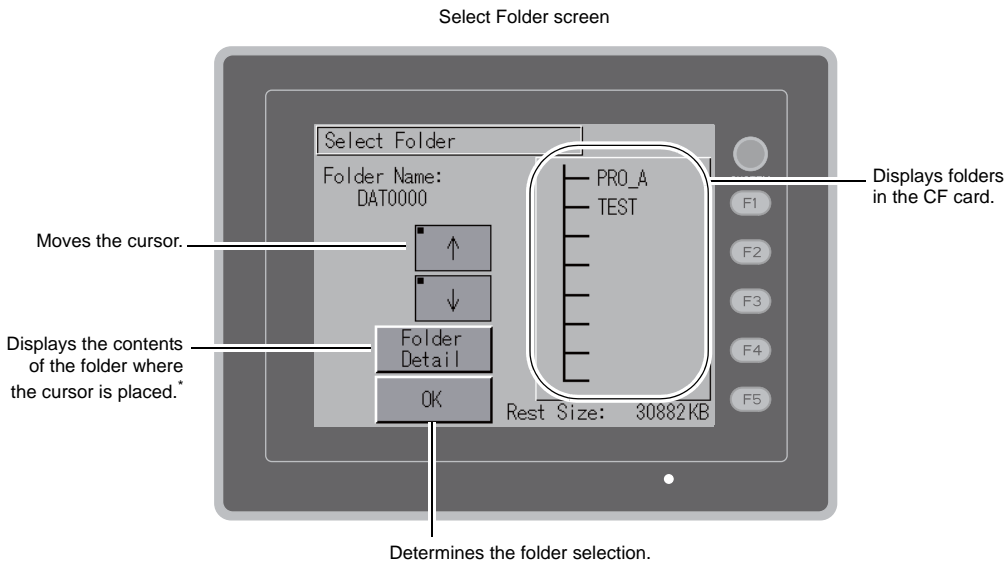

\* Pressing the [Folder Detail] switch displays the contents of the folder where the cursor is placed.

Folder Detail screen

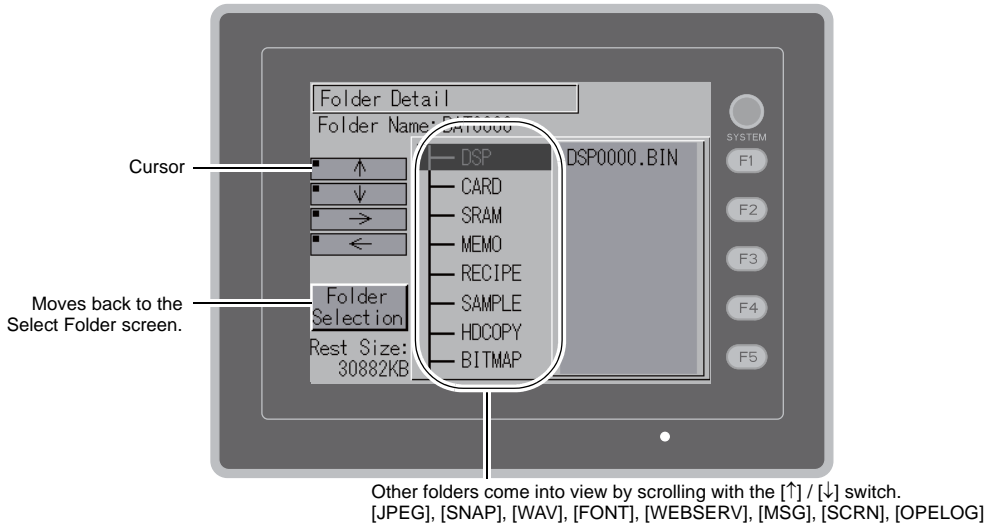

- After selecting the folder, press the [Select Data] switch.  
The [Data Selection] window is displayed, and the [Select Data] switch changes to [Start].

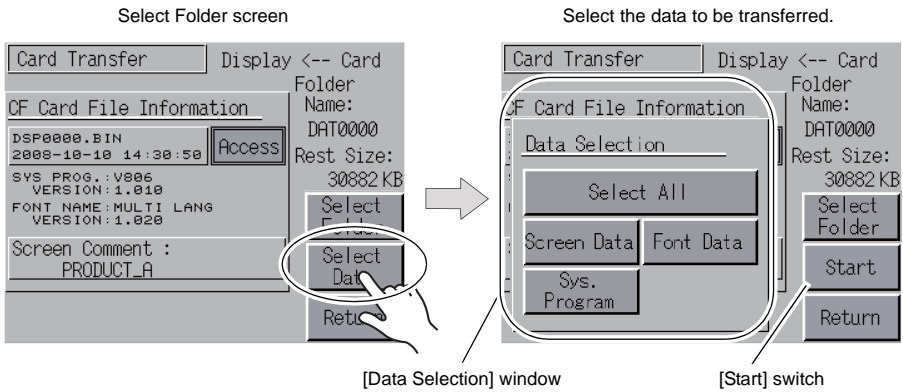

\* To cancel the [Data Selection] window, press the [Return] switch.

5. Select the desired data, and press the [Start] switch. During data transfer, the [Start] switch changes to [Transferring].

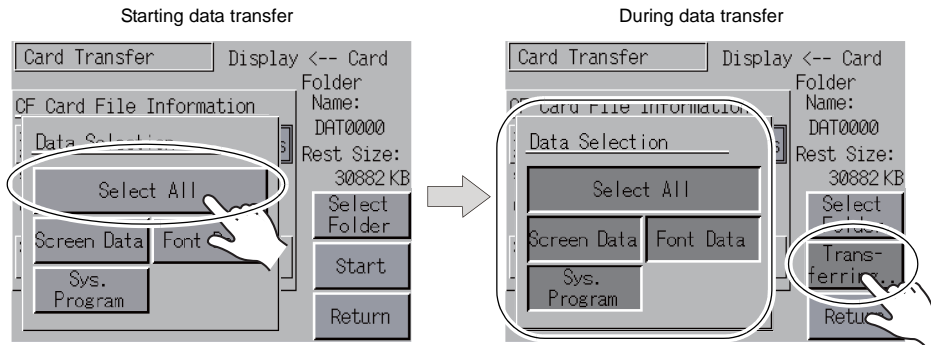

6. When the data has been transferred successfully, the following message window is displayed. Press the [OK] switch. If the [Sys. Program] or [Select All] switch was selected on the [Data Selection] window, the Main Menu screen is automatically displayed on completion of data transfer.

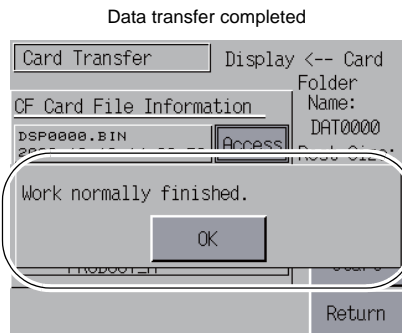

- \* If any other message is displayed, refer to "Message Window Displayed during Data Transfer (between V806 and Card)" (page 5-29).

### When [Display --> Card] Is Selected:

1. When [Display --> Card] is selected, the Card Transfer screen is displayed.

Card Transfer screen

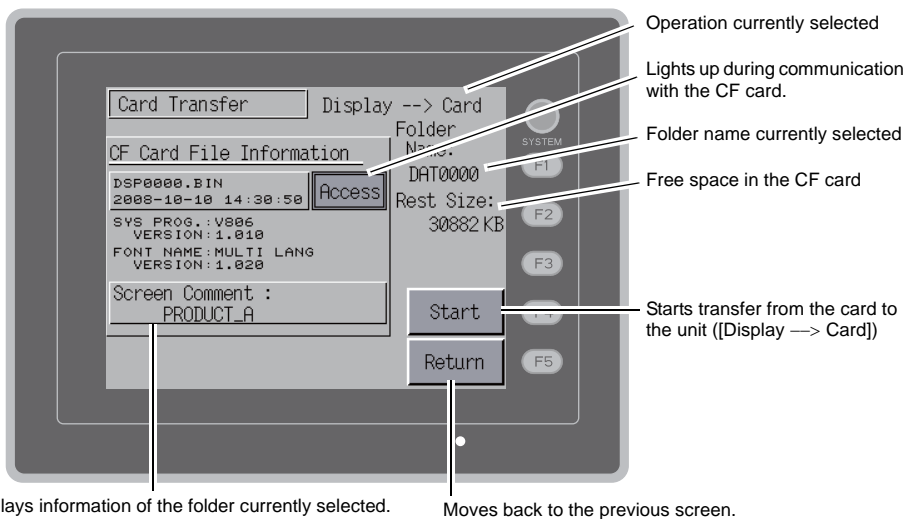

2. Check the folder name and CF card file information, and press the [Start] switch.

\* Note that data on the CF card is overwritten if the access folder name of screen data is the same as that in the CF card.

When the CF card file information is blank, a new file "DSP0000.BIN" is created in the DSP folder under the access folder.

3. During data transfer, the [Start] switch changes to [Transferring]. When data has been transferred successfully, the following message window is displayed. Press the [OK] switch.

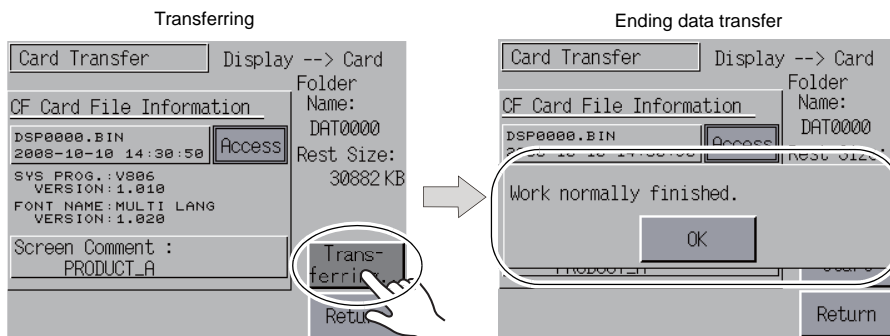

The [CF Card File Information] field shows the data that has been transferred.

\* If any other message is displayed, refer to "Message Window Displayed during Data Transfer (between V806 and Card)" (page 5-29).

**When [Display <--> Card] Is Selected:**

1. When [Display <--> Card] is selected, the Card Transfer screen is displayed.  
The screen data in the unit is compared with the one in the access folder (in the DSP folder).

Card Transfer screen

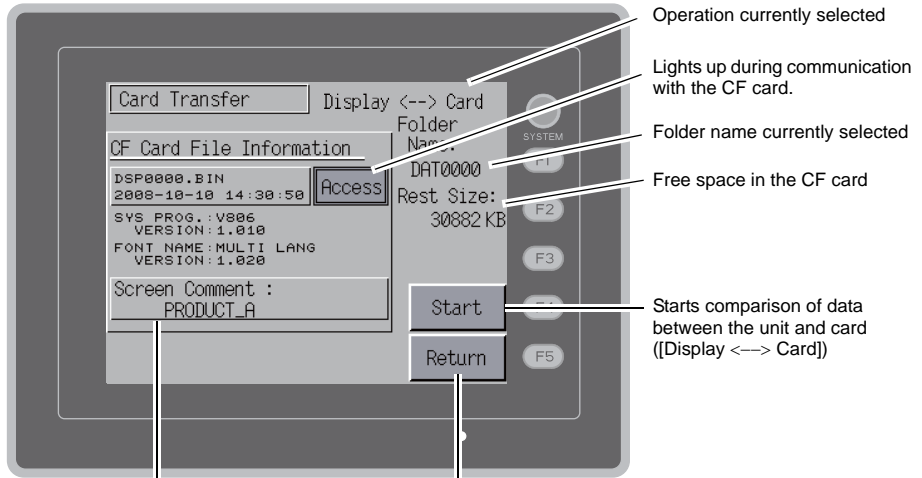

Displays information of the folder currently selected.      Moves back to the previous screen.

2. Press the [Start] switch.
3. During data comparison, the [Start] switch changes to [Transferring]. When data comparison has been completed successfully, the following message window is displayed. Press the [OK] switch.

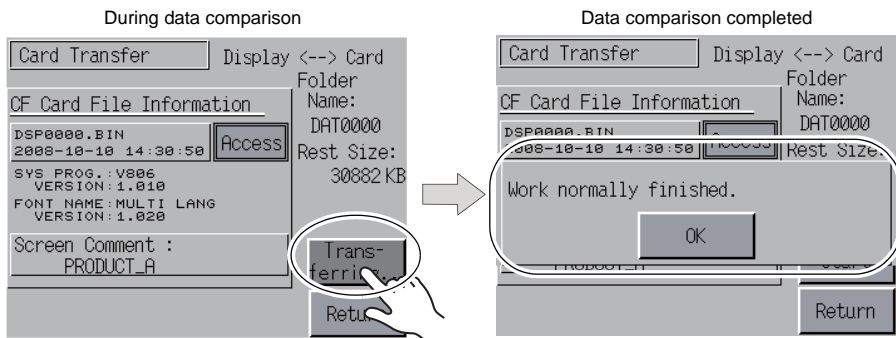

\* If any other message is displayed, refer to "Message Window Displayed during Data Transfer (between V806 and Card)" (page 5-29).

### 7-3. Saving Backup Copies of SRAM

This section explains the procedure for saving backup copies of the SRAM memory for battery replacement.

1. Press the [SRAM] switch on the Card Transfer screen. When the switch is pressed, it is selected.
2. Select [Display <-- Card], [Display --> Card] or [Display <--> Card] in the [Transfer Menu] field.

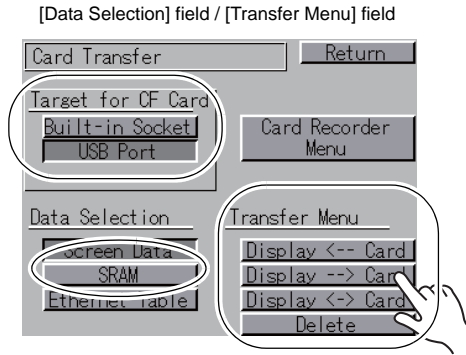

3. The SRAM Transfer screen is displayed.
  - When [Display --> Card] or [Display <--> Card] is selected:  
Select the CF card folder having the same name as the access folder for screen data in the V806 series. The name is shown on the screen.

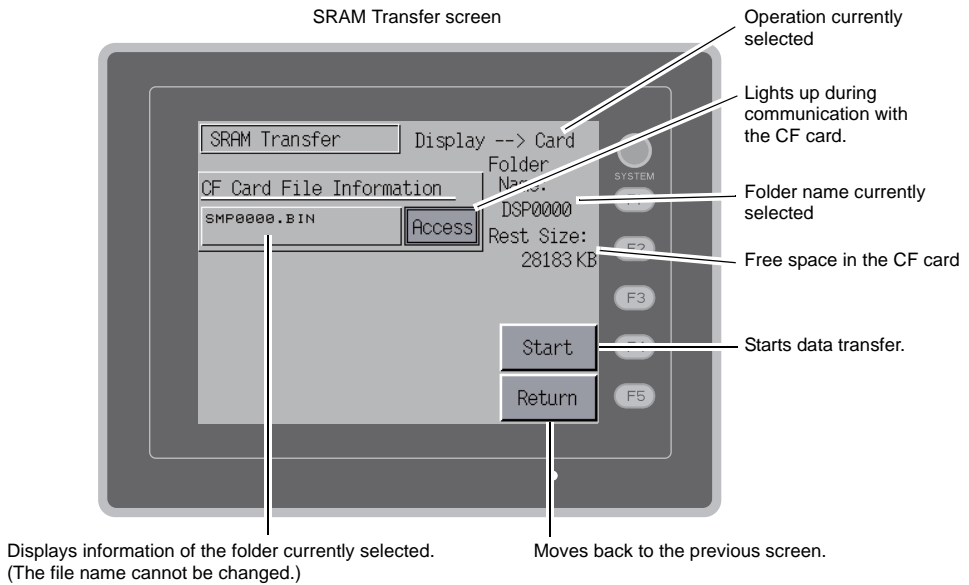



- When [Display ← Card] is selected:  
To change the access folder to another, press the [Select Folder] switch and display the Select Folder screen. For more information on the Select Folder screen, refer to step 3 described in “When [Display ← Card] Is Selected.” (page 5-19).

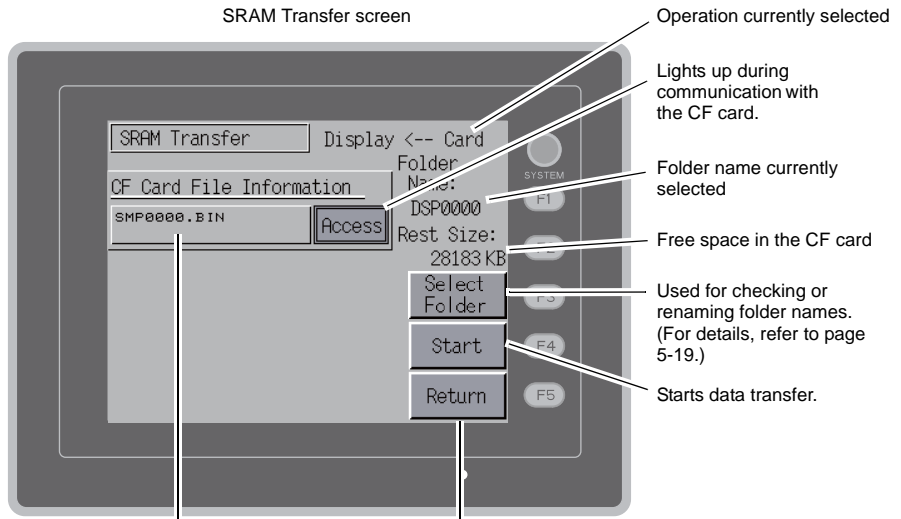

Displays information of the folder currently selected. (The file name cannot be changed.)

Moves back to the previous screen.

4. Check the folder name, free space and transfer menu, press the [Start] switch. During data transfer or comparison, the [Start] switch changes to [Transferring].

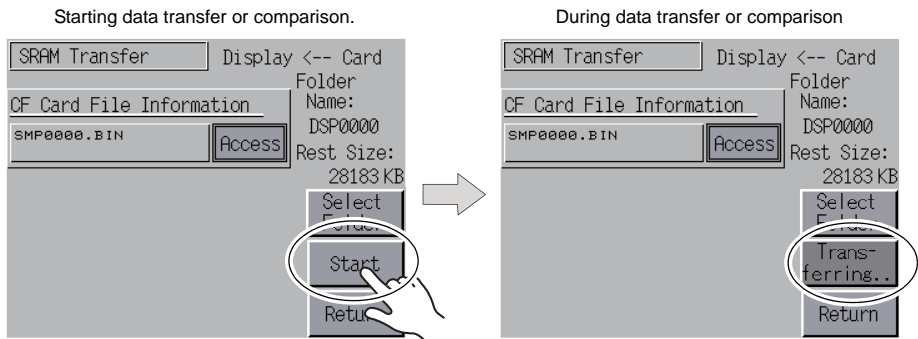

5. When data has been transferred successfully, the following message window is displayed. Press the [OK] switch.

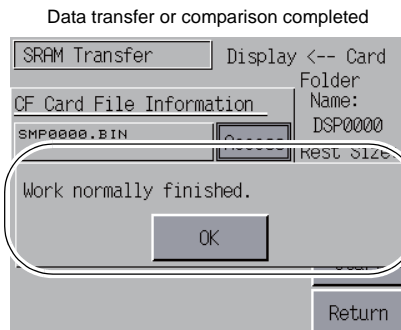

\* If any other message is displayed, refer to “Message Window Displayed during Data Transfer (between V806 and Card)” (page 5-29).

## 7-4. Deleting Data on the CF Card

Data on the CF card can be deleted. To delete the data, follow the procedures described below.

1. Selecting [Delete] in the [Transfer Menu] field displays the Delete Data in CF Card screen. To move back to the previous screen, press the [Return] switch.

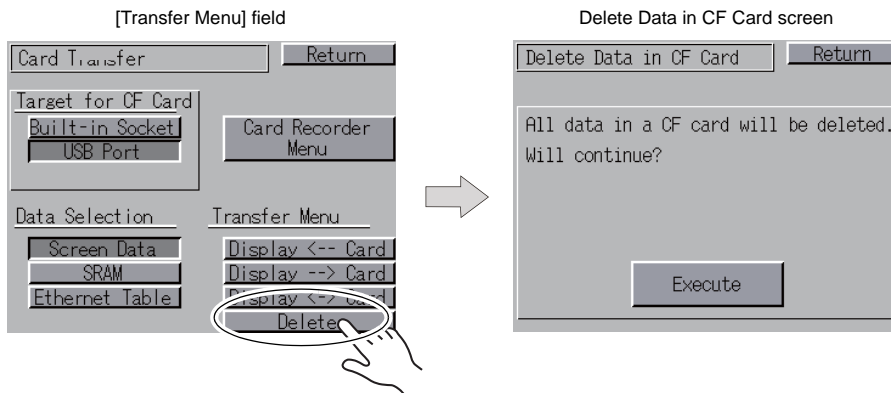

2. Press the [Execute] switch if deleting all data on the CF card. The switch is lit for a while. When the data has been completely deleted, the message "\*\*Deleting Completed\*\*" is displayed.

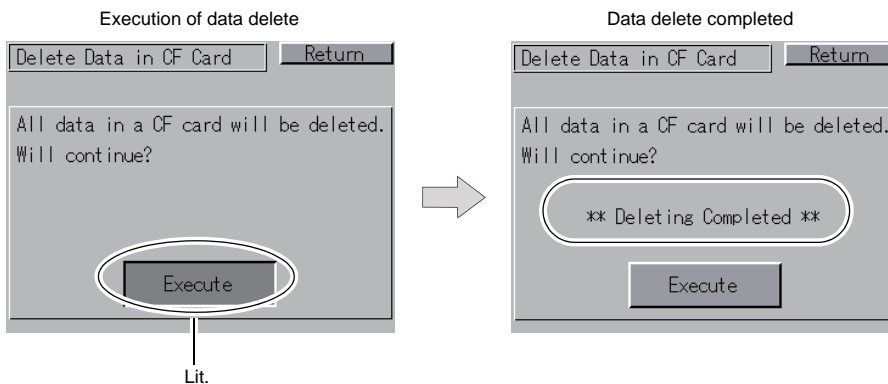

- \* The data on the CF card is completely deleted; however, when the Main Menu screen is displayed again by the [Return] switch, the access folder for the screen data that has been transferred to the V806 is automatically created.

## 7-5. Transferring Data to the Card Recorder

When the [Card Recorder Menu] switch is pressed on the Card Transfer screen, the Card Recorder Menu screen appears. This screen is used to transfer screen data between the V806 series and a memory card.

The transfer procedure is explained below.

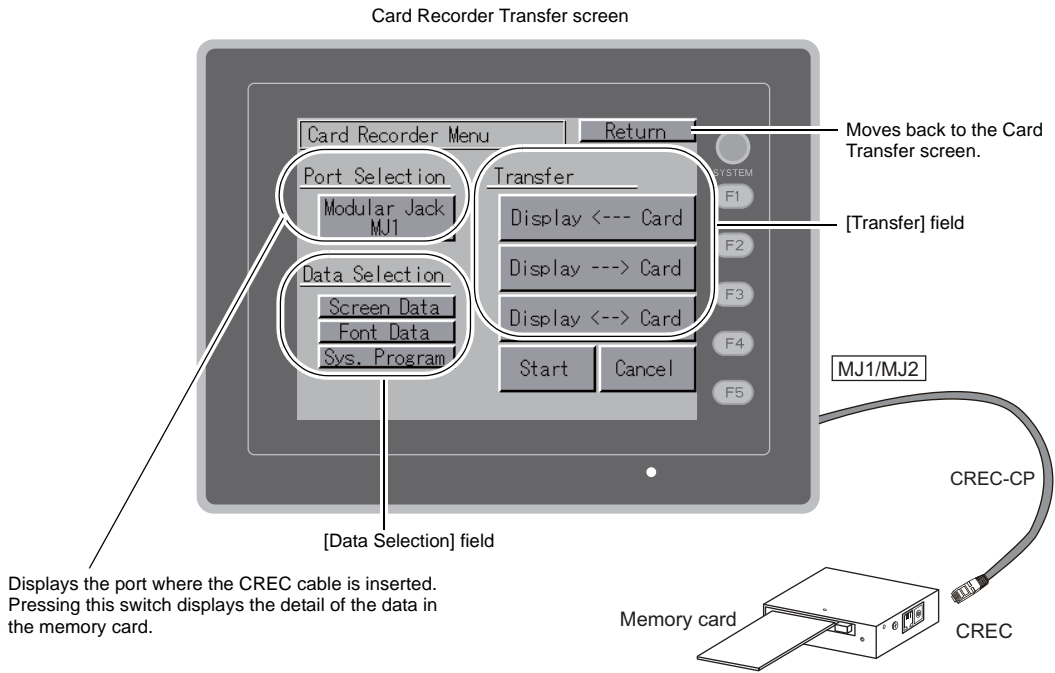

1. Connect the CREC cable "CREC-CP" to the MJ port that is displayed in the [Port Selection] field.

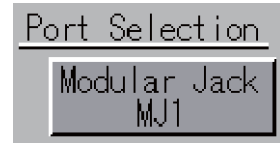

2. Insert a memory card into the card recorder "CREC".
3. Press the [Modular Jack MJ1 (or MJ2)] switch in the [Port Selection] field to display the Memory-Card screen. You can view the information in the memory card.

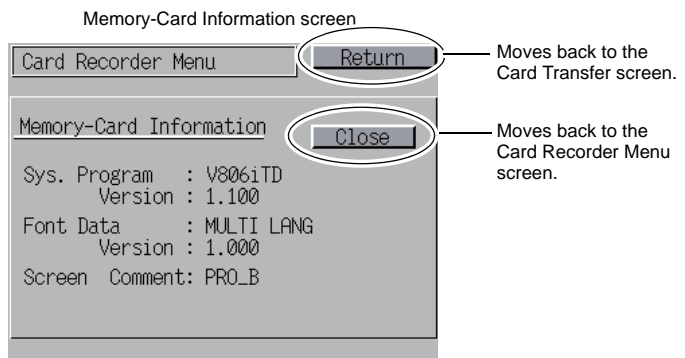

4. The [Modular Jack MJ1 (or MJ2)] switch under [Port Selection] lights up. Select necessary items in the [Data Selection] and [Transfer] fields.

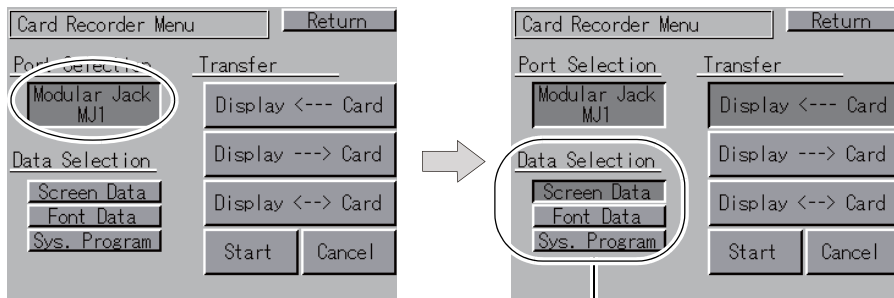

Multiple items can be selected in the [Data Selection] field.

5. Press the [Start] switch. During data transfer, the [Start] switch changes to [Transferring]. When data has been transferred successfully, the following message window is displayed. Press the [OK] switch.

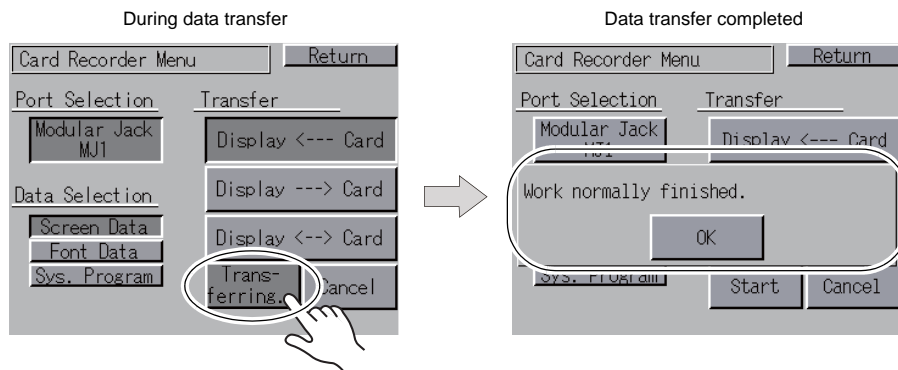

- \* If any other message is displayed, refer to "Message Window Displayed during Data Transfer (between V806 and Card)" (page 5-29).

## 7-6. Message Window Displayed during Data Transfer (between V806 and Card)

If data transfer from the CF card or the memory card result in an error, the error message window as shown below is called up on V806.

Error message window

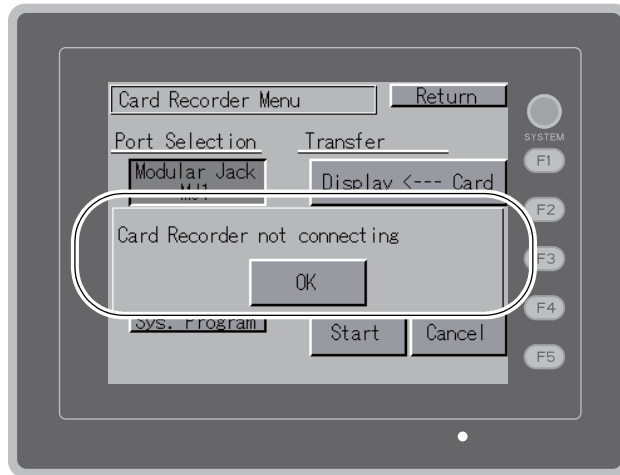

The kinds and the contents of the messages are shown below.

Messages	Contents	CF Card	Memory Card
Work normally finished.	The specified operation has been concluded normally.	○	○
Card Recorder not connecting	No card recorder is connected when selecting a modular jack.	–	○
Card Recorder Communication Error	A communication error occurred between the V806 and the card recorder when selecting a modular jack.	–	○
Card not setting	Card is not inserted.	○	○
Card Capacity over	Cannot write the data into a card because the data size in the V806 unit is larger than the capacity of a card.	○	○
Write Protect: ON	Cannot write data into a card because the write protect switch in a card is ON.	–	○
Writing Error occurred.	The error occurred while writing data into a card.	○	○
Selected data does not exist.	The data in the reading target does not exist.	○	○
Data type is different.	The specified type of the data in the V806 unit is different from the type of the card data.	○	○
Selected data can not be read.	The data in a card cannot be read.	○	○
Reading Error occurred.	The error occurred during writing data into a flash ROM of the V806 unit.	○	○
Data discrepant	There is some discrepancy in data, when comparing the data between a card and the V806.	○	○
Screen data on V8 will be broken.	Warning about data destruction in V806 that may occur when transferring font data larger than the present data from a memory card to V806. (The [OK] switch continues transferring; the [Cancel] switch stops transferring.)	○	○
Cover for CF card is opened.	The CF card interface cover is opened.	○	–
Undefined Error occurred.	The error occurred due to some cause other than those mentioned above.	○	○
Invalid format.	The filesystem of the CF card or USB thumb drive cannot be recognized. Format these devices to FAT or FAT32 on a computer.	○	–

## 8. I/O Test

Pressing the [I/O Test] switch on the Main Menu drop-down window brings up the I/O Test screen. This screen is used to check that there is no problem with the V806 interfaces and touch switch operation.

Main Menu drop-down window

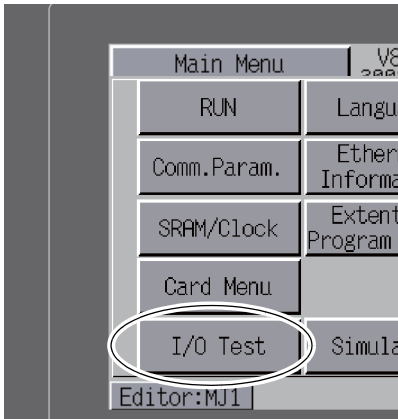

I/O Test screen

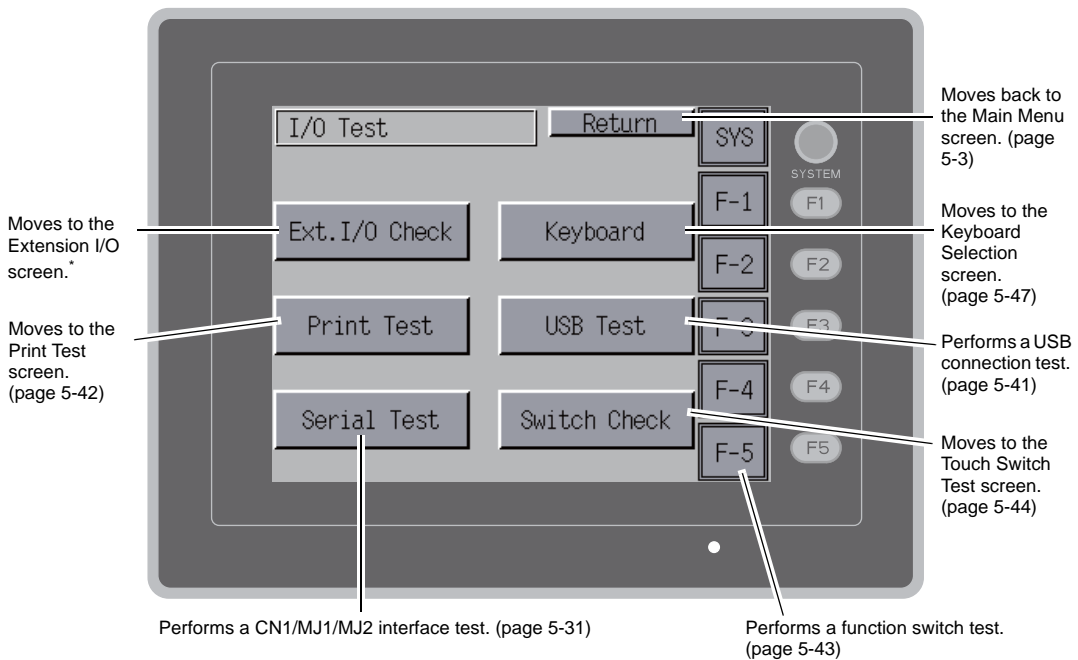

\* When the serial extension I/O "V-I/O" is connected, you can check that the V-I/O works correctly. The [Ext. I/O Check] switch appears only when [V-I/O] is selected for a modular jack (MJ1/MJ2) on the V-SFT-5 editor.

### 8-1. Self-loop Test

Pressing the [Serial Test] switch on the I/O Test screen displays the Serial Test screen. This is a signal test for communications through the MJ1, MJ2 or CN1 connector.

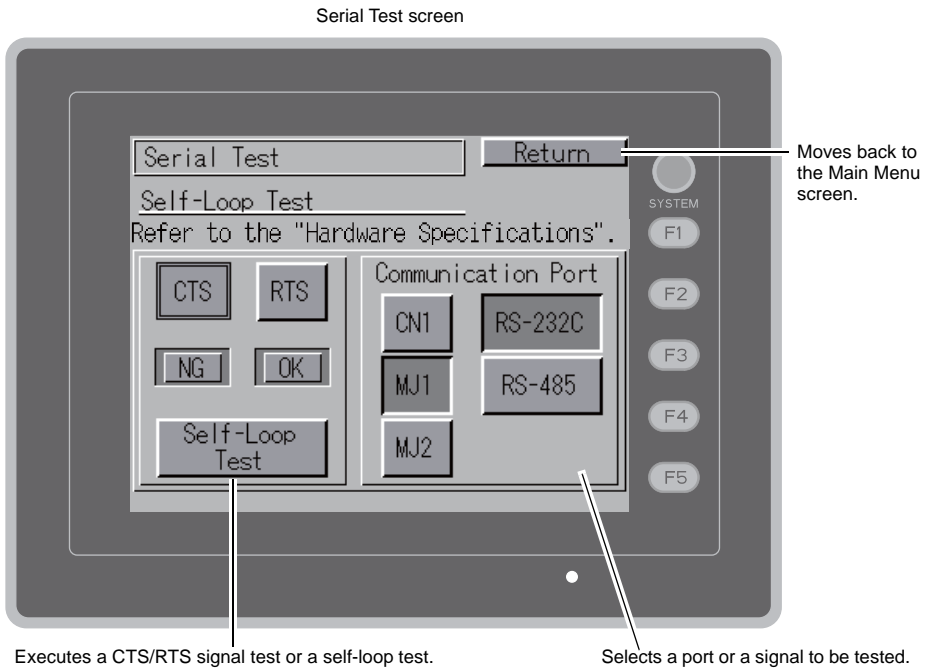
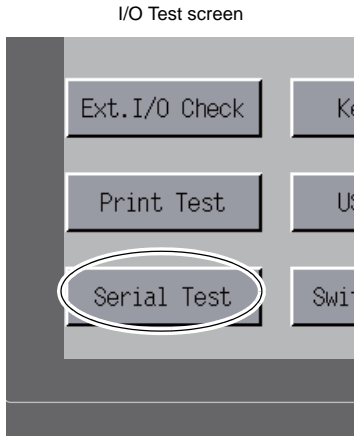

## Pin Numbers of MJ1/MJ2 and CN1 (D-sub 9-pin)

The signal test procedure may vary, depending on the presence or absence of the optional unit, "DU-10". Refer to the description of the test you wish to conduct.

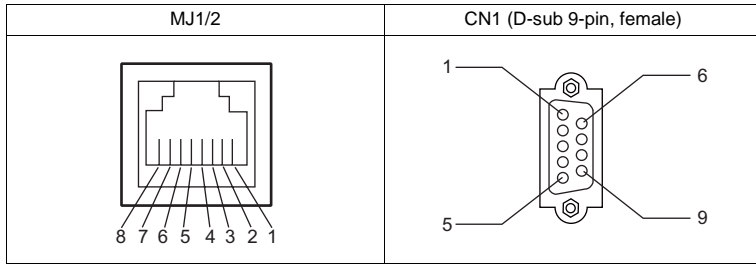

## MJ2: RS-232C Signal Test

Check the signals [SD] and [RD].  
Turn the [MJ2] and [RS-232C] switches on.

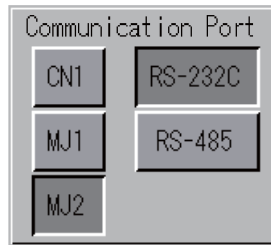

### With/Without DU-10

- Slide the slide switch on the V806 unit to the upper position for RS-232C/RS-485.
- Install a jumper between pins 7 and 8 of MJ2.

Name	No.
RD	7
SD	8

- Press the [Self-Loop Test] switch. When the [OK] lamp lights up, the test is successfully completed.

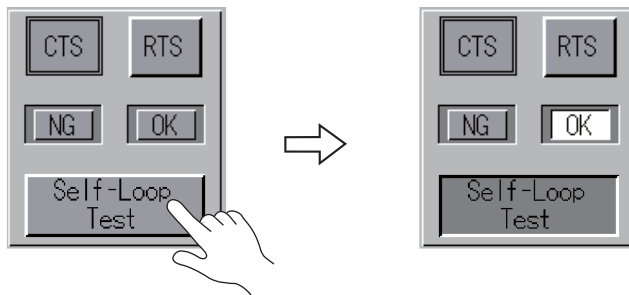

\* If the [NG] lamp lights up, pin 7 or 8 may be faulty. Contact your local distributor.



## MJ2: RS-422/RS-485 Signal Test

Check the signals [+SD], [-SD], [+RD] and [-RD].  
Turn the [MJ2] and [RS-485] switches on.

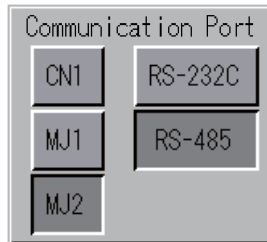

### Without DU-10

1. Slide the slide switch on the V806 unit to the lower position for RS-422.
2. Install a jumper between pins 1 and 7, and between pins 2 and 8 of MJ2.

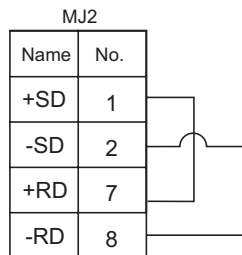

3. Press the [Self-Loop Test] switch. When the [OK] lamp lights up, the test is successfully completed.

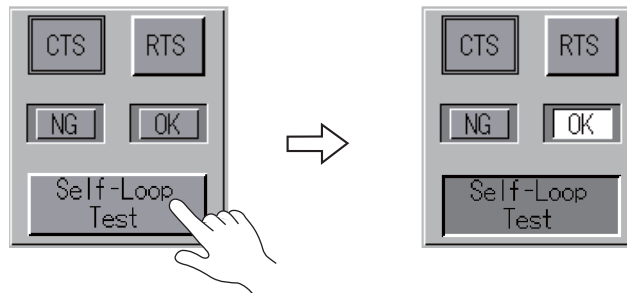

\* If the [NG] lamp lights up, a pin may be faulty. Contact your local distributor.

### With DU-10

Execute an RS-485 (2-wire connection) signal test. The test is conducted on a condition that the MJ2 is connected to the CN1. Therefore, check that RS-422 signals are normally sent/received at the CN1 before proceeding to a self-loop test for the MJ2. The signal test procedure for CN1 is described in "CN1: RS-485 Signal Test" (page 5-39).

When conducting an RS-422 (4-wire connection) signal test, disconnect the "DU-10".

The signal test procedure is described in, "MJ2: RS-422/RS-485 Signal Test" (page 5-33).

1. Slide the slide switch on the V806 unit to the upper position for RS-232C/RS-485.
2. Install wiring between MJ2 and CN1 as shown below.

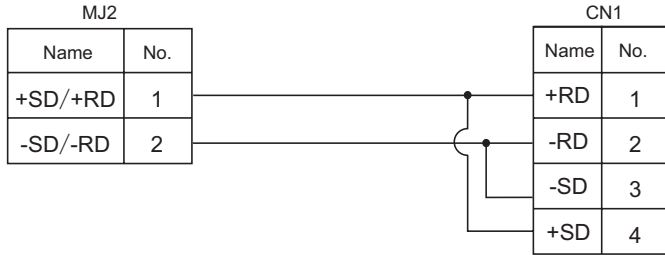

3. Press the [Self-Loop Test] switch. When the [OK] lamp lights up, the test is successfully completed.

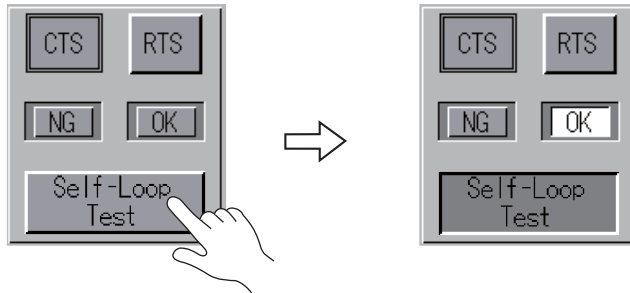

\* If the [NG] lamp lights up, a pin may be faulty. Contact your local distributor.

### MJ1: RS-232C Signal Test

Check the signals [SD] and [RD].  
Turn the [MJ1] and [RS-232C] switches on.

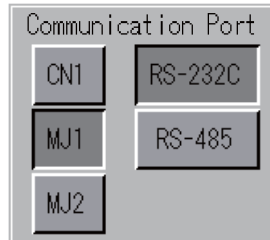

For the signal test procedure, refer to steps 2 and 3 described in "MJ2: RS-232C Signal Test" (page 5-32).

### MJ1: RS-485 Signal Test

Check the signals [+SD], [-SD], [+RD] and [-RD].  
Turn the [MJ1] and [RS-485] switches on.

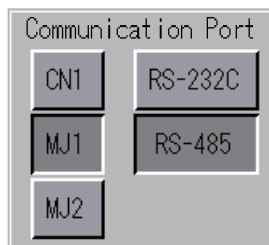

#### Without DU-10

The test is conducted on the condition that the MJ1 is connected to the MJ2. Therefore, check that RS-485 signals are normally sent/received at the MJ2 before proceeding to a self-loop test for the MJ1.

The signal test procedure for the MJ2 is described in, "MJ2: RS-422/RS-485 Signal Test" (page 5-33).

1. Slide the slide switch on the V806 unit to the upper position for RS-232C/RS-485.
2. Install wiring between MJ1 and MJ2 as shown below.

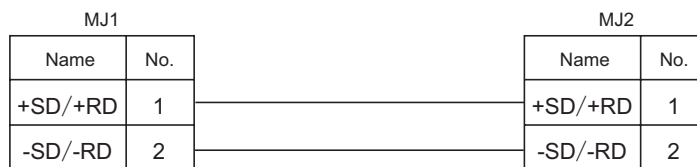

- Press the [Self-Loop Test] switch. When the [OK] lamp lights up, the test is successfully completed.

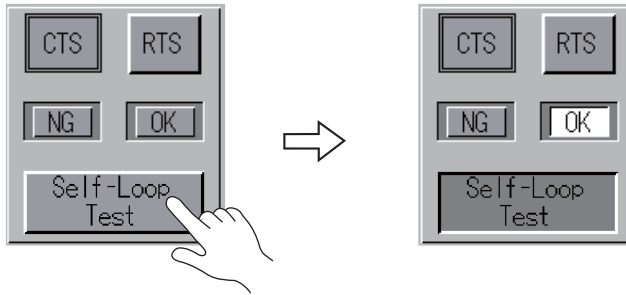

\* If the [NG] lamp lights up, a pin may be faulty. Contact your local distributor.

### With DU-10

The test is conducted on the condition that the MJ1 is connected to the CN1. Therefore, check that RS-422 signals are normally sent/received at the CN1 before proceeding to a self-loop test for the MJ1.

The signal test procedure for the CN1 is described in, "CN1: RS-485 Signal Test" (page 5-39).

- Install wiring between MJ1 and CN1 as shown below.

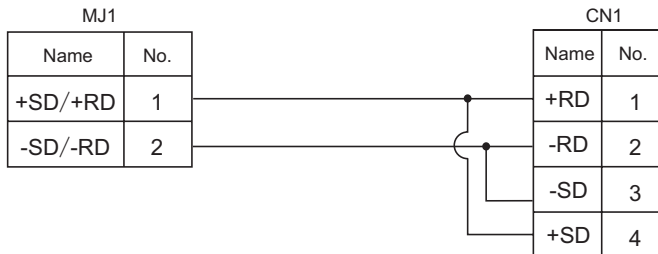

- Press the [Self-Loop Test] switch. When the [OK] lamp lights up, the test is successfully completed.

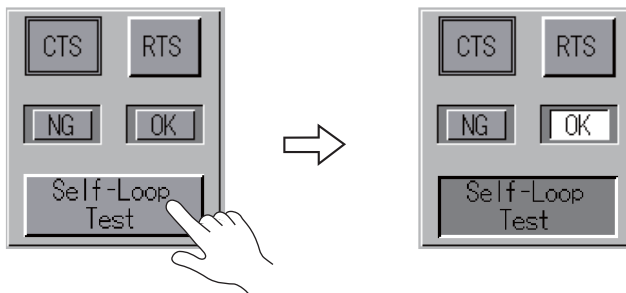

\* If the [NG] lamp lights up, a pin may be faulty. Contact your local distributor.

## CN1 (D-sub 9-pin): RS-232C Signal Test

Turn the [CN1] and [RS-232C] switches on.

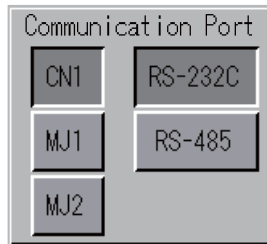

## [SD]/[RD] Signal Test

Check the signals [SD] and [RD].

1. Install a jumper between pins 2 and 3 of CN1 (D-sub 9-pin).

Name	No.
RD	2
SD	3

2. Press the [Self-Loop Test] switch. When the [OK] lamp lights up, the test is successfully completed.

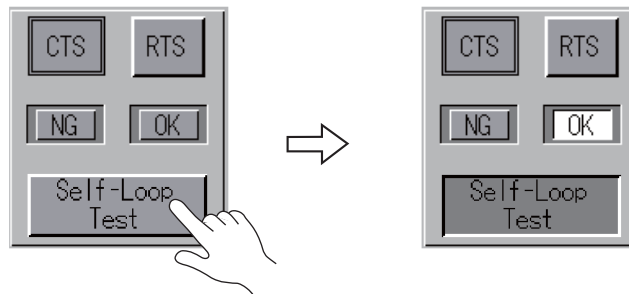

\* If the [NG] lamp lights up, pin 2 or 3 may be faulty. Contact your local distributor.

**[RTS]/[CTS] Signal Test**

Check the signals [RTS] and [CTS].

1. Install a jumper between pins 7 (RTS) and 8 (CTS) of CN1 (D-sub 9-pin).

Name	No.
RTS	7
CTS	8



2. Press the [RTS] switch and check that both [RTS] and [CTS] lamps light up at the same time. Press the [RTS] switch again and check that both [RTS] and [CTS] lamps go off at the same time.

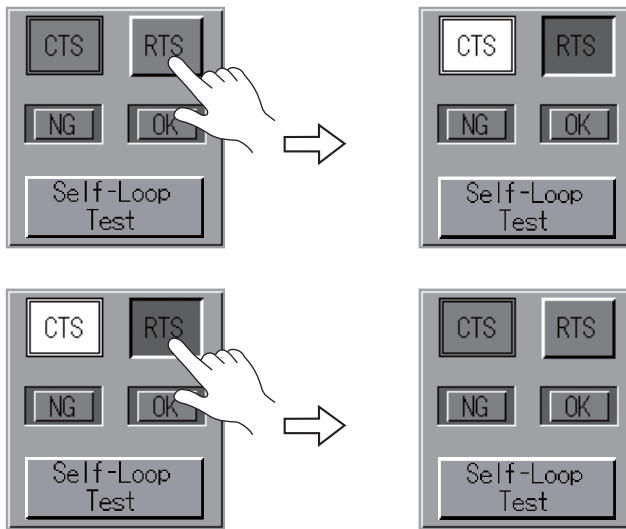

## CN1: RS-485 Signal Test

Turn the [CN1] and [RS-485] switches on.

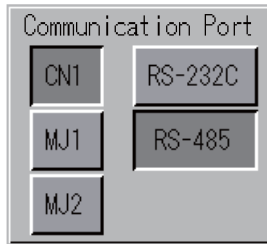

## [SD]/[RD] Signal Test

Check the signals [+SD], [-SD], [+RD] and [-RD].

1. Install a jumper between pins 1 and 4, and between pins 2 and 3 of CN1 (D-sub 9-pin).

Name	No.
+RD	1
-RD	2
-SD	3
+SD	4

The diagram shows a table with four rows and two columns. To the right of the table, there are two vertical lines representing jumpers. The first jumper connects the 'No.' column of the first row (1) to the 'No.' column of the fourth row (4). The second jumper connects the 'No.' column of the second row (2) to the 'No.' column of the third row (3).

2. Press the [Self-Loop Test] switch. When the [OK] lamp lights up, the test is successfully completed.

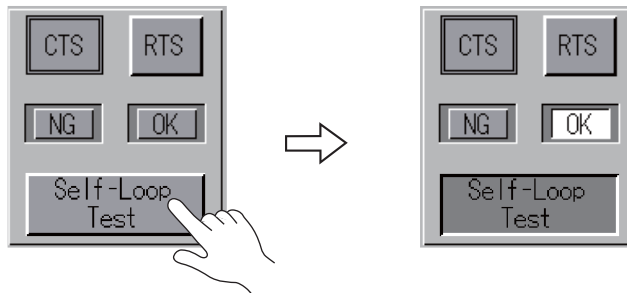

\* If the [NG] lamp lights up, a pin may be faulty. Contact your local distributor.

### [RTS] Signal Test

Check the signals [+RTS] and [-RTS].

1. Install a jumper between pins 1 (+RD) and 6 (+RTS) of CN1 (D-sub 9-pin) and between pins 2 (-RD) and 7 (-RTS).

Name	No.
+RD	1
-RD	2
+RTS	6
-RTS	7



2. Press the [RTS] switch and check that both [RTS] and [CTS] lamps light up at the same time. Press the [RTS] switch again and check that both [RTS] and [CTS] lamps go off at the same time.

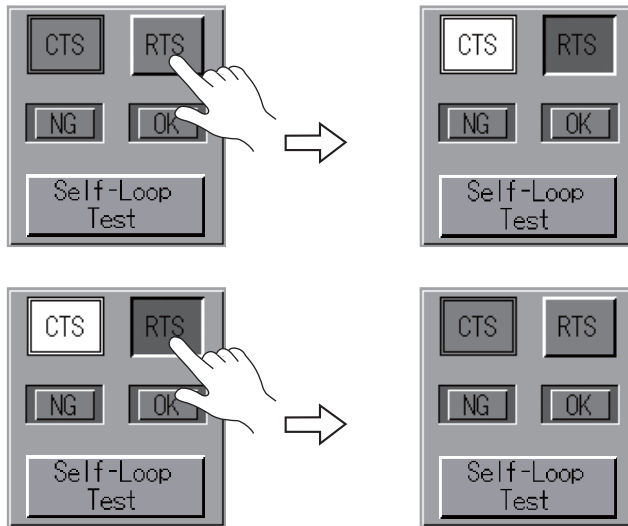

\* Since CN1 (D-sub 9-pin) does not have [+CTS] nor [-CTS] signal, a self-loop test should be performed by using [+RD] (pin 1) and [-RD] (pin 2) signals.



## 8-2. USB Test

Pressing the [USB Test] switch on the I/O Test screen displays the USB Test screen. This screen is used to check the status of the USB-A (master port) connection.

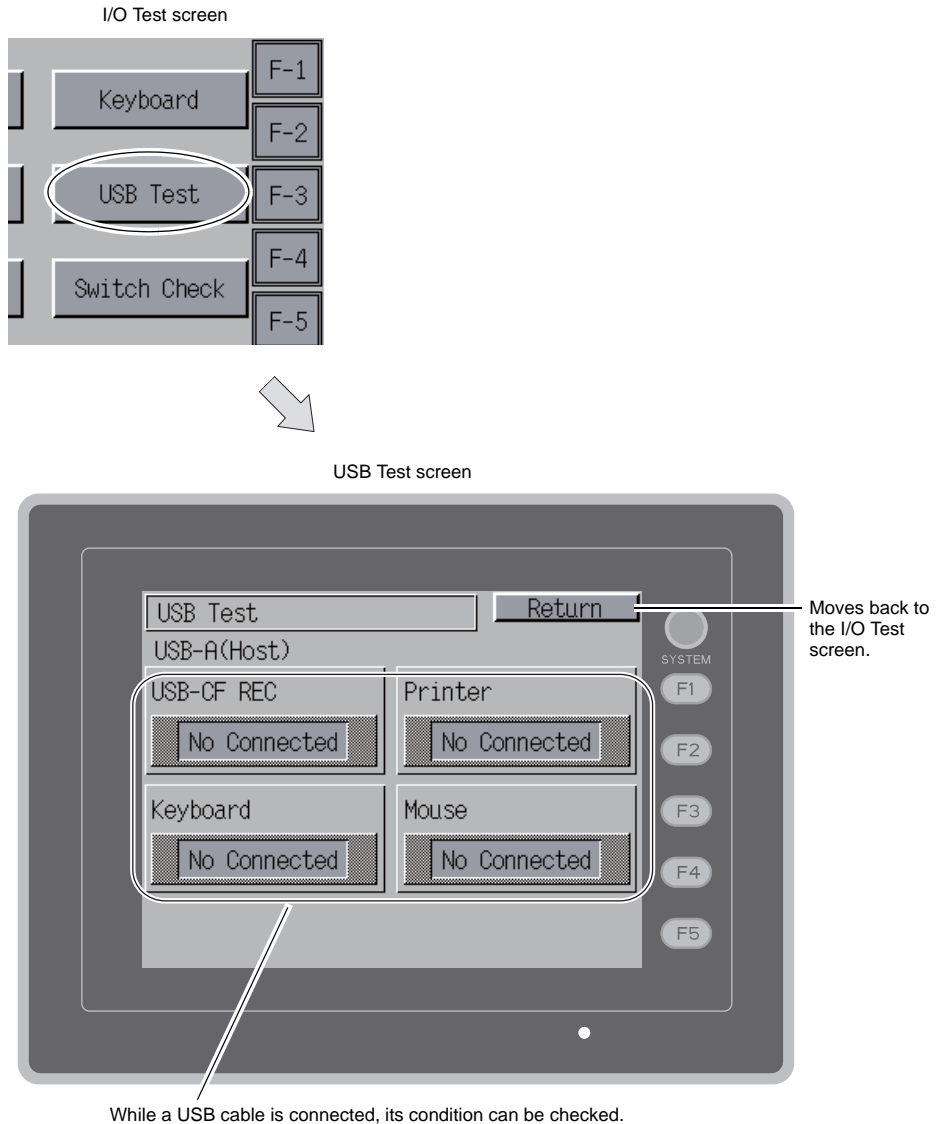

### Checking the Connection Status

When the lamp shows [Connected], the USB device is correctly recognized.



\* If the lamp on the screen shows [No Connected], the USB device is not correctly recognized.



## 8-4. [SYSTEM] Switch & Function Switch Test

Check the operations of the six function switches provided vertically on the right side of the V806 panel. Hold down the switch, and check that the lamp on the screen lights up.

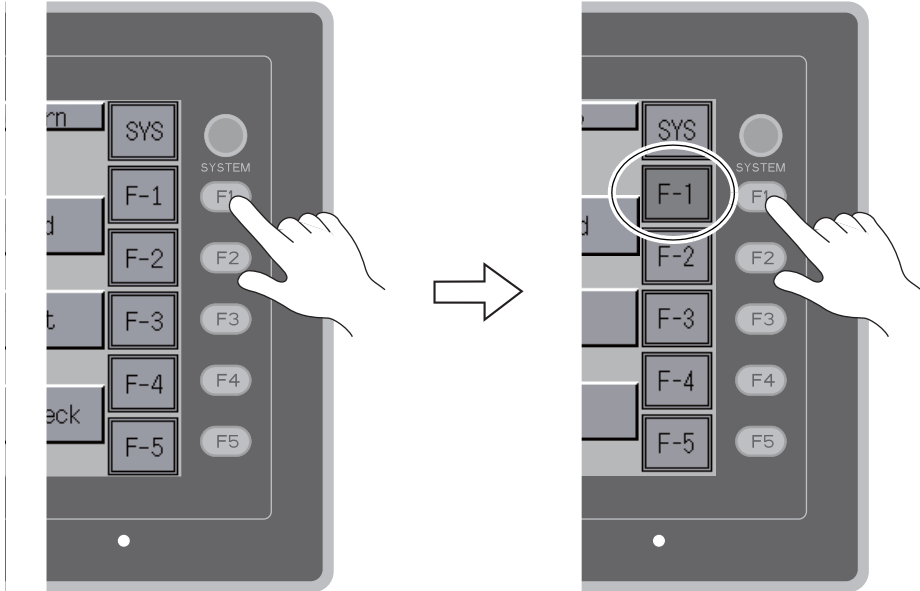

## 8-5. Touch Switch Test

Pressing the [Switch Check] switch on the I/O Test screen displays the touch switch test screen. This screen allows you to check touch switches for any errors; for example, a pressed switch remains inactive or a switch that is not pressed becomes active.

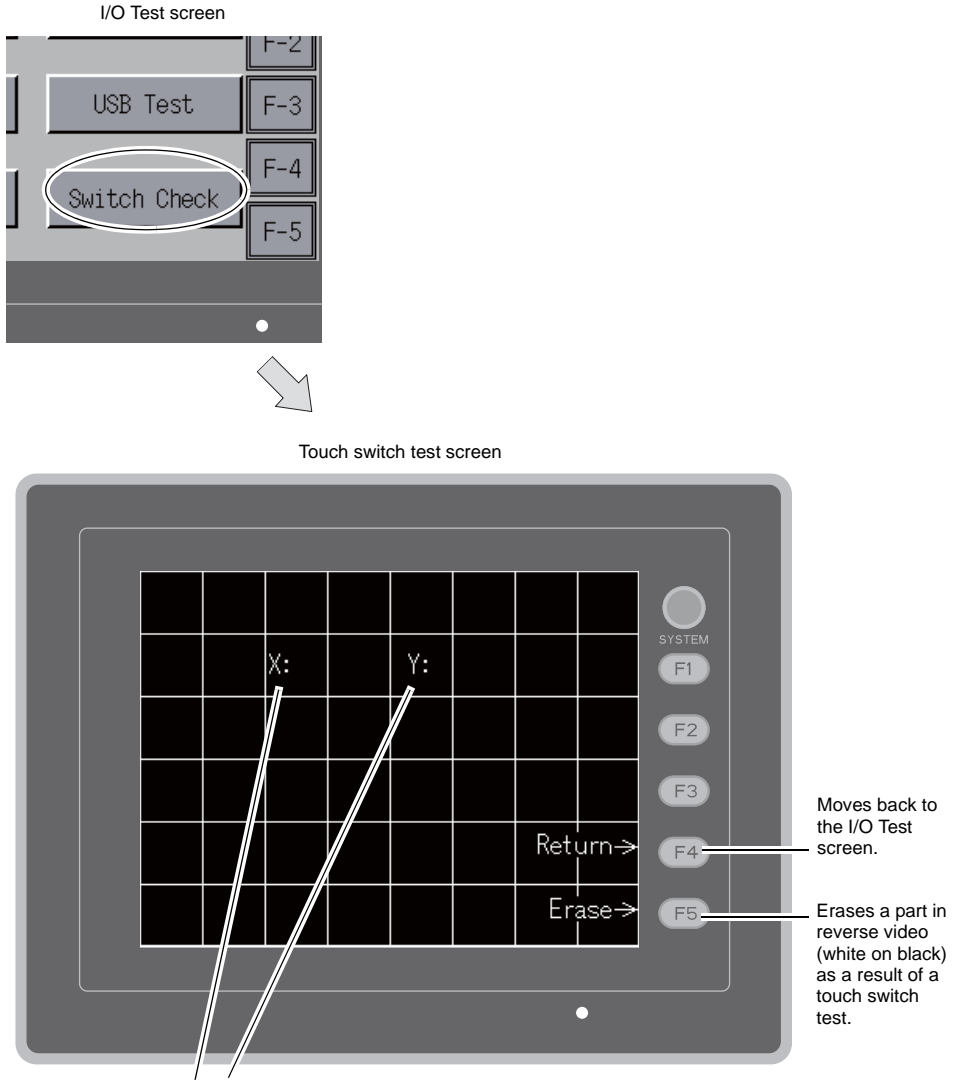

Shows the X and Y coordinates of the part where an output is produced by pressing.

## Checking the Switch Output State

Press a position on the touch switch test screen, and check that the pressed position turns white. The white color means that the touch switch is activated correctly.

Touch switch test screen

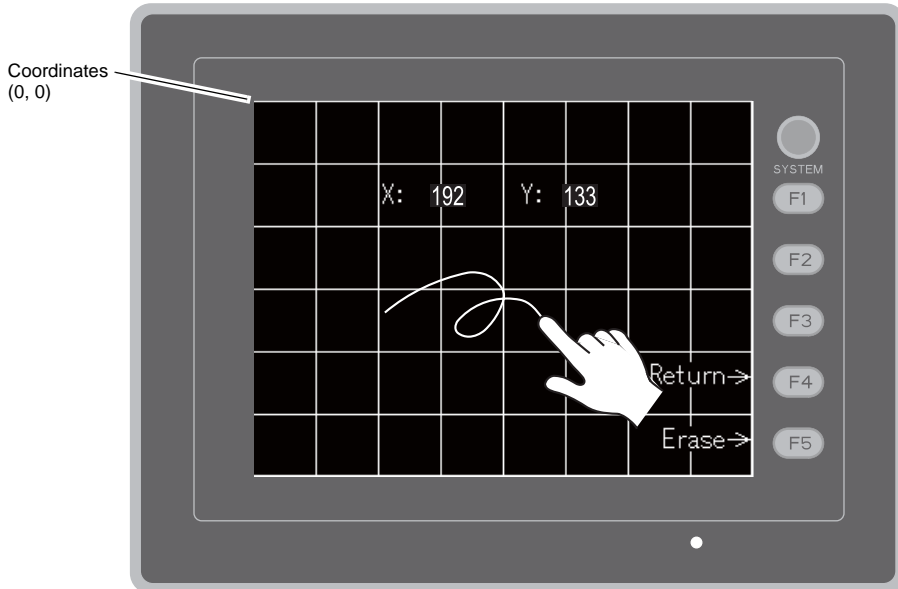

- \* If a position different from the pressed position turns white on the touch switch test screen, the touch switch position needs to be adjusted. For details, refer to, "Touch Switch Adjustment" (page 5-46).

Touch switch test screen

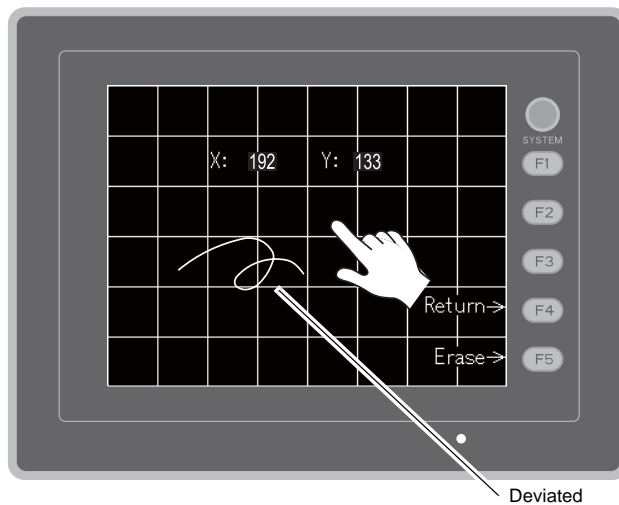

## Touch Switch Adjustment

If a position different from the pressed position turns white on the touch switch test screen, follow the steps described below to adjust the touch switch position.

1. Hold down the [SYSTEM] switch and press the [F2] switch on the touch switch test screen. The Touch Switch Adjustment screen appears.

Touch switch test screen

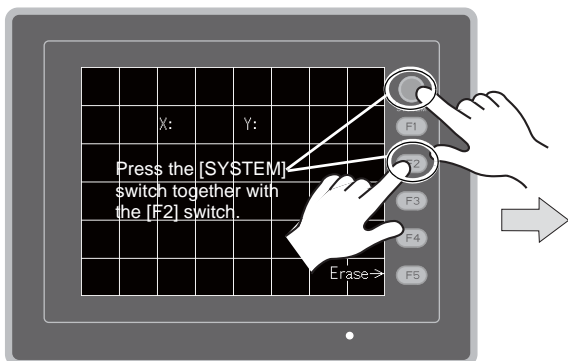

Touch Switch Adjustment screen

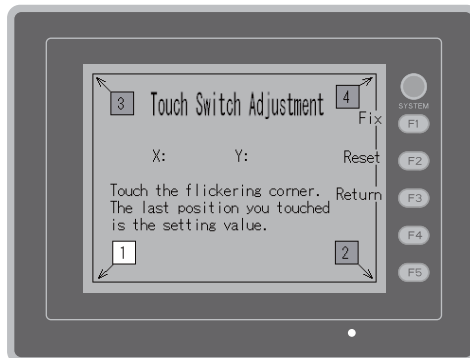

2. Press on "1" that is flashing at the corner. When the finger is released, a beep sounds and the position is set. "2" flashes.
3. Press on "2" that is flashing at the corner. When the finger is released, a beep sounds and the position is set. "3" flashes.
4. Press on "3" that is flashing at the corner. When the finger is released, a beep sounds and the position is set. "4" flashes.
5. Press on "4" that is flashing at the corner. When the finger is released, a beep sounds and the position is set.

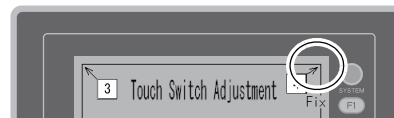
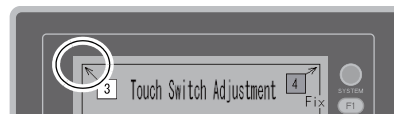
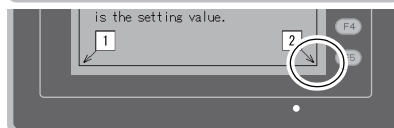
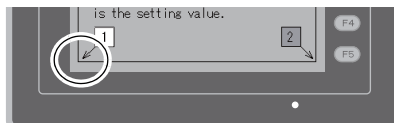

6. To re-set the positions, press the [F2] switch and follow step 2 and later.
7. Press the [F1] switch. A long beep sounds and the positions are determined. The touch switch test screen is displayed again.
8. To cancel the setting, press the [F3] switch. The touch switch test screen is displayed again.

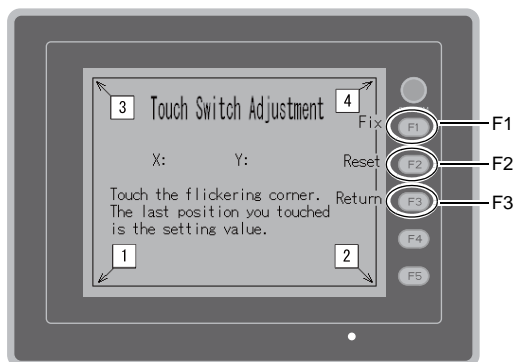

## 8-6. Keyboard Selection

This screen is used to select the type of the keyboard to be connected to the USB-A (master) port.

1. Keyboard Selection screen  
Press the [Keyboard] switch to display the Keyboard Selection screen.

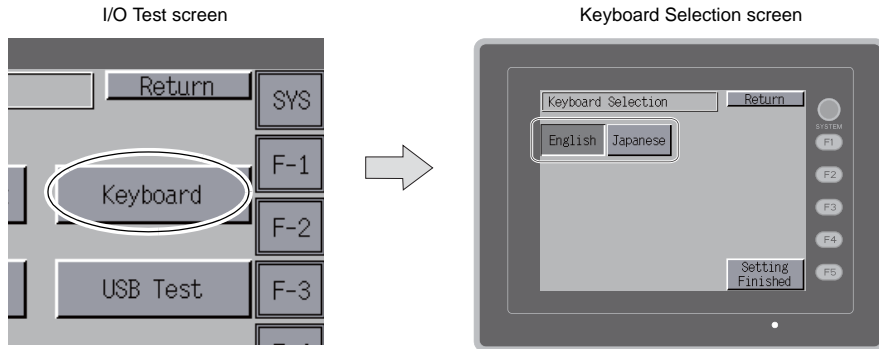

2. Selecting a keyboard type  
Select the keyboard type by pressing the [English] or [Japanese] switch.

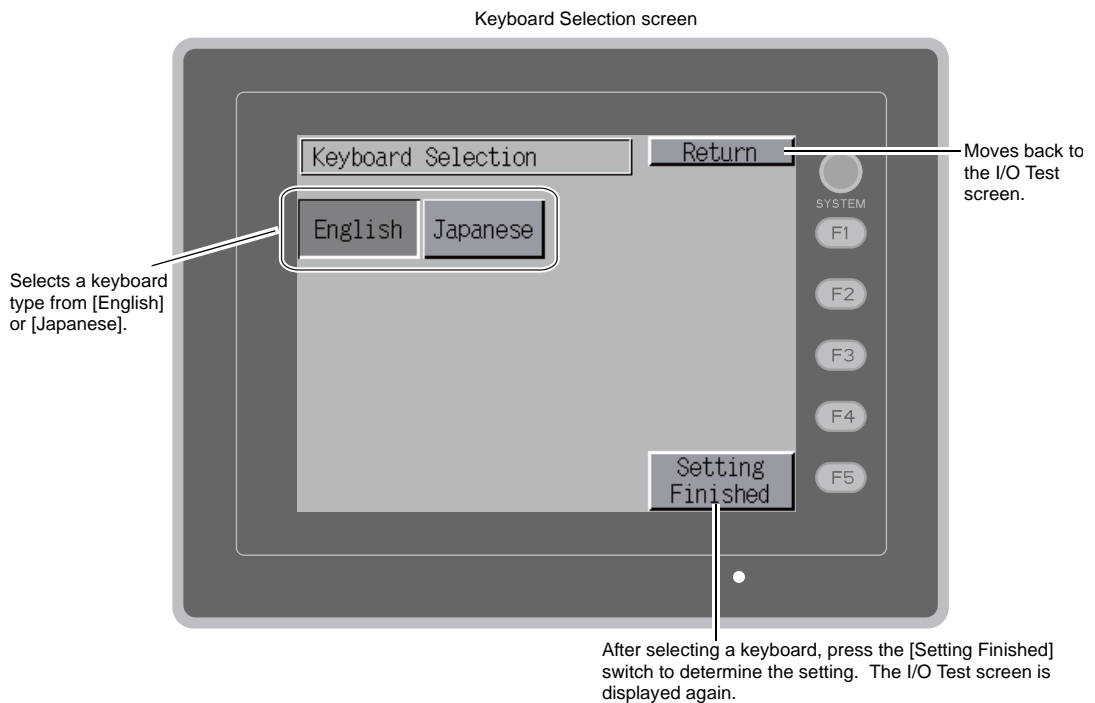

- \* [English] is selected as the default.  
After the [Setting Finished] switch is pressed when a keyboard type has been selected from the Keyboard Selection screen, the selected keyboard remains effective if the power is turned off and on again.

3. Press the [Setting Finished] switch to determine the setting. The I/O Test screen is displayed again.

## 9. Extended Function Setting

Pressing the [Editor: MJ1] switch on the Main Menu screen and the [F5] switch at the same time displays the Extended Function Setting screen. This screen is used to set the baud rate for modem communication and the local port number for V-Link or Modbus slave communication.

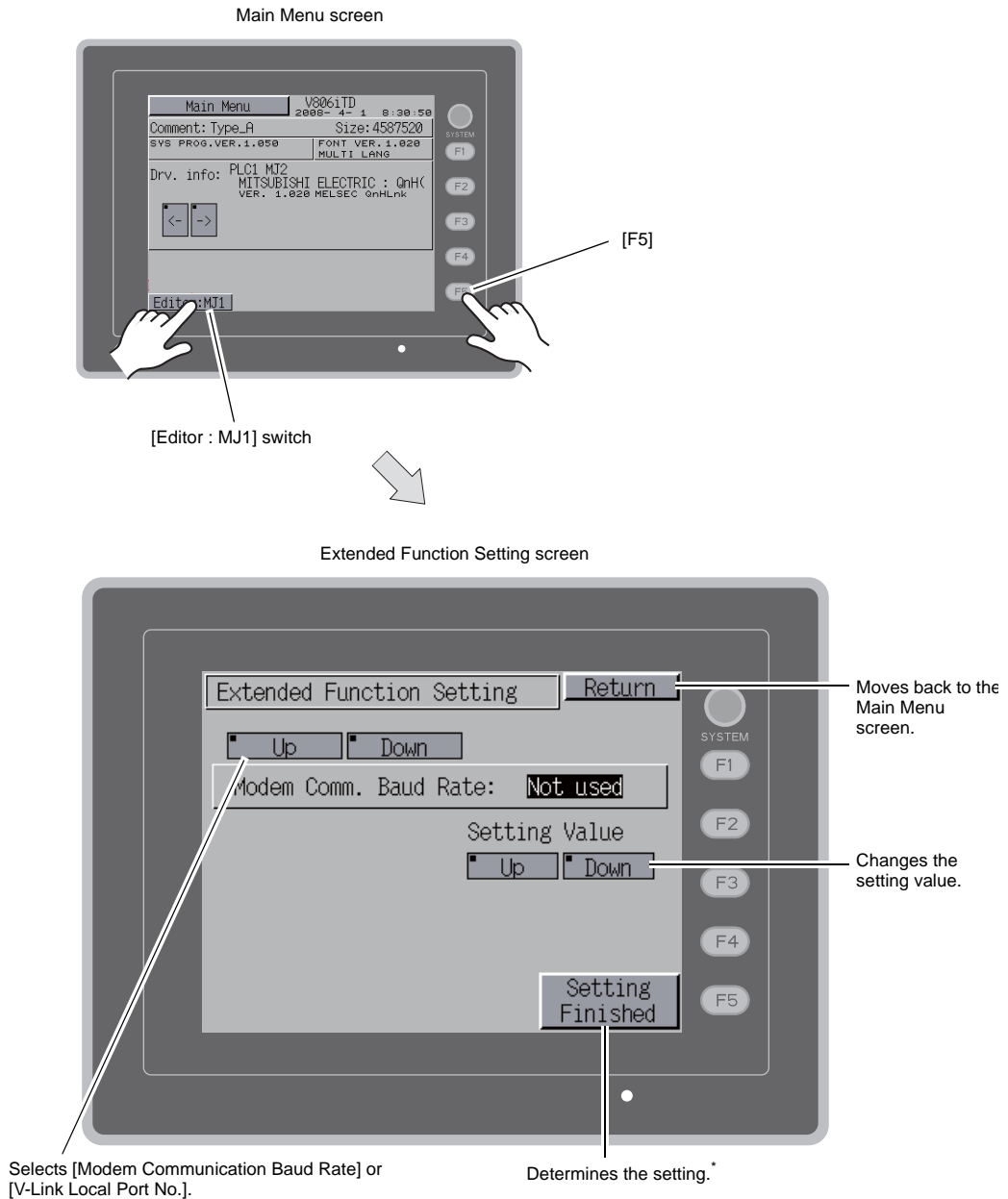

\* The function switches and switches on the Main Menu screen are not valid for 15 seconds after the [Setting Finished] switch is pressed.



## 9-1. Setting Baud Rate between V806 Series and Modem

Set the baud rate to be used when transferring screen data between the V806 series and a modem.

1. Select the desired baud rate using the [Up] or [Down] switch, and press the [Setting Finished] switch to determine the setting.

\* The baud rate can be selected from 4800, 9000, 19200, 38400, 57600 or 115200 bps.

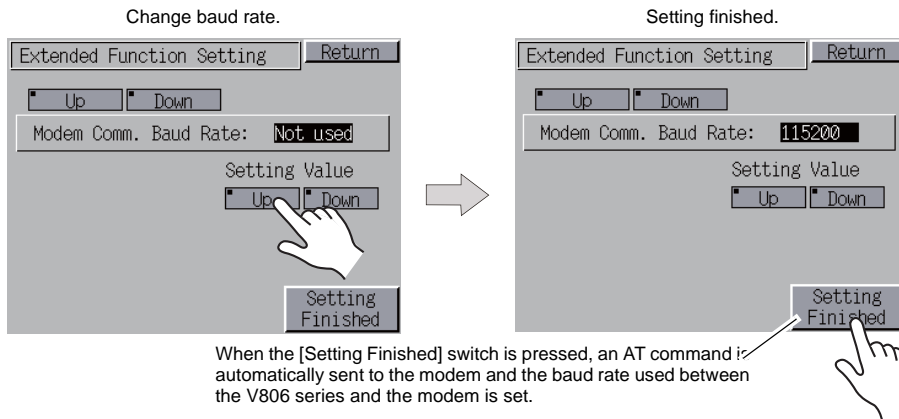

2. The Main Menu screen is displayed automatically. [Modem Connect Mode]\* automatically appears under [Editor: MJ1].

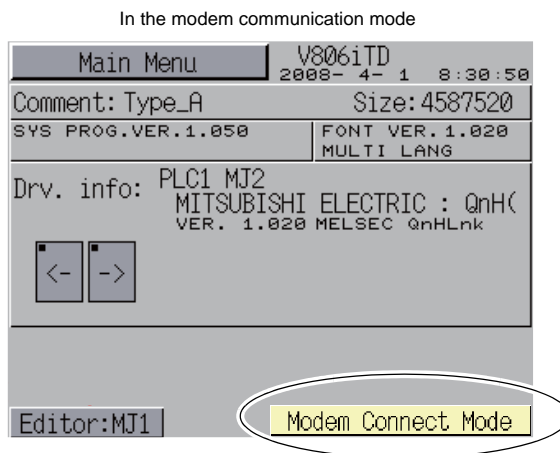

\* To transfer screen data without a modem, select "Not Used" for [Modem Comm. Baud Rate]. To transfer screen data by connecting the V806 series and the computer via "V-CP", select "Not used" for [Modem Comm. Baud Rate].

## 9-2. Setting Local Port Number

For V-Link, Modbus slave or multi-link communication, set the local port number from the Main Menu screen.

(The local port number can be set when [Set Local Port No. in Main Menu] is checked with [PLCn: V-Link] or [PLCn: Modbus Slave (RTU)] selected in the [Device Connection Setting] dialog ([System Setting] → [Device Connection Setting]) or with [Connection Mode: Multi-link] selected in the [Communication Setting] tab window ([System Setting] → [Device Connection Setting] → [Communication Setting]).

1. Displaying the [Local No.] field  
Press the [Down] switch to display the [Local No.] field.
2. Setting the local port number  
Select a local port number using the [+] or [-] switch. The local port number can be selected from 1 to 254.  
Press the [Setting Finished] switch to complete the setting.

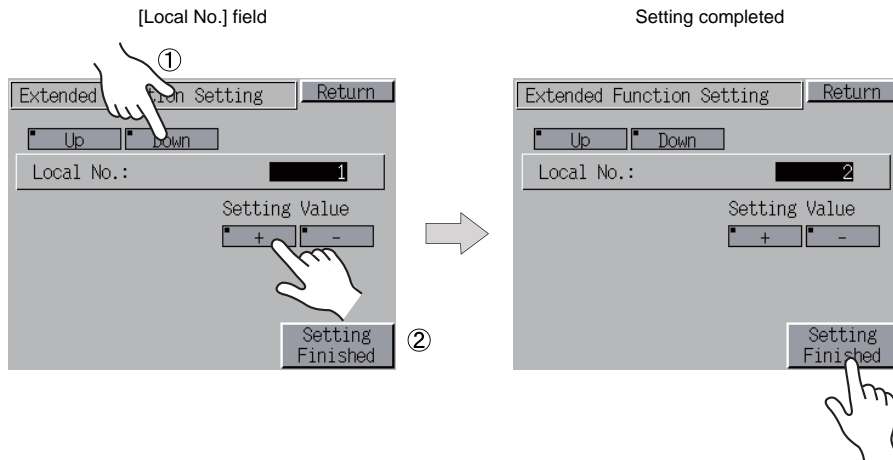

3. The Main Menu screen is automatically displayed again.

# 6 Error Handling

---

1. Error Messages
2. Troubleshooting

# 1. Error Messages

There are five kinds of error messages displayed on the V806 series:

1. Communication Error
2. Data Loading
3. Warning
4. System Error
5. Touch switch is active.

## 1. Communication Error

When communication is not established between the V806 series and a controller, or any abnormality (noise etc.) is detected, the following messages are displayed on the V806 series.

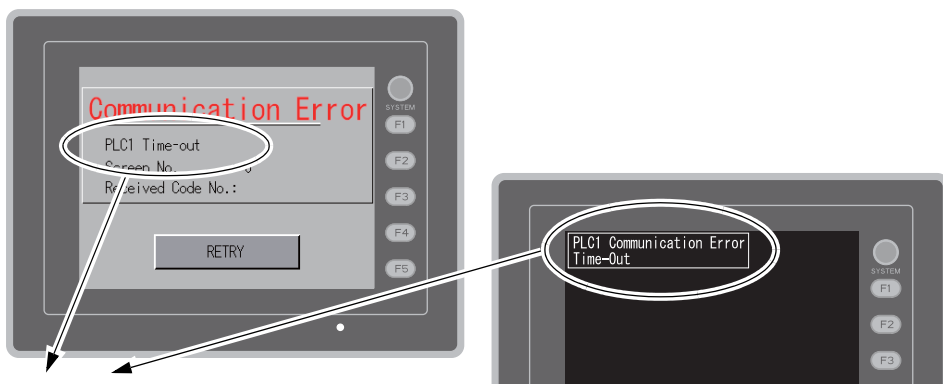

Error Messages	Contents	Solution	Remarks
Time-Out	Although a request to send is given to a controller, no answer is returned within the specified time.	1. Check settings in the [Communication Setting] tab window of the [Device Connection Setting] dialog.	1
		2. Check the cable connection.	
Parity	An error occurred in parity check.	3. Data may be disrupted because of noise. Fix noise.	2
		1. Check the cable connection.	1
Framing	Although the stop bit must be [1], it is detected as [0].	2. Data may be disrupted because of noise. Fix noise.	2
		1. Check settings in the [Communication Setting] tab window of the [Device Connection Setting] dialog.	1
Overrun	After one character is received, the next character is received before internal processing is completed.	2. Check the cables and wiring.	
		3. Data may be disrupted because of noise. Fix noise.	2
Check code error	The check code in the controller response was not correct.	1. Check settings in the [Communication Setting] tab window of the [Device Connection Setting] dialog.	1
		2. Data may be disrupted because of noise. Fix noise.	2

\* If the above error messages are displayed on the V806 series without establishing communication between V806 and PLC, test the solution of remark "1". If the error occurs suddenly in communication, test the solution of remark "2".

Error Messages	Contents	Solution
Error code received	An error code was sent by a controller. (NAK)	Examine the controller error code and solve the problem.
Break	The controller's SD remains at the low level.	Examine the connection between the controller's SD and the V806's RD.
Invalid memory (Mitsubishi CPU)	You specified an address that exceeds the memory range of the PLC that you are linked to.	Check the type and range of memory that you set.
Invalid CPU model (Mitsubishi CPU)	The PLC currently being supported does not have a corresponding CPU.	Confirm whether or not the CPU that you are using can be used with the V806 series.
Format	The code of the received data is invalid.	<ol style="list-style-type: none"> <li>1. Confirm link unit settings. (After making settings, cut power to the controller.)</li> <li>2. On the V-SFT-5 editor, select [System Setting] → [Device Connection Setting] and check the settings.</li> <li>3. If errors only occur from time to time, a noise-based communication error may be present.</li> </ol>
Compare (HIDIC S10)	Transmission data and received data are different.	
NAK	A NAK code is received.	
Transaction Error (Allen-Bradley PLC)	Transmitted transaction data and received transaction data are not in agreement.	
Communication Error	An unclear communication error is detected.	
Count error (Mitsubishi CPU and Q link unit)	The expected data amount is different from the count value.	
Command error (Mitsubishi CPU and Q link unit)	The response code differs from the expected code.	
Invalid cassette (Mitsubishi ACPU)	This cassette is not included in the memory cassettes currently being supported.	Contact your local distributor.
Password error (Mitsubishi QCPU)	The password is incorrect.	

## 1-1. Error Messages for Network Communication

### Ethernet

Error Messages	Contents	Solution
Ethernet Error:XXXX	The Ethernet status is saved at system memory address \$s518 and a code other than "0" (normal) is received. XXXX : Error No.	For the contents and solution to each error number, refer to Appendix 5 of the V8 Series Connection Manual separately provided.

### CC-LINK

Error Messages	Contents	Solution
I/F Board Err	The I/F unit for CC-LINK has an error.	Contact your local distributor.
Station Number Err	The port number set by a switch is not within the setting range (1 to 64).	Specify the port number within the setting range.
Word Writing to Sp. Relay	Word writing to a special relay (M9000 and later) is attempted. (Notes: Only bit writing is possible for special relays when connecting with CC-LINK.)	Do not attempt to perform word writing to special relays.

## OPCN-1

Error Messages	Contents	Solution
I/F Board Err	The I/F unit for OPCN-1 has an error.	Contact your local distributor.
Stat. No. out of range	The port number set by a switch is not within the setting range (1 to 127).	Specify the port number within the setting range.
Network Link Error	Cannot connect to the master station in the network.	Check the condition of the master station (PLC). Check the network connection.
Network I/O Access Err	MONITOUCH has attempted to have access to a memory area out of the designated input/output words.	Check the memory for the network I/O in the screen data file.
Waiting for Reply	<ol style="list-style-type: none"> <li>Less than "Max_int" time (communication monitoring time for salve station) set on the PLC for OPCN-1 communications</li> <li>Timeout on the V806 series (The timeout time can be set in the [Device Connection Setting] dialog that is displayed by selecting [System Setting] → [Device Connection Setting] on the V-SFT-5 editor.)</li> </ol> This error is indicated when the above 1 and 2 are present.	When the "Max_int" time is too long (infinite, for example) on the PLC, it is not possible to know whether or not the response from the PLC is correctly made. This error message disappears when a response from the PLC is received within the "Max_int" time.
Word Writing to Sp. Relay (Mitsubishi: A Series)	Word writing to a special relay (M9000 and later) is attempted. (Notes: Only bit writing is possible for special relays when connecting with OPCN-1.)	Do not attempt to perform word writing to special relays.

## T-LINK

Error Messages	Contents	Solution
T-LINK I/F Board Err	The I/F unit for T-LINK has an error.	Contact your local distributor.
Network I/O Access Err	MONITOUCH has attempted to have access to a memory area out of the designated input/output words.	Check the memory for the network I/O in the screen data file.
Communication Error Received Code No. 22	The PLC loader is being accessed so that processing is not performed on the V806 series. (This error occurs during program transfer from the PLC loader for most cases.)	Wait for the PLC loader to finish processing, and retry to establish communication.
Communication Error Received Code No. 32	An attempt to access an area that does not exist within the PLC is made. Example: A file area (W) that is not defined with the PLC program	Check the PLC memory addresses set in the screen data file.
Communication Error Received Code No. 36	The number of monitor registration points is too small.	Correct the number of monitor registration points. For monitor registration, refer to the user manual of the PLC you are using.

## PROFIBUS-DP

Error Messages	Contents	Solution
Time-Out	"Check" is displayed 2 or 3 seconds before this error occurs when connecting the V806 series and PROFIBUS-DP in the RUN mode.	The setting for [Own Stat. No.] on the V806 series is discrepant with that for [Address] for [V8 series] on the SIMATIC Manager. Check and correct the setting.
	A screen is displayed instantaneously (= communications performed) before this error occurs when connecting the V806 series and PROFIBUS-DP in the RUN mode.	The DB address set on the V806 screen may not exist on the PLC (memory over). Check the setting.

## DeviceNet

○: Extinguished ●: Illuminated ◎: Blinking

Error Messages	LED		Contents	Solution
	MS	NS		
Initialization error	● Red	○	Reading or writing to RAM is not performed normally during initialization check.	<ul style="list-style-type: none"> <li>Turn the power on again.</li> </ul> If recovery is not possible, a fault is suspected.
			Start-up information check error: The baud rate is outside the specified range.	<ul style="list-style-type: none"> <li>Make the baud rate (using DIP switch 7 and 8) the same as set for the master on "CU-07" and turn on the power again.</li> </ul> If recovery is not possible, a fault is suspected.
			Start-up information check error: Excessive size for input	<ul style="list-style-type: none"> <li>On the V-SFT-5 editor, select [System Setting] → [Device Connection Setting]. In the [Input/Output Word Counts Setting] tab window, enter the desired value of up to 128 words for [Input Range]. Then turn on the power again.</li> </ul>
			Start-up information check error: Excessive size for output	<ul style="list-style-type: none"> <li>On the V-SFT-5 editor, select [System Setting] → [Device Connection Setting]. In the [Input/Output Word Counts Setting] tab window, enter the desired value of up to 128 words for [Output Range]. Then turn on the power again.</li> </ul>
BUS OFF Error	● Green	● Red	<ul style="list-style-type: none"> <li>The communication cable is short-circuited at start-up.</li> <li>The baud rate does not match the setting for the master.</li> </ul>	<ul style="list-style-type: none"> <li>Check the wiring and turn on the power again.</li> <li>Make the baud rate (using DIP switch 7 and 8) the same as set for the master on "CU-07" and turn on the power again.</li> </ul>
Node Address Duplication Error	● Green	● Red	The same node address is already used for the master or some other slave.	<ul style="list-style-type: none"> <li>Check the node address and correct it to an address which is not used yet (using DIP switch 1 to 6) on "CU-07". Then turn on the power again.</li> </ul>
Network Error	● Green	○	The network power is off.	<ul style="list-style-type: none"> <li>Turn on the network power supply.</li> </ul>
			No other devices exist on the network.	<ul style="list-style-type: none"> <li>Check the wiring and turn on the power again.</li> <li>Make the baud rate (using DIP switch 7 and 8) the same as set for the master on "CU-07" and turn on the power again.</li> </ul>
		◎ Red	I/O time-out: Communication with the master has become disabled.	<ul style="list-style-type: none"> <li>Check the conditions of the master power supply.</li> <li>Check the wiring.</li> </ul>
		◎ Green	No connection exists.	<ul style="list-style-type: none"> <li>Check the wiring.</li> </ul>
Definition Error	–	–	The returned error code is not supported by the DeviceNet.	Review the settings below: <ul style="list-style-type: none"> <li>Master setting</li> <li>CU-07 setting</li> <li>V-SFT-5 setting</li> <li>Wiring</li> </ul>

\* Depending on the errors detected, turning on the power again may be necessary on the master as well as on the V806 series.

## 2. Data Loading

If an error is detected on the screen data in the RUN mode, the following messages are displayed on the V806 series.



Error Messages	Contents	Solution
Screen No. Error	There is no setting for the received screen.	At the start of communications, the V806 series regards the value in the read area "n + 2" as the screen number. Check that this value is an existing screen number on the controller.
Error : XX (XX : XXX)	There is an error in the created screen data.	<p>According to the item number and the sub-item number displayed on the V806 series, find the edited screen where the error occurs. Check the contents of the error (error number) and remove the error.</p> <p style="text-align: center;">                     Error : XX (XX : XXX)   └───┬─── Sub-item No.   └───┬─── Item No.   └───┬─── Error No.                 </p> <p>For details on the item number and sub-item number, refer to the V8 Series Reference Manual.</p>

## 3. Warning

A message may be displayed on the Main Menu screen. This is a warning message. For the warning details and solutions, refer to the V8 Series Reference Manual and correct screen data.

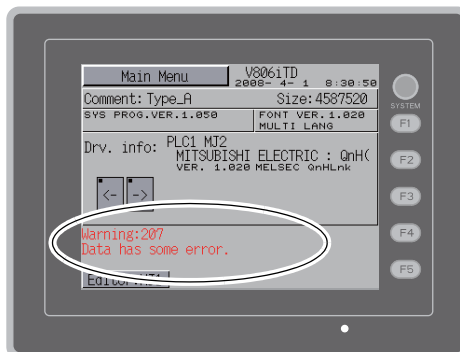



## 4. System Error

---

When a system error is detected, the following error screen is displayed on the V806 series.

System Error screen

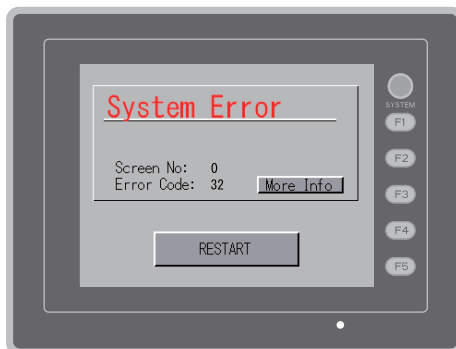

Error Code: XX

- 1: Watchdog timer error
- 11: Switch table error
- 30: Request for displaying full error
- 31: Memory allocation system error
- 32: General exceptions/MMU address system error
- 33: RTOS system error
- 34: Memory error
- 35: Inaccurate memory error
- 37: Inaccurate memory write error

The source of the error could be one of the following three problems.

- 1) Program crash due to noise
- 2) Hardware problem
- 3) Bad program

**If any of these errors occurs, contact your local distributor.**

## 5. Touch Switch Is Active

---

If the power is turned off while a touch switch is activated, the error screen is displayed.

If you are touching the screen, remove your hand from it.

If the error screen remains displayed, contact your local distributor.



## 2. Troubleshooting



### In the Event of an Error

Perform the steps below:

1. If the current error matches a symptom in the following table, correct it by following the instructions provided.
2. If the error does not match the symptoms in the table, contact your local distributor.  
Please provide the distributor with the information on the MONITOUCH model, serial number, symptom of the error, error message, etc.

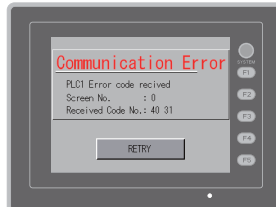
### Probable Symptoms

Symptom	Cause	Solution
<p>MONITOUCH is connected to controllers; however, communication fails. "Communication Error: Time-Out" appears on the screen.</p> 	<p>Probable causes are:</p> <ol style="list-style-type: none"> <li>1) Cables are not connected correctly or any cable is disconnected.</li> <li>2) Parameter settings in the controller are not correct or disagree with the V806-series settings.</li> <li>3) The MONITOUCH is faulty.</li> </ol>	<p>Solutions are:</p> <ol style="list-style-type: none"> <li>1) Check the cable connection.</li> <li>2) Recheck the parameter settings in the controller.</li> <li>3) Perform a self-loop test on the I/O Test screen (page 5-31). If the test is not successful, please return MONITOUCH to your local distributor immediately.</li> </ol>
<p>Communications have been successful. However, opening a certain page always causes a "Communication Error: Error code received" error.</p> 	<p>The error code denotes a controller error (NAK) in the hexadecimal notation.</p> <ol style="list-style-type: none"> <li>1) When the error code appears only on a certain screen, a memory address that does not exist on the controller may be set on the V806-series screen.</li> <li>2) When the error code appears at power-on, the memory address set for buffering area or initial macro or in the [Read/Write Area] tab window ([System Setting] → [Device Connection Setting]) may not exist in the controller.</li> </ol>	<ol style="list-style-type: none"> <li>1) Check if any address outside the allowable range for controller memory is set on the screen.</li> <li>2) Check if the address set for buffering area or initial macro or in the [Read/Write Area] tab window ([System Setting] → [Device Connection Setting]) is outside the allowable range for the controller memory.</li> </ol>

Symptom	Cause	Solution
<p>Communications have been successful. However, "Communication Error: Parity" or "Communication Error: Framing" suddenly occurs.</p> 	<p>Noise may cause the error.</p>	<p>Check if appropriate measures are taken against noise.</p> <p>Example: Check if communication and power cables are bundled together. Try to attach a ferrite core to the communication cable. Try to attach a noise filter to the power supply, etc.</p>
<p>"SYSTEM ERROR: xx" occurs.</p> 	<p>The following causes are probable, depending on the symptoms.</p> <ol style="list-style-type: none"> <li>1) Turning the power off and back on corrects the error. ↓ Communication failed because of improper timing.</li> <li>2) Turning the power off and back on does not correct the error. ↓ A certain condition always causes the error. Or MONITOUCH is faulty.</li> <li>3) A CF card is inserted. ↓ The CF card (front and back) may be reversed.</li> </ol> <p>If none of the above matches your error, contact your local distributor.</p>	<ol style="list-style-type: none"> <li>1) If communication is stable after turning the power on again, continue and observe operation.</li> <li>2) Make a note of the information on error number, etc. displayed on the screen and contact your local distributor.</li> <li>3) Check that the inserted CF card faces the correct side.</li> </ol>
<p>Switches do not work.</p>	<ol style="list-style-type: none"> <li>1) Switches do not work in the RUN mode. A beep sounds. ↓ Is the switch interlock enabled?</li> <li>2) Switch activation position is wrong. On the I/O Test screen displayed from the Main Menu screen, press the [Switch Check] switch. On the touch switch test screen, a position different from the pressed position is activated. ↓ The switch activation position may be misaligned.</li> <li>3) Switches do not work even in the STOP mode. On the I/O Test screen displayed from the Main Menu screen, press the [Switch Check] switch. When the touch switch test screen is pressed, nowhere is activated. ↓ MONITOUCH switches may be faulty.</li> </ol>	<ol style="list-style-type: none"> <li>1) Check the settings of switch functions, etc. on the V-SFT-5 editor.</li> <li>2) Perform a touch switch adjustment (page 5-46).</li> <li>3) Return MONITOUCH to your local distributor.</li> </ol>

Symptom	Cause	Solution
The screen becomes dark or black.	<p>1) Touching the screen restores it to the previous illuminated state. ↓ The backlight operates automatically as preset.</p> <p>2) Touching the screen does not restore it. However, the POWER lamp is lit. ↓ The backlight may be at the end of its life. Or MONITOUCH may be faulty.</p>	<p>1) The time for turning off the backlight can be changed on the V-SFT-5 editor.</p> <p>2) Return MONITOUCH to your local distributor.</p>
Screen data cannot be transferred.	<p>1) Screen data transfer has never succeeded. ↓ There may be some errors in the settings on the computer.</p> <p>2) Screen data transfer was possible, but is disabled now. ↓ The MONITOUCH may be faulty. Or, there may be some errors in settings.</p> <p>3) Only serial transfer is successful. ↓ There may be some errors in the Ethernet or USB settings.</p>	<p>1) In the [Transfer] dialog on the V-SFT-5 editor, decrease the baud rate by one level. Also check that the correct COM port is selected.</p> <p>2) Check if the modem connection mode is selected (page 5-49). ("Modem Connect Mode" displayed at the bottom of the Main Menu screen denotes the mode.) Also perform an RS-232C self-loop test (page 5-31).</p> <p>3) Transfer via Ethernet Check that the IP addresses set on the V-SFT-5 editor and MONITOUCH are the same. Also check if any error due to Ethernet connection occurs on MONITOUCH.</p> <p>Transfer via USB Is the USB driver recognized? Has the driver been installed successfully (page 2-20)?</p> <p>If the problem persists, contact your local distributor.</p>

# MEMO

Please use this page freely.

# 7 Inspection and Maintenance

---

1. Inspection and Maintenance
2. Warranty Policy

# 1. Inspection and Maintenance

**DANGER**

Be sure to turn off the power before conducting inspection or maintenance. Failure to do so could cause an electric shock or damage to the unit.

## Daily Inspection

- Check that the screws on the V806 series are tightened firmly.
- Check that the connectors and terminal screws used for connection with other devices are tightened firmly.
- If the display surface or frame is dirty, wipe it with a soft cloth soaked in alcohol (commercially available).
- Conduct periodical inspection once or twice a year. The number of inspections may be increased as necessary if facilities are relocated or modified, or the environment is hot, humid, or dusty.

## Periodical Inspection

Inspect the following points periodically.

- Are the ambient temperature and humidity appropriate?  
0 to +50 °C, 85 %RH or less
- Are the environmental conditions appropriate?  
No excessive dust, and no conductive dust
- Does the atmosphere contain no corrosive gas?
- Is the source voltage in the allowable range?  
With DC power supply: 24 VDC  $\pm$  10 %
- Are the V806-series mounting screws tightened firmly?
- Are the connectors and terminal screws used for connection with other devices tightened firmly?
- Is the lithium primary battery within the expiry date?  
About 5 years from the date of your purchase

## 2. Warranty Policy

---

### Inquiries about Failure

---

Please direct inquiries about failure or repair to your local distributor. Your information on the MONITOUCH model, serial number, symptom of the failure, error message (if shown), etc. will be appreciated.

- \* An inquiry form is provided on the final page (page 7-3) of this chapter. The form may be used for your inquiry.

### Warranty Period

---

The product is under warranty for one year after the date of purchase or delivery to the specified place. On the assumption that the maximum stock period of the product after manufacture is 6 months, the warranty period is limited to 18 months (checked by the serial number) after manufacture. When a warranty period is specified in the contract, however, the period in the contract takes precedence.

### Free-of-charge Repair

---

If the product fails before the expiry of the warranty, it will be repaired free of charge. However, repair of any failure resulting from the causes below will be chargeable even within the warranty period.

- Breakage of or damage to the appearance (case or surface sheet), touch switches, LCD, or other components due to dropping, impact, or mishandling
- LCD or backlight at the end of life
- Fusion of a printed circuit board pattern associated with connection to external devices, or fusion of a pattern in the terminal block or connector section of a printed circuit board caused by short-circuiting of external load circuit
- Overvoltage or different voltage applied due to wiring mistake (power supply terminal, external communication terminal, or other terminal blocks)
- Failure caused by lightning surge
- Failure due to the entry of conductive substances, water, solvent, particles, etc. under inappropriate environmental conditions
- Failure due to inappropriate environmental conditions (e.g. corrosive gas or high humidity)
- Failure due to vibration or impact exceeding the specified level
- Disassembly and modification by the customer or failure obviously resulting from improper handling by the customer

### Chargeable Repair

---

Any failure that occurs after the expiry of the warranty or does not satisfy the requirements for the free-of-charge repair will be repaired on a chargeable basis.



## Inquiry Form

Your name			
Company name			
Contact	Phone		Fax
	E-mail		
Model code *1			Ser. No. *1
MONITOUCH version *2	SYSTEM PROG. Ver. :		I/F Driver Ver. :
Purchased from: (Distributor)			
Person in charge		Date of purchase	
Symptom			
(Please describe the symptom of the failure and also include the error message if any is displayed.)			

- \*1 See the label on the back of MONITOUCH for the model code and serial number (seven digits plus one letter of the alphabet).

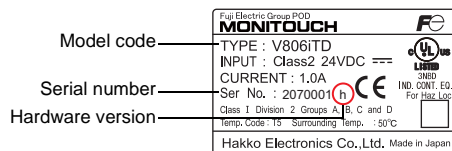

- \*2 Enter the version if it can be checked.  
The version is displayed on the Main Menu screen (page 5-3).

MEMO

Please use this page freely.

**Hakko Electronics Co., Ltd.**  
**[www.monitouch.com](http://www.monitouch.com)**

**Sales**      890-1, Kamikashiwano-machi, Hakusan-shi,  
Ishikawa, 924-0035 Japan  
TEL +81-76-274-2144    FAX +81-76-274-5136