

# V7E Series

## 15W 2:1 Regulated Single & Dual output



### Features

- Wide 2:1 Input Range
- Full SMD Technology
- 1600~3500 VDC Isolation
- No Minimum Load Required
- Efficiency up to 89%
- Extended Operating Temperature Range -40 ~ 85°C max.
- Continuous Short Circuit Protection
- Over Current Protection
- Soft Start
- EMI Complies With EN55022 Class A
- Optional Heat-sink

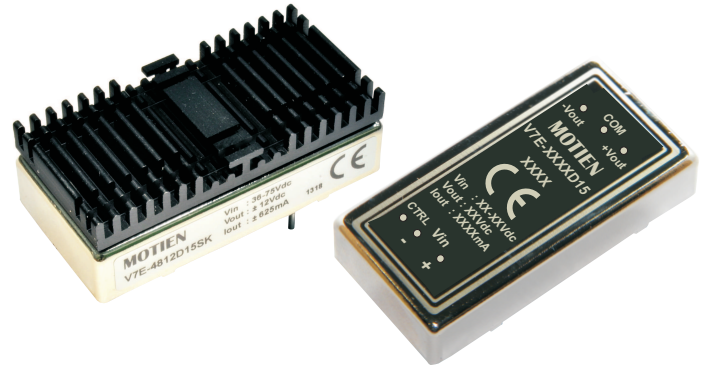

The V7E series is a family of high performance and cost effective 15W single and dual output DC/Dc converters. Encapsulated in a 2"X1" nickel coated brass case, featuring Active clamp switching technology - providing perfect regulation from no load to full load. Which is suitable for network distributed power source. High efficiency up to 89% - Output voltages are available from 3.3V, 5V, 12V, 15V and  $\pm 3.3V, \pm 5V, \pm 12V, \pm 15V$  and input ranges of 2:1 ranging from 12V (9V~18V), 24V(18V~36V) and 48V (36V~75V).

ALL SPECIFICATIONS ARE TYPICAL AT 25°C, NOMINAL INPUT AND FULL LOAD UNLESS OTHERWISE NOTED.

OUTPUT SPECIFICATIONS		EMC SPECIFICATIONS	
Output Voltage Accuracy	$\pm 1\%$ , max.	Radiated Emissions	EN55032 CLASS A
Maximum Output Current	See table, max.	Conducted Emissions (7)	EN55032 CLASS A
Line Regulation	$\pm 0.5\%$ , max.	ESD	IEC 61000-4-2 Perf. Criteria A
Load Regulation( Io=0% to 100%)(1)	Single: $\pm 0.5\%$ , max. Dual: $\pm 0.5\%$ , max. Dual: $\pm 0.8\%$ , max(only $\pm 3.3V$ )	RS	IEC 61000-4-3 Perf. Criteria A
Cross Regulation (Dual Output) (2)	$\pm 5\%$	EFT(8)	IEC 61000-4-4 Perf. Criteria A
Ripple&Noise (3)	75mVp-p, max.	Surge(8)	IEC 61000-4-5 Perf. Criteria A
Over Current Protection	140% of FL, typ.	CS	IEC 61000-4-6 Perf. Criteria A
Short Circuit Protection	Indefinite(hiccup) (Automatic Recovery)	PFMF	IEC 61000-4-8 Perf. Criteria A
Temperature Coefficient	$\pm 0.02\%/^{\circ}C$	GENERAL SPECIFICATIONS	
Capacitive Load (4)	See table, max.	Efficiency	See table, typ.
Transient Recovery Time (5)	250 $\mu$ s, typ.	I/O Isolation Voltage(60sec)	
Transient Response Deviation(5)	$\pm 3\%$ , max.	Input/Output	1600Vdc-3500Vdc
		Case/Input & Output	1600Vdc
INPUT SPECIFICATIONS		Isolation Resistance	1000 M $\Omega$ , min.
Input Voltage Range	See table	Isolation Capacitance	1200 pF, typ.
Under Voltage Lockout		Switching frequency	300kHz, typ.
12V Models Module ON / OFF	8.6Vdc / 7.9Vdc, typ.	Humidity	95% rel H
24V Models Module ON / OFF	17.8Vdc / 16Vdc, typ.	Reliability Calculated MTBF(MIL-HDBK-217 F)	>1.121 Mhrs
48V Models Module ON / OFF	33.5Vdc / 30.5Vdc, typ.	Safety Standard (designed to meet)	IEC/EN 60950-1
Start up Time (Nominal Vin and constant resistive load)	20mS, typ.	PHYSICAL SPECIFICATIONS	
Input Filter	Pi Type	Case Material	Nickel-coated Copper
Input Current(No-Load)	See table, max.	Pin Material	$\Phi 1.0$ mm Brass Solder-coated
Input Current(Full-Load)	See table, typ.	Potting Material	Epoxy (UL94V-0 rated)
Input Reflected Ripple Current(6)	20mA <sub>p-p</sub> , typ.	Weight	31.0g
CTRL(7) Module ON	2.5 to 5.5 Vdc or Open	Dimensions	2.00"x1.00"x0.4"
Module OFF	-0.7 to 0.8Vdc	ABSOLUTE SPECIFICATIONS (9)	
CTRL OFF Input Current	2.5mA, typ.	These are stress ratings. Exposure of devices to any of these conditions may adversely affect long-term reliability.	
ENVIRONMENTAL SPECIFICATIONS		Input Surge Voltage(100mS)	
Operating Ambient Temperature	-40°C ~ +85°C(See Derating Curve)	12 Models	30 Vdc, max.
	-40°C ~ +70°C(For 100% load)	24 Models	50 Vdc, max.
Maximum Case Temperature	100°C	48 Models	100 Vdc, max.
Thermal Impedance (Nature Convection)	Without Heat-sink 12°C/W With Heat-sink 10°C/W	Soldering Temperature (1.5mm from case 10sec Max.)	260°C, max.
Storage Temperature	-40°C ~ +125°C.		
Cooling	Nature Convection		

The information and specifications contained in this data sheet are believed to be correct at time of publication. However, MOTIEN Technologies accepts no responsibility for consequences arising from printing errors or inaccuracies. Specifications are subject to change without notice. No rights under any patent accompany the sale of any such product(s) or information contained herein.

## V7E - 15W 2:1 Regulated Single & Dual output

### PART NUMBER STRUCTURE

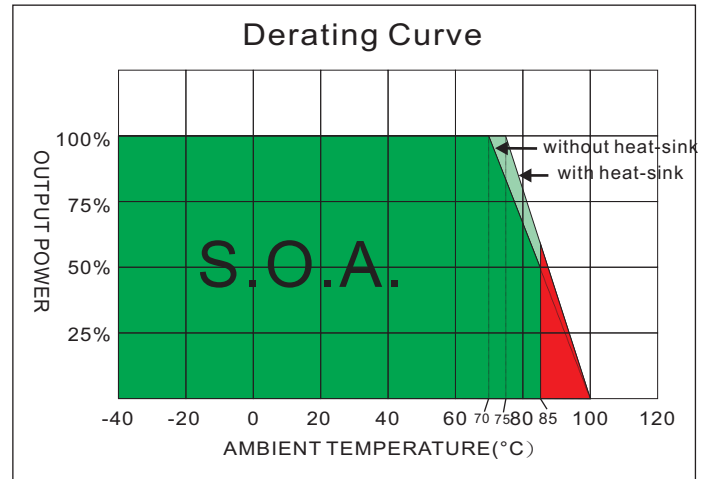
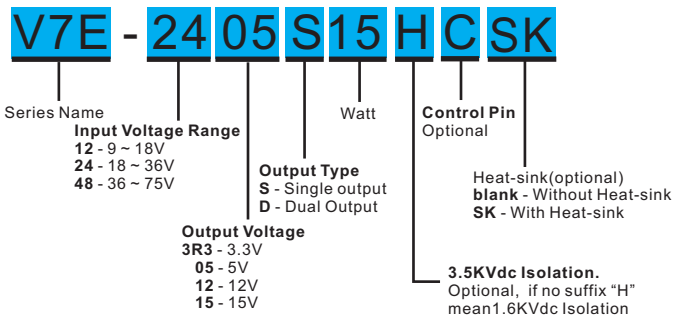

### MODEL SELECTION GUIDE

MODEL NUMBER	INPUT Voltage Range (Vdc)	INPUT Current		OUTPUT Voltage (Vdc)	OUTPUT Current		EFFICIENCY @FL (% , typ.)	Capacitor Load @FL (µF, max.)
		No-Load (mA, max.)	Full Load (mA, typ.)		Min. load (mA)	Full load (mA)		
V7E-123R3S15	9-18	30	1031	3.3	0	3000	82	3300
V7E-1205S15	9-18	30	1524	5	0	3000	84	3300
V7E-1212S15	9-18	30	1453	12	0	1250	88	1000
V7E-1215S15	9-18	30	1436	15	0	1000	89	680
V7E-123R3D15	9-18	30	1031	±3.3	0	±1500	82	±1000
V7E-1205D15	9-18	30	1506	±5	0	±1500	85	±1000
V7E-1212D15	9-18	30	1453	±12	0	±625	88	±470
V7E-1215D15	9-18	30	1453	±15	0	±500	88	±330
V7E-243R3S15	18-36	25	515	3.3	0	3000	82	3300
V7E-2405S15	18-36	25	753	5	0	3000	85	3300
V7E-2412S15	18-36	25	718	12	0	1250	89	1000
V7E-2415S15	18-36	25	718	15	0	1000	89	680
V7E-243R3D15	18-36	25	515	±3.3	0	±1500	82	±1000
V7E-2405D15	18-36	25	753	±5	0	±1500	85	±1000
V7E-2412D15	18-36	25	718	±12	0	±625	88	±470
V7E-2415D15	18-36	25	718	±15	0	±500	88	±330
V7E-483R3S15	36-75	20	257	3.3	0	3000	82	3300
V7E-4805S15	36-75	20	376	5	0	3000	85	3300
V7E-4812S15	36-75	20	359	12	0	1250	89	1000
V7E-4815S15	36-75	20	359	15	0	1000	89	680
V7E-483R3D15	36-75	20	257	±3.3	0	±1500	82	±1000
V7E-4805D15	36-75	20	376	±5	0	±1500	85	±1000
V7E-4812D15	36-75	20	363	±12	0	±625	88	±470
V7E-4815D15	36-75	20	363	±15	0	±500	88	±330

Suffix "H" means 3.5KVdc isolation

### NOTE

- Load regulation for dual output: minimum load to full load balanced on all outputs.
- One load is 25% to 100% load, the other load is 100% load, the output voltage variable rate is within ±5%.
- Measured with 20MHz bandwidth and 1.0uF ceramic capacitor.
- Tested by minimal Vin and constant resistive load.
- Tested by normal Vin and 25% load step change ( 75%-50%-25% of Io ).
- Measured Input reflected ripple current with a simulated source inductance of 12uH.
- To order the converter with CTRL function, please add suffix C ( e.g. V7E-4812S10C ).
- Input filter components (C1, L, C2) are used to help meet conducted emissions requirement for the module. These components should be mounted as close as possible to the module; and all leads should be minimized to decrease radiated noise.
- An external filter capacitor is required if the module has to meet IEC61000-4-4 and IEC61000-4-5.  
The filter capacitor Motien suggest: Nippon chemi-con KY series, 220uF/100V.
- Exceeding the absolute ratings of the unit could cause damage. It is not allowed for continuous operating.

The models listed above is just for standard type. If you need the special specification product, please contact our service member by telephone presented in shortform cover or e-mail to : sales@motien.com.tw

**TEST CONFIGURATIONS**

**Input Reflected Ripple Current Test Step**

Input reflected ripple current is measured through a source inductor  $L_{in}$ (12uH) and a source capacitor  $C_{in}$ (47uF, ESR<1.0Ω at 100KHz) at nominal input and full load.

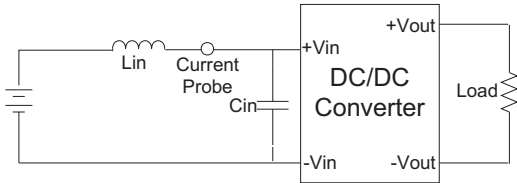

**EMI Filter**

Input filter components ( $C1, L, C2$ ) are used to help meet conducted emissions requirement for the module. These components should be mounted as close as possible to the module; and all leads should be minimized to decrease radiated noise.

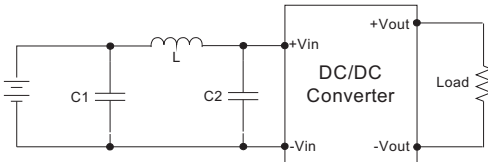

	C1	L	C2
V7E-12XXXXXX	330uF/100V	12uH	100uF/100V
V7E-24XXXXXX	330uF/100V	12uH	100uF/100V
V7E-48XXXXXX	330uF/100V	12uH	100uF/100V

**Output Ripple & Noise Measurement Test**

Use a capacitor  $C_{out}$ (1.0uF) measurement. The Scope measurement bandwidth is 0-20MHz.

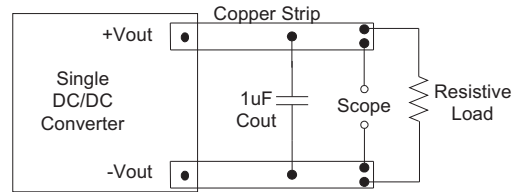

**MECHANICAL SPECIFICATIONS**

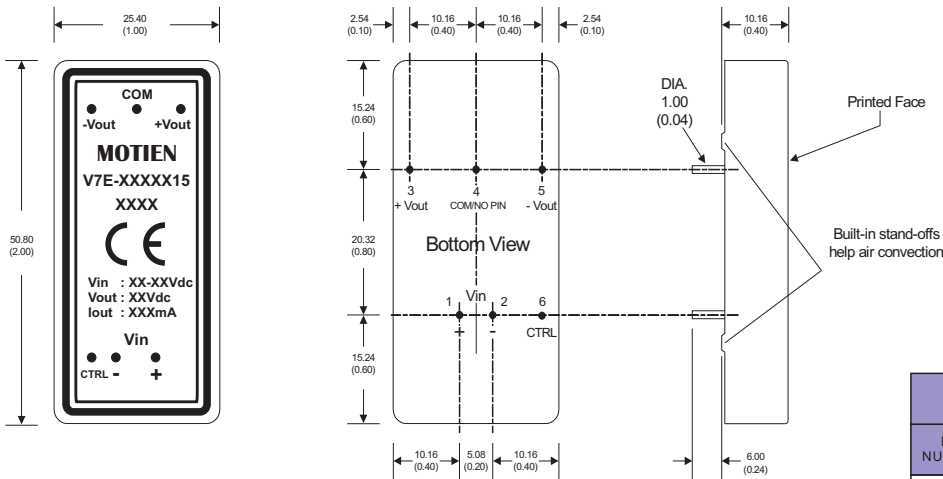

- All dimensions are typical in millimeters ( inches ).
1. Pin diameter:  $1.0 \pm 0.05$  (  $0.04 \pm 0.002$  )
  2. Pin pitch and length tolerance:  $\pm 0.35$  (  $\pm 0.014$  )
  3. Case Tolerance:  $\pm 0.5$  (  $\pm 0.02$  )

PIN NUMBER	Standard		Remote Control(optional)	
	SINGLE	DUAL	SINGLE	DUAL
1	+V Input	+V Input	+V Input	+V Input
2	-V Input	-V Input	-V Input	-V Input
3	+V Output	+V Output	+V Output	+V Output
4	N.P.	Common	N.P.	Common
5	-V Output	-V Output	-V Output	-V Output
6	N.P.	N.P.	CTRL	CTRL

(The Pin Connection of high isolation one is the same with normal one.)

**MECHANICAL SPECIFICATIONS**

**With Heat-sink**

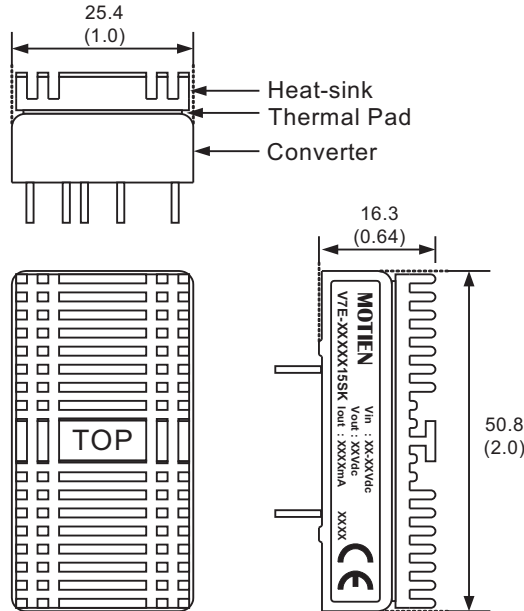

Order code: V7E-XXXXS15SK(contain: heat-sink, thermal pad)  
 Material: Aluminum  
 Finish: Anodic treatment (black)  
 Weight: 11.2 g (0.39oz) (without converter)

Note:  
 1. Converters will be supplied with heat-sinks already mounted.  
 Please contact factory for quotation.