

Super Fast Recovery Diode, 200A

Features

- Dual Diode Construction
- Low Leakage Current
- Low forward voltage drop
- High surge current capability
- Super Fast Switching

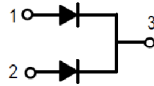

TWIN TOWER PACKAGE

Maximum Ratings ($T_J = 25^\circ\text{C}$ unless otherwise specified)						
Parameter	Symbol	Conditions	MUR20005CT(R)	MUR20010CT(R)	MUR20020CT(R)	Units
Repetitive peak reverse voltage	V_{RRM}		50	100	200	V
RMS reverse voltage	V_{RMS}		35	70	140	V
DC blocking voltage	V_{DC}		50	100	200	V
Average forward current	$I_{F(AV)}$	$T_C \leq 140^\circ\text{C}$	200	200	200	A
Non-repetitive forward surge current, half sine-wave	I_{FSM}	$T_C = 25^\circ\text{C}$	800	800	800	A

Electrical Characteristics ($T_J = 25^\circ\text{C}$ unless otherwise specified)						
Parameter	Symbol	Conditions	MUR20005CT(R)	MUR20010CT(R)	MUR20020CT(R)	Units
DC forward voltage	V_F	$I_F = 50\text{ A}$ $T_J = 25^\circ\text{C}$	1.3	1.3	1.3	V
DC reverse current	I_R	$V_R = 50\text{ V}$ $T_J = 25^\circ\text{C}$	25	25	25	μA
		$V_R = 50\text{ V}$ $T_J = 125^\circ\text{C}$	1	1	1	mA
Maximum Reverse Recovery Time	t_{rr}	$I_F = 0.5\text{ A}$ $I_R = 1.0\text{ A}$ $I_{RR} = 0.25\text{ A}$	75	75	75	nS

Thermal Characteristics ($T_J = 25^\circ\text{C}$ unless otherwise specified)						
Parameter	Symbol		MUR20005CT(R)	MUR20010CT(R)	MUR20020CT(R)	Units
Thermal resistance junction to case	R_{thj-c}		1.0	1.0	1.0	$^\circ\text{C/W}$
Operating, storage temperature range	T_J, T_{stg}		- 40 to +175	- 40 to +175	- 40 to +175	$^\circ\text{C}$



Package Outline

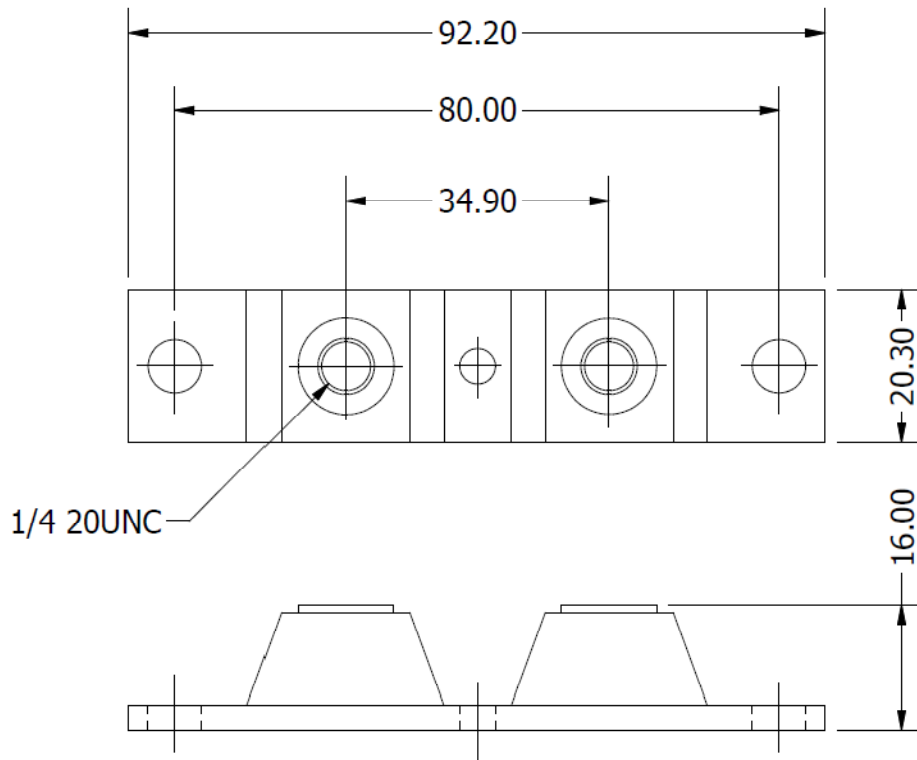

ALL DIMENSIONS IN MM

Ordering Table

MUR	200	05	CT
1	2	3	4

- 1 – Device Type
 - > MUR = Dual Diode Recovery Module
- 2 – Current Rating = $I_{F(AV)}$
- 3 – Voltage = code x 10 = V_{RRM}
- 4 – Polarity
 - > CT = Normal (Cathode to Base)
 - > CTR = Reverse (Anode to Base)