

Diode-Diode Module, 100 Amps

Features

- Improved glass passivation for high reliability
- Exceptional stability at high temperatures
- High di/dt and dv/dt capabilities
- Low thermal resistance



Voltage Ratings ($T_A = 25^\circ\text{C}$, unless otherwise noted)					
Type number	Voltage Code	V_{RRM} , Maximum repetitive peak reverse voltage (V)	V_{RSM} , Maximum non-repetitive peak reverse voltage (V)	V_{DRM} , Maximum repetitive peak off-state voltage (V)	I_{RRM} , Maximum reverse leakage current @ T_{JMAX} (mA)
NDD100	60	600	700	600	max. 5
	80	800	900	800	
	100	1000	1100	1000	
	120	1200	1300	1200	
	140	1400	1500	1400	
	160	1600	1700	1600	
	180	1800	1900	1800	

Electrical Characteristics ($T_A = 25^\circ\text{C}$ unless otherwise noted)			
Parameter	Symbol	Values	Units
Maximum average forward current @ $T_J = 85^\circ\text{C}$	$I_{F(AV)}$	100	A
Maximum average RMS forward current	$I_{F(RMS)}$	157	A
Maximum non-repetitive surge current	I_{FSM}	2500	A
Maximum I^2t for fusing	I^2t	31250	A^2s
Forward voltage drop	V_{FM}	max. 1.35	V
Isolation voltage	V_{ISO}	3000	V

Thermal & Mechanical Specifications ($T_A = 25^\circ\text{C}$ unless otherwise noted)			
Parameter	Symbol	Values	Units
Operating junction temperature range	T_J	-40 to +125	$^\circ\text{C}$
Storage temperature	T_{stg}	-40 to +125	$^\circ\text{C}$
Thermal resistance, junction to case	$R_{th(JC)}$	0.35	$^\circ\text{C/W}$
Mounting torque	to heatsink	F	Nm
	to terminals		
Weight	W	100	g

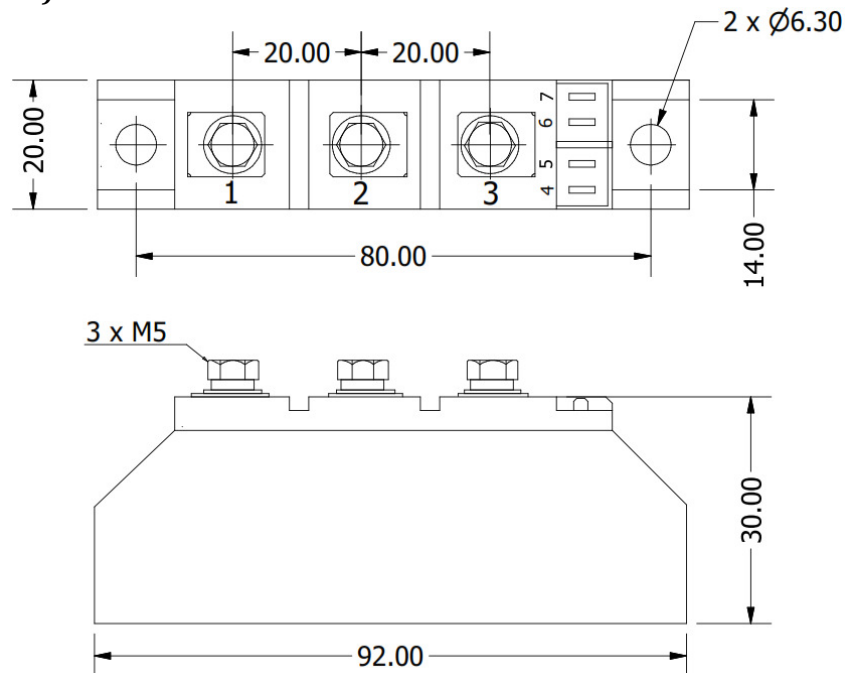
Package Outline
(All dimensions in mm)

Circuit Configuration

Circuit Description	Configuration Code	Circuit Drawing
Series Connection (doubler circuit)	N	
Common Anode	A	
Common Cathode	K	



Ordering Table

<i>NDD</i>	<i>100</i>	<i>N</i>	<i>160</i>
1	2	3	4

1 – Power Module

- > DD = Diode-Diode
- > TD = Thyristor-Diode
- > TT = Thyristor-Thyristor

2 – Current Rating = $I_{F(AV)}$

3 – Circuit Configuration (see Table)

4 – Voltage Code (see Voltage Ratings table)