

# zSeries-VI Wireless Sensor System

zED-VI-P, zED-VI-LCD, zED-VI-LCD-AA, zED-VI-DC-H2,  
zED-VI-LCD-DC-H2, zED-VI-CCELL, and zCDR-VI  
Operator's Manual

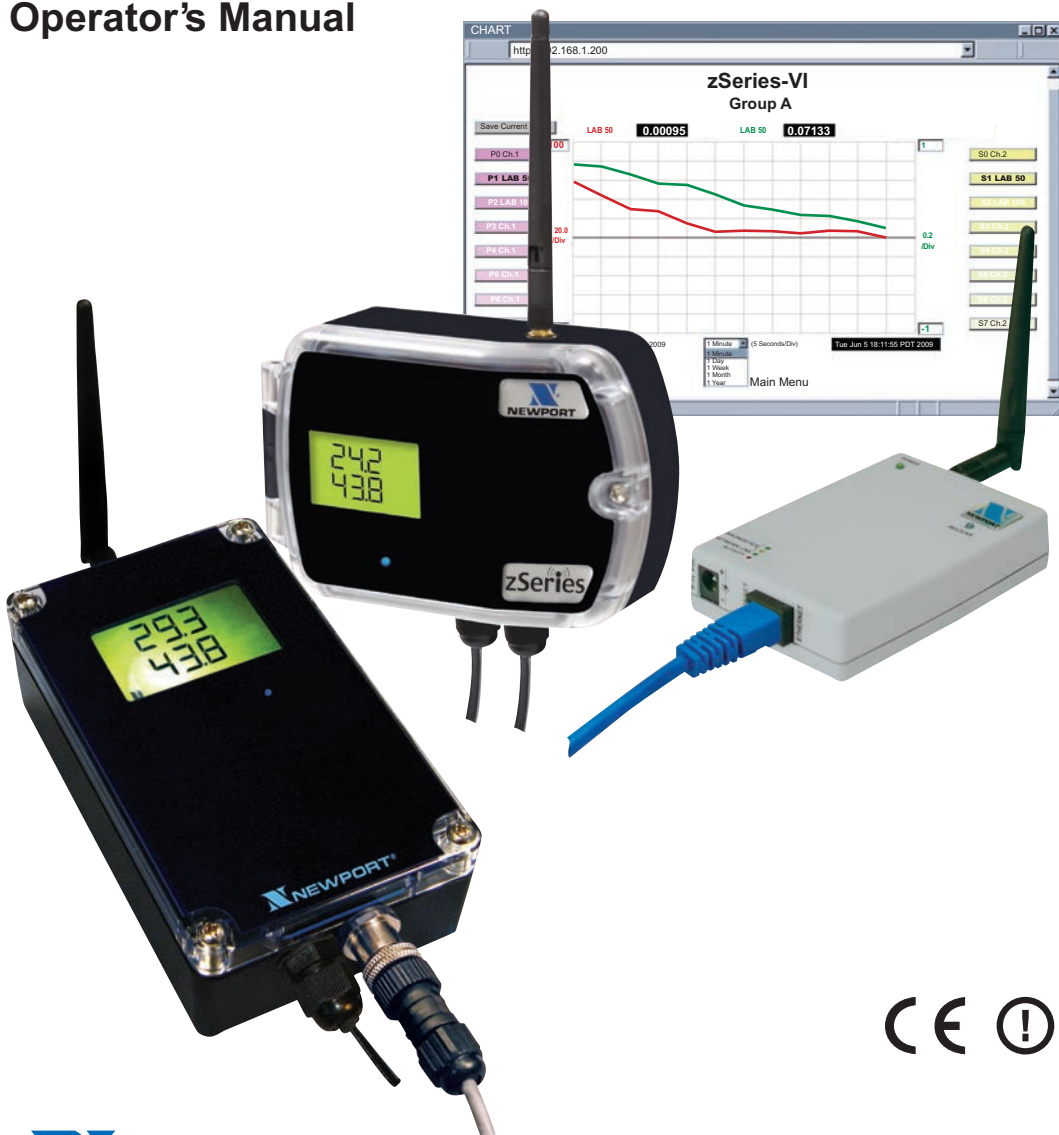

 **NEWPORT** Electronics, Inc.  
<http://www.newportUS.com/manuals>



Additional products from

**NEWPORT** Electronics, Inc.

Counters	Rate Meters
Frequency Meters	Timers
PID Controllers	Totalizers
Clock/Timers	Strain Gauge Meters
Printers	Voltmeters
Process Meters	Multimeters
On/Off Controllers	Soldering Iron Testers
Recorders	pH pens
Relative Humidity	pH Controllers
Transmitters	pH Electrodes
Thermocouples	RTDs
Thermistors	Thermowells
Wire	Flow Sensors
Wireless	

For Immediate Assistance  
In the U.S.A. and Canada: 1-800-NEWPORT<sup>®</sup>  
In Mexico: (95) 800-NEWPORT<sup>SM</sup>  
Or call your local NEWPORT Office.

**NEWPORTnet<sup>SM</sup> On-Line Service**  
[www.newportUS.com](http://www.newportUS.com)

**Internet e-mail**  
[info@newportUS.com](mailto:info@newportUS.com)

It is the policy of NEWPORT to comply with all worldwide safety and EMC/EMI regulations that apply. NEWPORT is constantly pursuing certification of its products to the European New Approach Directives. NEWPORT will add the CE mark to every appropriate device upon certification.

The information contained in this document is believed to be correct but NEWPORT Electronics, Inc. accepts no liability for any errors it contains, and reserves the right to alter specifications without notice.

**WARNING:** These products are not designed for use in, and should not be used for, patient connected applications.

**TRADEMARK NOTICE:** , **NEWPORT<sup>®</sup>**, **NEWPORT<sup>®</sup>** and **newportUS.com** are trademarks of NEWPORT Electronics, Inc.

**PATENT NOTICE:** This product is covered by one or more of the following patents: U.S. Pat. No. Des. 336,895; 5,274,577/ CANADA 2052599; 2052600/ ITALY 1249456; 1250938 / FRANCE BREVET No. 91 12756 / SPAIN 2039150; 2048066 / UK PATENT No. GB2 249 837; GB2 248 954 / GERMANY DE 41 34398 C2. The  is a Trademark of OMEGA Engineering, Inc. Used Under License. Other US and International Patents pending or applied for.



This device is marked with the international caution symbol. It is important to read the Setup Guide before installing or commissioning this device as it contains important information relating to safety and EMC.

# TABLE OF CONTENTS

## Part 1: Introduction

1.1	Safety and EMC Considerations .....	2
1.2	Before You Begin.....	2
1.3	Description.....	2

## Part 2: Hardware

2.1a	Parts of the End Device - zED-P/-LCD .....	5
2.1b	Parts of the End Device - zED-CCELL .....	6
2.1c	Parts of the End Device - zED-DC-H2 .....	7
2.2	Dimensions and Mounting - End Device .....	8
2.3a	Disassembly - End Device - zED-P/-LCD.....	9
2.3b	Disassembly - End Device - zED-AA/-LCD-AA .....	10
2.3c	Disassembly - End Device - zED-CCELL .....	11
2.3d	Disassembly - End Device - zED-DC-H2.....	12
2.4	Parts of the Coordinator .....	13
2.5	Dimensions and Mounting - Coordinator.....	14
2.6	DIP Switches .....	15
2.6.1	DIP Switch Setup: Device ID (DID) .....	15
2.6.2	DIP Switch Setup: Network ID (NID) .....	17
2.6.3	DIP Switch Setup: Ethernet - Coordinator .....	18
2.7	Network Communication Interfaces .....	18
2.7.1	10Base-T RJ-45 Pinout.....	18
2.7.2	10Base-T Crossover Wiring.....	19
2.8	Analog Wiring .....	19

## Part 3: Network Configuration

3.1	Ethernet (MAC) Address .....	20
3.2	Network Protocols .....	20
3.3	DHCP .....	20
3.4	DNS .....	21
3.5	IP Address .....	21
3.5.1	Default IP Address .....	21
3.5.2	Changing TCP/IP Properties on Your Computer.....	22

## Part 4: Operations

4.0	Testing the Connection.....	23
4.1	iConnect Software .....	24
4.2	Setting a new IP Address over the Network .....	26
4.3	Coordinator's Configurations and Operations .....	27
4.3.1	Power Up Device .....	28
4.3.2	Get Readings from the End Device .....	29
4.3.3	Java Runtime Environment Setup .....	31
4.3.3.1	Java Runtime Environment 1.7 Setup Instructions.....	31
4.3.3.3	Browser Proxy Selection .....	32

# TABLE OF CONTENTS

(continued)

4.3.4	Chart .....	33
4.3.5	Diagnostic .....	35
4.3.6	Configuration .....	36
4.3.7	Sensor Setup.....	37
4.3.7.1	Sensor Setup Parameters.....	38
4.3.8	Access Control .....	40
4.4	Telnet Setup .....	41
4.5	HTTPget Program .....	41
4.5.1	HTTPget using Port 2000.....	42
4.5.2	HTTPget and ARP to Setup Device IP Address .....	43
4.6	ARP Protocol .....	43
4.7	iLog Software.....	45
4.8	Mail Notifier Software.....	47
4.8.1	Installation.....	47
4.8.2	Program Options Setup and Configuration .....	48
4.8.3	Device Setting Setup and Configuration .....	49
4.8.4	Sending Text Messages to a Cell Phone .....	50
Part 5: Environment / Operating Conditions .....		51
5.1	General Deployment Guidelines .....	51
5.2	With Line-of-Sight .....	53
5.3	Without Line-of-Sight .....	54
5.4	Casing and Closure Around the Antenna .....	54
5.5	Fine Adjustment in Performance .....	55
Part 6: Specifications .....		56
Part 7: Factory Preset Values .....		60
Appendix A	Glossary .....	61
Appendix B	IP Address .....	62
Appendix C	IP Netmask .....	63
Appendix D	ASCII Chart .....	64
	ASCII Chart Control Codes .....	65
Appendix E	iLog Error Messages.....	66
Appendix F	ASCII / Telnet Commands Table.....	67
Appendix G	Frequently Asked Questions (FAQ).....	69
Appendix H	Warnings and Regulatory Information .....	71

## LIST OF FIGURES:

Figure 1.1	zSeries-VI Wireless System on the Ethernet Network	4
Figure 2.1a	Parts of the End Device - zED-P/-LCD	5
Figure 2.1b	Parts of the End Device - zED-CCELL	6
Figure 2.1c	Parts of the End Device - zED-DC-H2	7
Figure 2.2	Mounting the End Device	8
Figure 2.3a	Disassembly of the End Device - zED-P/-LCD	9
Figure 2.3b	Disassembly of the End Device - zED-AA/-LCD-AA	10
Figure 2.3c	Disassembly of the End Device - zED-CCELL	11
Figure 2.3d	Disassembly of the End Device - zED-DCELL	12
Figure 2.4	Parts of the Coordinator	13
Figure 2.5	Mounting the Coordinator	14
Figure 2.6	Device ID (DID) - 8 Position DIP Switch Setup	15
Figure 2.7	Network ID (NID) - 8 Position DIP Switch Setup	17
Figure 2.8	Ethernet - 4 Position DIP Switch Setup	18
Figure 2.9	RJ45 Pinout	18
Figure 2.10	10Base-T Crossover Cable Wiring	19
Figure 2.11	Analog Wiring	19
Figure 3.1	4 Position DIP Switch on Bottom Side of Coordinator	20
Figure 3.2	Network Connections	22
Figure 3.3	Network Connections	22
Figure 4.1	Pinging the Coordinator from MS-DOS Prompt	23
Figure 4.2	Assigning an IP Address using iConnect	24
Figure 4.3	Accessing the zSeries-VI System for Configuration	25
Figure 4.4	Access Control	26
Figure 4.5	Home Page Menu	27
Figure 4.6	Login and Administrator Password	27
Figure 4.7	Select Readings by Group	29
Figure 4.8	Readings	29
Figure 4.9	Comma Separated Value Format	30
Figure 4.10	Java 1.7 Screen Shot	31
Figure 4.11	Select Chart by Group	33
Figure 4.12	Chart - End Device #1 LAB 50	33
Figure 4.13	Diagnostic	35
Figure 4.14	Configuration	36
Figure 4.15	Sensor Setup by Group	37
Figure 4.16	Sensor Setup	38
Figure 4.17	Sensor Parameters	39
Figure 4.18	Access Control	40
Figure 4.19	HTTPget Example of Polling End Device #1, 2, 3, 4	42
Figure 4.20	ARP Commands and Responses	44
Figure 4.21	iLog Software Logging Data for End Device #1, 3, 4	45
Figure 4.22	Mail Notifier Main Window	47
Figure 4.23	Mail Notifier Profile Setup	48

## **LIST OF FIGURES:**

(continued)

<b>Figure 4.24</b>	<b>Mail Notifier Device Setting .....</b>	<b>50</b>
<b>Figure 5.1</b>	<b>Operation in Buildings .....</b>	<b>52</b>
<b>Figure 5.2</b>	<b>Fresnel Zone .....</b>	<b>53</b>
<b>Figure 5.3</b>	<b>Materials in Buildings .....</b>	<b>54</b>
<b>Figure 5.4</b>	<b>Channels .....</b>	<b>55</b>

## **LIST OF TABLES:**

<b>Table 4.1</b>	<b>iLog Excel Applications .....</b>	<b>46</b>
<b>Table 4.2</b>	<b>Mail Notfier Commands .....</b>	<b>49</b>
<b>Table 6.1</b>	<b>Estimated Battery Life .....</b>	<b>57</b>

## NOTES, WARNINGS and CAUTIONS

Information that is especially important to note is identified by the following labels:

- **NOTE**
- **WARNING or CAUTION**
- **IMPORTANT**
- **TIP**

**Note** E31

**NOTE:** Provides you with information that is important to successfully setup and use the zSeries-VI Analog Input Wireless System.



**CAUTION or WARNING:** Tells you about the risk of electrical shock.



**CAUTION, WARNING or IMPORTANT:** Tells you of circumstances or practices that can affect the instrument's functionality and must refer to accompanying documents.

**Tip** E31

**TIP:** Provides you helpful hints.

---

## FEATURES

- ✓ **Web Server**
- ✓ **Email Alarms**
- ✓  **$\pm 100\text{mV}$ ,  $\pm 1\text{V}$ ,  $\pm 10\text{V}$  Scalable Voltage Inputs**
- ✓  **$\pm 20\text{mA}$  Scalable Current Input**
- ✓ **No Special Software Required**

## **PART 1 INTRODUCTION**

### **1.1 Safety and EMC Considerations**

Refer to the Environment/Operating Conditions Section.



**Warning:** the following parts of the unit are ESD sensitive:

- Plastic connector of the antenna
- LCD display
- Metal connectors for power

#### **EMC Considerations**

- Whenever EMC is an issue, always use shielded cables.
- Never run signal and power wires in the same conduit.
- Use twisted-pair wires for signal connections.
- Install Ferrite Bead(s) on signal wires close to the instrument if EMC problems persist.

**Failure to follow all instructions and warnings may result in injury!**

### **1.2 Before You Begin**

**Inspecting Your Shipment:** Remove the packing slip and verify that you have received everything listed. Inspect the container and equipment for signs of damage as soon as you receive the shipment. Note any evidence of rough handling in transit. Immediately report any damage to the shipping agent. The carrier will not honor damage claims unless all shipping material is saved for inspection. After examining and removing the contents, save the packing material and carton in the event reshipment is necessary.

**Customer Service:** If you need assistance, please contact the Customer Service Department nearest you.

**Manuals, Software:** The latest Operation Manual as well as free configuration software (**iConnect**), data-logging software (**iLog**) and **Mail Notifier** are available at **the website listed on the cover page of this manual** or on the CD-ROM enclosed with your shipment.

### **1.3 Description**

The rugged, high-performance, high power zSeries-VI wireless sensor/transmitter system provides Web-based monitoring of a broad range of voltage and current measurements.

The high power End Devices run on either AC power, low voltage power, or batteries. The AC version (zED-P, zED-LCD) is powered by a 5 Vdc universal AC power adapter that operates on any voltage worldwide (110 to 240 Vac). Should AC power fail, the unit can operate on a 3.6V ultra-long-life lithium back-up battery (included).

A low power option (zED-DC) operates at 10 to 30 Vdc, or 24 Vac.

A completely wireless End Devices are powered by two AA (zED-LCD-AA) or two C-cell (zED-CCELL) alkaline batteries. These End Devices can operate for weeks, months, or years before changing the batteries. Battery life depends on the type of sensor and other user settings such as the frequency of transmission.

Each End Device supports two channels of differential, bipolar analog signals. Input types including  $\pm 0$  to 100mV,  $\pm 0$  to 1V,  $\pm 0$  to 10V and  $\pm 0$  to 20mA can be selected from the web page and readings are fully scalable to virtually any engineering unit.

The End Devices can be installed in clean rooms, laboratories, museums, computer server rooms, warehouses, and any remote facility. The high power End Devices transmit up to 3280 feet/1000m without obstructions or interference, to a "Coordinator" connected directly to an Ethernet network and the Internet.



### 1.3 Description (continued)

The wireless system complies with IEEE 802.15.4 operating at 2.4 GHz and the user can switch to different communication channels to avoid interference with other wireless technologies (e.g. Wi-Fi).

To achieve robust and reliable wireless communication, End Devices retransmit data adaptively to the environment so that power consumption is optimized in harsh conditions. The zSeries-VI wireless sensor system also provides error detection mechanism for inactive communication and diagnostic information including signal strength and data transmission success rate to help trouble shooting potential wireless system installation issues.

Each zSeries-VI Coordinator can directly support up to thirty-two (32) End Devices and a maximum of 8 Coordinators can be setup in the vicinity. The Coordinators include AC adaptors to operate on any voltage worldwide from 100 to 240 Vac and 50 to 60 Hz. The Coordinator connects directly to an Ethernet Network or the Internet. Unlike an RS232 or USB device, it does not require a host computer.

The zSeries-VI system allows you to monitor and record voltage and current over an Ethernet network or the Internet without any special software-just your Web Browser.

The zSeries-VI Coordinator is an independent node on the network sending and receiving data in standard TCP/IP packets. It is easily configured from a Web Browser and can be password protected. From within an Ethernet LAN or over the Internet, the user simply types the IP address (such as 192.168.1.200) or an easy to remember name (such as "ServRoom" or "Chicago5") and the Coordinator serves a Web Page with the current readings.

The device can trigger an alarm if variables go above or below a set point that you determine. Your alarm can be sent by email to a single user or to a group distribution list, including text messages to Internet enabled cell phones and PDA's. The "Mail Notifier" software is free and easy to use program for this application.

The zSeries-VI wireless sensor system is easy to install, simple to operate, and features award-winning iServer technology with an Embedded Web Server that requires no special software.

The zSeries-VI system serves Active Web Pages to display real time readings and charts of analog signals. You can also log data in standard data formats for use in a spreadsheet or data acquisition program such as Excel or Visual Basic. iLog is a free and easy to use program for logging data to Excel.

The virtual chart viewed on the web page is a Java™ Applet that records a chart over the LAN or Internet in real time. With the zSeries-VI system there is no need to invest time and money learning a proprietary software program to log or chart the data.

Chart scales are fully adjustable on the fly. For example, the chart can display one minute, one hour, one day, one week, one month or one year. Analog signals can be charted across a large span such as -10 to 10V or within any narrow range such as -10mV to 10mV.

The OPC Server software makes it easy to integrate the zSeries-VI wireless sensor system with many popular Data Acquisition and Automation programs offered by Omega, Wonderware, iConics, Intellution, Rockwell Automation, and National Instruments, among others.

### 1.3 Description (continued)

The following example illustrates how you can hookup zSeries-VI wireless system to your network:

The zSeries-VI wireless system consists of a single **Coordinator** and one or more **End Devices**. End Devices will send data periodically to the Coordinator where it serves as a gateway between the users and the End Devices. The users can access the data through the Coordinator's web server and provided data acquisition software.

A standard web browser can be used to monitor and chart analog signals. The browser can also be used to configure the device's IP address, passwords for access and overall configuration parameters.

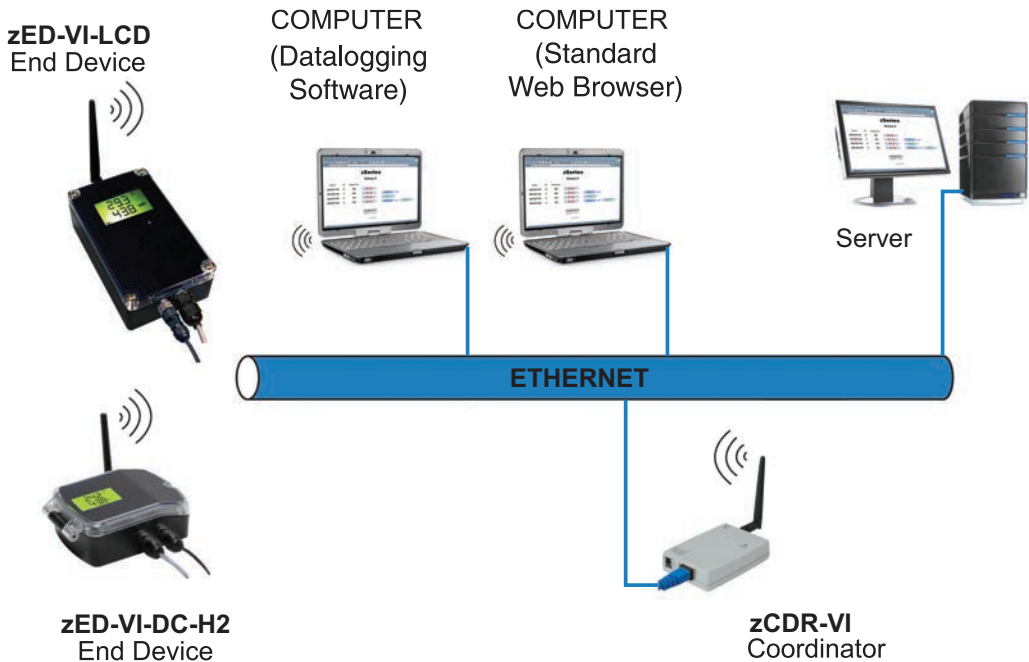
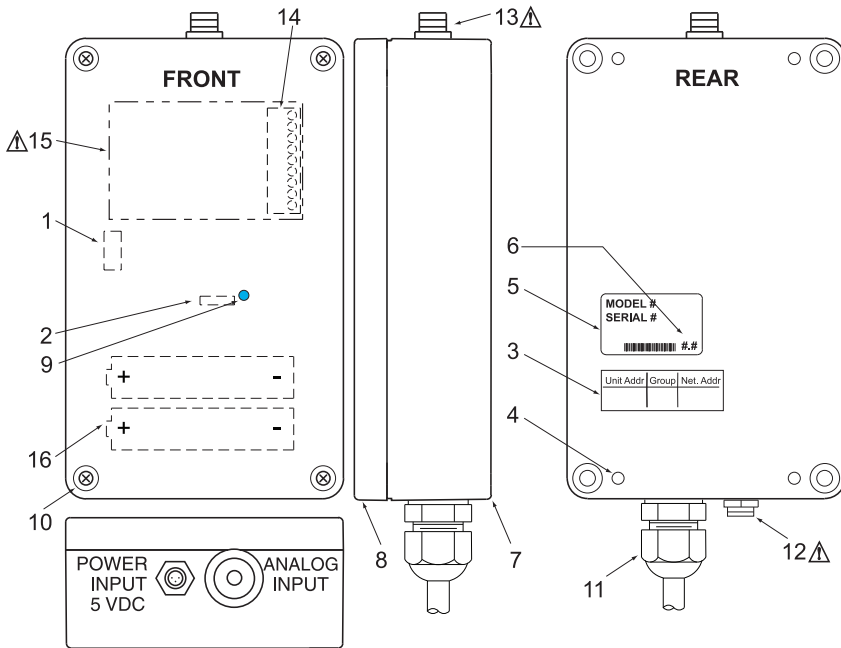

Figure 1.1 zSeries-VI Wireless System on the Ethernet Network

## PART 2 HARDWARE

### 2.1a Parts of the End Device (zED-P/-LCD/-AA)

**Warning:**  
the following parts are  
ESD sensitive.



1	8 position DIP switch (under cover), sets the NID and DID of the End Device (see <b>Section 2.6</b> for details)
2	Power Switch
3	Label for Unit Address, Group No. and Network ID Address (NID)
4	Wall mounting holes
5	Label with model and serial numbers
6	Radio module firmware revision location on label
7	Case's tray, where the PCB, sensor and batteries are mounted
8	Case's cover
9	Transmit LED (blue)
10	4 Screws attaching Cover
11	Analog signal inputs through 1 cable gland.
12	Power Input, through quick disconnect connector (for zED-P & zED-LCD)
13	Antenna Mount
14	Analog Input removable terminal block connector (under cover)
15	LCD Display (for zED-LCD & zED-LCD-AA)
16	Two AA alkaline batteries (for zED-LCD-AA) or one lithium back-up battery (for zED-P & zED-LCD) (located under cover)

**Figure 2.1a Parts of the End Device (zED-P/-LCD/-AA)**

## 2.1b Parts of the End Device (zED-CCELL)

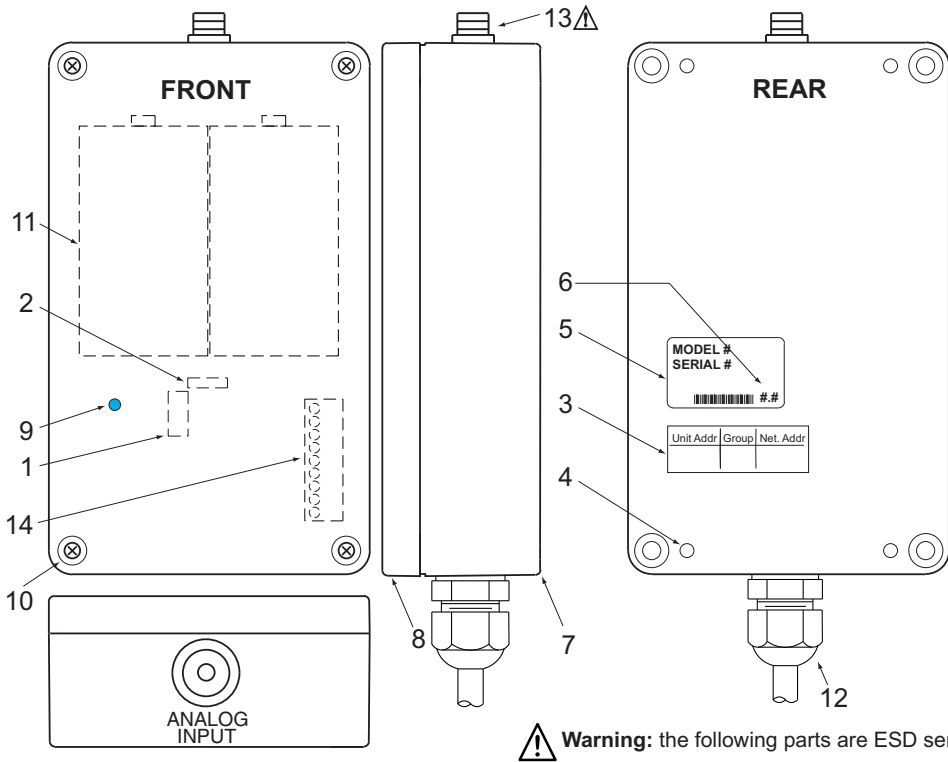

**Warning:** the following parts are ESD sensitive.

1	8 position DIP switch (under cover), sets the NID and DID of the End Device (see <b>Section 2.6</b> for details)
2	Power Switch (under cover)
3	Label for Unit Address, Group No. and Network ID Address (NID)
4	Wall mounting holes
5	Label with model and serial numbers
6	Radio module firmware revision location on label
7	Case's tray, where the PCB, sensor and batteries are mounted
8	Case's cover
9	Transmit LED (blue)
10	Four Screws attaching Cover
11	Two C-cell batteries (under cover)
12	Analog signal inputs through cable gland
13	Antenna Mount
14	Analog Input removable terminal block connector (under cover)

**Figure 2.1b Parts of the End Device (zED-CCELL)**

## 2.1c Parts of the End Device (zED-DC-H2)

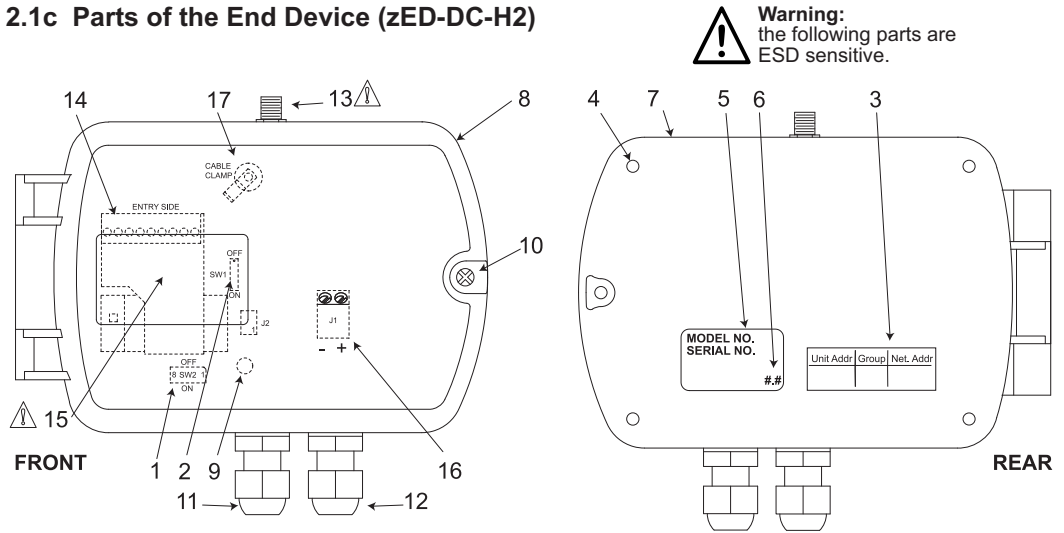

1	8 position DIP switch (under cover), sets the NID and DID of the End Device (see <b>Section 2.6</b> for details)
2	Power Switch
3	Label for Unit Address, Group No. and Network ID Address (NID)
4	Wall mounting holes
5	Label with model and serial numbers
6	Radio module firmware revision location on label
7	Case's tray, where the PCB is mounted
8	Case's cover
9	Transmit blue LED (under cover)
10	One Screw attaching Cover
11	Analog signal inputs through 1 cable gland
12	Low Power Input, through cable gland connector
13	Antenna Mount
14	Analog Input removable terminal block connector (under cover)
15	LCD Display (for units with -LCD option)
16	Low Power terminal block connector (under cover)
17	Cable Clamp for analog wiring (under cover)

**Figure 2.1c Parts of the End Device (zED-DC-H2)**

## 2.2 Dimensions and Mounting - End Device

Position unit where required. Mark and drill holes as required, using a #6 screw.

Attach antenna (refer to **Section 5** for Environmental/Operating Conditions) and attach power supply.

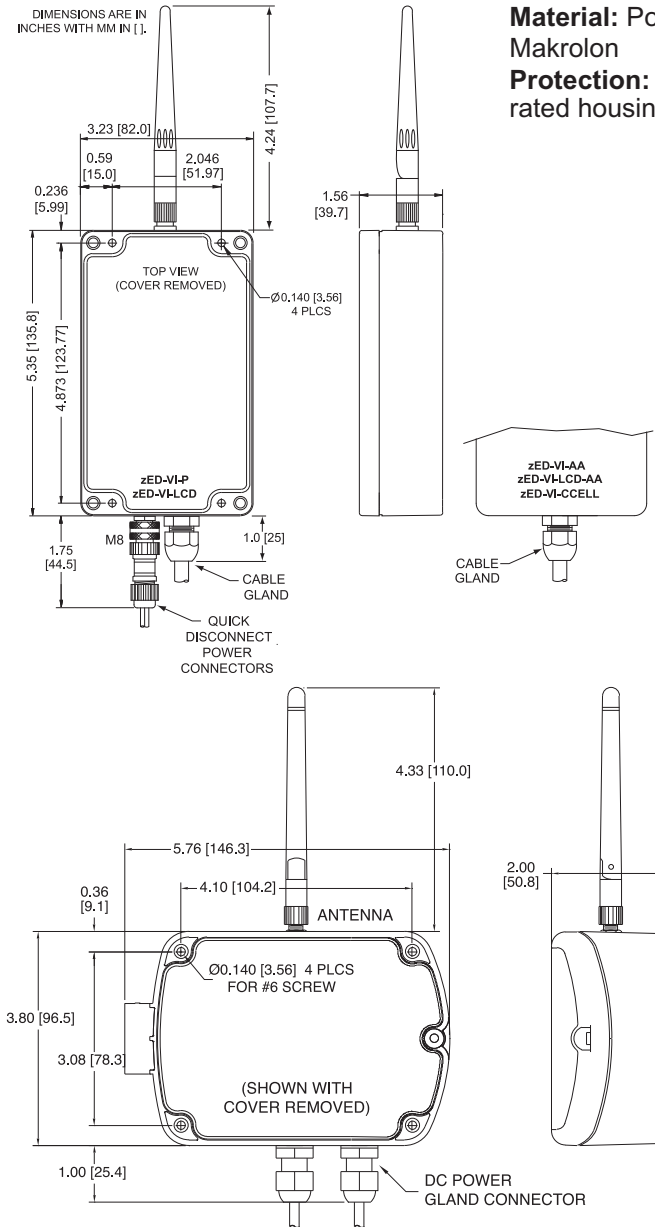

**Figure 2.2 Mounting the End Device**

### 2.3a Disassembly - End Device (zED-P / zED-LCD)

You may need to open the unit for one of the following reasons:

- To turn on Power Switch.
- To mount unit to wall. Refer to **Figure 2.2** for mounting dimensions.
- To connect or replace the 3.6 Vdc lithium back-up battery (note the polarity of battery).
- To access Analog Input Terminal Block Connector.
- To access programming connector.

Remove Cover as shown below, by removing the four (4) Cover Mounting Screws.

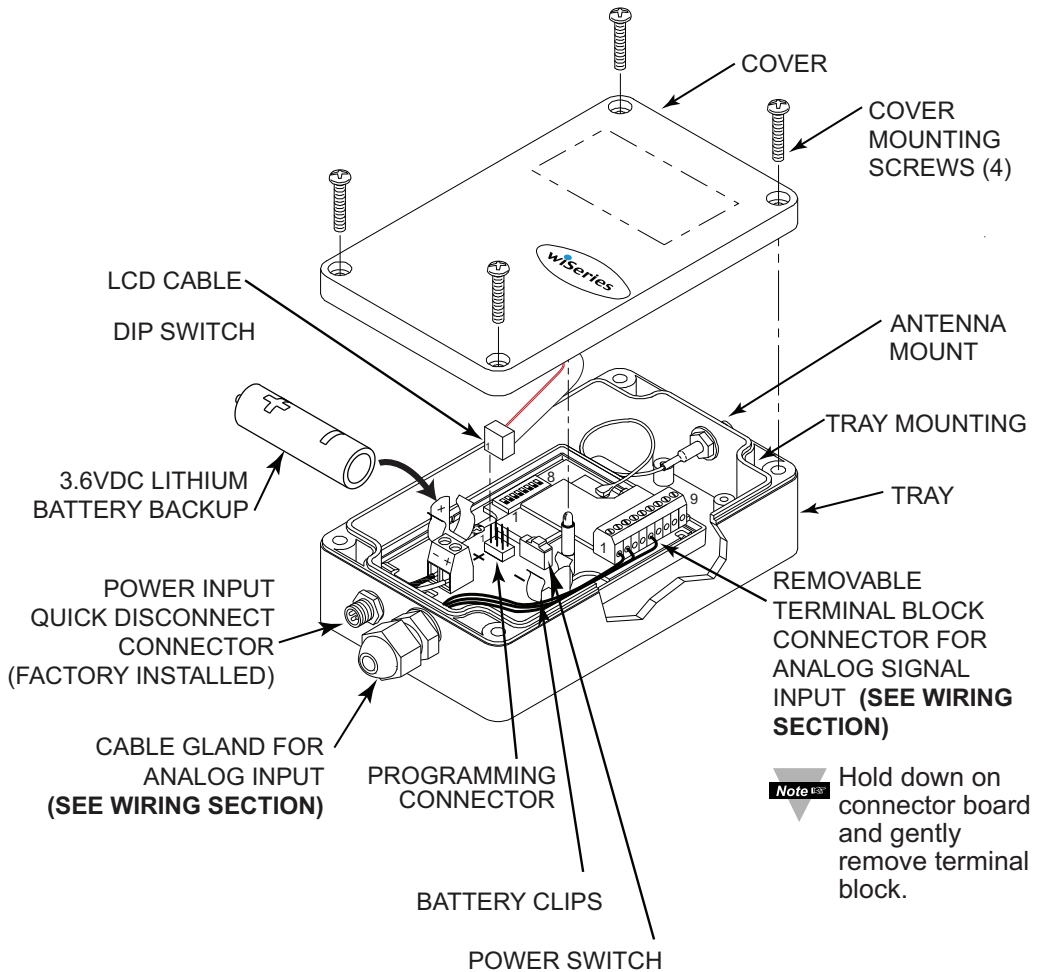

Figure 2.3a Disassembly of the End Device (zED-P / zED-LCD)

## 2.3b Disassembly - End Device (zED-LCD-AA)

You may need to open the unit for one of the following reasons:

- To turn on Power Switch.
- To mount unit to wall. Refer to **Figure 2.2** for mounting dimensions.
- To connect or replace the AA batteries (note the polarity of battery).
- To access Analog Input Terminal Block Connector.
- To access programming connector.

Remove Cover as shown below, by removing the four (4) Cover Mounting Screws.

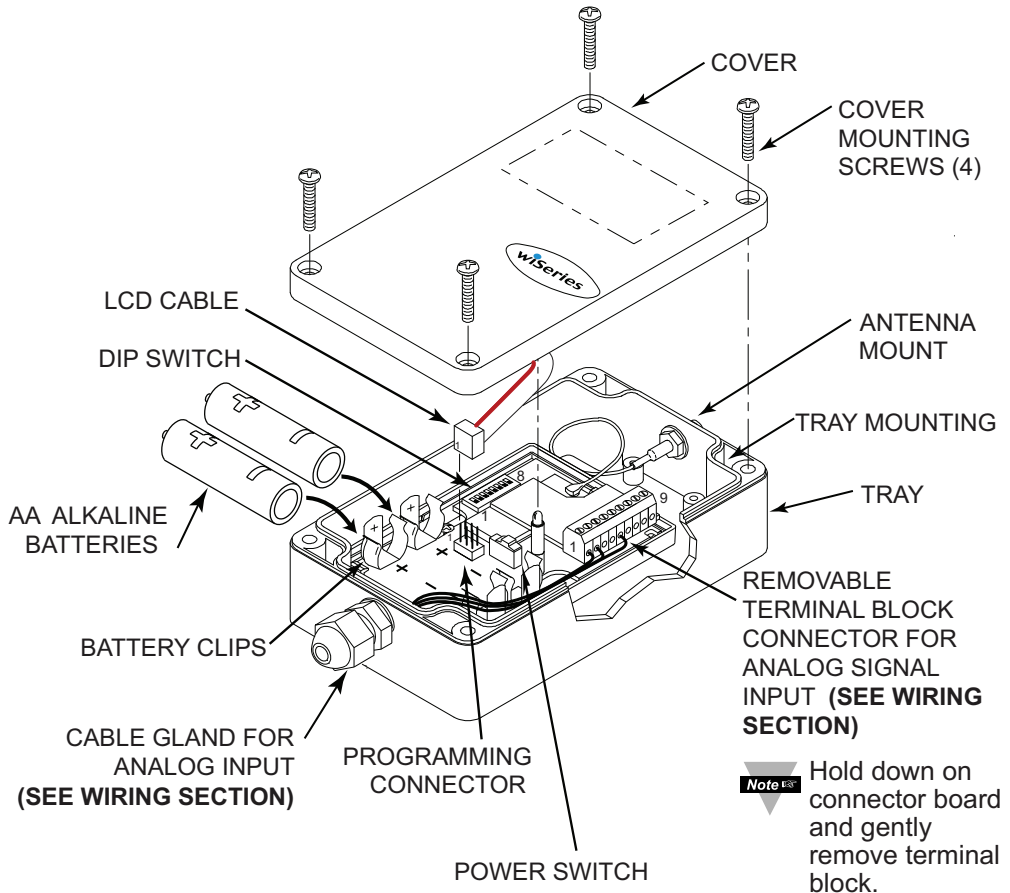

**Figure 2.3b Disassembly of the End Device (zED-LCD-AA)**



### 2.3c Disassembly - End Device (zED-CCELL)

You may need to open the unit for one of the following reasons:

- To turn on Power Switch.
- To mount unit to wall. Refer to **Figure 2.2** for mounting dimensions.
- To connect or replace the two C-cell alkaline batteries (note the polarity of batteries).
- To access Analog Input Terminal Block Connector.
- To access programming connector.

Remove Cover as shown below, by removing the four (4) Cover Mounting Screws.

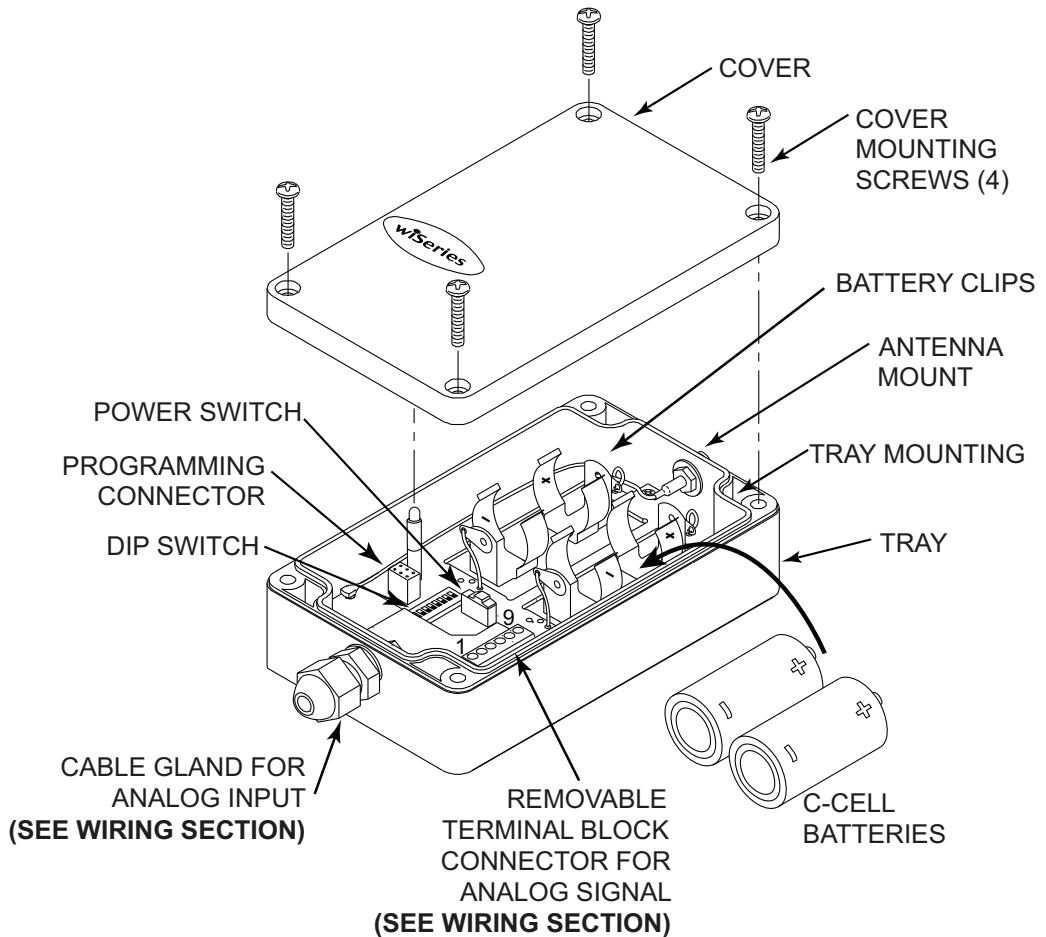

**Figure 2.3c Disassembly of the End Device (zED-CCELL)**

### 2.3d Disassembly - End Device (zED-DC-H2)

You may need to open the unit for one of the following reasons:

- To turn on Power Switch.
- To access 8 Position DIP Switch.
- To mount unit to wall. Refer to **Figure 2.2** for mounting dimensions.
- To access Analog Input Terminal Block Connector.
- To access Low Power Input Terminal Block Connector.
- To access programming connector.

Open Cover as shown below, by removing the Cover Mounting Screw.

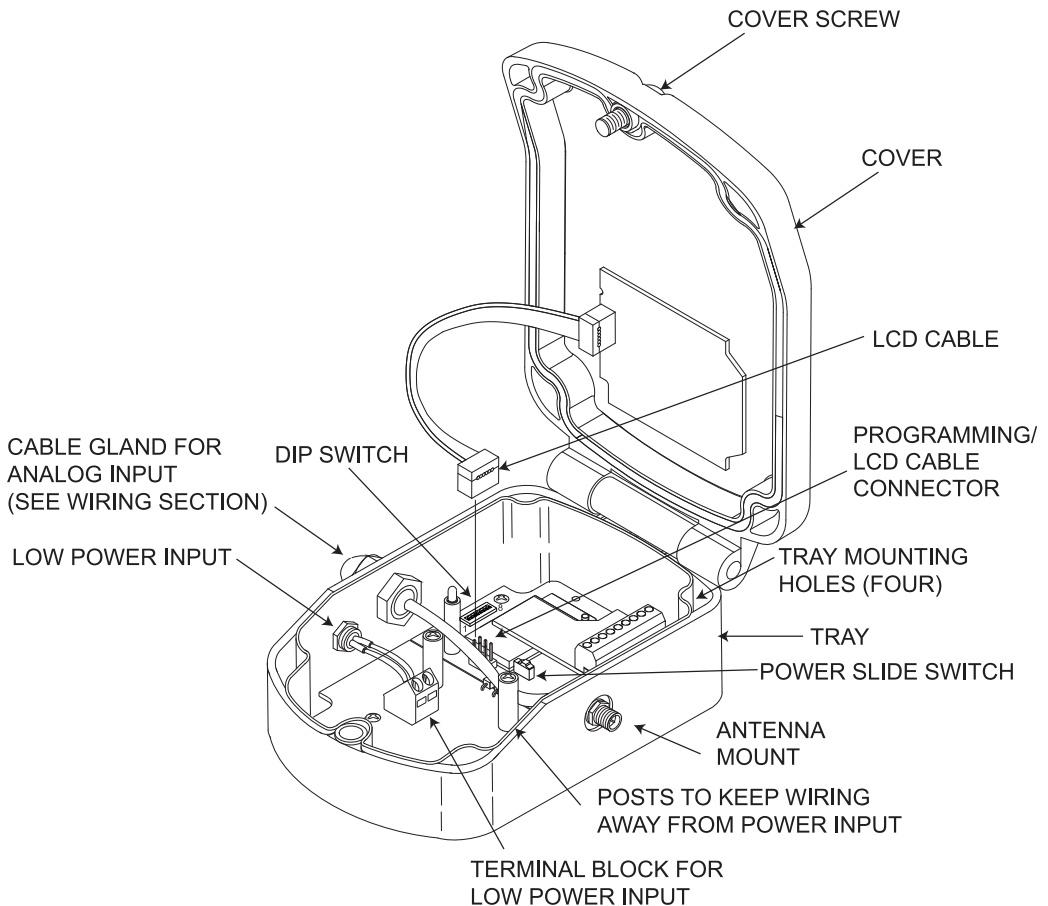

**Figure 2.3d Disassembly of the End Device (zED-DC-H2)**

## 2.4 Parts of the Coordinator

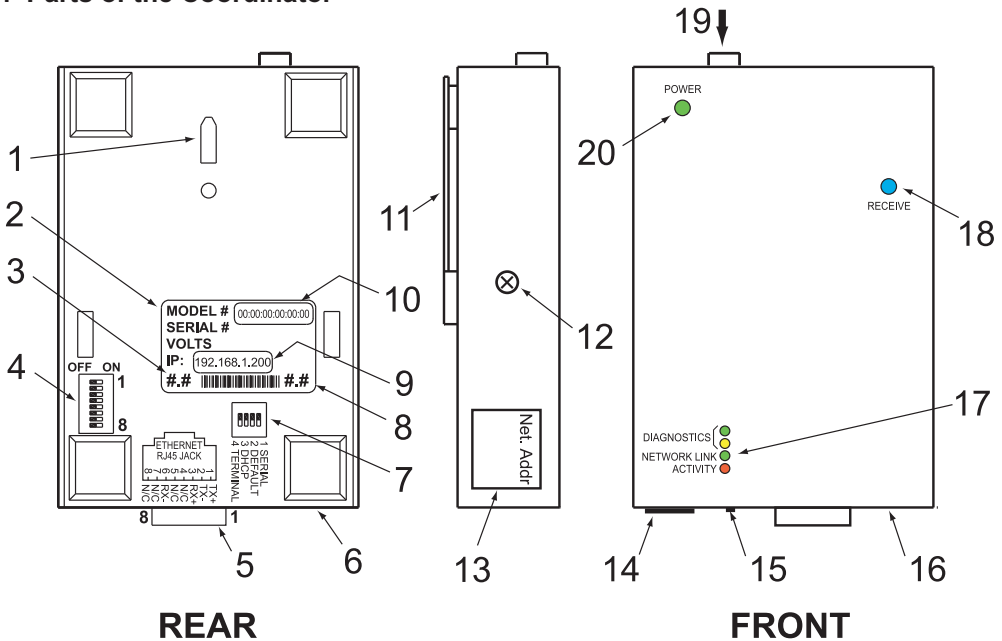

Figure 2.4 Parts of the Coordinator

1	Wall mounting bracket clip holes (3 places)
2	Label with model and serial numbers
3	Coordinator's firmware revision on label
4	8 position DIP switch, from which the last 3 positions are used to assign the NID, network ID number (see <b>Section 2.6</b> for details)
5	Ethernet: RJ45 interface for 10BASE-T connection.
6	Case's tray, where the PCB is mounted
7	4 position DIP switch, sets the DHCP and Factory Defaults
8	Coordinator's radio module firmware revision on label
9	Label with default IP address, remove and then write your IP address, in the space provided
10	Label with MAC address (in hex code)
11	Wall mounting bracket
12	Case's cover mounting screw (2 places)
13	Label for Network ID address (NID)
14	Power supply: Plus (+) power supply wire connection inside the plug; Minus (-) power supply wire connection outside the plug
15	Reset button: Used for power resetting the Ethernet board
16	Case's cover

## 2.4 Parts of the Coordinator (continued)

17	<p><u>Diagnostics LED</u>: (Yellow and Green) Diagnostics: at boot-up they light up for 2 seconds, then turn off; DHCP: if DHCP is enabled, they blink and stay solid periodically</p> <p><u>Network Link LED</u>: (Green) Solid: Indicates good network link.</p> <p><u>Activity LED</u>: (Red) Blinking: Indicates network activities (receiving or sending packets).</p>
18	Receive LED (blue) while blinking, the Coordinator looks for the clearest channel to communicate. Once it finds that channel, the light will change to solid.
19	Antenna connector
20	Power LED: (Green) Solid: Indicates Power-ON

## 2.5 Dimensions and Mounting - Coordinator

Position unit where required. Mark and drill the two screw holes. Once the bracket is mounted to the wall: align back of unit over the three bracket clips, when engaged, slide downward, the unit will snap in place.

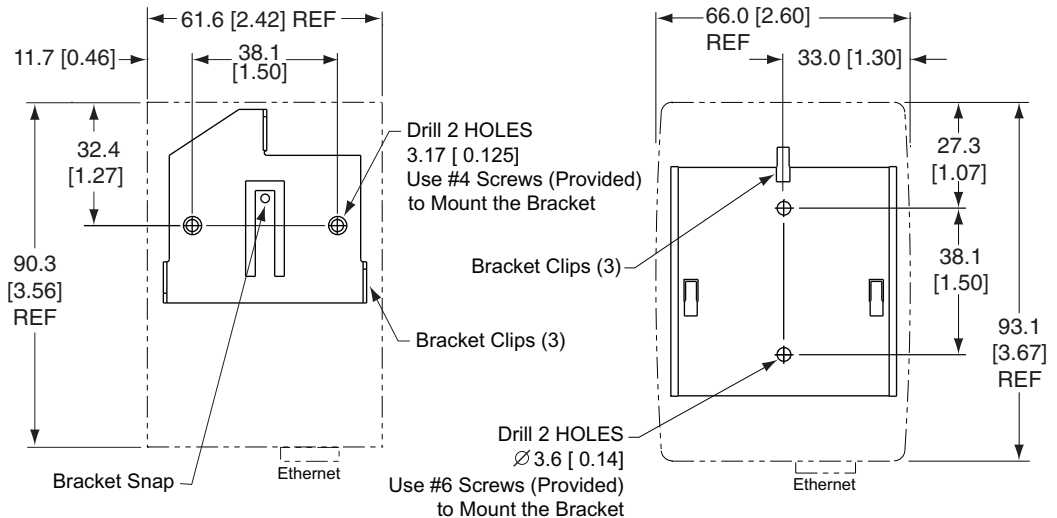

**Version A: Metal Enclosure**

**Version B: New Plastic Enclosure**

**Figure 2.5 Mounting the Coordinator**

Attach antenna (refer to **Section 5** for Environmental/Operating Conditions) and attach power supply.



If unit is to be mounted on a flat surface, you may take the bottom rubber feet off the unit.

## 2.6 DIP Switches

### 2.6.1 DIP Switch Setup: Device ID (DID)

The End Device is shipped with all DIP switches in the "OFF" position.

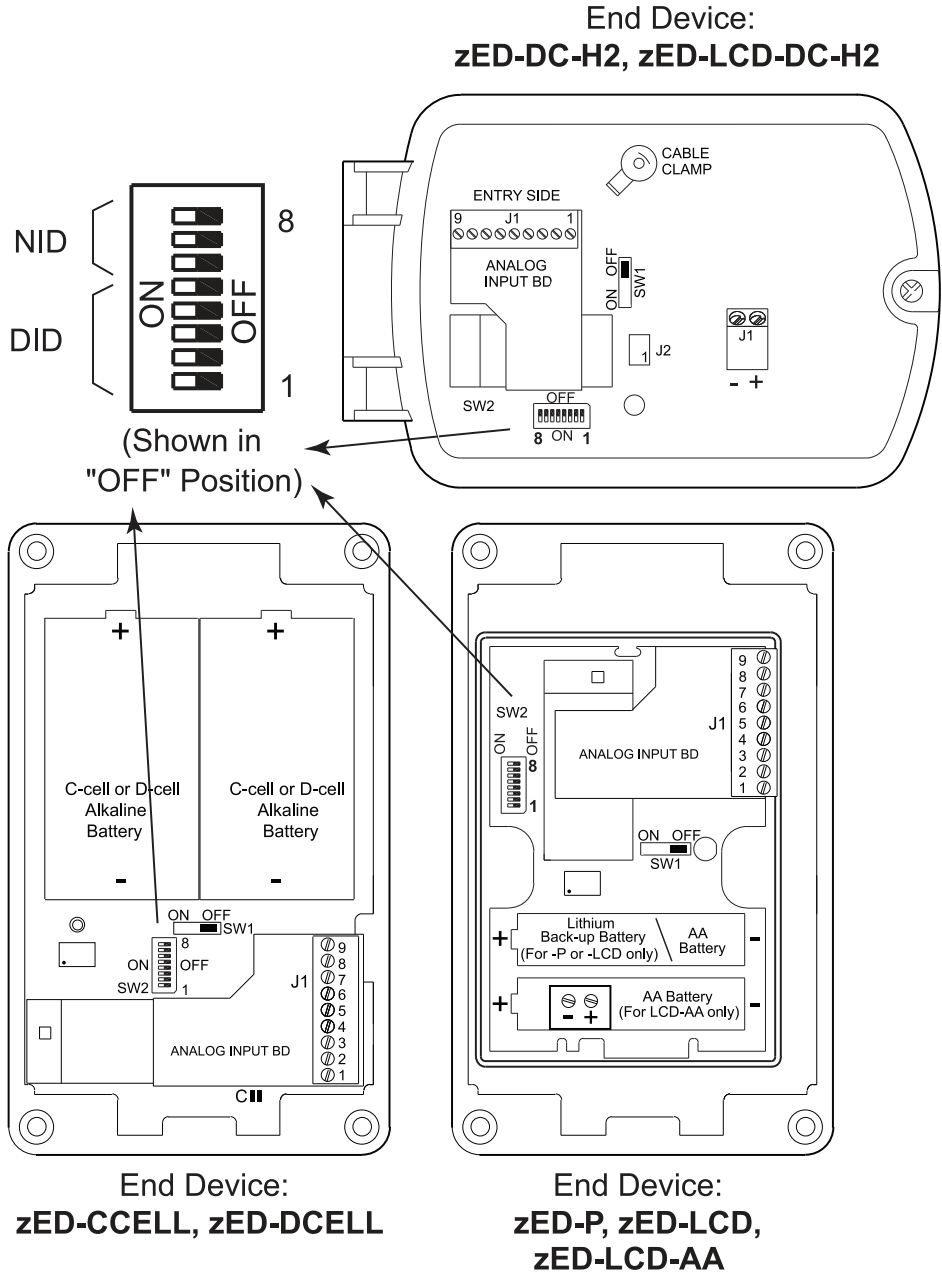

Figure 2.6 Device ID (DID) - 8 Position DIP Switch Setup

### 2.6.1 DIP Switch Setup: Device ID (DID) continued

For each End Device you can setup the unique **Device ID** using DIP switch **#1 - 5**.

The Device ID also determines the Group of the End Device. The Coordinator puts every eight End Devices into a Group so that the system is more manageable.

You can setup the **Network ID (NID)** (which is the same as the Coordinator's) with DIP switches **# 6 - 8**. Refer to **Section 2.6.2**.

Device ID	1	2	3	4	5	
GROUP A	0	OFF	OFF	OFF	OFF	OFF
	1	ON	OFF	OFF	OFF	OFF
	2	OFF	ON	OFF	OFF	OFF
	3	ON	ON	OFF	OFF	OFF
	4	OFF	OFF	ON	OFF	OFF
	5	ON	OFF	ON	OFF	OFF
	6	OFF	ON	ON	OFF	OFF
	7	ON	ON	ON	OFF	OFF
GROUP B	8	OFF	OFF	OFF	ON	OFF
	9	ON	OFF	OFF	ON	OFF
	10	OFF	ON	OFF	ON	OFF
	11	ON	ON	OFF	ON	OFF
	12	OFF	OFF	ON	ON	OFF
	13	ON	OFF	ON	ON	OFF
	14	OFF	ON	ON	ON	OFF
	15	ON	ON	ON	ON	OFF

Device ID	1	2	3	4	5	
GROUP C	16	OFF	OFF	OFF	OFF	ON
	17	ON	OFF	OFF	OFF	ON
	18	OFF	ON	OFF	OFF	ON
	19	ON	ON	OFF	OFF	ON
	20	OFF	OFF	ON	OFF	ON
	21	ON	OFF	ON	OFF	ON
	22	OFF	ON	ON	OFF	ON
	23	ON	ON	ON	OFF	ON
GROUP D	24	OFF	OFF	OFF	ON	ON
	25	ON	OFF	OFF	ON	ON
	26	OFF	ON	OFF	ON	ON
	27	ON	ON	OFF	ON	ON
	28	OFF	OFF	ON	ON	ON
	29	ON	OFF	ON	ON	ON
	30	OFF	ON	ON	ON	ON
	31	ON	ON	ON	ON	ON

## 2.6.2 DIP Switch Setup: Network ID (NID)

Each sensor network has a unique **Network ID** (or NID).

For the End Device (see **Figure 2.6**) and the Coordinator (see **Figure 2.7**) setup the Network ID with DIP switches **#6 - 8**

If there is no other IEEE 802.15.4 system, the default NID can be used where all three dip switches are **OFF**.

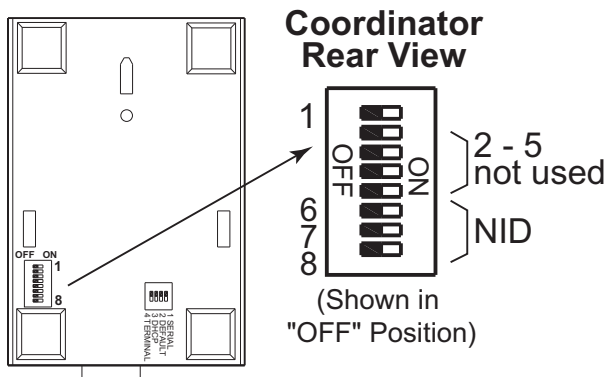

**Figure 2.7 Network ID (NID) - 8 Position DIP Switch Setup**

PID	NID	#6	#7	#8
13106 (0x3332)	0	OFF	OFF	OFF
13107 (0x3333)	1	ON	OFF	OFF
13108 (0x3334)	2	OFF	ON	OFF
13109 (0x3335)	3	ON	ON	OFF
13110 (0x3336)	4	OFF	OFF	ON
13111 (0x3337)	5	ON	OFF	ON
13112 (0x3338)	6	OFF	ON	ON
13113 (0x3339)	7	ON	ON	ON

### Definitions:

**DID (Device ID):** The first 5 DIP switches used to assign a device number to an End Device.

**NID (Network ID):** The last 3 DIP switches used to assign a unique network number to a network of a Coordinator and End Device(s).

**PID (Personal Network ID):** The sum of the Network ID (NID) and 13106 (0x3332). The PID as defined by IEEE for 802.15.4 standard is an identifying factor for separating 802.15.4 wireless networks to avoid overlapping and allow interoperability.

**Note** Once the End Devices and the Coordinator start communicating, make sure to push DIP switch **#1**, located on the back of the **Coordinator** to the **ON** position. This will lock the Coordinator on the same channel it initially established the connection.

**Note** It's a good practice to record NID and DID numbers on designated labels placed on the Coordinator and End Devices, see **Figure 2.1** and **2.4**.

## 2.6.3 DIP Switch Setup: Ethernet - Coordinator

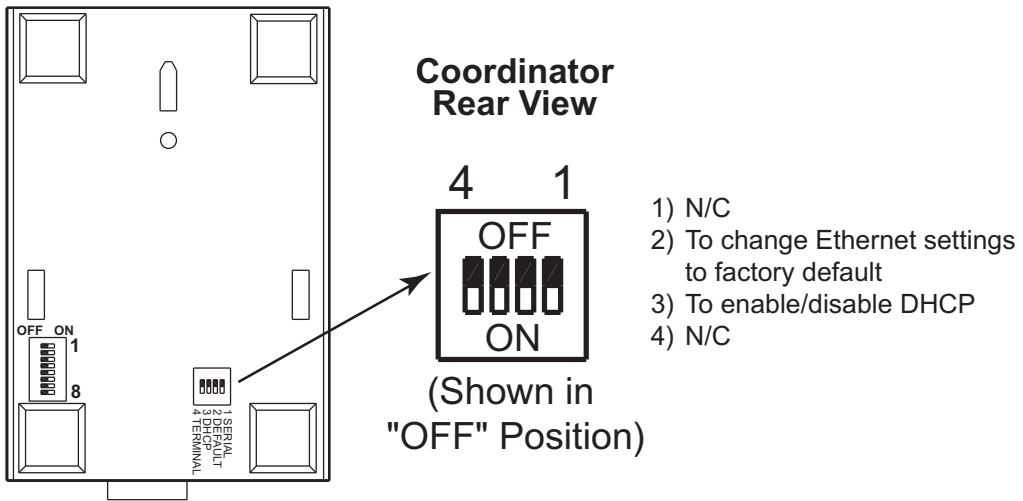

**Figure 2.8 Ethernet - 4 Position DIP Switch Setup**

**Note**

To set the Coordinator to factory default settings:

- 1) Slide DIP switch **#2** to **ON** position.
- 2) Power the Coordinator on and wait about 10 seconds until the Coordinator fully boots up.
- 3) Set the DIP switch **#2** back to **OFF** position (it does not matter if the Coordinator is powered ON or OFF, just make sure that the DIP switch is set to OFF, otherwise, every time the unit is power-cycled the factory settings will take over).

## 2.7 Network Communication Interfaces

### 2.7.1 10BASE-T RJ-45 Pinout

The 10BASE-T Ethernet network (RJ-45) system is used in the Coordinator for network connectivity. The 10 Mbps twisted-pair Ethernet system operates over two pairs of wires. One pair is used for receiving data signals and the other pair is used for transmitting data signals. This means that four pins of the eight-pin connector are used.

Pin	Name	Description
1	+Tx	+ Transmit Data
2	-Tx	- Transmit Data
3	+RX	+ Receive Data
4	N/C	Not Connected
5	N/C	Not Connected
6	-Rx	- Receive Data
7	N/C	Not Connected
8	N/C	Not Connected

**Figure 2.9 RJ45 Pinout**



### 2.7.2 10BASE-T Crossover Wiring

When connecting the Coordinator directly to the computer, the transmit data pins of the computer should be wired to the receive data pins of the Coordinator, and vice versa. The 10Base-T crossover cable with pin connection assignments are shown below.

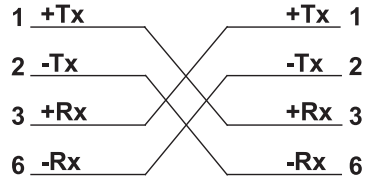

**Figure 2.10 10BASE-T Crossover Cable Wiring**

**Note**

Use straight through cable for connecting the Coordinator to an Ethernet hub. The ports on the hub are already crossed.

### 2.8 Analog Input Wiring

The figure below shows the wiring hook-up for Channel 1 and 2.

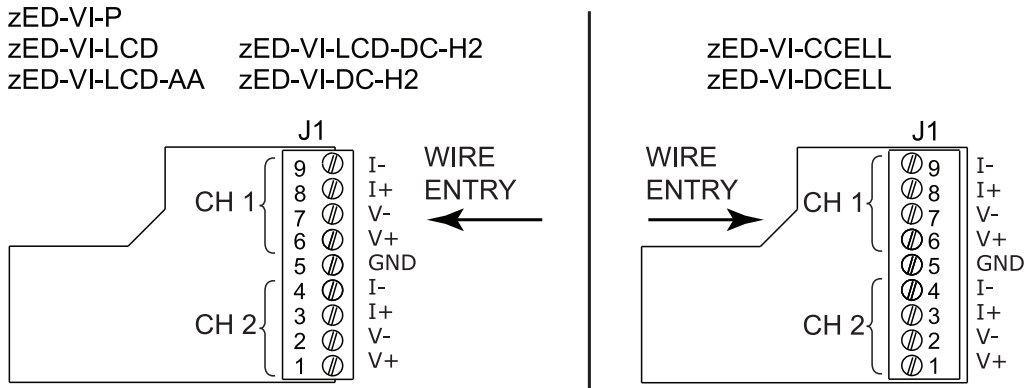

ANALOG INPUT BD

**Figure 2.11 Analog Input Wiring**

## PART 3

### NETWORK CONFIGURATION

#### 3.1 Ethernet (MAC) Address

MAC (Media Access Control) address is your computer's unique hardware number. When you're connected to the LAN from your computer, a correspondence table relates your IP address to your computer's physical (MAC) address. The MAC address can be found on the label of your device and contains 6 bytes (12 characters) of hexadecimal numbers XX:XX:XX:XX:XX:XX hex

For Example: 0A:0C:3D:0B:0A:0B

**Note** 

Remove the small label with the **default IP** address and there will be room to put your IP address. See **Figure 2.4**.

#### 3.2 Network Protocols

The Coordinator can be connected to the network using standard TCP/IP protocols. It also supports ARP, HTTP (WEB server), DHCP, DNS and Telnet protocols.

#### 3.3 DHCP

DHCP, Dynamic Host Configuration Protocol enables computers and devices to extract their IP configurations from a server (DHCP server).

If DHCP is enabled on your Coordinator, as soon as the Coordinator is connected to the network, there is an exchange of information between DHCP server and the Coordinator. During this process the IP address, the Gateway address, and the Subnet Mask will be assigned to the Coordinator by the DHCP server. Note that the DHCP server must be configured correctly to do such assignment.

The Coordinator is shipped with DHCP disabled (factory default).

If fixed or static IP address is desired, the DHCP must be disabled.

The DHCP can be enabled by setting the DIP switch #3 to the "ON" position

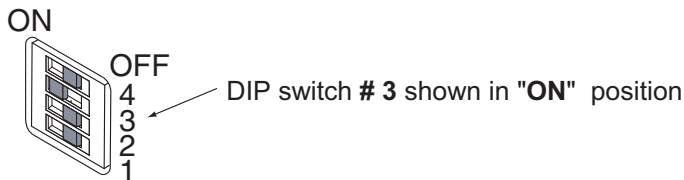

**Figure 3.1 4 Position DIP Switch on the Bottom Side of Coordinator**

**Note** 

Setting the **Coordinator's** IP address to **0.0.0.0** will also enable DHCP.

### 3.4 DNS

DNS, Domain Name System enables computers and devices to be recognized over a network based on a specific name instead of IP addresses.

For example, instead of having to use **http://192.168.1.200** (IP address), you would use only **http://z03ec** or any sixteen character name stored as Host Name under Access Control menu in the zSeries-VI Home Page.

The default DNS name for the Coordinator is "z" followed by the **last four digits** of the MAC address of that particular Coordinator.



Note

1. It is very important to communicate with the network administrator in order to understand DHCP and its existing configurations on the host server, before enabling DHCP on the Coordinator.
2. The Coordinators are shipped with a default static IP address of **192.168.1.200** and Subnet Mask of **255.255.255.0**.
3. On Windows servers where DHCP and DNS are separate functions it is very important to configure the DHCP server to communicate with the DNS in order for the iServer's Host Name to correctly respond. If you cannot access the iServer using its Host Name, please contact your network administrator to make sure the DHCP and DNS servers are linked together.

### 3.5 IP Address

Every active device connected to the TCP/IP network must have a unique IP address. This IP address is used to establish a connection to the Coordinator. Every computer using TCP/IP should have a unique 32-bit address which is divided into two portions, the network ID and the host ID. For instance, every computer on the same network uses the same network ID. At the same time, all of them have a different host ID. For more details about the IP address see **Appendix B**.

#### 3.5.1 Default IP Address

The Coordinator is shipped with a default IP address of **192.168.1.200** and Subnet Mask of **255.255.255.0**. If you are going to use a Web browser or Telnet program to access the Coordinator using its default IP address, make sure that the PC from which you're establishing the connection has an IP address that is in the same range as the Coordinator's IP address (**192.168.1.x**, where **x** can be any number from 1 to 254). See **Section 3.5.2**.



Note

Your PC's IP address cannot be the same as the Coordinator's IP address.

You also need to make sure that your PC's Subnet Mask is **255.255.255.0**. This is a good way to access the Coordinator over the network and make any configuration changes needed. If **192.168.1.200** is already in use on your network, use an Ethernet crossover cable between your computer and the Coordinator to change the IP address or any other settings within the Coordinator.

### 3.5.2 Changing TCP/IP Properties on Your Computer

Go to your computer's **Control Panel** then **Network Connections**.

Pick the network with the proper Ethernet card. Right click and choose **Properties**.

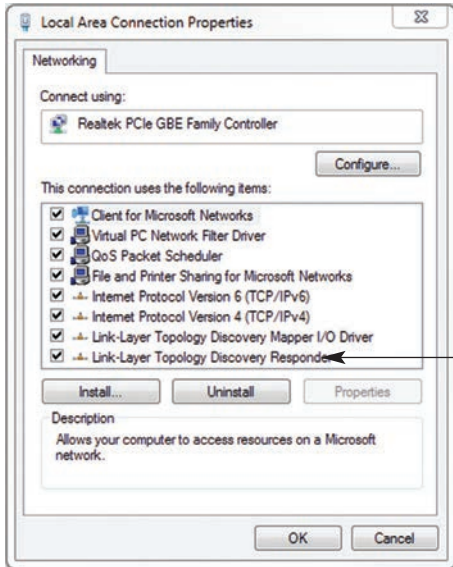

Look for **Internet Protocol Version 4 (TCP/IPv4)**, click on it and press **Properties**

**Figure 3.2 Network Connections**

Setup the IP address (in this case, **192.168.1.1**) as shown below and press OK.

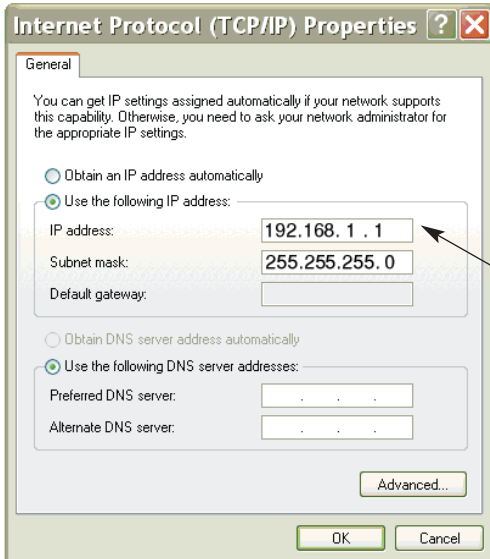

You can access the Coordinator's web server via any internet browser using IP address of **192.168.1.200**.

Once you log into the Coordinator's web server, you will be able to change its IP configuration according to **Section 4.2**.

**Note**

After you configure the Coordinator's IP configurations, you should go back and set your PC's previous IP settings.

**Figure 3.3 Network Connections**

## PART 4 OPERATIONS

This Coordinator can be used and configured in several ways, depending on user's preference and network setup. It can be configured using a Web browser, like Internet Explorer. It can also be configured using the iConnect Configuration Software.

If DHCP and DNS servers are configured to exchange information, the connection will be very simple. All you need to do is to enable DHCP on the Coordinator (see **Section 3.3**) and use a straight through network cable to connect the Coordinator to an Ethernet hub or switch and power it up. Now, you can use the Coordinator's default Host (Domain) Name, which is **zxxxx** (where xxxx are the last four characters of its MAC address) to access the Coordinator's Web Server.

If DHCP is not the preferred method, you can configure your PC's network connection (see **Section 3.5.2** for more details) with an IP address of **192.168.1.x** that is in the same range as the Coordinator's default IP address (**192.168.1.200**) and connect to the Coordinator using a cross-over network cable between your PC's network port and the Coordinator.

After you're done with configuring the Coordinator, you can set your PC's network connection back to its original settings.

On your computer, from the MS-DOS Prompt window type "**ping 192.168.1.200**" and press Enter. If DHCP and DNS servers are used type "**ping zxxxx**", where xxxx are the last four digits of the Coordinator's MAC address, located on the back of the device. You should get a reply as shown in **Figure 4.1**.

### 4.0 Testing the Connection

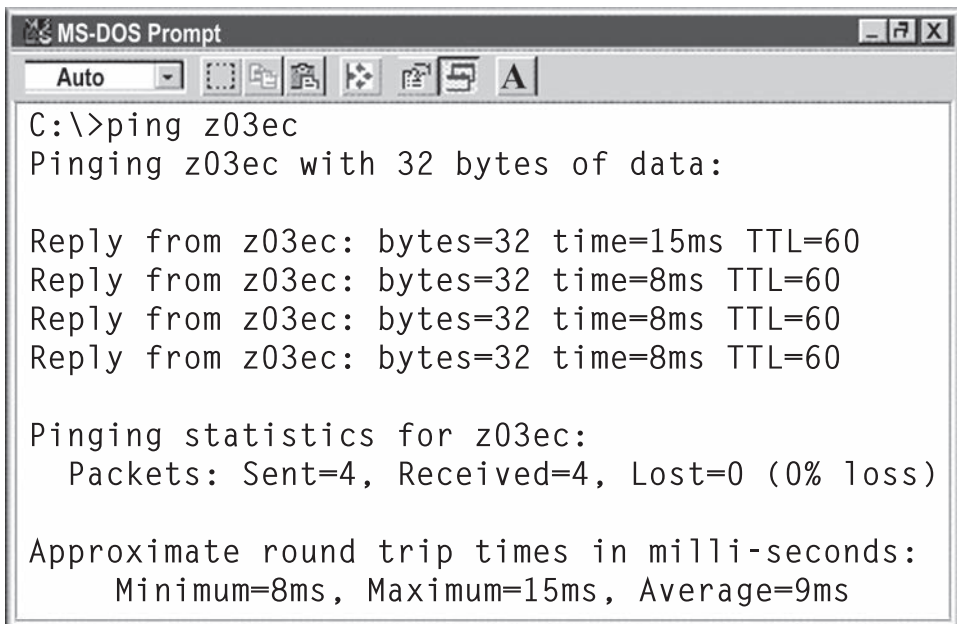

```
MS-DOS Prompt
Auto
C:\>ping z03ec
Pinging z03ec with 32 bytes of data:

Reply from z03ec: bytes=32 time=15ms TTL=60
Reply from z03ec: bytes=32 time=8ms TTL=60
Reply from z03ec: bytes=32 time=8ms TTL=60
Reply from z03ec: bytes=32 time=8ms TTL=60

Pinging statistics for z03ec:
    Packets: Sent=4, Received=4, Lost=0 (0% loss)

Approximate round trip times in milli-seconds:
    Minimum=8ms, Maximum=15ms, Average=9ms
```

**Figure 4.1 Pinging the Coordinator from MS-DOS Prompt**

This proves that the connection is proper and you can get into configuration or run mode using the Telnet or Web browser.

## 4.1 iConnect Software

The Coordinator may also be assigned an IP Address by using the iConnect software.

- a) Download the iConnect software from the website listed in this manual.
- b) Install iConnect software on a networked PC. This software is compatible with Windows 95, 98, NT, 2000, and XP.
- c) Use iConnect to assign an IP address to the Coordinator and access its web pages for configuration. You can also use any standard web browser to access the zSeries-VI system's web pages. Consult with your IT department for obtaining an IP address.

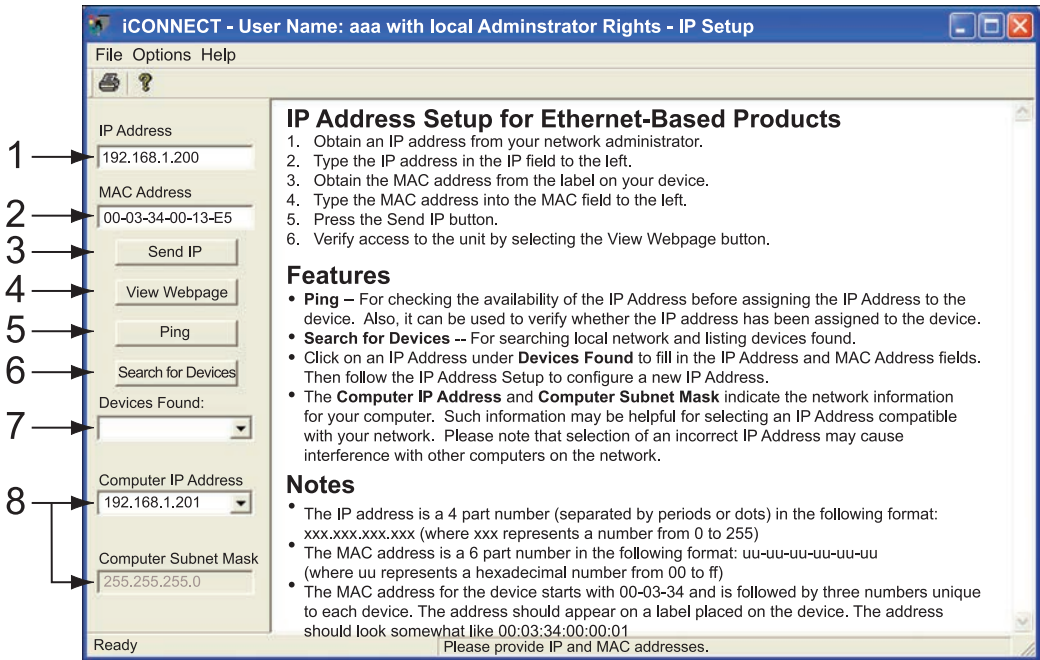
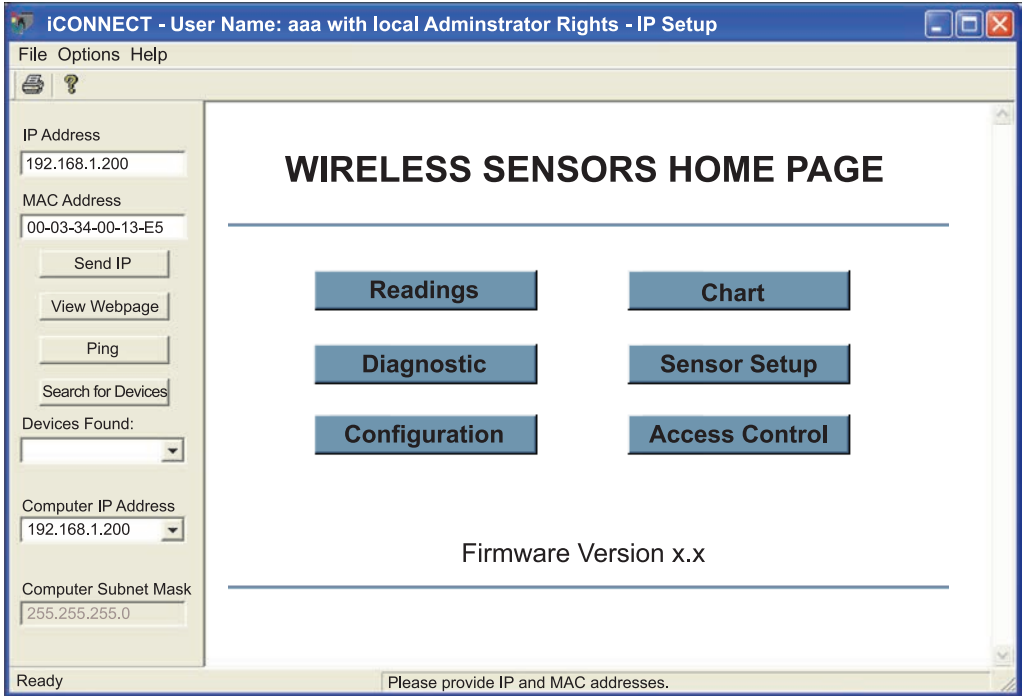

**Figure 4.2 Assigning an IP Address using iConnect**

- 1) Place the IP address in this box.
- 2) Take the MAC address from the label attached to the bottom of the Coordinator and place it in this box.
- 3) Click here to send the above IP address to the Coordinator.
- 4) After the IP address is assigned to the Coordinator, click here to access its web pages.
- 5) Click here to Ping the Coordinator whose IP address is shown in the IP address box.
- 6) Click here to find all the Coordinators on your network .
- 7) The IP addresses for the Coordinators found by the iConnect will be listed here.
- 8) These fields indicate the IP address and the subnet mask of the PC on which the iConnect is running.

#### 4.1 iConnect Software (continued)

- d) To access the zSeries-VI system for Configuration:  
Click on the "View Webpage" button, you will access the zSeries-VI home page, refer to **Section 4.3** for details.



**Figure 4.3 Accessing the zSeries-VI System for Configuration**

## 4.2 Setting a New IP Address over the Network

Besides using the iConnect software, you may use the Coordinator's default IP address to access it and assign a new IP address to it.

The Coordinator is shipped with a default IP address of **192.168.1.200** and Subnet Mask of **255.255.255.0**.

You can configure your PC's Network connection (see **Section 3.5.2** for more details) with an IP address that is in the same range as the Coordinator's IP address (**192.168.1.x**) and connect to the Coordinator using a crossover network cable between your PC and the Coordinator.

With this completed, you can go to the DOS-Prompt and ping **192.168.1.200**.

If you receive responses back (**Figure 4.1**), you can go to the Web browser and type in <http://192.168.1.200> and it will take you to the zSeries-VI Home Page.

Select **Access Control**, button, you'll be asked for the password. You should be on the Access Control page where you can simply type in the desired Static IP address, and click Save.

For more details about the "Access Control" page refer to **Section 4.3.9**.

ACCESS CONTROL

Address <http://192.168.1.200>

# ACCESS CONTROL

Login Password

Admin Password

Host Name

MAC Address

IP Address

Gateway Address

Subnet Mask

[Main Menu](#)

**Figure 4.4 Access Control**

For the IP address to take effect, the Coordinator needs to be turned OFF and ON using the "Network Reset" button. Pressing the physical button marked "RESET" on the Coordinator does the same thing.

You can now connect the Coordinator to an Ethernet hub using a straight through cable, power it up, and follow the ping routine mentioned in the previous section.



### 4.3 Coordinator's Configurations and Operations

The Blue LED should blink for about 8 seconds and then stay on. It indicates that the Coordinator is searching for the least noisy channel and starts listening there. That's when the blue LED changes from blinking to solid. Using a web browser, you should be able to view the homepage.

- Start your web browser.
- From the browser you type <http://zxxxx> using the last four-digits from the MAC address label located on the device if DHCP and DNS are used. If a static IP address is used, then simply type <http://x.x.x.x>, where **x.x.x.x** is the Coordinator's IP address.
- The Home Page, will be displayed.

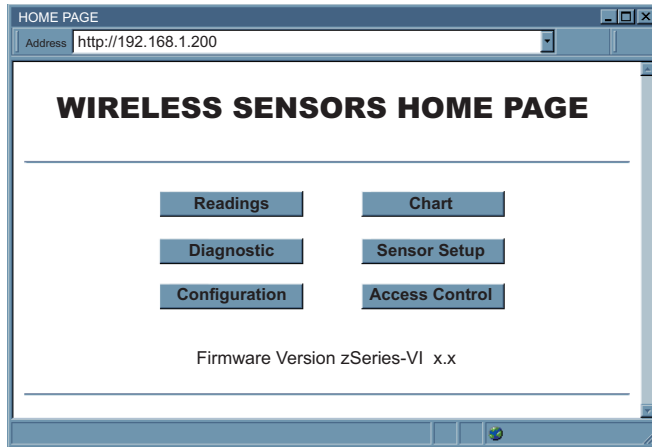

Figure 4.5 Home Page Menu



In order to access certain menu items of the Home Page, users may be prompted for a password, as shown in the two figures below.

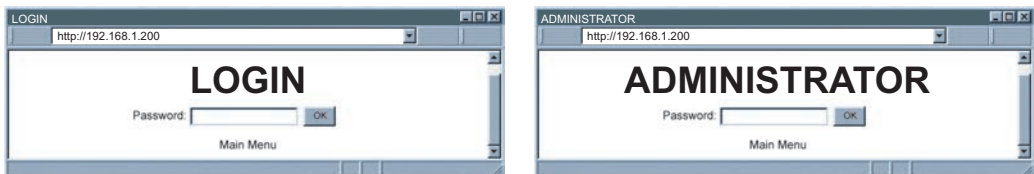

Figure 4.6 LOGIN and ADMINISTRATOR Passwords

There are 2 different access levels:

1. **ADMINISTRATOR Password** (administrator) allows certain groups and individual users to access and modify "entire" parameters without any restrictions.  
The default password is **00000000**. This password can be up to 16 alphanumeric case-sensitive characters.
2. **LOGIN Password** (operator) allows users to access and modify all of the parameters, except "Access Control" which requires an Administrator password.  
The default password is **12345678**. This password can be up to 16 alphanumeric case-sensitive characters.

### 4.3.1 Power Up Device

To verify that an End Device is working before deploying remotely, install batteries and power it on right next to the Coordinator. When the End Device is powered on, it will search for the Coordinator in all 16 channels reserved for IEEE 802.15.4 (channel 11 through 26) by sending request packets. While it's searching, the blue LED on the End Device blinks every second. Once the Coordinator responds to the End Device request, the LED will blink only when the End Device sends data to the Coordinator (default is every 10 seconds). If the Coordinator is not powered on or it's out of reach, the End Device will keep searching until the batteries discharge (e.g. roughly 36 hours for zED).

Once the Coordinator responds back to the End Device it will include its network number in the response packet called Beacon. At this time the End Device would know what the correct Coordinator is (there could be more than one Coordinator responding to the End Device's request packet). The channel on which the Coordinator responds back is automatically picked to be the clearest among all 16 channels and therefore the End Device starts sending data to the Coordinator on that particular channel.

 **Note** Once the End Devices and the Coordinator start communicating, make sure to push DIP switch #1 located on the back of the Coordinator to **ON** position. This will lock the Coordinator on the same channel it initially established the connection.

After the End Device transmits data to the Coordinator, it expects an acknowledgment packet back from the Coordinator. If the End Device does not receive an acknowledgment packet back within 50ms, it will go to sleep mode for 2 seconds and then will transmit the data. This cycle will be repeated for 10 times and if it still does not receive the acknowledgment packet back, the End Device takes a longer sleep time of 3 minutes. After 3 minutes, the End Device retransmits the data every 2 seconds for 4 times and each time it waits for 50ms for an acknowledgment. If it still does not receive a response back from the Coordinator it will take another 3 minutes of sleep. This last sequence will continue until the batteries are drained. Through the whole retransmission cycle explained above the blue LED on the End Device will blink anytime retransmission takes place.

 **Note** The data being retransmitted will automatically gets updated as new readings take place.

 **Note** If the communication channel is manually selected in the Coordinator, the End Devices must be power-cycled in order to establish connection over the new channel. If it's not possible to power-cycle the End Devices locally, a remote option is available through the Coordinator's Web server or Telnet console.

 **Note** When there are two End Devices with the same Device ID, both will be transmitting data every second with their LEDs blinking once a second. The Coordinator will receive data from both End Devices and will display their data alternately. On the "Readings", "Chart", and "Diagnostic" pages of the Coordinator's Web server, the phrase "ID" error code will be placed indicating the conflict. Once the problem is resolved, click on the "Reset Sensor" button located on the Sensors Parameters page to remove the "ID" error code.

 **Note** In case of power failure/outage during normal operation, the zED-P/-LCD will automatically switch its power supply from AC adapter to back-up battery. However, power switching may fail if the End Device is on and consumes lots of energy. Therefore, "LOST" will be detected, the LED stops blinking periodically and the unit must be power cycled manually.

### 4.3.2 Get Readings from the End Device

Once you see the End Device's LED blinking periodically, it means it is sending data which will appear on the "Readings" page. To view the data in a chart format, you can use the "Chart" page.

Click on [Readings](#) from the Home Page, the following page will appear. Select the proper Group to view the readings.

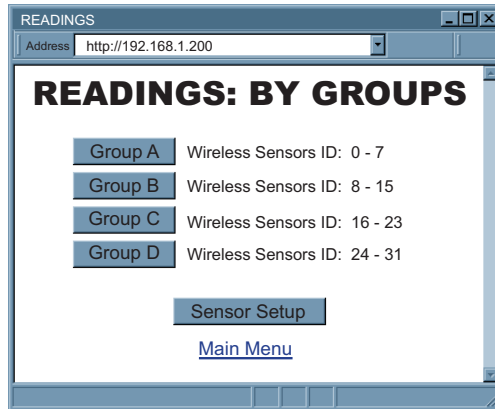
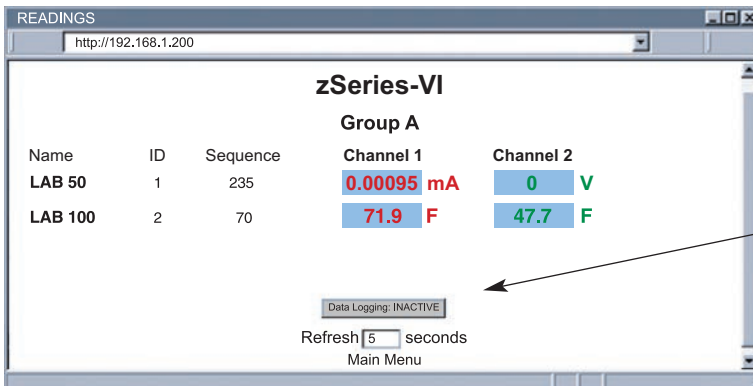

Figure 4.7 Select Readings by Groups

In a few seconds the following page will appear, showing updates of Channel 1 and Channel 2.



**Note** After entering a Refresh Time, make sure to press Enter on your keyboard.

Figure 4.8 Readings

**Note** While accessing the "Readings" page, if a blank screen appears without any "java application running" or image of a "Java logo", please verify you have the latest Java Runtime Environment installed and configured according to the **Section 4.3.3.1**. If you do not have Java Runtime Environment, you may download it from our website or contact the Customer Service Department nearest you.

**Note** You can rescale the signal readings to different engineering units.

### 4.3.2 Get Readings from the End Device (continued)

The "Readings" fields are defined as follows:

**Title:** Coordinator's name, assigned in "Configuration" page.

**Name:** End Device's name, assigned in "Sensor Parameters" page.

**ID:** Sensor ID.

**Sequence:** Sequence number [0-255, Lost, ID ].

The Sequence number is incremented for each newly received data. Therefore, it indicates if the sensor is transmitting data successfully.

This area also will display error messages:

**Lost** Coordinator has not received data from the sensor.

**ID** More than one sensor is configured with the same Device ID.

**Reading Values:** 5 significant digits (at most) are shown. The order is from left to right.

**First Reading** Input signal (Voltage/Current) from Channel 1.

**First Unit** Unit of Channel 1, assigned in Sensor Parameters.

**Second Reading** Input signal (Voltage/Current) from Channel 2.

**Second Unit:** Unit of Channel 2, assigned in Sensor Parameter.

**Data Logging:** Press to activate/de-activate data logging. When it is pressed to activate data logging, a file browser pops up to ask for which file data will be saved. Data is in Comma Separated Value (csv) format, which can also be opened in Excel. Please name file with **.csv** extension.

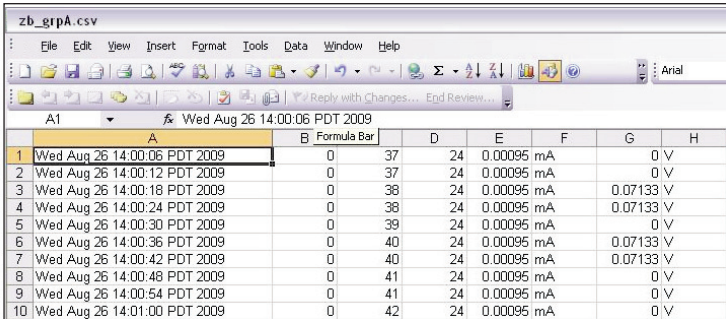

	A	B	D	E	F	G	H
1	Wed Aug 26 14:00:06 PDT 2009	0	37	24	0.00095 mA	0 V	
2	Wed Aug 26 14:00:12 PDT 2009	0	37	24	0.00095 mA	0 V	
3	Wed Aug 26 14:00:18 PDT 2009	0	38	24	0.00095 mA	0.07133 V	
4	Wed Aug 26 14:00:24 PDT 2009	0	38	24	0.00095 mA	0.07133 V	
5	Wed Aug 26 14:00:30 PDT 2009	0	39	24	0.00095 mA	0 V	
6	Wed Aug 26 14:00:36 PDT 2009	0	40	24	0.00095 mA	0.07133 V	
7	Wed Aug 26 14:00:42 PDT 2009	0	40	24	0.00095 mA	0.07133 V	
8	Wed Aug 26 14:00:48 PDT 2009	0	41	24	0.00095 mA	0 V	
9	Wed Aug 26 14:00:54 PDT 2009	0	41	24	0.00095 mA	0 V	
10	Wed Aug 26 14:01:00 PDT 2009	0	42	24	0.00095 mA	0 V	

**Figure 4.9 Comma Separated Value Format**

Columns from left to right: Date and time, Device ID, Sequence number, Device type, Reading 1, Unit 1, Reading 2, Unit 2, next Device ID, next Sequence number, ... (up to 8 End Devices).

**ACTIVE** data is currently being logged in the specified file.

**INACTIVE** data logging is not executed.

**Refresh:** How often the current applet asks for data from the Coordinator. Once you enter the Refresh Time you must press Enter on your keyboard for the time to take effect.



Ensure Java Runtime Environment is setup. Refer to **Section 4.3.3** before activating data logging

### 4.3.3 Java Runtime Environment Setup

If your computer does not have Java installed, please download from java.sun.com. You can change the Java setting by clicking its icon in Control Panel. To load the applet, you have to enable the web browser and disable cache.

#### 4.3.3.1 Java Runtime Environment 1.7 Setup instructions

1. Go to your computer's Control Panel. Open the Java Plug-in.

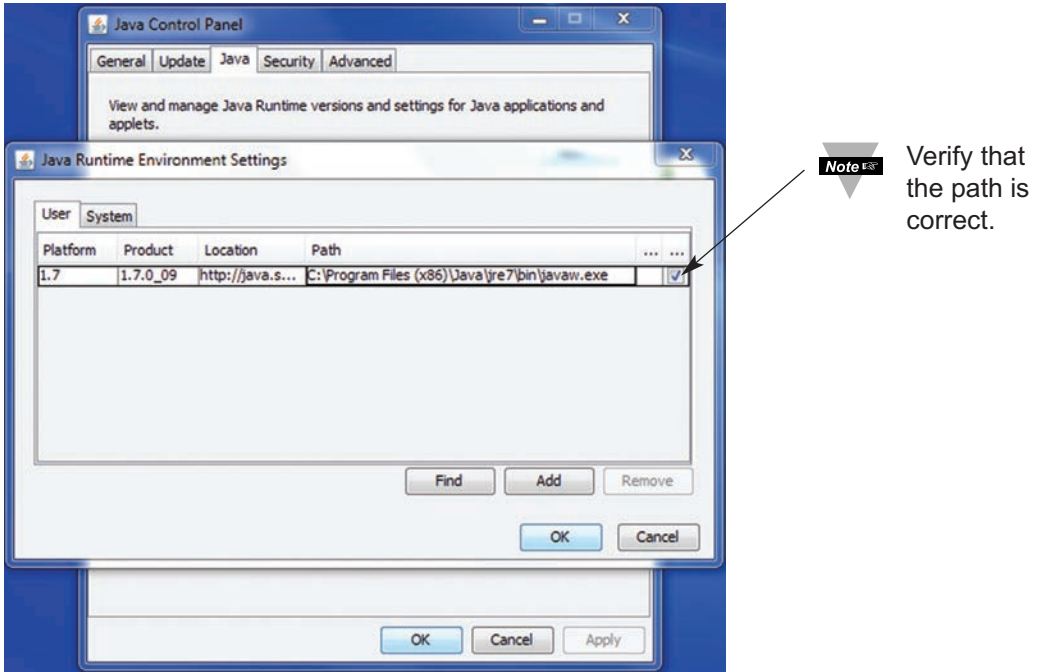

Figure 4.10 Java 1.7 Screen Shot

### 4.3.3.2 Browser Proxy Selection

#### Accessing Coordinators within your internal network

- Usually when the computer and Coordinators are on an internal network, you will not use Proxy server access.
- You should un-check the "Use Browser Settings" option on the "Proxy" tab.

#### Accessing Coordinators units using the internet

- Often the web browser will use Proxy server access to the internet. In such cases, the default Java runtime settings on the "Proxy" tab should suffice. The default setting is the "Use Browser Settings" option.
- If the default proxy setting doesn't work, then you may have a situation where the proxy settings of the web browser are incorrect.

#### Diagnostics:

If the web page of the zSeries-VI system appears, then the HTTP Proxy is working fine. If the data isn't updated on the zSeries-VI system upon selecting the "Readings" web page, there may be a problem with access through a winsock proxy server. In such cases your network administrator will need to provide the winsock proxy server and port #s. (The TCP ports the Coordinator uses for Java applets are 1000 and 1001).

These values should be entered into the Socks line on the "Proxy" tab (of the Java Plugin control panel) or into the "connections" tab on the View,Internet Options dialog and make sure that the Proxy tab shows that the "Use Browser Settings" option is not selected (i.e. when you specify proxy connections in the Java Plugin control panel).

#### Accessing Coordinators units over Peer-to-Peer network

A simple peer-to-peer network is setup by disconnecting from the main network (as users will often do when trying to do initial setup of the zSeries-VI system) and then connecting the Coordinator to another computer using an ethernet hub, an ethernet switch, or a Cross-over cable connection.

Often when using a peer-to-peer network, the Java plugin and the web browser (such as Internet Explorer) have internet connections configured to connect through proxy servers. In such case, you will need to simply assign the final IP address on this peer to peer network and then view the Wireless System's charts after connecting the Coordinator into the regular network. Otherwise you can disable the Java plug-in's "Use Browser Settings" temporarily and then reconfigure the Java plug-in settings for regular network access after testing the Wireless System's chart access on your peer-to-peer network.

The "Use Browser Settings" should not be selected. And the HTTP and Socks proxy entries should be blank. Also, setup the internet browser so that proxy servers are disabled.

Java and the Java Coffee Cup Logo are trademarks or registered trademarks of Sun Microsystems, Inc. in the U.S. and other countries."

### 4.3.4 Chart

Click on [Chart](#), from the Home Page, the following page will appear. Select the proper Group to view the Chart.

In a few seconds the following page will appear. The Java™ Applet graph displays analog signals from each End Device. Analog signals can be charted across a large span such as -10 to 10V or within any narrow range such as -10mV to 10mV.

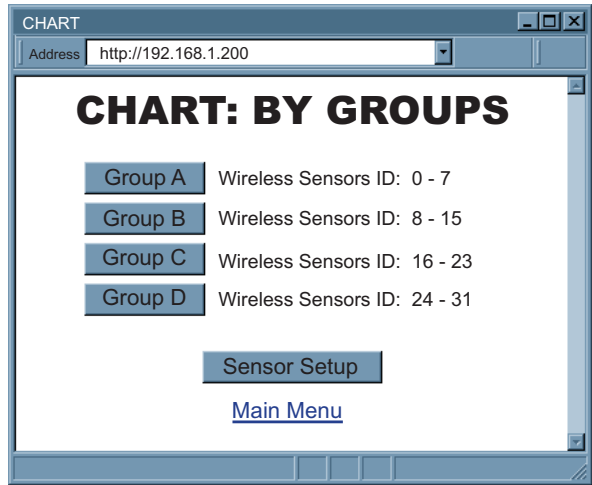

Figure 4.11 Select Chart by Groups

**Note**

If a blank screen appears without any "java application running" or image of a "Java logo", please verify you have the latest Java Runtime Environment installed and configured according to the instructions (refer to **Section 4.3.3.1**). If you do not have Java Runtime Environment, you may download it from our website or contact the Customer Service Department nearest you.

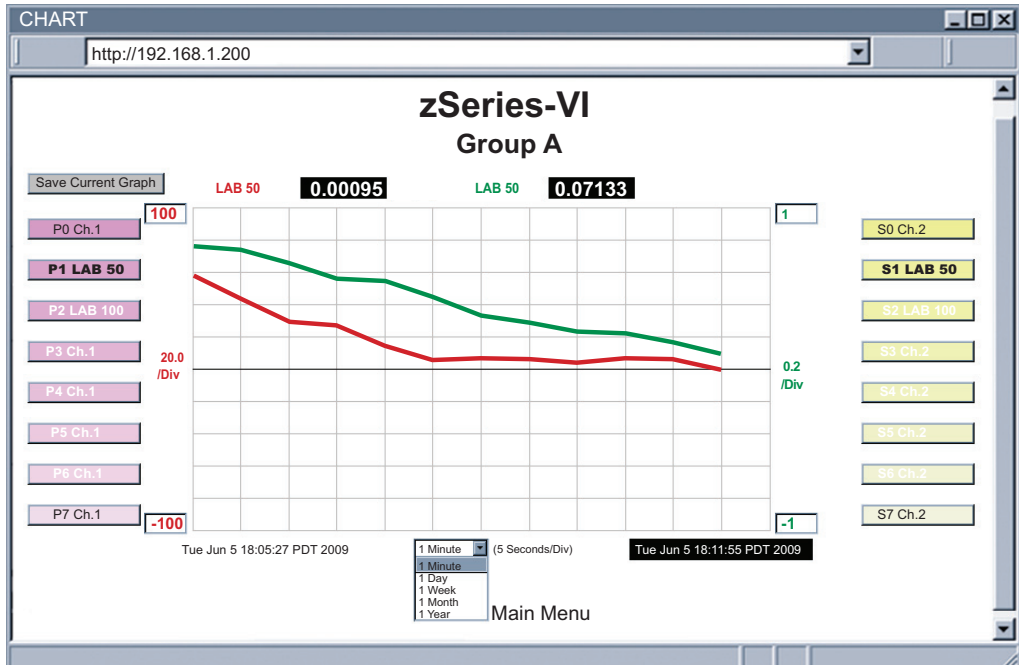

Figure 4.12 Chart - End Device #1 LAB 50

#### 4.3.4 Chart (continued)

**Title:** Coordinator's name, assigned in "Configuration" page.

**Save Current Graph:** Save the current graph in PNG (Portable Network Graphics) format. The filename has extension **.png**.

**Max/Min Ch.1:** Maximum and minimum signal from channel 1 (Primary) of the current graph.

**Max/Min Ch.2:** Maximum and minimum signal from channel 2 (Secondary) of the current graph.

**P# button (Primary):** P# shows the sensor name and controls the primary channel signal.

When clicked once, it turns bold, highlights primary channel signal trend line and displays current signal.

When clicked twice, it turns white and the trend line will disappear.

When clicked again, it comes back to normal operation.

**Chart Area:** Range of signal from channel 1 can be controlled by the upper and lower boxes on the left.

Range of signal from channel 2 can be controlled by the boxes on the right.

**S# button (Secondary):** S# shows the sensor name, displays error messages [Lost/ID] and controls the secondary channel signal.

When clicked once, it turns bold, highlights secondary channel signal trend line and displays current signal.

When clicked twice, it turns white and the trend line will disappear.

When clicked again, it comes back to normal operation.

**Applet Start Date and Time:** Activates when the "Chart" page opens up.

**X-axis Drop-down List:** Time scale for the chart.

The chart area can be shown based on 1 min, 1 hour, 1 day, 1 week, 1 month, or 1 year time intervals.

**Last Update Date and Time:** The last date and time when data arrived.



### 4.3.5 Diagnostic

Click on [Diagnostic](#), the following page will appear.

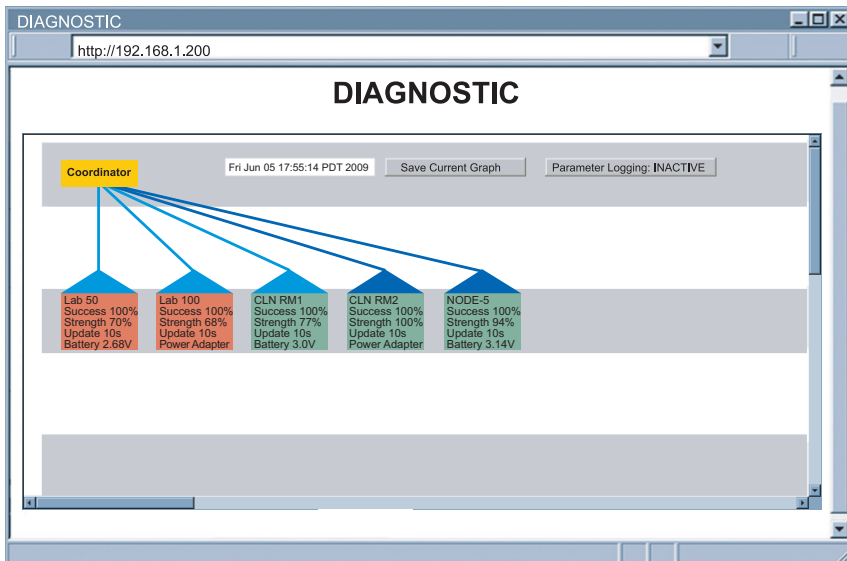

Figure 4.13 Diagnostic

**Date and Time:** Most recent time when data is received.

**Save Current Graph:** Save the current graph in PNG format. The filename has extension **.png**.

**Parameters Logging:** Click to activate/deactivate parameters logging. When it is activated, a file browser screen will allow you to name and save the logging file. The file is in Comma Separated Value (**.csv**) format.

**ACTIVE** – parameters are currently being logged in the specified file.

**INACTIVE** – parameters logging is not activated.

**Coordinator (yellow box):** Coordinator is always at the top of the wireless network hierarchy (star topology).

**Sensor:** Sensor's name, assigned in "Sensor Parameters" page.

**Success Rate:** (0-100%), a low success rate indicates a longer data delay, shorter battery lifetime and high network traffic. Any error messages (LOST, ID, OPEN) will be shown here as well.

**Radio Signal Strength:** (0-100%), the higher the better.

The **blue line and blue triangle (roof)** connecting to the Coordinator indicates the radio signal strength. Darker blue means a stronger radio signal.

*Dark Blue:* between 100% and 79%; *Medium Blue;* 78% to 11%; *Light Blue:* 10% to 0%

**Update Rate:** The time interval the Coordinator received data from the End Device, assigned in Sensor Parameter. "Cont." is shown if device is in continuous mode.

**Battery Voltage:** The total voltage of the batteries in the End Device. Once the voltage gets to 2.7V, it's recommended to change the batteries.

The **box (house) color** indicates battery voltage. *Green:* >2.7V; *Red:* <2.7V

### 4.3.6 Configuration

Click on [Configuration](#) from the Home Page, the following page will appear.

CONFIGURATION

Address

# CONFIGURATION

Name

TCP Connections  Port

PID 13111

Channel

Transmission Power

Please refer to your local regulations for the allowed maximum transmission power

Radio Version x.x

[Main Menu](#)

**Figure 4.14 Configuration**

**Name:** Coordinator name [maximum of 16 alphanumeric characters]

**TCP Connections:** Number of TCP connections available for data query. If "0" is selected no TCP connection can be made to the indicated port number [ 0 through 5 ].

**Port:** Port number for TCP connections. [invalid ports: <500, >65536, 1000, 1001 ].

**Save:** Saves any changes for above settings.

### 4.3.6 Configuration (continued)

**PID:** The Personal Network ID is automatically detected and displayed.

**Channel:** Choose the operation channel defined in IEEE 802.15.4 for the sensor network. This allows you to select a wireless channel to communicate with the End Devices. It is strongly suggested to let the Coordinator to search for the best channel automatically, and by not touching this field.

**Transmission Power:** This determines the signal power transmitted by the Coordinator. The options are 10 dBm and 20 dBm.

**Note** Refer to your local regulations for the allowed maximum transmission power.

**Save:** Saves changes for Channel and Transmission Power.

**Radio Reset:** Power resets the radio module in the Coordinator.

**Radio Version:** Firmware version of the radio module, also shown on model/serial label.

### 4.3.7 Sensor Setup

Click on [Sensor Setup](#) from the Home Page, the following page will appear. Select the proper Group.

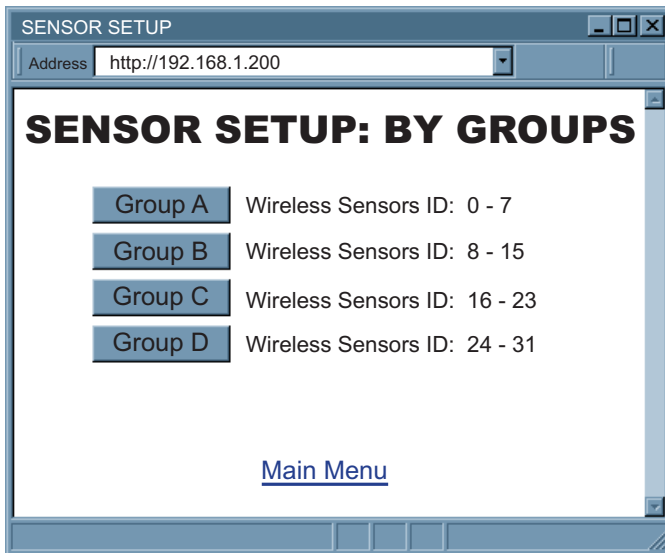

**Figure 4.15 Sensor Setup by Group**

The Sensor Setup Page is for configuring End Device parameters such as name and update rate.

**Note** A faster update period consumes more energy and creates more traffic. The update time must be selected to satisfy acceptable network performance and desired battery lifetime.

### 4.3.7 Sensor Setup (continued)

**SENSOR SETUP**

#	Check	Sensor Name	Update Seconds	Units	Power	Firmware
0	<input type="checkbox"/>	ABCDEFGH	10	--	--	--
1	<input checked="" type="checkbox"/>	LAB 50	10	mA,V	Battery	1.0
2	<input checked="" type="checkbox"/>	LAB 100	10	F, F	Power Adapter	1.0
3	<input type="checkbox"/>	ABCDEFGH	10	--	--	--
4	<input type="checkbox"/>	ABCDEFGH	10	--	--	--
5	<input type="checkbox"/>	ABCDEFGH	10	--	--	--
6	<input type="checkbox"/>	ABCDEFGH	10	--	--	--
7	<input type="checkbox"/>	ABCDEFGH	10	--	--	--

Click on Sensor # to modify Sensor Parameters

Update Checked Box

Readings

Chart

Select Another Group

Main Menu

Clicking this box will take you directly to the Readings page.

Clicking this box will take you directly to the Chart page.

Clicking this box will take you to the Sensor Setup: By Groups page

**Figure 4.16 Sensor Setup**

**#:** Sensor ID configured by DIP switches on the End Device. Click on the number to view and modify Sensor Parameters. See **Figure 4.20**

**Check:** Each check box controls whether or not readings from the End Device will be outputted. If unchecked the readings from the End Device will not be displayed on the "Readings", "Chart", and "Diagnostic" pages, nor it will respond to Telnet connection.

**Sensor Name:** Name of an End Device shows on the "Readings" and "Chart" pages, this is a text field and can take up to 8 alphanumeric characters.

**Updates Seconds:** How often an End Device sends its data to the Coordinator.

**Units:** Engineering unit for the signal. Readings are fully scalable to virtually any engineering unit.

**Power:** Type of power of the End Device [*Battery or Power Adapter*].

**Firmware:** Version number of the End Device firmware.

**Update Checked Box:** After checking/unchecking the boxes, make sure this is clicked to save the changes.

#### 4.3.7.1 Sensor Setup Parameters

**Sensor Name:** Name of this End Device.

### 4.3.7.1 Sensor Setup Parameters (continued)

**Update (seconds):** How often this sensor is sending its data to the Coordinator.

*Continuous* should be selected for continuous mode operation (20 samples/second).

*Periodic* (1 sample/update).

**Note** A faster update period consumes more energy and creates more traffic.

The update time must be selected to satisfy acceptable network performance and desired battery lifetime.

#### Channel 1 or Channel 2:

Choices for analog input signals are 0-100mV, 0-1V, 0-10V and 0-20mA. Select the proper measurement range to maximize resolution and accuracy. If a particular channel is not used, it should be disabled to optimize power consumption.

**Input Low:** The minimum input value being scaled to Reading Low.

**Reading Low:** Output Reading representing Input Low.

**Input High:** The maximum input value being scaled to Reading High.

**Reading High:** Output Reading representing Input High.

**Note** You can rescale the signal readings to different engineering units.

**Update:** Saves changes

**Reset Value:** Ignores changes and puts previous values back in the fields.

**Cancel:** Ignores all the changes and goes back to the "Sensor Setup" page.

**Reset Sensor:** Reset the End Device readings and status. If the End Device is not on the network, the data will be cleared after about 3 minutes. Otherwise, the End Device will reset itself and re-join the network after a minute.

**Identify: INACTIVE:** End device is in running mode and sending data to the Coordinator periodically. **ACTIVE:** End device is in identify mode and it keeps its blue LED on solid so that operator can identify the corresponding sensor easily.

**Select Another Group:** Go back to the group selection page to setup sensors.

The screenshot shows a web browser window titled "SENSOR PARAMETERS" with the address "http://192.168.1.200". The main content area is titled "SENSOR PARAMETERS" and "Sensor #1, Group A". It contains two channels of sensor configuration. Channel 1 is set to "20mA" with an input range of 4 to 20 and a reading range of 4 to 20, with the unit set to "mA". Channel 2 is set to "1V" with an input range of 0 to 100 and a reading range of 0 to 100, with the unit set to "V". Below the channels are several buttons: "Update", "Reset Value", "Cancel", "Reset Sensor", "Identify: INACTIVE", and "Select Another Group". A "Main Menu" link is also present at the bottom.

Figure 4.17 Sensor Parameters

### 4.3.8 Access Control

This section describes the "Access Control" page of the Web interface. This page allows the users to set up the network and security parameters of the zSeries-VI wireless system.

At the initial entrance to the "Access Control" page you may be prompted for the LOGIN Password (see **Figure 4.6**) prior to an ADMINISTRATOR Password.

The screenshot shows a web browser window titled "ACCESS CONTROL" with the address bar set to "http://192.168.1.200". The main content area displays the following configuration fields:

- Login Password:
- Admin Password:
- Host Name:
- MAC Address: 00:03:34:00:85:C4
- IP Address:
- Gateway Address:
- Subnet Mask:

Below the fields are three buttons: "Save", "Reset", and "Network Reset". At the bottom, there is a link for "Main Menu".

**Figure 4.18 Access Control**

**Login Password:** This allows users to access and modify all of the zSeries-VI Home Page menu items, except "Access Control", which requires an Administrator password. The default Login password is **12345678**. This password can be up to 16 alpha-numeric case-sensitive characters.

If there is no Login Password assigned (blank box) the zSeries-VI system will not require a password to access and modify zSeries-VI Home page menu items.

**Admin (administrator) Password:** This allows users to access and modify the "Access Control" page. The default password is **00000000**. This password can be up to 16 alpha-numeric case-sensitive characters.

If there is no Administrator Password assigned (blank box) the zSeries-VI system will not require password to access and modify "Access Control" page.

**Host Name:** Name of the server (DNS) max 16 characters, default is "z" and the last 4 digits of the MAC address. Refer to **Section 3.4**, DNS.

**MAC Address:** This is also called Hardware address or Ethernet address, which is assigned to the Coordinator at production. The MAC (Media Access Control) address is the Coordinator's unique hardware number and is not changeable.

### 4.3.8 Access Control (continued)

**IP Address:** The IP (Internet Protocol) address is a 32-bit number that identifies each sender or receiver of information that is sent in packets across the Ethernet or the Internet. The Coordinator's default IP address is **192.168.1.200**. The Coordinator's IP address should be changed to fit user's networking environment. Consult with your IT department for obtaining an IP address.

 **Note** The DHCP will be enabled in the Coordinator if its IP address is set to 0.0.0.0. The DHCP can also be enabled by setting the DIP switch **#3** to ON position.

**Gateway Address:** A gateway is a network point that acts as an entrance to another network. A gateway is often associated with a router, which knows where to direct a given packet of data that arrives at the gateway. If the Coordinator is sending packets to another network node that is not on the same network on which the Coordinator is connected, a gateway address needs to be given to the Coordinator. The gateway address should be the IP address of the router connected to the same LAN to which the Coordinator is connected. The Coordinator default gateway address is **0.0.0.0**. Consult with your IT department for obtaining a gateway address.

**Subnet Mask:** It's a 32-bit number that is used to determine which part of the IP address is the network portion and which part is the host portion. The Coordinator default subnet mask is **255.255.255.0**. Consult with your IT department for obtaining a subnet mask.

**Save:** Saves any changes for above settings.

**Reset:** Pressing the Reset button will set all the fields back to their original values.

**Network Reset:** Reboots the embedded server. Note that all updated network parameters take effect after reboot.

 **Note** Changes made in the "Access Control" page can be saved permanently by pressing the **Save** button and power recycling the Coordinator (press **Network Reset** button).

## 4.4 Telnet Setup

In the Configuration page, set the TCP Connections to 1 - 5 other than 0, and use a telnet simulation program to connect to the Coordinator (using Port 2000). The command can be sent to query the Coordinator and you will get a response back.

For a list of commands refer to ASCII/TELNET Commands Table in **Appendix F**.

## 4.5 HTTPget Program

The HTTPget software is used to send a single HTTP or TCP request to a Coordinator. In contrast, the telnet or Hyperterminal programs allow a continuous connection with multiple requests to be sent to the Coordinator.

Generally HTTPget is used for simply programming an IP address to the Coordinator or for quickly obtaining a reading from a device.

The Coordinator must be configured from the configuration web page so that the "TCP Connections" indicates any number between 1 and 5. Make sure that the Port Field number indicates 2000.

## 4.5 HTTPget Program (continued)

Whenever Terminal Server service (using Port 2000 by default) is required, the # of connections must be set to a value from 1 to 5. The Terminal Server mode is the recommended mode for the most reliable connection when operating with NEWPORT software or with other programs supporting TCP/IP communications. The Port 2000 access can be used with NEWPORT software and may be needed with some zSeries-VI wireless system products when you need to view readings from the web page while simultaneously collecting data through TCP/IP communications.

### 4.5.1 HTTPget using Port 2000

You can setup and read the information from the zSeries-VI wireless system by using the HTTPget program. The following program can be used to read data from the embedded server firmware by using TCP port **2000**. The command string is sent to this TCP port, then the response can be read back from the same socket.

The HTTPget.exe file is used to setup and read information from the zSeries-VI system. This file will be automatically installed when you install the MailNotifier software available on our website and CD.

Notes on using **HTTPget** :

The HTTPget.exe program is installed to the windows directory (usually c:\winnt or c:\windows) when installing the Mail Notifier software.

1. Open up a command window (or have a DOS window)
  - a) Click on start menu
  - b) Click on "Run"
  - c) In the dialog box that appears, type "cmd" or "command" and click on "OK" button.
  - d) A command window should now appear.
2. If you now type "httpget" and press the "enter", the program options should be displayed.
3. Next run HTTPget with the options displayed below

**httpget -r -S ERDGALL 192.168.1.200:2000 -C1 -q**

where:

- r -S are parameters needed for the the command string
- ERDGALL is the Telnet command (refer to **Appendix F**).
- 192.168.1.200 is an IP address
- 2000 is a socket port number
- C1 closes the TCP connection after 1 second
- q displays no error messages once the connection is closed

```
C:\WINDOWS\system32\cmd.exe
H:\>httpget -r -S ERDGALL 192.168.1.200:2000 -C1 -q
1 181 24 0.00095 mA 0.01733 V
2 155 24 7.9 F 47.7 F
3 213 24 19.7 mA 10.3 V
4 195 24 0.02 mA 0.03 V
5 1 24 19 mA 5.3451 V
H:\>
```

Figure 4.19 HTTPget Example of Polling End Device #1, 2, 3, 4



## 4.5.2 HTTPget and ARP to Setup Device IP Address



Use the iConnect software, which may be downloaded from our website, to do these IP changes whenever possible.

Use ARP first to assign the mac address to a static IP address in computer arp table by this command:

```
arp -s 192.168.1.200 00-03-34-00-06-b6
```

Then use the following command to assign new IP to the device:

```
Httpget -r -S "00000000" 192.168.1.200:1
```

where:

"00000000" is admin. password. If the password is wrong, the unit will ignore the new IP. If the new IP is taken, you will get the message "New IP is Assigned" after the HTTPget command. The device will reset automatically.

"192.168.1.200" is an example of an IP address. It is replaced with IP address suitable for your network.

"00-03-34-00-06-b6" is replaced with your Coordinator MAC address.

## 4.6 ARP Protocol

ARP is the Internet layer protocol responsible for matching or obtaining the MAC (hardware) address that corresponds to a particular IP address. The ARP command allows the user to view the current contents of the ARP cache of the local computer (residing on the same network). Microsoft includes the ARP.EXE utility for viewing and modifying the ARP cache with its Windows products. The following ARP commands can be used to view cache entries:

- **arp -a** Use this command to view all ARP cache entries.
- **arp -a** plus **IP address** Use this command to view ARP cache entries associated with one particular interface on a network with multiple adapters.
- **arp -g** Same as arp -a.
- **arp -N** Use this command to display ARP entries for specific network interface.
- **arp -s** plus **IP address** plus **Physical address** Use this command to manually add a permanent static entry to the ARP cache.
- **arp -d** plus **IP address** Use this command to manually delete a static entry.

## 4.6 ARP Protocol (continued)

The following window shows examples of arp commands and responses.

- Your computer has an IP address of **192.168.1.118**
- The destination computer has an IP address of **192.168.1.96**

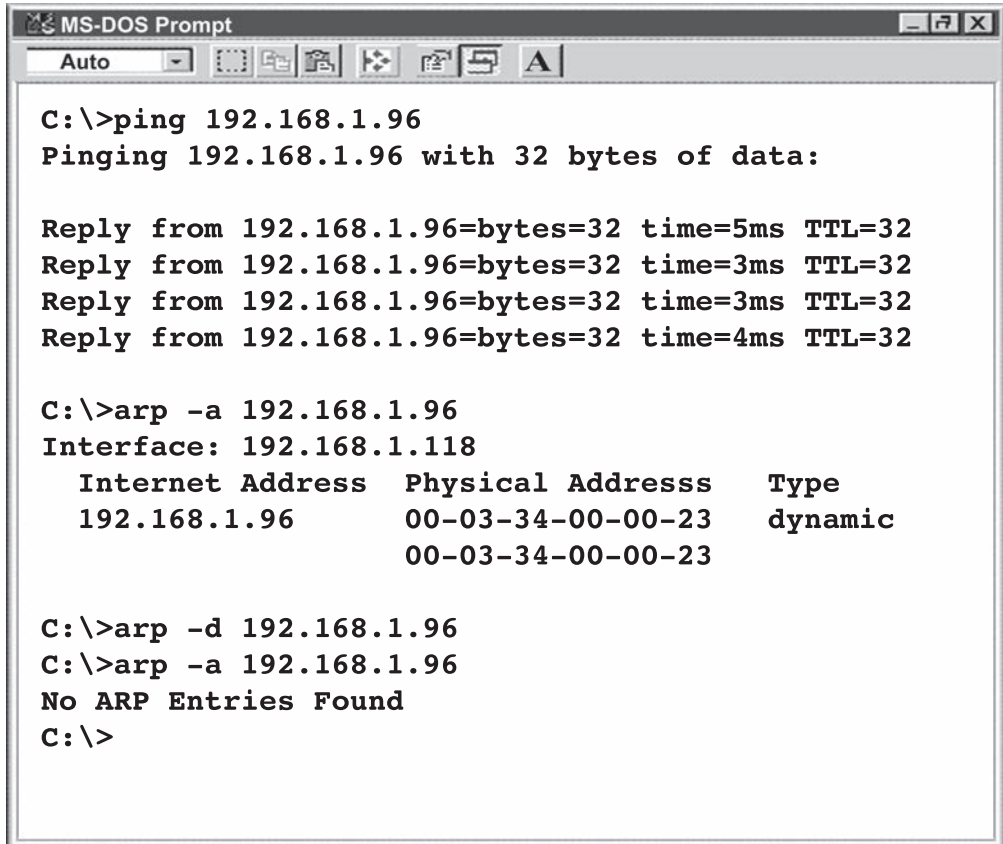

```
MS-DOS Prompt
Auto
C:\>ping 192.168.1.96
Pinging 192.168.1.96 with 32 bytes of data:

Reply from 192.168.1.96=bytes=32 time=5ms TTL=32
Reply from 192.168.1.96=bytes=32 time=3ms TTL=32
Reply from 192.168.1.96=bytes=32 time=3ms TTL=32
Reply from 192.168.1.96=bytes=32 time=4ms TTL=32

C:\>arp -a 192.168.1.96
Interface: 192.168.1.118
    Internet Address    Physical Address    Type
    192.168.1.96       00-03-34-00-00-23  dynamic
                        00-03-34-00-00-23

C:\>arp -d 192.168.1.96
C:\>arp -a 192.168.1.96
No ARP Entries Found
C:\>
```

Figure 4.20 ARP Commands and Responses

## 4.7 iLog Software

This is an Excel application software that can log analog signals from the Coordinator over the local network (Ethernet) or the internet.

- a) Download the iLog software from the website listed in this manual.
- b) Install iLog software on a networked PC. This software is compatible with Windows 95, 98, NT, 2000, XP, Windows Vista and Windows 7 (32 and 64-bit).
- c) If you have Excel 2007 or higher, when installing iLog choose “Custom” installation option and on the next window check the box for “Excel 2007 Apps” and continue the installation to the end.
- d) For complete information of how to use the iLog software, click on the HELP button.
- e) There is a list of Error Messages in **Appendix E**.

Time	Dev1	Dev2	Rdg 5	Rdg 6	Error
9/25/2007 6:23:43 PM	73.20	74.10	70.80	72.50	0
9/25/2007 6:23:48 PM	73.20	74.10	71.00	72.50	0
9/25/2007 6:23:54 PM	73.20	74.10	71.00	72.50	0
9/25/2007 6:24:00 PM	73.20	74.10	70.90	72.50	0
9/25/2007 6:24:06 PM	73.20	74.30	70.80	72.50	0
9/25/2007 6:24:12 PM	73.20	74.30	70.80	72.50	0
9/25/2007 6:24:18 PM	73.20	74.30	70.90	72.50	0
9/25/2007 6:24:24 PM	73.20	74.30	70.80	72.50	0
9/25/2007 6:24:30 PM	73.20	74.30	70.60	72.50	0
9/25/2007 6:24:36 PM	73.20	74.30	70.90	72.50	0
9/25/2007 6:24:42 PM	73.20	74.40	70.80	72.50	0
9/25/2007 6:24:48 PM	73.20	74.40	70.80	72.50	0
9/25/2007 6:24:53 PM	73.40	74.40	70.70	72.50	0
9/25/2007 6:24:59 PM	73.40	74.40	70.60	72.50	0
9/25/2007 6:25:05 PM	73.40	74.40	70.50	72.50	0
9/25/2007 6:25:11 PM	73.40	74.40	70.50	72.50	0
9/25/2007 6:25:17 PM	73.40	74.40	70.40	72.50	0
9/25/2007 6:25:23 PM	73.40	74.40	70.30	72.50	0
9/25/2007 6:25:29 PM	73.40	74.40	70.30	72.50	0
9/25/2007 6:25:35 PM	73.40	74.40	70.30	72.50	0
9/25/2007 6:25:41 PM	73.40	74.40	70.20	72.50	0
9/25/2007 6:25:47 PM	73.40	74.40	70.20	72.50	0

Figure 4.21 iLog Software Logging Data for End Device #1, 2

**Note**

The Options button will let you select the product model. Choose your product model from the Model Selection pull-down menu (from General tab).

## 4.7 iLog Software (continued)

**Table 4.1 iLog Excel Applications**

The iLog application actually consists of several Excel files, though most supported devices can be accessed by the main iLog program. The main program is listed as "iLog", plus a version number, under the Start Menu program links (those links available by clicking the Start button on the Windows taskbar).

In the following table, the iLog File column shows how many sensors are logged by the main iLog file. If more than 3 sensors are available, then the Alternate column shows how many sensors the device can support. Devices with more than 3 sensors will have their own Excel file. For these files, click on the model device found in the Start Menu.

<b>Networked Product</b>	<b>iLOG File</b>	<b>Alternate</b>
iTHX-W, iTHX-2	3 column	
iTHX-M, iTHX-SD	3 column	
iTHX-W Dual Probe	1st probe / 3 column	6 column
iSE-TC, iSD-TC	3 column	5 column
iSE-TH, iSD-TH	3 column	5 column
iBTHX-W, iBTHX-D	3 column	4 column
iBTX-M, iBTX-SD	2 column	
iPTX-W	2 column	
ITCX	3 column	
iTH Controller	3 column	
iVI	3 column	4 column
iSeries	1 column	
iDRX/iDRN	1 column	
INF-B	1 column	

### **Wireless Devices**

The "Auto" column shows number of columns per remote device that are possibly displayed.

The Full column shows number of columns allocated per device for the "Full" spreadsheet, which will be able to display all data for all active devices.

<b>Networked Product</b>	<b>Auto</b>	<b>Full</b>
zSeries Receiver and Remotes	1 to 4 column / device	4 column / 32 device
wi8/wiDR-zT with zED Remotes	1 to 2 column / device	2 column / 32 device
UWTC REC-3 and Remotes	1 or 2 column / device	2 column / 32 device
wi8/wiDR-U with UWTC Remotes	1 to 2 column / device	2 column / 32 device

The active wireless devices, when shown in the Excel application, will be shown with the device number and the units returned.

## 4.8 Mail Notifier Software

For complete information of how to use the Mail Notifier software, click on the Help menu of the main window.

The Mail Notifier software generates email notifications for alarm conditions. Users can be notified automatically of alarm conditions monitored via internet connections throughout the world. By use of the email forwarding of alarm conditions, alarm conditions can be monitored on a network isolated from the internet and forwarded to connections on the Internet.

The Mail Notifier utility operates under Windows 98, NT 4.0, 2000, and XP in conjunction with existing email that supports the MAPI messaging interface. If MS Outlook has been loaded, the MAPI support should be available.

### 4.8.1 Installation

The Mail Notifier must be loaded on a computer running Microsoft Windows (versions specified earlier) using an email program that provides MAPI access. Network access must be available between this computer and the zSeries-VI wireless system. Network access must also be available from this computer to the appropriate email server and from the email server to the recipient's email server.

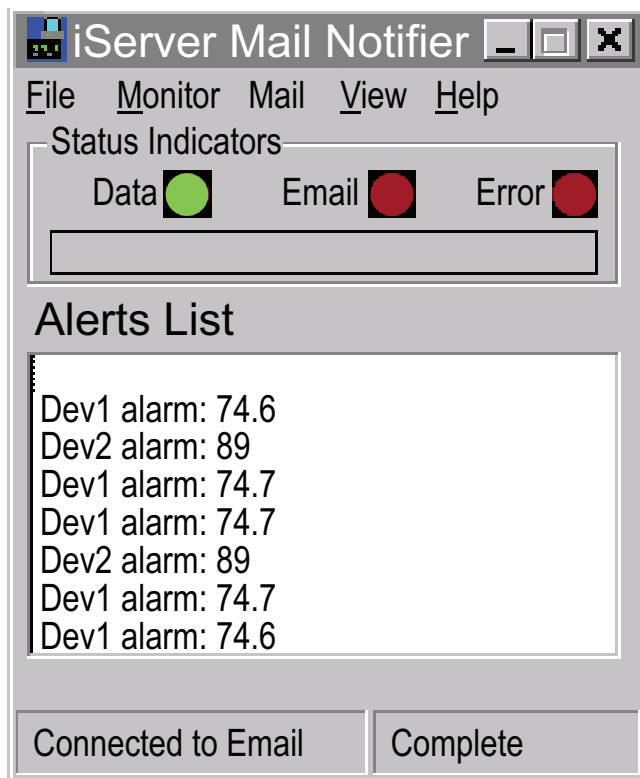
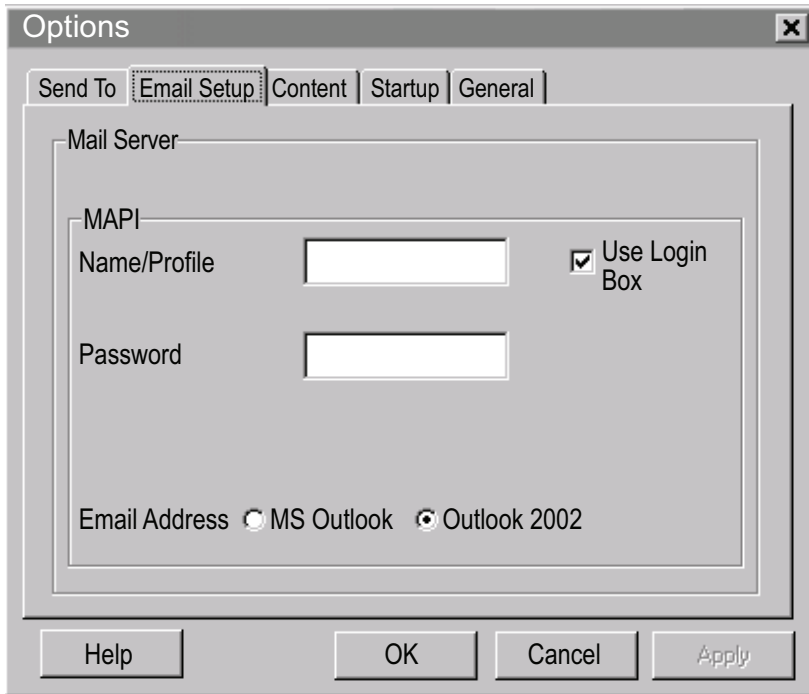

Figure 4.22 Mail Notifier Main Window

## 4.8.2 Program Options Setup and Configuration

Complete program setup requires:

- Entering a recipient for the email
- Specifying connection details to MAPI services.
- Defining alarms for devices, and selecting how and when the email will be active.



**Figure 4.23 Mail Notifier Profile Setup**

### Email Address Setup

The email addresses must be entered using individual addresses or alias. Select "Options" from the "View" menu and enter the email addresses on the "Send To" screen. This will be the list of email addresses to which alarm notifications will be sent.

### Email Setup

The Mail Notifier is compatible with original MS Outlook™ and Outlook™ 2002 to 2005.

The Mail Notifier will attempt to automatically identify whether the Outlook is a newer version. A red bar appears under the Mail Notifier splash window to confirm that the detection of the 2002 or newer version is acceptable. With the newer versions, no additional steps should be taken to enable the connection between the Mail Notifier and the Email server.

#### Note

MS Outlook tends to require that the users respond to a "login box" in order for email access to be activated for Mail Notifier. Some other email clients may allow for Mail Notifier to gain access without user login, as may be desired for a system recovering from a power outage. See the Help files for more information.

### 4.8.3 Device Setting and Configuration

Make sure that the Coordinator is configured (using web access, see **Figure 4.17**) to the settings below.

TCP Connection = any value from 1 to 5

Port number = 2000 (other values may be acceptable as long as Mail Notifier is setup with the same Port number).

Then on the Mail Notifier Alarm Editor:

- 1) Set the "IP address" (for example **192.168.1.200**).
- 2) Specify "Socket Number" **2000**.
- 3) Set the "Address/RS485 Unit" to the Device ID number for an End Device.
- 4) Set the "Reading Cmd" using general commands in the following Table below.
- 5) Define the Alarm Configuration (High/Low, High value, or Low value).

Specify Email Interval. This determines how many seconds each sequential alarm notification will be sent.

Determine Monitor interval. This establishes the interval or time resolution in seconds for which readings will be obtained from the device.

**Table 4.2 Mail Notifier Commands**

Desired Value to Monitor	Reading Cmd string	Actual Command String (see Note 2)
Reading A	zRdgA	ERDB003
Reading B	zRdgB	ERDB003
Battery voltage (mV)	zBatt	EQPE003
Signal Level	zSignal	EQPE003
Sleep Interval	zSleep	EQPE003
Status (see Note 4)	zAddress	EQNF003



1. The End Devices are configured in Mail Notifier with symbolic commands rather than actual device commands.
2. zRdgA with RS485 Device Unit # as 3, for example, is sent as ERDB003.
3. "Reading A" will be the first value returned for a device in response to a command such as ERDB003.
4. "Status" can be used to detect an address conflict. The value should be tested to be at value 32 if there is an address conflict.

### 4.8.3 Device Setting and Configuration (continued)

The screenshot shows a dialog box titled "Alarm Editor" with a close button (X) in the top right corner. The dialog is divided into two main sections: "Device Info (1 of 2)" and "Alarm Configuration".

**Device Info (1 of 2)**

Server IP Address	192.168.1.200
Socket Number	2000
Bus Address/Device ID	3
Description	
Src ID	Dev1
Reading Cmd	zRdgA

On the right side of the Device Info section, there are buttons for "OK", "Cancel", "Help", "Add", and "Del". Below these buttons is a checkbox labeled "Only Monitor Access to iServer device" which is currently unchecked.

**Alarm Configuration**

Alarm Type	Alarm High	Info Message	
Alarm High	73	Email Interval	0.05 hrs.
Alarm Low	0	Monitor Interval	0.5 min.
		Alarm Hold Time	0.0 min.

**Figure 4.24 Mail Notifier Device Setting**

### 4.8.4 Sending Text Messages to a Cell Phone

Once you install the Mail Notifier Software and configure it to work with any of our networking products, you can use the following format to have Mail Notifier send a text message to your cell phone. Since most cell phones are capable of receiving text messages you just need to find the correct email format for your cell phone provider and use it within the Mail Notifier environment.

T-Mobile	phone_number@tmomail.net
Virgin Mobile	phone_number@vmobl.com
AT&T	phone_number@txt.att.net
Sprint	phone_number@messaging.sprintpcs.com
Verizon	phone_number@vtext.com
Nextel	phone_number@messaging.nextel.com

“phone\_number” is your 10 digit cell phone number.



## **PART 5**

### **ENVIRONMENT / OPERATING CONDITIONS**

End Device/Coordinator are designed to be fixed mounted and operated in a clean and dry environment. Care should be taken to prevent the components of your wireless system from being exposed to moisture, toxic chemicals, extreme cold or hot temperature that are outside the specification listed in this manual.

The following is a list of basic good practice you should apply when operating this Wireless System.

1. Do not operate the wireless device in flammable or explosive environments.
2. Do not use the wireless device in medical, nuclear or any other critical application where failure can cause damage or harm.
3. Always operate the wireless device within the recommended environmental limits specified in this manual.
4. Do not operate your wireless device with a battery or AC adapter other than what's supplied or specified in this manual or on the battery compartment label.
5. Keep each wireless device at least 8 inches (20 cm) from other radio transmitters, antennas, and people.
6. The FCC approval for this device specifies the specific antenna supplied with this device.

#### **5.1 General Deployment Guidelines**

1. Position Coordinator in a central location. When multiple End Devices are in operation, position your Coordinator in a central space if possible in equal distance to each End Device.
2. Test your system before permanent mounting. Try to move the devices to different location around and mounting angles to determine what installation achieves the best signal strength before permanently mounting the End Device.
3. Move your system components higher off the floor and away from exterior walls. The closer the End Device/Coordinator are, the greater the interference and lose of signal strength will be.
4. Maintain a line-of-sight between antennas and keep Fresnel zone free of obstruction. See **Figure 5.2**.
5. Maintain a constant ambient temperature environment. Exposing your system components to extreme cold or hot temperatures, or sudden changes in ambient conditions will have an effect on the performance of your system.
6. As a general rule in buildings, head height or above is preferred. On the other hand, End Device stays close to the floor may have their range reduced by 50% to 90%.

## 5.1 General Deployment Guidelines (continued)

7. Where possible, try to ensure an uninterrupted line-of-sight between nodes. Avoid obscuring objects (e.g. metal pillars, posts, sign) near the antenna. A close object obscures a wider range of solid angle.
8. It is important to understand that the environment may change over time due to new equipment or machinery being installed, building construction, etc. If new obstacles exist between your End Device and Coordinator, antenna angle may need to be re-adjusted and/or the unit has to be relocated.
9. An IEEE 802.15.4 wireless network will not work under water. Wet condition (e.g. in heavy rainfall) may exhibit some degradation. In most cases, water droplets on or close to the antenna are more serious than the rain itself. Humidity can affect radio performance as well.
10. Reduced performance scenario:
  - a. A large building may have few obstructions between nodes but large amount of metallic paneling that cause reflections.
  - b. A small domestic installation may have numerous brick walls between nodes in individual rooms.
  - c. An office building may have metalized dry-wall partitions together with mezzanine ceilings.

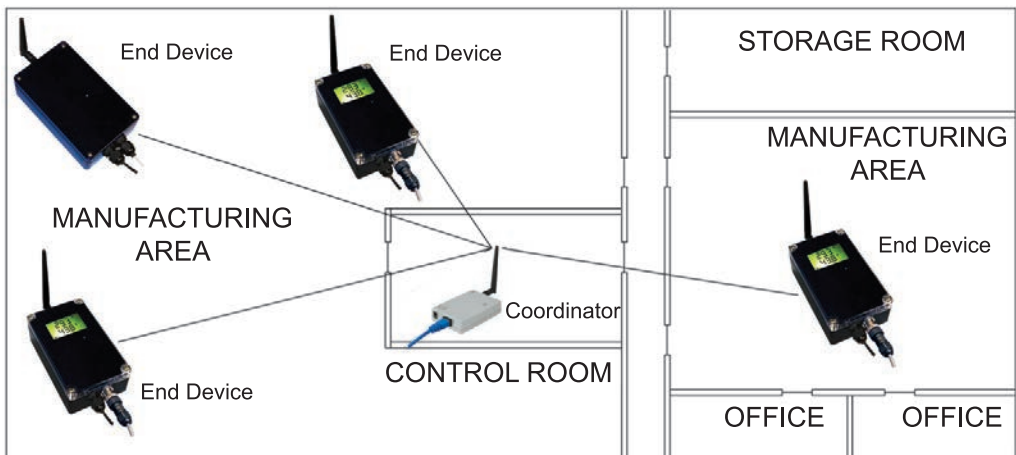

**Figure 5.1 Operation in Buildings**

**Note E-3**

Data is sent through radio signal at 2.4 GHz. Radio signals are electromagnetic waves, hence the signal becomes weaker the further it travels.

While radio waves can penetrate some solid materials like a wall, they can diminish more than when a direct line-of-sight between the transmitting and receiving antenna exist.

Therefore, it is generally a good idea to place Coordinator at the center while End Devices are located about the same distance away from it. If possible, keeping clearance around the line of site will improve performance as well.

## 5.2 With Line-of-Sight

When installing your Coordinator it is important to position your device in such a way to optimize the antenna location within what's known as the "Fresnel Zone". The Fresnel Zone can be thought of as a football-shaped invisible tunnel between two locations that provides a path for RF signals between your End Device and your Coordinator.

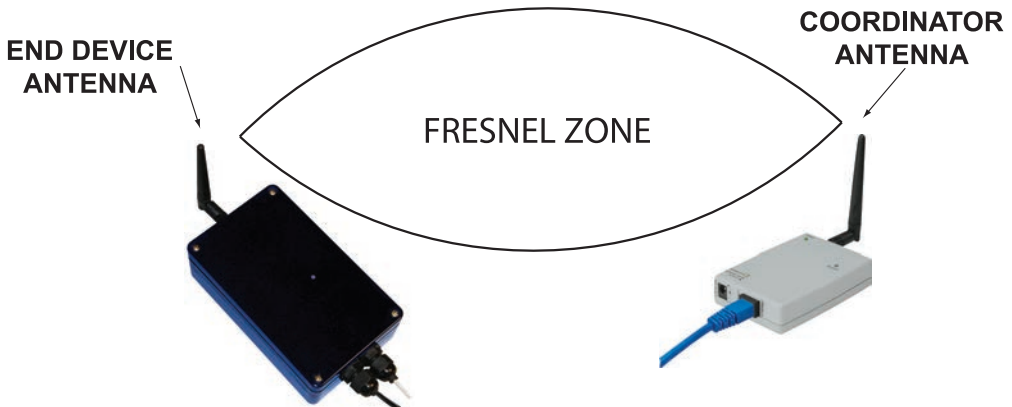

**Figure 5.2 Fresnel Zone**

In order to achieve maximum range, the football-shaped path in which radio waves travel must be free of obstructions. Obstacles in the path (especially metal) will decrease the communication range between your End Device and Coordinator. Also, if the antennas are mounted just barely off the ground or below the ceiling, over half of the Fresnel zone ends up being obstructed resulting in significant reduction in range. Below is the calculated radius of the football-shaped tunnel for different distance range:

Distance (feet)	Radius (feet)
100	3.2
200	4.5
300	5.5

It is recommended that within the tunnel of the above radius, at least 60% of space is free of obstruction.

Since signal reaches destination directly in a line-of-sight situation, it is important to adjust antenna properly to achieve maximum performance. Antenna for the Coordinator and End Device should be perpendicular to the plane where Coordinator and End Device is located.

### 5.3 Without Line-of-Sight

When line-of-sight is not possible, signal penetrates and is reflected by different objects to reach the destination. Therefore, it is important to learn about how these materials would affect signal propagation. Depending on the thickness, moisture content and angle of incidence, a wall may allow between 1% and 25% of the radio power to pass through. Metal panel or metalized glass window will not allow much radio power to pass through. Signal will be reflected if the panel is a mirror. Some radio power may propagate through small holes in the panel or around metal edges through the process of diffraction.

Material Type	Possible Signal Reduction
Wood, Plaster, Sheetrock, Fiberglass Uncoated Glass w/out Metal	0 to 10%
Brick, Pressboard	5 to 35%
Reinforced Concrete	10 to 90%
Metal Walls, Metal Doors, Elevators, Metal Piping, Metal Stair Cases, Metal Mesh, Metal Screening	90 to 100%

**Figure 5.3 Materials in Buildings**

In a non-line-of-sight situation at 2.45 GHz, it is possible to move the receive antenna only 1 to 1 1/2" (3 to 4 cm) and see signal strength varies from 6 dB to -20 dB due to multiple signal reflection path. Therefore, there should be about 20 dB path loss margin to take signal fading into account.

### 5.4 Casing and Closure Around the Antenna

1. Metallic structure should be kept at least 0.8" (2 cm), although 2.4" (6 cm) is recommended away from the antenna.
2. Any casing that encloses the antenna should be plastic. In addition, it is also wise to avoid plastic case with dark fillers or colorants.

## 5.5 Fine Adjustment in Performance

1. To avoid interference from WiFi / IEEE 802.11, one could consult the figure below to choose the best channel through the Configuration webpage. In all, channels 15, 20, 25 and 26 are not overlapping with any WiFi / IEEE 802.11 bands in the United States while channels 15, 16, 21 and 22 can be used in Europe.

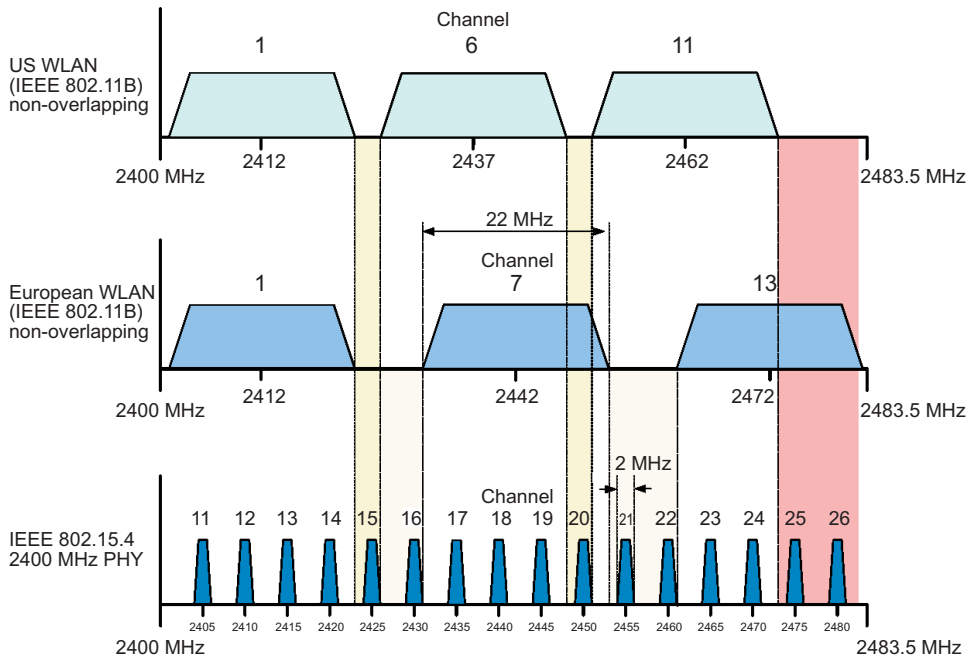

**Figure 5.4 Channels**

2. It is possible that IEEE 802.15.4 devices experience interference from Wi-Fi / IEEE 802.11 and Bluetooth devices and certain microwave ovens. Therefore, it is worth locating nodes as far as possible to minimize effect. Note that international radio regulations which govern radio equipment ensure that cell phones use their allocated band only. It is highly unlikely that cell phones will interfere with IEEE 802.15.4 equipment.
3. In some cases, a short RF cable may be used to connect an antenna to your device. Please note that RF extension cables will always add some loss to the transmitting signal strength. The longer the cable the more signal will be lost over that cable. Therefore, the length of the cable should be kept as short as possible. Also, note that use of any other antenna other than what's shipped with your device will void FCC and CE regulatory compliance.
4. To achieve satisfactory IEEE 802.15.4 performance in the presence of WLAN interference, a channel center-frequency offset of 7 MHz is recommended.
5. For co-channel operation, a physical separation from the WLAN Access Point (AP) of 26.2' (8 m) is recommended to achieve a Packet Error Rate (PER) of 1%. For a particularly saturated WLAN link, 29.5' to 32.8' (9 to 10 m) may be necessary.
6. To achieve satisfactory IEEE 802.15.4 performance in the presence of Bluetooth interference, a separation distance of 6.5' (2 m) is recommended.

## **PART 6**

### **SPECIFICATIONS**

#### **ANALOG VOLTAGE & CURRENT INPUT**

<b>Voltage Input:</b>	Differential; bipolar; $\pm 100$ mV, $\pm 1$ V, $\pm 10$ V
<b>Input Impedance:</b>	400 K ohm for voltage
<b>Current Input:</b>	Differential; bipolar; $\pm 20$ mA (5 Ohm load)
<b>Accuracy:</b>	$\pm 0.1\%$ Full Range @ 25°C
<b>Reading Rate:</b>	Periodic (1 sample/update) or continuous (20 samples/second)
<b>A/D Conversion:</b>	Sigma-Delta
<b>Resolution:</b>	16 bits
<b>Temperature Coefficient:</b>	$\pm 50$ ppm/°C
<b>Common Mode Rejection:</b>	105 dB
<b>Normal Mode Rejection:</b>	98 dB
<b>Warm-Up to Rated Accuracy:</b>	30 minutes

#### **WIRELESS COMMUNICATION**

<b>Standard:</b>	IEEE 802.15.4, DSSS
<b>Frequency:</b>	2.4 GHz (2400 to 2483.5 MHz), 16 channels
<b>Network Topology:</b>	Star Topology
<b>Radio Power Output:</b>	100 mW (20 dBm); 10 mW (10 dBm)

**Note** 

Limitations on Equivalent Isotropic Radiated Power (EIRP) levels in the European Community and other countries applies. An improper combination of power level can result in an EIRP above the allowed amount per regulations. See **Appendix H**.

<b>Data Rate:</b>	Bit rate 250 Kp/s; Symbol rate 62.5 Symbol/s; Chip rate 2000 kchip/s
<b>Modulation:</b>	Orthogonal Quaternary Phase Shift Keying (O-QPSK)
<b>Receiver Sensitivity:</b>	-100 dBm
<b>Range:</b>	
<b>zED-VI-P/-LCD/-CCELL</b>	Up to 1000 m (3280 ft) without obstructions
<b>zED-VI-AA/-LCD-AA</b>	or interference

**Note** 

The above ranges assume a line-of-Sight (LOS) between the Meter/Receiver and End Device without obstructions or interference at which the diagnostic signal strength web interface registers approximately 25%.

<b>Antenna Frequency:</b>	2400 to 2500 Mhz
<b>Impedance:</b>	50 ohm
<b>Connector:</b>	Reverse Polarity SMA Plug
<b>Emission Designation:</b>	2M00M1D
<b>Channel Spacing:</b>	5 MHz

## INTERFACE SPECIFICATIONS (zCDR-VI)

<b>Ethernet:</b>	Standards Compliance IEEE 802.3 10Base-T (RJ45)
<b>Supported Protocols:</b>	TCP/IP, ARP, ICMP, DHCP, DNS, HTTP, and Telnet
<b>LED Indicators:</b>	Network Activity, Network Link, Diagnostics, Receive and Power
<b>Management:</b>	Device configuration and monitoring through embedded WEB server
<b>Embedded WEB Server:</b>	Serves WEB pages (Java™ Applets) containing real-time data and live updated charts within definable time intervals

## POWER (zED-VI-P, zED-VI-LCD)

<b>Power Input:</b>	5 Vdc
<b>Consumption:</b>	0.8 W max
<b>Safety Qualified ac Power Adapter (included)</b>	
<b>Nominal Output:</b>	5 Vdc @ 0.6 A
<b>Input:</b>	100 to 240 Vac, 50/60 Hz
<b>Back-up Lithium Battery:</b>	One 3.6 Vdc, supplied; re-order # UWTC-BATT
<b>Lifetime:</b>	Estimated 8 months with frequency of 1 reading per 2 minutes

## POWER (zED-VI-DC-H2)

<b>Power Input:</b>	10 to 30 Vdc, or 24 Vac ±10%
<b>Consumption:</b>	1.1 W
<b>Isolation Dielectric per 60 sec:</b>	1000 Vdc

## POWER (zED-VI-LCD-AA)

<b>Alkaline Battery:</b>	Two AA 1.5 Vdc, supplied
<b>Lifetime:</b>	Estimate of 8 months with frequency of 1 reading per 2 minutes

## POWER (zED-VI-CCELL)

<b>Alkaline Battery:</b>	Two C-cell 1.5 Vdc, supplied
<b>Lifetime:</b>	Estimate of 2.3 years with frequency of 1 reading per 2 minutes

Table 6.1

Alkaline Battery Estimated Lifetime		
Frequency	zED-TC/VI-LCD-AA	zED-TC/VI-CCELL
continuous	5 days	2 weeks
10 sec	5 months	1.4 years
30 sec	7.2 months	2 years
60 sec	7.9 months	2.2 years
120 sec	8 months	2.3 years
300 sec	8.6 months	2.4 years

## POWER (zCDR-VI)

Power Input:	9 to 12 Vdc
Consumption:	2.5 W max.
<b>Safety Qualified ac Power Adapter (included)</b>	
Nominal Output:	9 Vdc @ 0.5 A
Input:	100 to 240 Vac, 50/60 Hz

## ENVIRONMENT

### Operating Temperatures--

zED-P, zED-DC-H2:	-20° to 70°C (-4° to 158°F) 90% RH, non-condensing
zED-CCELL:	-18° to 55°C (0° to 131°F) 90% RH, non-condensing
zED-LCD, zED-LCD-DC-H2:	-10° to 60°C (14° to 140°F) 90% RH, non-condensing
zED-LCD-AA	-10° to 55°C (14° to 131°F) 90% RH, non-condensing
zCDR-VI:	0° to 70°C (32° to 158°F) 90% RH, non-condensing

AC Power Adapter: 0° to 40°C (32° to 104°F)

### Storage Temperatures--

zED-xx-xx:	-40° to 125°C (-40° to 257°F), with exception of batteries
Antenna, and AC Adapter:	-20° to 70°C (-4° to 158°F)

### Weight:

zCDR-VI:	181 g (6.4 oz);
zED-VI-CCELL:	386 g (13.6 oz);
zED-VI-P/-LCD/-H:	323 g (11.4 oz)

## PACKAGING

See **Section 2.0**

## GENERAL

**Software:** The software packages available for the zSeries-VI wireless system are **iConnect** (configuration software for the Ethernet interface), **iLog** (Excel-based software for automatic data logging), and **Mail Notifier** (email alarm notification software).



## **SAFETY & REGULATORY COMPLIANCE**

<b>Safety:</b>	EN60950-1:2006 (IEC 60950-1:2005) Safety Requirement under article 3.1.a of the R&TTE
<b>EMC:</b>	EN 301 489-1, V1.6.1:2005-09 Electromagnetic compatibility article 3.1.b of the R&TTE EN 301 489-17, V1.2.1:2002-08 Electromagnetic compatibility article 3.1.b of the R&TTE EN 55022:2006 + A1:2007, Class B, (CISPR 22 +A1:2005)
<b>Radio:</b>	EN 300 328 V1.7.1:2006-10 Spectrum article 3(2) of the R&TTE
<b>FCC:</b>	Part 15C, Class DTS Intentional radiator tested for 15.205, 15.209, 15.247(d), 15.215(c), 15.247(a)(2), 15.247(b), 15.247(e) (See <b>Appendix H</b> ).
<b>CE:</b>	The product herewith complies with the essential requirements and other relevant provisions of the R&TTE Directive 1999/5/EC, the EMC Directive 2004/108/EC, and the Low Voltage Directive 2006/95/EC, and carries the CE-marking accordingly. The following CE Mark  is affixed to this equipment.

**PART 7**  
**FACTORY PRESET VALUES**

See **Appendix H**. The CE declaration is available at the website listed on the cover page of this manual.

<b>PRESET PARAMETERS</b>	<b>FACTORY DEFAULTS</b>
IP Address	192.168.1.200
Gateway Address	0.0.0.0
Subnet Mask	255.255.255.0
Device Host Name	z and last 4 digits from the MAC address
Login Password	12345678
Admin Password	00000000
DHCP	Disabled
Web Server	Enabled
TCP Connections	1
Port #	2000
Channel	Auto Detect
PID Unit Address	13106 (0x3332)
Group	A
Network ID Address	000
Name	zSeries-VI
End Device Name	ABCDEFGH
Check Box	Checked
Update readings (seconds)	10 seconds
Channel 1	10V
Channel 2	10V
Input Low	0
Reading Low	0
Input High	100
Reading High	100
Unit	unit
<b>DIP Switches:</b>	
Coordinator 4 Position	all OFF
Coordinator 8 Position	all OFF
End Device 8 Position	all OFF

User of this manual should be familiar with following definitions:

**ARP (Address Resolution Protocol)** is a protocol for mapping an Internet Protocol address (IP address) to a physical machine address that is recognized in the local network. For example, the IP address in use today is an address that is 32-bits long. In an Ethernet local area network, however, addresses for attached devices are 48-bits long. (The physical machine address is also known as a Media Access Control or MAC address.) A table, usually called the ARP cache, is used to maintain a correlation between each MAC address and its corresponding IP address. ARP provides the protocol rules for making this correlation and providing address conversion in both directions.

**Ethernet** is a network protocol defined by the IEEE 802.3 standard. Ethernet-based networks use MAC Address rather than IP Address to exchange data between computers. By using ARP and adding TCP/IP support, Ethernet devices may be connected as part of the Internet. An Ethernet LAN typically uses coaxial cable or special grades of twisted pair wires. The most commonly installed Ethernet systems are called 10BASE-T and provide transmission speeds up to 10 Mbps. Devices are connected to the cable and compete for access using a Carrier Sense Multiple Access with Collision Detection (CSMA/CD) protocol.

**IP (Internet Protocol)** is the method or protocol by which data is sent from one computer to another on the Internet.

**IP address (Internet Protocol address)** is a 32-bit number that identifies each sender or receiver of information that is sent in packets across the Internet.

**IP Netmask** is a 32-bit pattern of bits used to determine which part of the IP address is the network portion and which part is the host portion.

**MAC (Media Access Control) Address** is your computer's unique hardware number. When you're connected to the Internet from your computer, a correspondence table relates your IP address to your computer's physical (MAC) address on the LAN.

**Ping** is a utility that tests the network connectivity. It is used to determine if the host is capable of exchanging information with another host.

**Port number/Socket number** is a way to identify a specific process to which an Internet or other network message is to be forwarded when it arrives at a server. It is a predefined address that serves as a route from the application to the Transport layer or from the Transport layer to the application of the TCP/IP system.

**Sockets** are a method for communication between a client program and a server program in a network and defined as "the endpoint in a connection". Information transferred across the Internet primarily occurs between sockets.

**TCP/IP (Transmission Control Protocol/Internet Protocol)** is the basic communication language or protocol of the Internet. When you are set up with direct access to the Internet, your computer is provided with a copy of the TCP/IP program just as every other computer that you may send messages to or get information from also has a copy of TCP/IP. TCP/IP often is used as a general term to indicate generic access to the Internet.

## Appendix B

## IP Address

An IP address is a unique 32-bit address assigned to a computer and includes:

- A network ID number identifying a network.
- A host ID number identifying a computer on the network.

All IP addresses have been divided into three smaller groups (classes) A, B and C

- **Class A** addresses have 8-bits of network ID and 24-bits of host ID. They can support a large number of hosts, approximately  $2^{24} = 16,777,216$  computers per network.

The IP addresses range in binary from 00000001.xxxxxxxx.xxxxxxxx.xxxxxxxx  
to 01111111.xxxxxxxx.xxxxxxxx.xxxxxxxx

The IP addresses range in decimal from 1.x.x.x to 127.x.x.x

Class A network ID's support a very large number of hosts.

- **Class B** addresses have 16-bits of network ID and 16-bits of host ID. They can support approximately  $2^{16} = 65,536$  computers per network.

The IP addresses range in binary from 10000000 00000000.xxxxxxxx.xxxxxxxx  
to 10111111 11111111.xxxxxxxx.xxxxxxxx

The IP addresses range in decimal from 128.0.x.x to 191.255.xxx.xxx

Class B network ID's support a medium number of hosts.

- **Class C** addresses have 24-bits of network ID and 8-bits of host ID. They can support approximately  $2^8 = 256$  computers per network.

The IP addresses range in binary from 11000000.00000000.00000000.xxxxxxxx  
to 11011111.11111111.11111111.xxxxxxxx

The IP addresses range in decimal from 192.0.0.xxx to 223.255.255.xxx

Class C network ID's support a small number of hosts.



The rest of the addresses are divided into two classes, D and E.

**Class D networks** are not assigned to the host. They are used for multicasting.  
The address range from 224.x.x.x to 239.x.x.x

**Class E** networks are experimental or reserved addresses.  
The address range from 240.x.x.x to 247.x.x.x

## Appendix C

## IP Netmask

IP Netmask or Subnet Mask is a 32-bit pattern of ones and zeros used to determine network portion of an IP address from the host portion of the IP address. Subnet mask is a network ID that is created by borrowing bits from host portion of IP address and using them as part of a network ID. The table below shows a default subnet mask for address Classes A, B, and C. Each bit that is set to "1" in the subnet mask corresponds to the bit in the IP address that is to be used as the network ID. Each bit that is set to "0" in the subnet mask corresponds to a bit in the IP address that is to be used as the host ID.

Address Class	Mask Binary Value	Mask Decimal Value or Dotted Notation
Class A	11111111 00000000 00000000 00000000	255.0.0.0
Class B	11111111 11111111 00000000 00000000	255.255.0.0
Class C	11111111 11111111 11111111 00000000	255.255.255.0

If your network requires more network ID's, you can extend the default subnet mask to include additional bits from the host ID. This allows for additional network ID's within the network. The table below shows some examples of subnet masks and bits moved from the hosts ID to create a new subnet.

Mask Dotted Notation	Mask Binary	Mask Bits
<b>Class A</b>		
255.0.0.0 (Default)	11111111 00000000 00000000 00000000	0
255.192.0.0	11111111 11000000 00000000 00000000	2
255.224.0.0	11111111 11100000 00000000 00000000	3
255.240.0.0	11111111 11110000 00000000 00000000	4
255.248.0.0	11111111 11111000 00000000 00000000	5
255.252.0.0	11111111 11111100 00000000 00000000	6
255.254.0.0	11111111 11111110 00000000 00000000	7
255.255.0.0	11111111 11111111 00000000 00000000	8
255.255.128.0	11111111 11111111 10000000 00000000	9
255.255.192.0.0	11111111 11111111 11000000 00000000	10
.....	.....	.
255.255.255.252	11111111 11111111 11111111 11111100	22
<b>Class B</b>		
255.255.0.0 (Default)	11111111 11111111 00000000 00000000	0
255.255.192.0	11111111 11111111 11000000 00000000	2
.....	.....	.
255.255.255.252	11111111 11111111 11111111 11111100	14
<b>Class C</b>		
255.255.255.0 (Default)	11111111 11111111 11111111 00000000	0
255.255.255.192	11111111 11111111 11111111 11000000	2
.....	.....	.
255.255.255.254	11111111 11111111 11111111 11111100	6

To determine the number of valid hosts ID's remaining after subnetting, use the following equation:  $2^n - 2$ , where n is the number of octet digits left after the subnet mask.

## Appendix D

## ASCII Chart

ASCII Char	Dec	Hex	Binary No Parity	ASCII Char	Dec	Hex	Binary No parity
NUL	00	00	00000000	@	64	40	01000000
SOH	01	01	00000001	A	65	41	01000000
STX	02	02	00000010	B	66	42	01000010
ETX	03	03	00000011	C	67	43	01000011
EOT	04	04	00000100	D	68	44	01000100
ENQ	05	05	00000101	E	69	45	01000101
ACK	06	06	00000110	F	70	46	01000110
BEL	07	07	00000111	G	71	47	01000111
BS	08	08	00001000	H	72	48	01001000
HT	09	09	00001001	I	73	49	01001001
LF	10	0A	00001010	J	74	4A	01001010
VT	11	0B	00001011	K	75	4B	01001011
FF	12	0C	00001100	L	76	4C	01001100
CR	13	0D	00001101	M	77	4D	01001101
SO	14	0E	00001110	N	78	4E	01001110
SI	15	0F	00001111	O	79	4F	01001111
DLE	16	10	00010000	P	80	50	01010000
DC1	17	11	00010001	Q	81	51	01010001
DC2	18	12	00010010	R	82	52	01010010
DC3	19	13	00010011	S	83	53	01010011
DC4	20	14	00010100	T	84	54	01010100
NAK	21	15	00010101	U	85	55	01010101
SYN	22	16	00010110	V	86	56	01010110
ETB	23	17	00010111	W	87	57	01010111
CAN	24	18	00011000	X	88	58	01011000
EM	25	19	00011001	Y	89	59	01011001
SUB	26	1A	00011010	Z	90	5A	01011010
ESC	27	1B	00011011	[	91	5B	01011011
FS	28	1C	00011100	\	92	5C	01011100
GS	29	1D	00011101	]	93	5D	01011101
RS	30	1E	00011110	^	94	5E	01011110
US	31	1F	00011111	_	95	5F	01011111
SP	32	20	00100000	`	96	60	01100000
!	33	21	00100001	a	97	61	01100001
"	34	22	00100010	b	98	62	01100010
#	35	23	00100011	c	99	63	01100011
\$	36	24	00100100	d	100	64	01100100
%	37	25	00100101	e	101	65	01100101
&	38	26	00100110	f	102	66	01100110
'	39	27	00100111	g	103	67	01100111
(	40	28	00101000	h	104	68	01101000
)	41	29	00101001	i	105	69	01101001
*	42	2A	00101010	j	106	6A	01101010
+	43	2B	00101011	k	107	6B	01101011
,	44	2C	00101100	l	108	6C	01101100
-	45	2D	00101101	m	109	6D	01101101
.	46	2E	00101110	n	110	6E	01101110

**Appendix D****ASCII Chart Continuation**

/	47	2F	00101111	o	111	6F	01101111
0	48	30	00110000	p	112	70	01110000
1	49	31	00110001	q	113	71	01110001
2	50	32	00110010	r	114	72	01110010
3	51	33	00110011	s	115	73	01110011
4	52	34	00110100	t	116	74	01110100
5	53	35	00110101	u	117	75	01110101
6	54	36	00110110	v	118	76	01110110
7	55	37	00110111	w	119	77	01110111
8	56	38	00111000	x	120	78	01111000
9	57	39	00111001	y	121	79	01111001
:	58	3A	00111010	z	122	7A	01111010
;	59	3B	00111011	{	123	7B	01111011
<	60	3C	00111100		124	7C	01111100
=	61	3D	00111101	}	125	7D	01111101
>	62	3E	00111110	~	126	7E	01111110
?	63	3F	00111111	DEL	127	7F	01111111

**ASCII Control Codes**

ASCII Char	Dec	Hex	Ctrl Key Equiv.	Definition	ASCII Char	Dec	Hex	Ctrl Key Equiv.	Definition
NUL	00	00	Ctrl @	Null Character	DC1	17	11	Ctrl Q	Data Control 1 - XON
SOH	01	01	Ctrl A	Start of Header	DC2	18	12	Ctrl R	Data Control 2
STX	02	02	Ctrl B	Start of Text	DC3	19	13	Ctrl S	Data Control 3 - XOFF
ETX	03	03	Ctrl C	End of Text	DC4	20	14	Ctrl T	Data Control 4
EOT	04	04	Ctrl D	End of Transmission	NAK	21	15	Ctrl U	Negative Acknowledge
ENQ	05	05	Ctrl E	Inquiry	SYN	22	16	Ctrl V	Synchronous Idle
ACK	06	06	Ctrl F	Acknowledge	ETB	23	17	Ctrl W	End of Trans Block
BEL	07	07	Ctrl G	Bell	CAN	24	18	Ctrl X	Cancel
BS	08	08	Ctrl H	Back Space	EM	25	19	Ctrl Y	End of Medium
HT	09	09	Ctrl I	Horizontal Tabulation	SUB	26	1A	Ctrl Z	Substitute
LF	10	0A	Ctrl J	Line Feed	ESC	27	1B	Ctrl [	Escape
VT	11	0B	Ctrl K	Vertical Tabulation	FS	28	1C	Ctrl \	File Separator
FF	12	0C	Ctrl L	Form Feed	GS	29	1D	Ctrl ]	Group Separator
CR	13	0D	Ctrl M	Carriage Return	RS	30	1E	Ctrl	Record Separator
SO	14	0E	Ctrl N	Shift Out	US	31	1F	Ctrl _	Unit Separator
SI	15	0F	Ctrl O	Shift In	SP	32	20		Space
DLE	16	10	Ctrl P	Data Link Escape					

**Appendix E****iLog Error Messages**

<b>Error #</b>	<b>Description</b>	<b>Note</b>
-8003	User stopped logging readings.	
-10005	Failed to find the Coordinator.	Ethernet cable is disconnected, Coordinator is powered off, connections across the firewall require longer "connection to socket time out" setting.
-10006	Windows socket was closed.	
-10007	Windows socket error.	Wrong IP or wrong Port number was used.
-10008	The Coordinator failed to respond to a request.	Wrong IP or wrong Port number was used.
-10011	Response came empty.	No data was sent.
-10012	Device responded with "Serial Time Out" string.	Possibly the iLog is configured for wrong product model.
-10014	Terminal Server Mode when the Port is 1000.	Try Port 2000 in iLog configuration.



## Appendix F ASCII / TELNET COMMANDS TABLE

Command	Device / Group ID	Description (see notes below if *)	Example
ERCR	Device ID: 000 – 031	Get continuous readings from an End Device (only -TC & -VI)	Get reading for sensor 7, ERCR007
ERDB	Device ID: 000 – 031	Get sensor readings of an End Device	Get reading for sensor 15, ERDB015
ERDR	Device ID: 000 – 031 Reading/parameter: a-s *4	Get individual reading or parameter	Get the first temp. reading for sensor 1, ERDR001c
ERDG	Group ID: 00A - 00D, ALL *5	Get sensor readings of a group / groups of sensors	Get readings for all group B, ERDG00B
EQNF	Device ID: 000 – 031	Get name, *3 status and firmware version of an End Device	Get name for sensor 15, EQNF015
EQNG	Group ID00A - 00D, ALL	Get name, *3 status and firmware version of a group/all groups of sensors	Get name for all sensors, EQNGALL
EQPE	Device ID: 000 – 031	Get sleep period, battery voltage, signal strength, success, network address and parent address of an End Device	Get sleep period for sensor 15, EQPE015
EQPG	Group ID: 00A - 00D	Get sleep period, battery voltage, signal strength, success, network address and parent address of a group / all groups of sensors	Get sleep period of group B, EQPG00B
ESPD	Device ID: 000-031, ALL	Set the sleep period for an End Device / all sensors *1	Set sensor 15's sleep period to 30 seconds, ESPD015 30
ESNM	Device ID: 000 – 031	Set the name of an End Device *2	Set the name of sensor 15, ESNM015 z15
ERST	Device ID: 000 – 031, ALL	Reset an End Device / all sensors	Reset all sensors, ERSTALL
ESTR	Device ID: 000 – 031, ALL	Request End Device(s) to go into identify mode	Put all sensors into identify mode, ESTRALL
ESTP	Device ID: 000 – 031, ALL	Request End Device(s) to resume normal operation	Resume all sensor to normal operation, ESTPALL
CRST		Reset wireless network	Reset network, CRST
CSTS		Get personal network ID and channel information	Get wireless network information, CSTS
FACTORY AdminPassword		Sets the Coordinators Ethernet configurations to Factory Defaults	FACTORY xxxxxxxx xxxxxxx is the Admin Password

\*1 Argument: 1 – 32767 (1 seconds to about 9 hours)

\*2 Argument: xxxxxxxx (8 characters)

\*3 and \*4 See the following page

\*5 Refer to **Section 4.5.1** HTTPget using Port 2000

## Appendix F ASCII /TELNET COMMANDS TABLE (continued)

\* An example of the status of an End Device

Command: **EQNG00A**

Response: **7 EngrLAB 01000010 2.0**

**7** is the Device ID (DID) of the End Device.

**EngrLAB** is the name for the End Device.

**"01000010"** is the bitmap representation of the internal state. The meaning for each bit is described below (bit 7 starts from the left).

**2.0** is version of the firmware in the End Device.

<p><b>Bit 7</b> not used.</p> <hr/> <p><b>Bit 6</b> shows if the communication to the End Device is lost. '1' means there has not been any data received from that particular End Device for 1 minute or 4 times the update rate, whichever is a longer time interval.</p> <hr/> <p><b>Bit 5</b> shows if there is more than one End Device having the same dip switch configuration. '1' means more than 1 End Device has the same Network ID and Device ID.</p> <hr/> <p><b>Bit 4</b> shows if there is any pending "identify mode request" command for the End Device. '1' means a "start" command is issued.</p>	<p><b>Bit 3</b> not used</p> <hr/> <p><b>Bit 2</b> shows if there is any pending "reset" command for the End Device. '1' means a "reset" command is issued.</p> <hr/> <p><b>Bit 1</b> shows the source of power supply to the End Device. '1' means it's powered by an adapter and '0' means it's powered by batteries.</p> <hr/> <p><b>Bit 0</b> shows the operation mode of the End Device. '1' means it is in identification mode and '0' means it is in normal operation mode.</p>
--	--

Based on the above information, End Device # 7 has not been communicating with the Coordinator and its power is supplied by an adapter.

### Reading/parameter for ERDR command

Options (lower case)	Reading/parameter
a	Sequence number
b	Device type
c	First temp / error message
d	First RH / barometric pressure / error message
e	Second temp / error message
f	Second RH / barometric pressure / error message
i	Update rate
j	Battery voltage
k	Signal strength
l	Success rate
q	Name
r	Status
s	Firmware version

### End Device Types

Both Channels Enabled	24
Only Channel 1 Enabled	25
Only Channel 2 Enabled	26

## Appendix G                      Frequently Asked Questions (FAQ)

**Q:** Java applet is not loaded?

**A:** Check Java Setting (icon in Control Panel). Make sure cache is disabled and your web browser is enabled for Java.

**Q:** I do not see any readings even if the applet is loaded, what could be wrong?

**A:** 1) Make sure the Coordinator and the End Device have the same Network ID (NID).

2) Check if the battery is still good. You should be able to see the blue LED when you power the End Device on.

3) If the End Device keeps blinking every second after it is powered on, that means it cannot find the Coordinator. Try to adjust the antenna and relocate the End Device according to **Section 5.1**.

**Q:** What are the error messages that appear on the "Reading", "Chart", and "Diagnostic" pages?

### **ID**

**A:** It means that there are more than one End Device sharing the same Device ID (DIP switches #1-5).

Remember, each sensor should have a unique Device ID in the same wireless network. Turning the device into Identify Mode may help searching for the physical location of such End Devices. Once the problem is resolved, click on the "Reset Sensor" button located on the Sensors Parameters page to remove the "**ID**" error code.

### **Lost**

**A:** It means that the End Device found the Coordinator when it was powered on, but it cannot communicate with it currently.

Make sure the Coordinator and the End Device have the same Network ID (NID). Also, make sure the Coordinator is powered on, the IEEE802.15.4 communication channel is unchanged, DIP switch **#1** (of the 8-DIP switch row) on the Coordinator was ON during the last Coordinator's power reset, and there is no obstructive objects blocking the communications path (see **Section 5** for more details). If the obstructive object is only temporary, you will get the sensor readings once the path is open.

**Q:** Nothing happens when I click on the Data Logging button, what could be wrong?

**A:** The Java policy file is not setup properly. Make sure you get a Java policy file and copy it to a folder in the host computer. Then input the java runtime argument in Java Setup (Control Panel) with the appropriate path to the policy file. Close all web browser and re-open the applet again. See Java Setup **Section**.

## Appendix G Frequently Asked Questions (FAQ) (continued)

**Q:** The Chart trend line for all the variables are broken, what could be wrong?

**A:** It indicates that a TCP connection to the Coordinator was timed-out and no data was obtained. Make sure the Coordinator is still on in the network and powered up. If there are too many broken lines, it may indicate that the network load is too heavy.

**Q:** The trend line for one of my sensors inside one End Device is broken, what could be wrong?

**A:** It indicates that TCP connection to the Coordinator is good but the Coordinator did not have any readings from the corresponding End Device. Make sure End Device is still blinking according to the update rate. It could be caused by a reset/power cycling of the Coordinator as well.

**Q:** Nothing happens when I click on the Save Current Graph button, what could be wrong?

**A:** The Java policy file is not setup properly. Make sure you get a Java policy file and copy it to a folder in the host computer. Then input the java runtime argument in Java Setup (Control Panel) with the appropriate path to the policy file. Close all web browser and re-open the applet again. See Java Setup **Section**.

**Q:** Nothing is shown inside the Diagnostic page/applet, what could be wrong?

**A:** The first thing you want to try is to click your mouse right inside the box. Then minimize and restore the web browser. Try to move the scrollbar as well. If nothing works after about a minute, check the TCP connection to the Coordinator.

**Q:** The End Device repeatedly makes 4 blinks every 2 seconds and then goes off for 3 minutes, what does this mean?

**A:** It is equivalent to getting a "Lost" message in the Java applets. It means that the End Device found the Coordinator when it was powered on, but it cannot communicate with it currently. Make sure the Coordinator and the End Device have the same Network ID (NID). Also, make sure the Coordinator is powered on, the IEEE802.15.4 communication channel is unchanged, the first DIP switch (of the 8-DIP switch row) on the Coordinator was on during the last Coordinator's power reset, and there is no obstructive objects blocking the communications path (see **Section 5** for more details). If the obstructive object is only temporary, you will get the sensor readings once the path is open.

**Q:** While the End Device is up and running I notice a sequence of blinking patterns that seem to repeat themselves, what could be wrong?

**A:** It means that the End Device needs several retransmissions before getting an acknowledgement packet back from the Coordinator. This indicates a reduced performance since more retransmissions required. Retransmissions consume power and cause shorter battery lifetime. Adjust the antenna and relocate the End Device for better communications. See **Section 5** for more details.

## Appendix H Warnings and Regulatory Information



In order to comply with FCC radio frequencies (RF) exposure limits, dipole antennas should be located at a minimum 7.9" (200mm) or more from the body of all persons.

This device complies with part 15 rules. Operation is subject to the following two conditions:

- 1) this device may not cause harmful interference, and
- 2) this device must accept any interference received, including interference that may cause undesired operation.

This equipment has been tested and found to comply with the limits of a Class B digital device, pursuant to Part 15 of the FCC Rules. These limits are designed to provide reasonable protection against harmful interference when the equipment is operated in a residential environment. This equipment generates, uses, and radiates radio frequency energy, and if not installed and used in accordance with the instructions, may cause harmful interference. However, there is no guarantee that interference will not occur. If this equipment does cause interference to radio or television reception, which can be determined by turning the equipment off and on, the user is encouraged to correct the interference by one of the following measures:

- Reorient or relocate the receiving antenna.
- Increase separation between the equipment and receiver.
- Connect the equipment to an outlet on a circuit different from which the receiver is connected.
- Consult dealer or an experienced radio/TV technician.



The following alert sign indicates that there are restrictions on usage of the equipment in regards to power limitations on Equivalent Isotropic Radiated Power (EIRP) levels in the European Community.

### The following are user restrictions:

- Wideband Data Transmission Systems on the band 2400 – 2483.5 MHz in Europe is limited to a Maximum of 10 mW (10dBm) for Direct Sequence Spread Spectrum (DSSS). See Annex 3 of ERC/REC 70-03, decision ERC/DEC/ (01)07.
- Combinations of power levels and antennas resulting in a radiated power level above 10 mW - EIRP for Direct Sequence Spectrum (DSSS) devices are considered as not compliant, and are not allowed for use within the European Community and other countries that have adopted the European R&TTE directive 1995/5/EC or the CEPT recommendation ERC/REC 70-03 or both.
- The users in Europe are instructed to change the default 20 dBm level to 10 dBm via the Web Interface of the Coordinator. The End Devices will follow the power level set on the Coordinator upon power-up; failure to change the default U.S.A. power level setting will violate the regulations requirements for Europe

## Appendix H                      Warnings and Regulatory Information (continued)

### UNIT'S MAXIMUM POWER LEVELS AND ANTENNA GAINS

	Antenna Gain	SMA Connector Output, Max	Maximum Radiated
<b>U.S.A (Regulatory 1000mW (30dBm))</b>	2.0 - 2.2 dBi	18.0 dBm	20 dBm
<b>EUROPE (Regulatory 10mW (10dBm)) (DSSS)</b>	2.0 - 2.2 dBi	7.0 - 7.5 dBm	10 dBm

**Note** 

The default 20 dBm must be changed to 10 dBm to comply with power level regulations. The 0.5 dBm variation depends on the internal DC power used (3V, 3.3V, 3.7V max) of the different model.









## Warranty/Disclaimer

NEWPORT Electronics, Inc. warrants this unit to be free of defects in materials and workmanship for a period of **one (1) year** from the date of purchase. In addition to NEWPORT's standard warranty period, NEWPORT Electronics will extend the warranty period for **one (1) additional year** if the warranty card enclosed with each instrument is returned to NEWPORT.

If the unit should malfunction, it must be returned to the factory for evaluation. NEWPORT's Customer Service Department will issue an Authorized Return (AR) number immediately upon phone or written request. Upon examination by NEWPORT, if the unit is found to be defective it will be repaired or replaced at no charge. NEWPORT's WARRANTY does not apply to defects resulting from any action of the purchaser, including but not limited to mishandling, improper interfacing, operation outside of design limits, improper repair, or unauthorized modification. This WARRANTY is VOID if the unit shows evidence of having been tampered with or shows evidence of being damaged as a result of excessive corrosion; or current, heat, moisture or vibration; improper specification; misapplication; misuse or other operating conditions outside of NEWPORT's control. Components which wear are not warranted, including but not limited to contact points, fuses, and triacs.

**NEWPORT is pleased to offer suggestions on the use of its various products. However, NEWPORT neither assumes responsibility for any omissions or errors nor assumes liability for any damages that result from the use of its products in accordance with information provided by NEWPORT, either verbal or written. NEWPORT warrants only that the parts manufactured by it will be as specified and free of defects. NEWPORT MAKES NO OTHER WARRANTIES OR REPRESENTATIONS OF ANY KIND WHATSOEVER, EXPRESSED OR IMPLIED, EXCEPT THAT OF TITLE, AND ALL IMPLIED WARRANTIES INCLUDING ANY WARRANTY OF MERCHANTABILITY AND FITNESS FOR A PARTICULAR PURPOSE ARE HEREBY DISCLAIMED. LIMITATION OF LIABILITY: The remedies of purchaser set forth herein are exclusive and the total liability of NEWPORT with respect to this order, whether based on contract, warranty, negligence, indemnification, strict liability or otherwise, shall not exceed the purchase price of the component upon which liability is based. In no event shall NEWPORT be liable for consequential, incidental or special damages.**

CONDITIONS: Equipment sold by NEWPORT is not intended to be used, nor shall it be used: (1) as a "Basic Component" under 10 CFR 21 (NRC), used in or with any nuclear installation or activity; or (2) in medical applications or used on humans. Should any Product(s) be used in or with any nuclear installation or activity, medical application, or used on humans, or misused in any way, NEWPORT assumes no responsibility as set forth in our basic WARRANTY / DISCLAIMER language, and additionally purchaser will indemnify NEWPORT and hold NEWPORT harmless from any liability or damage whatsoever arising out of the use of the Product(s) in such a manner.

## Return Requests/Inquiries

Direct all warranty and repair requests/inquiries to the NEWPORT Customer Service Department. **BEFORE RETURNING ANY PRODUCT(S) TO NEWPORT, PURCHASER MUST OBTAIN AN AUTHORIZED RETURN (AR) NUMBER FROM NEWPORT'S CUSTOMER SERVICE DEPARTMENT (IN ORDER TO AVOID PROCESSING DELAYS).** The assigned AR number should then be marked on the outside of the return package and on any correspondence.

The purchaser is responsible for shipping charges, freight, insurance and proper packaging to prevent breakage in transit.

FOR **WARRANTY** RETURNS, please have the following information available **BEFORE** contacting NEWPORT:

1. P.O. number under which the product was **PURCHASED**,
2. Model and serial number of the product under warranty, and
3. Repair instructions and/or specific problems relative to the product.

FOR **NON-WARRANTY** REPAIRS, consult NEWPORT for current repair charges. Have the following information available **BEFORE** contacting NEWPORT:

1. P.O. number to cover the **COST** of the repair,
2. Model and serial number of product, and
3. Repair instructions and/or specific problems relative to the product.

NEWPORT's policy is to make running changes, not model changes, whenever an improvement is possible. This affords our customers the latest in technology and engineering.

NEWPORT is a registered trademark of NEWPORT Electronics, Inc.

© Copyright 2012 NEWPORT Electronics, Inc. All rights reserved. This document may not be copied, photocopied, reproduced, translated, or reduced to any electronic medium or machine-readable form, in whole or in part, without prior written consent of NEWPORT Electronics, Inc.

For immediate technical or application assistance please call:

**1-800-6397678®**  
**1-800-NEWPORT**

---

Newport Electronics, Inc.  
2229 South Yale Street • Santa Ana, CA • 92704 • U.S.A.  
TEL: (714) 540-4914 • FAX: (203) 968-7311  
Toll Free: 1-800-639-7678 • [www.newportUS.com](http://www.newportUS.com) • e-mail: [info@newportUS.com](mailto:info@newportUS.com)  
ISO 9001 Certified

---

Newport Technologies, Inc.  
976 Bergar • Laval (Quebec) • H7L 5A1 • Canada  
TEL: (514) 335-3183 • FAX: (514) 856-6886  
Toll Free: 1-800-639-7678 • [www.newport.ca](http://www.newport.ca) • e-mail: [info@newport.ca](mailto:info@newport.ca)

---

Newport Electronics, Ltd.  
One Omega Drive • River Bend Technology Centre  
Northbank, Irlam • Manchester M44 5BD • United Kingdom  
Tel: +44 161 777 6611 • FAX: +44 161 777 6622  
Toll Free: 0800 488 488 • [www.newportuk.co.uk](http://www.newportuk.co.uk) • e-mail: [sales@newportuk.co.uk](mailto:sales@newportuk.co.uk)

---

Newport Electronics B.V. - Benelux  
Managed by the United Kingdom Office  
TEL: +31 20 3472121 • FAX: +31 20 6434643  
Toll Free: 0800 0993344 • [www.newport.nl](http://www.newport.nl) • e-mail: [info@newport.nl](mailto:info@newport.nl)

---

Newport Electronics spol s.r.o.  
Frystatska 184, 733 01 Karviná • Czech Republic  
TEL: +420 59 6311899 • FAX: +420 59 6311114  
Toll Free: 0800-1-66342 • [www.newport.cz](http://www.newport.cz) • e-mail: [info@newport.cz](mailto:info@newport.cz)

---

Newport Electronics GmbH  
Daimlerstrasse 26 • D-75392 Deckenfronn • Germany  
TEL: 49 7056 9398-0 • FAX: 49 7056 9398-29  
Toll Free: 0800 / 6397678 • [www.newport.de](http://www.newport.de) • e-mail: [sales@newport.de](mailto:sales@newport.de)

---

Newport Electronique S.A.R.L. - France  
Managed by the United Kingdom Office  
TEL: 01 57 32 48 17 • FAX: 01 57 32 48 18  
Toll Free: 0805 541 038 • [www.newport.fr](http://www.newport.fr) • e-mail: [sales@newport.fr](mailto:sales@newport.fr)

---

Mexico and Latin America  
FAX: 001 (203) 359-7807  
TEL En Español: 001 (203) 359-7803

<b>NEWPORTnet<sup>SM</sup> On-Line Service</b> <a href="http://www.newportUS.com">www.newportUS.com</a>	<b>Internet e-mail</b> <a href="mailto:info@newportUS.com">info@newportUS.com</a>
--	--



**NEWPORT** Electronics, Inc.