



EMI Filters

advanced EMI protection

Table of Contents

Product Selection Chart	1
EMI Filters - An Introduction	2
SL1 RANGE - Solder Mounted C & Pi Circuit Filters	6
TL1 RANGE - Miniature Threaded C & Pi Circuit Filters	8
SL2 RANGE - Solder Mounted C Circuit Filters	10
SP2 RANGE - Printed Circuit Mounted Pi Filters	12
SM3 RANGE - Surface Mounted Pi Filters	14
PF1 RANGE - Miniature Press Fit C Circuit Filters	16
TH1 RANGE - Miniature Threaded Coaxial Capacitors	18
TH2 RANGE - Miniature Threaded Coaxial Capacitors	20
TH3 RANGE - Miniature Threaded C Circuit Filters	22
TV3 RANGE - Miniature Threaded TVS C Circuit Filters	24
TL4 RANGE - Miniature/Microslim Threaded C & L Circuit Filters	26
PL2 RANGE - Panel Mounted L & C Circuit Filters	28
PV2 RANGE - Panel Mounted TVS L & C Circuit Filters	30
PH1 RANGE - Panel Mounted Hermetic Feedthrough Capacitors	32
PH2 RANGE - Panel Mounted Hermetic L Circuit Filters	34
PH3 RANGE - Panel Mounted Hermetic Pi Filters	37
PH4 RANGE - Panel Mounted L Circuit Filters	40
PH5 RANGE - Panel Mounted Hermetic T Filter	42
PH6 RANGE - Panel Mounted Hermetic Twin T & Twin Pi Filters	45
PM5 RANGE - Panel Mounted Multiway L & C Circuit Filters	47
Product Installation and Component Mounting Notes	49
Permissible Mounting Torques and Bulkhead Mounting Details	50
Mounting Panel Thickness Table	51
Nut and Washer Information	52
Application Notes	53

PRODUCT SELECTION CHART

Circuit	Capacitance	Voltage	Current	Family	Mounting	Special Features	Page
C	1000 pF	400	10	SL1	Solder		6
C	47 - 8200 pF	500	10	TL1	Threaded		8
C	10 - 5,000 pF	200	10	SL2	Solder	Hermetic Option	10
C	10 - 5,000 pF	200	10	PF1	Push Fit		16
C	22 - 100,000 pF	300	15	TH1	Threaded		18
C	0.1 - 120 nF	300	10	TH2	Threaded		20
C	22 - 100,000 pF	100	10	TH3	Threaded		22
C	4,700 - 100,000 pF	TVS	10	TV3	Threaded	Transient Voltage Suppression	24
C	330 - 22,000 pF	200	10	TL4	Threaded	Microslim Option	26
C	1.2 μ F	80	10	PL2	Panel		28
C	1.2 μ F	TVS	10	PV2	Panel	Transient Voltage Suppression	30
C	0.01 - 4 μ F	600	15	PH1	Panel	Hermetic	32
C	330 - 22,000 pF	200	10	PM5	Panel	Multiway	47
L	22 - 100,000 pF	200	10	TH1	Threaded		18
L	330 - 22,000 pF	200	10	TL4	Threaded	Microslim Option	26
L	1.2 μ F	80	15	PL2	Panel		28
L	1.2 μ F	TVS	10	PV2	Panel	Transient Voltage Suppression	30
L	0.01 - 3 μ F	600	15	PH2	Panel	Hermetic	34
L	0.01 - 1.4 μ F	600	15	PH4	Panel		40
L	330 - 22,000 pF	200	10	PM5	Panel	Multiway	47
Pi	680 - 5,000 pF	200	10	SL1	Solder		6
Pi	680 - 5,000 pF	350	10	TL1	Threaded		8
Pi	1,500 pF	200	10	SP2	Solder		12
Pi	1,500 - 22,000 pF	200	10	SM3	Surface Mount	Tape & Reel Option	14
Pi	0.01 - 3 μ F	600	10	PH3	Panel	Hermetic	37
T	0.01 - 3 μ F	600	10	PH5	Panel	Hermetic	42
Twin Pi	0.21 - 4 μ F	600	5	PH6	Panel	Hermetic	45
Twin T	0.14 - 3 μ F	600	4	PH6	Panel	Hermetic	45

EMI Filters

Electro Magnetic Interference in its simplest definition is electrical 'noise' on a signal or power line. Radio Frequency Interference is Electro Magnetic Interference (EMI) which affects radio frequencies.

Modern electronics are susceptible to interference and increasingly protection against EMI is a legislative, contractual and safety requirement for telecommunications, avionics, industrial and defence equipment. Many circuits are particularly sensitive to voltage transients or spikes on signal and control lines making them acutely vulnerable to EMI.

Therefore it is essential that equipment operating within this potentially hostile environment is compliant with worldwide electromagnetic standards & legislation to provide both protection and reliability.

There are many routes to ensure that electrical and electronic equipment meets directives on electromagnetic compatibility (EMC). EMC means that equipment has the ability to function as designed, without being adversely affected by an electromagnetic interference and without being the source of such interference.

EMI can be caused by a number of factors; power supplies, high bandwidth signals, radar & radio sources, aerials, high current flows or switching, radar transmitters, motors, computer clocks, electrostatic discharge and of course natural electrical disturbances such as lightning.

The effects of EMI can vary, from image or sound degradation ('snow' or 'hum') through unexpected switching or resetting of controllers to the most severe cases which can lead to total system failure.

Anyone manufacturing, supplying or using critical components, products and systems simply cannot afford to take chances with EMI. This is especially relevant in the defence industry and aerospace where safety and reliability are paramount.

Many of the most critical systems which must be protected against EMI are used by the military but it can also be a factor in a huge range of other areas. For example:

- EMI 'noise' from the subway system caused the failure of Rubens Barichello's gearbox in the Monaco Grand Prix.
- EMI from a signal booster disrupted pilot to air traffic control communication at Luton Airport.
- EMI emanating from new trains introduced in Connecticut caused the track signals to fail.
- EMI generated by a walkie-talkie being used at the Davis-Besse nuclear power plant in Ohio disabled the plant's emergency shutdown system.

So EMI is a threat that has to be taken seriously.

Manufacturers have a dual responsibility. They must ensure that their equipment is protected against EMI. But they must also ensure that their equipment does not cause problems for other equipment or systems. That means EMI filtering is now an essential element of electrical and electronic equipment design.

EMI Protection

Protecting equipment against EMI requires effective screening. The simplest method is to enclose the equipment in a metal conductive box or 'Faraday cage'.

However, in practical terms most equipment requires input and output connections, power cables and signal or control wiring. This cabling can act as antennae – transmitting and receiving the interference, and introducing electrical 'noise' which in turn contaminates other wires and circuits.

This EMI contamination can be countered by capacitive (C) and inductive (L) filtering. The primary function of a filter is to attenuate or reduce the intensity of the high frequency or radio frequency (RF) currents and voltages, which would otherwise cause interference. Low pass filters are designed to pass all frequencies below a specific cut-off level.

A capacitor acts as a 'path to ground/earth' for signals but only at high frequency – which is where the 'noise' is located. Inductors reject the 'noise' back down the line, but allow DC signals to pass through. EMC filter products also incorporate Transient Voltage Suppression (TVS) in many cases to protect against harmful voltage spikes.

Combinations of C and L configuration filters can be specified to deliver various performance characteristics determined the level of attenuation (reduction in intensity) required at various frequencies.

To allow comparison insertion attenuation calculations assume a 50Ohm system but variations to source and load impedances of the circuit can have a great effect and should be considered when selecting the filter configuration.

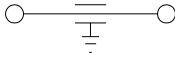
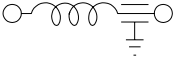
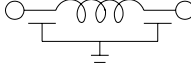
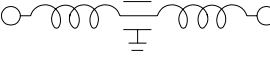
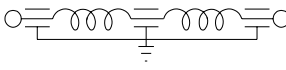
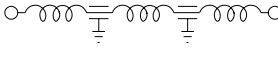
CONFIGURATION	CIRCUIT CONFIGURATION	APPLICATIONS AND ADVANTAGES
C		<ul style="list-style-type: none"> • Higher impedance • Simple construction • Low cost
L		<ul style="list-style-type: none"> • Used when source and load impedances are different • Low cost • Increased filtering at high frequencies
Pi		<ul style="list-style-type: none"> • High impedance systems • Steep interference cut off response
T		<ul style="list-style-type: none"> • Low impedance systems • Steep interference cut off response
2Pi		<ul style="list-style-type: none"> • High impedance systems • Low cut off frequency
2T		<ul style="list-style-type: none"> • Low impedance systems • Low cut off frequency

Most high performance filter solutions utilise one or more of three capacitor technologies:

- single layer tubular capacitors (dry pressed and extruded)
- multilayer discoidal capacitors
- multilayer capacitor planar arrays – custom-designed solutions which achieve multiway filtering in a compact design

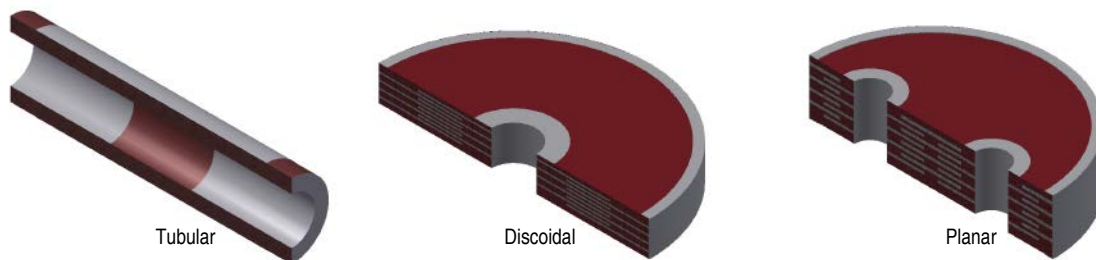

These translate into a range of products:

- **Filtered connectors** integrated into a custom shell or added to a standard shell. Easy and cost effective to assemble in large numbers they offer reduced weight and remove the need for bulkhead fittings.
- **Filtered modules & filter arrays** are generally bespoke designs which can utilise any filter technology including Transient Voltage Suppression (TVS) to protect against voltage spikes. They can also integrate non-filter elements in an interconnect solution. The customer benefits from ease of assembly and avoiding additional connector cost or lead-time.
- **Discrete feedthrough filters** incorporate environmental or hermetic sealing and are designed for threaded, solder-in or push-fit bulkhead mounting. They offer a good performance range and high reliability with integrated TVS protection in a wide product base.
- **Surface mount filters** for printed circuit boards offer good electrical performance across a limited range of frequencies, automated assembly and effective environmental sealing.
- **Capacitor planar arrays** are bespoke interconnect solutions with multiline capacitors located within a single ceramic disc, and offer the customer the option of specifying the electrical characteristic for each line. They are highly reliable, reduce assembly complexity and offer a solution with a comparative low cost per line.

Oxley Group - Proven EMI Protection

Oxley has established itself as a world class provider of EMI suppression capability and integrated solutions for defence, aerospace, rail, electronics and telecommunications applications, meeting the needs of global customers requiring uncompromising quality and reliability in demanding environments across military and industrial platforms.

A leading specialist in the effective suppression of electromagnetic interference through standard and advanced filtering solutions including Transient Voltage Suppression (TVS), Oxley offers customers comprehensive design, manufacturing and test facilities for electronic systems and components within the company's UK manufacturing centre and through Oxley Inc. in the USA. That represents an extensive core capability for new product development and a rapid turnaround service - even for customised designs.

Oxley filter solutions are used in a wide range of applications. For military customers that includes vehicles and weaponry including IR rifle sights, man-portable and vehicle communication systems, rocket igniter systems, military generators and aircraft ejector seat control circuits and gun control systems, Within the aerospace sector typical uses are aircraft pressure sensors, aero engine controllers, helicopter weight on ground sensors and obstacle avoidance radars. They are also found in train communication systems, security cameras, and crane remote controls, automated cruise controls in cars and in electrical test equipment.

Facilities at Oxley's UK production centre include a ceramic production capability for discoidal, tubular and multiway capacitors, CNC machining, electro-plating, prototype model shop, tool room and dedicated test area. All products are tested to the most rigorous standards, with on-site high voltage and DC and AC burn-in facilities. Company approvals include: BS EN 9100: Rev C, ISO 9001:2000, ISO 14001:2004 and AS9100C.

Innovation, quality and reliability are at the heart of the business to develop powerful bespoke capabilities and deliver products that enhance the capability of platforms and systems across the world, laying the foundations of Oxley's comprehensive product portfolio:

EMI Filters - both discrete and multiline



Ceramic planar capacitor arrays



Arrays of discrete filters

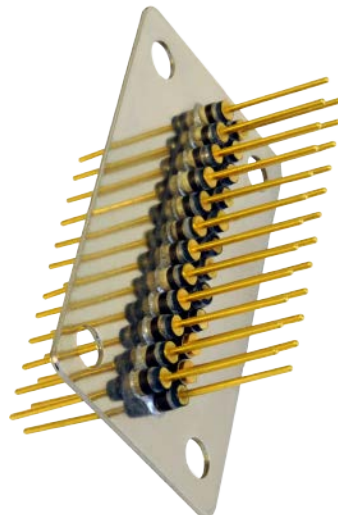

Custom filter modules



Filtering of MIL standard connectors



Threaded, solder, press fit and surface mount styles



Understanding the priorities of the customer is a key element for Oxley in delivering high performance, long term reliability and stable performance over the working temperature range. The experience of manufacturing a wide range of components using standard materials and techniques combines with the expertise and insight gained developing thousands of custom-made solutions to offer outstanding customer benefits:

- Proven reliability both through design and on-site dc/ac burn-in facilities to agreed confidence levels.
- Advanced performance through the use of custom-designed ceramic and Transient Voltage Suppression.
- Minimum size and weight achieved by bespoke ceramic and Transient Voltage Suppression.
- Lower customer costs by integrating the filter capability into the connector or module.

MIL-STD-461 and EMI Filters - Explanation

The US MIL-STD-461 specification regulates the control of electromagnetic interference emissions and susceptibility of equipment. It sets requirements for the levels of emissions allowed to be exported from electrical equipment, and the susceptibility levels of equipment from external noise sources. It also provides guidelines on measuring those features.

If the levels of emissions from equipment exceed the limits set in MIL-STD-461, then they need to be attenuated (reduced in intensity) using an EMI filter. The performance of that filter across the frequency spectrum must allow the equipment emissions to be suppressed to a level low enough to allow the equipment to claim compliance with the limits of the specification. That filter performance requirement is determined by the electromagnetic signature of the equipment, and the specified limits. Compliance can then be verified by test and measurement.

Therefore no filter manufacturer can claim that their filters “meet” MIL-STD-461; because it is the equipment or platform which “meets” the specification - not the filter.

Solder Mounted C and Pi Circuit Filters

[Key Characteristics

Applications

- High density panels
- Bulkhead filter arrays

Rugged

- Robust thick walled tubular construction

Performance

- ≤5nF
- ≤400Vdc
- High frequency
- Temperature -55°C to +125°C

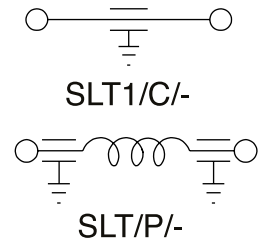
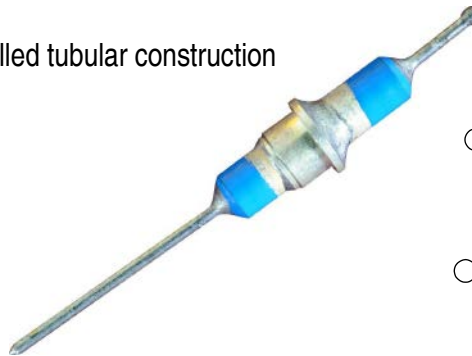

[Electrical Characteristics

Circuit	Cap	Current	Voltage dc	I.L. (dB) 1MHz	10 MHz	100 MHz	1 GHz	10 GHz	Colour Code
C	1000pF	10A	400v	-	5	24	40	65	-
P	680pF	10A	200v*	-	4	35	60	70	Green
P	1500pF	10A	200v*	1	12	50	75	75	Blue
P	5000pF	10A	200v*	4	25	70	75	75	Red

*Voltage derates linearly to 100v dc from 85°C to 125°C

[Ordering Information

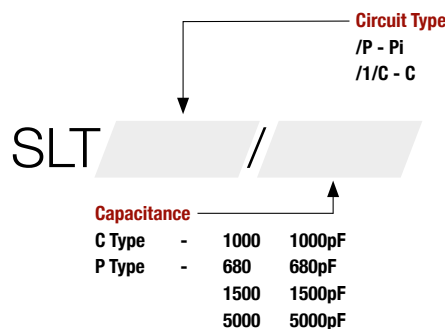

Example: SLTP/P/1500 - Pi Circuit, 1500pF

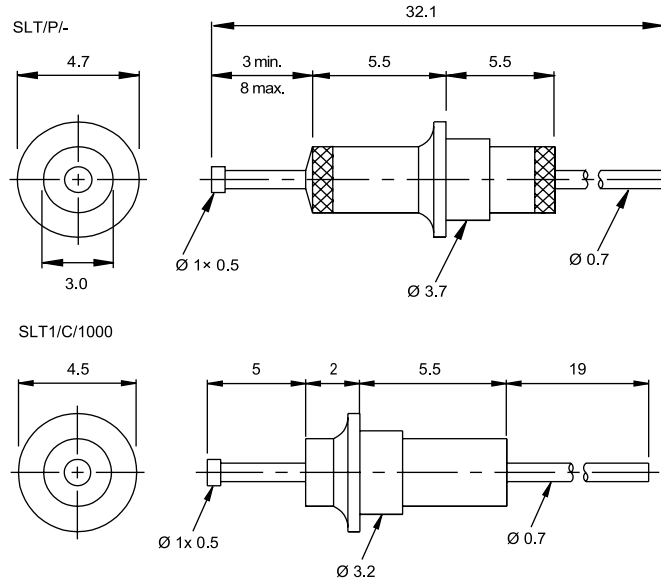

ALL DIMENSIONS IN MM

Mechanical Information

TYPE	MOUNTING HOLE	MINIMUM PITCH
SLT1/C/1000	3.4mm	4.8mm
SLT/P/680	4mm	5mm
SLT/P/1500	4mm	5mm
SLT/P/5000	4mm	5mm

Technical Information

MOUNTING EYELET	Brass, Silver finish
FEED THROUGH TERMINATIONS	Copper Alloy, Tin Lead or Silver finish



SAI GLOBAL
AS9100
Aerospace

*ROHS versions available upon request - please speak to the sales department

Miniature Threaded C and Pi Circuit Filters

[Key Characteristics

Applications

- High density panels
- Bulkhead filter arrays

Rugged

- Robust thick walled tubular construction

Performance

- ≤10nF
- ≤500Vdc
- High frequency
- Temperature -55°C to +125°C

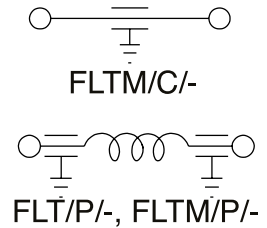

[Electrical Characteristics

Circuit	Cap	Current	Voltage dc	I.L. (dB) 1MHz	10 MHz	100 MHz	1 GHz	Colour Code
C	47pF	10A	500v*	-	-	6	23	Yellow/Yellow
C	470pF	10A	500v*	-	3	18	30	Orange/Orange
C	1000pF	10A	500v*	-	7	26	32	Brown/Brown
C	4700pF	10A	350v*	1	17	34	42	Red/Red
C	8200pF	10A	350v*	6	23	40	50	Dark Blue/Dark Blue
P	680pF	10A	350v**	-	4	35	70	Grey/White
P	1500pF	10A	350v**	1	12	50	75	Red/White
P	5000pF	10A	350v*	4	25	70	75	Green/White

*Voltage derates linearly to 100v dc from 85°C to 125°C
 ** Voltage derates linearly to 200v dc from 85°C to 125°C

[Ordering Information

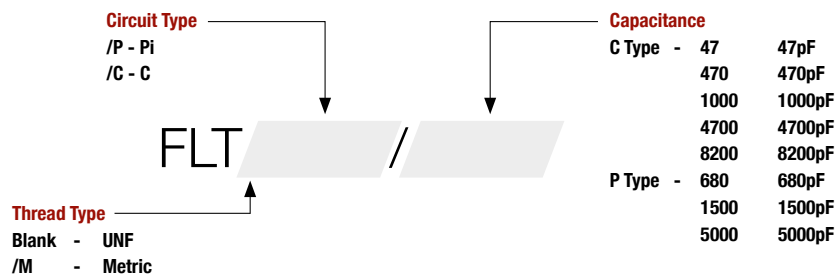

Example: FLTM/P/5000

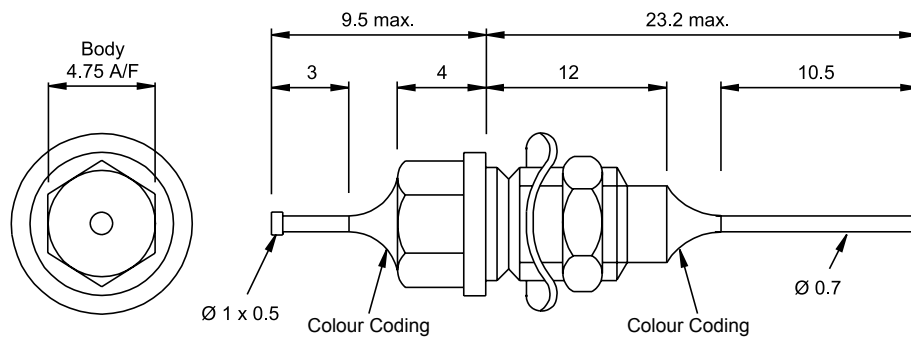

ALL DIMENSIONS IN MM

Mechanical Information

TYPE	FLTM/-	FLT/-
Thread	M5 x 0.8	12-32 UNEF
Mounting Hole Diameter	5.1mm	5.62mm
Chassis Thickness (max.)	3.1mm	3.1mm
Minimum Pitch (with nut)	7.05mm	7.45mm
Minimum Pitch (without nut)	6.5mm	6.5mm
Nut A/F	6mm	6.35mm
Mounting Torque	0.35Nm	0.35Nm

Technical Information

BODY & NUT	Brass, Silver finish
WASHER	Tin plated Beryllium Copper Alloy
TERMINATIONS	Copper Alloy, Tin Lead or Silver finish



SAI GLOBAL
AS9100
Aerospace

*ROHS versions available upon request - please speak to the sales department

Solder Mounted C Circuit Filters

[Key Characteristics

Applications

- High density panels
- Bulkhead filter arrays

Rugged

- Discoidal construction high performance

Performance

- ≤5nF
- ≤200Vdc
- High frequency
- Temperature -55°C to +125°C

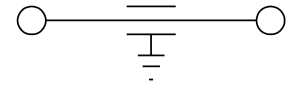

[Electrical Characteristics

Circuit	Cap	Current	Voltage dc	I.L. (dB) 10MHz	100 MHz	1 GHz	10 GHz	Colour Code
C	10pF	10A**	200v*	-	-	7	25	Pink
C	500pF	10A**	200v*	3	20	40	55	Orange
C	1000pF	10A**	200v*	9	26	40	60	Brown
C	2700pF	10A**	200v*	17	35	50	65	Light Green
C	5000pF	10A**	200v*	20	38	53	65	Red

*Voltage derates linearly to 100v dc from 85°C to 125°C
 ** Current on Hermetic version = 5A

[Ordering Information

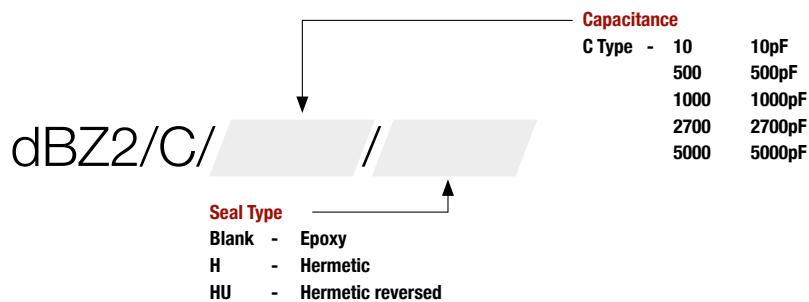

Example: dBZ2/C/2700/HU

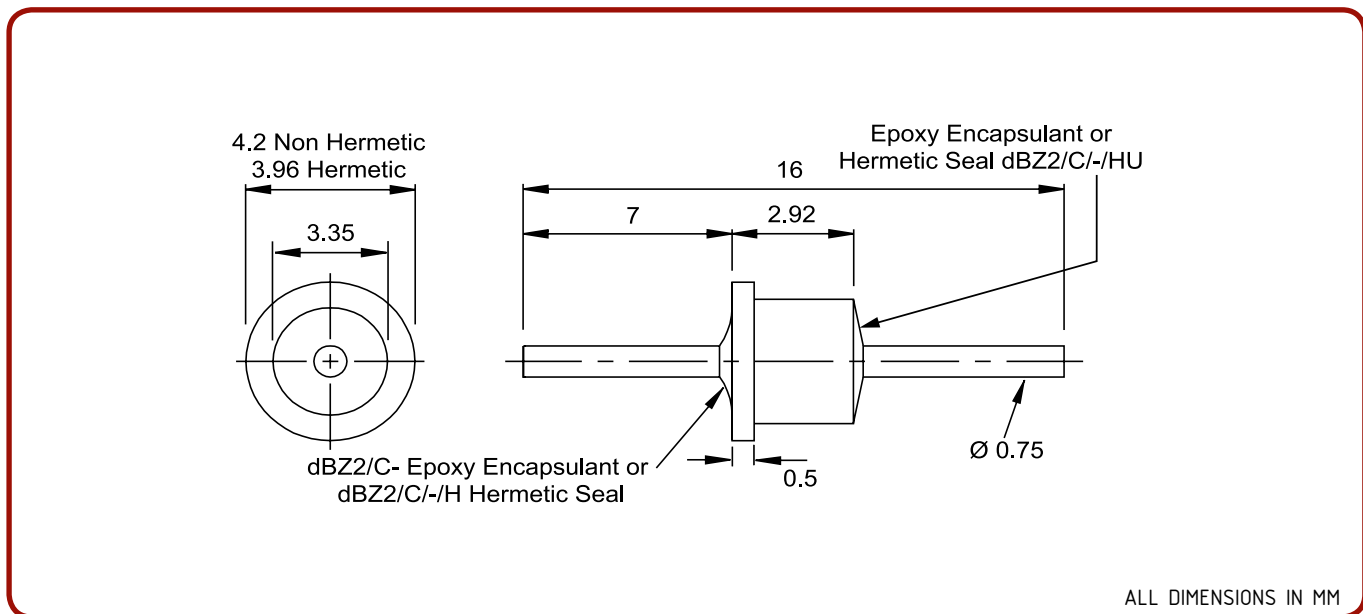

ALL DIMENSIONS IN MM

Mechanical Information

Mounting Hole Diameter	3.5mm
------------------------	-------

Technical Information

BODY HERMETIC	Mild Steel, Gold finish
BODY EPOXY	Brass, Gold finish
FEEDTHROUGH TERMINATIONS HERMETIC	Iron/Cobalt/Nickel Alloy Gold finish
FEEDTHROUGH TERMINATIONS EPOXY	Copper Alloy, Gold finish



SAI GLOBAL
AS9100
Aerospace

*ROHS versions available upon request - please speak to the sales department

Printed Circuit Mounted Pi Filter

[Key Characteristics

Applications

- Printed Circuit Boards

Rugged

- Tubular thick-walled construction

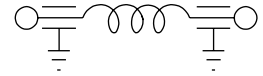

Performance

- 1500pF
- ≤200Vdc
- High frequency
- Temperature -55°C to +125°C



[Electrical Characteristics

Circuit	Cap	Current	Voltage dc	I.L. (dB) 2MHz	10 MHz	50 MHz	100 MHz	500 MHz
Pi	1500pF	10A	200v*	3	22	40	60	60

*Voltage derates linearly to 100v dc from 85°C to 125°C

[Ordering Information

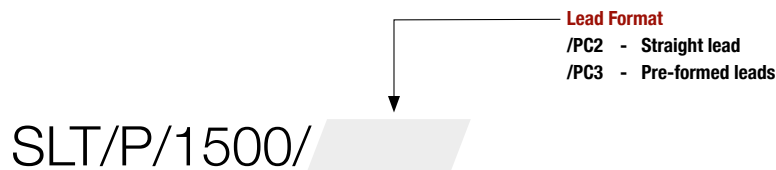

Example: SLT/P/1500/PC3 -

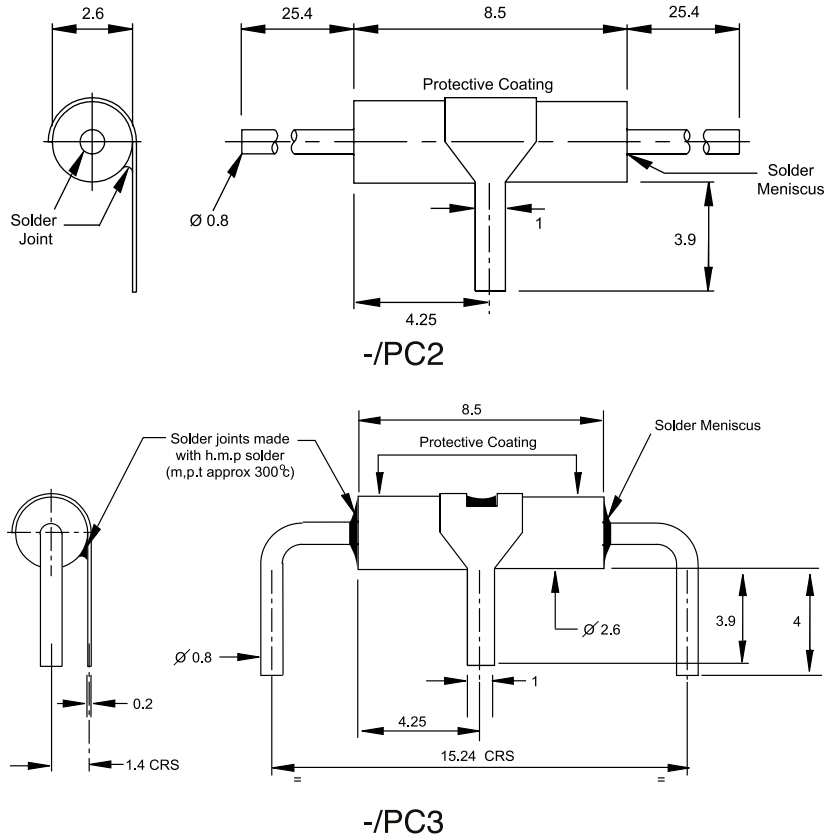

ALL DIMENSIONS IN MM

Technical Information

EARTH TAG	Brass, Tin Lead on area for user soldering, silver finish on remainder
FEED THROUGH TERMINATIONS	Copper Alloy, Tin Lead finish



SAI GLOBAL
AS9100
Aerospace

*ROHS versions available upon request - please speak to the sales department

Surface Mounted Pi Filter

[Key Characteristics

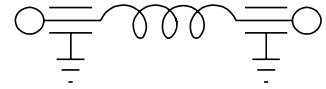

Applications

- Pick and place for printed circuit boards

Performance

- <22nF
- <200Vdc
- High frequency
- Temperature -55°C to +125°C

Rugged

- Discoidal construction for high performance
- High melting point internal construction

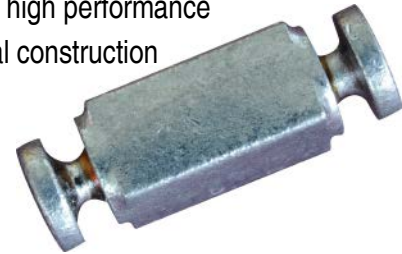

[Electrical Characteristics

Circuit	Cap	Current	Voltage dc	IL (dB) 1MHz	10 MHz	100 MHz	1 GHz	10 GHz
Pi	1500pF	10A	200v*	2	16	50	65	65
Pi	22000pF	10A	200v*	12	48	65	65	65

* Voltage derates linearly to 100v dc from 85°C to 125°C

[Ordering Information

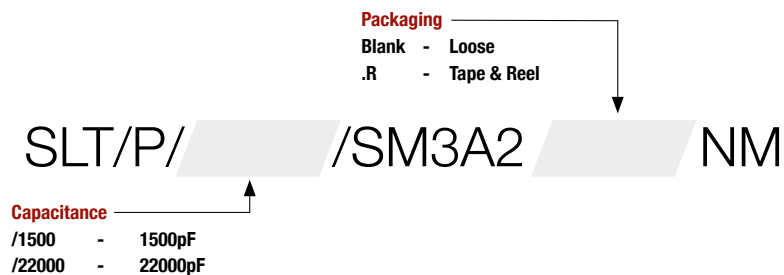

Example: SLT/P/1500/SM3A2.RNM - 1500pF in tape & reel packaging

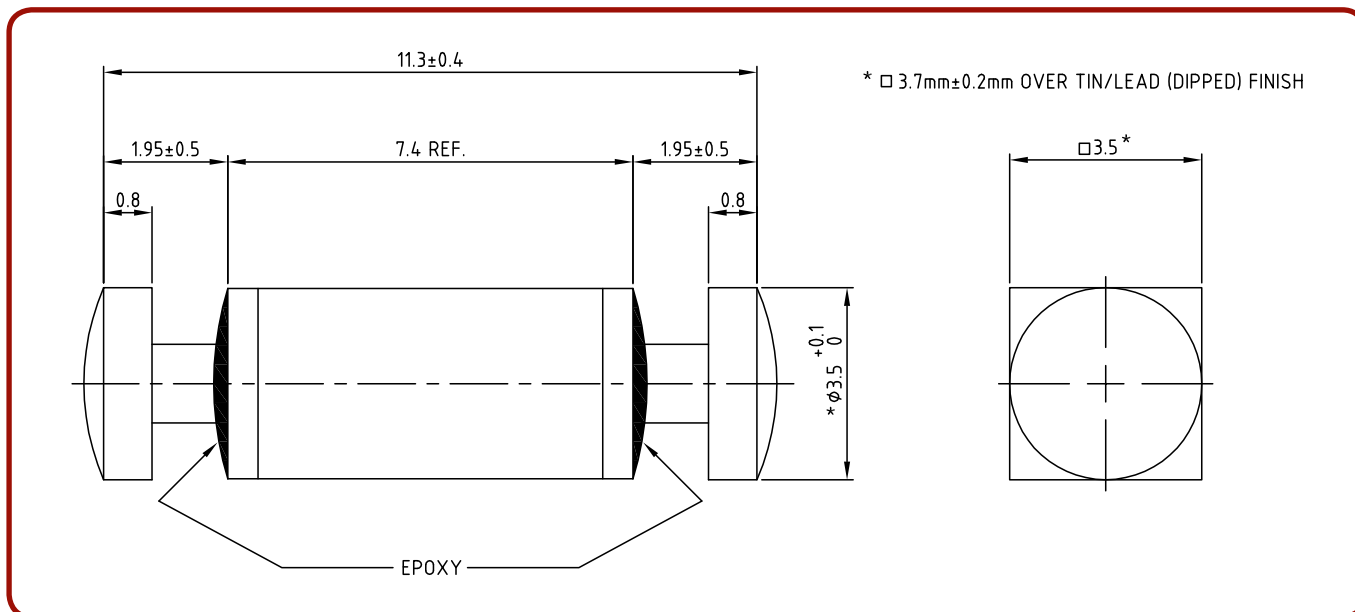

Recommended PCB Track Sizes Dimensions in mm

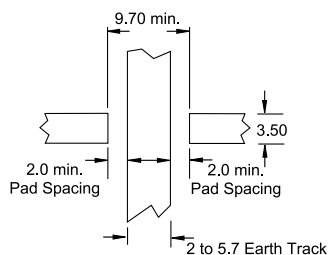

Technical Information

TERMINATION	Tin Lead
TAPE AND REEL INFORMATION	Component is supplied tape and reeled in accordance with BS6062 Part 3 Type II (equivalent to IEC 286-3)
BLISTER TAPE DIMENSIONS	$A_0=4$, $B_0=13$, $K=4$, width=24, pitch=12



Miniature Press Fit C Circuit Filters

[Key Characteristics

Applications

- High density panels
- Bulkhead filter arrays
- Microwave filters and amps

Rugged

- Discoidal construction high performance

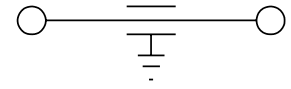

Performance

- ≤5nF
- ≤200Vdc
- High frequency
- Temperature -55°C to +125°C



[Electrical Characteristics

Circuit	Cap	Current	Voltage dc	I.L. (dB) 10MHz	100 MHz	1 GHz	10 GHz	Colour Code
C	10pF	10A	200v*	-	-	7	25	Pink
C	500pF	10A	200v*	3	20	40	55	Orange
C	1000pF	10A	200v*	9	26	40	60	Brown
C	2700pF	10A	200v*	17	35	50	65	Light Green
C	5000pF	10A	200v*	20	38	53	65	Red

*Voltage derates linearly to 100v dc from 85°C to 125°C

[Ordering Information

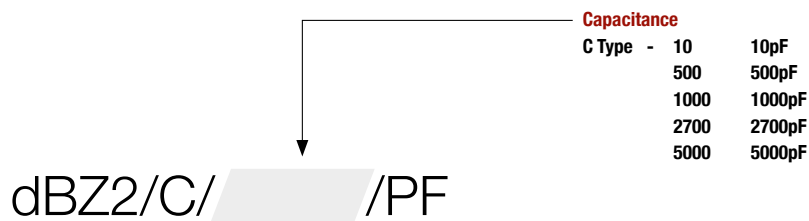

Example: dBZ2/C/2700/PF

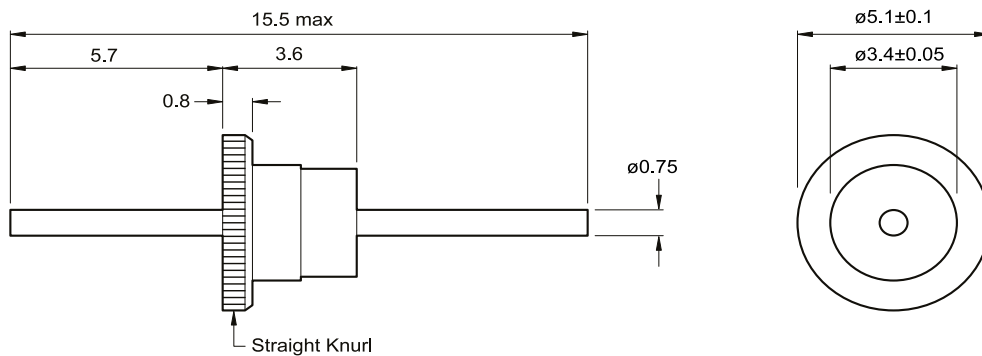

ALL DIMENSIONS IN MM

[Mechanical Information

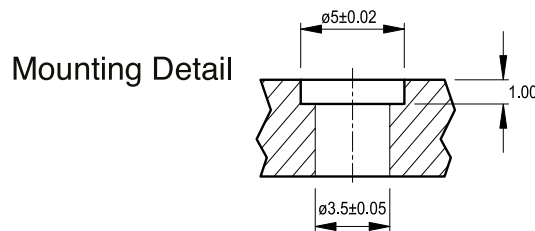

[Technical Information

BODY	Copper Alloy, Gold finish
FEEDTHROUGH TERMINATIONS	Copper Alloy, Gold finish



SAI GLOBAL
AS9100
Aerospace

*ROHS versions available upon request - please speak to the sales department

Miniature Threaded Coaxial Capacitors

[Key Characteristics

Applications

- High density panels
- Bulkhead filter arrays

Performance

- ≤ 100nF
- ≤ 200Vdc
- High Frequency
- Temperature -55° to 125°C

Resilient

- Discoidal construction

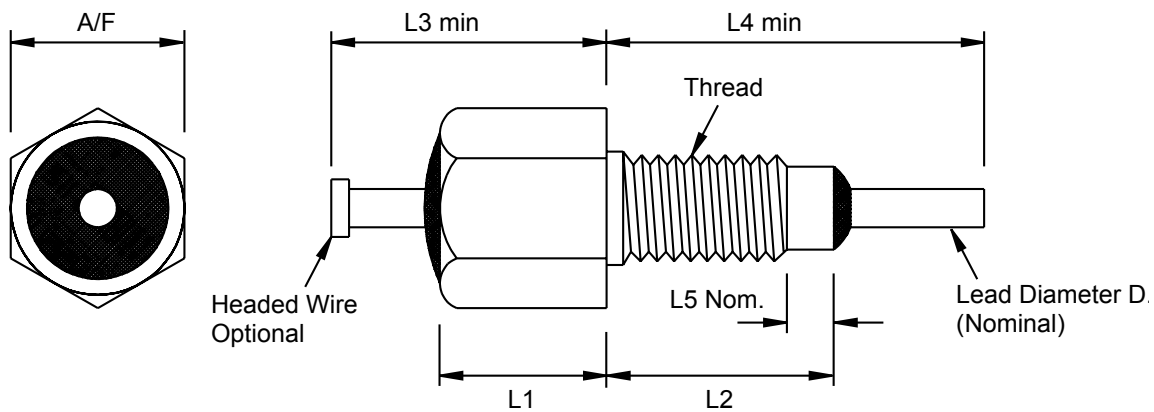
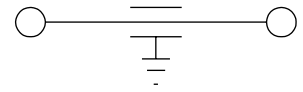

ALL DIMENSIONS IN MM UNLESS OTHERWISE STATED

This range is also available as an LC style filter by the inclusion of inductance within the threaded area. To order, amend code from DCT to DLT.

[Ordering Information

Case Dimensions									
I_	L1	L2	L3	L4	L5	A/F	D	Thread	Max Panel Thickness
/07	3.2	5.9	7.0	23.0	1.25	4.05	0.7	6.32 UNC 2A	2.0
/18	5.0	6.5	25.0	25.0		6.4	0.9	M5 x 0.8	2.5
/19	5.0	6.5	25.0	25.0		6.4	0.9	2BA	2.5
/55	7.0		10.0	3.5	1.25	4.05	0.6	4.40 UNC 2A	1.5

Voltage
4 - 100v
6 - 200v

DCT/ / / / / N/ / / / /

Wire
Blank - Plain wire
P - Headed wire

Finish
Blank - Tin
S - Silver

Capacitance
22P0 - 22pF
100P - 100pF
02N7 - 2700pF
47N0 - 47000pF

Electrical Characteristics

Cap	Current (Amps)	Voltage dc (-55°C to 85°C)	Voltage dc (+125°C)*	Min IR	IL (dB) 10 MHz	100 MHz	1 GHz	10 GHz	Case Dimensions
22pF	10	100v	87v	10GΩ		1	6	33	18 & 19
47pF	10	100v	87v	10GΩ		2	11	35	18 & 19
100pF	10	100v	87v	10GΩ		4	19	37	18 & 19
330pF	10	100v	87v	10GΩ		11	32	47	18 & 19
470pF	10	100v	87v	10GΩ	1	14	36	50	18 & 19
680pF	10	100v	87v	10GΩ	2	17	38	54	18 & 19
1000pF	10	100v	87v	10GΩ	4	20	39	60	18 & 19
4700pF	10	100v	87v	5GΩ	15	33	45	62	18 & 19
10,000pF	10	100v	87v	5GΩ	21	40	48	62	18 & 19
22,000pF	10	100v	87v	5GΩ	28	47	55	65	18 & 19
27,000pF	10	100v	87v	2.5GΩ	30	45	60	65	07 & 55
47,000pF	10	100v	87v	5GΩ	34	53	62	65	18 & 19
50,000pF	10	100v	87v	2.5GΩ	34	53	62	65	07 & 55
100,000pF	10	100v	87v	5GΩ	41	60	65	65	18 & 19
330pF	10	200v	175v	5GΩ	0	11	32	47	07 & 55
680pF	10	200v	175v	5GΩ	2	17	38	54	07 & 55
1000pF	10	200v	175v	5GΩ	4	20	39	60	07 & 55
4700pF	10	200v	175v	5GΩ	15	33	45	62	07 & 55
10,000pF	10	200v	175v	5GΩ	21	40	48	62	07 & 55

*Voltage decreases linearly from 85°C to 125°C

Technical Information

BODY & NUT	Tin or Silver
ENVIRONMENTAL CLASSIFICATION	55/125/56



Miniature Threaded Coaxial Capacitors

[Key Characteristics

Applications

- High density panels
- Bulkhead filter arrays

Performance

- ≤ 120nF
- ≤ 300Vdc
- High Frequency
- Temperature -55° to 125°C

Resilient

- Discoidal construction

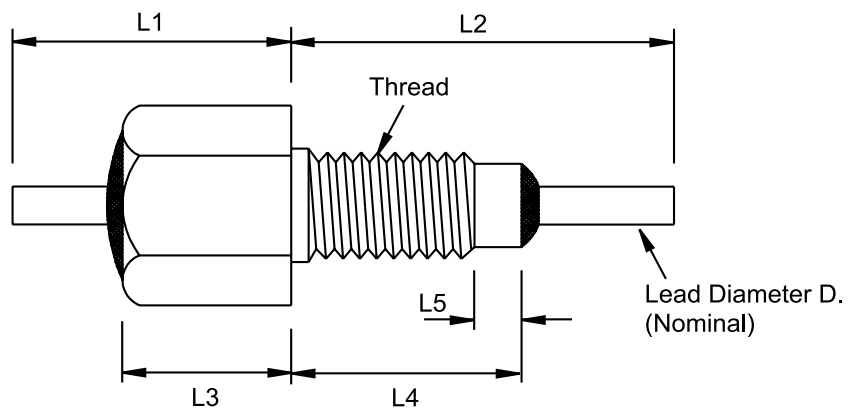
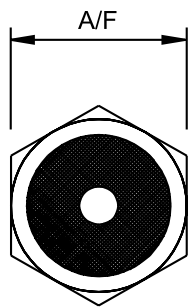
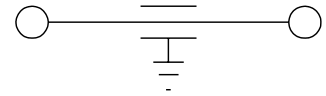

ALL DIMENSIONS ARE MAX AND IN MM UNLESS OTHERWISE STATED

[Ordering Information

Voltage

- 1 - 50v
- 2 - 70v
- 4 - 100v
- 5 - 150v
- 7 - 300v

Case Dimensions

/	L1	L2	L3	L4	L5	A/F	D	Thread	Max Panel Thickness
			+0 -1.5	+0 -1.5					
/05	7.8	10.1	3.5	5.8	1.25	4.05	0.8	4-40 UNC 2A	2.0
/06	12.5	15.0	3.0	5.8	1.25	4.05	0.8	M3 x 0.5	2.0
/08	8.3	12.6	3.5	7.0	1.25	5.0	0.8	8-32 UNC 2A	3.0
/09	9.2	23.9	5.0	8.0	1.5	5.0	0.8	12-32 UNEF 2A	3.0



Finish
Blank - Tin
S - Silver

Capacitance
22P0 - 22pF 02N7 - 2700pF
100P - 100pF 47N0 - 47000pF

Electrical Characteristics

Min. Cap.(nF)	Current (Amps)	Voltage dc (-55°C to 85°C)	Voltage dc (+125°C) (*see note)	Min IR (G Ω)	Typical Insertion Loss (dB) (50 Ω system)								Case Options
					50 kHz	100 kHz	300 kHz	1 MHz	10 MHz	100 MHz	1 GHz	10 GHz	
45	10	50v	43v	5	-	-	4	14	30	45	55	60	05 & 06
50	10	50v	43v	5	-	-	6	15	32	45	60	60	08 & 09
0.1	10	70v	60v	10	-	-	-	-	-	2	17	28	05 & 06
0.5	10	70v	60v	10	-	-	-	-	-	13	30	40	05 & 06
1.2	10	70v	60v	10	-	-	-	-	3	20	37	45	05 & 06
2.7	10	70v	60v	10	-	-	-	-	9	25	40	50	05 & 06
5	10	70v	60v	10	-	-	-	-	14	30	45	55	05 & 06
120	10	70v	60v	1	-	-	12	21	40	55	55	55	08 & 09
15	10	100v	87v	5	-	-	-	5	20	35	50	60	05 & 06
80	10	100v	87v	2	-	-	7	19	37	51	55	55	08 & 09
0.1	10	150v	130v	5	-	-	-	-	-	2	17	28	05 & 06
0.5	10	150v	130v	5	-	-	-	-	-	13	30	40	05 & 06
1.2	10	150v	130v	5	-	-	-	-	3	20	37	45	05 & 06
2.7	10	150v	130v	5	-	-	-	-	9	25	40	50	05 & 06
0.1	10	300v	260v	5	-	-	-	-	-	2	17	28	05 & 06
0.5	10	300v	260v	5	-	-	-	-	-	13	30	40	05 & 06
1.2	10	300v	260v	5	-	-	-	-	3	20	35	45	05 & 06

*Voltage decreases linearly from 85°C to 125°C

Technical Information

BODY & NUT	Tin or Silver
ENVIRONMENTAL CLASSIFICATION	55/125/56



Miniature Threaded C Circuit Filters

[Key Characteristics

Applications

- High Density Panels
- Bulkhead Filter Arrays

Performance

- ≤100nF
- ≤100Vdc
- High frequency
- Temperature -40°C to +100°C

Rugged

- Discoidal construction
- High Performance

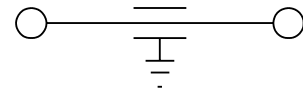

[Ordering Information

Circuit	Cap	Current	Voltage dc	IL (dB) 0.1Mhz	1MHz	10MHz	100MHz	1GHz	Colour Code (hex end/ thread end)
C	22pF	10A	100v *	-	-	-	3	15	Black/White
C	47pF	10A	100v *	-	-	-	5	20	Yellow/White
C	100pF	10A	100v *	-	-	-	8	28	White/White
C	330pF	10A	100v *	-	-	2	18	34	Green/White
C	470pF	10A	100v *	-	-	3	20	40	Orange/White
C	680pF	10A	100v *	-	-	4	22	40	Grey/White
C	1000pF	10A	100v *	-	-	9	27	40	Brown/White
C	4700pF	10A	100v *	-	3	20	38	53	Red/White
C	10000pF	10A	100v *	1	8	27	44	63	Blue/White
C	47000pF	10A	100v *	4	20	41	45	74	Lt Blue/White
C	100000pF	10A	50v *	2	25	45	57	75	Lt Brown/White

* Voltage derates linearly to 50% of quoted voltage dc from 85°C to 100°C

[Ordering Information

Capacitance

22	-	22pF
47	-	47pF
100	-	100pF
330	-	330pF
470	-	470pF
680	-	680pF
1000	-	1000pF
4700	-	4700pF
10000	-	10000pF
47000	-	47000pF
100000	-	100000pF

Lead Options
 Blank - Plain lead
 Ref1 - with PIP

Thread
 Blank - 2BA
 M - M5 x 0.8

DLT/ / / /

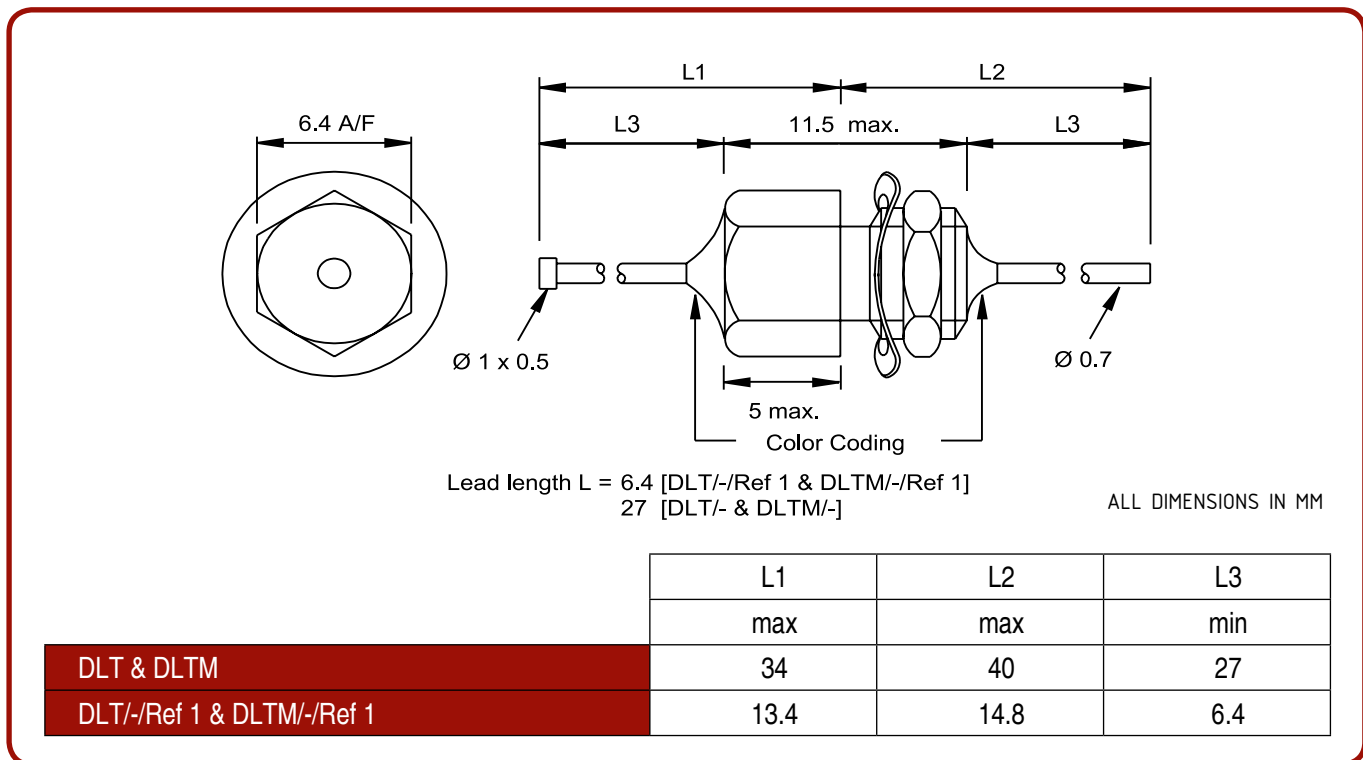

Mounting Details

	DLT/-, DLT/-/Ref 1	DLTM/, DLTM/-/Ref 1
THREAD	2BA	M5 x 0.8
MOUNTING HOLE	5.1mm	
MOUNTING TORQUE	0.35Nm	
CHASSIS THICKNESS	1.2 - 1.6mm	
MINIMUM PITCH (with nut)	8mm	
MINIMUM PITCH (without nut)	8mm	

Technical Information

CASE & NUT	Brass, Tin finish
FEEDTHROUGH TERMINATIONS	Copper Alloy, Tin Lead or Silver finish



SAI GLOBAL
AS9100
Aerospace

*ROHS versions available upon request - please speak to the sales department

Miniature Threaded TVS C Circuit Filters

[Key Characteristics

Applications

- High density panels
- Bulkhead filter arrays

Rugged

- Discoidal construction
- High performance

Performance

- ≤100nF
- 5, 14 or 18 Vdc working voltage
- High frequency
- Temperature -55°C to +125°C

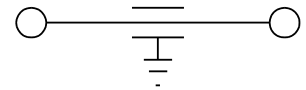
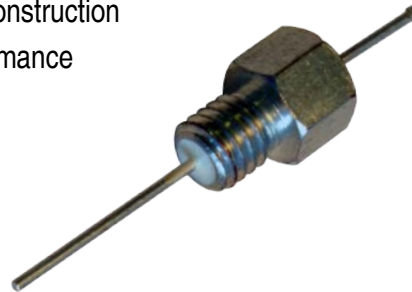

[Electrical Characteristics

Circuit	Cap	Current	IL (dB) 0.1MHz	1MHz	10 MHz	100 MHz	1 GHz	Colour Code (Hex end/Thread end)
C	4700pF	10A	-	3	20	38	53	Red/White
C	10000pF	10A	1	8	27	44	63	Blue/White
C	47000pF	10A	2	20	41	45	74	Lt Blue/White
C	100000pF	10A	2	25	47	57	75	Lt Brown/White

[Transient Voltage Characteristics

Parameter		Test Conditions	/5	/14	/18
Working Voltage dc	Volt (max)	<50µA leakage current	5.6v	14v	18v
Breakdown Voltage	Volt (max)	1mA dc current	7.1-8.7v	15.9-19.4v	22.5-27.5v
Clamping Voltage	Volt (max)	10A 8/20µS	15.5v	30v	40v
Peak Current	Amps (max)	8/20µS	120A	120A	120A
Transient Energy	Joules (max)	10/1000µS	0.3J	0.3J	0.3J

[Ordering Information

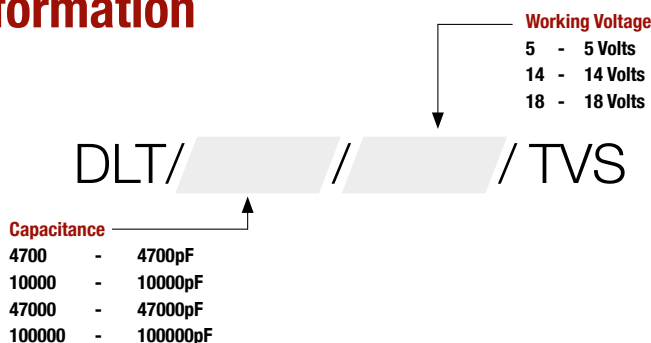

Example: DLT/4700/14/TVS - 4700pF, 14 volts with Transient Voltage Suppression

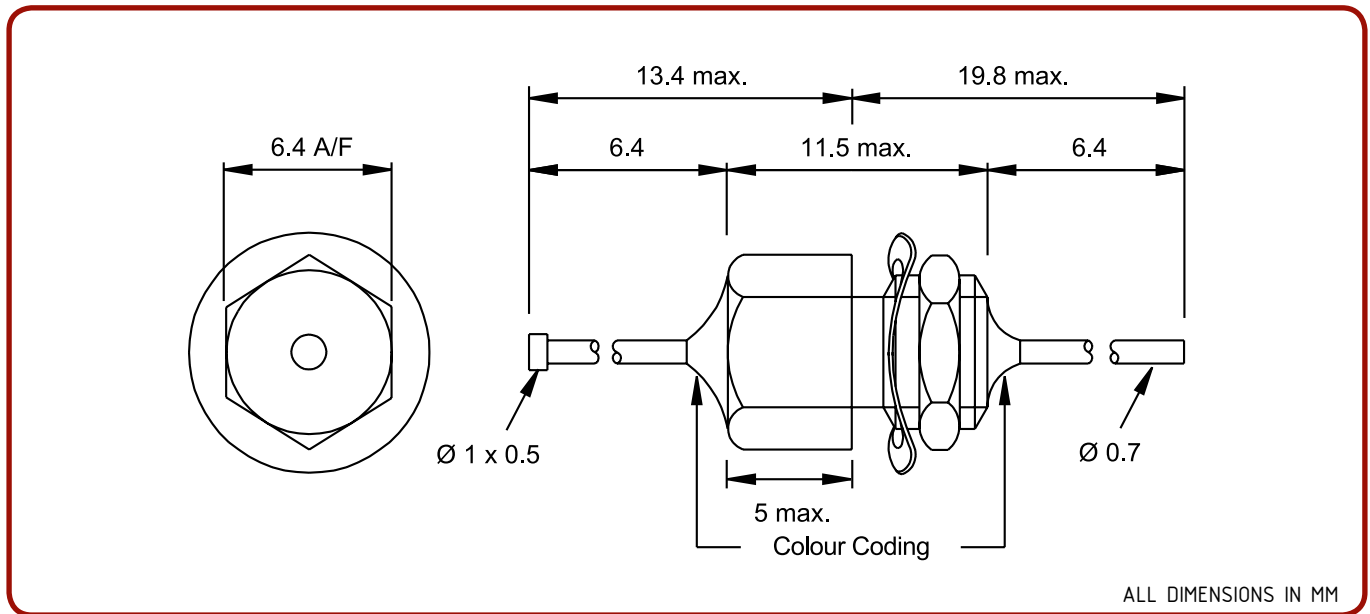

Mounting Details

THREAD	2BA
CHASSIS THICKNESS (max)	1.2 - 1.6mm
MINIMUM PITCH	8mm
MOUNTING TORQUE	0.35mm

Technical Information

CASE & NUT	Brass, Tin finish
FEEDTHROUGH TERMINATIONS	Copper Alloy, Tin Lead or Silver finish
MARKING	In addition to colour code, a transient protected device is indicated by a black or white dot on the colour coding to distinguish it from a standard DLT/- device



SAI GLOBAL
AS9100
Aerospace

*ROHS versions available upon request - please speak to the sales department

Miniature/Microslim Threaded C & L Circuit Filters

[Key Characteristics

Applications

- High Density Panels
- Bulkhead Filter Arrays

Performance

- ≤22nF
- ≤200Vdc
- High frequency
- Temperature -55°C to +125°C

Rugged

- Discoidal construction
- High performance

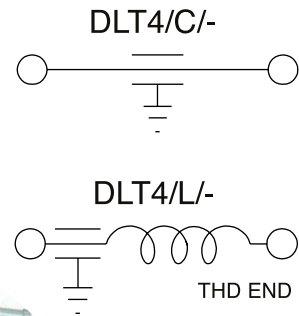
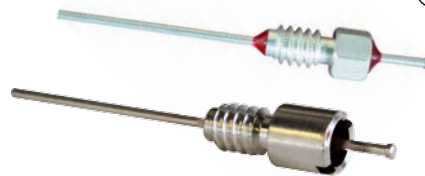

[Electrical Characteristics

Circuit	Cap	Current	Voltage	IL (dB) 1MHz	10 MHz	100 MHz	1 GHz	10 GHz	Colour Code (Hex end/Thread end)	Marking**
C	330pF	10A	200v*	-	2	18	35	60	Green/White	OXC n33
C	680pF	10A	200v*	1	4	22	35	70	Grey/White	OXC 268
C	1000pF	10A	200v*	1	9	26	40	70	Brown/White	OXC 1n0
C	4700pF	10A	200v*	3	20	36	50	70	Red/White	OXC 4n7
C	10000pF	10A	200v*	8	27	44	63	70	Black/White	OXC 10n
C	22000pF	10A	200v*	12	30	50	68	70	Blue/White	OXC 22n
L	330pF	10A	200v*	-	2	20	38	60	Green/Red	OXL n33
L	680pF	10A	200v*	1	4	24	38	70	Grey/Red	OXL n68
L	1000pF	10A	200v*	1	9	28	43	70	Brown/Red	OXL 1n0
L	4700pF	10A	200v*	3	20	38	56	70	Red/Red	OXL 4n7
L	10000pF	10A	200v*	8	28	48	70	70	Black/Red	OXL 10n
L	22000pF	10A	200v*	12	31	54	70	40	Blue/Red	OXL 22n

* Voltage derates linearly to 50% of quoted voltage from 85°C to 125°C

** Marking at manufacturers discretion

[Ordering Information

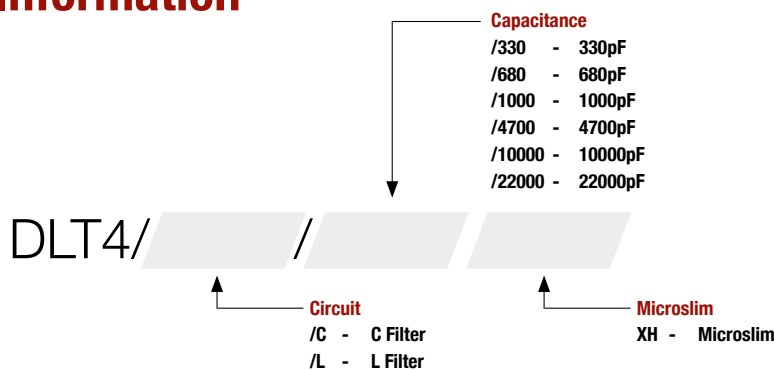

Example: DLT4/C/4700 - C circuit, 4700pF

Miniature Threaded Data

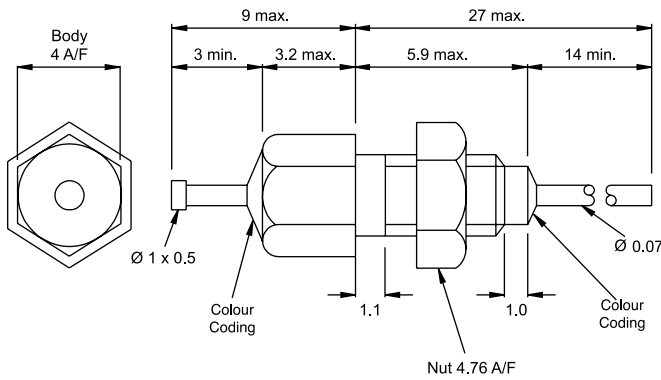

Thread	6-32 UNC (2A)
Minimum Component Pitch (with nut)	6mm
Minimum Component Pitch (without nut)	5mm
Mounting Torque	0.3 Nm

ALL DIMENSIONS IN MM

Microslim Threaded Data

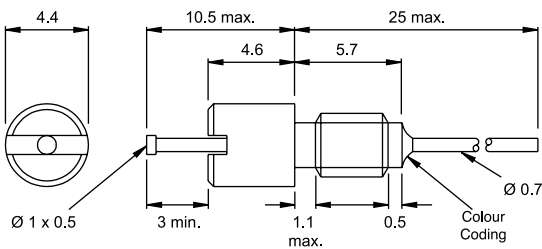

Thread	6-32 UNC 2A
Mounting Hole	3.7mm
Max. Chassis Thickness	3.2mm
Minimum Pitch (with and without nut)	4.8mm
Mounting Torque	0.3 Nm

Mounting Details

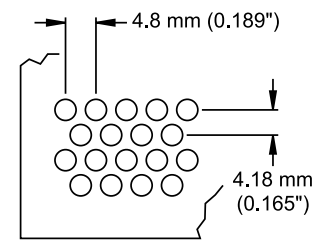
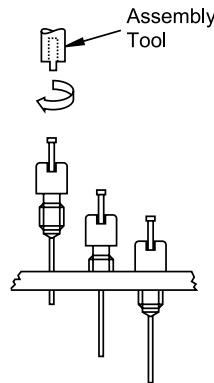

Minimum Pitching

ALL DIMENSIONS IN MM

NOTE: DLT4/NUT/XH supplied separately

Technical Information

CASE & NUT	Brass, Silver finish
FEEDTHROUGH TERMINATIONS	Copper Alloy, Tin Lead or Silver finish
MICROSLIM ASSEMBLY TOOLS PART NUMBER	ATXH/01 & ATXH/02



SAI GLOBAL
AS9100
Aerospace

*ROHS versions available upon request - please speak to the sales department

Panel Mounted L & C Circuit Filters

[Key Characteristics

Applications

- Panels
- Bulkhead Filter Arrays

Performance

- >1000nF
- ≤80Vdc
- High frequency
- Temperature -55°C to +125°C

Rugged

- Discoidal construction
- High performance

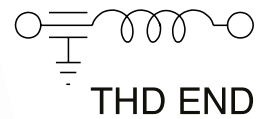
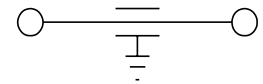

[Electrical Characteristics

Circuit	Cap	Current	Voltage dc	IL (dB) 0.01MHz	0.1 MHz	1 MHz	10 MHz	100 MHz	1 GHz	10 GHz	Colour Code (Hex end/Thread end)
C	1200nF	15A	80v*	6	25	44	54	77	80	80	Red/White
L	1200nF	15A	80v*	9	28	47	58	85	90	90	Red/Red

* Voltage derates linearly to 50 volts dc from 85°C to 125°C

[Ordering Information

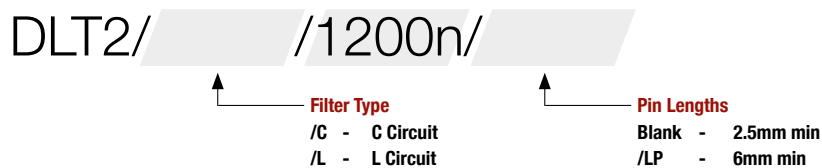

Example: DLT2/C/1200n/LP - C Filter with long pin option

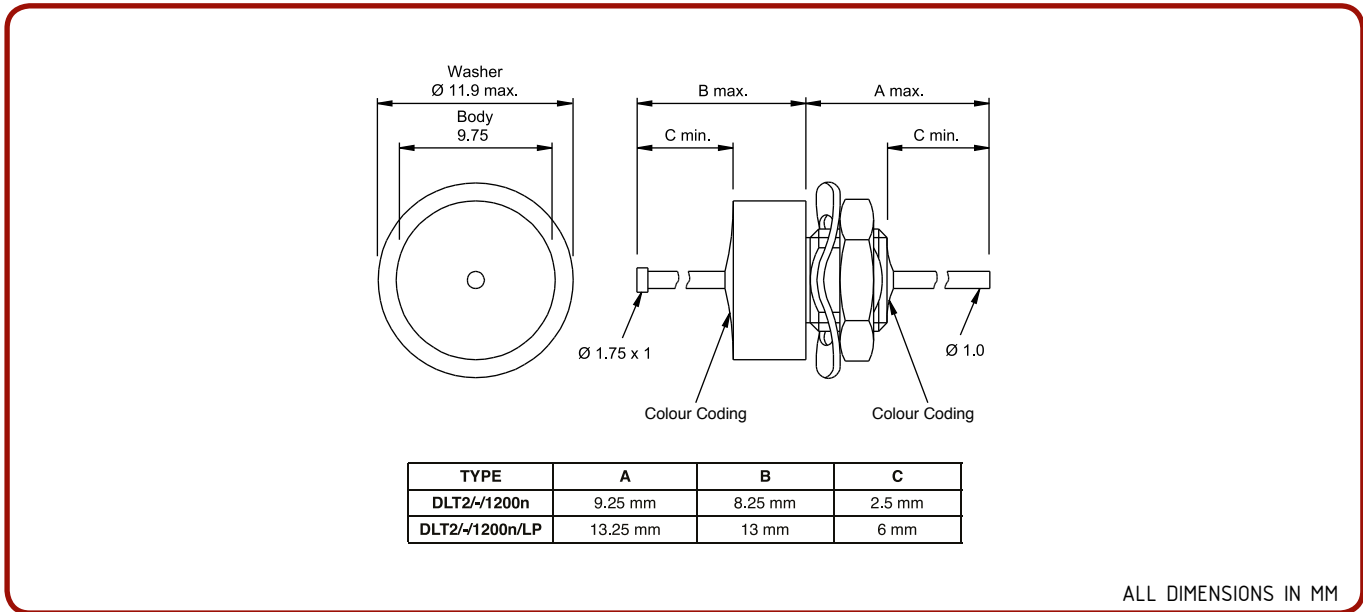

Mounting Details

THREAD	M6 x 0.75mm
CHASSIS THICKNESS (max)	2.25mm
MINIMUM PITCH (without nut/washer)	9.9mm
Nut A/F	8.2mm
MOUNTING TORQUE	0.5Nm

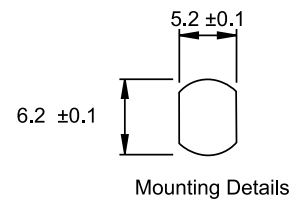

Technical Information

CASE & NUT	Brass, Silver finish
FEEDTHROUGH TERMINATIONS	Copper Alloy, Tin Lead or Silver finish
WASHER	Silver plated, Beryllium-Copper alloy



SAI GLOBAL
AS9100
Aerospace

*ROHS versions available upon request - please speak to the sales department

Panel Mounted TVS L & C Circuit Filters

[Key Characteristics

Applications

- Panels
- Bulkhead Filter Arrays

Performance

- 1200nF
- 5, 14, 18, 26, 30, 48 & 60 Vdc working voltage
- Temperature -55°C to +125°C

Rugged

- Discoidal construction
- High performance

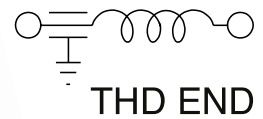
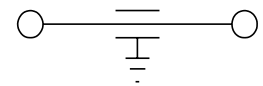

[Electrical Characteristics

Circuit	Cap	Current for dc & 400Hz ac	IL (dB) 100MHz - 1GHz	Colour Code (Top end/Thread end)
C	1200nF	10A	65	Red/White
L	1200nF	10A	65	Red/Red

[Transient Voltage Characteristics

Parameter		Test Conditions	/5	/14	/18	/26	/30	/48	/60
Working Voltage dc	Volt (max)	<50µA	5.6v	14v	18v	26v	30v	48v	60v
Breakdown Voltage	Volt (max)	1mA dc current	7.1 - 8.7v	15.9 - 19.4v	22.5 - 27v	30.5 - 37.3v	36 - 45v	54.5 - 66.5v	67 - 83v
Clamping Voltage	Volt (max)	10A 8/20µS	15.5v	30v	40v	58v	65v	100v	120v
Peak Current	Amps (max)	8/20µS	150A	150A	150A	120A	120A	250A	250A
Transient Energy	Joule (max)	10/1000µS	0.4J	0.4J	0.4J	0.4J	0.4J	1.2J	1.5J

[Ordering Information

DLT2/ /1200n/LP/

Filter Type

- /C - C Circuit
- /L - L Circuit

Nominal Working Voltage

- /5 - 5Vdc
- /14 - 14Vdc
- /18 - 18Vdc
- /26 - 26Vdc
- /30 - 30Vdc
- /48 - 48Vdc
- /60 - 60Vdc

Example: DLT2/C/1200n/LP/26/TVS - C Filter, TVS at 26Vdc working voltage

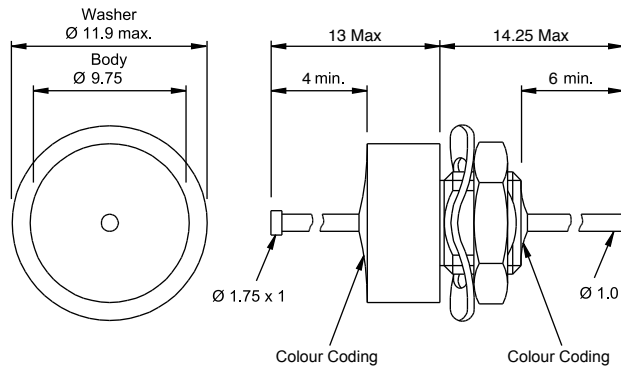

NOTE: BLACK DOT ON COLOUR CODING ON TVS PROTECTED PARTS

ALL DIMENSIONS IN MM

Mounting Details

THREAD	M6 x 0.75mm
CHASSIS THICKNESS (max)	2.25mm
MINIMUM PITCH (without nut/washer)	9.9mm
Nut A/F	8.2mm
MOUNTING TORQUE	0.5Nm

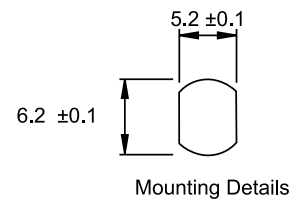

Technical Information

CASE & NUT	Brass, Silver finish
FEEDTHROUGH TERMINATIONS	Copper Alloy, Tin Lead or Silver finish
WASHER	Silver plated, Beryllium-Copper alloy



SAI GLOBAL
AS9100
Aerospace

*ROHS versions available upon request - please speak to the sales department

Electrical Characteristics

Min. Cap (μ F)	Rated Current (Amps)	Voltage dc (-55°C to 85°C)	Voltage dc (+125°C)	Voltage AC 400Hz (+125°C)	Min IR (M Ω)	Min. Insertion Loss (dB) (50 Ω system)							Part prefix
						30 kHz	100 kHz	150 kHz	300 kHz	1 MHz	10 MHz	1 GHz	
0.15	10	50v	43v		1000	-	-	10	16	26	45	60	DCT112N
0.3	10	50v	43v		100	-	-	16	22	30	50	60	DCT113N
0.45	10	50v	43v		100	-	-	19	25	35	55	60	DCT114N
0.6	10	50v	43v		100	-	-	22	27	38	57	60	DCT117N
1.2	15	80v	70v	50v	100	14	24	28	34	44	54	70	DCT326P
3	15	80v	70v	50v	100	20	28	35	41	51	54	70	DCT340P
4	15	80v	70v	50v	50	23	33	36	42	52	63	70	DCT328P
0.7	15	100v	87v	62v	500	10	20	23	28	38	52	65	DCT426P
1.4	15	100v	87v	62v	250	14	24	28	34	44	58	65	DCT428P
0.039	10	125v	105v		1000	-	-	2	5	13	32	50	DCT4112N
0.079	10	125v	105v		500	-	-	6	10	20	40	60	DCT4113N
0.11	10	125v	105v		300	-	-	8	13	23	40	60	DCT4114N
0.16	10	125v	105v		200	-	-	11	17	27	47	60	DCT4117N
0.3	15	150v	130v	90v	1000	4	13	16	22	32	48	65	DCT527P
0.7	15	150v	130v	90v	500	9	20	23	28	37	55	60	DCT540P
0.9	15	150v	130v	90v	250	12	22	25	31	41	58	65	DCT528P
2.1	15	150v	130v	90v	150	18	29	33	39	50	60	65	DCT541P
0.028	10	175v	150v		1000	-	-	1	3	12	30	50	DCT5112N
0.057	10	175v	150v		500	-	-	3	7	16	33	50	DCT5113N
0.12	10	175v	150v		250	-	-	9	14	24	44	60	DCT5114N
0.11	10	175v	150v		200	-	-	8	13	23	40	60	DCT5117N
0.1	15	200v	175v	125v	1000	-	5	8	13	23	38	60	DCT626P
0.3	15	200v	175v	125v	250	4	12	16	21	31	47	60	DCT628P
0.45	15	200v	175v	125v	500	6	16	19	24	34	51	60	DCT640P
1.2	15	200v	175v	125v	100	14	25	28	34	45	50	65	DCT641P
0.017	10	250v	215v		1000	-	-	-	1	7	24	40	DCT6112N
0.034	10	250v	215v		500	-	-	1	3	12	30	50	DCT6113N
0.051	10	250v	215v		300	-	-	2	6	15	33	55	DCT6114N
0.068	10	250v	215v		200	-	-	5	10	20	40	60	DCT6117N
0.06	15	300v	260v	185v	1000	-	2	4	8	18	33	50	DCT726P
0.1	15	300v	260v	185v	1000	-	3	6	11	21	35	55	DCT726P1
0.12	15	300v	260v	185v	500	-	6	9	14	24	39	50	DCT728P
0.25	15	300v	260v	185v	1000	2	10	13	18	27	45	65	DCT740P
0.75	15	300v	260v	185v	250	9	19	23	28	37	54	65	DCT741P
0.02	15	450v	400v	280v	1000	-	-	-	-	9	26	50	DCT826P
0.04	15	450v	400v	280v	500	-	-	-	6	15	30	50	DCT828P
0.12	15	450v	400v	280v	1000	-	4	7	13	23	40	60	DCT840P
0.21	15	450v	400v	280v	500	-	10	13	19	30	49	60	DCT841P
0.008	15	600v	530v	375v	1000	-	-	-	-	-	14	35	DCT926P1
0.01	15	600v	530v	375v	1000	-	-	-	-	5	19	40	DCT926P
0.02	15	600v	530v	375v	500	-	-	-	2	11	25	40	DCT928P
0.07	15	600v	530v	375v	1200	-	-	-	7	17	36	60	DCT940P
0.21	15	600v	530v	375v	400	-	7	10	16	26	42	60	DCT942P

Technical Information

BODY & NUT	Tin or Silver
ENVIRONMENTAL CLASSIFICATION	55/125/56 Hermetic



SAI GLOBAL
AS9100
Aerospace

*ROHS versions available upon request - please speak to the sales department

Panel Mounted Hermetic L Circuit Filters

[Key Characteristics

Applications

- Panels
- Bulkhead filter arrays

Performance

- $\leq 3\mu\text{F}$
- $\leq 600\text{Vdc}$
- High Frequency
- Temperature -55°C to 125°C

Rugged

- Discoidal construction

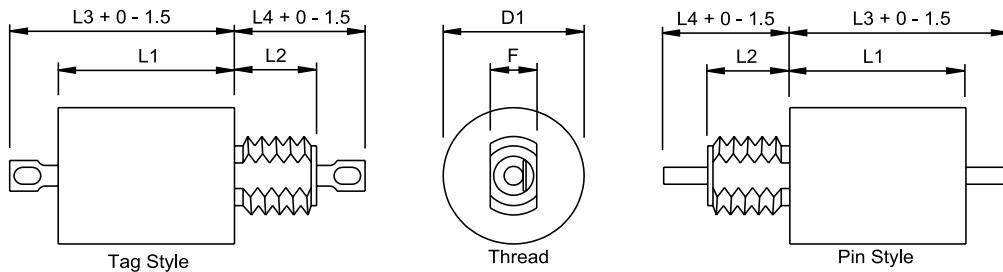
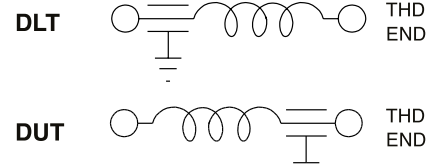

ALL DIMENSIONS ARE MAX AND IN MM UNLESS OTHERWISE STATED

CASE DIMENSIONS

/__	D1	F	L1	L2	L3	L3	L4	L4	Thread	Tag hole	Pin dia	Max Panel Thickness	
		Nom		STD (Long)	tag	Pin	Tag - STD (Long)	Pin - STD (Long)	UNF2A	Metric		STD(Long)	
/25	9.78	5.08	4.57	4.83(7.92)	8.5	17	8.9(12.0)	17.2(20.3)	1/4-28	M6x0.75	1.27x1.78	1.55	1.5(3.0)
/26	9.78	5.08	6	4.83(7.92)	10.1	18.4	8.9(12.0)	17.2(20.3)	1/4-28	M6x0.75	1.27x1.78	1.55	1.5(3.0)
/29	9.78	5.08	12.2	4.83(7.92)	16.3	24.6	8.9(12.0)	17.2(20.3)	1/4-28	M6x0.75	1.27x1.78	1.55	1.5(3.0)
/31	9.78	5.08	14.7	4.83(7.92)	18.9	27.2	8.9(12.0)	17.2(20.3)	1/4-28	M6x0.75	1.27x1.78	1.55	1.5(3.0)
/42	17.53	6.35	17.45	8	22.6	29.4	14	20	5/16-24	M8x1.0	1.45x3.0	2.15	3

[Ordering Information

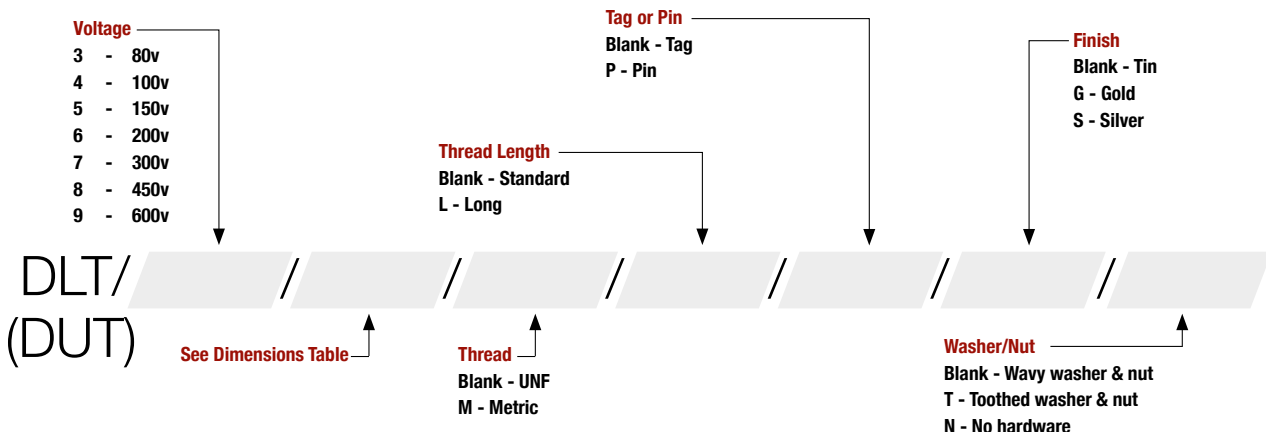

[Electrical Characteristics

Cap µF	Rated Current (Amps)	Voltage dc (-55°C to 85°C)	Voltage dc (+125°C)	Voltage ac 400Hz (+125°C)	Min IR (MΩ)	Min. Insertion Loss (dB) (50 Ω system)								Part Prefix
						15 kHz	30 kHz	100 kHz	150 kHz	300 kHz	1 MHz	10 MHz	1 GHz	
1.4	0.06	80	70	50	100	-	25	44	52	65	70	70	70	DLT331A
1.4	0.5	80	70	50	100	-	17	35	42	53	70	70	70	DLT331G
1.4	1	80	70	50	100	-	15	28	34	45	65	70	70	DLT331H
1.4	3	80	70	50	100	-	14	25	28	35	51	70	70	DLT331K
1.4	5	80	70	50	100	-	14	24	28	34	45	65	70	DLT331M
1.4	10	80	70	50	100	-	14	24	28	34	44	58	70	DLT331N
1.4	15	80	70	50	100	-	14	25	27	34	44	54	70	DLT326P
3	0.5	80	70	50	100	-	25	45	52	63	70	70	70	DLT342G
3	1	80	70	50	100	-	23	41	48	60	70	70	70	DLT342H
3	3	80	70	50	100	-	20	31	35	42	60	70	70	DLT342K
3	5	80	70	50	100	-	20	31	34	41	56	70	70	DLT342M
3	10	80	70	50	100	-	20	28	35	41	51	60	70	DLT342N
0.7	0.06	100	87	62	500	-	40	61	68	70	70	70	70	DLT431A
0.7	0.1	100	87	62	500	8	19	39	46	58	70	70	70	DLT429B
0.7	0.25	100	87	62	500	-	12	32	38	50	70	70	70	DLT431D
0.7	0.3	100	87	62	500	6	15	33	43	52	70	70	70	DLT429E
0.7	0.45	100	87	62	500	-	9	19	23	32	52	70	70	DLT431F
0.7	0.5	100	87	62	500	5	12	27	36	46	67	70	70	DLT429G
0.7	1	100	87	62	500	5	10	19	26	34	53	70	70	DLT429H
0.7	2	100	87	62	500	5	9	18	23	30	46	70	70	DLT429J
0.7	15	100	87	62	500	-	9	20	23	29	39	52	70	DLT425P
0.75	1	100	87	62	500	-	10	22	29	39	56	70	70	DLT431H
0.75	3	100	87	62	500	-	10	20	24	30	45	70	70	DLT431K
0.75	5	100	87	62	500	-	10	20	23	29	39	66	70	DLT431M
0.75	10	100	87	62	500	-	10	19	23	28	38	57	70	DLT431N
0.3	15	150	130	90	1000	-	4	12	16	21	31	48	70	DLT525P
0.3	15	150	130	90	1000	-	4	12	16	21	31	48	70	DLT526P
0.6	0.5	150	130	90	400	-	11	29	35	47	65	70	70	DLT531G
0.6	1	150	130	90	400	-	10	22	27	36	57	70	70	DLT531H
0.6	3	150	130	90	400	-	9	19	22	29	44	65	70	DLT531K
0.6	5	150	130	90	400	-	7	15	20	26	37	65	70	DLT531M
0.6	10	150	130	90	400	-	5	12	17	21	31	48	70	DLT531N
1.4	0.5	150	130	90	300	-	20	40	48	58	70	70	70	DLT542G
1.4	1	150	130	90	300	-	18	37	44	56	70	70	70	DLT542H
1.4	3	150	130	90	300	-	14	25	29	37	55	70	70	DLT542K
1.4	5	150	130	90	300	-	14	24	28	34	47	70	70	DLT542M
1.4	10	150	130	90	300	-	14	24	27	33	44	60	70	DLT542N
0.1	15	200	175	125	1000	-	-	5	8	13	23	38	60	DLT625P
0.2	0.5	200	175	125	500	-	-	18	25	38	58	70	70	DLT631G
0.2	1	200	175	125	500	-	-	12	19	29	48	70	70	DLT631H
0.2	3	200	175	125	500	-	-	9	13	17	33	65	70	DLT631K
0.2	5	200	175	125	500	-	-	9	13	17	28	61	70	DLT631M
0.2	10	200	175	125	500	-	-	9	13	17	27	44	70	DLT631N
0.45	0.5	200	175	125	500	-	10	30	37	48	68	70	70	DLT642G
0.45	1	200	175	125	500	-	8	27	33	45	65	70	70	DLT642H
0.45	3	200	175	125	500	-	5	15	19	27	45	70	70	DLT642K
0.45	5	200	175	125	500	-	6	16	18	24	36	70	70	DLT642M
0.8	10	200	175	125	250	-	9	19	22	28	39	60	70	DLT642N

Cap μF	Rated Current (Amps)	Voltage dc (-55°C to 85°C)	Voltage dc (+125°C)	Voltage ac 400Hz (+125°C)	Min IR (MΩ)	Min. Insertion Loss (dB) (50 Ω system)								Part Prefix
						15 kHz	30 kHz	100 kHz	150 kHz	300 kHz	1 MHz	10 MHz	1 GHz	
0.06	15	300	260	185	1000	-	-	2	4	8	18	33	50	DLT726P
0.1	15	300	260	185	1000	-	-	3	6	11	21	35	55	DLT726P1
0.12	0.5	300	260	185	500	-	-	15	22	33	54	70	70	DLT731G
0.12	1	300	260	185	500	-	-	8	14	25	45	70	70	DLT731H
0.12	3	300	260	185	500	-	-	6	9	15	30	61	70	DLT731K
0.12	5	300	260	185	500	-	-	6	9	14	25	51	70	DLT731M
0.12	10	300	260	185	500	-	-	6	9	14	24	42	70	DLT731N
0.25	0.5	300	260	185	1000	-	5	25	32	43	62	70	70	DLT742G
0.25	1	300	260	185	1000	-	2	20	26	38	59	70	70	DLT742H
0.25	3	300	260	185	1000	-	2	11	14	22	39	70	70	DLT742K
0.25	5	300	260	185	1000	-	-	9	13	19	33	65	70	DLT742M
0.25	10	300	260	185	1000	-	2	10	13	18	29	50	70	DLT742N
0.02	15	450	400	280	1000	-	-	-	-	-	9	23	40	DLT826P
0.04	0.5	450	400	280	500	-	-	7	13	24	45	60	70	DLT831G
0.04	1	450	400	280	500	-	-	-	5	15	35	67	70	DLT831H
0.04	3	450	400	280	500	-	-	-	-	9	28	61	70	DLT831K
0.04	5	450	400	280	500	-	-	-	-	5	17	45	70	DLT831M
0.04	10	450	400	280	500	-	-	-	-	5	15	33	70	DLT831N
0.12	0.5	450	400	280	1000	-	-	19	26	38	60	70	70	DLT842G
0.12	1	450	400	280	1000	-	-	10	16	28	48	70	70	DLT842H
0.12	3	450	400	280	1000	-	-	4	8	16	33	65	70	DLT842K
0.12	5	450	400	280	1000	-	-	4	7	13	27	60	70	DLT842M
0.12	10	450	400	280	1000	-	-	4	7	13	23	48	70	DLT842N
0.01	0.5	600	530	375	1000	-	-	3	6	14	32	45	70	DLT931G2
0.01	1	600	530	375	1000	-	-	-	-	5	22	50	70	DLT931H2
0.01	3	600	530	375	1000	-	-	-	-	-	7	43	70	DLT931K2
0.01	5	600	530	375	1000	-	-	-	-	-	3	31	70	DLT931M2
0.01	10	600	530	375	1000	-	-	-	-	-	3	22	70	DLT931N2
0.02	0.5	600	530	375	500	-	-	5	10	20	41	56	70	DLT931G
0.02	1	600	530	375	500	-	-	-	-	11	31	63	70	DLT931H
0.02	3	600	530	375	500	-	-	-	-	2	16	47	70	DLT931K
0.02	5	600	530	375	500	-	-	-	-	2	11	37	70	DLT931M
0.02	10	600	530	375	500	-	-	-	-	2	11	30	70	DLT931N
0.02	15	600	530	375	1000	-	-	-	-	-	5	19	40	DLT926P
0.07	0.5	600	530	375	1200	-	-	14	21	33	55	60	70	DLT942G
0.07	1	600	530	375	1200	-	-	9	16	27	48	60	70	DLT942H
0.07	3	600	530	375	1200	-	-	-	3	10	28	64	70	DLT942K
0.07	5	600	530	375	1200	-	-	-	-	9	22	55	70	DLT942M
0.07	10	600	530	375	1200	-	-	-	-	7	18	43	60	DLT942N

Technical Information

BODY & NUT	Tin or Silver
ENVIRONMENTAL CLASSIFICATIONS	55/125/56 Hermetic



Panel Mounted Hermetic Pi Filter

[Key Characteristics

Applications

- Panels
- Bulkhead filter arrays

Performance

- $\leq 3\mu\text{F}$
- $\leq 600\text{Vdc}$
- High Frequency
- Temperature -55°C to 125°C

Rugged

- Discoidal construction

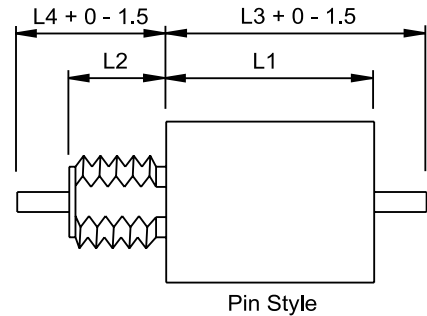
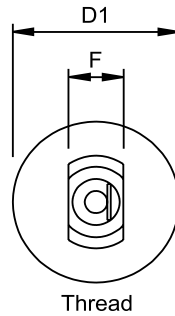
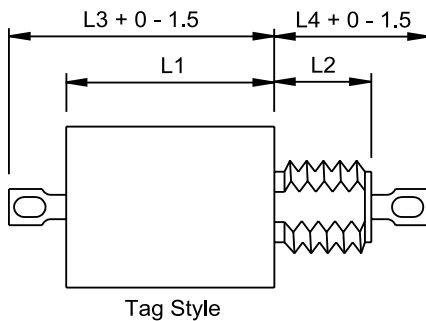
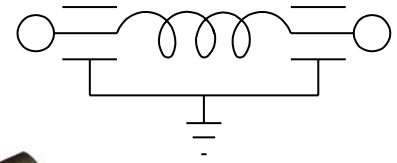

ALL DIMENSIONS ARE MAX AND IN MM UNLESS OTHERWISE STATED

CASE DIMENSIONS

/ __	D1	F	L1	L2	L3	L3	L4	L4	Thread		Tag hole	Pin dia	Max Panel Thickness
									UNF2A	Metric			
		Nom		STD (Long)	Tag	Pin	Tag - STD (Long)	Pin - STD (Long)					STD(Long)
/31	9.78	5.08	14.7	4.83(7.92)	18.9	27.2	8.9(12.0)	17.2(20.3)	1/4-28	M6x0.75	1.27x1.78	1.55	1.5(3.0)
/32	9.78	5.08	16.3	4.83(7.92)	20.4	28.7	8.9(12.0)	17.2(20.3)	1/4-28	M6x0.75	1.27x1.78	1.55	1.5(3.0)
/43	17.53	6.35	24.85	8	30.1	36.8	14	20	5/16-24	M8x1.0	1.45x3.0	2.15	3

[Ordering Information

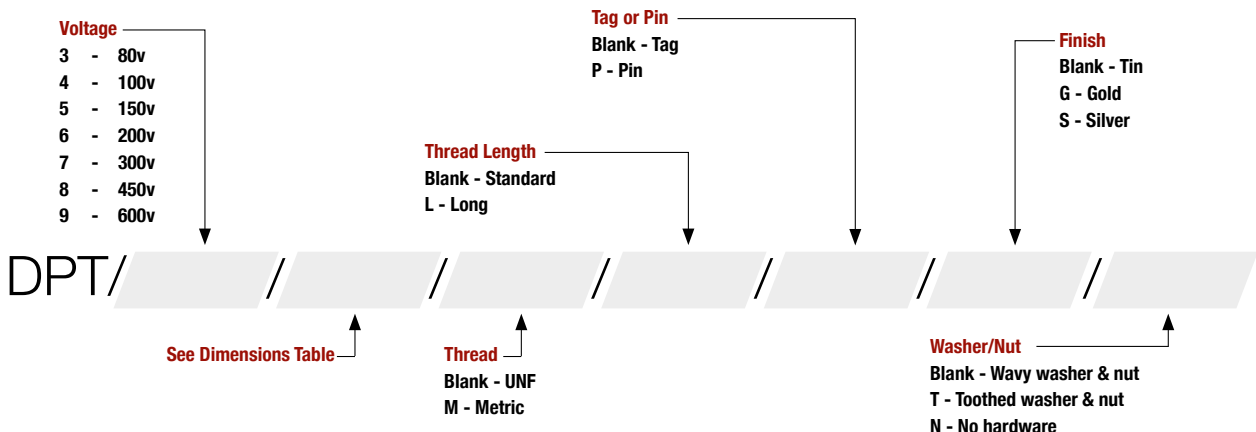

Electrical Characteristics

Cap μ F	Rated Current (Amps)	Voltage dc (-55°C to 85°C)	Voltage dc (+125°C)	Voltage ac 400Hz (+125°C)	Min IR (M Ω)	Min. Insertion Loss (dB) (50 Ω system)							Part Prefix
						30 kHz	100 kHz	150 kHz	300 kHz	1 MHz	10 MHz	1 GHz	
2.8	0.5	80	70	50	50	34	66	76	80	80	80	80	DPT333G
2.8	1	80	70	50	50	22	58	68	80	80	80	80	DPT333H
2.8	3	80	70	50	50	-	40	50	50	65	80	80	DPT333K
2.8	5	80	70	50	50	-	14	33	60	80	80	80	DPT333M
2.8	10	80	70	50	50	21	30	30	40	50	68	80	DPT333N
3	0.5	80	70	50	100	35	70	70	70	70	70	70	DPT343G
3	1	80	70	50	100	33	65	70	70	70	70	70	DPT343H
3	3	80	70	50	100	-	45	55	65	70	70	70	DPT343K
3	5	80	70	50	100	-	40	52	68	70	70	70	DPT343M
3	10	80	70	50	100	-	12	20	50	70	70	70	DPT343N
1.4	0.1	100	87	62	250	34	67	72	80	80	80	80	DPT431B
1.4	0.3	100	87	62	250	29	60	70	80	80	80	80	DPT431E
1.4	0.5	100	87	62	250	21	54	67	78	80	80	80	DPT431G
1.4	0.5	100	87	62	250	23	57	65	80	80	80	80	DPT433G
1.4	1	100	87	62	250	-	39	56	69	80	80	80	DPT431H
1.4	1	100	87	62	250	3	47	55	75	80	80	80	DPT433H
1.4	2	100	87	62	250	-	31	45	63	80	80	80	DPT431J
1.4	3	100	87	62	250	10	25	40	58	80	80	80	DPT433K
1.4	5	100	87	62	250	-	-	-	50	80	80	80	DPT431M
1.4	5	100	87	62	250	14	-	-	44	75	80	80	DPT433M
1.4	10	100	87	62	250	15	22	25	20	44	62	80	DPT433N
0.66	0.5	150	130	90	500	6	39	50	68	80	80	80	DPT533G
0.66	1	150	130	90	500	-	28	40	59	80	80	80	DPT533H
0.66	3	150	130	90	500	-	5	20	41	75	80	80	DPT533K
0.66	5	150	130	90	500	-	-	-	26	63	80	80	DPT533M
0.66	10	150	130	90	500	8	12	18	27	38	58	80	DPT533N
2.1	0.5	150	130	90	150	34	65	75	80	80	80	80	DPT543G
2.1	1	150	130	90	150	27	60	69	80	80	80	80	DPT543H
2.1	3	150	130	90	150	12	36	48	66	80	80	80	DPT543K
2.1	5	150	130	90	260	9	12	35	57	80	80	80	DPT543M
2.1	10	150	130	90	150	18	21	17	36	70	80	80	DPT543N
2.8	1	150	130	90	100	35	68	-	80	80	80	80	DPT543H1
2.8	5	150	130	90	100	-	26	-	63	80	80	80	DPT543M1
0.2	0.5	200	175	125	500	-	21	35	49	80	80	80	DPT633G
0.2	1	200	175	125	500	-	5	17	39	70	80	80	DPT633H
0.2	3	200	175	125	500	-	-	-	18	53	80	80	DPT633K
0.2	5	200	175	125	500	-	-	-	-	43	80	80	DPT633M
0.2	10	200	175	125	500	-	9	12	18	28	45	75	DPT633N
0.9	0.5	200	175	125	250	18	51	61	78	80	80	80	DPT643G
0.9	1	200	175	125	250	12	48	57	76	80	80	80	DPT643H
0.9	3	200	175	125	250	7	23	36	55	80	80	80	DPT643K
0.9	5	200	175	125	250	-	8	17	43	73	80	80	DPT643M
1.5	10	200	175	125	100	14	15	17	33	68	70	70	DPT643N

Cap μ F	Rated Current (Amps)	Voltage dc (-55°C to 85°C)	Voltage dc (+125°C)	Voltage ac 400Hz (+125°C)	Min IR (M Ω)	Min. Insertion Loss (dB) (50 Ω system)							Part Prefix
						30 kHz	100 kHz	150 kHz	300 kHz	1 MHz	10 MHz	1 GHz	
0.12	0.5	300	260	185	500	-	7	15	25	54	80	80	DPT733G
0.12	1	300	260	185	500	-	-	-	13	45	80	80	DPT733H
0.12	3	300	260	185	500	-	-	-	-	27	80	80	DPT733K
0.12	5	300	260	185	500	-	-	-	-	10	70	80	DPT733M
0.12	10	300	260	185	500	-	-	-	5	14	34	80	DPT733N
0.5	0.5	300	260	185	500	8	41	52	68	80	80	80	DPT743G
0.5	1	300	260	185	500	-	38	49	67	70	70	70	DPT743H
0.5	3	300	260	185	500	4	6	20	42	72	80	80	DPT743K
0.5	5	300	260	185	500	-	-	6	32	65	70	70	DPT743M
0.5	10	300	260	185	500	5	12	14	12	46	80	80	DPT743N
0.04	0.5	450	400	280	500	-	5	11	26	57	80	80	DPT833G
0.04	1	450	400	280	500	-	-	-	16	46	80	80	DPT833H
0.04	3	450	400	280	500	-	-	-	-	29	76	80	DPT833K
0.04	5	450	400	280	500	-	-	-	-	13	65	80	DPT833M
0.04	10	450	400	280	500	-	-	-	-	12	51	80	DPT833N
0.21	0.5	450	400	280	1000	-	30	41	58	70	70	70	DPT843G
0.21	1	450	400	280	1000	-	27	38	56	80	80	80	DPT843H
0.21	3	450	400	280	1000	-	-	6	27	60	70	70	DPT843K
0.21	5	450	400	280	1000	-	7	8	15	51	70	70	DPT843M
0.21	10	450	400	280	1000	-	9	12	14	39	70	70	DPT843N
0.5	1	450	400	280	500	-	38	49	67	70	70	70	DPT843H1
0.01	0.5	600	530	375	1000	-	3	6	13	33	62	80	DPT933G2
0.01	1	600	530	375	1000	-	-	-	4	22	66	80	DPT933H2
0.01	3	600	530	375	1000	-	-	-	-	4	58	80	DPT933K2
0.01	5	600	530	375	1000	-	-	-	-	-	46	80	DPT933M2
0.01	10	600	530	375	1000	-	-	-	-	-	31	80	DPT933N2
0.02	0.5	600	530	375	500	-	3	8	20	48	79	80	DPT933G
0.02	1	600	530	375	500	-	-	-	9	38	80	80	DPT933H
0.02	3	600	530	375	500	-	-	-	-	30	78	80	DPT933K
0.02	5	600	530	375	500	-	-	-	-	5	57	80	DPT933M
0.02	10	600	530	375	500	-	-	-	-	8	43	80	DPT933N
0.14	0.5	600	530	375	800	-	21	31	48	70	70	70	DPT943G
0.14	1	600	530	375	800	-	15	25	43	70	70	70	DPT943H
0.14	3	600	530	375	800	-	-	-	20	52	70	70	DPT943K
0.14	5	600	530	375	800	-	-	-	6	44	70	70	DPT943M
0.14	10	600	530	375	800	-	-	6	11	25	70	70	DPT943N

Technical Information

BODY & NUT	Tin or Silver
ENVIRONMENTAL CLASSIFICATIONS	55/125/56 Hermetic



SAI GLOBAL
AS9100
Aerospace

*ROHS versions available upon request - please speak to the sales department

Panel Mounted L Circuit Filters

[Key Characteristics

Applications

- High Density Panels
- Bulkhead Filter Arrays

Performance

- $\leq 1.4\mu\text{F}$
- $\leq 600\text{Vdc}$
- High frequency
- Temperature -55°C to $+125^\circ\text{C}$

Rugged

- Discoidal construction

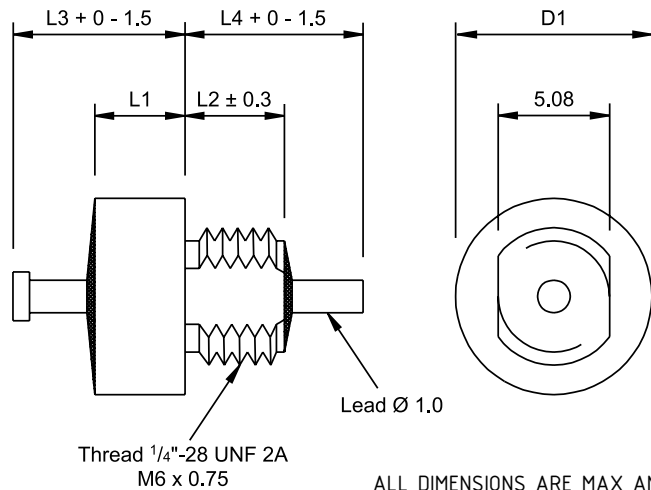
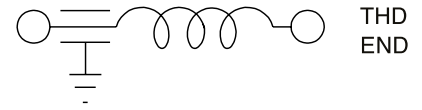

ALL DIMENSIONS ARE MAX AND IN MM UNLESS OTHERWISE STATED

[Ordering Information

- Voltage**
- 3 - 80v
 - 4 - 100v
 - 5 - 150v
 - 6 - 200v
 - 7 - 300v
 - 8 - 450v
 - 9 - 600v

- Pin**
- Blank - Standard
 - P1-P6 - Consult Factory
- Thread Length**
- Blank - Standard
 - L - Long

- Finish**
- Blank - Tin
 - G - Gold
 - S - Silver



CASE DIMENSIONS						
/_	D1	L1	L2	L3	L4	Max Panel Thickness
			STD (Long)		Tag - STD (Long)	STD(Long)
/25	9.78	4.6	4.83(7.92)	8.25	8.9(12.0)	1.5(3.0)
/26	9.78	6.0	4.83(7.92)	10.1	8.9(12.0)	1.5(3.0)
/50	9.78	4.6	4.83(7.92)	8.25	9.3(12.4)	1.5(3.0)

- Thread**
- Blank - UNF
 - M - Metric

- Washer/Nut**
- Blank - Wavy washer & nut
 - T - Toothed washer & nut
 - N - No hardware

Electrical Characteristics

Cap Min	Current (Amps)	Voltage dc (-55°C to 5°C)	Voltage dc (+125°C) (*see note)	Min IR	Typical Insertion Loss (dB) (50Ω system)							Part No
					30 kHz	100 kHz	150 kHz	300 kHz	1 MHz	10 MHz	1 GHz	
1.2μF	15	80v	50v	100MΩ	15	25	27	34	44	60	70	DLT050B*
1.4μF	15	80v	70v	100MΩ	15	25	28	34	44	54	70	DLT326PR
0.7μF	15	100v	87v	500MΩ	9	20	23	29	39	52	70	DLT425PR
0.7μF	15	100v	87v	500MΩ	9	20	23	29	39	52	70	DLT426PR
0.3μF	15	150v	130v	1GΩ	4	12	16	21	31	48	70	DLT526PR
0.1μF	15	200v	175v	1GΩ		5	8	13	23	38	60	DLT626PR
0.06μF	15	300v	260v	1GΩ		2	4	8	18	33	50	DLT726PR
0.02μF	15	450v	400v	1GΩ					9	23	45	DLT826PR
0.01μF	15	600v	530v	1GΩ					5	19	40	DLT926PR

*No AC Rating, insertion loss at 25°C only

Technical Information

BODY & NUT	Tin or Silver
ENVIRONMENTAL CLASSIFICATION	55/125/56 Non Hermetic



SAI GLOBAL
AS9100
Aerospace

*ROHS versions available upon request - please speak to the sales department

Panel Mounted Hermetic T Filter

[Key Characteristics

Applications

- Panels
- Bulkhead filter arrays

Performance

- $\leq 3\mu\text{F}$
- $\leq 600\text{Vdc}$
- High Frequency
- Temperature -55°C to 125°C

Rugged

- Discoidal construction

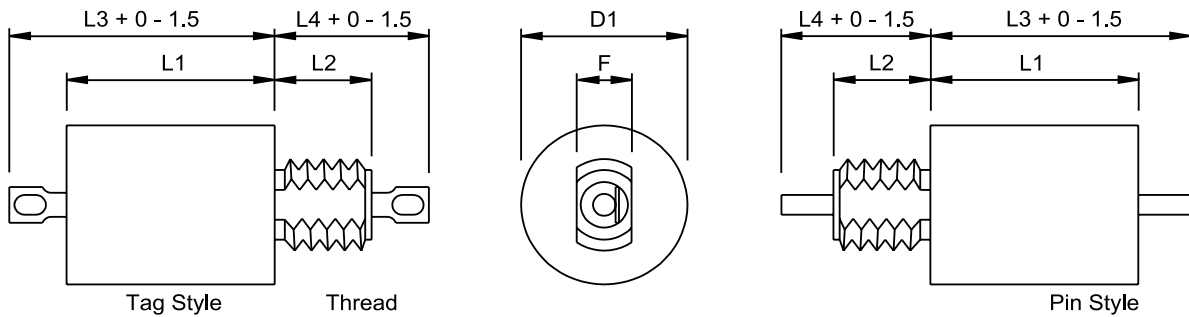
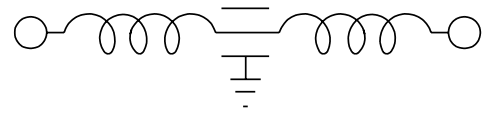

ALL DIMENSIONS ARE MAX AND IN MM UNLESS OTHERWISE STATED

CASE DIMENSIONS

/_	D1	F	L1	L2	L3	L3	L4	L4	Thread		Tag hole	Pin dia	Max Panel Thickness
									UNF2A	Metric			
		Nom		STD (Long)	Tag	Pin	Tag - STD (Long)	Pin - STD (Long)					STD(Long)
/34	9.78	5.08	26	4.83(7.92)	30.1	38.4	8.9(12.0)	17.2(20.3)	1/4-28	M6x0.75	1.27x1.78	1.55	1.5(3.0)
/43	17.53	6.35	24.85	8	30.1	36.8	14	20	5/16 -24	M8x1.0	1.45x3.0	2.15	3

[Ordering Information

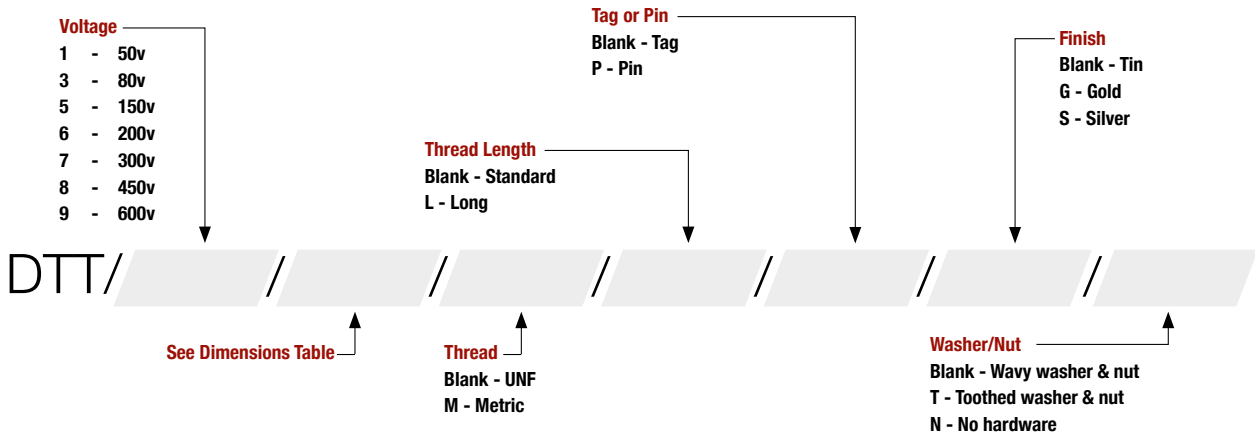

Cap μ F	Rated Current (Amps)	Voltage dc (-55°C to 85°C)	Voltage dc (+125°C)	Voltage AC 400Hz (+125°C)	Min IR (M Ω)	Min. Insertion Loss (dB) (50 Ω system)							Part Prefix
						30 kHz	100 kHz	150 kHz	300 kHz	1MHz	10MHz	1 GHz	
1.4	1	80	70	50	100	16	32	40	57	75	75	75	DTT334H
1.4	2	80	70	50	100	15	26	31	37	61	75	75	DTT334J
1.4	4	80	70	50	100	15	25	29	34	47	75	75	DTT334L
1.4	10	80	70	50	100	15	25	28	34	44	60	75	DTT334N
3	1	80	70	50	100	26	51	60	70	70	70	70	DTT343H
3	2	80	70	50	100	21	37	45	60	70	70	70	DTT343J
3	3	80	70	50	100	20	32	36	46	65	70	70	DTT343K
3	4	80	70	50	100	20	31	35	44	63	70	70	DTT343L
3	5	80	70	50	100	21	32	36	44	64	70	70	DTT343M
0.75	1	100	87	62	1000	10	25	34	49	75	75	75	DTT434H
0.75	2	100	87	62	1000	10	19	25	32	56	75	75	DTT434J
0.75	4	100	87	62	1000	10	19	22	29	42	75	75	DTT434L
0.75	10	100	87	62	1000	9	19	22	28	39	58	75	DTT434N
0.33	10	150	130	90	1000	5	14	16	21	31	54	75	DTT534N
0.6	1	150	130	90	400	10	24	32	47	70	75	75	DTT534H
0.6	2	150	130	90	400	9	20	25	34	57	80	80	DTT534J
0.6	4	150	130	90	400	9	19	21	27	39	70	75	DTT534L
0.7	1	150	130	90	1000	14	42	52	69	75	75	75	DTT543H1
0.7	2	150	130	90	1000	9	21	30	38	66	75	75	DTT543J1
0.7	10	150	130	90	1000	9	19	22	29	39	58	75	DTT543N1
1.4	1	150	130	90	300	21	49	59	75	75	75	75	DTT543H
1.4	2	150	130	90	300	14	30	38	53	70	70	70	DTT543J
1.4	3	150	130	90	300	13	24	29	39	64	70	70	DTT543K
1.4	4	150	130	90	300	13	24	28	37	59	70	70	DTT543L
1.4	5	150	130	90	300	14	24	28	34	48	75	75	DTT543M
1.4	10	150	130	90	500	14	24	28	34	44	60	75	DTT543N
0.1	2	200	175	125	1000	-	-	9	14	34	75	75	DTT634J
0.1	10	200	175	125	1000	-	5	8	11	21	41	75	DTT634N
0.18	1	200	175	125	500	-	16	21	38	65	75	75	DTT634H
0.18	4	200	175	125	500	-	9	11	17	30	75	75	DTT634L
0.2	2	200	175	125	1000	-	11	17	29	57	75	75	DTT634J1
0.45	1	200	175	125	500	10	38	49	67	70	70	70	DTT643H
0.45	2	200	175	125	500	4	20	28	45	70	70	70	DTT643J
0.45	4	200	175	125	500	5	14	18	26	40	70	70	DTT643L
0.45	10	200	175	125	500	5	15	19	24	35	50	75	DTT643N
0.8	3	200	175	125	250	9	20	25	35	60	70	70	DTT643K
0.8	5	200	175	125	250	9	19	23	30	45	70	70	DTT643M
0.12	1	300	260	185	500	-	11	20	36	66	75	75	DTT734H
0.12	2	300	260	185	500	-	6	10	18	41	75	75	DTT734J
0.12	4	300	260	185	500	-	6	9	15	27	62	75	DTT734L
0.12	10	300	260	185	500	-	6	9	15	25	45	75	DTT734N
0.25	1	300	260	185	1000	3	30	41	57	75	75	75	DTT743H
0.25	2	300	260	185	1000	-	15	23	39	68	70	70	DTT743J
0.25	3	300	260	185	1000	-	10	15	25	50	70	70	DTT743K
0.25	4	300	260	185	1000	-	9	13	20	38	70	70	DTT743L
0.25	5	300	260	185	1000	2	10	13	19	35	75	75	DTT743M
0.25	10	300	260	185	1000	-	12	14	19	30	54	75	DTT743N
0.28	3	300	260	185	1000	2	12	17	30	57	80	80	DTT743K1

NOTE - Voltage decreases linearly from 85°C to 125°C

Cap μ F	Rated Current (Amps)	Voltage dc (-55°C to 85°C)	Voltage dc (+125°C)	Voltage ac 400Hz (+125°C)	Min IR (M Ω)	Min. Insertion Loss (dB) (50 Ω system)							Part Prefix
						30 kHz	100 kHz	150 kHz	300 kHz	1MHz	10MHz	1 GHz	
0.04	1	450	400	280	500	-	-	-	16	46	80	80	DTT834H
0.04	2	450	400	280	500	-	-	-	6	26	73	80	DTT834J
0.04	4	450	400	280	500	-	-	-	5	19	60	75	DTT834L
0.04	10	450	400	280	500	-	-	-	5	15	39	75	DTT834N
0.1	10	450	400	280	1000	-	6	7	12	23	40	75	DTT843N
0.12	1	450	400	280	1000	-	27	37	56	70	75	75	DTT843H
0.12	2	450	400	280	1000	-	8	16	33	60	70	70	DTT843J
0.12	3	450	400	280	1000	-	4	8	18	44	70	70	DTT843K
0.12	4	450	400	280	1000	-	4	7	14	33	70	70	DTT843L
0.12	5	450	400	280	1000	-	4	7	13	29	70	70	DTT843M
0.008	1	600	530	375	1000	-	-	-	6	40	74	75	DTT934H1
0.008	2	600	530	375	1000	-	-	-	-	17	71	75	DTT934J1
0.008	4	600	530	375	1000	-	-	-	-	3	43	75	DTT934L1
0.008	10	600	530	375	1000	-	-	-	-	-	23	75	DTT934N1
0.01	1	600	530	375	1000	-	-	-	7	42	75	75	DTT934H2
0.01	2	600	530	375	1000	-	-	-	-	19	74	75	DTT934J2
0.01	4	600	530	375	1000	-	-	-	-	4	45	75	DTT934L2
0.01	10	600	530	375	1000	-	-	-	-	3	26	75	DTT934N2
0.02	1	600	530	375	500	-	-	-	20	51	75	75	DTT934H
0.02	2	600	530	375	500	-	-	-	2	22	68	75	DTT934J
0.02	4	600	530	375	500	-	-	-	2	12	48	75	DTT934L
0.02	10	600	530	375	500	-	-	-	2	11	31	75	DTT934N
0.07	1	600	530	375	1200	-	17	28	46	70	70	70	DTT943H
0.07	2	600	530	375	1200	-	-	10	27	57	70	70	DTT943J
0.07	3	600	530	375	1200	-	-	3	13	39	70	70	DTT943K
0.07	4	600	530	375	1200	-	-	-	11	34	70	70	DTT943L
0.07	5	600	530	375	1200	-	-	-	8	19	52	70	DTT943M

NOTE - Voltage decreases linearly from 85°C to 125°C

Technical Information

BODY & NUT	Tin or Silver
ENVIRONMENTAL CLASSIFICATIONS	55/125/56 Hermetic



SAI GLOBAL
AS9100
Aerospace

*ROHS versions available upon request - please speak to the sales department

Panel Mounted Hermetic Twin T & Twin Pi Filters

[Key Characteristics

Applications

- Panels
- Bulkhead filter arrays

Performance

- ≤ 4μF
- ≤ 600Vdc
- High Frequency
- Temperature -55°C to 125°C

Rugged

- Discoidal construction

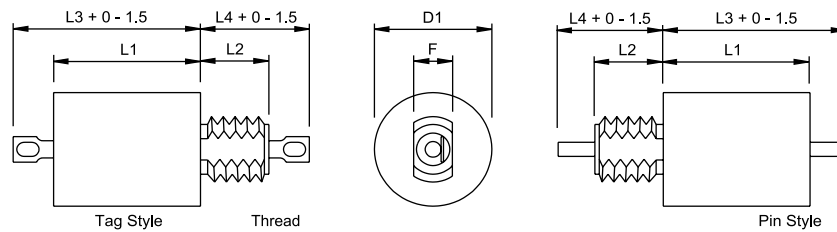
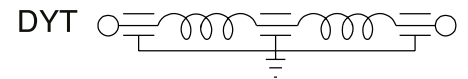
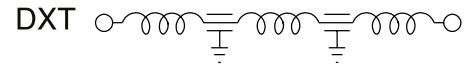

ALL DIMENSIONS ARE MAX AND ARE IN MM UNLESS OTHERWISE STATED

CASE DIMENSIONS

/__	D1	F	L1	L2	L3	L3	L4	L4	Thread	Tag hole	Pin dia	Max Panel Thickness	
		Nom		STD (Long)	tag	Pin	Tag - STD (Long)	Pin - STD (Long)	UNF2A	Metric		STD(Long)	
/34	9.78	5.08	26	4.83(7.92)	30.1	38.4	8.9(12.0)	17.2(20.3)	1/4-28	M6x0.75	1.27x1.78	1.55	1.5(3.0)
/35	9.78	5.08	30.2	4.83(7.92)	34.3	42.6	8.9(12.0)	17.2(20.3)	1/4-28	M6x0.75	1.27x1.78	1.55	3.0 (3.0)
/44	17.53	6.35	34.15	8	39.2	46.1	14	20	5/16-24	M8x1.0	1.45x3.0	2.15	3
/45	17.53	6.35	39.25	8	44.3	51.2	14	20	5/16-24	M8x1.0	1.45x3.0	2.15	3

[Ordering Information

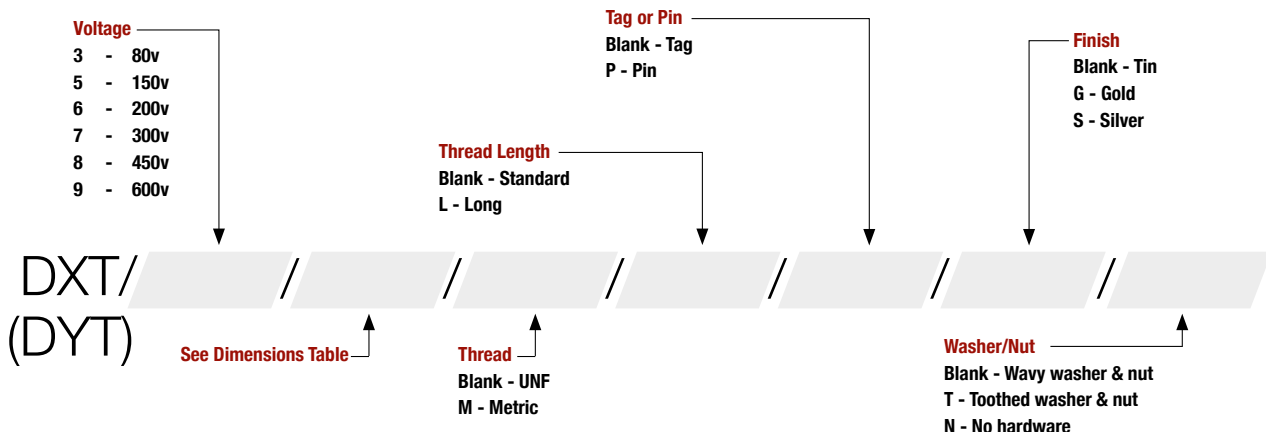

Type	Nominal Cap.(μ F)	Rated Current (Amps)	Voltage dc (-55°C to 85°C)	Voltage dc (+125°C)	Voltage ac 400Hz (+125°C)	MinIR (M Ω)	Min. Insertion Loss (dB) (50 Ω system)							Part Prefix
							30 kHz	100 kHz	150 kHz	300 kHz	1 MHz	10 MHz	1 GHz	
DXT	3	1	80	70	50	100	35	70	70	70	70	70	70	DXT345H
DXT	3	4	80	70	50	100	10	42	55	70	70	70	70	DXT345L
DXT	2.1	1	150	130	90	150	35	70	70	70	70	70	70	DXT545H
DXT	2.1	4	150	130	90	150	-	36	50	65	70	70	70	DXT545L
DXT	0.18	1	200	175	125	500	-	-	19	48	90	90	90	DXT635H
DXT	0.18	4	200	175	125	500	-	-	-	-	42	90	90	DXT635L
DXT	1.5	1	200	175	125	100	23	65	70	70	70	70	70	DXT645H
DXT	0.5	1	300	260	185	500	-	49	66	90	90	90	90	DXT745H
DXT	0.5	4	300	260	185	500	3	9	5	28	68	90	90	DXT745L
DXT	0.21	1	450	400	280	500	-	33	49	80	80	80	80	DXT845H
DXT	0.21	4	450	400	280	500	-	-	-	22	60	70	70	DXT845L
DXT	0.14	1	600	530	375	800	-	6	18	43	70	70	70	DXT945H
DXT	0.14	4	600	530	375	800	-	-	-	8	50	70	70	DXT945L
DYT	4	1	80	70	50	100	45	70	70	70	70	70	70	DYT344H
DYT	4	5	80	70	50	100	6	45	65	70	70	70	70	DYT344M
DYT	0.9	1	150	130	90	250	-	-	63	90	90	90	90	DYT534H
DYT	0.9	4	150	130	90	250	-	-	-	15	85	90	90	DYT534L
DYT	2.1	1	150	130	90	140	34	90	90	90	90	90	90	DYT544H
DYT	2.1	5	150	130	90	170	9	15	28	70	90	90	90	DYT544M
DYT	1.5	1	200	175	125	100	22	70	70	70	70	70	70	DYT644H
DYT	0.25	5	300	260	185	500	-	-	-	25	70	70	70	DYT744M
DYT	0.5	1	300	260	185	500	-	3	27	60	70	70	70	DYT744H
DYT	0.21	1	450	400	280	500	-	33	50	70	70	70	70	DYT844H
DYT	0.21	5	450	400	280	500	-	4	4	8	60	70	70	DYT844M
DYT	0.21	1	600	530	375	500	-	10	32	65	70	70	70	DYT944H
DYT	0.21	5	600	530	375	400	-	-	-	6	33	70	70	DYT944M

Technical Information

BODY & NUT	Tin or Silver
ENVIRONMENTAL CLASSIFICATIONS	55/125/56 Hermetic



SAI GLOBAL
AS9100
Aerospace

*ROHS versions available upon request - please speak to the sales department

Panel Mounted Multiway L and C Circuit Filters

[Key Characteristics

Applications

- Panels
- Bulkhead filter arrays

Rugged

- Planar construction
- High performance

Performance

- ≤22,000pF
- ≤200Vdc
- High frequency
- Temperature -55°C to +125°C

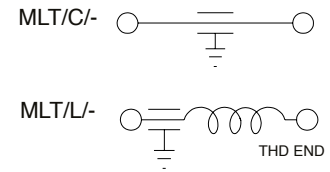

[Electrical Characteristics

Circuit Type	Cap. (pF) (-20% +80%)	Single Line Current Rating (Ad.c.)	Bunched Current Rating (Ad.c.)	Voltage dc* (-55°C to 85°C)	Voltage dc (+125°C)	Typical Insertion loss (dB) (50 Ω system)					Colour Code** Top/ Threaded end	Code/ Colour** marking
						1 MHz	10 MHz	100 MHz	1 GHz	10 GHz		
C	330	10	5	200v	100v	—	2	18	35	60	Green/White	OX C3 30
C	680	10	5	200v	100v	1	4	22	35	70	Grey/White	OX C6 80
C	1000	10	5	200v	100v	1	9	26	40	70	Brown/White	OX C1 n0
C	4700	10	5	200v	100v	3	20	36	50	70	Red/White	OX C4 n7
C	10000	10	5	200v	100v	8	27	44	63	70	Black/White	OX C1 0n
C	22000	10	5	200v	100v	12	30	50	68	70	Blue/White	OX C2 2n
L	330	10	5	200v	100v	—	2	20	38	60	Green/Red	OX L3 30
L	680	10	5	200v	100v	1	4	24	38	70	Grey/Red	OX L6 80
L	1000	10	5	200v	100v	1	9	28	43	70	Brown/Red	OX L1 n0
L	4700	10	5	200v	100v	3	21	38	56	70	Red/Red	OX L4 n7
L	10000	10	5	200v	100v	8	28	48	70	70	Black/Red	OX L1 0n
L	22000	10	5	200v	100v	12	31	54	70	70	Blue/Red	OX L2 2n

*Voltage derates linearly to 100v dc from 85°C to 125°C

** Marking at manufacturers discretion

[Ordering Information

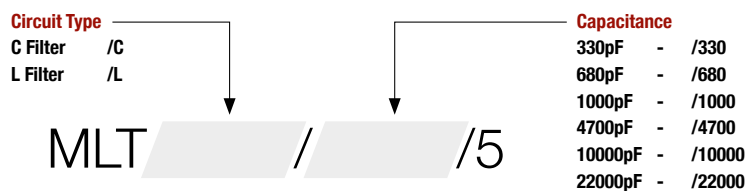

Example: MLTC/4700/5 - C circuit, 4700pF

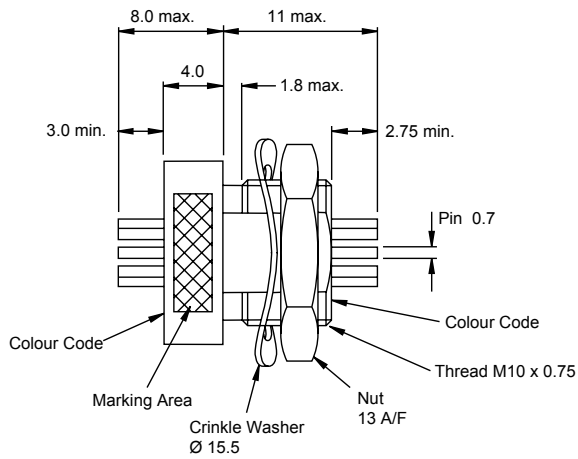

Thread	M10 \times 0.75
Min. Pitch	14.60 mm
Min. Chassis Thickness	2.25 mm
Max Chassis Thickness	5.0 mm

ALL DIMENSIONS IN MM

Mounting Details

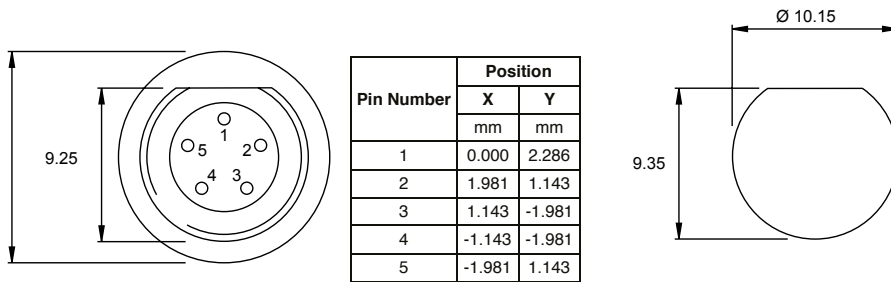

Technical Information

CASE & NUT	Brass, Silver finish
WASHER	Tin plated Beryllium Copper Alloy
FEEDTHROUGH TERMINATIONS	Copper Alloy, Tin Lead or Silver finish



SAI GLOBAL
AS9100
Aerospace

*ROHS versions available upon request - please speak to the sales department

Product Installation

Due to the nature of the components used in the assembly of ceramic filters, great care must be taken to avoid damage either by mechanical or thermal stress during the installation or termination of the device. Bending or cropping of terminal wires should not be carried out unless adequate support of the wire can be provided to eliminate the possibility of mechanical stress or shock during the cutting operation.

To achieve optimum insertion loss performance, the design of the equipment must be such that it allows for the component to be mounted to a bulkhead of minimal impedance. Co-axial earthing over a full 360° must be achieved and input and output connections should be screened from each other.

LEAD WIRE ATTACHMENT

- 1 To eliminate the risk of thermal shock, the filter assembly should be preheated to 120°C (248°F) for 5 minutes.
- 2 Joints should be effected using a soldering iron with a bit temperature not exceeding 300°C (572°F). To minimise the heat transfer to the filter elements, the solder joint should be completed within a period not exceeding 10 seconds.
- 3 The assembly should be allowed to cool at a rate not exceeding 100°C (212°F) per minute.
- 4 In subsequent degreasing operations, care must be taken to avoid any thermal shock.

Component Mounting

SOLDER STYLE

- 1 The filter and mounting plate must be preheated together to eliminate thermal shock on the ceramic elements. This assembly should be allowed to increase in temperature gradually by soaking in an ambient of 120°C (248°F) for a period of up to 5 minutes where possible. Heat must not be applied directly to the filter body and the temperature on the filter surface should not be allowed to increase faster than by 100°C (212°F) per minute.
- 2 After the preheat cycle, the temperature should be raised to achieve solder flow, not exceeding 250°C. This should be maintained for a minimum period, consistent with a good joint (10 seconds maximum). Forced cooling, e.g. by cleaning must be avoided.

THREADED STYLE

- 1 All thread area and mating surfaces must be clean and dry prior to assembly.
- 2 If a washer is used, this must be fitted between the nut and ground plane. The selection of the washer style - either internal toothed or wavy, must take into consideration the material of the bulkhead. It is recommended that toothed washers should not be used in conjunction with protective finishes such as alochrome.
- 3 If mounting in a threaded hole, the form of the hole should be as style A, which is designed to ensure efficient RF sealing of the assembly by maximizing the mating surface area. For mounting in a plain hole by the use of the supplied mounting hardware, the clearance hole should be as style B or C.
- 4 The maximum panel thickness as detailed for the particular device must not be exceeded. The mounting torque as defined below for the particular style of hole and thread diameter must be observed. No strain should be exerted on the cylindrical part of the filter body or on any of the terminal/seal areas.
- 5 Locking compounds, if used, should be applied after the device has been installed to the correct mounting torque to avoid the danger of mating surface contamination and the subsequent increase in the resistance of the filter to the bulkhead joint (resulting in serious insertion loss degradation).
- 6 When mounting into a threaded hole, the maximum permissible mounting torque applied must be limited to half the value defined for mounting into a non-threaded hold (see table overleaf).

PERMISSABLE MOUNTING TORQUES (unless otherwise stated on data sheet)

THREAD	CLEARANCE MOUNTING HOLE D + 0.2 - 0.0 MM	MAX. TORQUE CLEARANCE HOLE (NM)	MAX. TORQUE THREADED HOLE (NM)
4-4 UNC 2A	2.95	0.4	0.2
6-32 UNC 2A	3.6	0.4	0.2
6-40 UNF 2A	3.6	0.4	0.2
8-32 UNC 2A	4.3	0.4	0.2
12-28 UNF 2A	5.6	0.6	0.3
12-32 UNEF 2A	5.6	0.6	0.3
1/4"-28 UNF 2A	6.6	1.0	0.5
5/16"-24 UNF 2A	8.2	1.2	0.6
5/16"-32 UNEF 2A	8.2	1.4	0.7
3/8"-32 UNEF 2A	9.8	1.8	0.9
M3	3.1	0.4	0.2
M3.5 x 0.6	3.6	0.4	0.2
M4 x 0.5	4.1	0.6	0.3
M5 x 0.5	5.1	0.8	0.4
M5 x 0.8	5.1	0.8	0.4
M6 x 0.75	6.1	1.0	0.5
M8 x 1.0	8.2	1.4	0.7
M10	10.1	1.8	0.9
2BA	5.1	0.6	0.3

BULKHEAD MOUNTING DETAILS

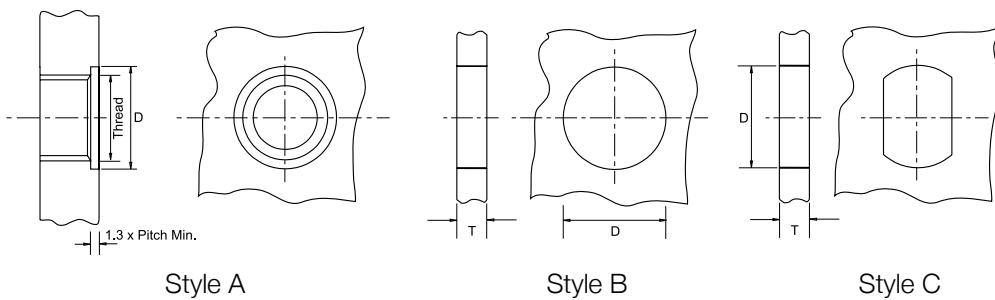

MOUNTING PANEL THICKNESS (DCT, DLT, DUT, DPT, DTT, DXT and DYT)

CASE DIMENSION	RECOMMENDED MOUNTING STYLE	MAXIMUM PANEL THICKNESS (T) FOR MOUNTING BY NUT (mm)	
		STANDARD THREAD	LONG THREAD
00	B or C	1.5	3.0
05	A or B	2.0	-
06	A or B	2.0	-
07	A or B	2.0	-
08	A or B	3.0	-
09	A or B	3.0	-
12	B or C	1.5	3.0
13	B or C	1.5	3.0
14	B or C	1.5	3.0
15	B or C	1.5	3.0
17	B or C	1.5	3.0
18	A or B	2.5	-
19	A or B	2.5	-
22	A or B	3.0	-
25	B or C	1.5	3.0
26	B or C	1.5	3.0
27	B or C	1.5	3.0
28	B or C	1.5	3.0
29	B or C	1.5	3.0
31	B or C	1.5	3.0
33	B or C	1.5	3.0
34	B or C	1.5	3.0
35	B or C	1.5	3.0
40	B or C	3.0	-
41	B or C	3.0	-
42	B or C	3.0	-
43	B or C	3.0	-
44	B or C	3.0	-
45	B or C	3.0	-
50	B or C	1.5	3.0
51	B or C	1.5	3.0
55	A or B	1.5	-

INTERNAL TOOTHED LOCK WASHER

Material: Phosphor Bronze

Finish: Tin, silver or gold plated to BS1872 to match filter finish

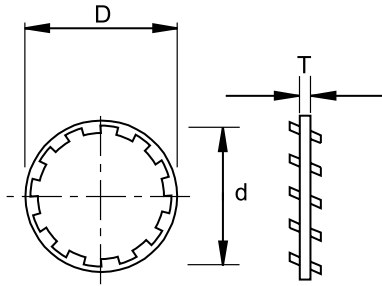

THREAD	d MIN.	D MAX.	T
4UN	2.87	6.48	0.36
6UN	3.68	7.75	0.36
8UN	4.42	8.79	0.46
12UN	5.59	10.31	0.53
¼"/M6	6.5	10.42	0.51
⅝"/M8	9.62	12.85	0.56

WAVY WASHER

Material: Beryllium copper to BS2870 CB101

Finish: Tin, silver or gold plated to BS1872 to match filter finish

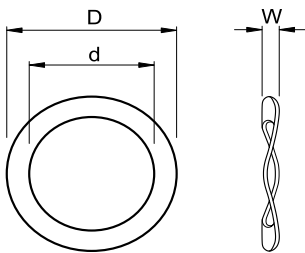

THREAD	+0.1 -0.0	D MAX.	W	Material Thickness
4UN	2.9	5.75	0.5	0.2
6UN/M3.5	3.56	7.24	0.5	0.2
8UN/M4	4.22	8.51	0.7	0.2
2BA/M5	5.3	9.2	0.7	0.3
12UN	5.54	6.98	0.7	0.2
¼"/M6	6.4	10.0	1.0	0.4
⅝"/M8	8.4	11.5	1.0	0.4
⅜"	9.6	12.83	1.5	0.4
M10	10.1	13.2	1.5	0.4

NUT

Material: Brass to BS2874 cz121pB3

Finish: Tin, silver or gold plated to BS1872 to match filter finish

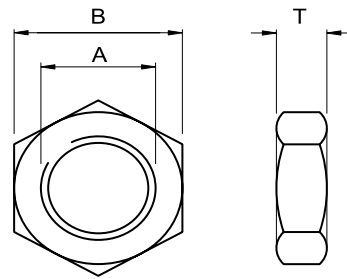

A (THREAD)	B ± 0.13 (A.F.)	T ± 0.13 Thickness
4-40 UNC	4.75	1.6
6-40 UNF	4.75	1.6
8-32 UNC	6.35	1.9
12-32 UNEF	7.92	1.9
12-32 UNEF	6.35	1.9
12-28 UNF	7.92	1.9
12-28 UNF	6.35	1.9
¼"-28 UNF	7.92	2.3
⅝"-32 UNEF	9.53	2.3
⅝"-24 UNF	9.53	2.3
⅜"-32 UNEF	12.7	2.3
M3.5 x 0.6	4.75	1.6
M4.0 x 0.5	6.35	1.9
M5.0 x 0.5	6.35	1.9
M5.0 x 0.8	6.35	1.9
M6.0 x 0.75	7.00	1.9
M8.0 x 1.0	10.00	2.3
M10 x 1.25	12.70	2.3
2BA	6.35	1.9

Application Notes

PERFORMANCE MEASUREMENT AND CALCULATIONS

INSERTION LOSS

The performance of low pass filters is often characterised in terms of an insertion loss curve. Insertion loss can be described as the ratio of voltages across the load with and without the filter in the circuit. This is generally defined using a 50Ω input and load impedance, and given in decibels (dB).

$$\text{Insertion Loss (dB)} = 20 \log_{10} (V1/V2)$$

Where V1 is the signal voltage without the filter present and V2 is the voltage after the filter has been put into the circuit.

All insertion loss figures shown in this catalogue are measured in a 50Ω system.

Since load current increase and temperature excursion reduce the insertion loss of any filter, operation at lower load current and/or temperature excursion than defined in the data tables will result in further gains of insertion loss of typically 3 to 6 dB.

To achieve optimum insertion loss, the filter should be mounted on a bulkhead of minimal RF impedance and provide co-axial earthing over 360°.

INSERTION LOSS CHARACTERISTICS

Figure 4 shows the insertion loss characteristics of various values of simple C style feedthrough filters measured in a 50Ω system.

Insertion Loss Characteristics

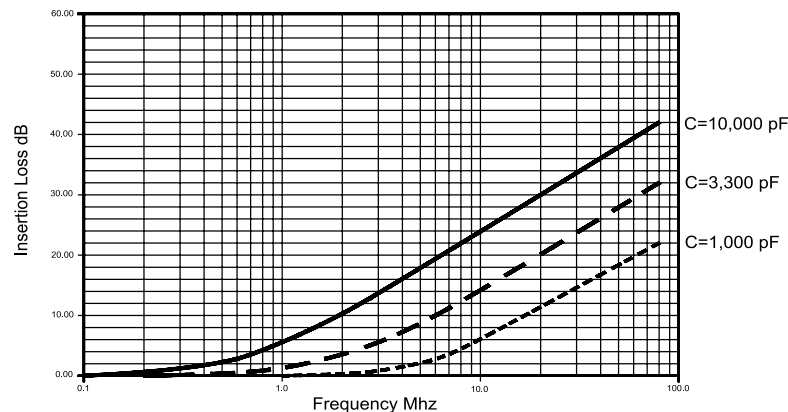

Figure 4 - Insertion Loss of feedthrough capacitor filters

The rising graphs show that the insertion loss rises as the frequency increases above a set point known as the cut-off frequency.

The cut-off frequency is usually defined as the point at which the insertion loss rises above 3 dB. Interference signals at frequencies above the cut-off frequency are increasingly attenuated by the filter. The filter capacitor value must be chosen to ensure that the cut-off frequency is above the desired signal bandwidth. Higher value capacitances result in lower cut-off frequencies, for the same system impedance.

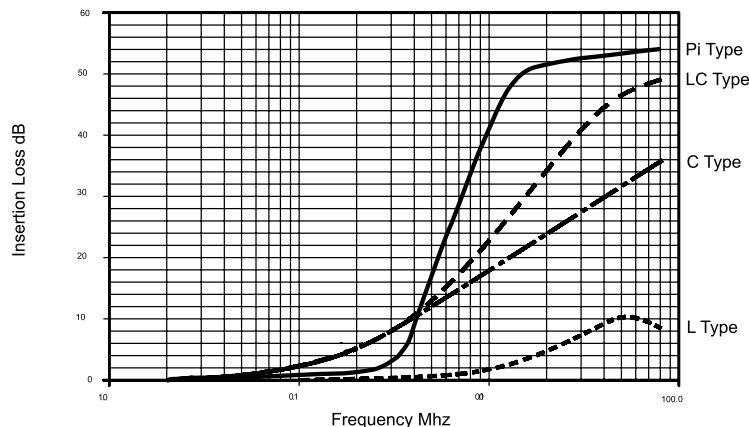

Figure 5 - Insertion Loss for various filter configurations

Figure 5 shows a comparison of typical insertion loss characteristics of different filter configurations. These graphs show that although the insertion loss of an inductive element (L) on its own is very poor, when it is combined with a capacitor to form an LC filter the performance is improved dramatically.

The inductive elements used in many leadthrough filters are in the form of a ferrite bead which has a drop off in attenuation at higher frequencies, leading to the flattening of the high frequency insertion loss response for the L and Pi types.

The responsive curve of the Pi section filter shows an even steeper gradient beyond the cut-off frequency.

In Figures 4 and 5 the characteristics are shown for the filters operating in a 50Ω system, however, the source and load impedance of the circuit in which the filter is operating can have a dramatic effect on the insertion loss. Figure 6 shows the relative low insertion loss of a C type filter operating with a 5Ω source instead of 50s. The graph also shows the dramatic improvement when the filter is replaced with an LC type. In this case the inductive element should be connected to the lower impedance side of the circuit.

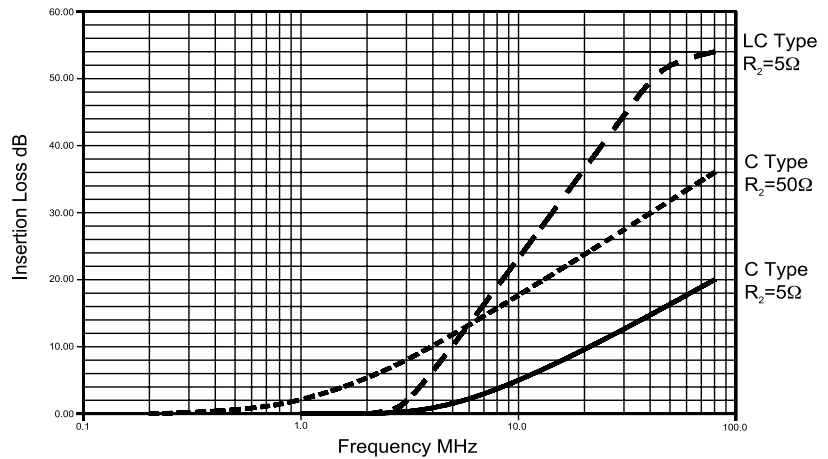

Figure 6 - Use of LC type filters in low impedance systems

CURRENT

The average line current must not exceed the rated current shown in the datasheet. At temperatures in excess of 105°C (221°F), up to a maximum of 125°C (257°F), the maximum current must be derated linearly to 0.6 times the rated current.

The possibility of current transients or surges must be considered. The steady state line current plus the transient of surge current should not be allowed to exceed the following:

- 1.5 times rated current for 10 secs
- 4 times rated current for 500 ms
- 8 times rated current for 50 ms

In filter units incorporating inductors, an increase in line current will reduce the performance of the inductor and hence reduce the level of insertion loss achieved. The insertion loss claimed is only achieved within the load measurement condition defined.

Devices specifying claiming insertion loss at full load current will exhibit higher insertion loss at lower currents.

VOLTAGE

The maximum voltage which may be applied to any filter element must not exceed the voltage rating of the device.

The AC rated voltage is defined for operation up to 125°C (257°F) and for frequencies up to 400 Hz. The peak AC voltage must not exceed the defined DC voltage at 125°C (257°F).

The possibility of voltage transients or spikes must be considered in determining the device voltage.

TEMPERATURE

The operating temperature for the device is defined in the specific voltage rating table - normally from -55°C (-67°F) to +85/+125°C (+185/+257°F). Temperature significantly affects the capacitor value and hence, the insertion loss achieved. The insertion loss claimed is only achieved within the temperature limits defined.

The effect of line current in increasing the temperature of the filter must be remembered. Mounting onto a bulkhead, as well as providing an efficient RF screen, must also provide an efficient heat sink.

The storage temperature of the device must not exceed the operating temperature limits. Extended storage at high ambient temperatures may cause degradation in the solderability of the terminations or discoloration of the finish.

DC VOLTAGE DROP

The effect of the resistance and rated current has been taken into consideration in the temperature rating of the filter. However, the voltage drop at line current should be borne in mind when selecting the current rating of the device. Higher current ratings should be selected if voltage drop must be minimised.

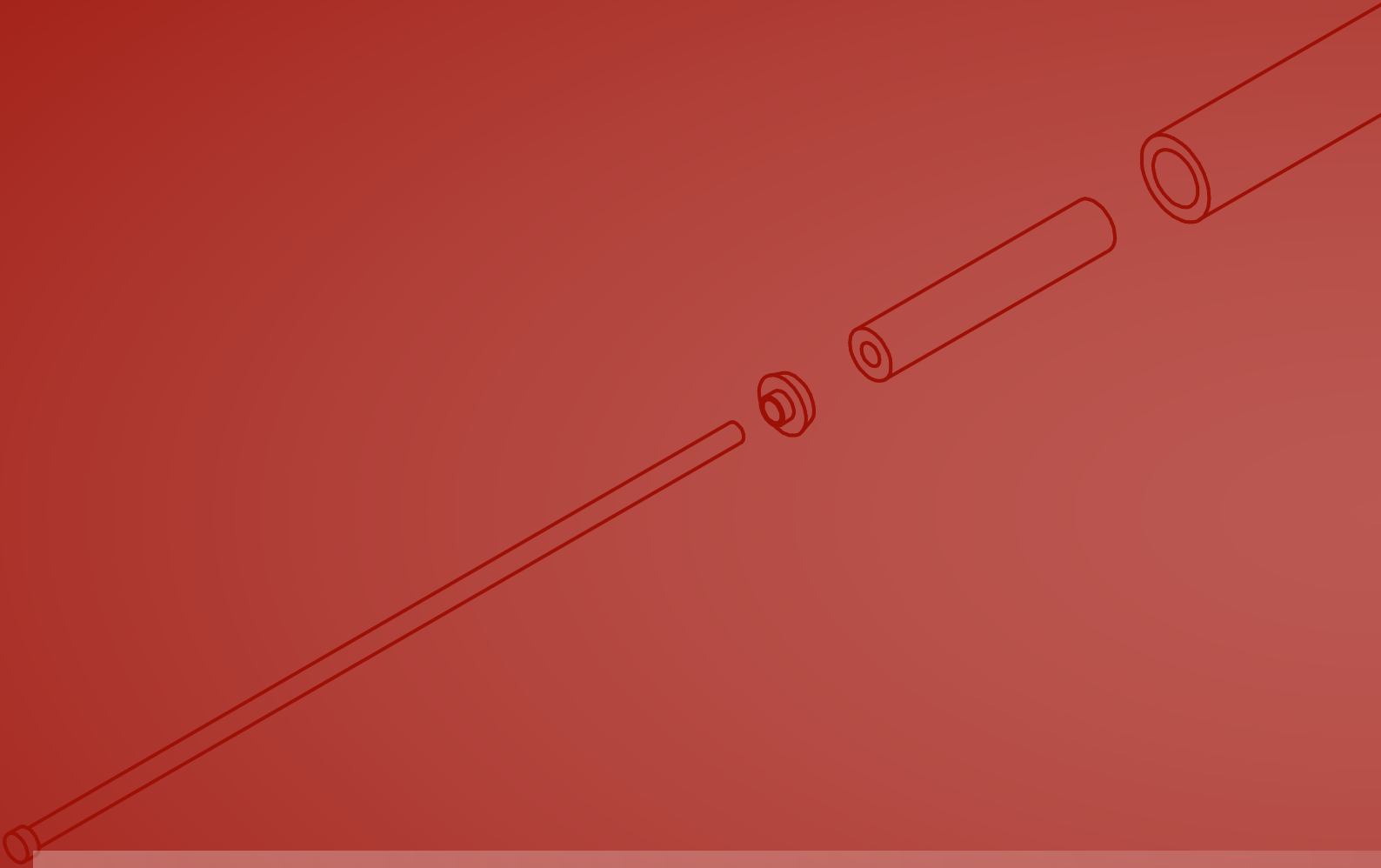

Oxley Developments Company Ltd

Priory Park Ulverston Cumbria LA12 9QG United Kingdom
t: +44 (0) 1229 483226 f: +44 (0) 1229 581851 e: sales@oxleygroup.com

Oxley Inc

31 Business Park Drive Branford CT 06405 USA
t: +1 (203) 488 1033 f: +1 (203) 481 6971 e: info@oxleygroup.com

ODC:SM:3037

