



Table of Contents

5J/52/5221/5223 SERIES.....	P1
5321/5322/5421/5521/5522/5523/5524 SERIES.....	P7
5621/5622/5623/5624 SERIES.....	P13
5631/5632/5918 SERIES.....	P18
5921 SERIES.....	P23
5922/5931/6221/6J31/616PCB SERIES.....	P33

Southern California Office:

15991 Red Hill Avenue, Suite #102,
Tustin, CA 92780 USA
Tel:+1-714-460-0718 Fax:+1-714-460-0728

Northern California Office:

500 Yosemite Drive,
Milpitas, CA 95035 USA
Tel:+1-408-855-8866 Fax:+1-408-855-8868



○ **Electric Performance**

Rated current	1.5AMPS	Rated voltage	125VAC
Contact resistance	Before insertion and extraction force: $\leq 40m\Omega$ After insertion and extraction force: $\leq 100m\Omega$		
Insulation resistance	Hi-Pot-Test $\geq 500M\Omega / 500VDC$		
Testing conditions	AC 1000V/0.5mA 50Hz & 60Hz 1 min		

○ **Mechanical Performance**

Mating Force with plugs	Plug Gold wire number	Mating Force
	2C	1.7kg
	4C	2.1kg
	6C	2.6kg
	8C	3.0kg
	10C	3.3kg
Locking Force	The PC plug should withstand pull of 50N MIN	
Durability	Under normal conditions of usage 750 Cycles MIN	

○ **Materials**

Synthetic plastic case	A. PA46+30%GF UL94V-0 B. PA66+30%GF HB
Plastic cord	C. PBT30%GF UL94V-0 D. LCP30%GF UL94V-0
Cover	0.25 thick copper alloy plated with tin and nickel
Contact Gold pin	A. Round pin: $\phi 0.46mm$, phosphor copper is plated with nickel, and then plated with gold, tin, and silver
	B. High pin: $0.45 \times 0.35mm$, phosphor copper is plated with nickel and then plated with gold, tin and silver
Optional plating thickness	$1.5\mu"$, $1.8\mu"$, $3\mu"$, $6\mu"$, $15\mu"$, $30\mu"$, $50\mu"$

Southern California Office:

15991 Red Hill Avenue, Suite #102,
Tustin, CA 92780 USA
Tel:+1-714-460-0718 Fax:+1-714-460-0728

<http://www.palconnusa.com>

Northern California Office:

500 Yosemite Drive,
Milpitas, CA 95035 USA
Tel:+1-408-855-8866 Fax:+1-408-855-8868

○ **Definitions of the letters in the models**

Code	Meaning
K	Front Full-Open Window
BK	Front Half-Open Window
FK	Reverse Full-Open Window
V	Separate parts
JK	Reverse Half-Open Window
Z	With wave filter
M	Copper shield
W	Gold wire exposed
T	Half shield
S	Full shield
H	Plastic case large size
L	with LED
P	With welding plates
U	With USB
SMT	With SMT
c	Type size
Q	Flat type pin
G	Environmental protection
1	One spring finger
2	Two spring fingers
3	Three spring fingers
4	Four spring fingers

Code	Meaning
A	pin distance front 4.57
B	pin distance front 3.68
C	pin distance back 3.05
D	pin distance front 3.05
E	pin distance back 3.85
F	pin distance back 3.56
12P	12 pin holes
10P	10 pin holes
8P	8 pin holes
12C	12 pins
10C	10 pins
8C	8 pins
4C	4 pins
I	Back pin number of 1
II	Back pin number of 2
III	Back pin number of 3
R	With ears
a	Type size
01	Sequence number 1
02	Sequence number 2
03	Sequence number 3
04	Sequence number 4

○ **Type of pin distance**

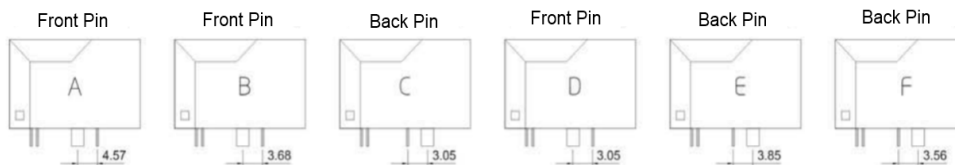

○ **Examples**

RJ45 Product Names

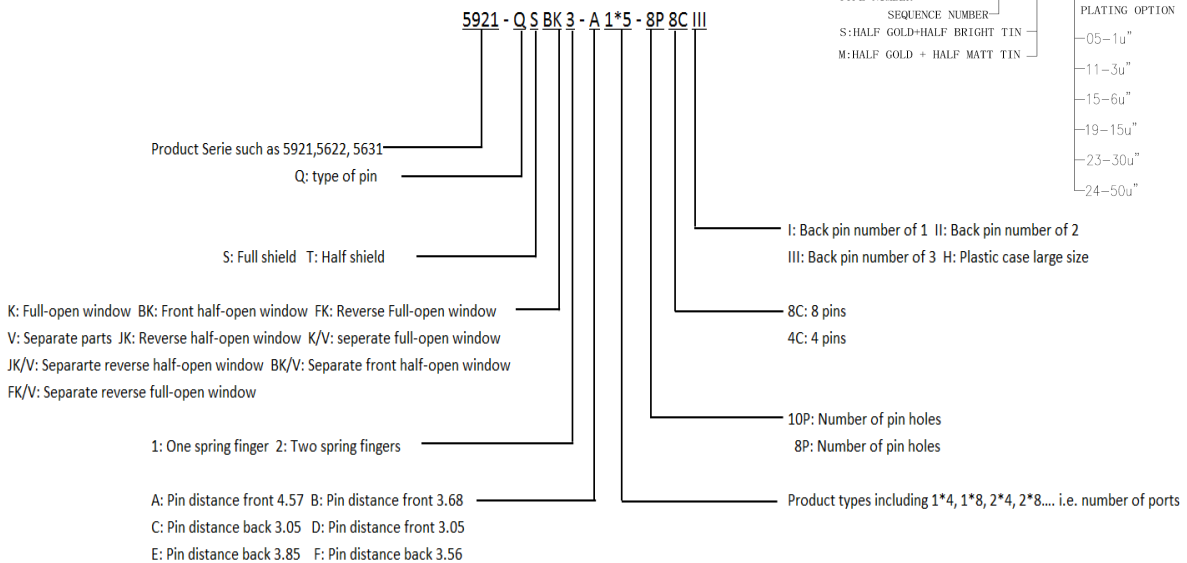

Southern California Office:

15991 Red Hill Avenue, Suite #102,
 Tustin, CA 92780 USA
 Tel:+1-714-460-0718 Fax:+1-714-460-0728

<http://www.palconnusa.com>

Northern California Office:

500 Yosemite Drive,
 Milpitas, CA 95035 USA
 Tel:+1-408-855-8866 Fax:+1-408-855-8868

5J SERIES

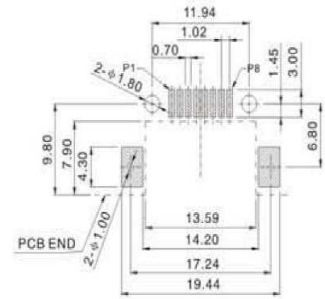
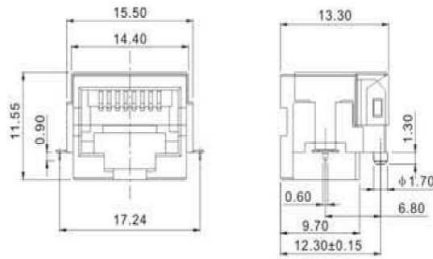

RECOMMENDED P.C.B LAYOUT TOP VIEW
(COMPONENT SIDE TOLERANCE±0.05)

P41000-0XXXX1
5J05-T-SMT-8C

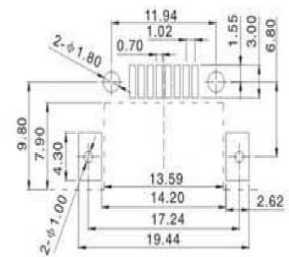
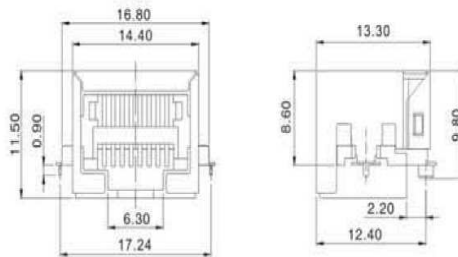

RECOMMENDED P.C.B LAYOUT TOP VIEW
(COMPONENT SIDE TOLERANCE±0.05)

P41028-01XXXX1
5J05-S-SMT-8C-1F

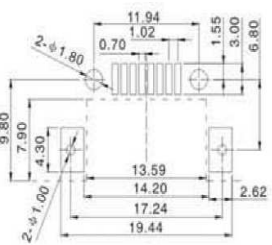
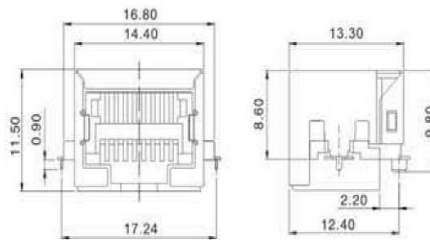

RECOMMENDED P.C.B LAYOUT TOP VIEW
(COMPONENT SIDE TOLERANCE±0.05)

P41028-XXXXX1
5J05-S-SMT-8C-1G

Southern California Office:

15991 Red Hill Avenue, Suite #102,
Tustin, CA 92780 USA
Tel:+1-714-460-0718 Fax:+1-714-460-0728

<http://www.palconnusa.com>

Northern California Office:

500 Yosemite Drive,
Milpitas, CA 95035 USA
Tel:+1-408-855-8866 Fax:+1-408-855-8868

5J/52 SERIES

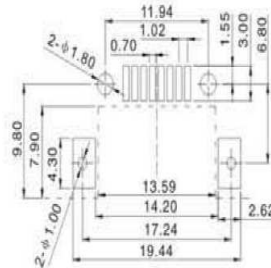
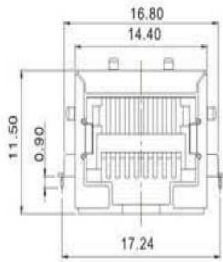

RECOMMENDED P.C.B LAYOUT TOP VIEW
(COMPONENT SIDE TOLERANCE±0.05)



P41330-XXXXX1
5J-S-K4-SMT-8C-1J-G

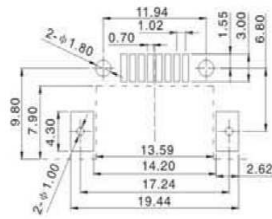
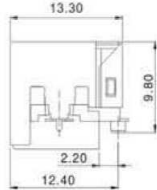
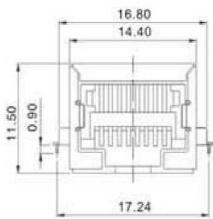

RECOMMENDED P.C.B LAYOUT TOP VIEW
(COMPONENT SIDE TOLERANCE±0.05)



P41332-00J111
5J-S-SMT-8C-1L-G

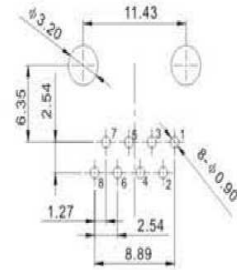
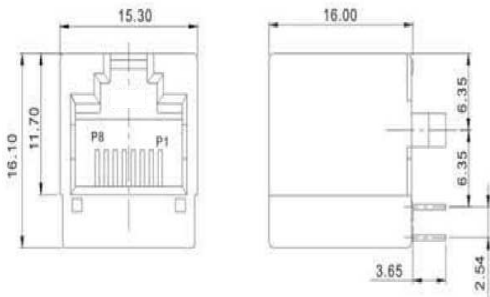

RECOMMENDED P.C.B LAYOUT TOP VIEW
(COMPONENT SIDE TOLERANCE±0.05)



P41350-XXGXX1
52-8C

Southern California Office:

15991 Red Hill Avenue, Suite #102,
Tustin, CA 92780 USA
Tel:+1-714-460-0718 Fax:+1-714-460-0728

<http://www.palconnusa.com>

Northern California Office:

500 Yosemite Drive,
Milpitas, CA 95035 USA
Tel:+1-408-855-8866 Fax:+1-408-855-8868

52 SERIES

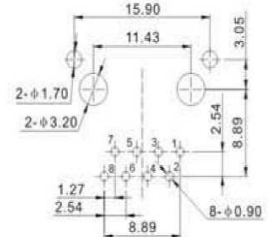
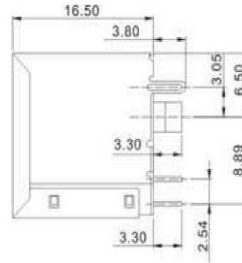
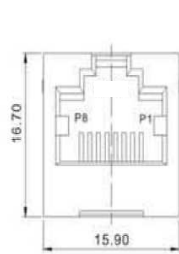

RECOMMENDED P.C.B LAYOUT TOP VIEW
(COMPONENT SIDE TOLERANCE±0.05)

P41351-XXGXX1
52-S-D-8C(4C)

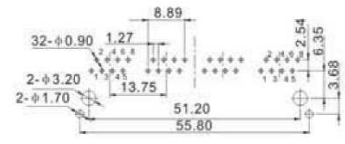
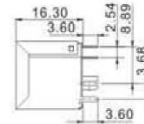
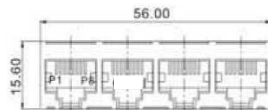

RECOMMENDED P.C.B LAYOUT TOP VIEW
(COMPONENT SIDE TOLERANCE±0.05)

P41353-XXGXX1
52-S-B-1X4-8C(4C)

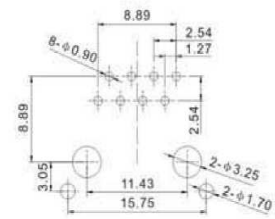
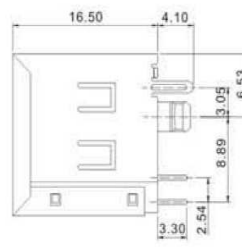
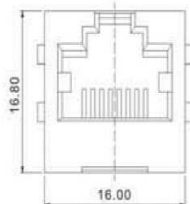

RECOMMENDED P.C.B LAYOUT TOP VIEW
(COMPONENT SIDE TOLERANCE±0.05)

P41003-0XXXX1
52-Q-S-BK4-D-8C-G

Southern California Office:

15991 Red Hill Avenue, Suite #102,
Tustin, CA 92780 USA
Tel:+1-714-460-0718 Fax:+1-714-460-0728

<http://www.palconnusa.com>

Northern California Office:

500 Yosemite Drive,
Milpitas, CA 95035 USA
Tel:+1-408-855-8866 Fax:+1-408-855-8868

5221/5223/5321 SERIES

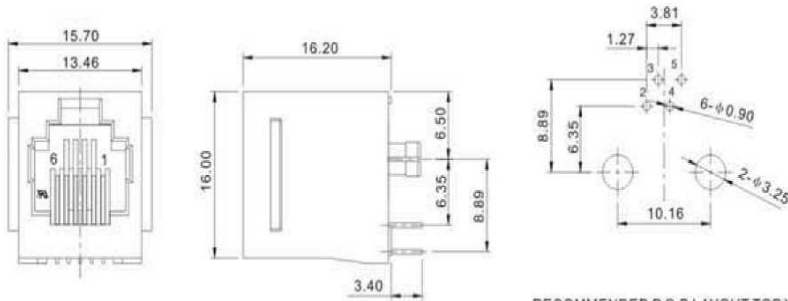

RECOMMENDED P.C.B LAYOUT TOP VIEW
(COMPONENT SIDE TOLERANCE±0.05)



P11080-XXGXXX
5221-1R-W-6P4C (6C/2C)

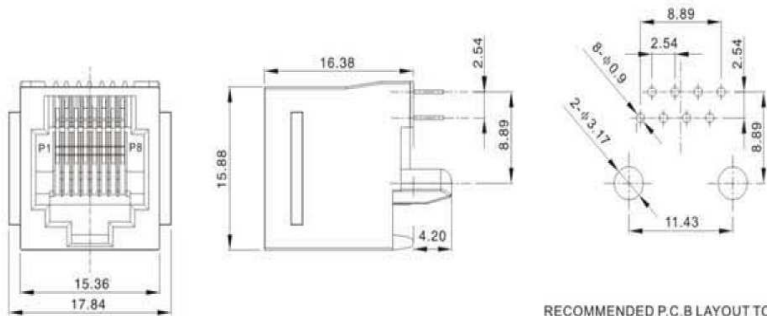

RECOMMENDED P.C.B LAYOUT TOP VIEW
(COMPONENT SIDE TOLERANCE±0.05)



P41001-XXXXXX
5223-Q-R-8P8C

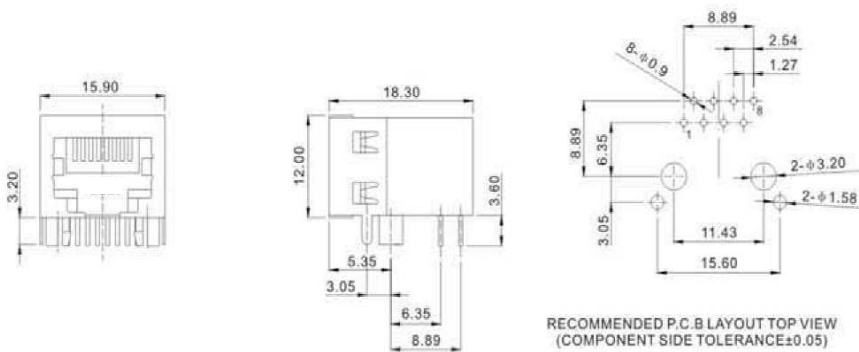

RECOMMENDED P.C.B LAYOUT TOP VIEW
(COMPONENT SIDE TOLERANCE±0.05)



P41038-00GXX1
5221-T-D-8C(4C)

Southern California Office:

15991 Red Hill Avenue, Suite #102,
Tustin, CA 92780 USA
Tel:+1-714-460-0718 Fax:+1-714-460-0728

<http://www.palconnusa.com>

Northern California Office:

500 Yosemite Drive,
Milpitas, CA 95035 USA
Tel:+1-408-855-8866 Fax:+1-408-855-8868

5321 SERIES

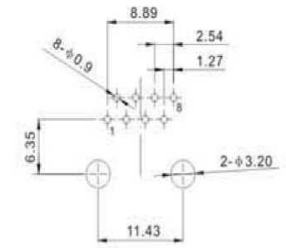
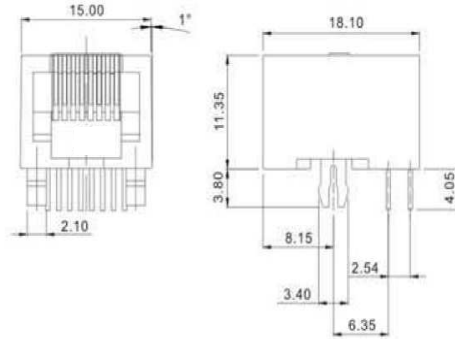

RECOMMENDED P.C.B LAYOUT TOP VIEW
(COMPONENT SIDE TOLERANCE±0.05)

P41040-00GXX1
5321-1-W-8C(4C)

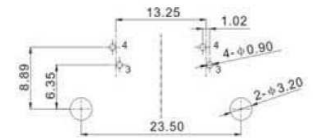
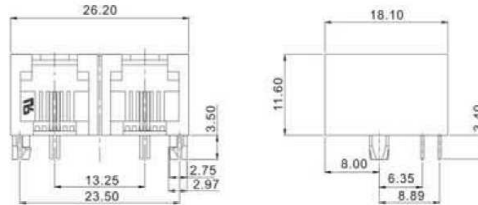

RECOMMENDED P.C.B LAYOUT TOP VIEW
(COMPONENT SIDE TOLERANCE±0.05)

P11024-XXXXX1
5321-2-6P2C (6C/4C)

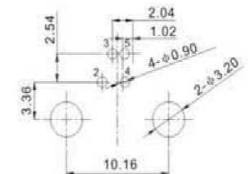
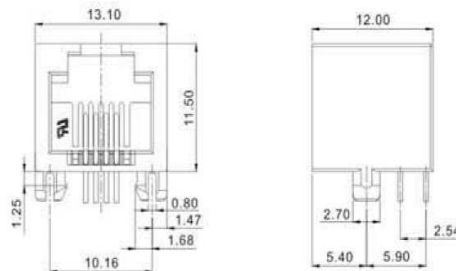

RECOMMENDED P.C.B LAYOUT TOP VIEW
(COMPONENT SIDE TOLERANCE±0.05)

P11002-XXGXX1
5321-1-6P4C (6C/2C)

Southern California Office:

15991 Red Hill Avenue, Suite #102,
Tustin, CA 92780 USA
Tel:+1-714-460-0718 Fax:+1-714-460-0728

<http://www.palconnusa.com>

Northern California Office:

500 Yosemite Drive,
Milpitas, CA 95035 USA
Tel:+1-408-855-8866 Fax:+1-408-855-8868

5321/5322/5421 SERIES

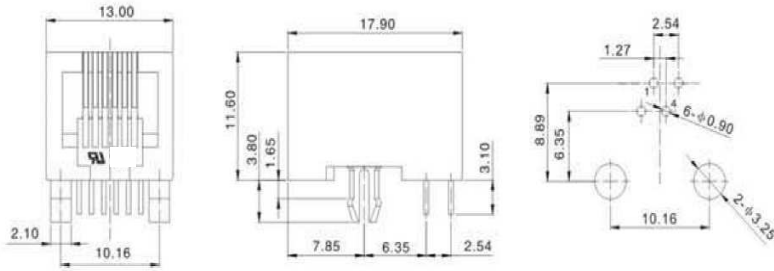

RECOMMENDED P.C.B LAYOUT TOP VIEW
(COMPONENT SIDE TOLERANCE±0.05)



P11005-00GXX1
5321-1-W-6P4C(6C/2C)

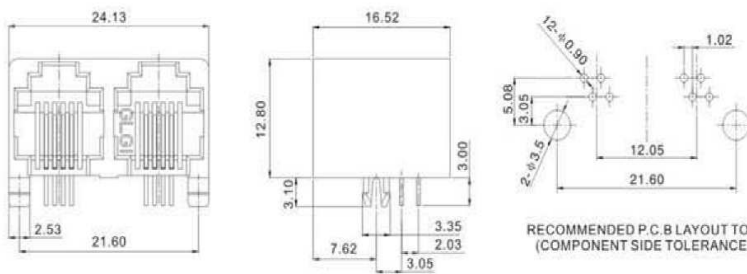

RECOMMENDED P.C.B LAYOUT TOP VIEW
(COMPONENT SIDE TOLERANCE±0.05)

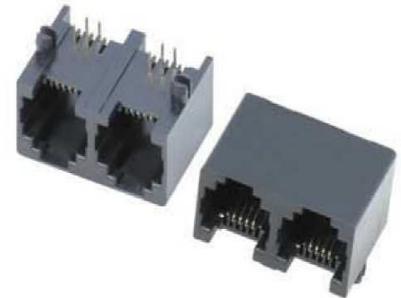

P11040-00GXX1
5322-2-6P4C(6C/2C)

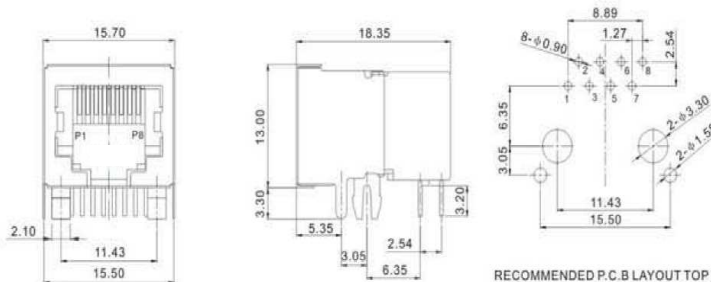

RECOMMENDED P.C.B LAYOUT TOP VIEW
(COMPONENT SIDE TOLERANCE±0.05)



P41380-00GXX1
5421-T-D-W-8C(4C)

Southern California Office:

15991 Red Hill Avenue, Suite #102,
Tustin, CA 92780 USA
Tel:+1-714-460-0718 Fax:+1-714-460-0728

<http://www.palconnusa.com>

Northern California Office:

500 Yosemite Drive,
Milpitas, CA 95035 USA
Tel:+1-408-855-8866 Fax:+1-408-855-8868

5521 SERIES

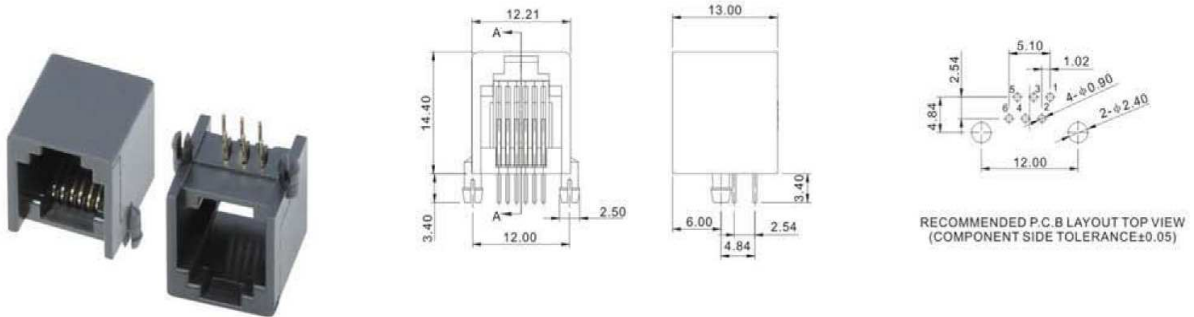

P11098-XXGXX1
5521-1-6P6C(4C/2C)

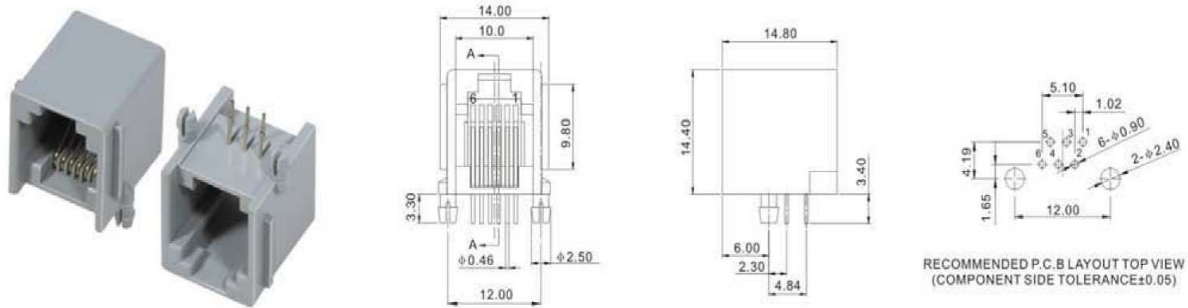

P11099-XXGXX1
5521-1R-6P6C(4C/2C)

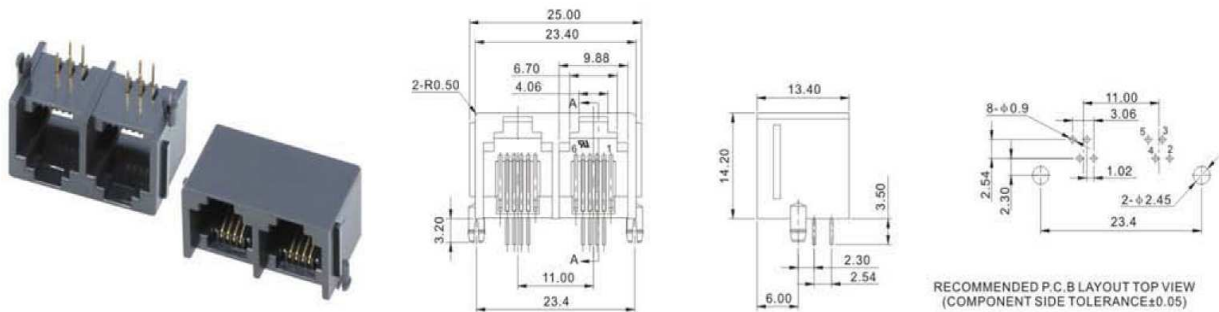

P11094-XXGXX1
5521-2R-6P4C (6C/2C)

Southern California Office:

15991 Red Hill Avenue, Suite #102,
Tustin, CA 92780 USA
Tel:+1-714-460-0718 Fax:+1-714-460-0728

<http://www.palconnusa.com>

Northern California Office:

500 Yosemite Drive,
Milpitas, CA 95035 USA
Tel:+1-408-855-8866 Fax:+1-408-855-8868

5521/5522/5523 SERIES

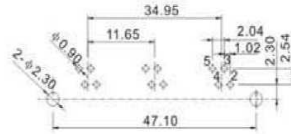
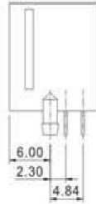
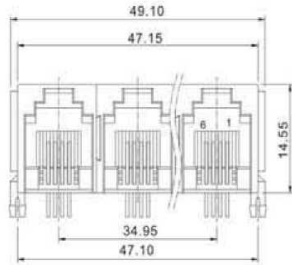

RECOMMENDED P.C.B LAYOUT TOP VIEW
(COMPONENT SIDE TOLERANCE±0.05)



P11090-XXGXX1
5521-4R-6P4C(6C/2C)

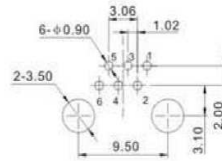
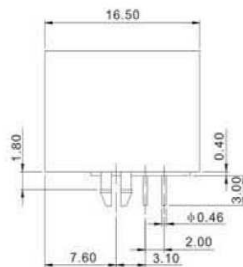
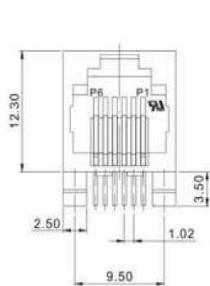

RECOMMENDED P.C.B LAYOUT TOP VIEW
(COMPONENT SIDE TOLERANCE±0.05)



P11132-00GXX1
5522-1-6P6C(4C/2C)

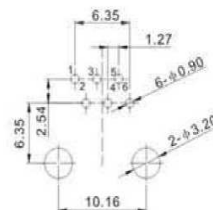
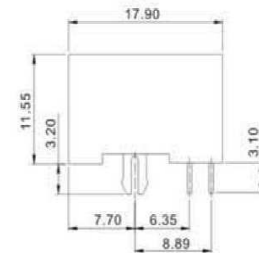
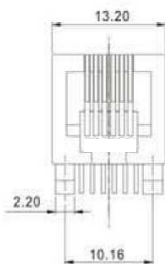

RECOMMENDED P.C.B LAYOUT TOP VIEW
(COMPONENT SIDE TOLERANCE±0.05)



P11050-00GXX1
5523-1-W-6P6C(4C/2C)

Southern California Office:

15991 Red Hill Avenue, Suite #102,
Tustin, CA 92780 USA
Tel:+1-714-460-0718 Fax:+1-714-460-0728

<http://www.palconnusa.com>

Northern California Office:

500 Yosemite Drive,
Milpitas, CA 95035 USA
Tel:+1-408-855-8866 Fax:+1-408-855-8868

5523/5524 SERIES

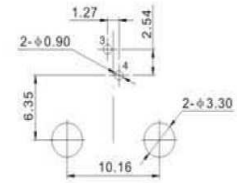
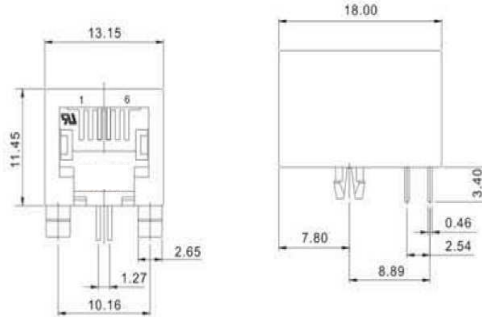
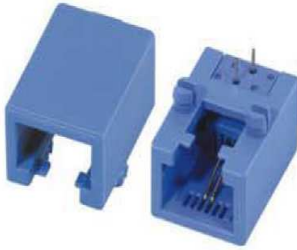

RECOMMENDED P.C.B LAYOUT TOP VIEW
(COMPONENT SIDE TOLERANCE±0.05)

P11056-00GXX1
5523-1-6P2C(6C/4C)

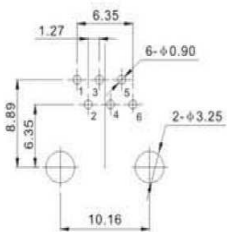
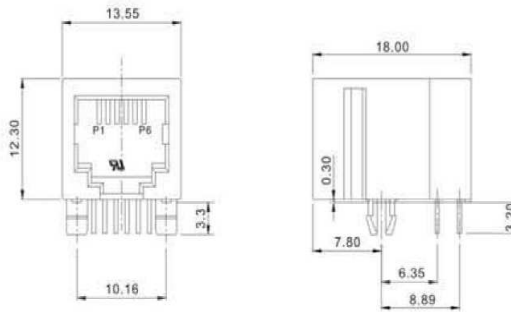

RECOMMENDED P.C.B LAYOUT TOP VIEW
(COMPONENT SIDE TOLERANCE±0.05)

P11111-00GXX1
5524-6P6C(4C/2C)

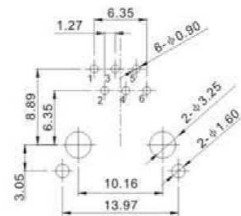
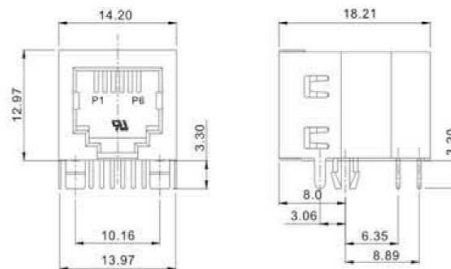

RECOMMENDED P.C.B LAYOUT TOP VIEW
(COMPONENT SIDE TOLERANCE±0.05)

P11112-00GXX1
5524-T-D-6P6C (4C/2C)

Southern California Office:

15991 Red Hill Avenue, Suite #102,
Tustin, CA 92780 USA
Tel:+1-714-460-0718 Fax:+1-714-460-0728

<http://www.palconnusa.com>

Northern California Office:

500 Yosemite Drive,
Milpitas, CA 95035 USA
Tel:+1-408-855-8866 Fax:+1-408-855-8868

5621 SERIES

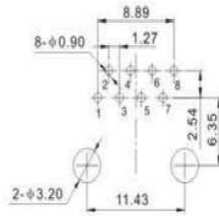
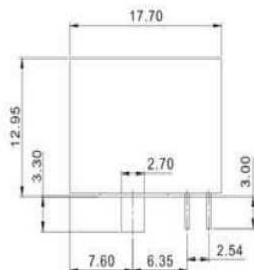
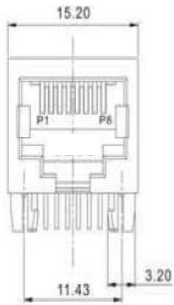

RECOMMENDED P.C.B LAYOUT TOP VIEW
(COMPONENT SIDE TOLERANCE±0.05)



P41360--XXGXX1
5621-8C(4C)

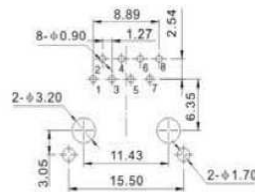
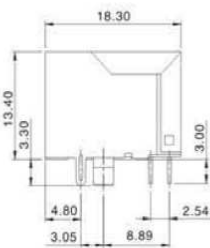
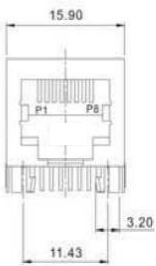

RECOMMENDED P.C.B LAYOUT TOP VIEW
(COMPONENT SIDE TOLERANCE±0.05)



P41363-XXGXX1
5621-S-D-8C(4C)

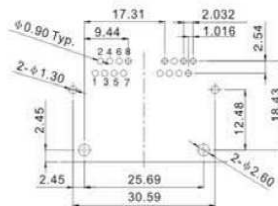
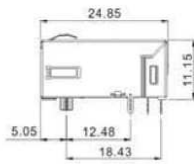
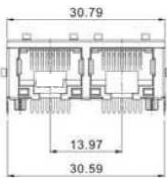

RECOMMENDED P.C.B LAYOUT TOP VIEW
(COMPONENT SIDE TOLERANCE±0.05)

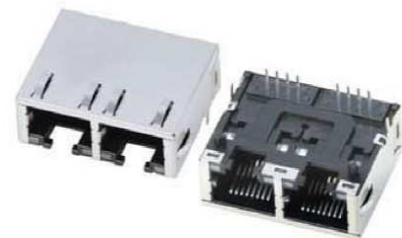

P41004-0XXXX1
5621-Q-S-BK6-1X2-8P8C

Southern California Office:

15991 Red Hill Avenue, Suite #102,
Tustin, CA 92780 USA
Tel:+1-714-460-0718 Fax:+1-714-460-0728

<http://www.palconnusa.com>

Northern California Office:

500 Yosemite Drive,
Milpitas, CA 95035 USA
Tel:+1-408-855-8866 Fax:+1-408-855-8868

5622 SERIES

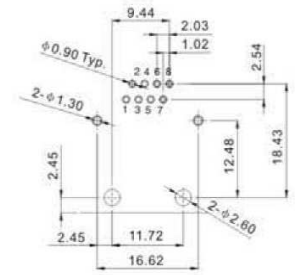
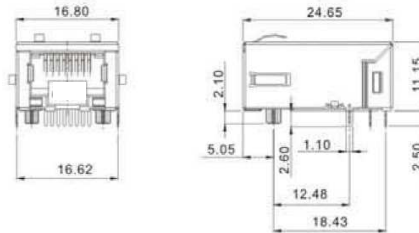

RECOMMENDED P.C.B LAYOUT TOP VIEW
(COMPONENT SIDE TOLERANCE±0.05)

P4130-00M241
5621-Q-S-K4-8P8C

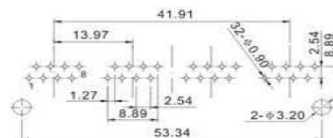
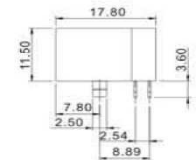
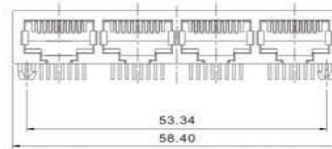
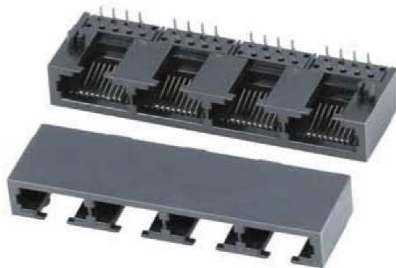

RECOMMENDED P.C.B LAYOUT TOP VIEW
(COMPONENT SIDE TOLERANCE±0.05)

P41018-XXGXX1
5622-1X4-8C(4C)

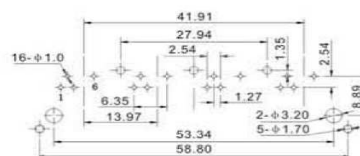
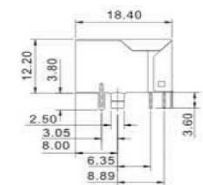
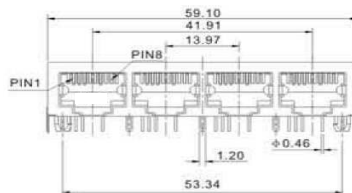

RECOMMENDED P.C.B LAYOUT TOP VIEW
(COMPONENT SIDE TOLERANCE±0.05)

P41021-XXGXX1
5622-S-D-1X4-4C-III (BK3/8C)

Southern California Office:

15991 Red Hill Avenue, Suite #102,
Tustin, CA 92780 USA
Tel:+1-714-460-0718 Fax:+1-714-460-0728

<http://www.palconnusa.com>

Northern California Office:

500 Yosemite Drive,
Milpitas, CA 95035 USA
Tel:+1-408-855-8866 Fax:+1-408-855-8868

5622 SERIES

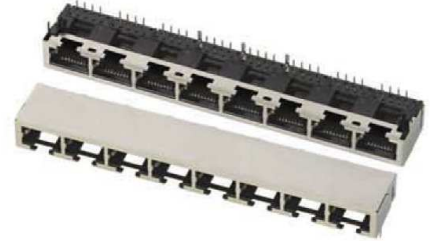
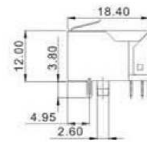
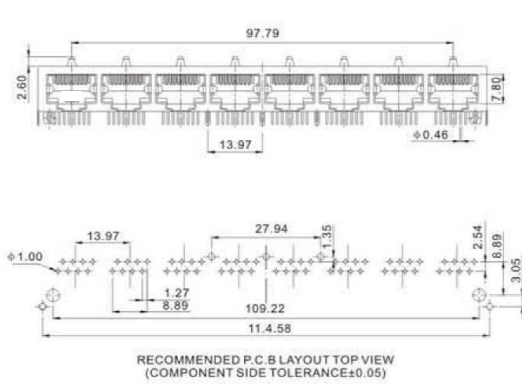

P41032-00G031
5622-S-D-1X8-8C-III

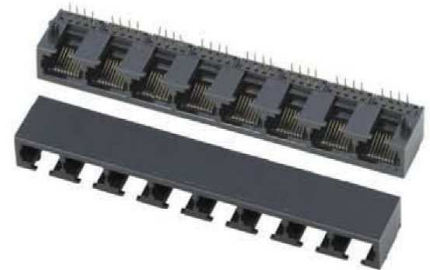
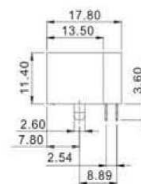
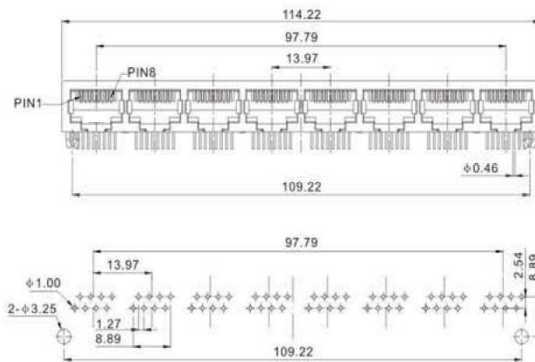

P41034-00GXX1
5622-1X8-8C(4C)

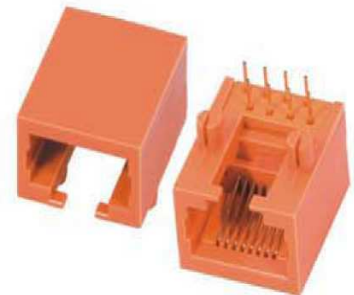
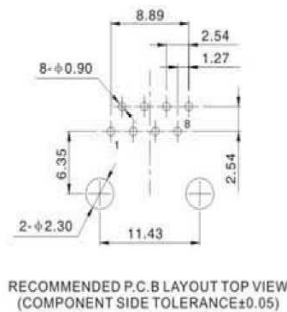
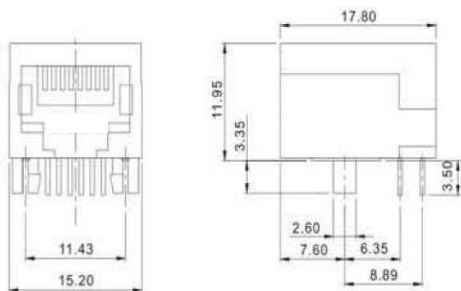

P41011-XXGXX1
5622-8C(4C)

Southern California Office:

15991 Red Hill Avenue, Suite #102,
Tustin, CA 92780 USA
Tel:+1-714-460-0718 Fax:+1-714-460-0728

<http://www.palconnusa.com>

Northern California Office:

500 Yosemite Drive,
Milpitas, CA 95035 USA
Tel:+1-408-855-8866 Fax:+1-408-855-8868

5622 SERIES

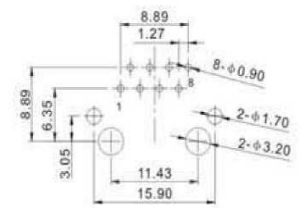
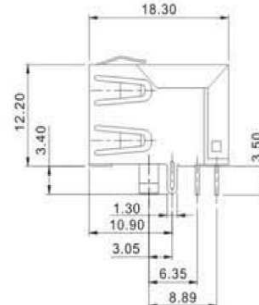
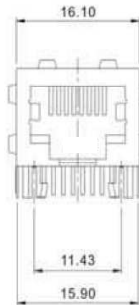

RECOMMENDED P.C.B LAYOUT TOP VIEW
(COMPONENT SIDE TOLERANCE±0.05)

P41014-00GXX1
5622-S-K6-C-8C(4C)

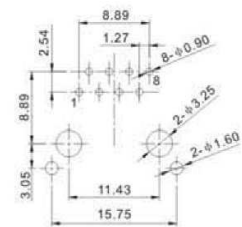
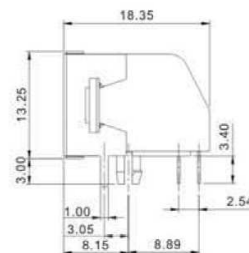
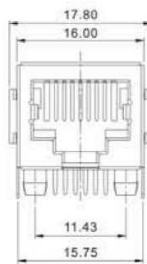

RECOMMENDED P.C.B LAYOUT TOP VIEW
(COMPONENT SIDE TOLERANCE±0.05)

P41005-XXSXX1
5622-Q-T-D-R-W-8C(6C)

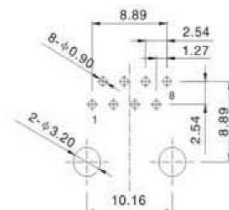
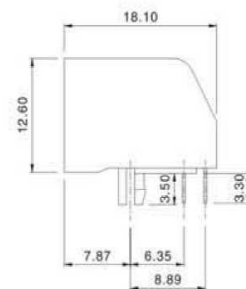
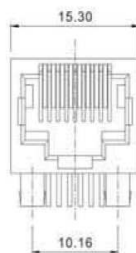

RECOMMENDED P.C.B LAYOUT TOP VIEW
(COMPONENT SIDE TOLERANCE±0.05)

P41008-XXSXX1
5622-Q-W-8P8C(6C)

Southern California Office:

15991 Red Hill Avenue, Suite #102,
Tustin, CA 92780 USA
Tel:+1-714-460-0718 Fax:+1-714-460-0728

<http://www.palconnusa.com>

Northern California Office:

500 Yosemite Drive,
Milpitas, CA 95035 USA
Tel:+1-408-855-8866 Fax:+1-408-855-8868

5622/5623 SERIES

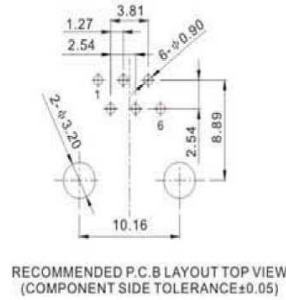
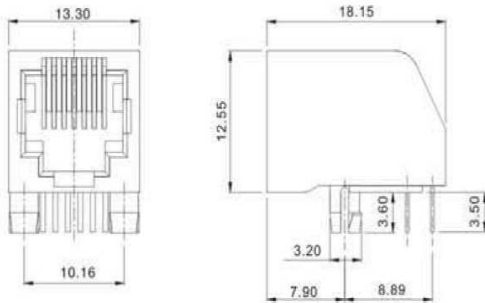

P11018-XXSXX1
5622-Q-W-6P6C(4C)

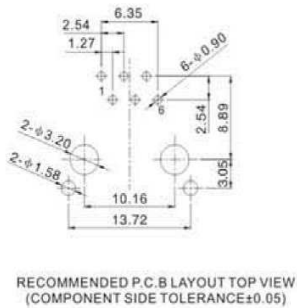
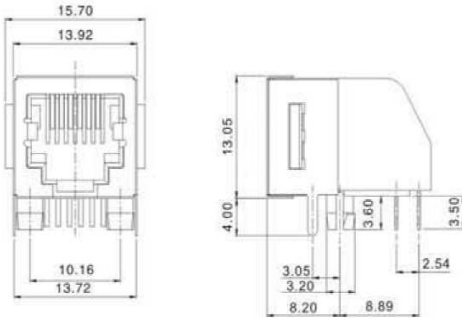

P11021-XXSXX1
5622-Q-T-D-R-W-6P6C(4C)

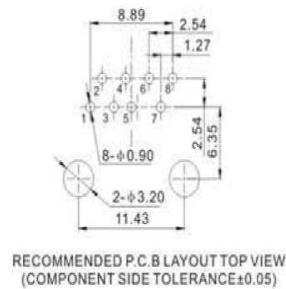
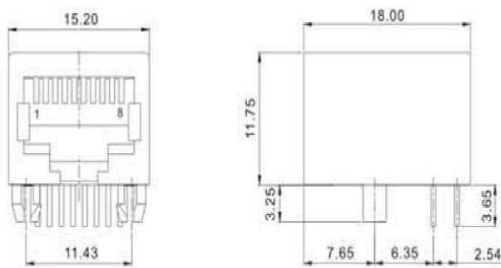

P41300-XXGXX1
5623-8C(4C)

Southern California Office:

15991 Red Hill Avenue, Suite #102,
Tustin, CA 92780 USA
Tel:+1-714-460-0718 Fax:+1-714-460-0728

<http://www.palconnusa.com>

Northern California Office:

500 Yosemite Drive,
Milpitas, CA 95035 USA
Tel:+1-408-855-8866 Fax:+1-408-855-8868

5624/5631 SERIES

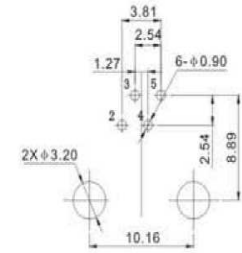
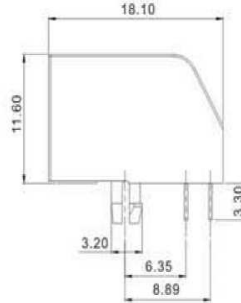
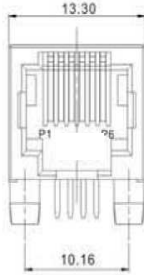

RECOMMENDED P.C.B LAYOUT TOP VIEW
(COMPONENT SIDE TOLERANCE±0.05)

P11120-00XXX1
5624-Q-W-6P4C

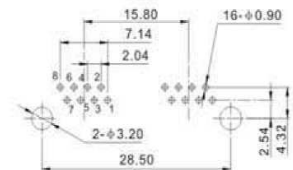
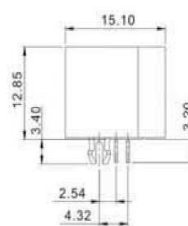
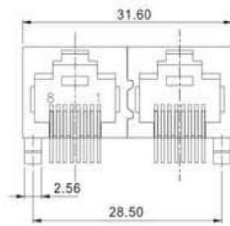

RECOMMENDED P.C.B LAYOUT TOP VIEW
(COMPONENT SIDE TOLERANCE±0.05)

P41250-XXGXX1
5631-1X2-8C-1C

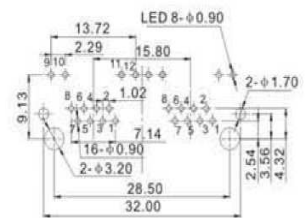
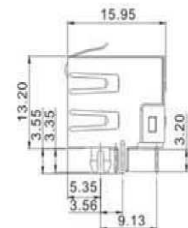
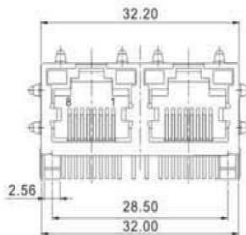

RECOMMENDED P.C.B LAYOUT TOP VIEW
(COMPONENT SIDE TOLERANCE±0.05)

P42042-XXGXX1
5631-S-K8-F-1X2-L-8C

Southern California Office:

15991 Red Hill Avenue, Suite #102,
Tustin, CA 92780 USA
Tel:+1-714-460-0718 Fax:+1-714-460-0728

<http://www.palconnusa.com>

Northern California Office:

500 Yosemite Drive,
Milpitas, CA 95035 USA
Tel:+1-408-855-8866 Fax:+1-408-855-8868

5631 SERIES

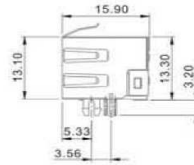
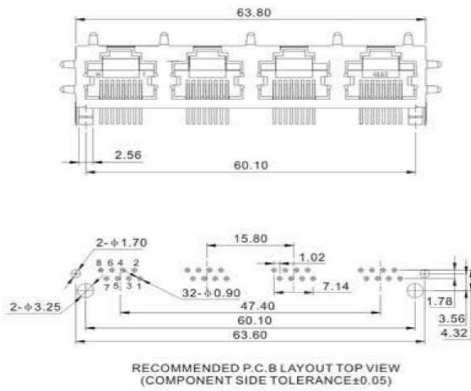

P41272-00GXX1
5631-S-K9-F-1X4-8C

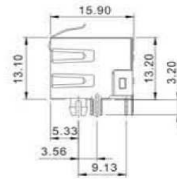
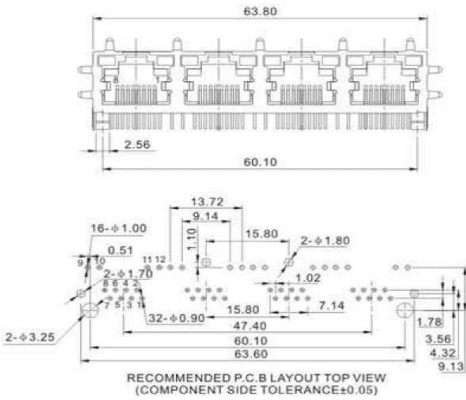

P42060-XXGXX1
5631-S-K9-F-1X4-L-8C-II

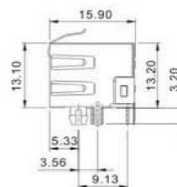
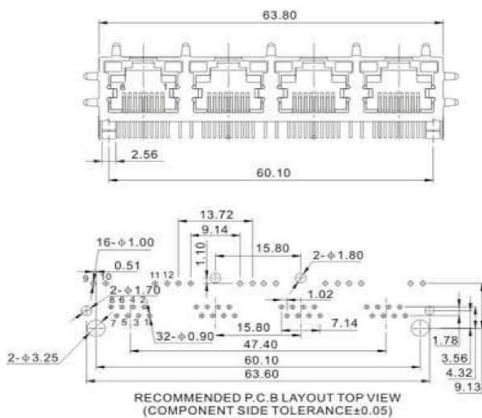

P42066-XXXXX1
5631-Q-S-K9-F-1X4-L-8C-II

Southern California Office:

15991 Red Hill Avenue, Suite #102,
Tustin, CA 92780 USA
Tel:+1-714-460-0718 Fax:+1-714-460-0728

<http://www.palconnusa.com>

Northern California Office:

500 Yosemite Drive,
Milpitas, CA 95035 USA
Tel:+1-408-855-8866 Fax:+1-408-855-8868

5631 SERIES

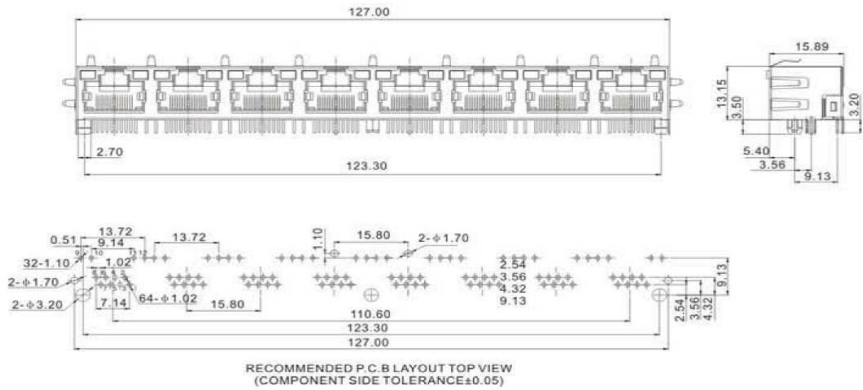

P42008-XXXXX1
5631-Q-S-K13-F-1X8-L-8C-II-G

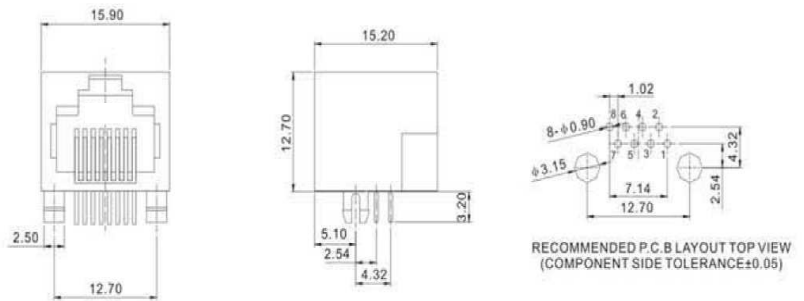
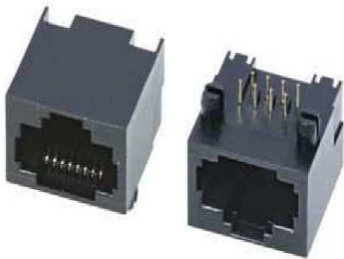

P41220-XXGXX1
5631-8C(4C)

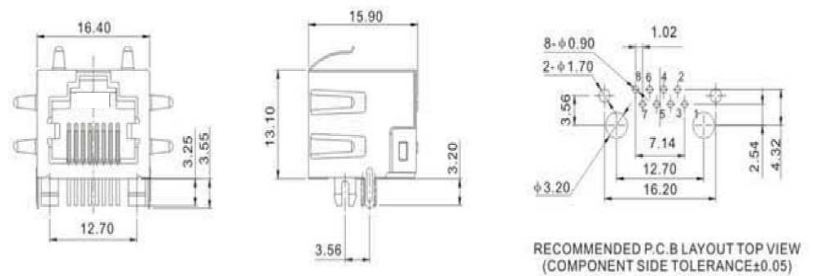

P41223-XXGXX1
5631-S-K6-F-8C(4C)

Southern California Office:

15991 Red Hill Avenue, Suite #102,
Tustin, CA 92780 USA
Tel:+1-714-460-0718 Fax:+1-714-460-0728

<http://www.palconnusa.com>

Northern California Office:

500 Yosemite Drive,
Milpitas, CA 95035 USA
Tel:+1-408-855-8866 Fax:+1-408-855-8868

5631 SERIES

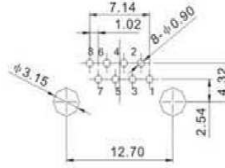
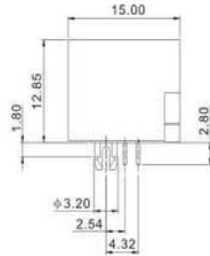
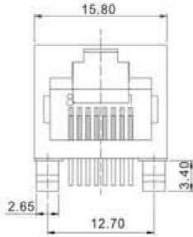

RECOMMENDED P.C.B LAYOUT TOP VIEW
(COMPONENT SIDE TOLERANCE±0.05)



P41225-00XXX1
5631-Q-8C

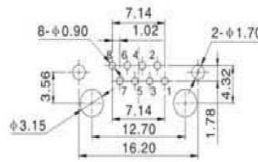
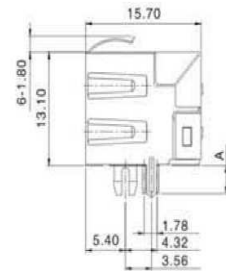
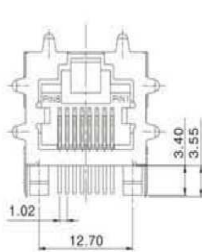

RECOMMENDED P.C.B LAYOUT TOP VIEW
(COMPONENT SIDE TOLERANCE±0.05)



P41227-XXXXX1
5631-Q-S-K6-F-8C

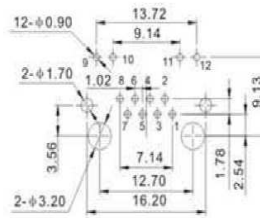
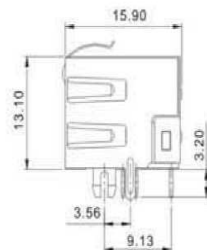
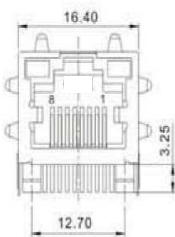

RECOMMENDED P.C.B LAYOUT TOP VIEW
(COMPONENT SIDE TOLERANCE±0.05)



P42022-XXGXX1
5631-S-K6-F-L-8C

Southern California Office:

15991 Red Hill Avenue, Suite #102,
Tustin, CA 92780 USA
Tel:+1-714-460-0718 Fax:+1-714-460-0728

<http://www.palconnusa.com>

Northern California Office:

500 Yosemite Drive,
Milpitas, CA 95035 USA
Tel:+1-408-855-8866 Fax:+1-408-855-8868

5631/5632/5918 SERIES

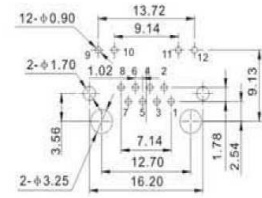
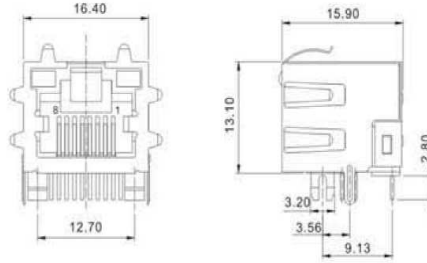

RECOMMENDED P.C.B LAYOUT TOP VIEW
(COMPONENT SIDE TOLERANCE±0.05)

P42002-XXXXX1
5631-Q-S-K6-F-L-8C

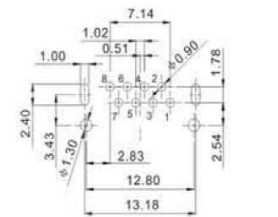
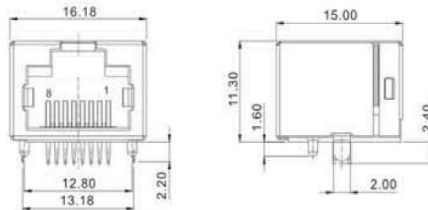

RECOMMENDED P.C.B LAYOUT TOP VIEW
(COMPONENT SIDE TOLERANCE±0.05)

P41921-00XXX1
5632-Q-S-8P8C

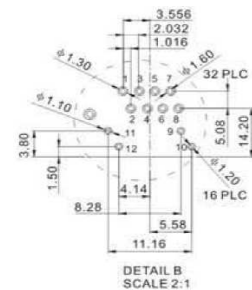
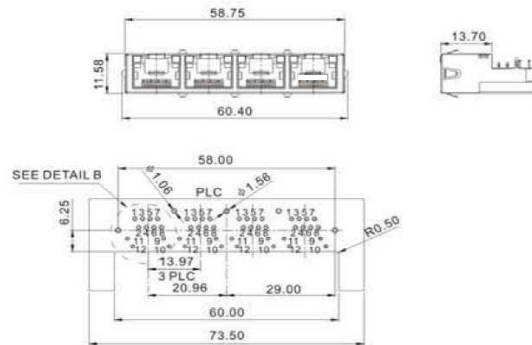

RECOMMENDED P.C.B LAYOUT TOP VIEW
(COMPONENT SIDE TOLERANCE±0.05)

P42001-0001
5918-Q-S-K8-1X4-8P8C

Southern California Office:

15991 Red Hill Avenue, Suite #102,
Tustin, CA 92780 USA
Tel:+1-714-460-0718 Fax:+1-714-460-0728

<http://www.palconnusa.com>

Northern California Office:

500 Yosemite Drive,
Milpitas, CA 95035 USA
Tel:+1-408-855-8866 Fax:+1-408-855-8868

5921 SERIES

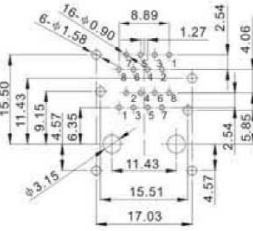
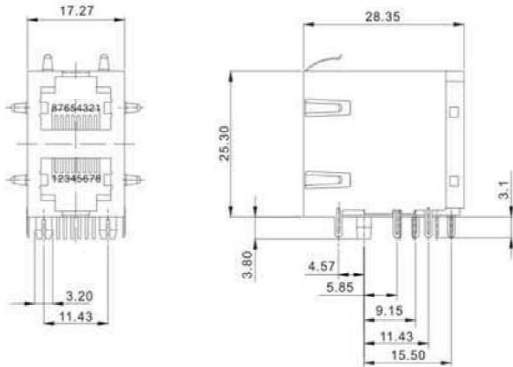

RECOMMENDED P.C.B LAYOUT TOP VIEW
(COMPONENT SIDE TOLERANCE±0.05)



P43001-XXGXX1
5921-S-K6-A-2X1-8C(4C)

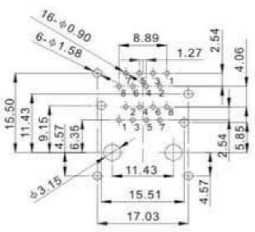
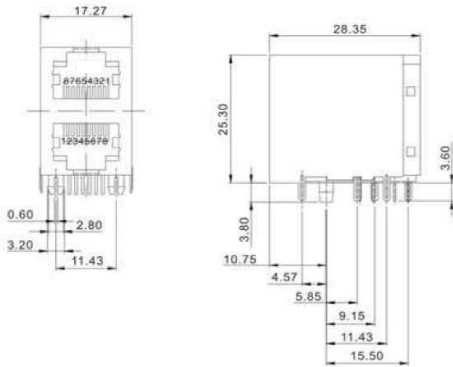

RECOMMENDED P.C.B LAYOUT TOP VIEW
(COMPONENT SIDE TOLERANCE±0.05)



P43003-00XXX1
5921-Q-S-A-2X1-8C

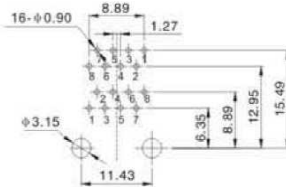
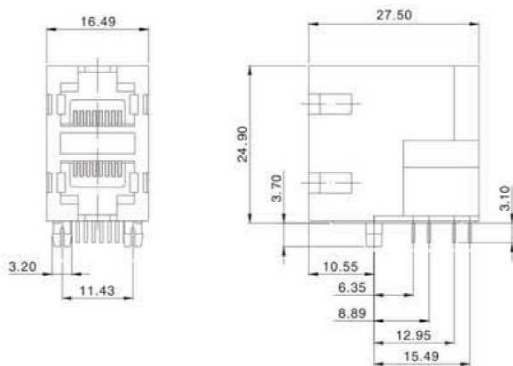

RECOMMENDED P.C.B LAYOUT TOP VIEW
(COMPONENT SIDE TOLERANCE±0.05)



P43005-00GXX1
5921-2X1-8C

Southern California Office:

15991 Red Hill Avenue, Suite #102,
Tustin, CA 92780 USA
Tel:+1-714-460-0718 Fax:+1-714-460-0728

<http://www.palconnusa.com>

Northern California Office:

500 Yosemite Drive,
Milpitas, CA 95035 USA
Tel:+1-408-855-8866 Fax:+1-408-855-8868

5921 SERIES

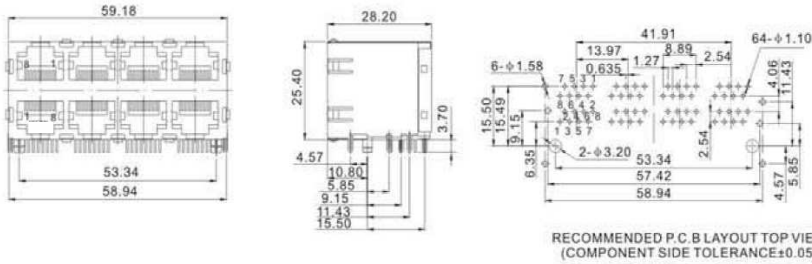

P43019-XXXXX1
5921-Q-S-FK10-A-2X4-8C

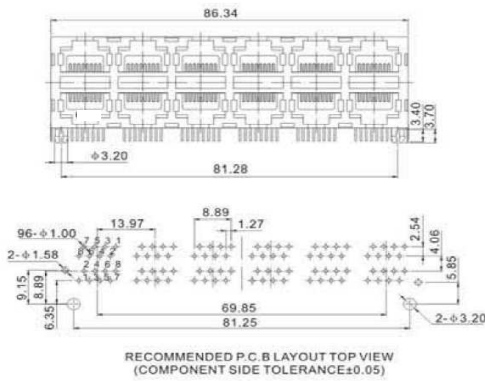

P43040-00GXX1
5921-P-2X6-8C

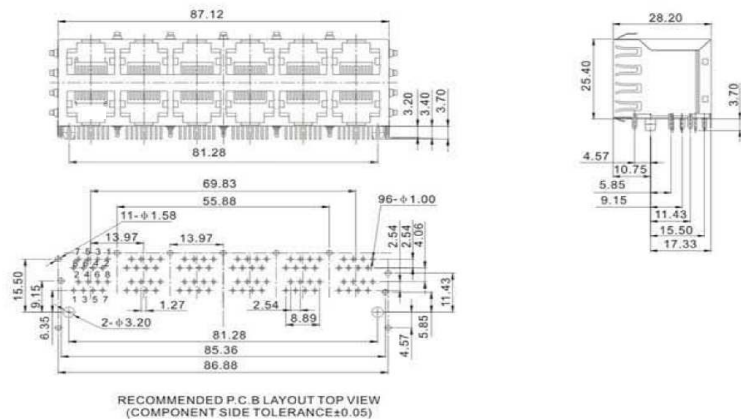

P43046-00XXX1
5921-Q-S-K18-A-2X6-8C-V

Southern California Office:

15991 Red Hill Avenue, Suite #102,
Tustin, CA 92780 USA
Tel:+1-714-460-0718 Fax:+1-714-460-0728

<http://www.palconnusa.com>

Northern California Office:

500 Yosemite Drive,
Milpitas, CA 95035 USA
Tel:+1-408-855-8866 Fax:+1-408-855-8868

5921 SERIES

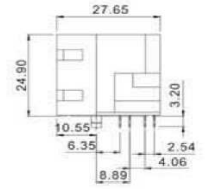
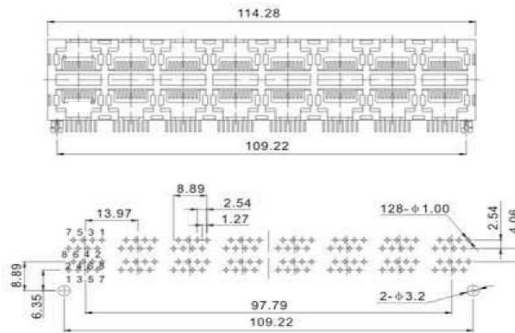

RECOMMENDED P.C.B LAYOUT TOP VIEW
(COMPONENT SIDE TOLERANCE±0.05)

P43060-XXGXX1
5921-2X8-8C-1A

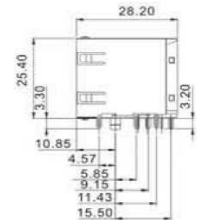
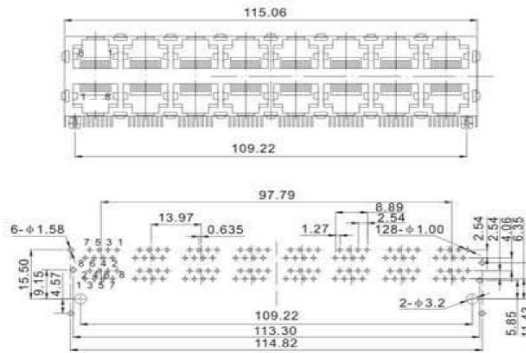

RECOMMENDED P.C.B LAYOUT TOP VIEW
(COMPONENT SIDE TOLERANCE±0.05)

P43062-XXGXX1
5921-S-FK18-A-2X8-8C

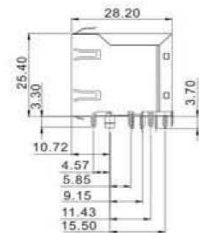
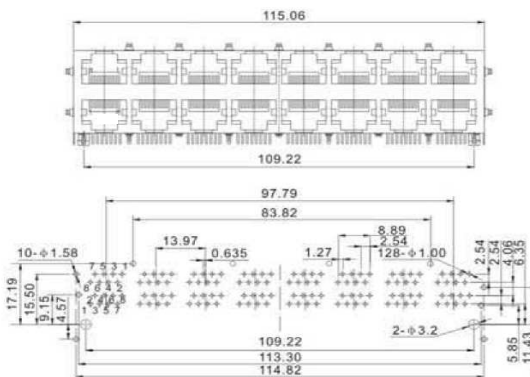

RECOMMENDED P.C.B LAYOUT TOP VIEW
(COMPONENT SIDE TOLERANCE±0.05)

P43065-00XXX1
5921-Q-S-K18-A-2X8-8C-IV

Southern California Office:

15991 Red Hill Avenue, Suite #102,
Tustin, CA 92780 USA
Tel:+1-714-460-0718 Fax:+1-714-460-0728

<http://www.palconnusa.com>

Northern California Office:

500 Yosemite Drive,
Milpitas, CA 95035 USA
Tel:+1-408-855-8866 Fax:+1-408-855-8868

5921 SERIES

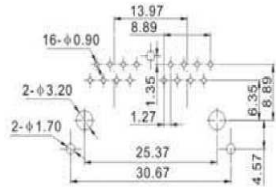
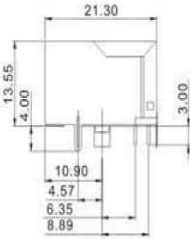
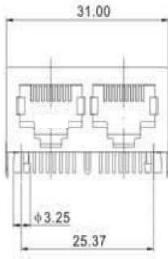

RECOMMENDED P.C.B LAYOUT TOP VIEW
(COMPONENT SIDE TOLERANCE±0.05)



P41067-XXGXX1
5921-S-A-1X2-8C-1

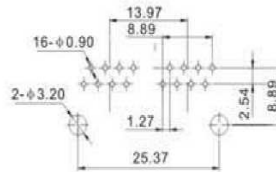
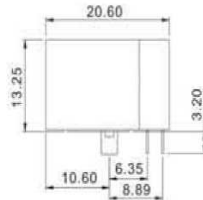
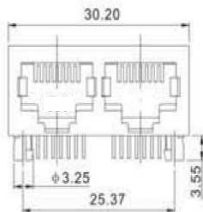

RECOMMENDED P.C.B LAYOUT TOP VIEW
(COMPONENT SIDE TOLERANCE±0.05)



P41089-00XXX1
5921-Q-1X2-8C

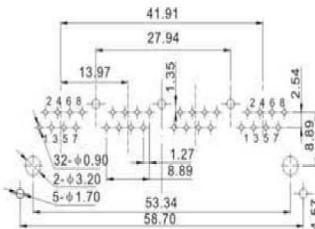
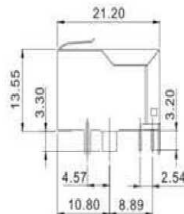
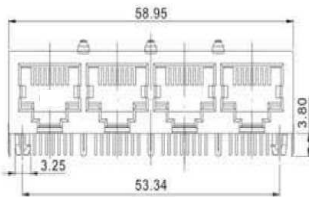

RECOMMENDED P.C.B LAYOUT TOP VIEW
(COMPONENT SIDE TOLERANCE±0.05)



P41072-XXGXX1
5921-S-BK3-A-1X4-8C(4C)-III

Southern California Office:

15991 Red Hill Avenue, Suite #102,
Tustin, CA 92780 USA
Tel:+1-714-460-0718 Fax:+1-714-460-0728

<http://www.palconnusa.com>

Northern California Office:

500 Yosemite Drive,
Milpitas, CA 95035 USA
Tel:+1-408-855-8866 Fax:+1-408-855-8868

5921 SERIES

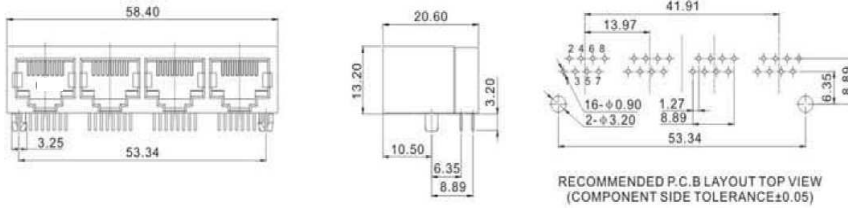

P41127-00GXX1
5921-1X4-8C(4C)-2A

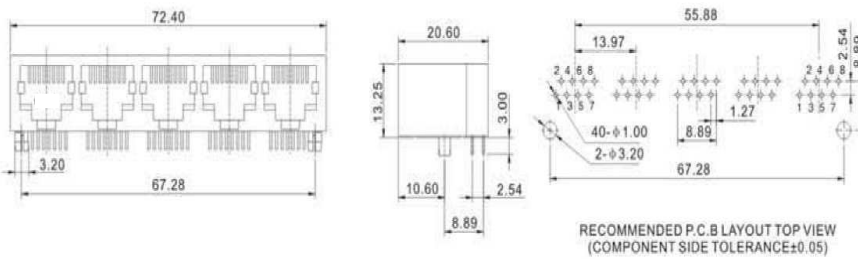

P41082-XXGXX1
5921-1X5-8C(4C)

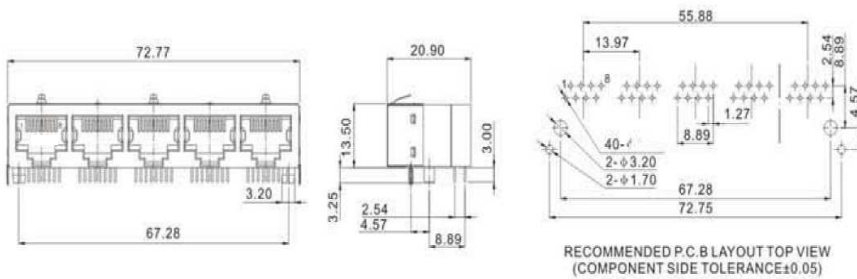

P41088-00GXX1
5921-T-BK3-A-1X5-8C(4C)

Southern California Office:

15991 Red Hill Avenue, Suite #102,
Tustin, CA 92780 USA
Tel:+1-714-460-0718 Fax:+1-714-460-0728

<http://www.palconnusa.com>

Northern California Office:

500 Yosemite Drive,
Milpitas, CA 95035 USA
Tel:+1-408-855-8866 Fax:+1-408-855-8868

5921 SERIES

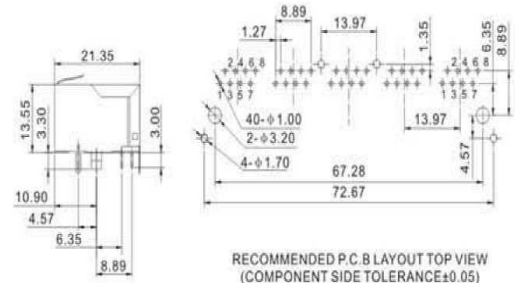
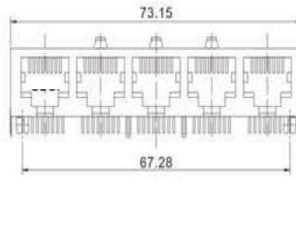
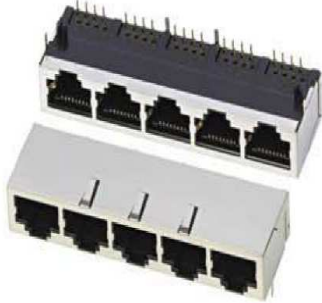

P41402-00GXX1
5921-S-BK3-A-1X5-8C(4C)-II

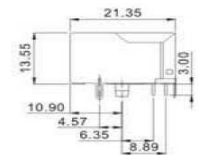
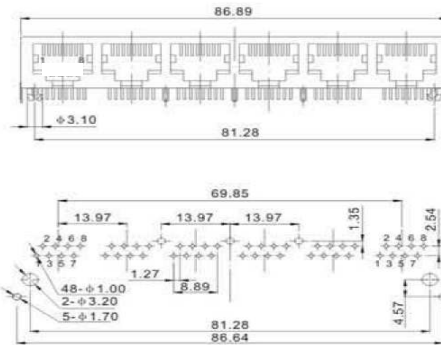
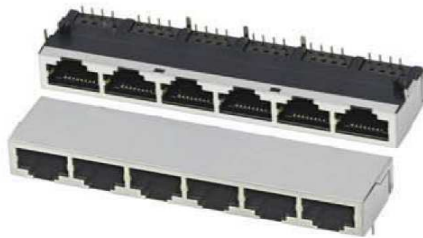

RECOMMENDED P.C.B LAYOUT TOP VIEW
(COMPONENT SIDE TOLERANCE±0.05)

P41132-XXGXX1
5921-S-A-1X6-8C(4C)-III

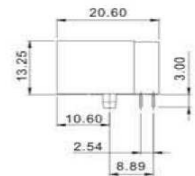
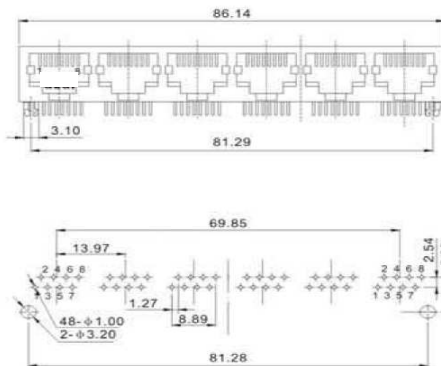
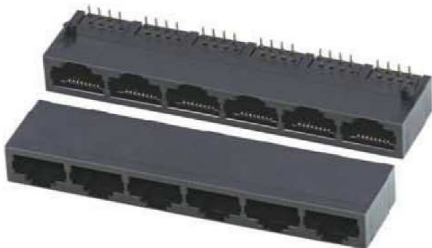

RECOMMENDED P.C.B LAYOUT TOP VIEW
(COMPONENT SIDE TOLERANCE±0.05)

P4113-00GXX1
5921-1X6-8C(4C)

Southern California Office:

15991 Red Hill Avenue, Suite #102,
Tustin, CA 92780 USA
Tel:+1-714-460-0718 Fax:+1-714-460-0728

<http://www.palconnusa.com>

Northern California Office:

500 Yosemite Drive,
Milpitas, CA 95035 USA
Tel:+1-408-855-8866 Fax:+1-408-855-8868

5921 SERIES

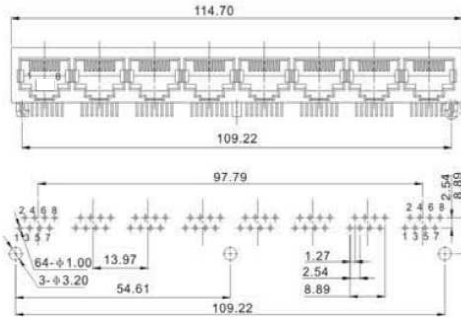

RECOMMENDED P.C.B LAYOUT TOP VIEW
(COMPONENT SIDE TOLERANCE±0.05)

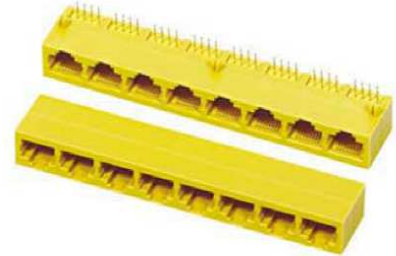
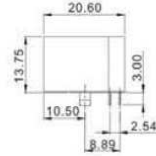

P41095-XXGXX1
5921-1X8-C-8C(4C)

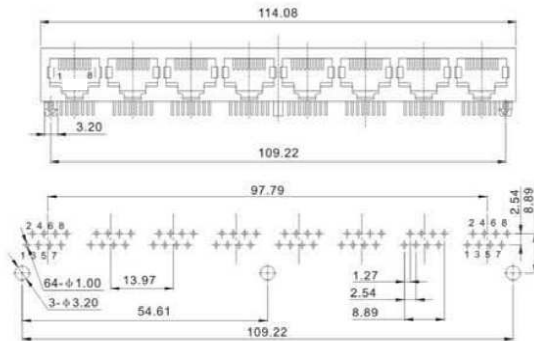

RECOMMENDED P.C.B LAYOUT TOP VIEW
(COMPONENT SIDE TOLERANCE±0.05)

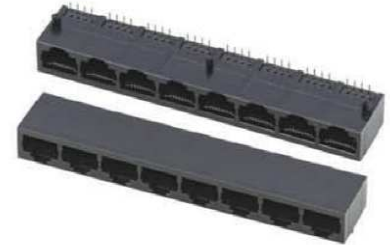
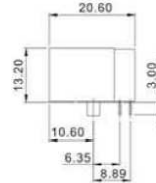

P41097-XXGXX1
5921-1X8-8C-(4C)

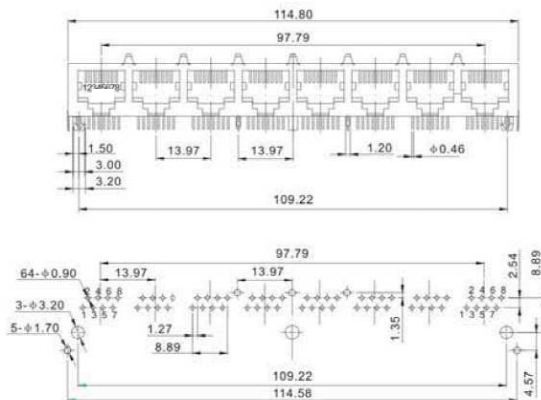

RECOMMENDED P.C.B LAYOUT TOP VIEW
(COMPONENT SIDE TOLERANCE±0.05)

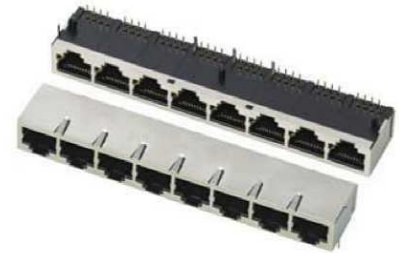
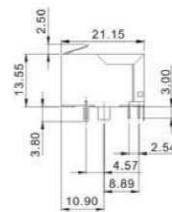

P41102-XXGXX1
5921-S-BK7-A-1X8-8C-III

Southern California Office:

15991 Red Hill Avenue, Suite #102,
Tustin, CA 92780 USA
Tel:+1-714-460-0718 Fax:+1-714-460-0728

<http://www.palconnusa.com>

Northern California Office:

500 Yosemite Drive,
Milpitas, CA 95035 USA
Tel:+1-408-855-8866 Fax:+1-408-855-8868

5921 SERIES

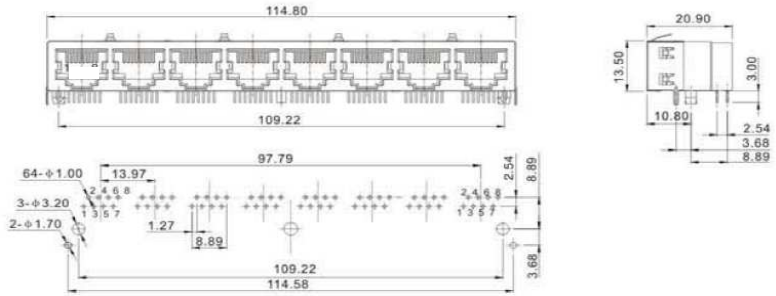
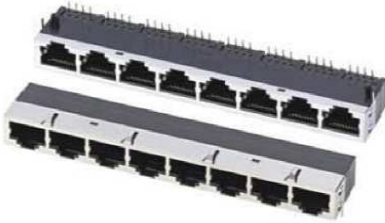

RECOMMENDED P.C.B LAYOUT TOP VIEW
(COMPONENT SIDE TOLERANCE±0.05)

P41105-XXGXX1
5921-T-BK4-B-1X8-8C(4C)

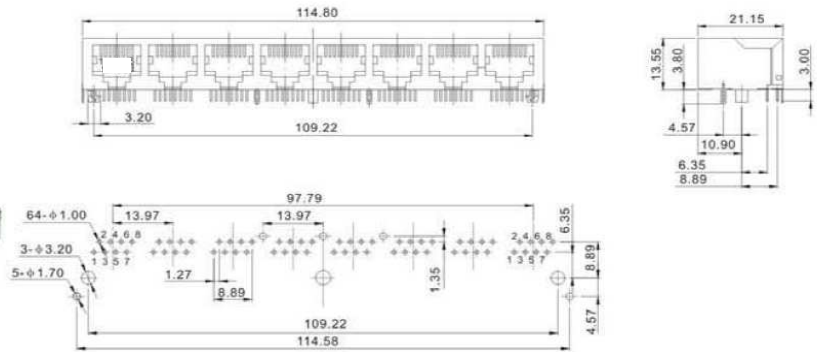
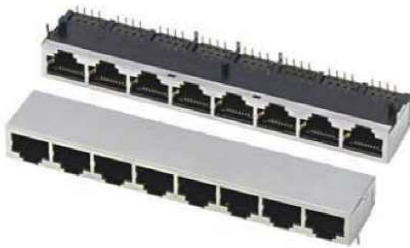

RECOMMENDED P.C.B LAYOUT TOP VIEW
(COMPONENT SIDE TOLERANCE±0.05)

P41111-00SXX1
5921-Q-S-A-1X8-8C-III

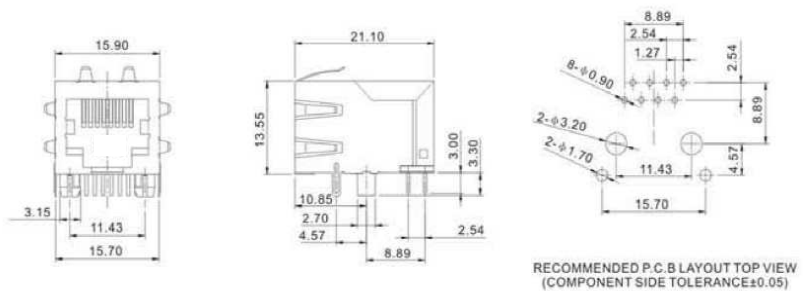

RECOMMENDED P.C.B LAYOUT TOP VIEW
(COMPONENT SIDE TOLERANCE±0.05)

P41108-XXGXX1
5921-S-K6-A-8C(4C)-G

Southern California Office:

15991 Red Hill Avenue, Suite #102,
Tustin, CA 92780 USA
Tel:+1-714-460-0718 Fax:+1-714-460-0728

<http://www.palconnusa.com>

Northern California Office:

500 Yosemite Drive,
Milpitas, CA 95035 USA
Tel:+1-408-855-8866 Fax:+1-408-855-8868

5921 SERIES

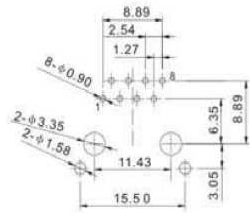
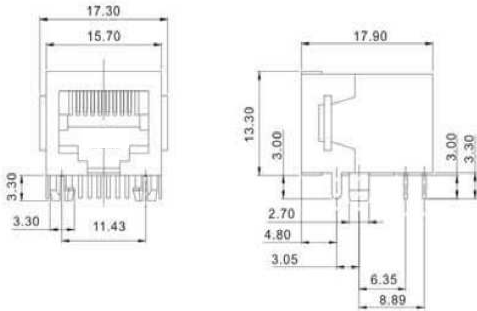

RECOMMENDED P.C.B LAYOUT TOP VIEW
(COMPONENT SIDE TOLERANCE±0.05)



P41052-XXGXX1
5921-T-D-R-10P8C(4C)-1C

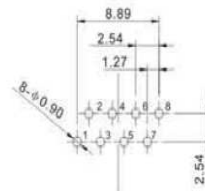
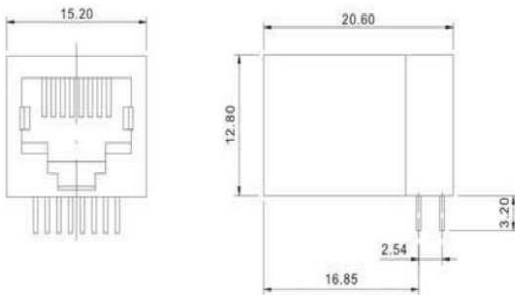

RECOMMENDED P.C.B LAYOUT TOP VIEW
(COMPONENT SIDE TOLERANCE±0.05)



P41054-XXGXX1
5921-8P8C(4C)

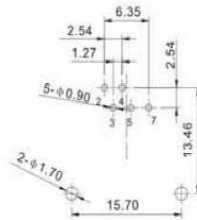
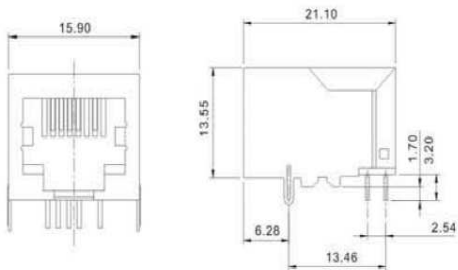

RECOMMENDED P.C.B LAYOUT TOP VIEW
(COMPONENT SIDE TOLERANCE±0.05)



P41056-XXGXX1
5921-S-A-8P5C-2A

Southern California Office:

15991 Red Hill Avenue, Suite #102,
Tustin, CA 92780 USA
Tel:+1-714-460-0718 Fax:+1-714-460-0728

<http://www.palconnusa.com>

Northern California Office:

500 Yosemite Drive,
Milpitas, CA 95035 USA
Tel:+1-408-855-8866 Fax:+1-408-855-8868

5921/5922 SERIES

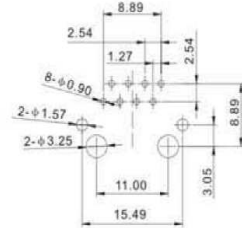
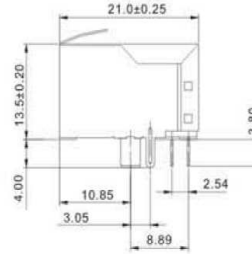
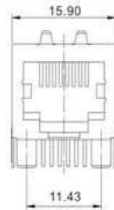

RECOMMENDED P.C.B LAYOUT TOP VIEW
(COMPONENT SIDE TOLERANCE±0.05)

P41060-00XXX1
5921-Q-S-BK2-C-8P8C-1C

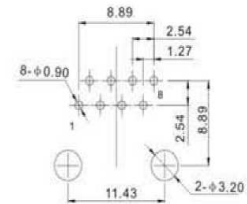
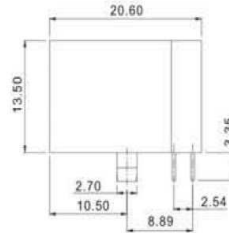
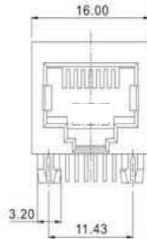

RECOMMENDED P.C.B LAYOUT TOP VIEW
(COMPONENT SIDE TOLERANCE±0.05)

P41094-00GXX1
5921-C-8P8C-1B

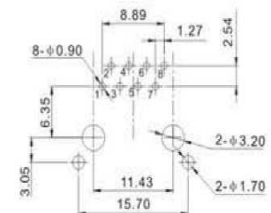
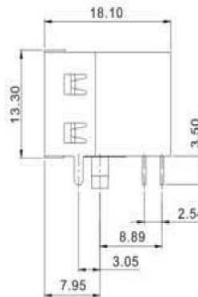
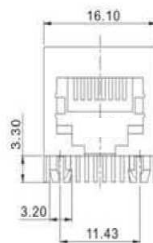

RECOMMENDED P.C.B LAYOUT TOP VIEW
(COMPONENT SIDE TOLERANCE±0.05)

P41370-XXGXX1
5922-T-A-8C

Southern California Office:

15991 Red Hill Avenue, Suite #102,
Tustin, CA 92780 USA
Tel:+1-714-460-0718 Fax:+1-714-460-0728

<http://www.palconnusa.com>

Northern California Office:

500 Yosemite Drive,
Milpitas, CA 95035 USA
Tel:+1-408-855-8866 Fax:+1-408-855-8868

5931 SERIES

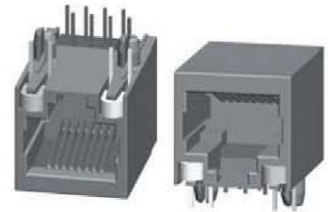
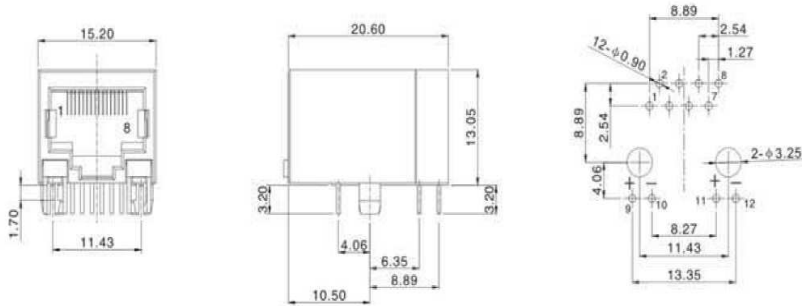

P42102-00XXX1
5931-Q-L-8C

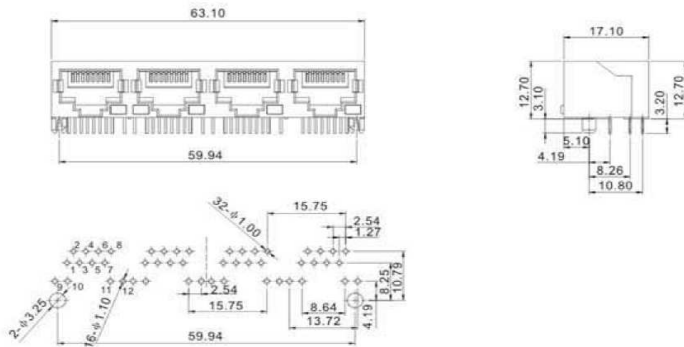

RECOMMENDED P.C.B LAYOUT TOP VIEW
(COMPONENT SIDE TOLERANCE±0.05)



P42100-XXXXX1
5931-Q-1X4-L-8C

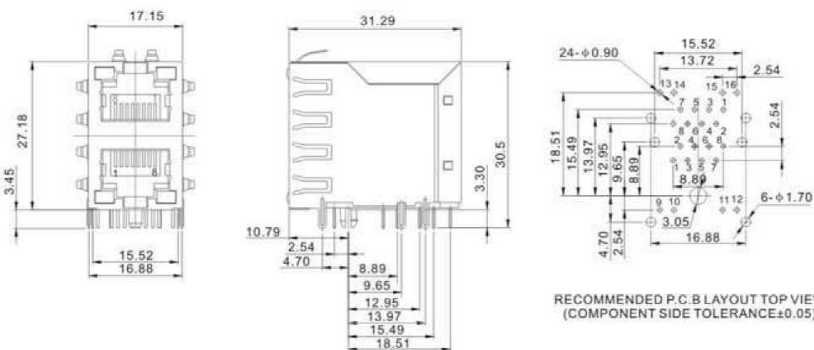

RECOMMENDED P.C.B LAYOUT TOP VIEW
(COMPONENT SIDE TOLERANCE±0.05)



P45003-XXXXX1
5931-Q-S-K10-2X1-L-C-8C(JK4)

Southern California Office:

15991 Red Hill Avenue, Suite #102,
Tustin, CA 92780 USA
Tel:+1-714-460-0718 Fax:+1-714-460-0728

<http://www.palconnusa.com>

Northern California Office:

500 Yosemite Drive,
Milpitas, CA 95035 USA
Tel:+1-408-855-8866 Fax:+1-408-855-8868

5931 SERIES

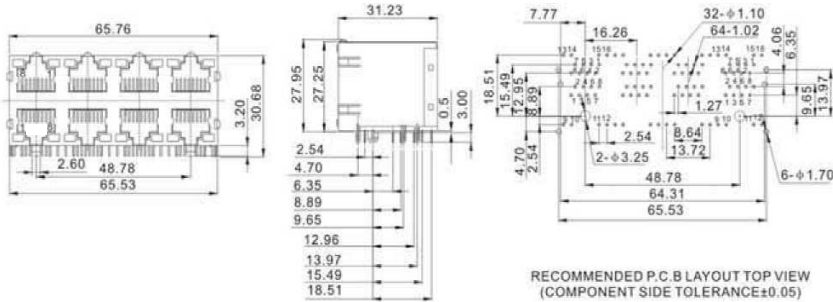

P45021-XXXXX1
5931-Q-S-FK8-2X4-L-c-8C(GY)

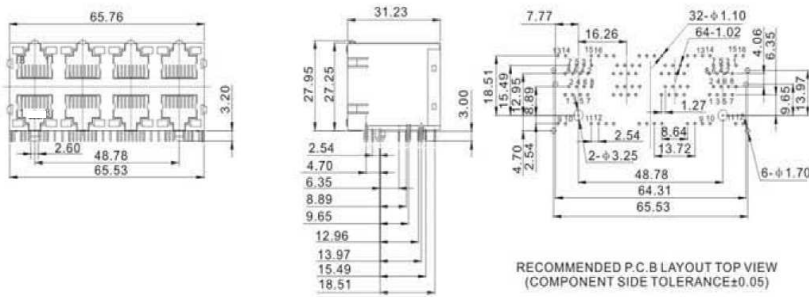

P45031-XXGXX1
5931-S-K9-2X4-L-a-8C

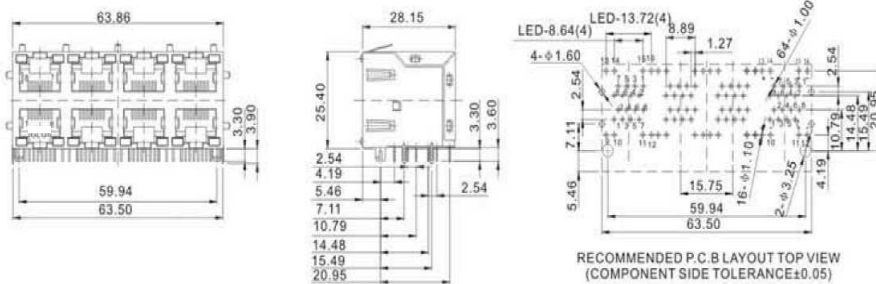

P45032-XXXXX1
5931-Q-S-K9-2X4-L-a-8C-G

Southern California Office:

15991 Red Hill Avenue, Suite #102,
Tustin, CA 92780 USA
Tel:+1-714-460-0718 Fax:+1-714-460-0728

<http://www.palconnusa.com>

Northern California Office:

500 Yosemite Drive,
Milpitas, CA 95035 USA
Tel:+1-408-855-8866 Fax:+1-408-855-8868

5931/6221 SERIES

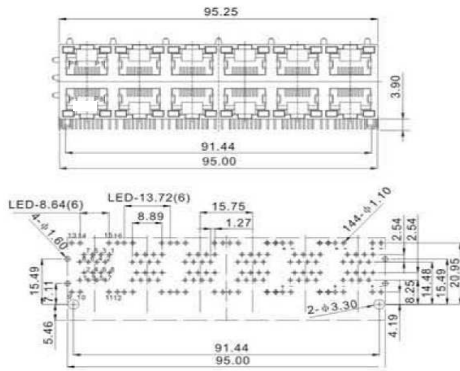

RECOMMENDED P.C.B LAYOUT TOP VIEW
(COMPONENT SIDE TOLERANCE±0.05)

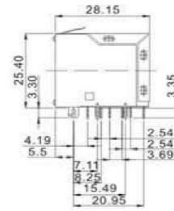

P45046-00XXX1
5931-Q-S-BK10-2X6-L-a-8C

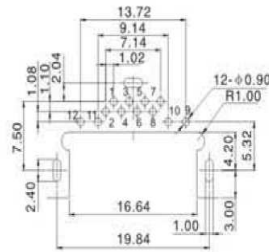
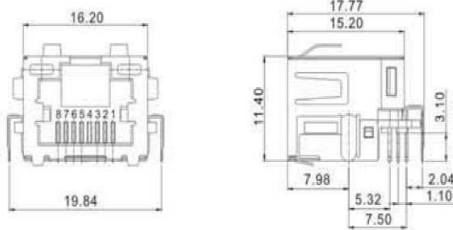

RECOMMENDED P.C.B LAYOUT TOP VIEW
(COMPONENT SIDE TOLERANCE±0.05)



P42000-XXXXX1
6221-Q-S-K6-L-8C(OG/G)

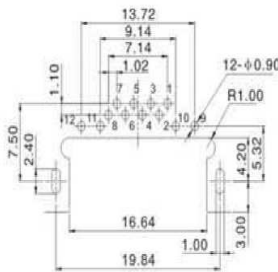
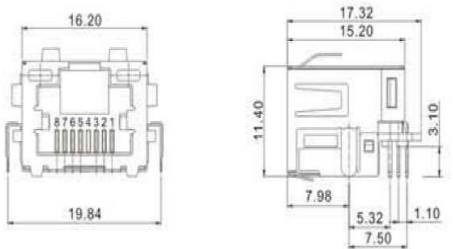

RECOMMENDED P.C.B LAYOUT TOP VIEW
(COMPONENT SIDE TOLERANCE±0.05)



P42003-XXXXX1
6221-Q-S-K6-L-8C(G/Y)

Southern California Office:

15991 Red Hill Avenue, Suite #102,
Tustin, CA 92780 USA
Tel:+1-714-460-0718 Fax:+1-714-460-0728

<http://www.palconnusa.com>

Northern California Office:

500 Yosemite Drive,
Milpitas, CA 95035 USA
Tel:+1-408-855-8866 Fax:+1-408-855-8868

6221/6J31/616PCB SERIES

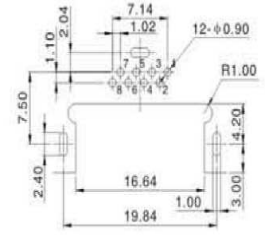
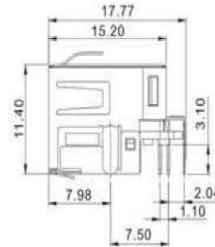
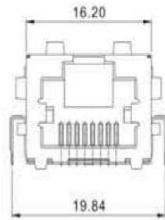

RECOMMENDED P.C.B LAYOUT TOP VIEW
(COMPONENT SIDE TOLERANCE±0.05)

P41931-00XXX1
6221-Q-S-K6-8C-1

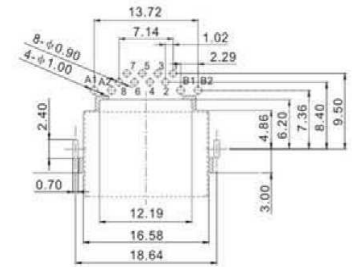
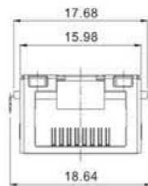

RECOMMENDED P.C.B LAYOUT TOP VIEW
(COMPONENT SIDE TOLERANCE±0.05)

P41911-00S092
6J31-Q-S-L-8P8C

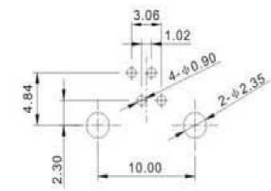
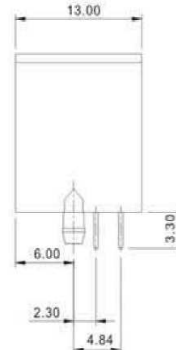
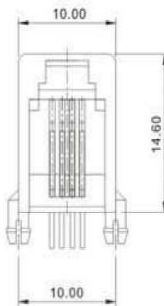

RECOMMENDED P.C.B LAYOUT TOP VIEW
(COMPONENT SIDE TOLERANCE±0.05)

P11061-XXGXX1
616PCB-4P4C(2C)

Southern California Office:

15991 Red Hill Avenue, Suite #102,
Tustin, CA 92780 USA
Tel:+1-714-460-0718 Fax:+1-714-460-0728

<http://www.palconnusa.com>

Northern California Office:

500 Yosemite Drive,
Milpitas, CA 95035 USA
Tel:+1-408-855-8866 Fax:+1-408-855-8868



For more information regarding samples please visit www.palpilot.com