



Device circuit breakers

Selective power distribution:
branch out, individual adaptation,
modular extension

Interference-free mains supply and signal transmission

A constant energy supply and secure data links are especially important for the operational reliability of electrical systems, installations, and devices.

Phoenix Contact meets all of these requirements with the TRABTECH product line. Coordinated solutions consisting of surge protection, monitoring, device circuit breakers and EMC products offer consistently high power and signal quality for maximum availability.



Device circuit breakers as a modularly expandable system or electronic multi-channel variant with comprehensive functions.

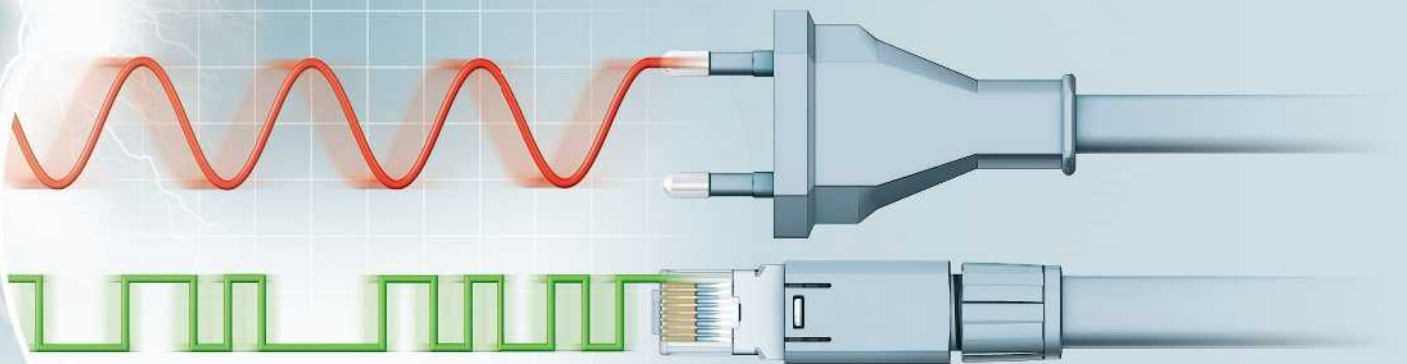

Selective fuse protection for circuits



Reliable protection in the event of harmful overload and short-circuit currents

System failures can be caused by various factors. A permanent overload, for example, can damage the load and lead to the downtime of the system or a system part.

Provide selective fuse protection for the control circuits in your systems in order to increase system availability.

In practice, around 90% of all systems are operated with 24 V DC control voltages.

Typical nominal currents of electrical loads

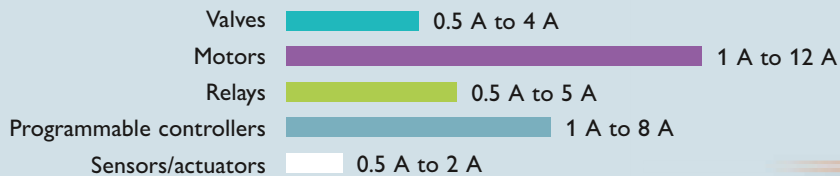

The different nominal currents of the various loads illustrate the usefulness of selective protection for the individual circuits. And you will find the perfect device circuit breaker for almost any nominal current.

Table of contents

High-quality device circuit breakers provide safety for your systems
Page 4/5

CBM multi-channel electronic device circuit breakers
Page 6/7

Electronic device circuit breakers
Page 8/9

Thermomagnetic device circuit breakers
Page 10/11

Thermal device circuit breakers
Page 12/13

Device circuit breaker board
Page 14/15

Product overview
Page 16–21

Device circuit breakers and QUINT POWER
Page 22/23

QUINT POWER
Page 24/25

TRIO POWER and CBM
Page 26/27

High-quality device circuit breakers provide security for your systems

Device circuit breakers are a key factor in high system availability. In the event of overload and short circuit, they selectively shut down the faulty circuit. All other system parts remain in operation.

- Thermal circuit breakers
- Thermomagnetic circuit breakers
- Electronic circuit breakers
- Multi-channel, electronic circuit breakers



Versatile use –
Device circuit breakers with various tripping technologies
 We offer the right solution for every application.
 Select the right circuit breaker plus a base element with push-in or screw connection technology.

Shutdown behavior of device circuit breakers

	Tripping time in the case of overload	Tripping time in the event of a short circuit	Your application is optimally protected in the event of
Thermal circuit breakers	■ Suitable	■ Unsuitable	<ul style="list-style-type: none"> • Overload
Thermomagnetic circuit breakers	■ Suitable	■ Ideal	<ul style="list-style-type: none"> • Overload • Short circuit • Long cable paths (SFB tripping characteristic)
Electronic circuit breakers	■ Ideal	■ Ideal	<ul style="list-style-type: none"> • Overload • Short circuit • Long cable paths (active current limitation)



Modular extension

It couldn't be easier. Enhance your system with additional device circuit breakers in no time at all. It is even possible to pre-wire your system on-site with a customized plug selection. The uniform, plug-in housing concept as well as the bridgeability of the base elements simplify installation.

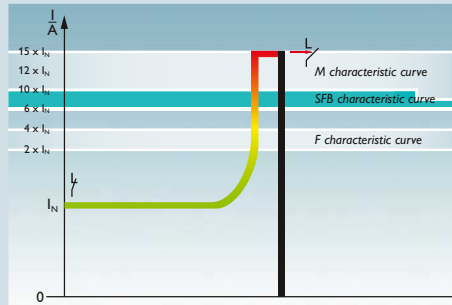

Branch out

Thermomagnetic device circuit breakers with the SFB tripping characteristic* provide maximum overcurrent protection – even in large systems with long cable paths. The characteristic curve:

- Prevents the device from being shut down unnecessarily early in the event of brief current increases during operation, such as starting currents
- Prevents excessively long overload currents that may be linked to hazardous heat buildup in the equipment

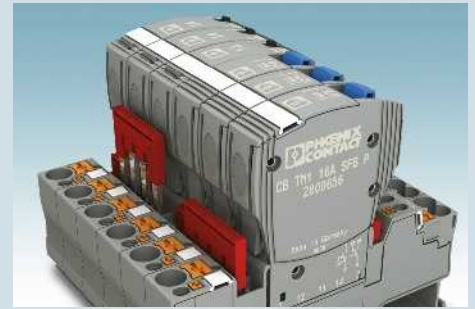

Individual adaptation

With the unique bridge system from the CLIPLINE complete range of accessories, the device circuit breakers can also be combined easily and individually. Potentials of the same type can be connected quickly and safely.

You can extend the power distribution, modify the signal string or bridge the auxiliary voltage for the electronic device circuit breakers without this resulting in significant wiring costs.



Multi-channel protection

The multi-channel electronic device circuit breaker provides protection for four or eight loads, depending on the version. The individual channels can be configured individually and have an electronic locking mechanism to prevent accidental changes. The status of each channel is displayed directly on the device and can also be queried as group remote signaling using the connections provided for this purpose.



Distribute effortlessly

Device circuit breaker boards combine the advantages of CB device circuit breakers with easy and space-saving potential distribution. The switching states of the circuit breakers are monitored and provided as group remote signaling in two groups via connection terminal blocks. Protect up to four loads simultaneously per channel. There is also the connection option for external relay contacts, such as for safety-oriented shutoff.



Selective protection

To trigger device circuit breakers magnetically and therefore quickly, power supplies have to provide a multiple of the nominal current for a short time. This current reserve is available with QUINT POWER with SFB Technology* and up to six times the nominal current for 12 ms.

*SFB = Selective fuse breaking/selective shutdown

CBM multi-channel electronic device circuit breakers

The multi-channel, electronic device circuit breakers are optimally suited for use in machine building, process engineering and control and systems manufacturing.

The voltage remains at a constant level due to the dynamic limiting of the current. Other loads will not be influenced.

The individual adjustability of the 4 and 8-channel devices provides a convenient and space-saving solution for any application.

Your advantages:

- The nominal current assistant facilitates the setting of nominal currents and provides optimal system protection
- Undervoltages and surge voltages will be identified, loads will be switched off reliably
- The electronic locking mechanism prevents accidental changes to the current values
- Fine nominal current graduations from 0.5 to 10 A in just one device
- Dynamic current limiting for a better utilization of the upstream power supply unit

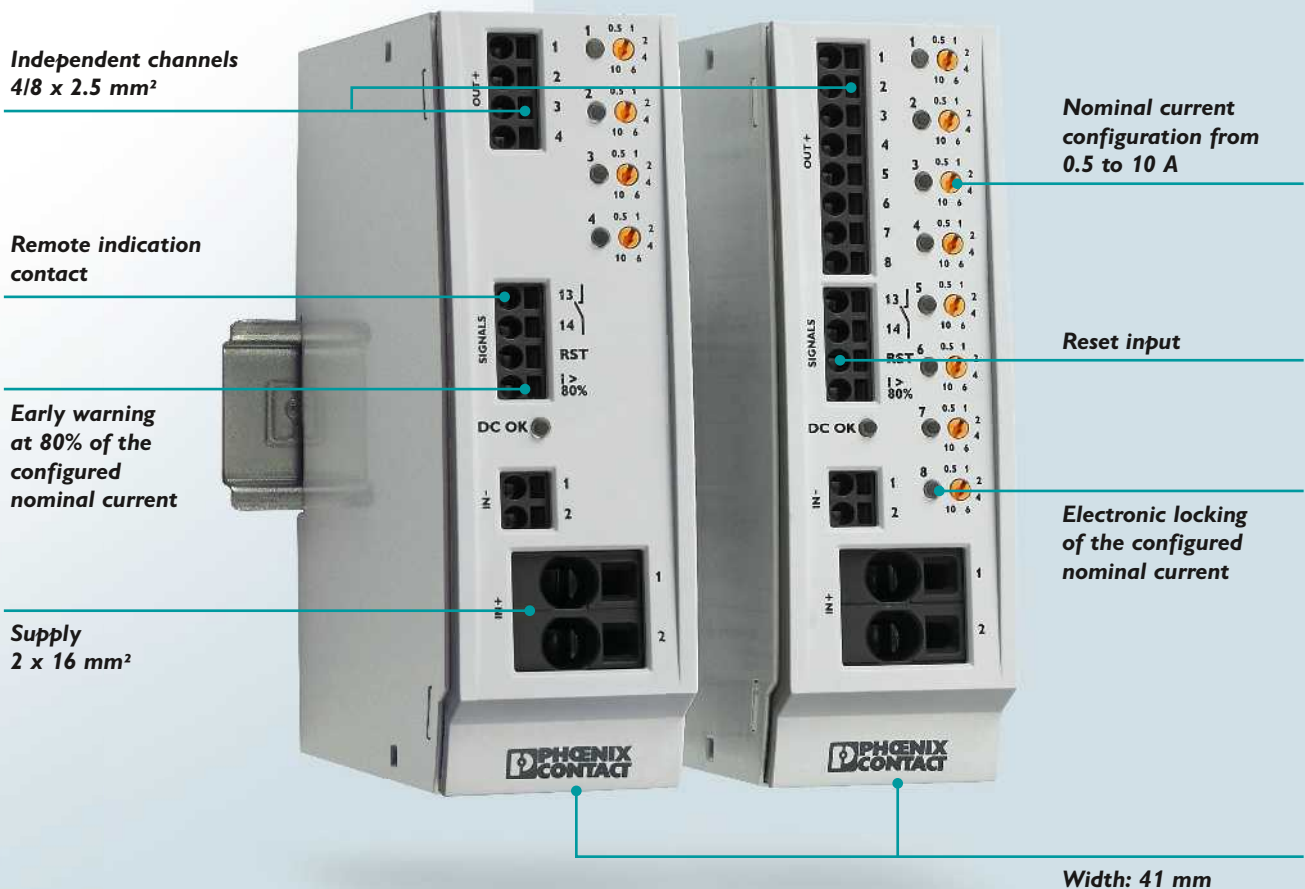

Tripping characteristics

The multi-channel electronic device circuit breakers differentiate between three states: normal operating state, overload and short circuit. In the range between 1.1 and 1.3 times the nominal current, an overload is detected and switched off after thirty seconds for

safety reasons. If the flowing current is over 1.3 times the nominal current, it is detected as a short circuit and actively limited depending on the configured current. Switching off in case of short circuit occurs after 20 milliseconds.

This allows the supply voltage to remain consistent, while other loads can continue to run without interruption.

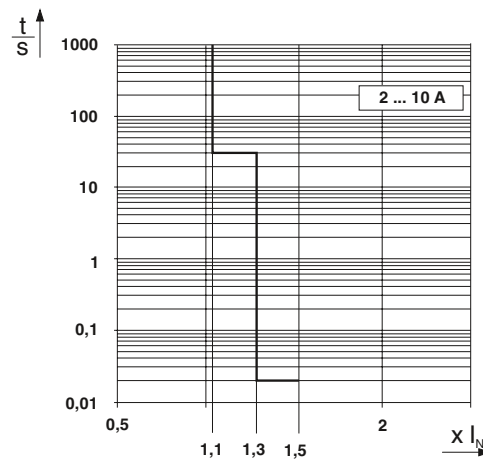
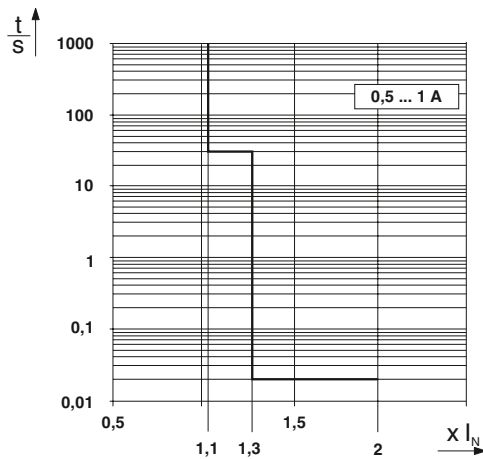
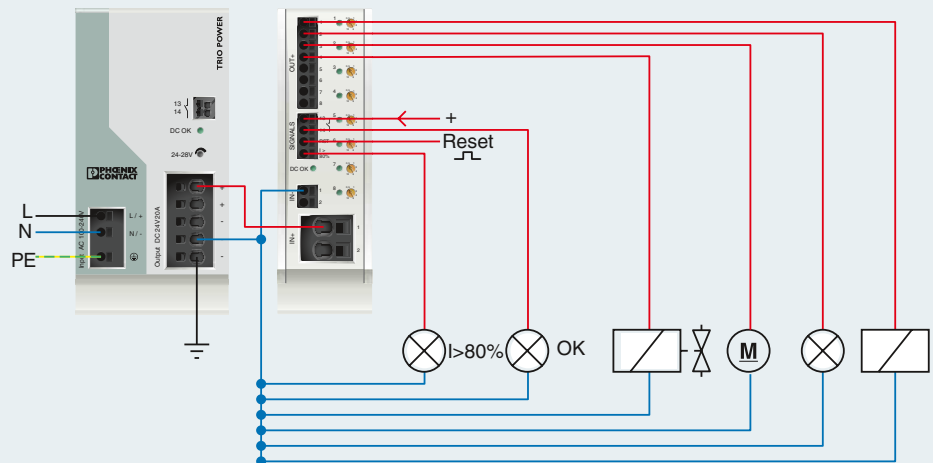

Illustration of application

By using multi-channel electronic device circuit breakers, the project engineering for a switchgear is significantly more simple and more easily understandable. The configurable nominal currents can be used to adjust the required protection for the load used. This makes the devices very well-suited for protecting relays, programmable controllers, motors, sensors/actuators and valves.

Also, the signaling always keeps the user up-to-date about the operating state of the system. The reset input can be used to remotely switch back on paths that have been switched off.



Electronic device circuit breakers

Electronic device circuit breakers are often used in automation and communication technology.

The active current limitation prevents the interruption of the output voltage at the switched-mode power supply unit in the event of an error. All other circuits remain unaffected.

Your advantages:

- Compact design with precise nominal current levels
- Sophisticated remote signaling concept enables monitoring from any location
- The reset or control input can be switched by means of remote control
- Active current limitation, even when switching capacitive loads
- Supply/remote signaling can be bridged with CLIPLINE complete accessories
- Variable connection technology: either push-in or screw connection

Negative bridge shaft

Plug locking



Two-piece/plug-in



Coding between plug and base element

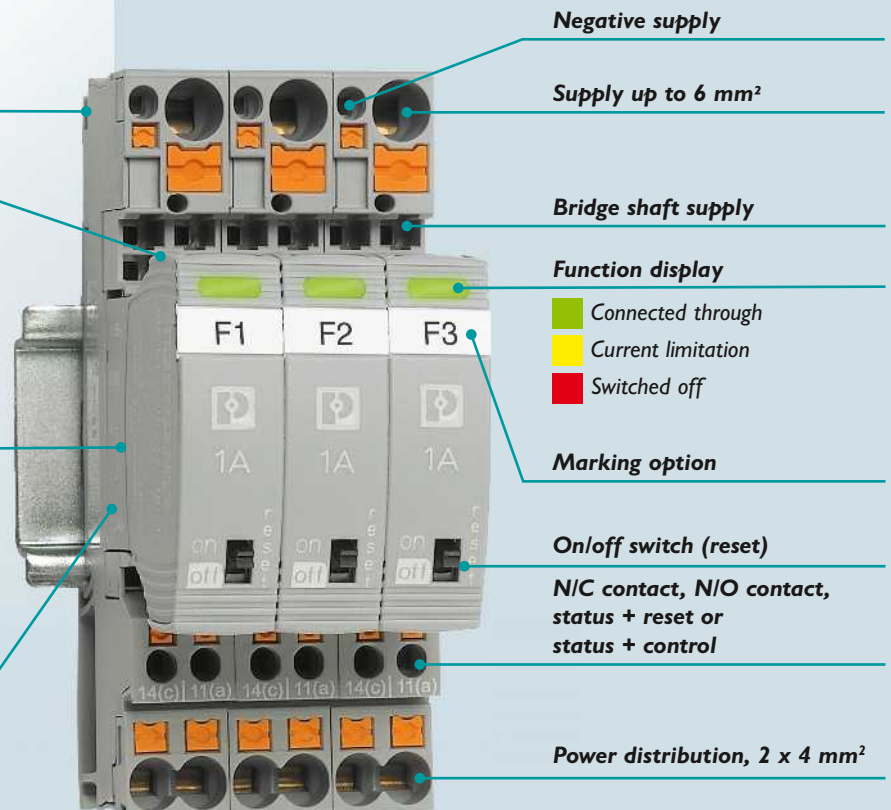
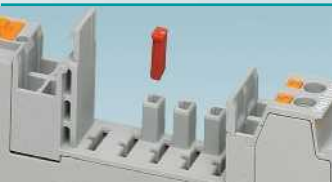

Tripping characteristics

In the event of a short circuit, electronic device circuit breakers trip within a few milliseconds. Here the current is limited to 1.25 times the nominal current. Even with a high cable resistance, the circuit breakers disconnect the circuit within the shortest possible time.

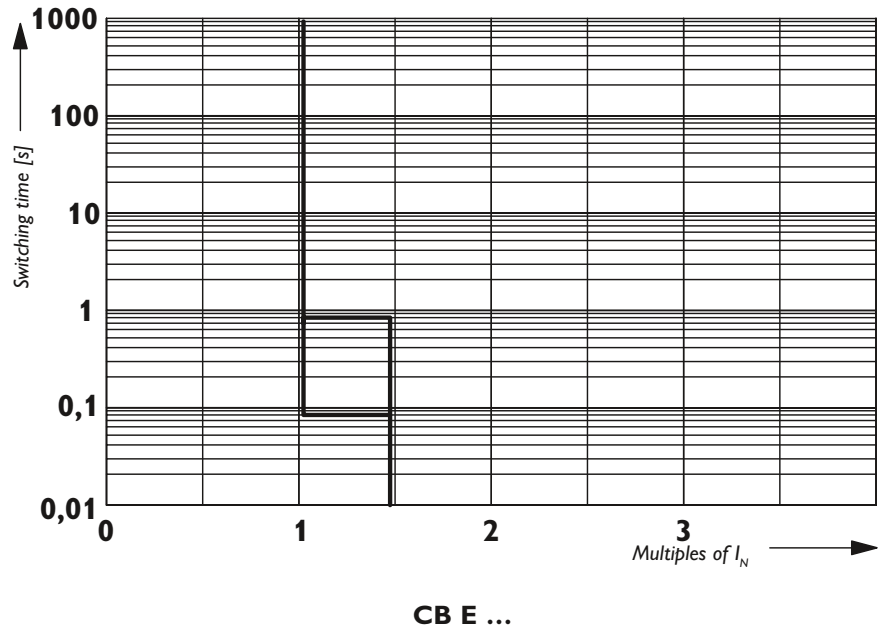
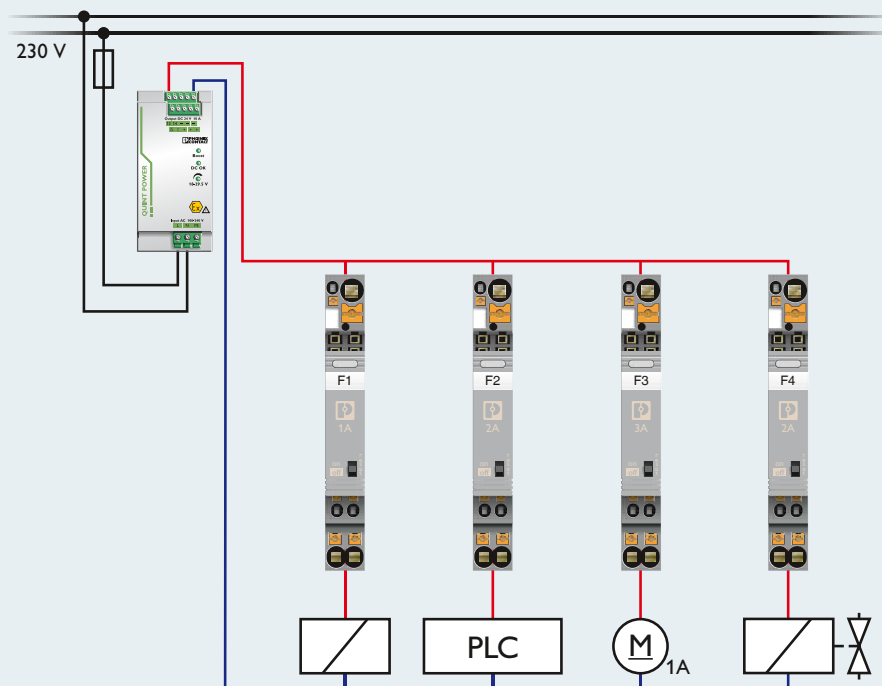

Illustration of application

Electronic device circuit breakers are ideal for protecting relays, programmable controllers, motors, sensors/actuators, and valves, for example.



Thermomagnetic device circuit breakers

The thermomagnetic device circuit breakers are used in information and communication technology as well as process engineering. Due to the various tripping characteristics, the circuit breakers can be used in a range of applications. The reactivation and immediate remote signaling of the operating state ensure availability.

Your advantages:

- Compact design with precise nominal current levels
- Sophisticated remote signaling concept enables monitoring from any location
- Maximum overcurrent protection over long cable paths thanks to SFB tripping characteristic
- Supply/remote signaling can be bridged with CLIPLINE complete accessories
- Protect 230/240 V AC control voltage with the aid of the M1 characteristic curve (based on characteristic C)
- Variable connection technology: either push-in or screw connection

Plug locking



Two-piece/plug-in



Coding between plug and base element



Bridge shaft remote signaling

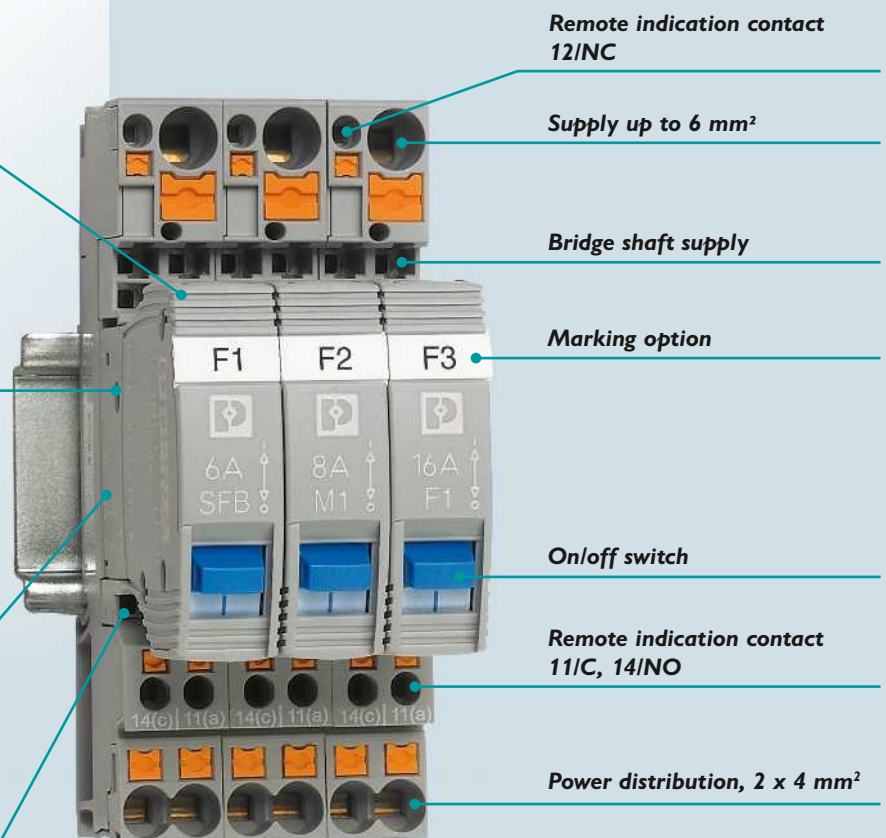

Tripping characteristics

With thermomagnetic device circuit breakers, the tripping time depends on the type of overload. In the event of an overload, the load is disconnected from the power supply by means of time-delayed thermal

tripping. If there is a high overload current or even a short circuit, the magnetic tripping interrupts the circuit in a matter of milliseconds. Protective devices should be selected with the most suitable characteristic curve in

relation to the area of application, the load, and the protection requirements.

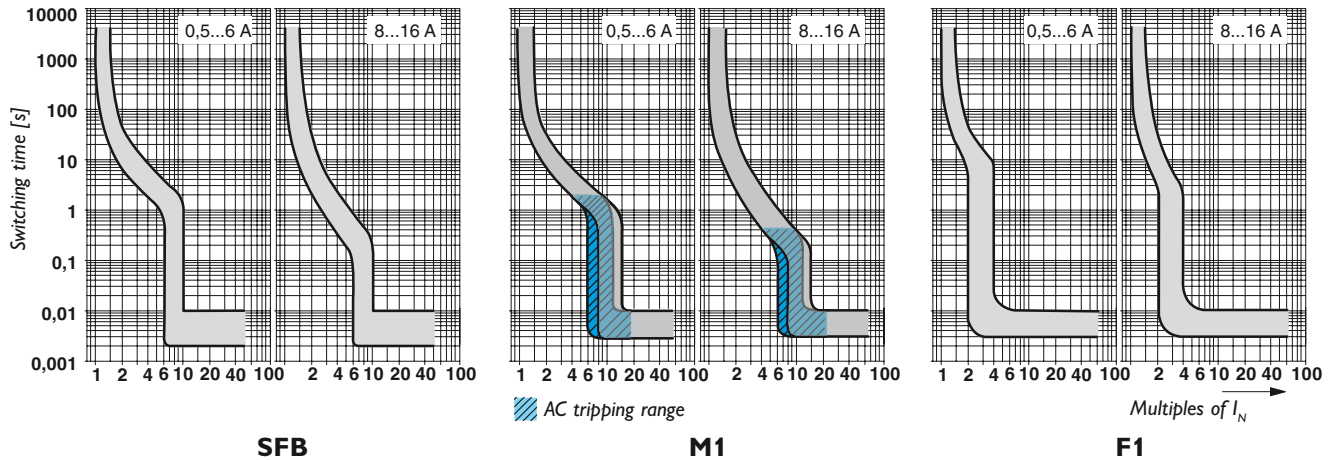
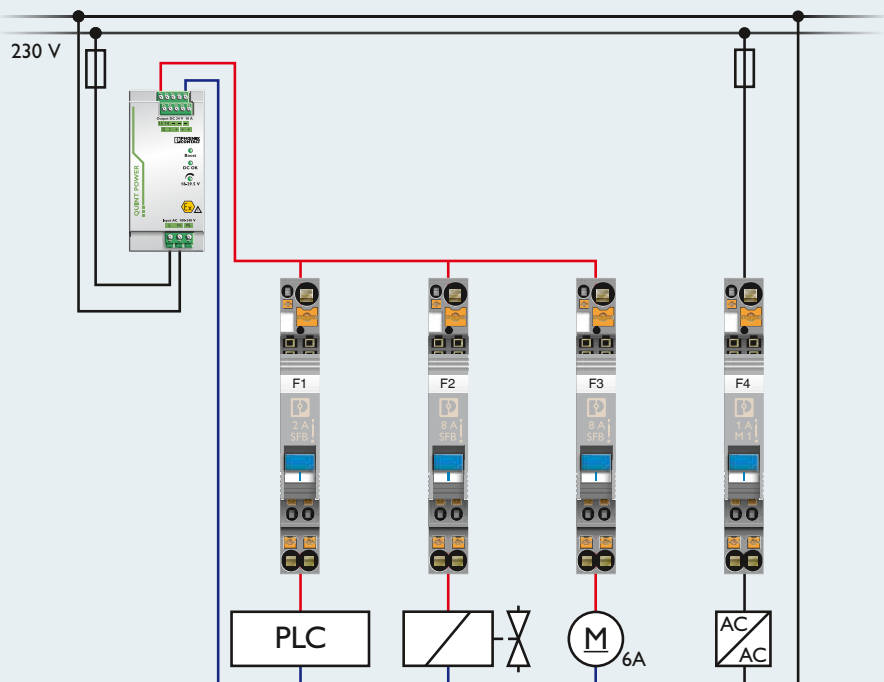

Illustration of application

Thermomagnetic device circuit breakers are ideal for protecting programmable controllers, valves, motors and frequency inverters, for example.



Thermal device circuit breakers

Thermal device circuit breakers provide optimum protection for inductive loads against overload in power distribution systems in control cabinet engineering and systems manufacturing. The integrated switching function enables the device to be switched on again immediately and therefore ensures the availability of the system.

Your advantages:

- Compact design with precise nominal current levels
- Fits in all fuse holders designed for flat-type fuse inserts in accordance with ISO 8820-3 (DIN 72581-3)
- Can be used to protect integrated circuits in all battery and onboard systems in the DC voltage range
- Supply can be bridged with CLIPLINE complete accessories
- Protect 230/240 V AC control voltage with the aid of the TCP... A products

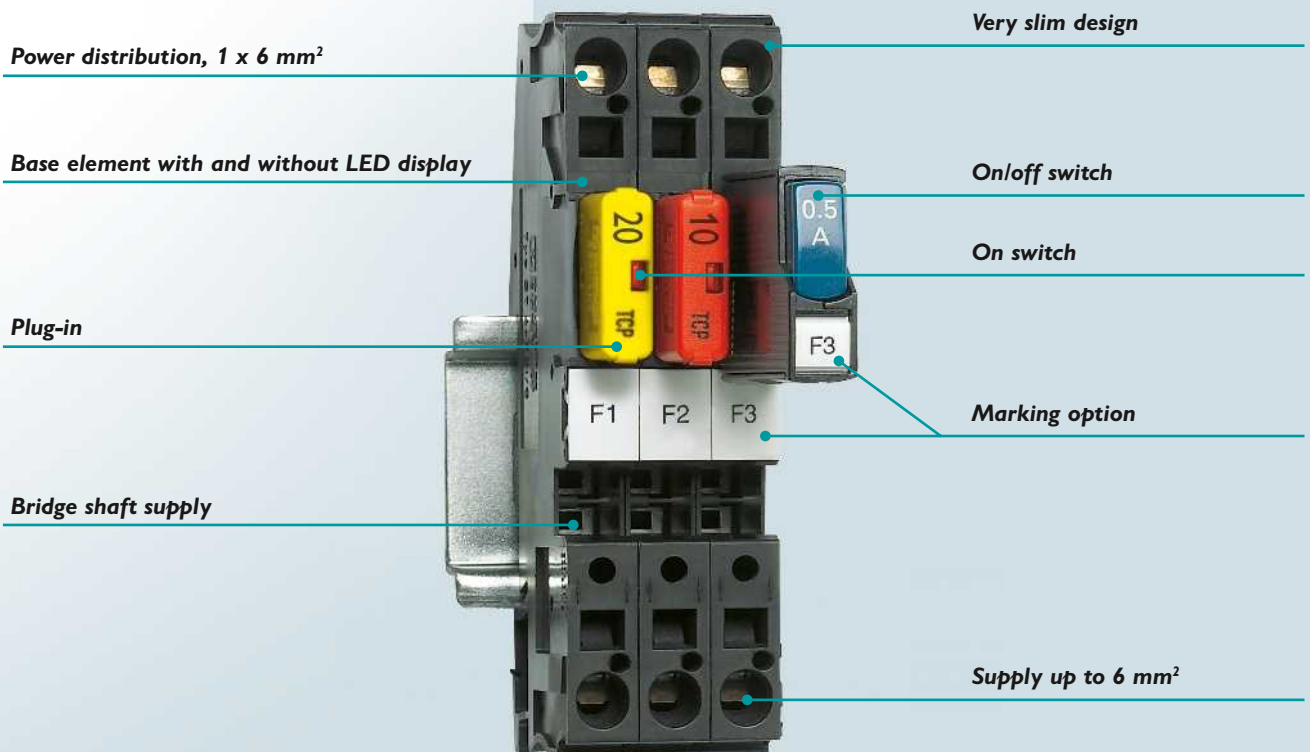

Tripping characteristics

The tripping time of the thermal device circuit breakers varies with the pending overload current. As can be seen in the characteristic curves, the circuit breaker trips more quickly as the overload increases. The protective

function provided by a bimetal reacts at a defined tripping temperature. With a relatively low overload current, it therefore takes longer for the connected load to be disconnected from the power supply.

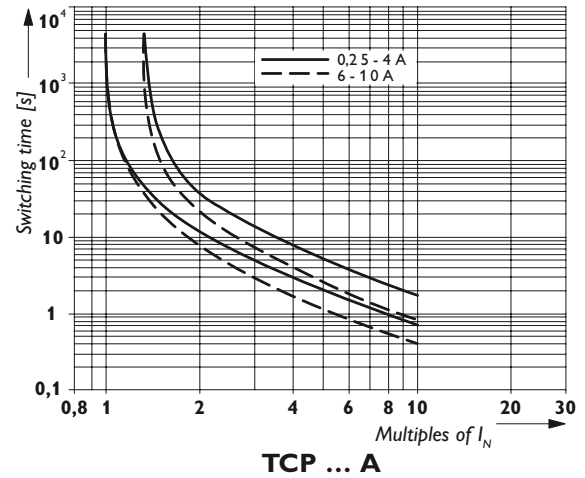
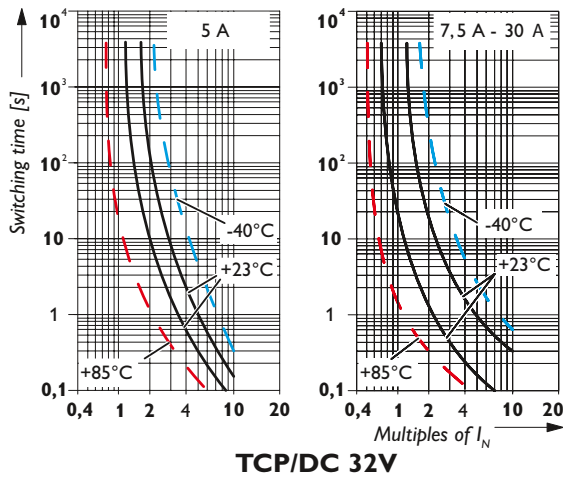
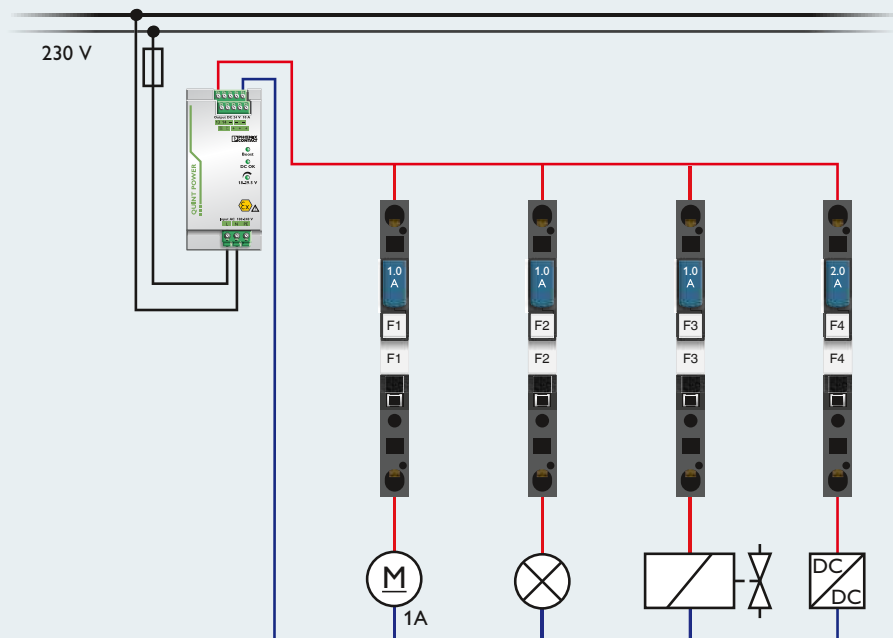

Illustration of application

Thermal device circuit breakers are ideal for protecting motors, lighting, solenoid valves, transformers and onboard networks, for example.



Device circuit breaker board

The multi-channel device circuit breaker boards are used in standard machine production or in control and process engineering, for example.

Due to the central potential distribution, installation time is reduced to a minimum. The boards are very versatile as they can be fitted individually with thermomagnetic and electronic circuit breakers.

Your advantages:

- Reduced installation time thanks to multi-channel device circuit breaker board (4/8/12 channels)
- Compact design saves up to 35% space
- Fuse protection of up to 12 A per channel provides optimum protection for the connected loads
- Thanks to the effortless potential distribution, four loads can be protected per channel
- Integrated group remote signaling ensures that you are always kept informed
- High current carrying capacity of the board supports supply of up to 60 A
- Looped-in relay contacts are also protected using the device circuit breaker

UM-PRO panel mounting base with increased temperature resistance

Fuse protection of up to 12 A per channel

Configuring the inserted circuit breakers with DIP switch

Group remote signaling divided into 2 groups

Up to 60 A supply, 4 x 16 mm²

Plug-in of push-in terminal blocks



Thermomagnetic and electronic circuit breakers can be used

Connection for external relay contacts, e.g. safety relays

4 x 2.5 mm² terminal outputs (+/-) per channel, protected

High operational reliability thanks to redundant power supply

Ensure high availability and productivity levels for your control and process engineering system.

This can be achieved with a redundant switchgear structure. In this case, two 24 V DC power supplies are decoupled via a redundancy module thereby offering superior system availability.

The doubled supply of the device circuit breaker board also offers the option of configuring redundant wiring.

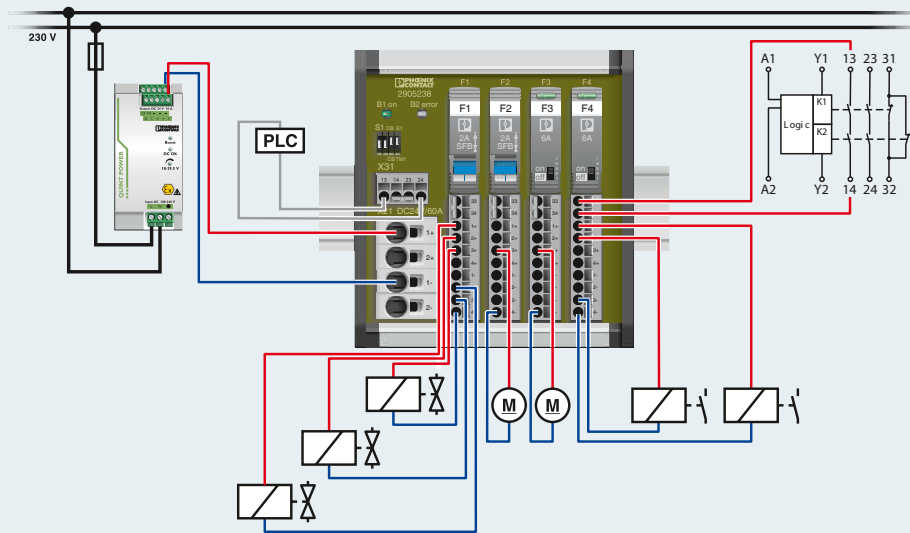

Illustration of application

The device circuit breaker boards offer connection options for up to five loads per mode of protection. Therefore, the boards combine the advantages of the device circuit breaker series CB TM1... and CB E1... with easy and space-saving potential distribution.

Group remote signaling is evaluated, for example, using a programmable controller.

Also, for each channel, the device circuit breaker board provides the option of connecting external relay contacts, such as for safety switching devices.



Product overview

Electronic device circuit breakers

	Product code	CBM multi-channel device circuit breaker	
	Channels	4	8
	Group remote signaling	Channels 1-4	Channels 1-8
	Max. supply current	40 A	80 A
		CBM E4 24DC/0.5-10A NO-R Order No. 2905743	CBM E8 24DC/0.5-10A NO-R Order No. 2905744

Electronic device circuit breakers



Product code	CB device circuit breakers			
	E electronic			
	1			
	24 DC			
Type	NO N/O contact	NC N/C contact	S-R status output and reset input	
Nominal current	1 A	CB E1 24DC/1A NO P Order No. 2800901	CB E1 24DC/1A NC P Order No. 2800915	CB E1 24DC/1A S-R P Order No. 2800908
	2 A	CB E1 24DC/2A NO P Order No. 2800902	CB E1 24DC/2A NC P Order No. 2800916	CB E1 24DC/2A S-R P Order No. 2800909
	3 A	CB E1 24DC/3A NO P Order No. 2800903	CB E1 24DC/3A NC P Order No. 2800917	CB E1 24DC/3A S-R P Order No. 2800910
	4 A	CB E1 24DC/4A NO P Order No. 2800904	CB E1 24DC/4A NC P Order No. 2800918	CB E1 24DC/4A S-R P Order No. 2800911
	6 A	CB E1 24DC/6A NO P Order No. 2800905	CB E1 24DC/6A NC P Order No. 2800919	CB E1 24DC/6A S-R P Order No. 2800912
	8 A	CB E1 24DC/8A NO P Order No. 2800906	–	CB E1 24DC/8A S-R P Order No. 2800913
	10 A	CB E1 24DC/10A NO P Order No. 2800907	–	CB E1 24DC/10A S-R P Order No. 2800914
Type	S-C Status output and control input	SI-R Inverted status output and reset input	SI-C Inverted status output and control input	
Nominal current	1 A	CB E1 24DC/1A S-C P Order No. 2800922	CB E1 24DC/1A SI-R P Order No. 2905799	CB E1 24DC/1A SI-C P Order No. 2905806
	2 A	CB E1 24DC/2A S-C P Order No. 2800923	CB E1 24DC/2A SI-R P Order No. 2905800	CB E1 24DC/2A SI-C P Order No. 2905807
	3 A	CB E1 24DC/3A S-C P Order No. 2800924	CB E1 24DC/3A SI-R P Order No. 2905801	CB E1 24DC/3A SI-C P Order No. 2905808
	4 A	CB E1 24DC/4A S-C P Order No. 2800925	CB E1 24DC/4A SI-R P Order No. 2905802	CB E1 24DC/4A SI-C P Order No. 2905809
	6 A	CB E1 24DC/6A S-C P Order No. 2800926	CB E1 24DC/6A SI-R P Order No. 2905803	CB E1 24DC/6A SI-C P Order No. 2905810
	8 A	CB E1 24DC/8A S-C P Order No. 2800927	CB E1 24DC/8A SI-R P Order No. 2905804	CB E1 24DC/8A SI-C P Order No. 2905811
	10 A	CB E1 24DC/10A S-C P Order No. 2800928	CB E1 24DC/10A SI-R P Order No. 2905805	CB E1 24DC/10A SI-C P Order No. 2905812

NO: normally open

NC: normally closed

S-R: status out – reset in

S-C: status out – control in

SI-R: status out inverted – reset in

SI-C: status out inverted – control in



reset in: restart with impulse

control in: switching on and off with applying 24 V DC

status out: in the case of active load output, a high signal (24 V DC) is issued

status out inverted: in the case of active load output, a low signal (0 V DC) is issued

Thermomagnetic device circuit breakers, 1 and 2-pos.

Product code	CB device circuit breakers			
	TM thermomagnetic			
Fuse type	1 changeover contact			
Function	1			
Number of positions	1			
Characteristic curve	SFB	M1	F1	
	0.5 A	CB TM1 0.5A SFB P Order No. 2800835	CB TM1 0.5A M1 P Order No. 2800846	CB TM1 0.5A F1 P Order No. 2800857
	1 A	CB TM1 1A SFB P Order No. 2800836	CB TM1 1A M1 P Order No. 2800847	CB TM1 1A F1 P Order No. 2800858
	2 A	CB TM1 2A SFB P Order No. 2800837	CB TM1 2A M1 P Order No. 2800848	CB TM1 2A F1 P Order No. 2800859
	3 A	CB TM1 3A SFB P Order No. 2800838	CB TM1 3A M1 P Order No. 2800849	CB TM1 3A F1 P Order No. 2800860
	4 A	CB TM1 4A SFB P Order No. 2800839	CB TM1 4A M1 P Order No. 2800850	CB TM1 4A F1 P Order No. 2800861
	5 A	CB TM1 5A SFB P Order No. 2800840	CB TM1 5A M1 P Order No. 2800851	CB TM1 5A F1 P Order No. 2800862
	6 A	CB TM1 6A SFB P Order No. 2800841	CB TM1 6A M1 P Order No. 2800852	CB TM1 6A F1 P Order No. 2800863
	8 A	CB TM1 8A SFB P Order No. 2800842	CB TM1 8A M1 P Order No. 2800853	CB TM1 8A F1 P Order No. 2800864
	10 A	CB TM1 10A SFB P Order No. 2800843	CB TM1 10A M1 P Order No. 2800854	CB TM1 10A F1 P Order No. 2800865
	12 A	CB TM1 12A SFB P Order No. 2800844	CB TM1 12A M1 P Order No. 2800855	CB TM1 12A F1 P Order No. 2800866
	16 A	CB TM1 16A SFB P Order No. 2800845	CB TM1 16A M1 P Order No. 2800856	CB TM1 16A F1 P Order No. 2800867
Function	2 changeover contacts			
Number of positions	2			
Characteristic curve	SFB	M1	F1	
	0.5 A	CB TM2 0.5A SFB P Order No. 2800868	CB TM2 0.5A M1 P Order No. 2800879	CB TM2 0.5A F1 P Order No. 2800890
	1 A	CB TM2 1A SFB P Order No. 2800869	CB TM2 1A M1 P Order No. 2800880	CB TM2 1A F1 P Order No. 2800891
	2 A	CB TM2 2A SFB P Order No. 2800870	CB TM2 2A M1 P Order No. 2800881	CB TM2 2A F1 P Order No. 2800892
	3 A	CB TM2 3A SFB P Order No. 2800871	CB TM2 3A M1 P Order No. 2800882	CB TM2 3A F1 P Order No. 2800893
	4 A	CB TM2 4A SFB P Order No. 2800872	CB TM2 4A M1 P Order No. 2800883	CB TM2 4A F1 P Order No. 2800894
	5 A	CB TM2 5A SFB P Order No. 2800873	CB TM2 5A M1 P Order No. 2800884	CB TM2 5A F1 P Order No. 2800895
	6 A	CB TM2 6A SFB P Order No. 2800874	CB TM2 6A M1 P Order No. 2800885	CB TM2 6A F1 P Order No. 2800896
	8 A	CB TM2 8A SFB P Order No. 2800875	CB TM2 8A M1 P Order No. 2800886	CB TM2 8A F1 P Order No. 2800897
	10 A	CB TM2 10A SFB P Order No. 2800876	CB TM2 10A M1 P Order No. 2800887	CB TM2 10A F1 P Order No. 2800898
	12 A	CB TM2 12A SFB P Order No. 2800877	CB TM2 12A M1 P Order No. 2800888	CB TM2 12A F1 P Order No. 2800899
	16 A	CB TM2 16A SFB P Order No. 2800878	CB TM2 16A M1 P Order No. 2800889	CB TM2 16A F1 P Order No. 2800900

Thermal circuit breakers



Product code	Thermal circuit breakers		
Number of positions	1		
Characteristic curve	T1		
Function	Can be switched on and off		
Nominal current	0.1 A	TCP 0,1A	Order No. 0712107
	0.25 A	TCP 0,25A	Order No. 0712123
	0.5 A	TCP 0,5A	Order No. 0712152
	1 A	TCP 1A	Order No. 0712194
	2 A	TCP 2A	Order No. 0712217
	3 A	TCP 3A	Order No. 0712233
	4 A	TCP 4A	Order No. 0712259
	6 A	TCP 6A	Order No. 0712275
	8 A	TCP 8A	Order No. 0712291
	10 A	TCP 10A	Order No. 0712314



Product code	Thermal circuit breakers		
Number of positions	1		
Characteristic curve	T1		
Function	Reclosable		
Nominal current	5 A	TCP 5/DC32V	Order No. 0700005
	7.5 A	TCP 7,5/DC32V	Order No. 0700007
	10 A	TCP 10/DC32V	Order No. 0700010
	15 A	TCP 15/DC32V	Order No. 0700015
	20 A	TCP 20/DC32V	Order No. 0700020
	25 A	TCP 25/DC32V	Order No. 0700025
	30 A	TCP 30/DC32V	Order No. 0700030
	40 A	TCP 40/DC32V	Order No. 0700040



Product code	Flat-type fuse terminal block		
Function	Without LED display	With LED display, 12 V	With LED display, 24 V
	ST 4-FSI/C Order No. 3036372	ST 4-FSI/C-LED 12 Order No. 3036495	ST 4-FSI/C-LED 24 Order No. 3036505
	UK 6-FSI/C Order No. 3118203	UK 6-FSI/C-LED12 Order No. 3001925	UK 6-FSI/C-LED24 Order No. 3001938

Device circuit breaker board

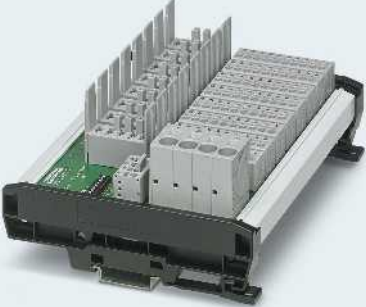
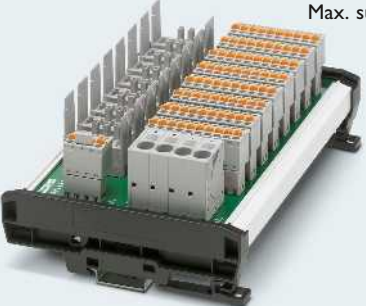
	Product code	CBB device circuit breaker board		
	Mounting	Thermomagnetic and electronic device circuit breaker CB TM1 ... and CB E1 ... NO		
	Channels	4	8	12
	Group remote signaling	2 x 2	2 x 4	2 x 6
	Max. supply current	48 A	60 A	60 A
	CBB 04 2x2RC-PT Order No. 2905238	CBB 08 2x4RC-PT Order No. 2905240	CBB 12 2x6RC-PT Order No. 2905241	
	Mounting	Thermomagnetic device circuit breaker CB TM1 ...		
	Channels	4	8	12
	Group remote signaling	2 x 2	2 x 4	2 x 6
	Max. supply current	48 A	60 A	60 A
		CBB TM 04 2x2RC P-PT Order No. 2801481	CBB TM 08 2x4RC P-PT Order No. 2801482	CBB TM 12 2x6RC P-PT Order No. 2801483

Select the right CB TM1... or CB E1... device circuit breakers according to the application.

Accessories

	Product code	Base element		
		Screw connection technology	Push-in connection technology	Solder base element for PCBs
		CB 1/10-1/10 UT-BE Order No. 2801305	CB 1/6-2/4 PT-BE Order No. 2800929	CB S-BE Order No. 2905067
<i>Note: supply can be loaded with up to 41 A if two bridges are connected.</i>				

	Product code	Bridge plug for base element	
		CB PT Bridge Order No. 2801014	CB RC Bridge Order No. 2801616
		<i>Bridge between 1 and 2</i>	<i>Bridge between 11 and 14</i>

	Product code	Base element and jumpers		
	Number of positions	2	FBL 2-6	Order No. 3030336
		3	FBL 3-6	Order No. 3030242
		4	FBL 4-6	Order No. 3030255
		5	FBL 5-6	Order No. 3030349
		10	FBL 10-6	Order No. 3030271
		20	FBL 20-6	Order No. 3030365
50		FBL 50-6	Order No. 3032224	

	Product code	Front cutting tool for jumpers
		CUTFOX-FBL Order No. 1212124

For more bridges and marking material, see main catalog or website.

Device circuit breakers and QUINT POWER

The configuration matrix can help with the secondary-side planning of your power supply unit. It describes the maximum cable lengths depending on:

- The device circuit breaker
- The conductor cross section
- The performance class of the power supply unit

Additional support is available from our online configurator and the online project engineering matrix.

QUINT POWER and device circuit breaker with SFB characteristic curve

The combination of QUINT POWER power supplies and thermomagnetic device circuit breakers with SFB characteristic curve provides you with the following advantages:

- Short circuit triggering after at least 10 milliseconds for safe operation of your controller
- Substantial reduction of tolerances; this causes the required release current to be reduced
- Safe shutoff of faulty paths through electrical isolation

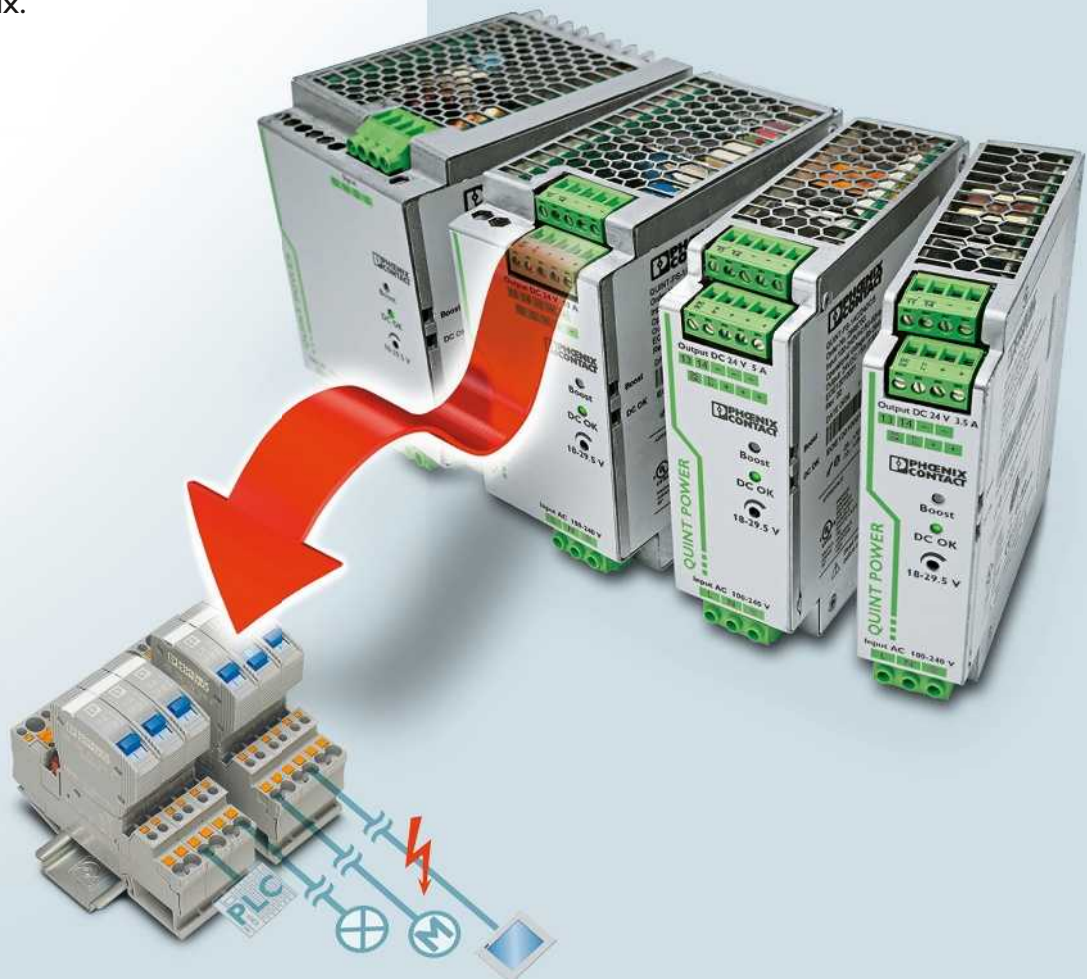

Cable calculations

Some information is needed in order to calculate the conductor lengths. This basic data includes the output voltage of the power supply (U), the rated current of the device circuit breaker (I_{CB}) and the conductor cross section of the cable to be used. The characteristic curves of the respective device circuit breaker types are used as a basis for this.

1. Calculation of the maximum resistance:

$$R_{\max} = \frac{U}{I_{CB} \times I_{\text{Factor}}}$$

$$= \frac{24 \text{ V}}{1 \text{ A} \times 15} = 1.6 \ \Omega$$

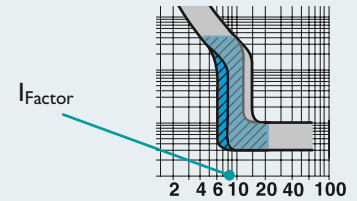

2. Calculation of the maximum cable resistance:

$$R_{\text{Cable max}} = R_{\max} - R_{\text{CB}}$$

$$= 1.6 \ \Omega - 1.1 \ \Omega$$

$$= 0.5 \ \Omega$$

CB	Internal resistance
CB 1A	1.1 Ω
CB 2A	0.32 Ω
CB 3A	0.14 Ω

3. Now all the necessary information is available in order to calculate the maximum cable lengths using the following formula:

$$l = \frac{R \times A}{\rho} \quad l = \frac{0.5 \times 1.5}{0.01786} \quad l = 42 \text{ m}$$

(forward and return line):

ρ = specific resistance (copper 0.01786)
A = cross section/conductor

Distance (l) = 21 m

Cable lengths

The values specified relate to the distance (l) from the power supply unit to the load. **Boundary parameters for the calculation:**

- CB TM1 x A SFB P device circuit breaker
- Electromagnetic tripping at the latest at:
 - 10 times the rated current
 - Ambient temperature: +20°C
 - Power supply QUINT POWER with SFB technology

The internal resistance of the device circuit breakers is taken into account.

In addition to the short-circuit current, the relevant power supply unit also supplies half the nominal current for paths connected in parallel.

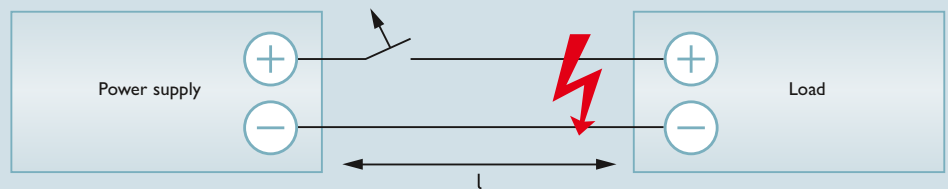

[Conductor cross section] mm²

	0.75	1	1.5	2.5	4
	Distance in m				

24 V / 5 A					
CB TM1 1A SFB P	27	36	54	91	
CB TM1 2A SFB P	10	13	20	34	
24 V/10 A					
CB TM1 1A SFB P	27	36	54	91	
CB TM1 2A SFB P	18	25	37	63	
CB TM1 3A SFB P	11	15	22	38	

Extract from the configuration matrix. The complete matrix can be found at: phoenixcontact.com > Products > Protective devices > Device circuit breakers

QUINT POWER – Power supply units for superior system availability

Benefit from the functional advantages of the QUINT POWER power supplies. The unique SFB technology and preventive function monitoring increase the availability of your application.



All features at a glance

Quick tripping of device circuit breakers

Dynamic power reserve SFB technology with up to 6 times the nominal current for 12 milliseconds

Reliable starting of heavy loads

Static POWER BOOST power reserve with up to 1.5 times the nominal current on a permanent basis

Preventive function monitoring

Warns of critical operating states before faults occur by permanently monitoring the output voltage and current, remote monitoring using active switching output and floating relay contact

Worldwide use

Thanks to the wide range input and international approval package

High operational reliability

due to high MTBF > 500,000 h, long power failure buffering times > 20 ms, high electric strength of single-phase devices of up to 300 V AC

Parallel connection possible

for increased performance and redundancy

Three-phase devices

Error-free operation, even in the event of a permanent phase failure, high surge resistance of up to 6 kV thanks to integrated gas-filled surge arrester

Compensation of voltage drops

Output voltage can be set on front side. The voltage range of 5 to 56 V DC can be covered with three power supply units with output voltages of 12, 24, and 48 V DC.

Easy-to-maintain connection technology

with coded COMBICON connectors (up to and including 10 A)

Robust design

Metal housing and wide temperature range of -25°C to +70°C

Minimize installation costs

Third negative terminal as the grounding terminal block

	Input voltage range	Output current / POWER BOOST / SFB	Magnetic fuse tripping up to	Setting range of the output voltage	Dimensions W x H x D
QUINT POWER 1~					
QUINT-PS/1AC/24DC/3.5 Order No. 2866747	85 V AC ... 264 V AC 90 V DC ... 350 V DC	3.5 A / 4 A / 15 A	B2	18 V DC ... 29.5 V DC	32 x 130 x 125
QUINT-PS/1AC/24DC/5 Order No. 2866750	85 V AC ... 264 V AC 90 V DC ... 350 V DC	5 A / 7.5 A / 30 A	B2, B4, C2	18 V DC ... 29.5 V DC	40 x 130 x 125
QUINT-PS/1AC/24DC/10 Order No. 2866763	85 V AC ... 264 V AC 90 V DC ... 350 V DC	10 A / 15 A / 60 A	B2, B4, B6, C2, C4	18 V DC ... 29.5 V DC	60 x 130 x 125
QUINT-PS/1AC/24DC/20 Order No. 2866776	85 V AC ... 264 V AC 90 V DC ... 350 V DC	20 A / 26 A / 120 A	B2, B4, B6, B10, B16, C2, C4, C6	18 V DC ... 29.5 V DC	90 x 130 x 125
QUINT-PS/1AC/24DC/40 Order No. 2866789	85 V AC ... 264 V AC 90 V DC ... 350 V DC	40 A / 45 A / 215 A	B2, B4, B6, B10, B16, B25, C2, C4, C6, C13	18 V DC ... 29.5 V DC	180 x 130 x 125
QUINT-PS/1AC/12DC/15 Order No. 2866718	85 V AC ... 264 V AC 90 V DC ... 350 V DC	15 A / 16 A / 60 A	B2, B4, B6, C2, C4	5 V DC ... 18 V DC	60 x 130 x 125
QUINT-PS/1AC/12DC/20 Order No. 2866721	85 V AC ... 264 V AC 90 V DC ... 350 V DC	20 A / 26 A / 120 A	B2, B4, B6, B10, C2, C4, C6	5 V DC ... 18 V DC	90 x 130 x 125
QUINT-PS/1AC/48DC/5 Order No. 2866679	85 V AC ... 264 V AC 90 V DC ... 350 V DC	5 A / 7.5 A / 30 A	B2, B4, C2	30 V DC ... 56 V DC	60 x 130 x 125
QUINT-PS/1AC/48DC/10 Order No. 2866682	85 V AC ... 264 V AC 90 V DC ... 350 V DC	10 A / 13 A / 60 A	B2, B4, B6, C2, C4	30 V DC ... 56 V DC	90 x 130 x 125
QUINT-PS/1AC/48DC/20 Order No. 2866695	85 V AC ... 264 V AC 90 V DC ... 350 V DC	20 A / 22.5 A / 100 A	B2, B4, B6, B10, C2, C4, C6	30 V DC ... 56 V DC	180 x 130 x 125
QUINT POWER 3~					
QUINT-PS/3AC/24DC/5 Order No. 2866734	320 V AC ... 575 V AC 450 V DC ... 800 V DC	5 A / 7.5 A / 30 A	B2, B4, C2	18 V DC ... 29.5 V DC	40 x 130 x 125
QUINT-PS/3AC/24DC/10 Order No. 2866705	320 V AC ... 575 V AC 450 V DC ... 800 V DC	10 A / 15 A / 60 A	B2, B4, B6, C2, C4	18 V DC ... 29.5 V DC	60 x 130 x 125
QUINT-PS/3AC/24DC/20 Order No. 2866792	320 V AC ... 575 V AC 450 V DC ... 800 V DC	20 A / 26 A / 120 A	B2, B4, B6, B10, B16, C2, C4, C6	18 V DC ... 29.5 V DC	69 x 130 x 125
QUINT-PS/3AC/24DC/40 Order No. 2866802	320 V AC ... 575 V AC 450 V DC ... 800 V DC	40 A / 45 A / 215 A	B2, B4, B6, B10, B16, B25, C2, C4, C6, C13	18 V DC ... 29.5 V DC	96 x 130 x 176
QUINT-PS/3AC/48DC/20 Order No. 2320827	320 V AC ... 575 V AC 450 V DC ... 800 V DC	20 A / 22.5 A / 100 A	B2, B4, B6, B10, C2, C4, C6	30 V DC ... 56 V DC	96 x 130 x 176
QUINT POWER CO, with protective coating for 100% humidity					
QUINT-PS/1AC/24DC/5/CO Order No. 2320908	85 V AC ... 264 V AC 90 V DC ... 350 V DC	5 A / 7.5 A / 30 A	B2, B4, C2	18 V DC ... 29.5 V DC	40 x 130 x 125
QUINT-PS/1AC/24DC/10/CO Order No. 2320911	85 V AC ... 264 V AC 90 V DC ... 350 V DC	10 A / 15 A / 60 A	B2, B4, B6, C2, C4	18 V DC ... 29.5 V DC	60 x 130 x 125
QUINT-PS/1AC/24DC/20/CO Order No. 2320898	85 V AC ... 264 V AC 90 V DC ... 350 V DC	20 A / 26 A / 120 A	B2, B4, B6, B10, B16, C2, C4, C6	18 V DC ... 29.5 V DC	90 x 130 x 125
QUINT-PS/3AC/24DC/20/CO Order No. 2320924	320 V AC ... 575 V AC 450 V DC ... 800 V DC	20 A / 26 A / 120 A	B2, B4, B6, B10, B16, C2, C4, C6	18 V DC ... 29.5 V DC	69 x 130 x 125
DC/DC converters					
QUINT-PS/24DC/24DC/5 Order No. 2320034	18 V DC ... 32 V DC	5 A / 6.25 A / 30 A	B2, B4, C2	18 V DC ... 29.5 V DC	32 x 130 x 125
QUINT-PS/24DC/24DC/10 Order No. 2320092	18 V DC ... 32 V DC	10 A / 12.5 A / 60 A	B2, B4, B6, C2, C4	18 V DC ... 29.5 V DC	48 x 130 x 125
QUINT-PS/24DC/24DC/20 Order No. 2320102	18 V DC ... 32 V DC	20 A / 25 A / 120 A	B2, B4, B6, B10, B16, C2, C4, C6	18 V DC ... 29.5 V DC	82 x 130 x 125
QUINT-PS/24DC/12DC/8 Order No. 2320115	18 V DC ... 32 V DC	8 A / 10 A / 48 A	B2, B4, C2	5 V DC ... 18 V DC	32 x 130 x 125
QUINT-PS/24DC/48DC/5 Order No. 2320128	18 V DC ... 32 V DC	5 A / 6.25 A / 30 A	B2, B4, C2	30 V DC ... 56 V DC	48 x 130 x 125
QUINT-PS/12DC/12DC/8 Order No. 2905007	9 V DC ... 18 V DC	8 A / 10 A / 48 A	B2, B4, C2	5 V DC ... 18 V DC	32 x 130 x 125
QUINT-PS/48DC/48DC/5 Order No. 2905008	30 V DC ... 60 V DC	5 A / 6.25 A / 30 A	B2, B4, C2	30 V DC ... 56 V DC	48 x 130 x 125

TRIO POWER and CBM – The perfect team for very high system availability

The combination of the CBM multi-channel electronic device circuit breakers and the TRIO POWER power supplies with push-in connection technology can help you increase the availability of your systems and machines.

Both products are perfectly matched to the requirements in machine building, forming an extremely slim 24 V power supply for superior system availability.

The common advantages:

- Saves space in the control cabinet thanks to narrow design of both products
- High system availability thanks to the optimum combination of power supply and device protection
- Quick and tool-free installation thanks to push-in technology
- A wide variety of application areas thanks to wide temperature range and high shock and vibration resistance



The features of TRIO POWER at a glance

- **Reliable starting of difficult loads**
The dynamic BOOST supplies 1.5 times the nominal current for 5 seconds
- **Active function monitoring**
Remote monitoring of the output voltage using floating relay contact
- **High operational reliability** due to robust design in terms of shock, vibration and electric strength. High MTBF (Mean Time Between Failure) and temperature range between -25 °C and +70 °C as well as device startup at -40 °C (type-tested)
- **Three-phase devices**
Error-free function, even if one phase fails permanently
- **Input voltage range** for DC voltage of 110 to 250 V DC or 600 V DC
- Minimize installation costs
- Third negative terminal block used as a grounding terminal block
- Compensation of voltage drops by means of output voltage that can be adjusted on the front



	Input voltage range	Output current/ dynamic boost	Setting range of the output voltage	Dimensions W x H x D
TRIO POWER 1~				
TRIO-PS-2G/1AC/24DC/3/C2LPS Order No. 2903147	85 V AC ... 264 V AC 110 V DC ... 250 V DC	3 A / 4.5 A	24 V DC ... 28 V DC	30 x 130 x 115
TRIO-PS-2G/1AC/24DC/5 Order No. 2903148	85 V AC ... 264 V AC 110 V DC ... 250 V DC	5 A / 7.5 A	24 V DC ... 28 V DC	35 x 130 x 115
TRIO-PS-2G/1AC/24DC/10 Order No. 2903149	85 V AC ... 264 V AC 110 V DC ... 250 V DC	10 A / 15 A	24 V DC ... 28 V DC	42 x 130 x 160
TRIO-PS-2G/1AC/24DC/20 Order No. 2903151	85 V AC ... 264 V AC 110 V DC ... 250 V DC	20 A / 30 A	24 V DC ... 28 V DC	68 x 130 x 160
TRIO POWER 3~				
TRIO-PS-2G/3AC/24DC/5 Order No. 2903153	3x 320 V AC ... 575 V AC 600 V DC	5 A / 7.5 A	24 V DC ... 28 V DC	35 x 130 x 115
TRIO-PS-2G/3AC/24DC/10 Order No. 2903154	2x/3x 320 V AC ... 575 V AC 600 V DC	10 A / 15 A	24 V DC ... 28 V DC	45 x 130 x 160
TRIO-PS-2G/3AC/24DC/20 Order No. 2903155	2x/3x 320 V AC ... 575 V AC 600 V DC	20 A / 30 A	24 V DC ... 28 V DC	65 x 130 x 160



Always up-to-date, always available to you. Here you'll find everything on our products, solutions and service:

phoenixcontact.com

Product range

- Cables and wires
- Connectors
- Controllers
- Electronics housing
- Electronic switchgear and motor control
- Fieldbus components and systems
- Functional safety
- HMIs and industrial PCs
- I/O systems
- Industrial communication technology
- Industrial Ethernet
- Installation and mounting material
- Lighting and signaling
- Marking and labeling
- Measurement and control technology
- Modular terminal blocks
- Monitoring
- PCB terminal blocks and PCB connectors
- Power supply units and UPS
- Protective devices
- Relay modules
- Sensor/actuator cabling
- Software
- Surge protection and interference filters
- System cabling for controllers
- Tools
- Wireless data communication

PHOENIX CONTACT GmbH & Co. KG
Flachmarktstraße 8
32825 Blomberg, Germany
Phone: + 49 5235 3-00
Fax: + 49 5235 3-41200
E-mail: info@phoenixcontact.com
phoenixcontact.com