



***California Instruments***  
**RS Series**  
**AC and DC Power Source**  
**User Manual**

User Manual  
California Instruments - AC Power Source  
AMETEK Programmable Power.

Models:

- RS90-3Pi
- RS180-3Pi
- RS270-3Pi
- RS360-3Pi
- RS450-3Pi
- RS540-3Pi

## About AMETEK

AMETEK Programmable Power, Inc., a Division of AMETEK, Inc., is a global leader in the design and manufacture of precision, programmable power supplies for R&D, test and measurement, process control, power bus simulation and power conditioning applications across diverse industrial segments. From bench top supplies to rack-mounted industrial power subsystems, AMETEK Programmable Power is the proud manufacturer of Elgar, Sorensen, California Instruments and Power Ten brand power supplies.

AMETEK, Inc. is a leading global manufacturer of electronic instruments and electromechanical devices with annualized sales of \$2.9 billion. The Company has over 11,000 colleagues working at more than 80 manufacturing facilities and more than 80 sales and service centers in the United States and around the world.

## Trademarks

AMETEK is a registered trademark of AMETEK, Inc. California Instruments is a trademark owned by AMETEK, Inc. Other trademarks, registered trademarks, and product names are the property of their respective owners and are used herein for identification purposes only.

## Notice of Copyright

*RS Series User Manual* © 2014 AMETEK Programmable Power, Inc. All rights reserved.

## Exclusion for Documentation

UNLESS SPECIFICALLY AGREED TO IN WRITING, AMETEK PROGRAMMABLE POWER, INC. ("AMETEK"):

- (a) MAKES NO WARRANTY AS TO THE ACCURACY, SUFFICIENCY OR SUITABILITY OF ANY TECHNICAL OR OTHER INFORMATION PROVIDED IN ITS MANUALS OR OTHER DOCUMENTATION.
- (b) ASSUMES NO RESPONSIBILITY OR LIABILITY FOR LOSSES, DAMAGES, COSTS OR EXPENSES, WHETHER SPECIAL, DIRECT, INDIRECT, CONSEQUENTIAL OR INCIDENTAL, WHICH MIGHT ARISE OUT OF THE USE OF SUCH INFORMATION. THE USE OF ANY SUCH INFORMATION WILL BE ENTIRELY AT THE USER'S RISK, AND
- (c) REMINDS YOU THAT IF THIS MANUAL IS IN ANY LANGUAGE OTHER THAN ENGLISH, ALTHOUGH STEPS HAVE BEEN TAKEN TO MAINTAIN THE ACCURACY OF THE TRANSLATION, THE ACCURACY CANNOT BE GUARANTEED. APPROVED AMETEK CONTENT IS CONTAINED WITH THE ENGLISH LANGUAGE VERSION, WHICH IS POSTED AT [WWW.PROGRAMMABLEPOWER.COM](http://WWW.PROGRAMMABLEPOWER.COM).

## Date and Revision

May 2014, Revision D

## Part Number

M440036

## Contact Information

Telephone: 800 733 5427 (toll free in North America)  
858 450 0085 (direct)



Fax: 858 458 0267

Email: [sales.ppd@ametek.com](mailto:sales.ppd@ametek.com)  
[service.ppd@ametek.com](mailto:service.ppd@ametek.com)

Web: [www.programmablepower.com](http://www.programmablepower.com)

# Important Safety Instructions

Before applying power to the system, verify that your product is configured properly for your particular application.

 WARNING	<p><b>Hazardous voltages may be present when covers are removed. Qualified personnel must use extreme caution when servicing this equipment. Circuit boards, test points, and output voltages also may be floating above (below) chassis ground.</b></p>
 WARNING	<p><b>The equipment used contains ESD sensitive parts. When installing equipment, follow ESD Safety Procedures. Electrostatic discharges might cause damage to the equipment.</b></p>

Only *qualified personnel* who deal with attendant hazards in power supplies, are allowed to perform installation and servicing.

Ensure that the AC power line ground is connected properly to the Power Rack input connector or chassis. Similarly, other power ground lines including those to application and maintenance equipment *must* be grounded properly for both personnel and equipment safety.













Always ensure that facility AC input power is de-energized prior to connecting or disconnecting any cable.

In normal operation, the operator does not have access to hazardous voltages within the chassis. However, depending on the user's application configuration, **HIGH VOLTAGES HAZARDOUS TO HUMAN SAFETY** may be normally generated on the output terminals. The customer/user must ensure that the output power lines are labeled properly as to the safety hazards and that any inadvertent contact with hazardous voltages is eliminated.

Guard against risks of electrical shock during open cover checks by not touching any portion of the electrical circuits. Even when power is off, capacitors may retain an electrical charge. Use safety glasses during open cover checks to avoid personal injury by any sudden component failure.

Neither AMETEK Programmable Power Inc., San Diego, California, USA, nor any of the subsidiary sales organizations can accept any responsibility for personnel, material or inconsequential injury, loss or damage that results from improper use of the equipment and accessories.

## SAFETY SYMBOLS

 WARNING Risk of Electrical Shock	 CAUTION Refer to Accompanying Documents
 Off (Supply)	 Direct Current (DC)
 Standby (Supply)	 Alternating Current (AC)
 On (Supply)	 Three-Phase Alternating Current
 Protective Conductor Terminal	 Earth (Ground) Terminal
 Fuse	 Chassis Ground

**Product Family: RS Series AC Power Source****Warranty Period: 1 Year****WARRANTY TERMS**

AMETEK Programmable Power, Inc. ("AMETEK"), provides this written warranty covering the Product stated above, and if the Buyer discovers and notifies AMETEK in writing of any defect in material or workmanship within the applicable warranty period stated above, then AMETEK may, at its option: repair or replace the Product; or issue a credit note for the defective Product; or provide the Buyer with replacement parts for the Product.

The Buyer will, at its expense, return the defective Product or parts thereof to AMETEK in accordance with the return procedure specified below. AMETEK will, at its expense, deliver the repaired or replaced Product or parts to the Buyer. Any warranty of AMETEK will not apply if the Buyer is in default under the Purchase Order Agreement or where the Product or any part thereof:

- is damaged by misuse, accident, negligence or failure to maintain the same as specified or required by AMETEK;
- is damaged by modifications, alterations or attachments thereto which are not authorized by AMETEK;
- is installed or operated contrary to the instructions of AMETEK;
- is opened, modified or disassembled in any way without AMETEK's consent; or
- is used in combination with items, articles or materials not authorized by AMETEK.

The Buyer may not assert any claim that the Products are not in conformity with any warranty until the Buyer has made all payments to AMETEK provided for in the Purchase Order Agreement.

**PRODUCT RETURN PROCEDURE**

Request a Return Material Authorization (RMA) number from the repair facility (**must be done in the country in which it was purchased**):

- **In the USA**, contact the AMETEK Repair Department prior to the return of the product to AMETEK for repair:  
Telephone: 800-733-5427, ext. 2295 or ext. 2463 (toll free North America)  
858-450-0085, ext. 2295 or ext. 2463 (direct)
- **Outside the United States**, contact the nearest Authorized Service Center (ASC). A full listing can be found either through your local distributor or our website, [www.programmablepower.com](http://www.programmablepower.com), by clicking Support and going to the Service Centers tab.

When requesting an RMA, have the following information ready:

- Model number
- Serial number
- Description of the problem

**NOTE:** Unauthorized returns will not be accepted and will be returned at the shipper's expense.

**NOTE:** A returned product found upon inspection by AMETEK, to be in specification is subject to an evaluation fee and applicable freight charges.

## Table of Contents

---

1.	Introduction .....	11
1.1	General Description .....	11
1.2	Manual organization and format .....	11
2.	Specifications .....	12
2.1	Electrical .....	12
2.2	Mechanical .....	20
2.3	Environmental .....	21
2.4	Regulatory .....	21
2.5	Front Panel Controls .....	21
2.6	Special Features and Options .....	22
2.7	Supplemental Specifications .....	30
3.	Unpacking and Installation .....	31
3.1	Unpacking .....	31
3.2	Power Requirements .....	31
3.3	Mechanical Installation .....	33
3.4	AC Input Connections and Wiring .....	33
3.5	AC On/Off Circuit Breaker on RS Series front panel .....	36
3.6	Output Connections .....	38
3.7	Connectors - Rear Panel .....	45
3.8	Multiple Cabinet System Configurations (incl. –MB) .....	52
3.9	Multiple Cabinet Power Up/Down Procedures .....	54
3.10	Clock and Lock Configurations .....	55
3.11	Basic Initial Functional Test .....	57
3.12	Remote Inhibit / Remote Shutdown .....	59
3.13	Junction Box Accessory TBD .....	60
4.	Front Panel Operation .....	61
4.1	Tour of the Front Panel .....	61
4.2	Menu Structure .....	68
4.3	Output Programming .....	105
4.4	Waveform Management [3Pi Controller only] .....	106
4.5	Standard Measurements .....	111
4.6	Advanced Measurements [3Pi Controller only] .....	113
4.7	Transient Programming .....	122
5.	Principle of Operation .....	129
5.1	General .....	129
5.2	Overall Description .....	130
5.3	Controller Assembly .....	131
5.4	System Interface Board .....	134
5.5	Current / Voltage Sensor Board .....	134
5.6	Low Voltage Power Supply .....	134
5.7	Power Module .....	135
6.	Calibration .....	140
6.1	Recommended Calibration Equipment .....	140
6.2	Front Panel Calibration Screens .....	141
6.3	Routine Measurement Calibration .....	143
6.4	Routine Output Calibration .....	148
6.5	Non-Routine Calibration .....	154

7. Service .....	156
7.1 Cleaning .....	156
7.2 General .....	156
7.3 Basic operation .....	156
7.4 Advanced Troubleshooting .....	158
7.5 Factory Assistance .....	160
7.6 Fuses .....	161
7.7 Firmware Updates .....	162
8. Top Assembly Replaceable Parts .....	165
9. Options .....	167
9.1 Introduction .....	167
9.2 Option -HV: Additional AC Voltage Range .....	168
9.3 Option -160: RTCA/DO-160 Tests .....	169
9.4 Option -411: IEC 61000-4-11 Voltage Dips and Interruptions .....	183
9.5 Option -413: IEC 61000-4-13 Interharmonics Test .....	191
9.6 Option -704: MilStd704 Tests .....	202
9.7 Option -ABD: Airbus ABD0100.1.8 Test .....	214
9.8 Option -AMD: Airbus AMD24C Test .....	214
9.9 Option -787: Boeing B787-0147 Test .....	214
9.10 Option -WHM: Watt Hour Measurement .....	215
9.11 Option -SNK: Current Sink .....	217
9.12 Option -EXTD: External drive .....	220
10. Error Messages .....	2201
Index .....	2266

## List of Figures

Figure 2-1: RS90 Voltage / Current Rating Chart for 150/300 V AC Ranges – Max Rating .....	15
Figure 2-2: Voltage / Current Rating Chart for 150/300 V AC Ranges – Derated .....	16
Figure 2-3: RS90 Voltage / Current Rating Chart for 200/400 V DC Ranges – Max. Rating .....	16
Figure 2-4: Voltage / Current Rating Chart for 200/400 V DC Ranges – Derated .....	17
Figure 2-5: RS90 Voltage / Current Rating Chart, -HV Option – Max. Rating .....	25
Figure 2-6: RS90 Voltage / Current Rating Chart, -HV Option – Derated .....	25
Figure 2-7: -HF Option Voltage Frequency Rating 300V range .....	27
Figure 2-8: -HF Option Voltage Frequency Rating 150V range .....	27
Figure 3-1: RS90 Power Source Photo .....	31
Figure 3-2: Location of AC Input Connection Block (TB3) and Chassis Ground Connection .....	34
Figure 3-3: RS Series AC Input Connection Diagram (Rear view) .....	35
Figure 3-4: Rear Panel – External Sense connector location .....	37
Figure 3-5: External sense cable shield connection to chassis ground .....	38
Figure 3-6: Location of Output Terminals (Rear view) .....	40
Figure 3-7: RS90 Output Wiring (Rear panel view) .....	41
Figure 3-8: RS180 or RS180-MB Output Wiring (Rear view) .....	42
Figure 3-9: Two RS90's in Clock and Lock mode Output Wiring (Rear view) .....	43
Figure 3-10: Ship kit Terminal Block dimensions TBD adjust .....	44
Figure 3-11: USB Connector pin orientation .....	49
Figure 3-12: Emergency Switch (ES Option) shut off inter connect on -MB systems .....	51
Figure 3-13: Multi-Cabinet DIP Switch Location and Setting - TBD .....	53
Figure 3-14: Functional Test Setup .....	58
Figure 3-15: 7003-416-1 Output Junction Box .....	60
Figure 4-1: Shuttle Knob .....	63
Figure 4-2: FUNCTION Keypad .....	64
Figure 4-3: Entering Values from the Decimal Keypad .....	66
Figure 4-4: Cursor UP Key Movement .....	66
Figure 4-5: Cursor DOWN key Movement .....	67
Figure 4-6: Main Menu 1 Screen .....	67
Figure 4-7: Menu 1 through 3 .....	68
Figure 4-8: PROGRAM Menu .....	72
Figure 4-9: MEASUREMENTS Screen, Single Phase and Three Phase Modes .....	74
Figure 4-10: HARMONICS/TRACE ANALYSIS Screen .....	76
Figure 4-11: TRANSIENTS Menu .....	79
Figure 4-12: VOLTAGE SURGE/SAG SETUP Screen .....	80
Figure 4-13: VOLTAGE SWEEP/STEP SETUP Screen .....	82
Figure 4-14: FREQUENCY SWEEP/STEP SETUP Screen .....	84
Figure 4-15: VOLTAGE/FREQUENCY SWEEP/STEP SETUP Screen .....	85
Figure 4-16: START/VIEW TRANSIENT SEQUENCE Screen .....	86
Figure 4-17: WAVEFORMS Menu .....	87
Figure 4-18: APPLICATIONS Menus .....	90
Figure 4-19: SETUP REGISTERS Menu .....	91
Figure 4-20: UTILITY Menus .....	92
Figure 4-21: GPIB/RS232 SETUP Menu .....	95
Figure 4-22: VOLTAGE/CURRENT CONTROL SETUP Menu .....	96
Figure 4-23: INITIAL SETUP Menus .....	97
Figure 4-24: LIMIT SETUP Menu .....	99
Figure 4-25: CONFIGURATION SETUP Menus .....	100
Figure 4-26: MEASUREMENT CAL FACTORS Menu .....	103
Figure 4-27: OUTPUT CAL FACTORS Menu (Series II only) .....	104
Figure 4-28: Selecting a Waveform .....	107
Figure 4-29: Selecting Waveforms for Single Phase or All Phases .....	107
Figure 4-30: Custom Waveform Creation with GUI Program .....	108
Figure 4-31: Waveform Crest Factor Affects Max. rms Voltage .....	109
Figure 4-32: Waveform Frequency Domain View Mode .....	110
Figure 4-33: Scrolling Through Tabular FFT Data .....	114
Figure 4-34: Scrolling through bar chart FFT Data .....	114
Figure 4-35: Scrolling Through Acquired Waveform Data .....	116
Figure 4-36: SET VOLT Trigger Source Acquisition .....	118
Figure 4-37: Positive Trigger Delay (Post Trigger Data) .....	120
Figure 4-38: Negative Trigger Delay (Pre-Trigger Data) .....	121
Figure 4-39: Pulse Transients .....	123
Figure 4-40: List Transients .....	124
Figure 4-41: Switching Waveforms in a Transient List .....	127
Figure 4-42: START/VIEW TRANSIENT SEQUENCE Menu .....	128
Figure 5-1: RS Series Functional Block Diagram .....	129
Figure 5-2: RS Series Detailed Block Diagram .....	132



Figure 5-3: Power Module Detailed Block Diagram .....	133
Figure 5-4: Power Module Layout .....	135
Figure 5-5: Amplifier Board Layout .....	137
Figure 6-1: Voltage Calibration Setup RS90 (Rear view).....	142
Figure 6-2: Current Measurement Calibration Setup (Rear view).....	144
Figure 6-3: DC offset AC filter .....	148
Figure 6-4: -413 Option Aux Generator Adjustments - TBD .....	152
Figure 9-1: Application Menu .....	170
Figure 9-2: DO160 Main Menu.....	171
Figure 9-3: Normal State.....	171
Figure 9-4: Voltage Modulation .....	173
Figure 9-5: Frequency Modulation .....	174
Figure 9-6: Power Interrupt .....	175
Figure 9-7: Power Interrupt for Group 2 and 3 .....	176
Figure 9-8: Emergency Screen .....	177
Figure 9-9: Abnormal Screen .....	178
Figure 9-10: DO-160 DC Main Menu .....	180
Figure 9-11: Normal State.....	180
Figure 9-12: Abnormal State .....	181
Figure 9-13: Application Menu .....	185
Figure 9-14: IEC1000-4-11 Menu .....	185
Figure 9-15: IEC Dips and Interrupts .....	186
Figure 9-16: Voltage Variation Screen .....	188
Figure 9-17: EN 61000-4-11 Voltage Variation specification- Edition 1.0 .....	189
Figure 9-18: EN 61000-4-11 Voltage Variation specification- Edition 2.0 .....	189
Figure 9-19: IEC 61000-4-11 GUI screen. ....	190
Figure 9-20: Application Setup Menus .....	192
Figure 9-21: IEC1000-4-13 Menu .....	192
Figure 9-22: IEC 1000-4-13 FCURVE.....	194
Figure 9-23: IEC 1000-4-13 OSWING .....	194
Figure 9-24: IEC 1000-4-13 SWEEP .....	195
Figure 9-25: IEC 1000-4-13 Harmonics .....	195
Figure 9-26: IEC 1000-4-13 INTERHARMONICS.....	196
Figure 9-27: IEC 61000-4-13 Meister Curve .....	196
Figure 9-28: IEC 61000-4-13 Test Flowchart Class 1 and 2.....	198
Figure 9-29: IEC 61000-4-13 Test Flowchart Class 3.....	199
Figure 9-30: MENU 2 SCREEN .....	201
Figure 9-31: INTERHARMONICS SCREEN .....	201
Figure 9-32: Application Menu .....	204
Figure 9-33: MIL704 Menu .....	204
Figure 9-34: Steady State Menu .....	205
Figure 9-35: Transient Menu.....	207
Figure 9-36: Emergency Menu.....	208
Figure 9-37: Abnormal Screen .....	209
Figure 9-38: MIL704 DC Menu.....	210
Figure 9-39: Steady State DC .....	210
Figure 9-40: Transient Menu.....	211
Figure 9-41: Abnormal Test Screen .....	212
Figure 9-42: Emergency Test.....	213
Figure 9-43: Application Screen.....	215
Figure 9-44: Watt-Hour Meter Screen.....	215
Figure 9-45: WH-Meter Screen with Function Active .....	215
Figure 9-46: REGENERATE CONTROL screen.....	218

## List of Tables

Table 3-1: Suggested Input Wiring Sizes for each RS Cabinet *	36
Table 3-2: Suggested Output Wiring Sizes*	39
Table 3-3: Output Terminal connections	40
Table 3-4: System Interface Connectors	46
Table 3-5: Analog Interface Connector	46
Table 3-6: BNC Connectors	47
Table 3-7: BNC Connectors	47
Table 3-8: External Sense Connector	47
Table 3-9: RS232 Connector pin out – RS with RS232 and USB	48
Table 3-10: USB Connector pin out	49
Table 3-11: RJ45 LAN Connector pin out	50
Table 3-12: Clock and Lock Configuration settings	55
Table 3-13: Clock and Lock Initialization settings	56
Table 3-14: Remote Inhibit Mode Settings	59
Table 6-1: Calibration Load Values	145
Table 6-2: Measurement Calibration Table - TBD	147
Table 6-3: Output Calibration Table – RS Series	153
Table 7-1: Basic Symptoms	156
Table 7-2: RS Fuse Ratings	161
Table 7-3: Flash Down load Messages	164
Table 8-1& 8-2: Replaceable Parts & Fuses	166
Table 9-1: Normal Voltage and Frequency Minimum	171
Table 9-2: Normal Voltage and Frequency Maximum	172
Table 9-3: Normal Voltage Unbalance	172
Table 9-4: Normal VoltageSurge Sequence	176
Table 9-5: Normal Frequency Transient Sequence	177
Table 9-6: Normal Frequency Variation Sequence	177
Table 9-7: Emergency Voltage and Frequency Minimum	178
Table 9-8: Emergency Voltage and Frequency Maximum	178
Table 9-9: Emergency Voltage Unbalance	178
Table 9-10: Abnormal Voltage Minimum	179
Table 9-11: Abnormal Voltage Maximum	179
Table 9-12: Abnormal Frequency Transient	179
Table 9-13: Normal Voltage Minimum	180
Table 9-14: Normal Voltage Maximum	180
Table 9-15: Voltage Surge	181
Table 9-16: Abnormal Voltage Surge	182
Table 9-17: Phase mapping	184
Table 9-18: IEC 61000-3-34 Table C.2	184
Table 9-19: Dips and Interruptions Tests Performed During RUN ALL	186
Table 9-20: Voltage Variations Test Performed During RUN ALL	188
Table 10-1: Error Messages	225

## 1. Introduction

---

This instruction manual contains information on the installation, operation, calibration and maintenance of all power systems that use the RS Series power sources with the programmable controller.

### 1.1 General Description

---

The RS Series AC and DC power source systems are high efficiency, floor standing AC and DC power sources that provide a precise output with low distortion. Available voltage ranges are 150 Vac, 300 Vac and 400 Vac in AC mode and 200 Vdc and 400 Vdc in DC mode. All models provide three-phase output mode in either AC, DC and AC+DC mode of operation. In DC mode, this implies there are three DC outputs with individual voltage programming on each output.

All RS-3Pi models provide features such as arbitrary waveform generation harmonics analysis, standard RS232C, USB, IEEE-488 interfaces and an available LAN option.

The RS Series units are contained in a floor standing enclosure on casters. This allows the units to be moved around more easily.

Read the installation instructions carefully before attempting to install and operate the RS Series power systems.

### 1.2 Manual organization and format

---

All user documentation for California Instruments power sources is provided on CDROM in electronic format. (Adobe Portable Document Format) The required Adobe PDF viewer is available for download from the [www.adobe.com](http://www.adobe.com) website. This manual may be printed for personal use if a hardcopy is desired. To request a hardcopy from AMETEK Programmable Power, contact customer service at [service.ppd@ametek.com](mailto:service.ppd@ametek.com) There will be a charge for printed manuals.

This manual contains sections on installation, normal use, maintenance and calibration. If the RS system is equipped with a GPIB, RS232C, USB or LAN interface, refer to the RS Programming manual for information on using the remote control interfaces and command syntax. The programming manual is provided on the same CDROM as this user manual.

## 2. Specifications

Specifications shown are valid over an ambient temperature range of  $25 \pm 5^\circ \text{C}$  and apply after a 30 minute warm-up time. Unless otherwise noted, all specifications are per phase for sine wave output into a resistive load. For three phase configurations or mode of operation, all specifications are for Line to Neutral (L-N) and phase angle specifications are valid under balanced load conditions only.

### 2.1 Electrical

#### 2.1.1 Input

Parameter	RS90	RS180	RS270	RS360	RS450	RS540
Line Voltage: (3 phase, 3 wire + ground (PE))	208 V <sub>LL</sub> ±10% 230 V <sub>LL</sub> ±10% 400 V <sub>LL</sub> ±10% 480 V <sub>LL</sub> ±10%					
Line VA:	106 KVA	212 KVA	318 KVA	424 KVA	530 KVA	636 KVA
Line Current:	350 A <sub>RMS</sub> @ 187 V <sub>LL</sub> 314 A <sub>RMS</sub> @ 207 V <sub>LL</sub> 180 A <sub>RMS</sub> @ 360 V <sub>LL</sub> 150 A <sub>RMS</sub> @ 432 V <sub>LL</sub>	Each RS90 chassis requires its own AC service.  Total Line currents are 2 x RS90	Each RS90 chassis requires its own AC service.  Total Line currents are 3 x RS90	Each RS90 chassis requires its own AC service.  Total Line currents are 4 x RS90	Each RS90 chassis requires its own AC service.  Total Line currents are 5 x RS90	Each RS90 chassis requires its own AC service.  Total Line currents are 6 x RS90
Line Frequency:	47-63 Hz					
Efficiency:	85 % (typical) depending on line and load					
Power Factor:	0.95 (typical) / 0.99 at full power.					
Inrush Current:	460 A <sub>pk</sub> @ 208 V <sub>LL</sub> 440A <sub>pk</sub> @ 230 V <sub>LL</sub> 264A <sub>pk</sub> @ 400 V <sub>LL</sub> 220A <sub>pk</sub> @ 480 V <sub>LL</sub>	Each RS90 chassis requires its own AC service.  Total Peak currents are 2 x RS90	Each RS90 chassis requires its own AC service.  Total Peak currents are 3 x RS90	Each RS90 chassis requires its own AC service.  Total Peak currents are 4 x RS90	Each RS90 chassis requires its own AC service.  Total Peak currents are 5 x RS90	Each RS90 chassis requires its own AC service.  Total Peak currents are 6 x RS90
Hold-Up Time:	> 10 ms					
Isolation Voltage:	2200 VAC input to output 1350 VAC input to chassis					

## 2.1.2 Output

**Note:** All specifications are for AC and DC unless otherwise indicated.

Output Parameter	RS90	RS180	RS270	RS360	RS450	RS540
<b>Modes</b>	AC, DC, AC+DC					
<b>Voltage:</b>						
Ranges (L-N):						
AC Mode	Low: 0 - 150 V / High: 0 - 300 V					
DC Mode	Low: 0 - 200 V / High: 0 - 400 V					
AC+DC Mode	AC: Low: 0 - 150 V / High: 0 - 300 V DC Offset: Low Vrange: 0 - 150 V High Vrange: 0 - 220 V					
<b>Resolution:</b>						
AC Mode	0.1 V					
DC Mode	0.1 V					
AC+DC Mode	AC: 0.1 V DC Offset: 0.01 V					
<b>Accuracy:</b>	± 0.3 V < 100Hz, ± 0.6 V > 100Hz, AC mode ± 1 V DC mode From 5% Vrange to 100% of Vrange, RMS bandwidth < 10KHz					
Distortion THD <sup>1</sup> : (Resistive full load, normal mode)	< 0.5 % @ 16 - 66 Hz < 1.00 % @ 66 - 500 Hz < 1.25 % @ > 500 Hz					
Distortion THD <sup>1</sup> : (Resistive full load, Regenerative mode (-SNK))	< 1 % @ 16 - 66 Hz < 2 % @ 66 - 500 Hz < 3 % @ > 500 Hz					
<b>Load Regulation:</b>	0.25 % FS @ DC - 100 Hz 0.5 % FS @ > 100 Hz					
<b>Line Regulation:</b>	0.1% for 10% input line change					
<b>DC Offset Voltage:</b>	< 20 mV					
<b>Output Noise:</b> (20 kHz to 1 MHz)	< 2 V <sub>RMS</sub> low V Range < 3 V <sub>RMS</sub> high V Range					
<b>Output Coupling</b>	DC coupled Except on optional -HV or -XV Voltage range output, which is AC coupled.					
<b>Power</b> (total power for all phases, either range, at full scale voltage, maximum ambient T = 35° C)						
AC Mode	90 KVA	180 KVA	270 KVA	360 KVA	450 KVA	540 KVA
DC Mode	60 KW	120 KW	180 KW	240 KW	300 KW	360 KW
AC+DC Mode	The maximum power and current in the AC+DC mode is equal to that in the DC mode					
<b>Current</b>						
<b>Note:</b> Current, maximum amps indicated per phase available between 50 and 100 % of voltage range.						

<sup>1</sup> The distortion specification for the RS Series is valid for pure (inductance < 12 uH) resistive load conditions and using a 30 KHz LP filter on distortion meter.

Output Parameter	RS90	RS180	RS270	RS360	RS450	RS540
Maximum ambient temperature for full power operation at full-scale voltage is 35° C. <b>Constant Power Mode:</b> Operation at higher currents but constant power is possible from 80% of Voltage range (125% of max. current) declining to 100% of maximum current at 100 % of voltage range for short periods of time or at reduced ambient temperatures. (< 15 mins @ 30° C). See Figure 2-2 and Figure 2-4.						
AC Mode	RS90, per phase V Lo: 200A V Hi: 100A	RS90, per phase V Lo: 400A V Hi: 200A	RS90, per phase V Lo: 600A V Hi: 300A	RS90, per phase V Lo: 800A V Hi: 400A	RS90, per phase V Lo: 1000A V Hi: 500A	RS90, per phase V Lo: 1200A V Hi: 600A
DC Mode AC+DC Mode	RS90, per phase V Lo: 100A V Hi: 50A	RS90, per phase V Lo: 200A V Hi: 100A	RS90, per phase V Lo: 300A V Hi: 150A	RS90, per phase V Lo: 400A V Hi: 200A	RS90, per phase V Lo: 500A V Hi: 250A	RS90, per phase V Lo: 600A V Hi: 300A
Note: Current derates linearly from 50% of voltage range to 20% of specified current at 5% of voltage range						
Current Limit Accuracy	0.5% of full scale					
Current Limit mode	Programmable, CC or CV mode					
<b>Repetitive Peak Current</b> Note: Maximum Peak Current shown. Value shown reflects absolute peak current protection level. This level may not be reached under all load conditions. Depending on load conditions, peak current may max out at lower levels due to amplifier output impedance. Note: A repetitive peak current limit function is provided which will generate a fault and shut off the power supply if the peak current drawn by the load exceeds the maximum level for more than 30 seconds. During this time, the amplifier will limit the peak current at a somewhat level above the maximum level but it is not allowable to run in this mode indefinitely. This should provide sufficient time to ride through any startup/inrush load conditions.						
AC Mode	RS90, per phase V Lo: 600A V Hi: 300A	RS90, per phase V Lo: 1200A V Hi: 600A	RS90, per phase V Lo: 1800A V Hi: 900A	RS90, per phase V Lo: 2400A V Hi: 1200A	RS90, per phase V Lo: 3000A V Hi: 1500A	RS90, per phase V Lo: 3600A V Hi: 1800A
<b>Frequency</b>						
Range:	Standard: 16 Hz - 819.0 Hz (for -HV option range, 45 Hz – 819.0 Hz) -LF option: 16 Hz - 500.0 Hz -HF option: 16 Hz – 905 Hz					
Resolution:	0.01 Hz from 16.00 to 81.91 Hz 0.1 Hz from 82.0 to 819.0 Hz					
Accuracy:	± 0.01 % ±0.15 % for the FC option					
<b>Phase (3 phase mode)</b>						
Range:	Phase B/C relative to phase A 0.0 to 360.0°					
Resolution:	0.1°					
Accuracy:	16 Hz - 100 Hz: < 1.5° 100 Hz - 500 Hz: < 2° > 500 Hz: < 4°					

Output Parameter	RS90	RS180	RS270	RS360	RS450	RS540
<b>Ext. Sync Mode (not available with FC option)</b>						
Input:	Isolated TTL input for external frequency control. Requires 5V at 5 mA for logic high.					
Accuracy:	Ext. Sync to phase A with fixed Ext. Sync Frequency input: 16 Hz - 100 Hz: < 2° 100 Hz - 500 Hz: < 3° > 500 Hz: < 4°					

**Note:** Output specifications apply below the Current / Voltage rating lines shown in the V/I rating chart below.

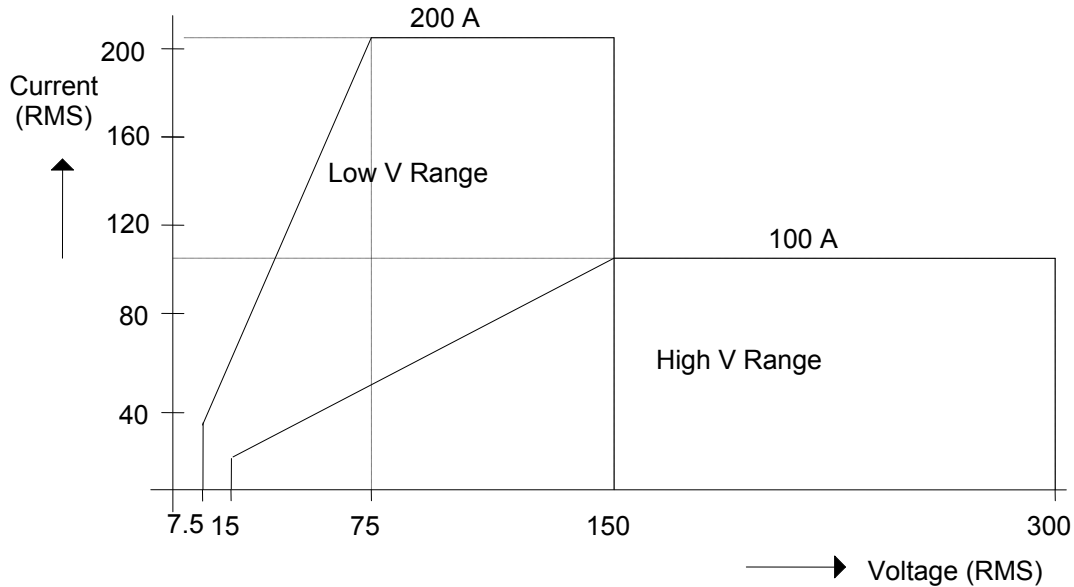

Figure 2-1: RS90 Voltage / Current Rating Chart for 150/300 V AC Ranges – Max Rating.

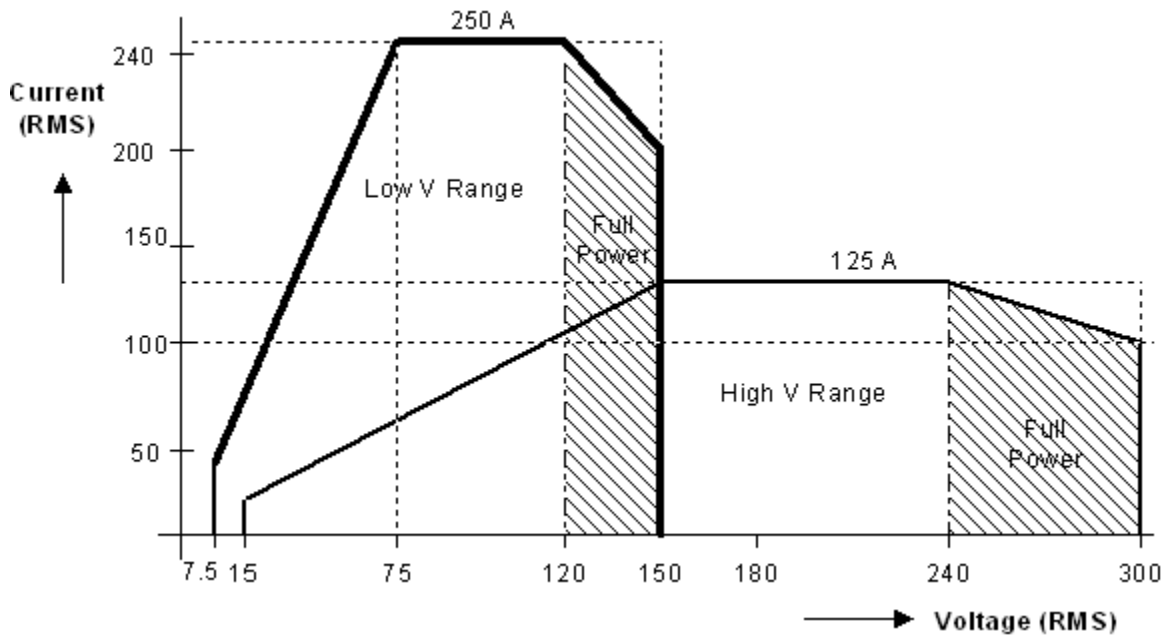

Figure 2-2: Voltage / Current Rating Chart for 150/300 V AC Ranges – Derated.

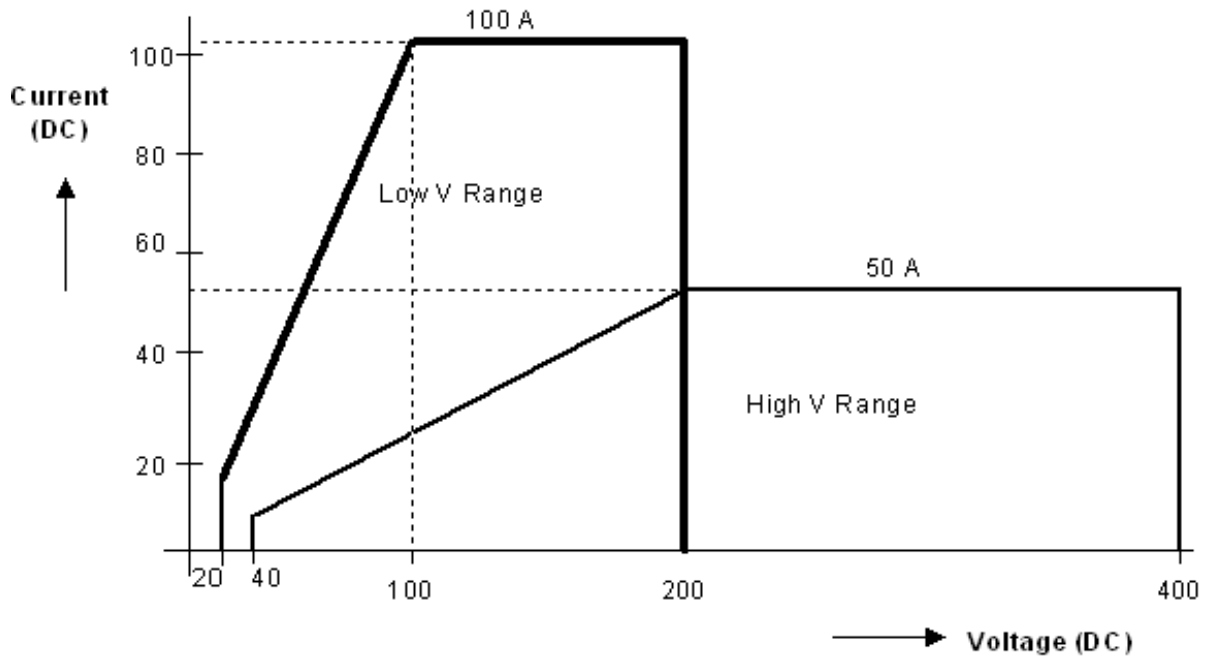

Figure 2-3: RS90 Voltage / Current Rating Chart for 200/400 V DC Ranges – Max. Rating



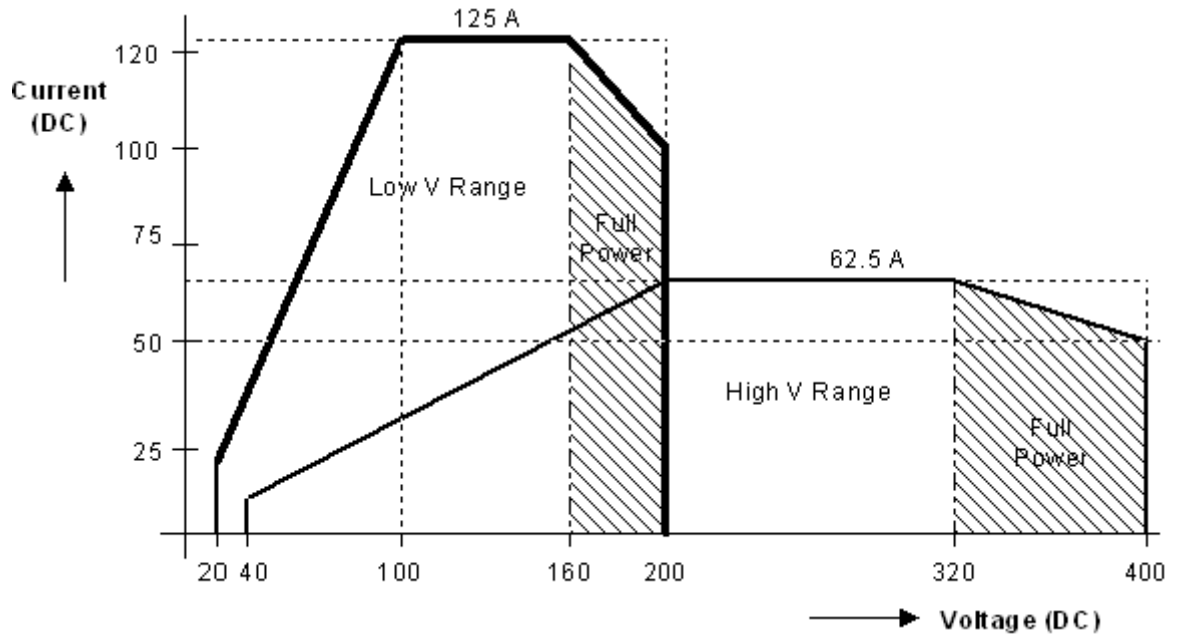

Figure 2-4: Voltage / Current Rating Chart for 200/400 V DC Ranges – Derated

### 2.1.3 AC Measurements

Measurement specifications apply to RS90 model only. See notes for other models and configurations.

Parameter	Range	Accuracy (±)	Resolution
Frequency	16.00 - 820.0 Hz	0.01% + 0.01 Hz ±0.15 % for the FC option	0.01 to 81.91 Hz 0.1 to 500 Hz 1 Hz above 500 Hz
RMS Voltage	0 - 300 Volts	0.1% FS, < 100 Hz 0.2% FS, > 100 Hz	0.01 Volt
RMS Current	0 - 250 Amps	0.5% FS, < 100 Hz 1.0% FS, > 100 Hz	0.1 Amp
Peak Current	0 - 750 Amps	2% FS, < 100 Hz 4% FS, > 100 Hz	0.1 Amp
VA Power	0 - 30 KVA	1% FS, < 100 Hz 2% FS, > 100 Hz	10 VA
Real Power	0 - 30 KW	1% FS, < 100 Hz 2% FS, > 100 Hz	10 W
Power Factor (>0.2kVA)	0.00 - 1.00	0.01, <100 Hz 0.02, 100-820 Hz	0.01

Note: Accuracy specifications are valid above 100 counts. For current and power measurements, specifications apply from 2% to 100% of measurement range.

Note: Power factor accuracy applies for PF > 0.5 and VA > 50 % of max.

### 2.1.4 DC Measurements

Parameter	Range	Accuracy ( $\pm$ )	Resolution
Voltage	0 - 400 Vdc	0.25% FS	0.1 Volt
Current	0 - 200 Adc	0.5% FS	0.01 Amp
Power	0 - 10 kW	1% FS	10 W
Note: Accuracy specifications are valid above 100 counts. For current and power measurements, specifications apply from 2% to 100% of measurement range.			

### 2.1.5 Harmonic Measurements

Harmonic measurement specifications apply to RS90-3Pi in three-phase mode. See notes for other models and configurations.

Parameter	Range	Accuracy ( $\pm$ )	Resolution
Frequency fundamental	16.00 - 820 Hz	0.03% + 0.03 Hz $\pm 0.15$ % for the FC option	0.01 Hz
Frequency harmonics			
	32.00 Hz – 16 KHz	0.03% + 0.03 Hz	0.01 Hz
Phase	0.0 - 360.0°	2° typ.	0.5°
Voltage	Fundamental	0.1% FS	0.01V
	Harmonic 2 - 50	0.1% + 0.1%/kHz FS	0.01V
Current	Fundamental	0.5% FS, < 100 Hz 1.0% FS, > 100 Hz	0.1A
	Harmonic 2 - 50	1.0% + 0.5%/kHz FS	0.1A
Note: For current measurements, specifications apply from 2% to 100% of measurement range.			

### 2.1.6 System Specification

Parameter	Specification
External Modulation:	0 to 10%
Synchronization Input:	Isolated TTL input for external frequency control. Requires 5V at 5 mA for logic high. <b>Note: Not available with FC option</b>
Trigger Input:	External trigger source input. Requires TTL level input signal. Triggers on negative edge. Response time 80 - 100 $\mu$ s.
Trigger Output:	Programmable through transient list system. 400 $\mu$ s pulse for voltage or frequency change. Isolated TTL output. Output reverts to Function strobe when not uses as Trig Out. This function is mutually exclusive with the Function Strobe output.
Function Strobe:	Active for any voltage or frequency program change. 400 $\mu$ s pulse for voltage or frequency change. Isolated TTL output. This function is mutually exclusive with the Trigger Output. Same output is used for Trigger Output if Trigger Output is programmed as part of list system.
Output Status:	Monitors status of output relay. Isolated TTL output. High if output relay is closed,

Parameter	Specification
	low if output relay is open.
Non volatile memory storage:	16 complete instrument setups and transient lists, 100 events per list.
Waveforms	Sine (Models with Standard controller) Sine, square, clipped, user defined (Models with Pi controller)
Transients	Voltage: drop, step, sag, surge, sweep Frequency: step, sag, surge, sweep Voltage and Frequency: step, sweep
IEEE-488 Interface:	SH1, AH1, T6, L3, SR1, RL2, DC1, DT1 Syntax: IEEE 488.2 and SCPI Response time is 10 ms (typical)
RS232C Interface:	Bi-directional serial interface 9 pin D-shell connector Handshake: CTS, RTS Data bits: 7, 8 Stop bits: 1,2 Baud rate: 9600 to 115,200 bps Syntax: IEEE 488.2 and SCPI. <b>Note:</b> Disconnect any USB connection when using the RS232 interface.
USB Interface:	Standard USB 1.1 peripheral. Data transfer rate: 460,800 bps Syntax: IEEE 488.2 and SCPI.  Note: Use of the USB port to control more than one power source from a single PC is not recommended, as communication may not be reliable. Use GPIB interface for multiple power source control.
LAN Interface:	Option –LAN. When the LAN interface is installed, the RS232 interface is disabled. RJ45 Connector, 10BaseT, 100BaseT or 1000BaseT, Data transfer rate: 460,800 bps Protocol: TCP/IP. Syntax: IEEE 488.2 and SCP <b>Note:</b> Disconnect any USB connection when using the LAN interface.
Current Limit Modes:	Two selectable modes of operation: 1. Constant current mode (voltage folds back with automatic recovery) 2. Constant voltage mode with trip-off (Relays open).

### 2.1.7 Unit Protection

Input Over current:	In-line fast acting fuses. Check fuse rating in Service and Maintenance section. Ratings will depend on AC input configuration settings. Circuit breaker for LV supply.
Input Over voltage:	Automatic shutdown.
Input Over voltage Transients:	Surge protection to withstand EN50082-1 (IEC 801-4, 5) levels.
Output Over current:	Adjustable level constant current mode with programmable set point.
Output Short Circuit:	Peak and RMS current limit.
Over temperature:	Automatic shutdown.

### 2.2 Mechanical

Parameter	Specification
Dimensions: (for each RS chassis)	Height: 74.5" 1892.3 mm Width: 30.3" 769.6 mm Depth: 38.3" 972.8 mm
Unit Weight: (for each RS chassis)	Net: 2150 lbs / 975 Kg approximately 2475 lbs / 1123 Kg approximately including –AV option Shipping: 2450 lbs / 1111 Kg approximately 2775 lbs / 1258 Kg approximately including –AV option
Material:	Steel chassis with aluminum panels and covers.
Finish:	Light textured painted external surfaces. Panels semi-gloss polyurethane color no. 26440 (medium gray)
Cooling:	Fan cooled with air intake on the front and exhaust to the rear. Fans: 14 x 225CFM. Air displacement 50 Cu Ft/sec. Max.
Internal Construction:	Modular sub assemblies.
Rear Panel Connections:	(See section 3 for description of connections) <ul style="list-style-type: none"> <li>• Cable entry and strain relieve for AC input wiring</li> <li>• Cable entry and strain relieve for output wiring</li> <li>• External sense terminal block (Remote voltage sense)</li> <li>• System interface (2x)</li> <li>• Clock and Lock BNC's (requires -LKM or -LKS options)</li> <li>• RS232, USB, GPIB, LAN (option)</li> <li>• Trigger In BNC</li> <li>• Trigger Out BNC</li> <li>• Function Strobe BNC</li> <li>• Output Status</li> </ul>

## 2.3 Environmental

Parameter	Specification
Operating Temp:	0° to +35° C. (Except in CP mode). +32° to +104° F.
Storage Temp:	-40° to +85 °C. -40° to +185° F.
Altitude:	< 2000 meters
Relative Humidity:	0-95 % RAH, non-condensing maximum for temperatures up to 31°C decreasing linearly to 50% at 40°C.
Installation/Over voltage Category:	II
Pollution Degree:	2
Indoor Use Only	
Vibration:	Designed to meet NSTA 1A transportation levels.
Shock:	Designed to meet NSTA 1A transportation levels.

## 2.4 Regulatory

Electromagnetic Emissions and Immunity:	Designed to meet EN50081-2 and EN50082-2 European Emissions and Immunity standards as required for the "CE" mark.
Acoustic Noise:	TBD 75 dBA maximum at 0% to 50% load, 80 dBA maximum greater than 50% load to 100% load. Measured at one meter.
Safety:	Designed to EN 61010-1 European safety standards as required for the "CE" mark.

## 2.5 Front Panel Controls

Controls:	
Shuttle knob:	Allows continuous change of all values including output calibration and range change.
Decimal keypad:	A conventional decimal keypad facilitates quick entry of numerical values such as voltage, current limit, etc. The large blue enter key will make the value you enter effective. Using the SET key allows the user to preset all parameter values and update them all at once by pressing the Enter key.
Up/down arrow keys:	A set of up and down arrow keys is used to move the cursor position in all menus. This allows quick selection of the desired function or parameter.
Function keys:	Measure key will display most measurement values. Program key will show all program parameters. Output on/off key for output relay control. Phase key will switch display to show program and measured values for each phase.

<b>Displays:</b>	
LCD graphics display:	A large high contrast LCD display with backlight provides easy to read guidance through all setup operations. An adjustable viewing angle makes it easy to read from all practical locations.
Status indicators:	Large and bright status indicators inform the user of important power source conditions. The Remote lamp informs the user that the unit is under remote control. The Overload lamp indicates that excessive current is being drawn at the output. The Over temperature lamp illuminates when internal heat sink temperatures are too high. The Hi Range indicator is lit any time the unit is switched to the high voltage range. The Output On/Off indicator is on when the power source output relays are closed.

## 2.6 Special Features and Options

<b>Controller Features</b>	
Parallel Operation:	Up to six RS90 units can be paralleled in a three-phase configuration (with one master controller and one to five auxiliary units). Only the master unit requires a controller in this setup. The auxiliary units are controlled through the system interface.
Clock and Lock Mode: (Option -LKM and -LKS required).	Three units (all with controllers) can be connected in a three-phase configuration using CLOCK and LOCK connections. Each unit requires its own controller in this configuration. One unit acts as the master and provides the reference clock to the auxiliary units. Note: This option cannot be combined with –HF option.
Controller:	Programmable controller front panel assembly.
Output Relay:	Standard output relay feature to isolate power source from the load.
Output On/Off:	The output relay can be used to quickly disconnect the load. A green status indicator displays the status of the output relay.
<b>Firmware / Software Options</b>	
- 704	Mil Std 704D & E test firmware.  Mil Std 704A, B, C, & F test software (refer to Avionics Software Manual P/N 4994-971 for details). Note: Requires use of RSGui Windows application software provided on CD ROM CIC496.
- 160	RTCA/DO-160D test firmware  RTCA/DO-160E test software (refer to Avionics Software Manual P/N 4994-971 for details).. Note: Requires use of RSGui Windows application software provided on CD ROM CIC496.
- 411	IEC 61000-4-11 test firmware (Pre-compliance)
- 413	IEC 61000-4-13 test firmware
-A350	Airbus A350 ABD0100.1.8.1 Test software (refer to Avionics Software Manual P/N 4994-971 for details).. Note: Requires use of RSGui Windows application software provided on CD ROM CIC496.
-ABD	Airbus A380 ABD0100.1.8 Test software (refer to Avionics Software Manual P/N 4994-971 for details).. Note: Requires use of RSGui Windows application software provided on CD ROM CIC496.

-AMD	Airbus AMD24C Test software (refer to Avionics Software Manual P/N 4994-971 for details).. Note: Requires use of RSGui Windows application software provided on CD ROM CIC496.
-B787	Boeing 787 Test software (refer to Avionics Software Manual P/N 4994-971 for details).. Note: Requires use of RSGui Windows application software provided on CD ROM CIC496.
-WHM	Watt Hour Measurements (Accuracy and Resolution. See Sec. 2.6.3.)
<b>Output Voltage Range Options</b>	
- HV	Adds 400 V AC only output range.
- XV	Adds customer specified AC only output range. Contact factory for details.
<b>Misc. Options</b>	
-ES	Emergency Shut off switch. This option key lock push button is installed on the front panel of the master RS if ordered with the RS system. When pushed in, the main AC contactor is opened disconnecting the AC input power to the RS input transformer. Note that the controller (and LCD display) will still be powered up but no power is available to the amplifiers and there will be no output power either. The controller runs off the LV supply, which must be turned off with the front panel breaker.  After the ES has been pushed, the provided key will be required to release it. Once the ES button has been released, the RS <b>must</b> be powered down using the front panel circuit breaker and turned back on to start up again.  <b>Note:</b> For multibox RS Systems (RS180 and up with more than one controller and front panel controls, each of which having an ES emergency switch, to connect a BNC cable between the cabinets for the ES connection. For 3 or more cabinets with controller, this BNC can be daisy chained using BNC T connectors.  <b>Note:</b> Do not misplace the 2 keys provided, as no duplicates are available from CI. If lost, the ES switch must be replaced. In that case, contact AMETEK Programmable Power customer service. ( <a href="mailto:service.ppd@ametek.com">service.ppd@ametek.com</a> ).
-HF	Increases maximum output frequency to 905 Hz. Note: This option cannot be combined with –LKM or –LKS option.
-LAN	Adds Ethernet interface (RJ45 connector) for local area network connection..
-LF	Limits maximum output frequency to 500 Hz.
-LKM	Clock and Lock system, Master. (Not available with –HF option)
-LKS	Clock and Lock system, Auxiliary. (Not available with –HF option)
-MB	Multi-box Option. Provides additional controllers in Auxiliary units of multi-cabinet configurations to allow individual RS90 units to be used stand-alone.
-SNK	Current Sink Option. Allows application of regenerative loads that feed energy (current, power) back into the RS output stage. The energy fed back is returned to the AC line (utility) feeding the RS.
-FC	Frequency control option. When enable, will cause the frequency to step $\pm 0.15\%$ around the program value.
<b>External Accessories</b> (External to RS chassis)	
7003-416-1	Input / Output wiring junction box. Connects two to six three-phase RS90 cabinet outputs, neutral and ground to a common output terminal block housed in a metal enclosure junction box. Can also be used to connect multiple RS chassis to common AC input service. See section 3.13 for details.

### 2.6.1 -HV Option Specifications

The -HV option provides an AC only output range of 0 to 400 Vac L-N. Specifications unique to the -HV option are shown in the table below.

Output Parameter	RS90	RS180	RS270	RS360	RS450	RS540
<b>Modes</b>						
Pi Controller	AC					
<b>Voltage:</b>						
Ranges (L-N):	0 -400 V					
Resolution:	0.1 V					
Accuracy:	$\pm 0.25\%$ of Full Scale / $\pm 1.0$ Vac rms					
Output Coupling	AC coupled					
<b>Power</b> (total power for all phases, either range, at full scale voltage)						
AC Mode	90 KVA	180 KVA	270 KVA	360 KVA	450 KVA	540 KVA
<b>Current</b>						
Note: Current, maximum amps per phase available between 50 and 100 % of voltage range.						
	75 A	150 A	225 A	300 A	375 A	450 A
<b>Peak Current</b>						
AC Mode	225 A	450 A	675 A	900 A	1125 A	1350 A
<b>Frequency:</b>						
Range:	45 Hz – 819 Hz with -LF option: 45 Hz – 500 Hz with -HF option: 45 Hz – 905 Hz (see also -HF option specification.)					



---

**Note:** Output specifications apply below the Current / Voltage rating lines shown in the V/I rating chart below.

---

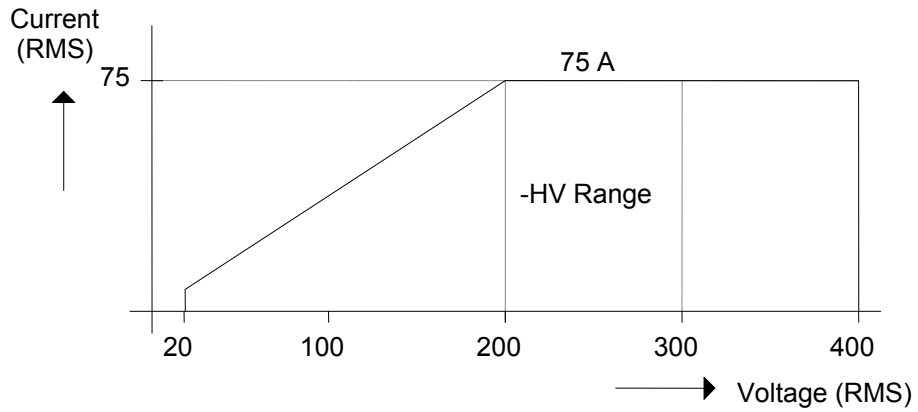

Figure 2-5: RS90 Voltage / Current Rating Chart, -HV Option – Max. Rating.

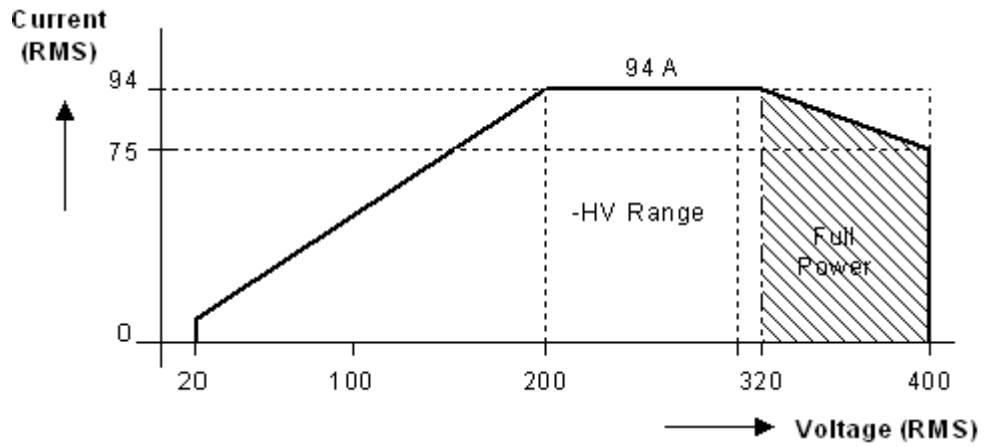

Figure 2-6: RS90 Voltage / Current Rating Chart, -HV Option – Derated.

### 2.6.2 -XV Option Specifications

Consult factory for -XV option specifications.

### 2.6.3 -HF Option Specifications

The -HF option extends the maximum available output frequency from 819 Hz to 905 Hz. Some restrictions are in effect at this increased output frequency level.

All other specifications of the RS system remain unchanged if this option is installed except as noted in the table below.

<b>-HF Option:</b>	
<b>Frequency</b>	
Range:	-HF option: 16 Hz - 905 Hz
Resolution:	0.01 Hz < from 16.00 to 81.92 Hz 0.1 Hz > from 82.0 to 819.2 Hz 1 Hz > from 820 to 905 Hz
Accuracy:	± 0.01 % ±0.15 % for the FC option
<b>Phase</b>	
Accuracy:	16 - 100 Hz: < 1.5° 100 - 500 Hz: < 2° 500 - 819 Hz: < 4° 819 - 905 Hz: < 5°
<b>Voltage</b>	
High Voltage Range	Maximum voltage at 905 Hz is 290 Vrms Maximum frequency at 300 Vrms is 875 Hz See Figure 2-7
Low Voltage Range	Maximum voltage at 905 Hz is 145 Vrms Maximum frequency at 150 Vrms is 875 Hz See Figure 2-8.
-HV Voltage Range	Maximum voltage at 905 Hz is 386 Vrms Maximum frequency at 400 Vrms is 875 Hz .
	Note: If the voltage or frequency settings shown here are exceeded for any length of time (> 1 sec), the RS may shut down generating an over temperature fault to protect itself.

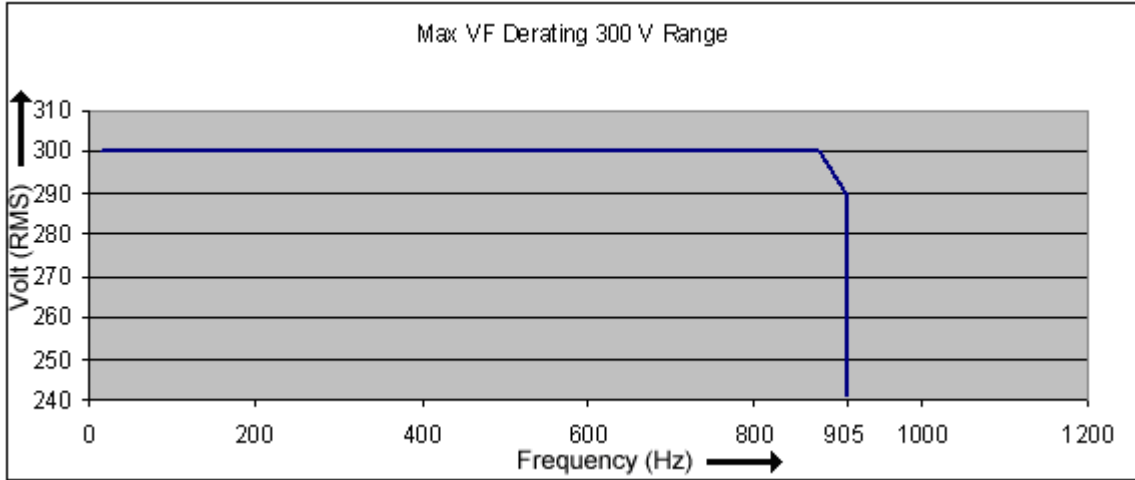

Figure 2-7: -HF Option Voltage Frequency Rating 300V range

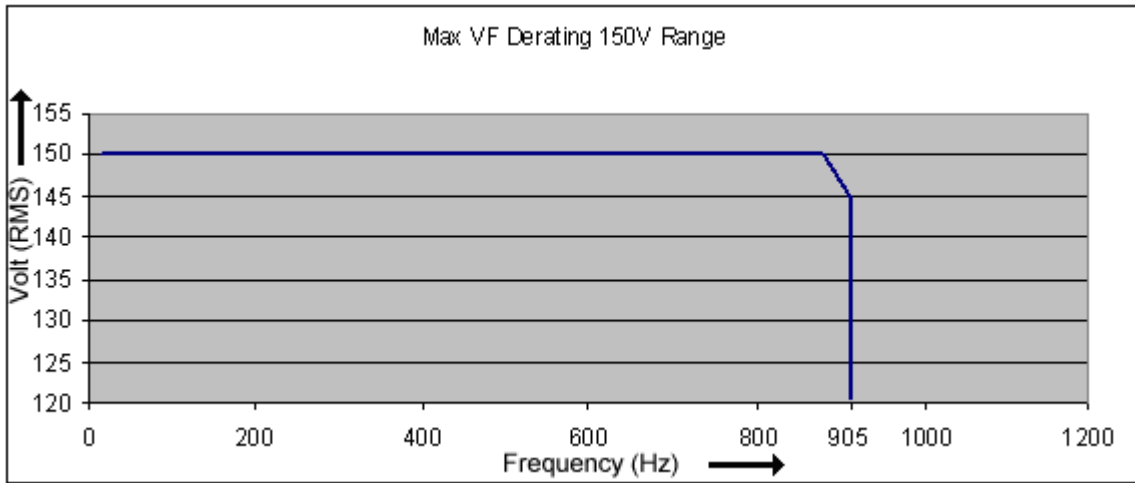

Figure 2-8: -HF Option Voltage Frequency Rating 150V range

**2.6.4 -LF Option Specifications**

---

The -LF option limits the maximum available output frequency to 500 Hz. All other specifications of the RS90 system remain unchanged if this option is installed.

**2.6.5 WHM Option Specifications**

---

Watt-hour measurement mode:

Accuracy:

0-6.000KW	0.01KWH + 0.1%	<100 Hz
	0.02KWH +0.1%	100-819 Hz
>6.000KW	Times three of the above specification	

Resolution:

0.001 KWH

### 2.6.6 SNK Option Specifications

The –SNK or current sink option enables the RS power source to sink current from the unit under test. This mode of operation is particularly useful when testing grid-tied products that feed energy back onto the grid. The ability of the RS to simulate the grid provides unique opportunities to test the EUT for compatibility to commonly occurring line anomalies like voltage and/or frequency fluctuations. Examples of these types of EUT are inverters (PV Solar, Wind) hybrid drive systems, regenerative breaks.

The SNK option requires special amplifiers that have a different control loop from the standard RS amplifiers. Consequently, the upper frequency limit of an RS configured with the –SNK option is 500Hz as opposed to the standard 819Hz. Also, the voltage distortion levels are slightly higher than on RS units without this option.

<b>-SNK Option:</b>	
<b>Frequency</b>	
Range:	-HF option: 16 Hz - 500 Hz
Resolution:	0.01 Hz < from 16.00 to 81.92 Hz 0.1 Hz > from 82.0 to 500.0 Hz
Accuracy:	± 0.01 % ±0.15 % for the FC option
<b>Phase</b>	
Accuracy:	16 - 100 Hz: < 1.5° 100 - 500 Hz: < 2°
<b>Voltage</b>	
Distortion THD <sup>1</sup> : (Resistive full load)	< 1 % @ 16 - 66 Hz < 2 % @ 66 - 500 Hz
<b>Power</b>	
Capability	Full power can be returned into RS as long as current does not exceed maximum current limit setting for selected range. See REGENERATE CONTROL screen for protection settings in REGEN mode.
Without –SNK option	RS units without the SNK will generate a warning message (Error 31) if power is regenerated by the load. If back driving continues, the RS will shut off (Error 32).
<b>Measurements</b>	
Power	Regenerated power is displayed with a negative sign to indicate direction of power flow.

All other specifications of the RS system remain unchanged if this option is installed.

<sup>1</sup> The distortion specification for the RS Series is valid for pure (inductance < 12  $\mu$ H) resistive load conditions and using a 30 KHz LP filter on distortion meter.

## 2.7 Supplemental Specifications

Supplemental specifications are not warranted and generally reflect typical performance characteristics. These characteristics have been checked on a type test basis only and are not verified on each unit shipped. They are provided for reference only.

### 2.7.1 Output

Output Parameter	RS90 – RS540
<b>Voltage:</b>	
Slew rate:	> 0.5 V/micro sec
Stability:	0.25 % over 24 hour period at constant line, load and temperature.
Settling time:	< 0.5 msec
<b>Frequency:</b>	
Temperature coefficient:	± 5ppm per degree C
Stability:	± 15 ppm per year
<b>Current:</b>	
Constant Power Mode:	Operation at higher currents but constant power is possible from 80% of Voltage range (125% of max. current) declining to 100% of maximum current at 100 % of voltage range for short periods of time or at reduced ambient temperatures. (< 15 mins @ 30° C). See Figure 2-2 and Figure 2-4. <b>Note:</b> This mode requires firmware revision 0.27 or higher.

### 2.7.2 Acoustic Noise Levels

Acoustic Noise:	Measured at a distance of one meter. (3 ft.)
Front	63 dBA at no load to 68 dBA at full load. (TBD verify)
Back	65 dBA at no load to 72 dBA at full load (TBD verify)

## 3. Unpacking and Installation

---

### 3.1 Unpacking

---

Inspect the unit for any possible shipping damage immediately upon receipt. If damage is evident, notify the carrier. **DO NOT** return an instrument to the factory without prior approval. Do not destroy the packing container until the unit has been inspected for damage in shipment. If possible, **retain the container** (wooden crate) in the event the system ever has to be returned to the factory for either repair or upgrades



**WARNING: This power source weighs approximately 2150 lbs / 975 Kg** approximately 2475 lbs / 1123 Kg. **Obtain adequate help when moving the unit. Make sure the location (floor) in which the RS Series unit(s) will be installed can support the weight of the unit(s).**

---

### 3.2 Power Requirements

---

The RS Series power Source has been designed to operate from a three-phase, three wire (Wye or Delta) AC input line. A protective earth connection is required as well. (PE).

Available three-phase input settings are 208 V<sub>LL</sub> (option -208), 230 V<sub>LL</sub> (option -230), 400 V<sub>LL</sub> (option -400), or 480 V<sub>LL</sub> (option -480).



Figure 3-1: RS90 Power Source Photo



***CAUTION: Do not connect 400 or 480V into a unit set for 208 or 230V unit, the result could be a severely damaged unit. Always check the input rating on the model number tag before connecting AC input power. Consult factory if input settings have to be changed.***

---



---

### 3.3 Mechanical Installation

---

The RS's are completely self-contained power sources. They are to be used free standing on a solid surface. The units are fan cooled, drawing air in from the front and exhausting at the rear. The front and back of each unit must be kept clear of obstruction and a 6" clearance must be maintained to the rear. Special consideration of overall airflow characteristics and the resultant internal heat rise must be considered at all times to avoid self heating and over temperature problems.

---

### 3.4 AC Input Connections and Wiring

---

Three-phase Delta or Y AC input voltage of sufficient amperage (consult AC input specifications for maximum AC current per phase) is required to power the RS Series.

---

**Note:** *AC power should be routed through a properly sized and rated three-phase PROTECTIVE CIRCUIT BREAKER or similar branch circuit protection device with disconnect capability. This will protect building wiring and other circuits from possible damage or shutdown in case of a system problem. It will also facilitate removing AC input power to the RS system in case of service or reconfiguration requirements.*

---

---

**Note:** *AC input wiring and connections must conform to local electrical safety codes that apply. Always consult a qualified electrician prior to installation of any RS System.*

---

AC input connections are to be made directly to the input fuse block. The input fuse block is located on the lower left hand corner of the front of the RS chassis. To access the input fuse connection block, the protective front cover needs to be removed first.



**CAUTION:** *Always disconnect any input power completely when removing any protective cover and allow the internal capacitors to fully discharge (minimum of 15 mins) before removing any cover.) See Figure 3-2 for details.*

---

No wiring for AC input connections is provided with the RS Series and must be provided by the end user or installer. Input wiring should be entered through the right hand side (when facing the back of the RS cabinet, see Figure 3-4) wire access opening located at the rear bottom of the RS chassis. A wire channel (marked as [2] in figure below) is provided below the input transformer to allow the input wiring to be routed to the front of the unit where the connections are to be made.



**WARNING:** *The power source's input connection wiring gage (size) must be sized for the maximum input current rating to ensure user safety and avoid possible power source damage, regardless of the actual output load.*

---

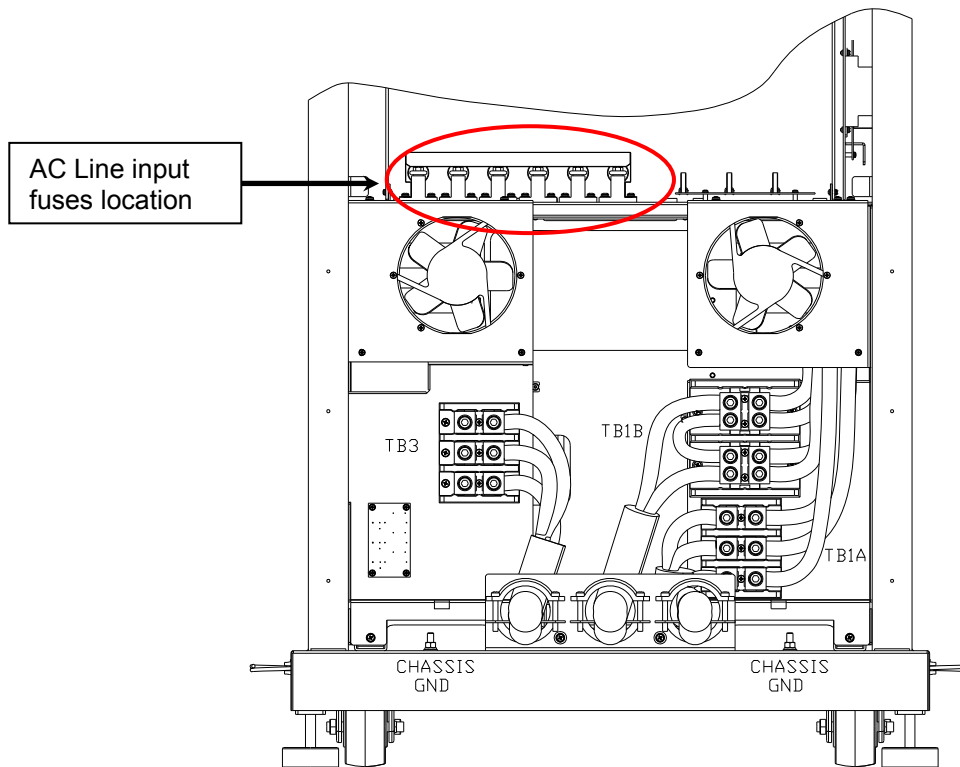

Figure 3-2: Location of AC Input Connection Block (TB3) and Chassis Ground Connection

**Note:** To comply with product safety requirements, **EARTH GROUND** must be connected to the chassis of the AC power system using the ground stud located directly below the AC input fuse block. Use a Green/Yellow ground wire.

**Note:** **DO NOT USE THE NEUTRAL CONNECTION OF A 3 PHASE Y AC POWER CONNECTION IN PLACE OF A TRUE EARTH GROUND CONNECTION. AC power system neutrals cannot be used for protective earth ground.**

The mains source must have a current rating equal to or greater than the input fuses and the input wiring must be sized to satisfy the applicable electrical codes. All covers must be re-installed prior to use and the strain relief provisions located at the rear bottom of the unit must be used to maintain protection against hazardous conditions.

**WARNING**

**DELTA INPUT WIRING CONNECTION ONLY.  
NO NEUTRAL CONNECTION IS NEEDED.**

**DO NOT USE AN AC NEUTRAL CONDUCTOR FOR  
GROUNDING THE CHASSIS. USE A SEPARATE  
PROTECTIVE EARTH GROUND CONNECTION ONLY.**

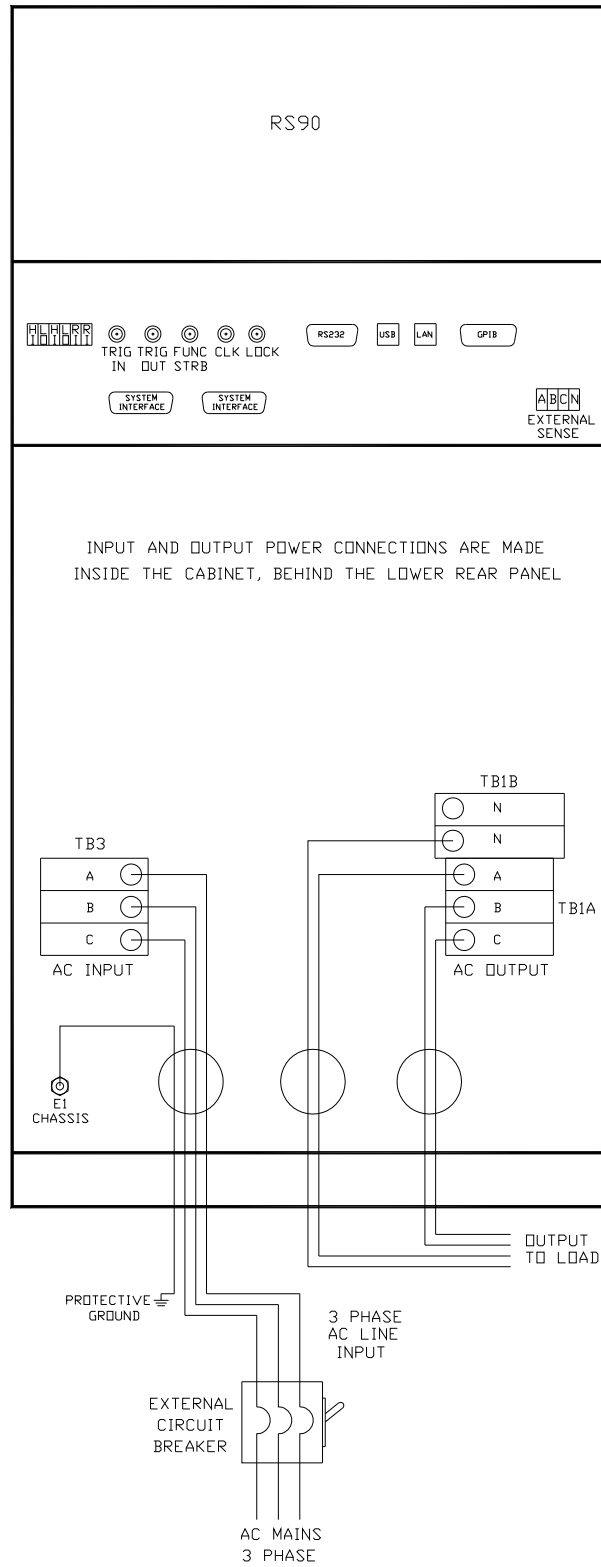

Figure 3-3: RS Series AC Input Connection Diagram (Rear view)

The input power cables and protective circuit breaker used must be large enough to handle the input current and input voltage of the power source and must conform to local electrical codes. Consult a qualified electrician prior to installation. Table 3-1 shows the size of the cables that may be used per RS cabinet. Note that wires must be sized to accommodate the worst-case maximum current that may occur under low line conditions. Local electrical codes may also require different wire types and sizes. These ratings should also be used when selecting a circuit breaker or equivalent disconnect device.

Cable lengths must not exceed twenty-five (25) feet. For lengths greater than 25 feet, calculate the voltage drop from the following formula:

$$2 \times \text{DISTANCE} \times \text{CABLE RESISTANCE PER FT.} \times \text{CURRENT} = \text{VOLT DROP}$$

Table 3-1: Suggested Input Wiring Sizes for each RS Cabinet \*

Nominal Line Voltage	Load Current @ low line	Wire Gauge (US)	Circular Mils (Kcmils)	Metric (mm <sup>2</sup> )
480 V	150 A <sub>RMS</sub>	2 AWG	66.4	33.6
400 V	180 A <sub>RMS</sub>	1 AWG	83.7	42.4
230 V	314 A <sub>RMS</sub>	3/0 AWG	168.0	85.0
208 V	350 A <sub>RMS</sub>	4/0 AWG	212.0	107.0

\* Data shown for use of high temperature (100° C) rated stranded copper wire, unbundled and not installed in conduit. Adjust wire gauge for Aluminum wire type. Always consult the National Electrical Code and/or local code regulations for proper rating and size of wire cabling prior to installation.



**CAUTION: Capacitors in the power source may hold a hazardous electrical charge even if the power source has been disconnected from the mains supply. Allow capacitors to discharge to a safe voltage before touching exposed pins of mains supply connectors. Power modules need at least 15 Minutes to discharge to safe levels before they can be removed.**

### 3.5 AC On/Off Circuit Breaker on RS Series front panel.

It is important to understand the purpose and operation of the On/Off circuit breaker of the RS Series located on the lower left side of the front panel. This is a 2A rated breaker that is used to engage and protect the two LV Power supplies of the RS chassis only. The LV Power supplies provides DC bias power to the entire RS system. The AC input power is routed through a set of three AC line fuses (F1, F2 and F3) located in the lower rear left bottom corner of the RS. (See Figure 3-2 for fuse locations). These fuses protect the three RS amplifiers and the AC input transformer from excessive input currents. The AC input power is connected to the input transformer through a large three-pole contactor. Removing AC power to the LV Power Supply by opening the front panel circuit breaker (moving the lever to the down (OFF) position) will cause this contactor to loose its coil voltage and will result in it opening and disconnecting the input transformer and amplifier from AC mains input.

**Note: If any RS system failure has occurred on any part of the RS system, AC input power must be removed immediately and not restored until the system has been inspected by a qualifier service technician. Always turn off the On/Off Circuit breaker before re-applying AC input power.**



**CAUTION:** The AC input fuses can only be checked is the RS unit is completely de-energized and disconnected from any AC power input.

**Note:** Under no circumstances should AC input power be applied if one or more of the AC input line fuses have failed and opened up.

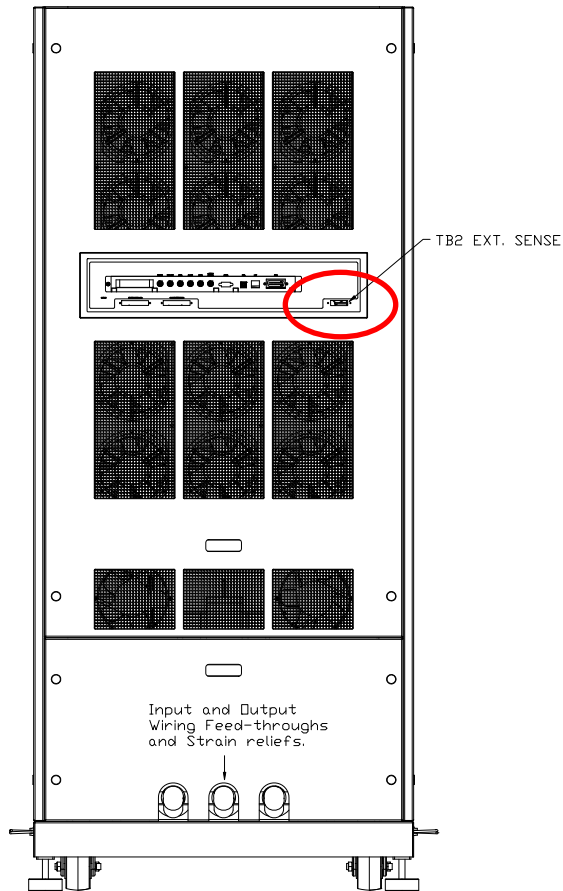

Figure 3-4: Rear Panel – External Sense connector location.

## 3.6 Output Connections

### 3.6.1 Output Wiring

The output terminal blocks, TB1A and TB1B are located at the lower rear of the unit behind the bottom access panel. See Figure 3-2 for details.

Three phase output line connections are made to terminal block TB1A. The phase outputs are labeled A, B and C. The neutral connection (if needed) can be made on terminal block TB1B. The neutral connection is always required to connect Y loads or for connecting a single phase load to Phase A only.

The external sense inputs allow the power system output voltages to be monitored directly at the load and must be connected at TB2 when the sense is programmed for external. The external sense input does not have to be connected when Internal Sense is programmed. The external sense wires are to be connected to TB2 on the rear panel and should be run using a twisted shielded cable. See Figure 3-4 for location of TB2 and Figure 3-5 for shield connection detail.

**Note:** *For External Sense connection, a shielded cable MUST be used with the shield connected to chassis ground at the Ext. Sense connector. (See Figure 3-5).*

External sense is recommended for multi-cabinet systems if the output wiring from the cabinets to the common output terminal block supplied is not of equal length.

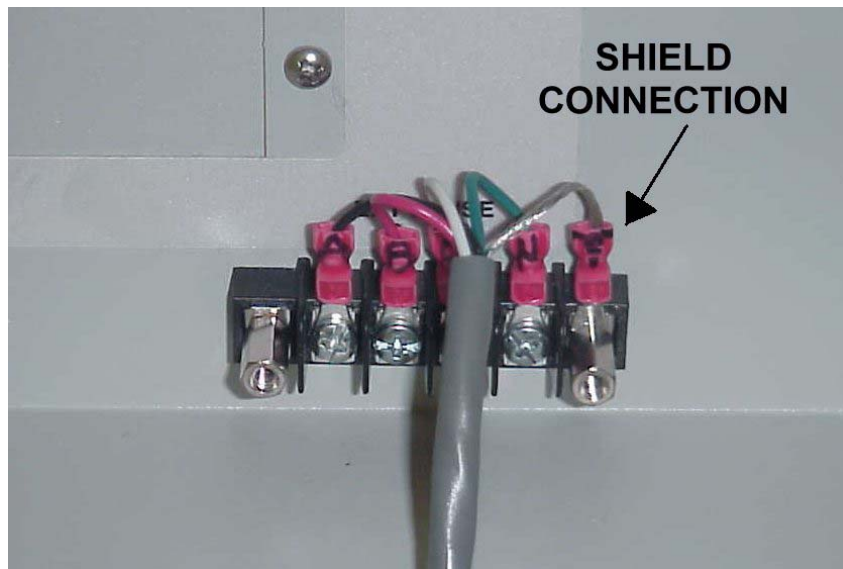

Figure 3-5: External sense cable shield connection to chassis ground

**Note:** *The output of the power source is isolated from the input line and floating with respect to chassis ground. If needed, either side (HI or LO) may be grounded.*

If the EUT changes frequently, you may want to consider using some quick disconnect scheme external to the RS so it will not be necessary to power down the RS and remove the front covers. This can take the form of a panel-mounted socket (1 or 3 phase) of sufficient current and voltage rating. (Not supplied with RS)

The output power cables must be large enough to prevent a total voltage drop exceeding 1% of the rated output voltage between the power source and the load. Table 3-2 shows the size of the cables that may be used. Note that wires must be sized to accommodate the maximum

current that is available. This may be a function of the voltage range and phase mode on some RS models. If the RS has more than one output voltage range, size the wires for the lowest available voltage range as the currents will be highest in that range.

Cable lengths must not exceed twenty-five (25) feet. For lengths greater than 25 feet, calculate the voltage drop from the following formula:

$$2 \times \text{DISTANCE} \times \text{CABLE RESISTANCE PER FT.} \times \text{CURRENT} = \text{VOLT DROP}$$

Table 3-2: Suggested Output Wiring Sizes\*

Load Current	Wire Gauge (US)	Circular Mils (kcmils)	Metric (mm <sup>2</sup> )
65 AMPS	8 AWG	16.5	8.37
130 AMPS	4 AWG	41.7	21.2
260 AMPS	2/0 AWG	133.0	67.4
400 AMPS	4/0 AWG	212.0	107.0

\* Data shown for use of high temperature (100° C) rated stranded copper wire, unbundled and not installed in conduit. Adjust wire gauge for Aluminum wire type.

---

**Note:** Use high temperature rated wire. Always consult the National Electrical Code and/or local code regulations for proper rating and size of wire cabling prior to installation.

---

**Output Terminal Blocks**

The RS90 has two output terminal blocks, TB1A and TB1B. The terminal blocks are large enough to accommodate the recommended wire gauge sizes shown in Table 3-2. The terminal blocks are located in the lower right corner on the back of the unit when facing the rear. The rear access panel at the bottom of the chassis needs to be removed to access these terminal blocks.



**CAUTION: REMOVE ALL INPUT POWER TO THE RS BEFORE REMOVING THE REAR ACCESS PANEL.**

The correct standard size Allen wrenches for connecting output wiring to TB1A and/or TB1B are supplied with each RS in the ship kit. Look for a brown envelope. If the correct tools cannot be found, contact AMETEK Programmable Power customer service at [service.ppd@ametek.com](mailto:service.ppd@ametek.com).

Terminal block TB1B provides the output neutral connection of the three phase WYE output. Phase A, B and C outputs are provided through terminals 1, 2 and 3 of TB1A respectively.

Connector	Terminal	Mode	Output
TB1A	1	3 Phase	Phase A
	2	3 Phase	Phase B
	3	3 Phase	Phase C
TB1B	1 - 4	3 Phase	Neutral

Table 3-3: Output Terminal connections.

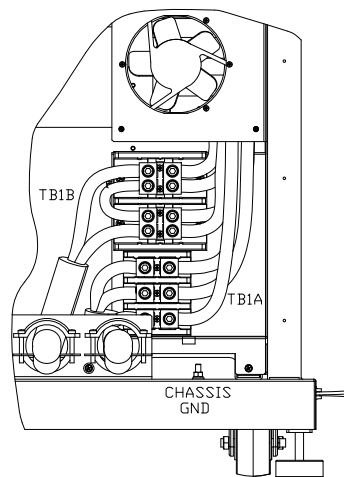

Figure 3-6: Location of Output Terminals (Rear view)



### 3.6.2 Output Wiring Diagram

Figure 3-7 shows the required output wiring connections for a RS90 (rear panel view).

Always disconnect all input power from the RS before removing the rear terminal block access panel. Route the load wires through the strain relief clamps. Depending on wire size required, it may be necessary to use two strain relief holes with 2 wires through each as shown.

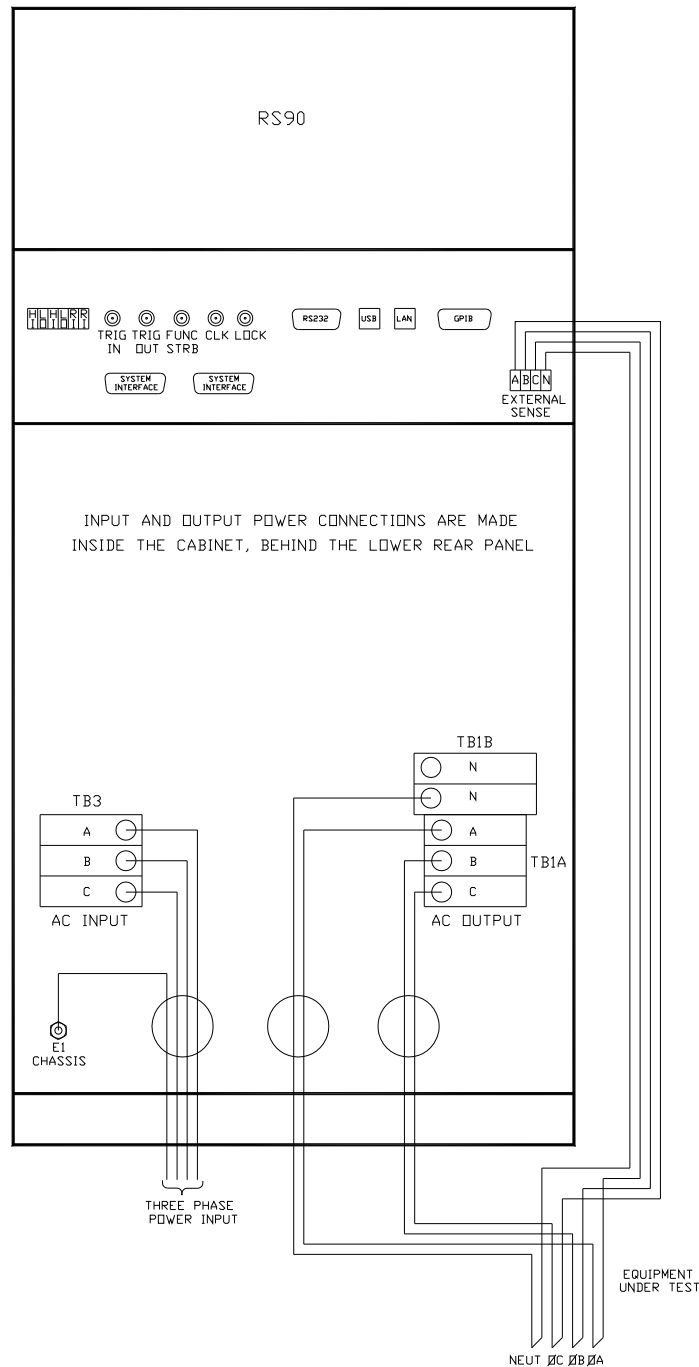

Figure 3-7: RS90 Output Wiring (Rear panel view)

3.6.3 RS180 Parallel Output Wiring Diagram

Figure 3-8 shows the required output connections for a RS180 dual chassis parallel mode output configuration (rear view). Always disconnect all input power from the RS90 before removing the rear panel cover that provides access to the input and output terminal connections. RS180 systems are shipped with external output terminal blocks that enable the output wiring from two chassis to be combined, providing a single point of connection to the EUT. These blocks must be installed in a suitable safety enclosure. It is important to match the length of the output wiring to the common output terminal block to ensure current sharing between the two RS90 power supplies. Additional RS90's can be paralleled in the same way to create higher power configurations.

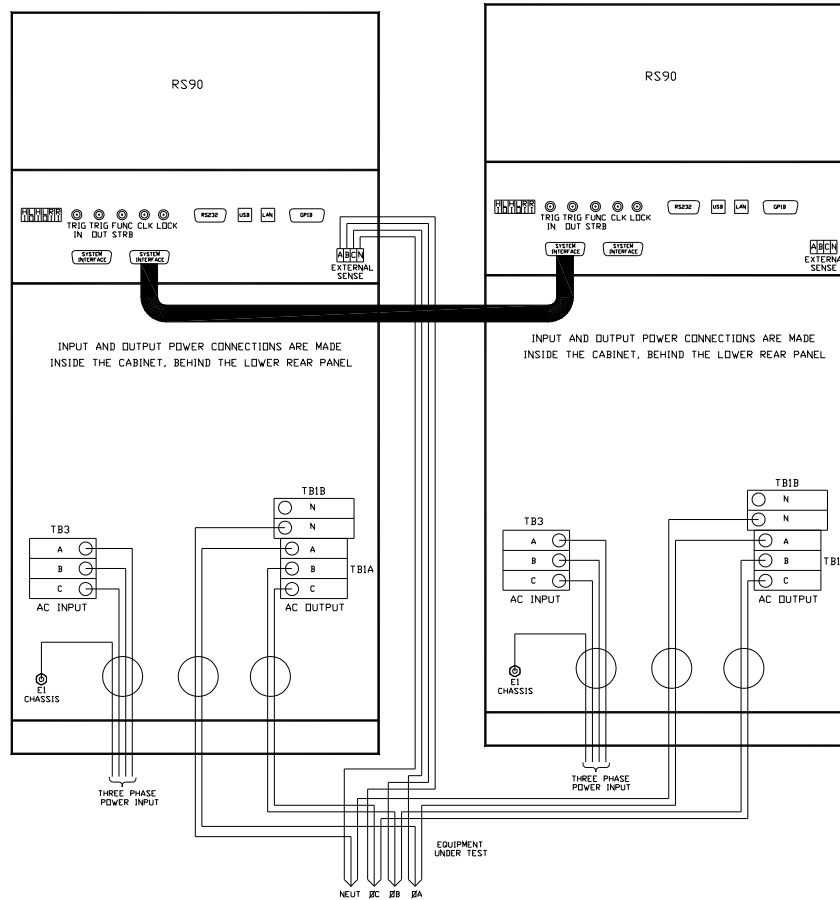

Figure 3-8: RS180 or RS180-MB Output Wiring (Rear view)

3.6.4 RS180 Clock and Lock Output Wiring Diagram

Figure 3-9 shows the required output connections for a RS90 Clock and Lock six phase output configuration (rear view). Always disconnect all input power from the RS90 before removing the rear panel cover that provides access to the input and output terminal connections. Clock and Lock systems can NOT be paralleled like a RS180 parallel system. Instead, they provide dual phase synchronized 3 phase power sources with the auxiliary unit frequency and phase locked to the master power source.

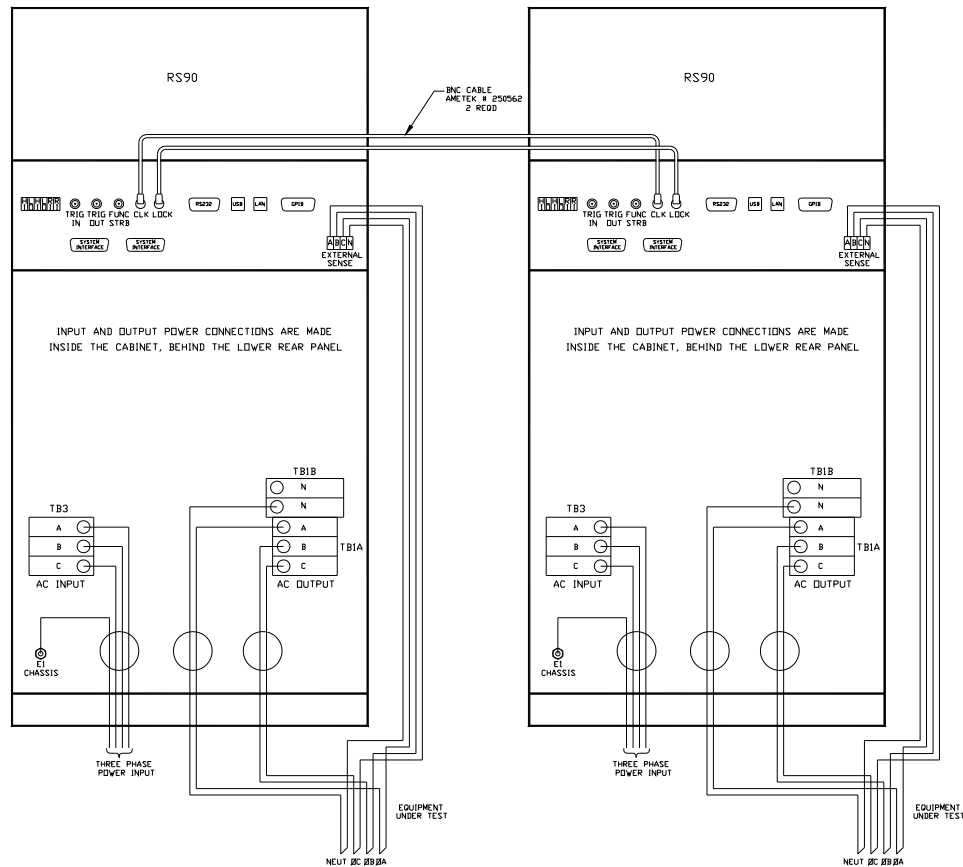

Figure 3-9: Two RS90's in Clock and Lock mode Output Wiring (Rear view)

### 3.6.5 Multi-Chassis Output Connections

If two or more RS chassis are used to form a single power system, the outputs of all chassis need to be combined (paralleled by phase). This can be done directly at the EUT if convenient or using the provided heavy-duty terminal blocks. Two blocks are provided with multi-chassis RS180 systems, one 2-position block and one 3-position block. These blocks allow up to four wires to be combined into one larger wire gauge size wire. The outputs of the 2 or 3 RS chassis are connected on one side of these blocks (Phase A,B and C into the 3 position terminal and the neutral into the 2 position terminal.). The EUT can be connected to the other side. Note that the wire size to the EUT should be sized up to accommodate the double or triple currents per phase.

TBD The dimensions of the supplied terminal blocks are shown in Figure 3-10.

Note that even if the EUT is a three-phase delta input, the output neutrals of the RS chassis' must be connected together for the system to work correctly.

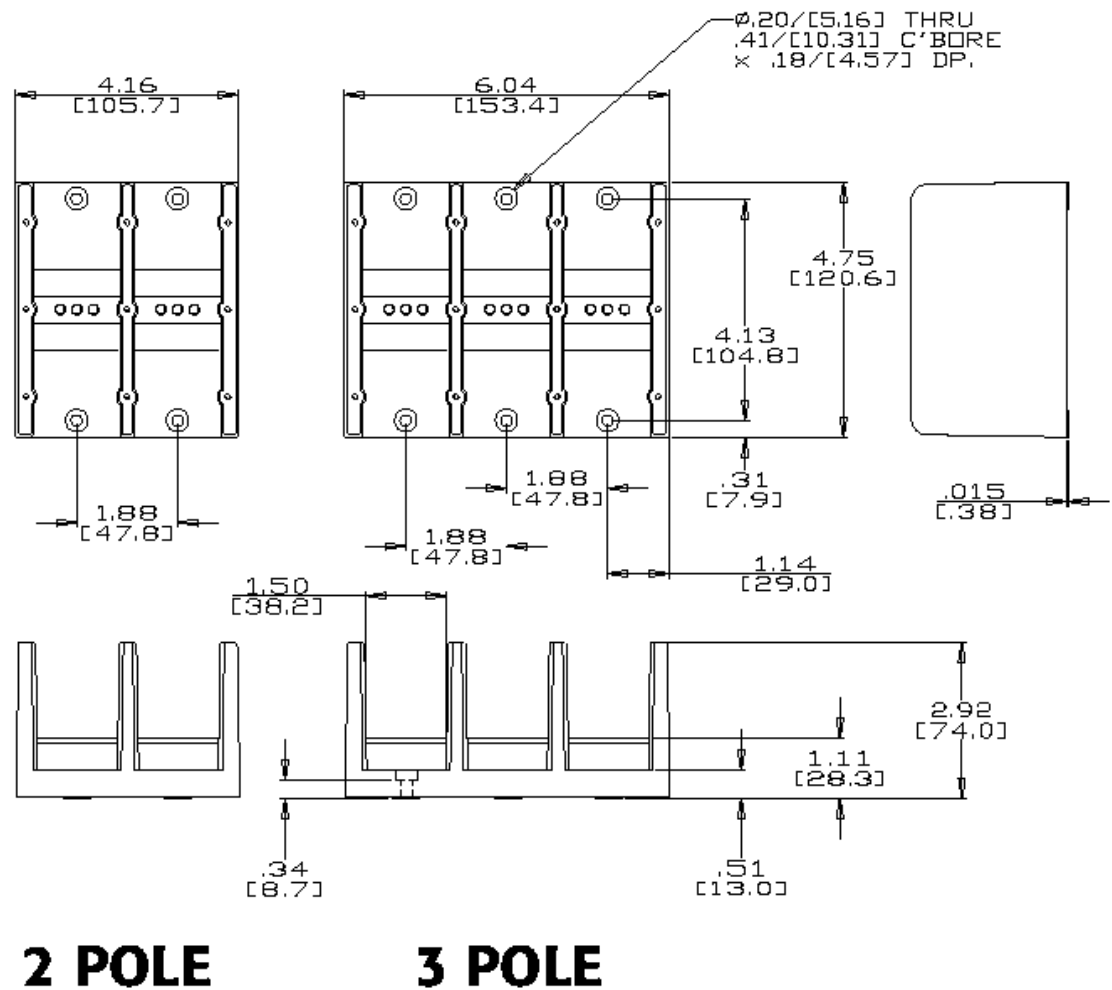

Figure 3-10: Ship kit Terminal Block dimensions TBD adjust

### 3.7 Connectors - Rear Panel

A number of connectors are located along the center rear panel. These connectors are in a recessed area to protect them from shipment damage.

#### 3.7.1 System Interface



**WARNING: The system interface connectors are for use with AMETEK Programmable Power supplied cables, and only between California Instruments equipment.**

The Clock and Lock BNC connectors located on the rear panel are used to synchronize and control the phase shift between the three outputs when 3 units are operating as a three-phase clock and lock system. This mode of operation requires the -LKM (on Master unit) and -LKS (on Auxiliary units) options. See paragraph 3.10 for more information on this mode of operation.

A set of two identical System Interface connectors, P8 and P9 ( TBD ) is located on the rear panel of each RS chassis. The system interface is used to connect the multiple RS90 power sources in a Master/Auxiliary configuration to create RS180 through RS540 models. In these configurations, only the Master RS90 power source has a built-in controller and front panel unless the Multi-box option (-MB) was specified at the of order. On -MB systems, two or more than RS90 chassis has a controller allowing reconfiguration into smaller power systems.

The same connector is also used to control the optional OMNI-3-75 Reference Impedance.

P8 / P9	Description
1	OUTP: Output ON. Controls state of output relay
2	N/C
3	N/C
4	N/C
5	COM: Common. Signal return.
6	OT: Over temperature. Indicates over temperature condition.
7	N/C
8	CLB: Current Limit B. Programmed current limit reference for phase B
9	CSA: Current Sum Phase A
10	CSC: Current Sum Phase C
11	FLT A: Amplifier Fault Phase A
12	FLT C: Amplifier Fault Phase C
13	XFMR: Optional voltage range select. (-HV or -XV option)
14	PARALLEL: Parallel operation control.
15	INPUT ON: Input power status
16	A ERR LO: Error Signal Phase A, low
17	B ERR HI: Error Signal Phase B, high
18	N/C
19	C ERR LO: Error Signal Phase C, Low

P8 / P9	Description
20	300 VRNG: 300 V AC Range Select
21	COM: Common. Signal return.
22	/REM OFF: Remote Off Control not
23	COM: Common. Signal return
24	FLK/BYP: Flicker / Bypass OMNI control
25	/OVL: Overload not
26	CLA: Current Limit A. Programmed current limit reference for phase A
27	CLC: Current Limit C. Programmed current limit reference for phase C
28	CSB: Current Sum Phase B.
29	N/C
30	FLT B: Amplifier Fault Phase B
31	N/C
32	DC: DC mode control
33	INP OFF: Input power control
34	A ERR HI: Error Signal Phase A, high
35	N/C
36	B ERR LO: Error Signal Phase B, low
37	C ERR HI: Error Signal Phase C, high

Table 3-4: System Interface Connectors

### 3.7.2 Analog Input Connector

Input screw-terminal strip. Functions are called out on rear panel decal. Table shows connections from left to right when standing at the rear of the RS cabinet.

Pin	Description
1	RPV HI. INPUT: Analog input for External Modulation
2	RPV Lo. INPUT: return.
3	EXT SYNC HI INPUT: Analog input for external sync mode.
4	EXT SYNC Lo INPUT: return.
5	RI: INPUT: Remote Inhibit. (See paragraph 3.12.)
6	RI: INPUT: return.

Table 3-5: Analog Interface Connector

### 3.7.3 BNC Connectors

BNC connectors. Functions are called out on rear panel decal. Table shows connections from left to right when standing at the rear of the RS cabinet.

*Table 3-6: BNC Connectors*

BNC	Description
1	Trigger Input (TTL input)
2	Trigger Output (TTL output) (Same signal connection as Function Strobe. Some units may not have this output connected. If you don't get an output trigger on this BNC, use the Function Strobe BNC instead.)
3	Function Strobe (TTL output) (Same signal connection as Trigger Output)
4	Clock (TTL output on Master / TTL input on Auxiliary)
5	Lock (TTL output on Master / TTL input on Auxiliary)
6	Emergency Shut off inter connect. Installed only on –MB systems with –ES Option.

*Table 3-7: BNC Connectors*

### 3.7.4 External Sense Connector

Pin	Description
1	Phase A sense
2	Phase B sense
3	Phase C sense
4	Neutral sense

*Table 3-8: External Sense Connector*

### 3.7.5 RS232C Serial Interface Connector

An RS232 serial interface connector is located on the rear panel on all models.

Pin	Name	Direction
1	N/C	
2	TxD	Output
3	RxD	Input
4	N/C	
5	Common	Common
6	N/C	
7	CTS	Input
8	RTS	Output
9	N/C	

*Table 3-9: RS232 Connector pin out – RS with RS232 and USB.*

The RS models RS232 interface use a straight through DB9 male to DB9 female serial cable, which is supplied in the RS ship kit for these models.



### 3.7.6 USB Interface

A standard USB Series B device connector is located on the rear panel for remote control. A standard USB cable between the AC Source and a PC or USB Hub may be used.

**Note:** *Use of the USB port to control more than one power source from a single PC is not recommended, as communication may not be reliable. Use GPIB interface for multiple power source control.*



Figure 3-11: USB Connector pin orientation.

Pin	Name	Description
1	VBUS	+5 VDC
2	D-	Data -
3	D+	Data +
4	GND	Ground

Table 3-10: USB Connector pin out.

### 3.7.7 LAN Interface – RJ45

An optional RJ45 Ethernet 10BaseT connector is located on the rear panel for remote control. A standard RJ45 UTP patch cord between the AC Source and a network Hub may be used to connect the AC source to a LAN. For direct connection to a PC LAN card, a crossover RJ45 cable is required. Consult your network administrator for directions on connecting the AC source to any corporate LAN.

If the –LAN Ethernet interface option is present, the MAC Address (Media Access Control) of the Ethernet port is printed on the serial tag of the power source. The serial tag is located on the rear panel of the unit.

For information on how to set up a network connection or a direct PC connection using the LAN interface, refer to the RS Series Programming Manual P/N 7003-961 distributed in Adobe PDF format on CD ROM CIC496.

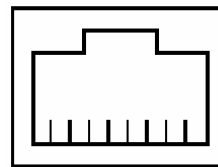

8 7 6 5 4 3 2 1

LAN

Pin	Ethernet TPE 10BaseT/100BaseT/1000BaseT	EIA/TIA 568A	EIA/TIA 568B Crossover
1	Transmit/Receive Data 0 +	White with green stripe	White with orange stripe
2	Transmit/Receive Data 0 -	Green with white stripe or solid green	Orange with white stripe or solid orange
3	Transmit/Receive Data 1 +	White with orange stripe	White with green stripe
4	Transmit/Receive Data 2 +	Blue with white stripe or solid blue	Blue with white stripe or solid blue
5	Transmit/Receive Data 2 -	White with blue stripe	White with blue stripe
6	Transmit/Receive Data 1 -	Orange with white stripe or solid orange	Green with white stripe or solid
7	Transmit/Receive Data 3 +	White with brown stripe or solid brown	White with brown stripe or solid brown
8	Transmit/Receive Data 3 -	Brown with white stripe or solid brown.	Brown with white stripe or solid brown

Table 3-11: RJ45 LAN Connector pin out.

### 3.7.8 ES Option - Emergency Switch Interconnect for –MB systems – BNC

An optional BNC connector is located on the rear panel for connecting multiple chassis, each having a controller and an emergency shut off switch (-ES option). This connection is required to create an OR-ed operation of more than one –ES switch.

This connector is only present on RS-MB systems with the –ES option. If present, a suitable BNC cable should be used to connect the emergency shut off signal between chassis. This connector is labeled as follows:

***"Caution: BNC cable must be connected for system Emergency Shut-Down"***

See figure below for an illustration of a RS180-MB-ES interconnect.

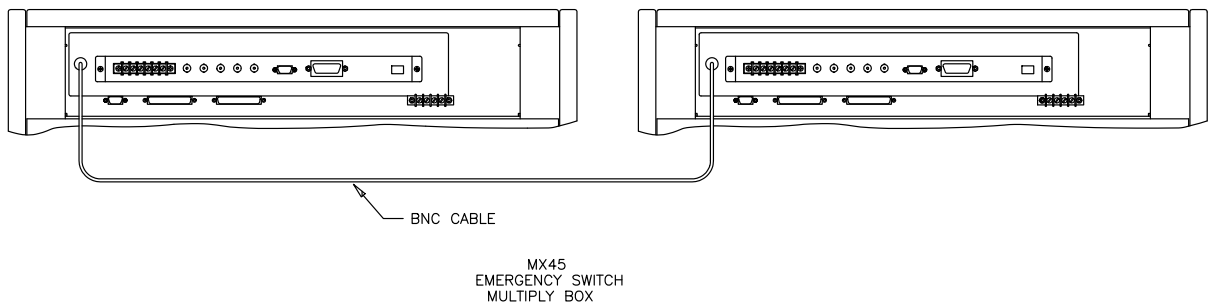

Figure 3-12: Emergency Switch (ES Option) shut off inter connect on -MB systems.

---

### 3.8 Multiple Cabinet System Configurations (incl. –MB)

---

Multi-cabinet RS models consist of one master and one to four autonomous or Auxiliary RS90 units. Auxiliary units do not have their own controller and are identified easily by their blank front panel (except for status indicator LEDs). Master units each have their own controller but can be configured as auxiliary units by disconnecting the ribbon cable marked J17 between the controller and the system interface board (P/N 7003-700-1 or P/N 7003-715-1). This disables the controller and allows the RS90 to operate as an Auxiliary unit. (Requires removal of the rear panel panel). See section 4.2.11.5 for information on setting the SYSTEM field in the configuration menu when changing configurations on RS systems with the –MB (Multi-box) option.

When used as a multi-cabinet system for higher power applications, the controllers in the unit(s) acting as the auxiliary to the master are either disabled or not present. For normal system configurations such as RS180-3Pi, the auxiliary unit will not have a controller or front panel and will have been factory configured for auxiliary operation.

For –MB systems such as RS180-3Pi-MB, the controller in the auxiliary unit must be disabled using S1. The SYSTEM field in the master unit controllers CONFIGURATION SETUP 3 screen must be set to the correct system configuration setting as well. The SYSTEM field for the controller in the auxiliary unit must be set to AUX if it is used as an auxiliary unit. See section 4.2.11.5.

---

**Note:** *New SYSTEM field configuration settings do not take effect until power is cycled.*

---

In addition to disabling the controller if present (as described above), the DIP switch (S1) located on the GPIB / RS232C / USB / IO assembly in the auxiliary cabinets. (Requires removal of the rear panel). The correct switch settings are shown below. (shown set for Master cabinet). Note that all units must be powered down before reconfiguring. Also, the output wiring must be changed to accommodate the new configuration.

---

**Note:** *If the units being re-configured for multi-cabinet operation were not factory configured this way, it may be necessary to balance the amplifiers by adjusting their gain. Refer to section 6.4 for details on Amplifier balancing.*

---

When used as a multi-cabinet system, the system interface cables must be connected between the master and the auxiliary cabinets.

---

**Note:** *If the –MB system has the –ES emergency shut off switch option, it is required to connect the ES BNC's between master chassis. See section 3.7.8.*

---

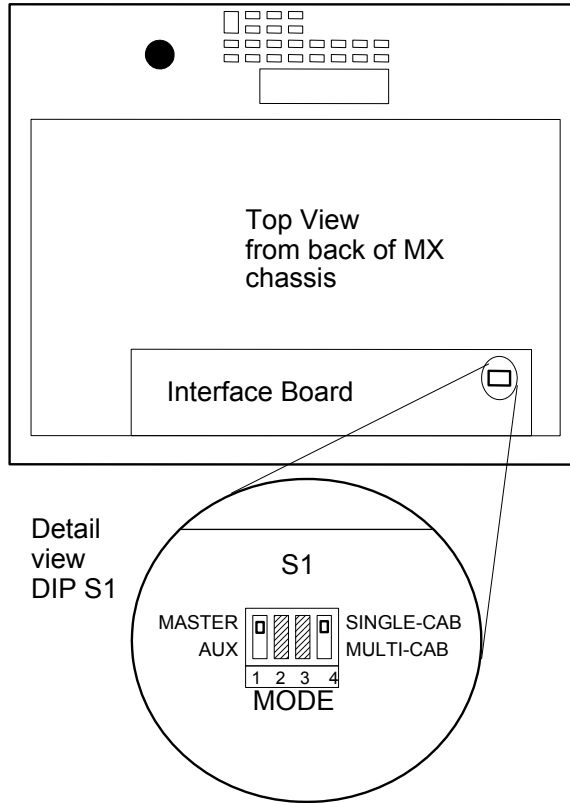

Figure 3-13: Multi-Cabinet DIP Switch Location and Setting - TBD

### 3.9 Multiple Cabinet Power Up/Down Procedures

---

For all multi-cabinet RS Series configurations (RS180 through RS540), the following Power Up (Turn on) and Power Down (Turn off) procedures should be observed.

#### 3.9.1 Power Up Procedure

---

**Follow these steps:**

1. Turn on each of the Auxiliary units using the front panel circuit breaker, one at a time. The exact order for turning on the auxiliary units is not important. Note that the bias supplies of each of the auxiliary cabinets will power up but not the actual amplifiers. This is because the auxiliary units are waiting for the turn on signal from the master unit.
2. Once all auxiliary units are on, **turn on** the **MASTER** unit **LAST** using the front panel circuit breaker. The master unit will go through an initialization process and power up itself plus the auxiliary units.
3. Allow 20 to 30 seconds for the turn on sequence to complete before attempting to communicate with the system.

#### 3.9.2 Power Down Procedure

---

The power-down / shutdown sequence for the system is the reverse of the power-up / turn-on sequence. This means the MASTER unit is turned off **FIRST**. Once the MASTER shuts down, all auxiliary units' main AC input power contactors will open up automatically. They still need to be turned off individually using the front panel circuit breaker. This will shut down their bias supplies as well.

**Follow these steps:**

1. Disconnect the EUT by opening the RS output relay. Use the Output On/Off button on the master unit front panel or send the "OUTPUT 0" command over the bus to do so.
2. **Turn off** the **MASTER** unit **FIRST** using the front panel circuit breaker. The master unit will disengage the main AC power input contactors of all auxiliary units at this time.
3. Next, turn off each of the Auxiliary units using the front panel circuit breaker, one at a time. The exact order for turning off the auxiliary units is not important.

### 3.10 Clock and Lock Configurations

The RS Series may optionally be equipped for clock and lock mode of operation. This mode is a special form of Master/Auxiliary, which requires each chassis to have its controller. As such, it is possible to create 3, 6 or 9 phase power systems using 2 to 3 RS chassis. For most applications, the normal multi-box parallel mode of operation as described in section 3.8 is most common as it provides a single controller (and GPIB/RS232 control interface).

In a clock and lock configuration, each unit has its own front panel controls (as well as individual GPIB, RS232C, USB or LAN interfaces) for operating the supply but the output frequency and phase of the auxiliary unit(s) (-LKS option) is synchronized (locked) to the Master RS unit (-LKM). Despite this phase lock mode of operation, the outputs of two clock and locked RS systems cannot be paralleled. Use normal multi-box parallel mode instead for application requiring more power than a single RS90 can provide.

This mode of operation requires that one RS has the -LKM (Lock Master) option and one or two RS units have the -LKS (Lock auxiliary) option.

#### 3.10.1 Clock/Lock Configuration Settings

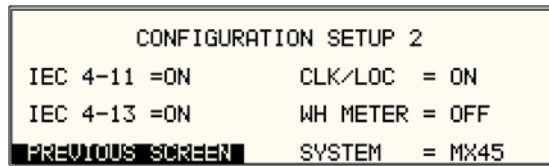

Clock and lock configuration settings for -LKM and -LKS equipped RS's are set at the factory at the time of shipment and cannot be changed. To check the configuration settings for an RS, select the UTILITY2, CONFIGURATION screen. In the configuration screen, the CLK/LOC entry determines if the unit is a Master or Auxiliary as follows:

CONFIGURATION 2 Field	Parameter	Description
CLK/LOC	N/A	Stand alone RS or RS-LKM clock and lock master. Frequency mode is set to either INT (internal = default) or SYNC (external sync).
	ON	Auxiliary RS. Frequency mode selection is INT (internal = for stand alone use) or EXT (external for Clock and Lock mode operation.)

Table 3-12: Clock and Lock Configuration settings

Note that the actual mode of operation of a Clock/Lock RS-LKM auxiliary unit is determined by the Clock mode set in the PROGRAM2 screen. For clock and lock mode of operation, the master is set to INT and the Auxiliary to EXT.

### 3.10.2 Clock/Lock Initialization Settings

The mode of operation of the RS-LKS auxiliary unit is determined by the Clock mode set in the PROGRAM2 screen. Since most clock and lock systems are permanently used in this configuration, the clock mode can be set to EXT (External) at power on by using the INITIAL SETUP3 screen.

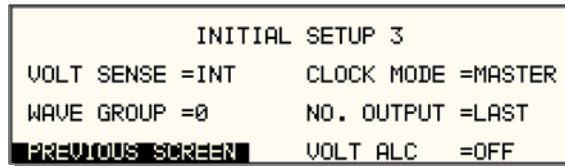

Available initial settings and their relationship to the Clock and Lock mode of operation are shown in the table below.

INITIAL SETUP 3 Field	Parameter	Description
CLK/LOC	STAND	Normal stand alone mode of operation. For standard RS power source with no clock and lock mode of operation.
	MASTER	For master (-LKM) power source in clock and lock mode of operation.
	AUX	For auxiliary (-LKS) power source in clock and lock mode of operation. Powers up with clock mode set to external.

Table 3-13: Clock and Lock Initialization settings

### 3.10.3 Clock/Lock and External Sync Mode

Note that an RS-LKM auxiliary unit is factory configured to operate in Clock and Lock mode when EXT clock mode is selected in the PROGRAM2 screen. This means that a RS-LKS **cannot** be used in normal external sync mode. However, the RS-LKM master unit can be operated in external sync mode. Note: **External sync mode not available with the FC option**

Furthermore, since the RS-LKM master unit is factory set for Master mode of operation, it in turn **cannot** be used as an Auxiliary source in a clock and lock configuration.

### 3.10.4 Remote Programming of Clock and Lock systems

Since clock and lock systems have multiple autonomous controllers that are synchronized in frequency, remote programming of these systems requires that the application program deals with all RS controllers. This often precludes the use of RS232C as generally not enough serial ports are available. The use of GPIB instead also offers the advantage of using the Group Execute Trigger (GET) capability to effect output changes on all phases (RS's) simultaneously which is otherwise difficult to do.

To set up a GPIB remote controlled clock and lock systems, the GPIB addresses for the individual RS's must be set to different address values in the UTILITY1, GPIB/RS232 SETUP screen.

**Note:** *This mode of operation is not supported by the RSGUI Windows software supplied with each RS unit.*



### 3.11 Basic Initial Functional Test

---



**CAUTION:** *Work carefully when performing these tests; hazardous voltages are present on the input and output during this test.*

---

Refer to Figure 3-14 for the required functional test set up. Proceed as follows to perform a basic function check of the power system:

1. Verify the correct AC line input rating on the nameplate of the RS unit(s) and make sure the correct three-phase line voltage is wired to the input of the RS before applying input power.
2. Connect a suitable resistive or other type load to the output of the RS. The load resistance value will depend on the voltage range you plan to check. Make sure the power resistor has sufficient power dissipation capability - up to 30 KW for full load test on one phase of RS90-3Pi - and that the load used does not exceed the maximum power rating of the RS. For three phase configurations, this test can be performed on one phase at a time if needed.
3. Connect an oscilloscope and DMM / voltmeter to the AC source output. Set both for AC mode.
4. If the correct voltage is present, turn on the RS unit(s) by closing the On/Off circuit breaker on the front panel. For multi-cabinet systems, turn on the auxiliary unit first and wait for them to cycle on, then turn on the master unit.
5. If the RS has more than one available output voltage range, go to the PROGRAM 1 screen and select the desired voltage range. The output mode can be set from the PROGRAM 2 screen (use the MORE soft key or press the PROGR function key again). Select AC mode.
6. Set the output voltage to 0 volt and close the output relay with the OUTPUT ON/OFF button. There should be little or no output although the DMM may show a noise level, especially if the DMM is in auto ranging mode.
7. Move the cursor to the VOLTAGE field in the PROGRAM 1 screen and either use the keyboard to program a small voltage (20 VAC) or slew the voltage up slowly with the knob. Observe the DMM reading. The reading should track the programmed voltage.
8. Also monitor the scope. The output should be a sinusoidal voltage waveform.
9. If the output tracks, increase the voltage till you reach 80 % of the voltage range or more. Check the output voltage reading and waveform.
10. Select the MEASUREMENT 1 screen by pressing the MEAS button. The output voltage, current and power will be displayed. For three phase configurations, use the PHASE button to select the ØABC display mode. This will show the voltage, current and power for all three phases. If all phases are loaded equally, the same current and power should be visible for all three unless the voltages are not programmed to the same level. If only one phase is loaded, current and power will only be shown for the loaded phase.

In the unlikely event the power source does not pass the functional test, refer to the calibration procedure in Section 6 or call AMETEK Programmable Power customer service department for further assistance.

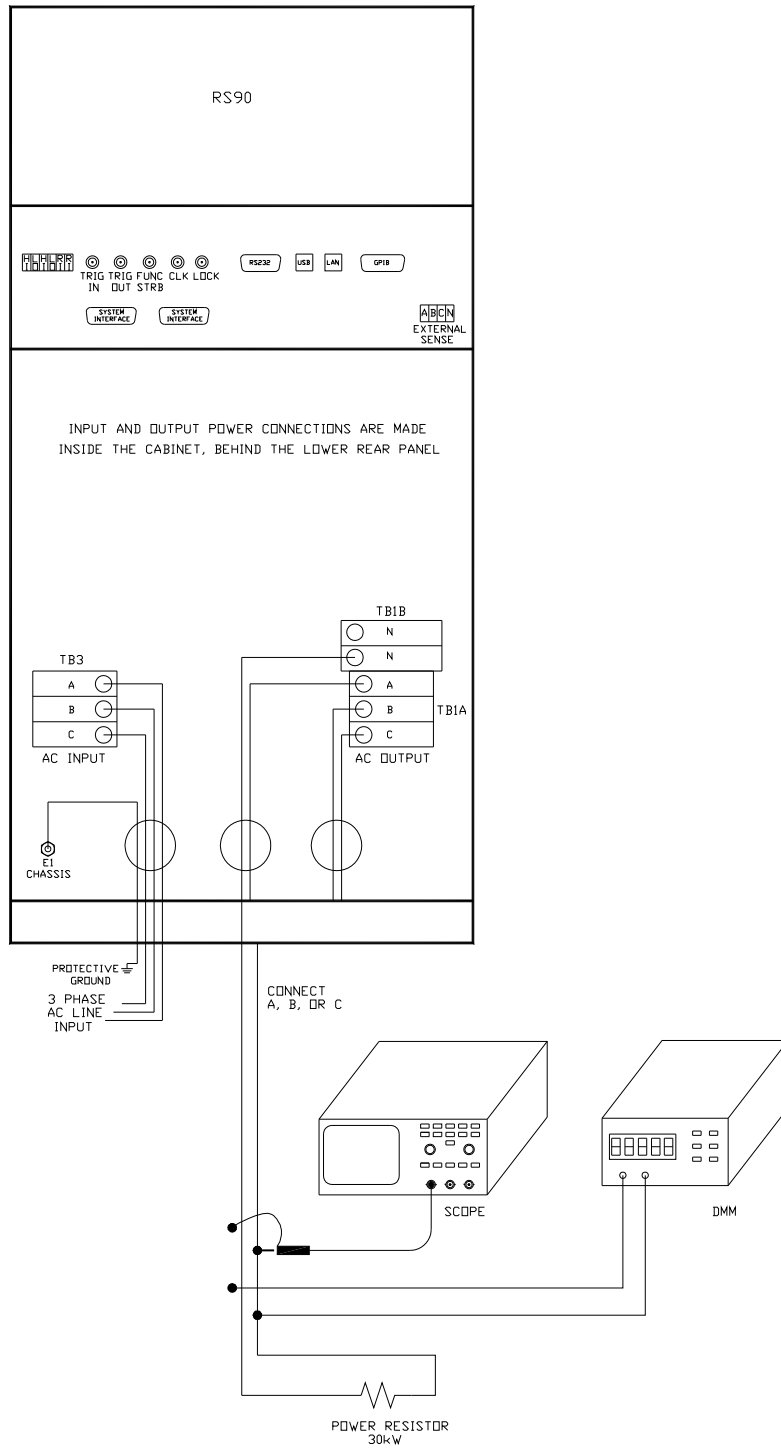

Figure 3-14: Functional Test Setup.

### 3.12 Remote Inhibit / Remote Shutdown

It may be necessary to provide a remote shutdown of the AC or DC output of the RS. The external remote inhibit input may be used for this purpose (RI). This input is also referred to as remote shutdown.

The default mode of operation for the RI input is a contact closure between pins 5 and 6 (return) of the rear panel screw-terminal strip. This will open the output relay of the RS.

It is possible to reverse the polarity of the RI input. This requires the use of the following bus command:

```

OUTPUT:RI[:LEVel] HIGH      /* Sets RI polarity to active high.
OUTPUT:RI[:LEVel] LOW       /* Sets RI polarity to active low (Factory default)

```

The remote control interface must be used to change this setting. Once set, the polarity setting remains in effect.

The way the RS responds to a remote inhibit event can be programmed over the remote control interface using the OUTPUT:RI:MODE command. See P/N 7003-961 programming manual for details on changing modes. The mode set is retained at power off and recalled at power up so stays in effect till changed again over the bus.

The following modes are supported.

MODE	OPERATION
LATCHING	A TTL low at the RI input latches the output in the protection shutdown state. This state can only be cleared by sending a OUTPUT:PROTEction:CLEar command over the bus.
LIVE	The output state follows the state of the RI input. A TTL low or contact closure at the RI input turns the output off; a TTL high or open contact turns the output on. This mode is equivalent to using the Output On/Off button on the front panel. Default mode. Units are shipped in this mode.
OFF	The instrument ignores the RI input.

Table 3-14: Remote Inhibit Mode Settings

**NOTE:** When using the Remote Inhibit input, it will be necessary to disconnect any RI connection to the RS master unit when turning on the RS master unit. During initialization, the RI connection must be OPEN or initialization will be halted with the message **WARNING FOR AUXILIARY** displayed on the LCD screen.

### 3.13 Junction Box Accessory TBD

An optional wiring junction box (P/N 7003-416-1) is available which may be used to connect the outputs of 2 to 6 RS cabinets together. The junction box also has a protective ground connection, which **MUST** be connected to a suitable protective earth ground.

Each junction box has four sets of terminals for phase A, phase B, phase C and Neutral. Each terminal is lined up with a strain relief on each side. The outputs from the RS90 cabinets connect to the “RS SYSTEM OUTPUT” side of these terminal blocks. The load can be connected to the “LOAD”. Note that the wiring is not supplied with the system and must be provided by the end user. The wire gauge of the load connection must be sized to handle the maximum current in the low voltage range of operation.

The “RS SYSTEM OUTPUT” side of the terminal block will accept up to 8 wires. If the external sense connection is made at the junction box, one of these can be used to connect the sense wiring.

**Note:** Do not swap output load wires or sense wires between phases, as damage to the system will result.

The “LOAD” side will accept 2 wires. The wire size range shown in Figure 3-15 refers to mechanical compatibility of terminal block only. This information does not reflect required wire size. The wire sizes accepted by the terminal blocks of the junction box on each side are shown in Figure 3-15.

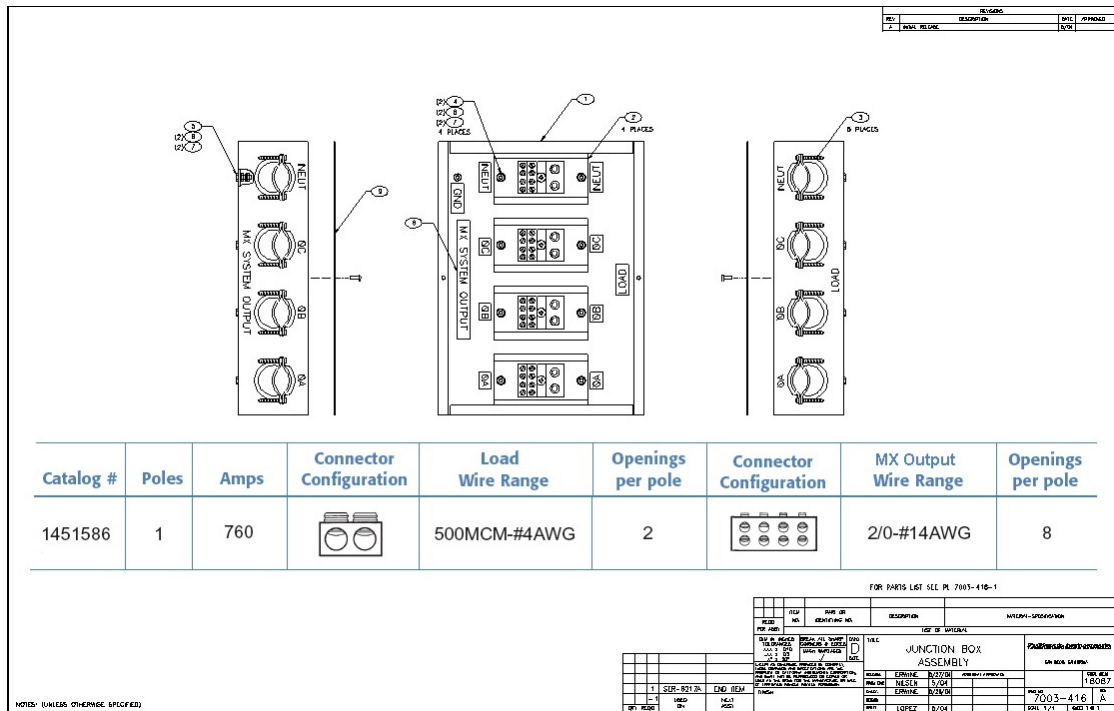

Figure 3-15: 7003-416-1 Output Junction Box

**Dimensions 7003-416-1:**

W x L x H Chassis	12.125 " x 16.125" x 4.125"	308 x 410 x 105 mm
Feet height:	0.875	22 mm
Strain relief hole size:	1.5" diameter	38 mm diameter

## 4. Front Panel Operation

---

### 4.1 Tour of the Front Panel

---

The RS Series with type non-Pi (basic) or type Pi controllers have identical front panels although some of the keys found on the front panel are only used by RS models with the 3Pi controller. If your unit is a P type controller, these keys will act as don't cares. This chapter provides information on operating the RS with either controller type.

Before operating the AC source using the front panel, it helps to understand the operation of the front panel controls. Specifically, the operation of the knob, keyboard and the menu layout are covered in the next few paragraphs.

#### 4.1.1 Front Panel Controls and Indicators

---

The front panel can be divided in a small number of functional areas:

- Mains circuit breaker
- Status Indicator lights
- Shuttle knob
- LCD display
- FUNCTION keypad
- DATA ENTRY keypad

#### 4.1.2 System On/Off Circuit Breaker

---

The circuit breaker located on the bottom left side of the front panel disconnects the low voltage supply of the RS Source from the three phase Line input. This will remove power from the mains AC input contactor and thus remove input power from the RS Series power source. As such, the circuit breaker acts as an indirect power on/off switch for the RS Series unit. Note however that AC input power remains applied to the primary side of the input transformer.

When the input current rating of the RS Series AC power source is exceeded, the protective fuses (F1 through F6) will blow. In this case, power to the low voltage supply may still remain through the front panel circuit breaker. In this case, the on/off circuit breaker should be opened (power off) first followed by a complete disconnect of all ac input power through an installed main circuit breaker.

Note that in multi-box RS90 system configurations, each RS90 chassis has its own on/off circuit breaker and set of line input fuses.

---

### 4.1.3 Status Indicator Lights

---

Four LED status indicators are located directly above the mains circuit breaker. These LED's correspond to the following conditions:

REMOTE	The REMOTE LED indicates that the unit is in remote control mode. If the IEEE-488 interface is used, this indicator will be lit whenever the REM line (REMOTE ENABLE) line is asserted by the IEEE controller. If the RS232, USB or LAN interface is used, the REMOTE state can be enabled by the controller using the SYST:REM command. Any time the REMOTE LED is lit, the front panel of the RS Series unit is disabled. There is no LOCAL button that allows the user to regain control of the front panel. This prevents accidental change of settings in ATE applications.
OVERLOAD	The OVERLOAD LED indicates an output overload condition. This condition can be controlled by setting the current limit value in the PROGRAM menu. Removing the load using the OUTPUT ON/OFF button will recover from an overload condition.
OVER TEMPERATURE	The OVER TEMPERATURE LED indicates an overheating problem inside the unit. This is an abnormal condition, which will cause the unit to shut off. Check the air openings to make sure they are not blocked.
HI RANGE	The HI RANGE LED is on when the high voltage output range has been selected.

#### 4.1.4 The Shuttle Knob

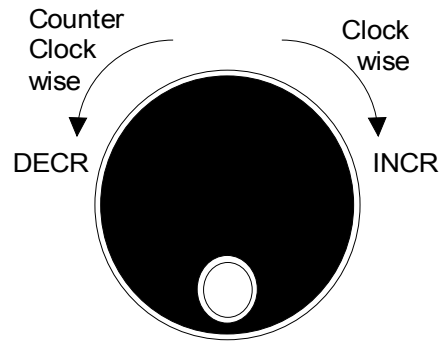

Figure 4-1: Shuttle Knob

The shuttle knob is located to the right of the LCD screen and is used to change setup parameters. Note that it cannot be used to move the cursor position between menu fields. Use the UP and DOWN arrow keys in the FUNCTION keypad for this.

The shuttle knob can operate in one of two distinct modes of operation:

<b>MODE</b>	<b>DESCRIPTION</b>
IMMEDIATE mode	Any time the ENTER key is pressed, the RS Series returns to its normal mode of operation. In this mode, changes made with the shuttle knob or the data entry keypad will take immediate effect. The IMMEDIATE mode is useful for slewing output values such as voltage and frequency and observing the effect on the load.
SET mode	When the SET key located in the FUNCTION keypad is pressed, changes made with the shuttle to any output parameter will not take effect until the ENTER key is pressed. In this mode, any changes made to a setup menu will be blinking to indicate the pending change condition. This mode allows changes to be made to all output parameters and executing them all at once by pressing the ENTER key.

### 4.1.5 FUNCTION Keypad

The function keypad provides access to all menus and measurement screens. The following keys are located in the FUNCTION keypad:

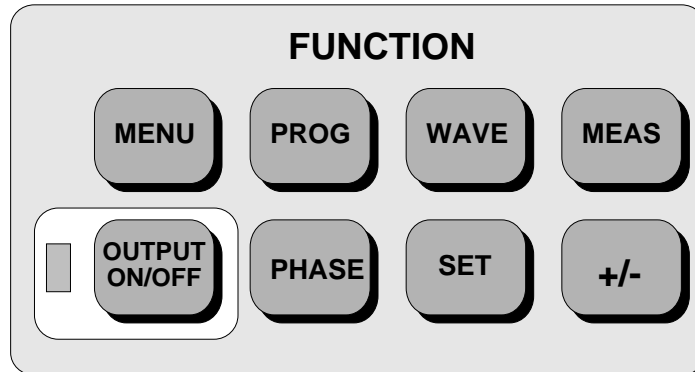

Figure 4-2: FUNCTION Keypad

KEY	DESCRIPTION
MENU	The top level menu is accessed by pressing the MENU key. Three shortcut keys are used to provide direct access to the PROGRAM, WAVEFORM, and MEASUREMENT screens as these are among the most frequently used screens. Thus, instead of going through the main menu to reach the PROGRAM, WAVEFORM, and MEASUREMENT screens, they can be accessed directly by pressing the PROG, WAVE, and MEAS keys respectively. A map of the Main menus is provided on the next few pages. There are three top level menus in the RS Series.
PROG	The PROG key is a shortcut to access the PROGRAM menu directly. The PROGRAM menu is one of the most frequently used menus. Thus, instead of going through the main menu to reach the PROGRAM menu, it can be accessed directly by pressing the PROG key.
WAVE	The WAVE key is a shortcut to access the WAVEFORM screen directly. The WAVEFORM screen is used to select a user defined arbitrary waveform.
MEAS	The MEAS key is a shortcut to access the MEASUREMENT screen directly. The MEASUREMENT screen is one of the most frequently used screens. Thus, instead of going through the main menu to reach the MEASUREMENT screen, it can be accessed directly by pressing the MEAS key.



OUTPUT ON/OFF	The OUTPUT ON/OFF key toggles the output relay on or off. The state of the output relay is reflected by the green LED located directly to the left of the OUTPUT ON/OFF key. If the green LED is lit, the output relay is enabled (closed) and the programmed output voltage is present at the output terminals. If the green LED is off, the output relay is open and both the HIGH and LO terminal of the output terminal block are disconnected from the power source. In this mode, the output is floating. The ON/OFF button provides a convenient way to disconnect the load without having to remove any wires.
PHASE	The PHASE key is used to select the phase on a RS90. Pressing the PHASE key will toggle phase A, B, C or ABC. Some screens may not support the ABC or show all phase information in which case this mode is skipped.
SET	The SET key is used to select the mode of operation of the shuttle. Refer to section 4.1.1 for details on its operation and the use of the SET key.
+/-	The +/- key can be used to toggle the sign for those parameters for which it is relevant. This is typically the output voltage when in DC mode of operation. For fields that have only two possible values such as the voltage range field, the +/- key can be used to toggle between these two values.

#### 4.1.6 DECIMAL KEYPAD

The decimal keypad may be used to enter any numeric parameter required in any of the menu fields. Several fields accept input from either the keypad or the knob. Data entered from the keypad is normally accepted once the ENTER key is pressed unless the front panel mode is in the SET mode. The following keys are available on the decimal keypad:

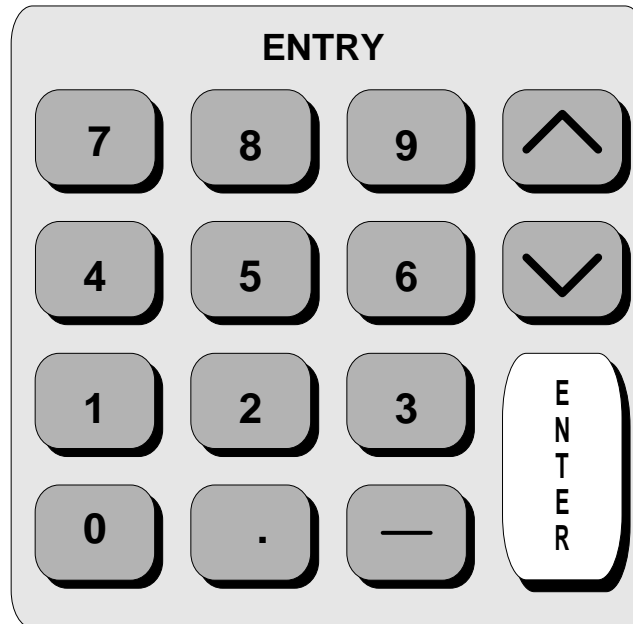

Figure 4-3: Entering Values from the Decimal Keypad

#### CURSOR UP

The UP key moves the cursor position upwards one position to the previous available cursor position. If the present cursor position is at the top of the right hand column, the cursor is moved to the bottom position of the left hand column. If the present cursor is at the top of the left hand column, the cursor is moved to the bottom of the right hand column. Figure 4-4 depicts the cursor movement through a two column menu.

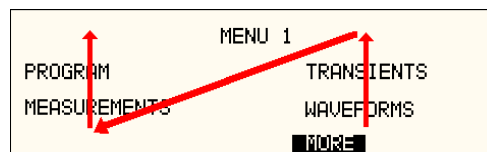

Figure 4-4: Cursor UP Key Movement

#### CURSOR DOWN

The DOWN key moves the cursor position downwards one position to the next available cursor position. If the present cursor position is at the bottom of the left hand column, the cursor is moved to the top position of the right hand column. If the present cursor is at the bottom of the right hand column, the cursor is moved to the top of the left hand column. Figure 4-5 depicts the cursor movement through a two-column menu.

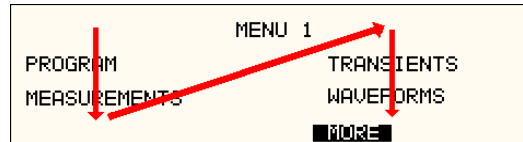

Figure 4-5: Cursor DOWN key Movement

The decimal keypad can be used at any time in lieu of the shuttle knob to change output parameters. Direct data entry is often faster to effect large changes in values than using the shuttle knob. Note that pressing the ENTER key while in SET mode of operation will cause the AC source to revert back to IMMEDIATE mode. Thus, to change all parameters in SET mode, enter a value for each field and then proceed to the next field without pressing the ENTER key.

0 through 9.

The numeric keys provide all decimal number for entry of parameters.

DECIMAL POINT

The decimal point key is used to enter fractional parts of values for fields that have a resolution less than 1. The amount of resolution for each menu field is normally visible on the LCD. If more digits are entered after the decimal point than can be accepted by a field, the value is automatically rounded to the available resolution when the ENTER key is pressed.

BACKSPACE

The BACKSPACE (←) key can be used to erase one digit at a time if you make a data entry error.

#### 4.1.7 LCD Display

The LCD display of the RS Series power source provides information on instrument settings and also guides the user through the various menus. To ease reading of the displayed information, most screens are widely spaced. A sample of the main menu 1 screen that appears when the RS Series source is powered up is shown in Figure 4-6. Due to the amount of space available on each screen, some menus have been split into parts. The MORE selection located at the bottom right hand side provides access to menu choices at the same level that did not fit on a single screen. Thus, to access MENU 2, the cursor should be placed on the 'MORE' selection followed by pressing the 'ENTER' key. Alternatively, the MENU key may be pressed to move to the MENU 2 screen.

The present cursor position is always shown with a inverse bar. The cursor is located on the 'MORE' selection in Figure 4-6. Pressing ENTER would cause MENU 2 to be displayed.

The cursor position can be moved by using the UP and DOWN keys located in the **DECIMAL** keypad.

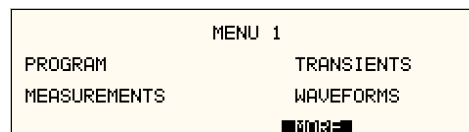

Figure 4-6: Main Menu 1 Screen

## 4.2 Menu Structure

The next few pages show a map of the available menus in the RS Series. There are three main level (level 1) menus from which all other menus can be reached. Frequently used (level 2) menus have a short cut key that provides direct access. Examples of such menus are Program, Measurements, and Waveform. In any case, there are never more than three levels of menus although some menus may be spread across more than one screen.

### 4.2.1 MAIN Menu

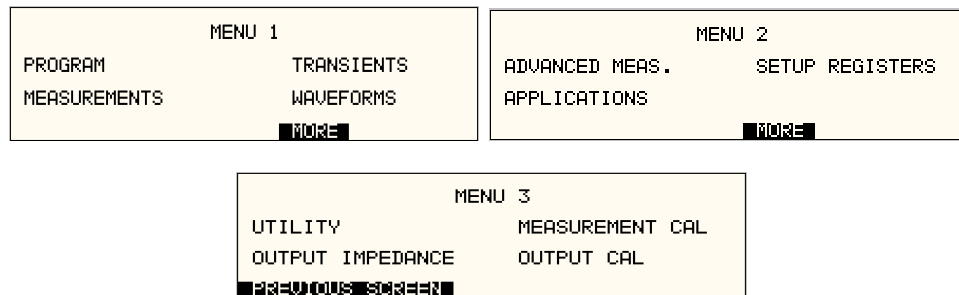

Figure 4-7: Menu 1 through 3

The top-level menu is split in three parts, MENU 1 through MENU 3 to allow spacing between menu entries. MENU 2 and 3 can be reached from MENU 1 by selecting the MORE entry or by pressing the MENU key repeatedly, which will toggle from MENU 1 to 2 to 3 and back to 1. The division of menu choices between the two screens is graphically illustrated in 4.2.2 by the boxes in level 1. Each box represents one screen. Subsequent screens can be reached using the MORE entry.

The following top-level menu choices can be accessed from the MENU key:

<b>Entry</b>	<b>Description</b>
<b><i>MENU 1</i></b>	
PROGRAM	The PROGRAM menu allows output parameters to be changed.
MEASUREMENTS	The MEASUREMENTS screens are not menus in that no user entries are required.
TRANSIENTS	The TRANSIENTS menu allows output transients to be programmed.
WAVEFORMS	The WAVEFORMS menu allows different waveforms to be selected from the waveform library.
MORE	The MORE selection causes the second part of the MENU screen to be displayed. (MENU 2)
<b><i>MENU 2</i></b>	
ADVANCED MEAS.	The ADVANCED MEAS. screens are for display only. No user entries are required.
APPLICATIONS	The APPLICATIONS menu provides access to the optional firmware application programs that may be installed in the RS Series AC source.
SETUP REGISTERS	The SETUP REGISTERS menu allows complete instrument settings and transient list programs to be saved to nonvolatile memory.
MORE	The MORE selection causes the third part of the MENU screen to be displayed. (MENU 3)
<b><i>MENU 3</i></b>	
UTILITY	The UTILITY menu provides access to less commonly used setup screens such as those for the GPIB and RS232C (also applies to USB and LAN) interface settings, initial startup values, etc.
MEASUREMENT CAL	The MEASUREMENT CAL menu allows for calibration of the AC source measurement system.
OUTPUT CAL	The OUTPUT CAL menu allows for calibration of the AC source output.

Following the Menu overview pages is a detailed description of each menu and sub menu.

4.2.2 Overview of Menu 1

	level 1	level 2	level 3																																																																										
MENU 1	PROGRAM	<b>PROGRAM1</b> VOLTAGE FREQ VOLT RANGE CURR LIMIT MORE																																																																											
		<b>PROGRAM2</b> PHASE CLOCK MODE VOLT MODE DC OFFSET START $\emptyset$																																																																											
	MEASUREMENTS	<b>MEASUREMENTS1</b> VOLTAGE CURRENT FREQ POWER MORE																																																																											
		<b>MEASUREMENTS 2</b> VA POWER PEAK CURR POWER FACT CREST FACT PEAK CURR RESET																																																																											
<b>MEASUREMENTS 3</b> VOLT THD CURR THD INST PK CURR PHASE																																																																													
TRANSIENTS	VOLT SURGE/SAG VOLT SWEEP/STEP FREQ SWEEP/STEP VOLT/FREQ SWEEP/STEP START/VIEW SEQUENCE PREVIOUS SCREEN																																																																												
		<table border="1"> <tr> <td></td> <td></td> <td>DURATION</td> <td>START <math>\emptyset</math></td> <td>START <math>\emptyset</math></td> </tr> <tr> <td></td> <td></td> <td>END VOLT</td> <td>END VOLT</td> <td>GO TO VOLT</td> </tr> <tr> <td></td> <td></td> <td>END DELAY</td> <td>DUR SCALE</td> <td>DUR SCALE</td> </tr> <tr> <td></td> <td>DURATION</td> <td>END DELAY</td> <td>DURATION</td> <td>DURATION</td> </tr> <tr> <td>START</td> <td>END VOLT</td> <td>FUNCTION</td> <td>END DELAY</td> <td>END VOLT</td> </tr> <tr> <td>PAUSE</td> <td>END FREQ</td> <td>REPEAT</td> <td>END DELAY</td> <td>END DELAY</td> </tr> <tr> <td>REPEAT #0</td> <td>END DELAY</td> <td>EVENT#</td> <td>FUNCTION</td> <td>FUNCTION</td> </tr> <tr> <td>CLEAR SEQ</td> <td>FUNCTION</td> <td>PREVIOUS SCREEN</td> <td>REPEAT</td> <td>REPEAT</td> </tr> <tr> <td></td> <td>REPEAT</td> <td></td> <td>EVENT#</td> <td>EVENT#</td> </tr> <tr> <td>#1</td> <td>SEQUENCE#</td> <td></td> <td>PREVIOUS SCREEN</td> <td>PREV. SCREEN</td> </tr> <tr> <td>#2</td> <td>PREVIOUS SCREEN</td> <td></td> <td></td> <td></td> </tr> <tr> <td>..</td> <td></td> <td></td> <td></td> <td></td> </tr> <tr> <td>#98</td> <td></td> <td></td> <td></td> <td></td> </tr> <tr> <td>#99</td> <td></td> <td></td> <td></td> <td></td> </tr> <tr> <td>PREVIOUS SCREEN</td> <td></td> <td></td> <td></td> <td></td> </tr> </table>			DURATION	START $\emptyset$	START $\emptyset$			END VOLT	END VOLT	GO TO VOLT			END DELAY	DUR SCALE	DUR SCALE		DURATION	END DELAY	DURATION	DURATION	START	END VOLT	FUNCTION	END DELAY	END VOLT	PAUSE	END FREQ	REPEAT	END DELAY	END DELAY	REPEAT #0	END DELAY	EVENT#	FUNCTION	FUNCTION	CLEAR SEQ	FUNCTION	PREVIOUS SCREEN	REPEAT	REPEAT		REPEAT		EVENT#	EVENT#	#1	SEQUENCE#		PREVIOUS SCREEN	PREV. SCREEN	#2	PREVIOUS SCREEN				..					#98					#99					PREVIOUS SCREEN				
		DURATION	START $\emptyset$	START $\emptyset$																																																																									
		END VOLT	END VOLT	GO TO VOLT																																																																									
		END DELAY	DUR SCALE	DUR SCALE																																																																									
	DURATION	END DELAY	DURATION	DURATION																																																																									
START	END VOLT	FUNCTION	END DELAY	END VOLT																																																																									
PAUSE	END FREQ	REPEAT	END DELAY	END DELAY																																																																									
REPEAT #0	END DELAY	EVENT#	FUNCTION	FUNCTION																																																																									
CLEAR SEQ	FUNCTION	PREVIOUS SCREEN	REPEAT	REPEAT																																																																									
	REPEAT		EVENT#	EVENT#																																																																									
#1	SEQUENCE#		PREVIOUS SCREEN	PREV. SCREEN																																																																									
#2	PREVIOUS SCREEN																																																																												
..																																																																													
#98																																																																													
#99																																																																													
PREVIOUS SCREEN																																																																													
WAVEFORMS	CLIP LEVEL GROUP MODE SINE SQUARE CLIPPED USER WAVE .. .. .. USER WAVE																																																																												
MORE																																																																													

4.2.3 Overview of Menu 2 and 3

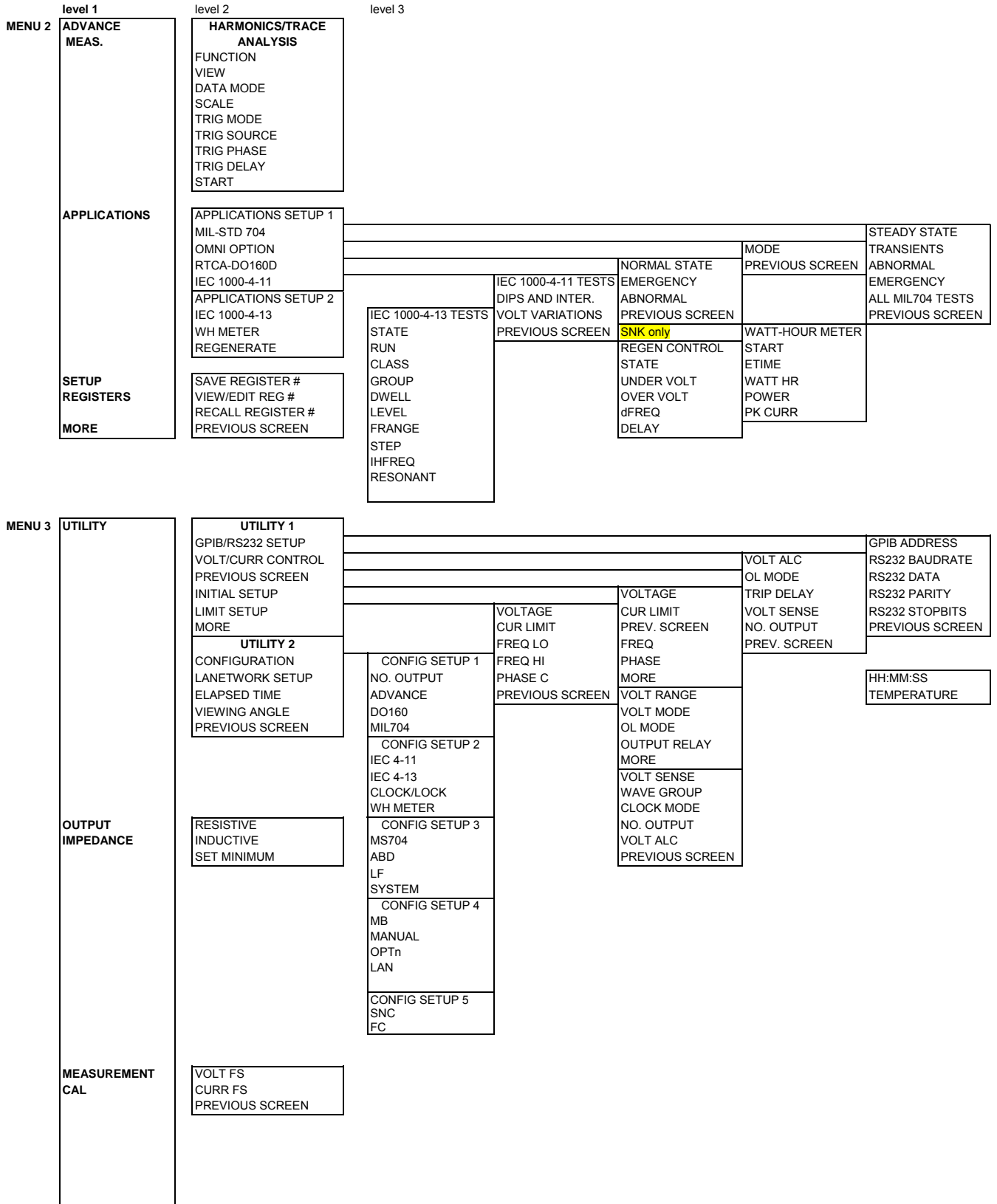

OUTPUT CAL	VOLT FS VOLT ZERO PHASE OFST IHARM FS IMP. REAL FS IMP. REACT FS IMP. REAL MIN IMP. REACT MIN PREVIOUS SCREEN
------------	---

#### 4.2.4 PROGRAM Menu



Figure 4-8: PROGRAM Menu

The PROGRAM menu is shown in Figure 4-8. It can be reached in one of two ways:

1. by selecting the PROGRAM entry in the MENU screen and pressing the ENTER key
2. by pressing the PROG key in the FUNCTION keypad

The PROGRAM menu is used to change output parameters. The most commonly used parameters are all located in PROGRAM 1. The PREVIOUS SCREEN entry, when selected, will return the user to the most recently selected menu. This is normally the MENU screen unless the PROGRAM menu was selected using the PROG key on the FUNCTION keypad. Less frequently used parameters are located in PROGRAM 2, which can be reached from the PROGRAM 1 screen using the MORE selection, or by pressing the PROGRAM key twice.

The following choices are available in the PROGRAM menus:

Entry	Description
<b>PROGRAM 1</b>	
VOLTAGE	Programs the output voltage in Vrms while in AC mode or absolute voltage when in DC mode. In DC mode, negative values can be entered.
FREQ	Programs the output frequency when in AC mode. If the unit is in DC mode, the value for FREQ will be set to DC and cannot be changed until AC mode is selected. When in AC mode, the frequency can be changed from 16 Hz to 500 Hz. Values entered that fall outside this range will generate a -200 RANGE ERROR and will not be accepted.
VOLT RANGE	Selects 150V, 300V or optional 400V range in AC mode and 200V or 400V range in DC mode. The actual range values may be different depending on the configuration. The value of this field can only be changed with the shuttle or the +/- key.
CURR LIMIT	Sets the current limit value for the current detection system. When the load current value exceeds the set current limit, a fault condition is generated. The actual response of the AC Source to a current limit fault is determined by the protection mode selected in the CONFIGURATION menu. (CC = Constant Current, CV = Constant Voltage).



**PROGRAM 2**

PHASE	Selects the phase angle between the external clock and the output of the AC source. If the clock source is internal, this parameter has no effect.
CLOCK MODE	Selects internal or external clock source. The RS Series controller uses an open-air crystal time base with an accuracy of 100 ppm. To improve output frequency stability and accuracy, an external clock generator may be used.
VOLT MODE	The RS Series offers three output modes, AC, DC and AC+DC. The VOLT MODE field can be used to toggle between these three output modes. Both the Knob and the +/- key may be used to toggle through these three selections. In DC mode, no frequency selection is possible and all maximum current and power ratings are divided by two.
DC OFFSET	When the AC+DC mode is selected, the VOLTAGE field in the PROGRAM 1 screen is used to set the AC portion of the output voltage. The DC OFFSET field in the PROGRAM 2 screen can be used to set the DC offset level. Either the knob or the decimal keypad may be used to set the DC offset level.
START $\emptyset$	Selects the start phase angle for output changes made to either voltage or frequency. This allows changing the output at a specific phase angle. The output on key also uses this phase angle setting to program the output voltage up to the set level after the output relay is closed. The default value for this field is RANDOM.

**4.2.5 MEASUREMENTS Screens**

The RS Series uses a DSP based data acquisition system to provide extensive information regarding the output of the Source. This data acquisition system digitizes the voltage and current waveforms and calculates several parameters from this digitized data. The result of these calculations is displayed in a series of measurement data screens. The actual digitized waveforms can also be displayed by selecting the Harmonics/Trace Analysis screen. A total of four measurement screens are used to display all this information.

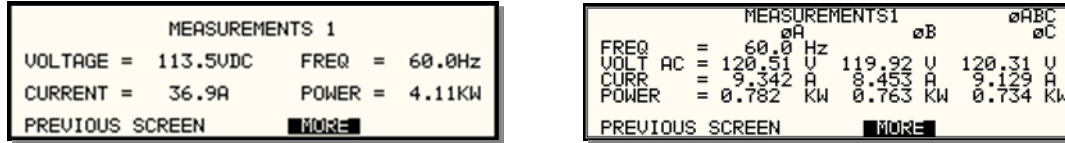

Figure 4-9: MEASUREMENTS Screen, Single Phase and Three Phase Modes

The first three Measurement screens available on the RS Series are not menus in that no changes can be made anywhere. Instead, these three screens provide load parameter readouts. The fourth measurement screen provides access to the advanced measurements and does offer several user accessible fields. The measurement screens can be reached by successively pressing the MEAS key, which will toggle to all four available screens.

In three-phase mode, measurements are available for each phase individually. To select the desired phase, use the PHASE key to toggle through phase A, B, C, or ABC. The ABC mode displays the data for all three phases simultaneously.

The following parameters are available in the first three measurement screens:

Entry	Description
<b>MEASUREMENT 1</b>	
VOLTAGE	When in AC or AC+DC mode, this value is the true rms output voltage measured at the voltage sense lines. In DC only mode, the voltage is the DC voltage including polarity.
CURRENT	When in AC or AC+DC mode, this value is the true rms output current drawn by the load. In DC only mode, the current is the DC current including polarity.
FREQ	When in AC or AC+DC mode, the output frequency is measured at the sense lines. When in DC only mode, this value always reads "DC".
POWER	In both AC and DC mode, this value is the real rms. power consumed by the load.
<b>MEASUREMENT 2</b>	
VA POWER	In AC or AC+DC mode, this value is the apparent rms. power consumed by the load. In DC mode, this value is always the same as the POWER readout.
PEAK CURR	This readout reflects the peak current value detected at the output. To measure inrush current for a unit under test, open the output relay and reset the peak current value using the PEAK CURR RESET entry. Then program the output voltage and frequency and turn on the output relay. The peak current measurement will continuously track the maximum current value detected until reset.

POWER FACTOR	This readout shows the power factor of the load.
CREST FACTOR	This readout displays the ratio between peak current and rms current.

### **MEASUREMENT 3**

VOLT THD	This readout displays the total voltage distortion for the selected phase. The distortion calculation is based on the H2 through H50 with the fundamental voltage (H1) in the denominator. Note that other common definitions of THD use the RMS value of the voltage as the denominator. This may result in different readings between instruments depending on the implementation chosen. The mode used by the power source is selectable over the bus.
CURR THD	This readout displays the total current distortion for the selected phase. The distortion calculation is based on the H2 through H50 with the fundamental current (H1) in the denominator. Note that other common definitions of THD use the RMS value of the current as the denominator. This may result in different readings between instruments depending on the implementation chosen. The mode used by the power source is selectable over the bus.
INST PK CURR	This readout reflects the instantaneous peak current value detected at the output. This value is updated continuously and does not require a reset operation like the PEAK CURR readout. The instantaneous peak current does not use a track and hold mechanism like the PEAK CURR measurement in the MEASUREMENT 2 screen. Instead, it tracks the peak current on a cycle-by-cycle basis. The INST PK CURR typically tracks the rms current and the crest factor.

### **Update Program Functions from Measurement Screen**

The Shuttle can be used to update program parameters such as voltage, frequency or current from the measurement screen. This can be achieved with the following sequence:

1. Select the program 1 screen using the PROG key.
2. Use the up and down key to select the desired function to update. (Selects parameter that will be changed by the shuttle once in the MEAS1 screen)
3. Select the measurement 1 screen by pressing the MEAS key.
4. The pointer symbol (▶) points to the programmed parameter (V, F or CL) that will be affected by turning the shuttle.

HARMONICS/TRACE ANALYSIS Screen

The fourth measurement screen is dedicated to the advanced measurements available on the RS Series. The Harmonics/Trace Analysis measurement screen is a true menu screen offering several user accessible fields. These fields are used to select the desired acquisition trigger and display mode. The actual data is displayed whenever the ENTER key is pressed while the cursor is on the VIEW or START field. The following fields are available on this menu:



Figure 4-10: HARMONICS/TRACE ANALYSIS Screen

Entry	Description
FUNCTION	Selects Voltage, Current or Both parameters for display.
VIEW	Available display modes are TABLE, BAR and TRACE.

TABLE mode: Displays the first 50 harmonics in a tabular text format.

VOLT HARMONIC MEASUREMENTS					
HR#	AMPL	PHASE	HR#	AMPL	PHASE
0	0.00	0.0	1	151.42	0.0
2	0.33	46.9	3	116.17	351.4
4	0.57	90.1	5	85.24	29.6
6	0.59	131.8	7	54.72	67.0
8	0.45	171.4	9	24.55	100.6

BAR mode: Displays the first 50 harmonics in a graphical bar chart display.

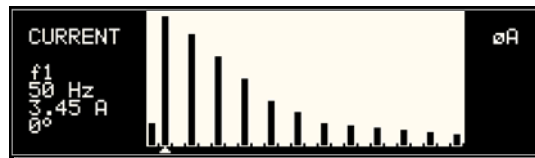

TRACE mode: Displays the selected Function in a time domain (waveform) graphical display.

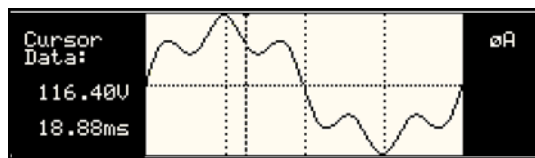

DATA MODE	Selects absolute or relative harmonics display for TABLE and BAR view modes. In relative mode, all harmonics are shown in a percentage of the fundamental, which is normalized at 100 %. In absolute mode, the harmonic amplitudes are shown in absolute volts or amperes.
-----------	--

	<p>This mode does not apply to the TRACE view display mode and is ignored when this mode is selected.</p>
SCALE	<p>Sets the horizontal time axis for the TRACE view display mode. The field range is 12 ms to 128 ms.</p> <p>This parameter is ignored when the TABLE or BAR view display mode is selected.</p>
TRIG MODE	<p>This field sets the trigger mode for the acquisition. Available options are SINGLE (single shot acquisition) or CONT (continuous acquisition). In SINGLE shot mode, the acquisition is triggered once each time the START field is selected and the ENTER key is pressed. The selected trigger source is used to determine the trigger point. Once the acquisition has been triggered, the data are displayed and do not change until the next acquisition is triggered. This mode is most appropriate for single shot events such as start up currents.</p> <p>In the CONT mode, acquisitions occur repeatedly and the data is updated on screen after each trigger occurs. This provides a continuous update of the data and is most appropriate for repetitive signals.</p>
TRIG SOURCE	<p>The trigger source selects the event that will trigger a measurement acquisition. Available options for this field are IMM (immediate), PHASE A or SET VOLT. The IMM trigger source causes the acquisition to trigger immediately when the ENTER key is pressed on the START field. Essentially, this is an asynchronous trigger event. The acquisition will always be triggered in this mode and data is available immediately.</p> <p>The PHASE A source will cause the acquisition to trigger on the occurrence of a set phase angle for the voltage on phase A. The trigger source is always phase A when in this mode, regardless of the phase selection shown in the top right corner of the display. When the acquisition is started, the acquisition system waits for the specified phase angle to occur before triggering the acquisition. This mode allows exact positioning of the acquisition data window with respect to the voltage waveform.</p> <p>The SET VOLT mode causes the acquisition to trigger at the specified voltage. This mode also programs the selected phase or all three phases when the measurement is started from the START field. As such, this trigger source selection also programs the output voltage to the selected rms level.</p>
TRIG PHASE / SET VOLT	<p>This field changes purpose, depending on the trigger source selected immediately above it. If the trigger source equals IMM or PHASE A, this field can be used to program the trigger phase angle (TRIG PHASE). In IMM mode, the value of this field is ignored.</p> <p>If the trigger source is set to SET VOLT, this field can be used to specify the rms voltage to program the output to and trigger the measurement on. The voltage value set here should not exceed the maximum voltage range selected or the rms capability for the wave shape selected on the phase or phases programmed.</p>

## TRIG DELAY

The trigger delay field allows the trigger point to be positioned anywhere in the acquisition window. A negative value will provide pre-trigger information on data leading up to the trigger event. The pre-trigger delay cannot exceed the length of the acquisition buffer. See paragraph 4.6.3.3 for details. A positive trigger delay positions the data window after the trigger event. Positive trigger delays can exceed the length of the acquisition buffer in which case the trigger event itself will not be in the buffer any more. The maximum value of the trigger delay is 1000 ms. The default trigger delay value is 0.0 ms, which puts the trigger event at the beginning of the acquisition window.

## START

The START field is used to start a new acquisition run. To start an acquisition, place the cursor on the START field and press the ENTER key. Once the ENTER key is pressed, the display toggles to the data display mode selected in the VIEW field as soon as the selected trigger event occurs. To return to the HARMONICS/TRACE ANALYSIS menu, press the ENTER key while in the data display mode.

To change display modes without triggering a new acquisition, make the desired changes in the menu and move the cursor to the VIEW field. Once on the VIEW field, press the ENTER key. This will not trigger a new acquisition, which means the original data is retained.

## 4.2.6 TRANSIENTS Menu



Figure 4-11: TRANSIENTS Menu

The transient menu provides access to the transient list data. Available list length is: 100 data points. This is represented by 100 transient step numbers from 0 through 99.

From the Transient menu, the desired transient step type can be selected. Based on the user's choice, the relevant transient type sub menu will be shown. The START/EDIT SEQUENCE sub menu allows the user to review and change any transient step or execute the transient list. When executing a transient list, transient steps are executed in an ascending numerical order. Steps that are not defined are skipped.

The following entries can be found in the TRANSIENTS menu:

<b>Entry</b>	<b>Description</b>
VOLT SURGE/SAG	Voltage surges and sags are temporary changes in amplitude. The output voltage will change from its present value to a user specified value for a specified duration. (Sag if the value is lower, surge if the value is higher.) After this period has expired, the output voltage returns to a user specified end value. This value may or may not be the same as the value present prior to the start of the sag or surge.
VOLT SWEEP/STEP	Voltage sweeps cause the output voltage to change from the present value to a user specified end value at a specified rate of change. A voltage step on the other hand is an instantaneous change in output voltage. The new value will be held for the duration period specified by the user. The final output voltage value of a sweep and a step transient step should be different than the value at the start of the transient step or no change in output value will occur.
FREQ SWEEP/STEP	This transient type is similar to a voltage sweep/step except it affects the frequency. Refer to the previous paragraph.
VOLT/FREQ SWEEP/STEP	This transient type combines the previous two types into a single step. The effect is that of changing the output voltage and frequency simultaneously.  Note: While this transient is programmed as a single transient step, two list entries are required to store this information. As such, every VOLT/FREQ SWEEP/STEP used will consume two list entries at a time.
START/VIEW SEQUENCE	This entry allows the user to switch to the transient execution menu. This menu provides a list of all available transient list steps and their sequence numbers. From this menu, transient list execution can be started.  The same menu can be used to view or edit any available transient list step or erase a step using the backspace key.

#### 4.2.6.1 VOLT SURGE/SAG sub menu

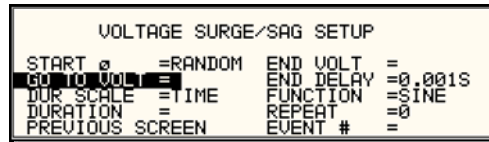

Figure 4-12: VOLTAGE SURGE/SAG SETUP Screen

The Voltage surge and sag screen shown in Figure 4-12 can be reached from the transient screen as follows:

1. Scroll to the VOLT SURGE/SAG entry using the up and down cursor keys.
2. Press the ENTER key to bring up the VOLT SURGE/SAG screen.

The VOLT SURGE/SAG screen has several data fields. All data fields that are blank to the right of the equal sign must be filled or an error message will occur when trying to leave this screen. The EVENT # is the last data field to be filled. Entering the event data field will cause the display to return to the TRANSIENT screen where a new selection can be made.

The VOLT/SURGE/SAG screen has the following fields:

START ø	This field will show the start phase angle of the voltage transient in degrees. Only one start phase angle per transient sequence is allowed. The start phase angle must be in the first transient event in the list. The start phase angle is not valid for DC transients. If no start phase angle is required, this field can be set to RANDOM by pressing the BACKSPACE (<-) key on the decimal keypad.
GO TO VOLT	This field will set the voltage level during the transient duration in volts
DUR SCALE	Duration scale default is time in seconds. Use the Shuttle knob to select CYCLES if desired. Note that durations expressed in cycles may cause rounding errors if the period of the selected frequency setting is not an integer number of mss. Thus, for 50 Hz applications, no rounding errors occur but for 60 Hz, the 16.66 ms period will cause a rounding error when converted. The Duration scale selection affects both the DURATION and END DELAY parameters.
DURATION	Duration is the time the output voltage level will dwell at the GO TO VOLT level. The DUR SCALE defines the time scale of this parameter in CYCLES or SECONDS
END VOLT	This is the output voltage level at the end of the transient EVENT and after a time specified by the DURATION
END DELAY	This is the time delay the voltage level will stay at the END VOLT level before it proceeds with the next transient event or completes the transient.
FUNCTION	This field can be used to select the wave shape to be used during this step of the transient sequence. Each step can use a different wave shape from the available library of 50 user-defined waveforms or the three standard waveforms. The output wave shape changes upon entry into each step and remains in effect for the duration of the step. The default wave shape is always the SINE (sine wave).



REPEAT	This is the number of times the SURGE/SAG transient event will repeat before it will proceed to the next event or exit the transient program. Note that the number of times the transient event is generated is equal to the REPEAT + 1. Leave this value at zero if only one execution of this event in the list is required.
EVENT #	This must be the last item in the transient edit screen. All data fields must be entered before inserting the EVENT #. The EVENT # takes a value from 1 to 99. The EVENT # defines the order of execution of the transient events in a multiple event transient. It is a good practice to enter spaced EVENT #'s to allow insertion of an EVENT later if needed. (For example, space them by 5.) Entry of a sequence EVENT # number will cause the display to return to the TRANSIENT screen.

#### 4.2.6.2 VOLTAGE SWEEP/STEP sub menu



Figure 4-13: VOLTAGE SWEEP/STEP SETUP Screen

The Voltage sweep and step screen shown in Figure 4-13 can be reached from the transient screen as follows:

1. Scroll to the VOLT SWEEP/STEP entry using the up and down keys.
2. Press the ENTER key to bring up the VOLTAGE SWEEP/STEP screen.

The VOLTAGE SWEEP/STEP screen has several data fields. All data fields that are blank to the right of the equal sign must be filled or an error message will occur when trying to leave this screen. The EVENT # is the last data field to be filled. Entering the event data field will cause the display to return to the TRANSIENT screen where a new selection can be made.

The VOLTAGE SWEEP/STEP screen has the following fields:

START	This field will show the start phase angle of the voltage transient in degrees. Only one start phase angle per transient sequence is allowed. The start phase angle must be in the first transient event in the list. The start phase angle is not valid for DC transient.
END VOLT	This is the output voltage level at the end of the transient event in volts.
DUR SCALE	Duration scale default is time in seconds. Use the Shuttle knob to select CYCLES if desired. Note that durations expressed in cycles may cause rounding errors if the period of the selected frequency setting is not an integer number of mss. Thus, for 50 Hz applications, no rounding errors occur but for 60 Hz, the 16.66 ms period will cause a rounding error when converted. The Duration scale selection affects both the DURATION and END DELAY parameters.
DURATION	Duration is the time it will take for the output voltage to reach the END VOLT level. As such, "Duration" will define the slew rate of the output voltage for the event. A duration of 0 seconds will cause the output voltage to reach the end voltage immediately. The DUR SCALE defines the time parameter CYCLES or SECONDS
END DELAY	This is the time delay the voltage level will stay at END VOLT before it proceeds with the next transient event or completes the transient.
FUNCTION	This field can be used to select the wave shape to be used during this step of the transient sequence. Each step can use a different wave shape from the available library of 50 user-defined waveforms or the three standard waveforms. The output wave shape changes upon entry into each step and remains in effect for the duration of the step. The default wave shape is always the SINE (sine wave).

REPEAT	This is the number of times the VOLTAGE SWEEP/STEP transient event will repeat before it will proceed to the next event or exit the transient program. Note that the number of times the transient event is generated is equal to the REPEAT + 1. Leave this value at zero if only one execution of this event in the list is required.
EVENT #	This must be the last item in the transient edit screen. All data fields must be entered before inserting the EVENT #. The EVENT # takes a value from 1 to 99. The EVENT # defines the order of execution of the transient events in a multiple event transient. It is a good practice to enter spaced EVENT #'s to allow insertion of an EVENT later if needed. (For example, space them by 5.) Entry of a sequence EVENT # number will cause the display to return to the TRANSIENT screen.

### 4.2.6.3 FREQUENCY SWEEP/STEP sub menu

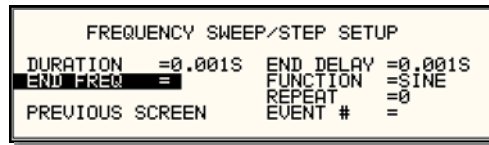

Figure 4-14: FREQUENCY SWEEP/STEP SETUP Screen

The Voltage sweep and step screen shown in Figure 4-14 can be reached from the transient screen as follows:

1. Scroll to the FREQ SWEEP/STEP entry using the up and down cursor keys.
2. Press the ENTER key to bring up the FREQ SWEEP/STEP screen.

The FREQ SWEEP/STEP screen has several data fields. All data fields that are blank to the right of the equal sign must be filled or an error message will occur when trying to leave this screen. The EVENT # is the last data field to be filled. Entering the event data field will cause the display to return to the TRANSIENT screen where a new selection can be made.

The FREQ SWEEP/STEP screen has the following fields:

DURATION	Duration is amount of the time the output frequency will take to reach the END FREQ level. Duration will define the slew rate of the output frequency for the event. A duration of 0 seconds will cause the output frequency to reach the end frequency immediately.
END FREQ	This is the output frequency at the end of the transient event in Hz.
END DELAY	This is the time delay the frequency will stay at END FREQ before it proceeds with the next transient event or completes the transient.
FUNCTION	This field can be used to select the wave shape to be used during this step of the transient sequence. Each step can use a different wave shape from the available library of 50 user-defined waveforms or the three standard waveforms. The output wave shape changes upon entry into each step and remains in effect for the duration of the step. The default wave shape is always the SINE (sine wave).
REPEAT	This is the number of times the FREQUENCY SWEEP/STEP transient will repeat before it will proceed to the next event or exit the transient. The number of times the transient event is generated is equal to the REPEAT + 1. Leave this value at zero if only one execution of this event in the list is required.
EVENT #	This must be the last item in the transient edit screen. All data fields must be entered before inserting the EVENT #. The EVENT # takes value from 1 to 99. The EVENT # defines the order of execution of the transient events in a multiple event transient. It is a good practice to enter spaced EVENT #'s to allow insertion of an EVENT later if needed. (For example, space them by 5.) Entry of a sequence EVENT # number will cause the display to return to the TRANSIENT screen.

#### 4.2.6.4 VOLTAGE/FREQUENCY SWEEP/STEP sub menu

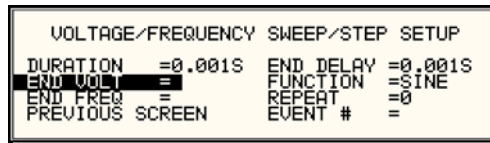

Figure 4-15 VOLTAGE/FREQUENCY SWEEP/STEP SETUP Screen

The Volt/freq sweep/step screen shown in Figure 4-15 can be reached from the transient screen as follows:

1. Scroll to the VOLT/FREQ SWEEP/STEP entry using the up and down cursor keys.
2. Press the ENTER key to bring up the VOLT/FREQ SWEEP/STEP screen.

The VOLT/FREQ SWEEP/STEP screen has several data fields. All data fields that are blank to the right of the equal sign must be filled or an error message will occur when trying to leave this screen. The EVENT # is the last data field to be filled. Entering the event data field will cause the display to return to the TRANSIENT screen where a new selection can be made.

The VOLT/FREQ SWEEP/STEP screen has the following fields:

DURATION	Duration is the amount of time the output voltage and frequency will take to reach the END FREQ and END VOLT levels. Duration will define the slew rate of the output voltage and frequency for the event. A duration of 0 seconds will cause the output voltage and frequency to reach their end value immediately.
END FREQ	This is the output frequency at the end of the transient event in Hz.
END VOLT	This is the output voltage at the end of the transient event in volts.
END DELAY	This is the time delay the output frequency and voltage will stay at END FREQ and END VOLT before proceeding with the next transient event or completing the transient.
FUNCTION	This field can be used to select the wave shape to be used during this step of the transient sequence. Each step can use a different wave shape from the available library of 50 user-defined waveforms or the three standard waveforms. The output wave shape changes upon entry into each step and remains in effect for the duration of the step. The default wave shape is always the SINE (sine wave).
REPEAT	This is the number of times the VOLTAGE/FREQUENCY SWEEP/STEP transient will repeat before it will proceed to the next event or exit the transient. The number of times the transient event is generated is equal to the REPEAT + 1. Leave this value at zero if only one execution of this event in the list is required.

**EVENT #** This must be the last item in the transient edit screen. All data fields must be entered before inserting the EVENT #. The EVENT # takes value from 1 to 99. The EVENT # defines the order of execution of the transient events in a multiple event transient. It is a good practice to enter spaced EVENT #'s to allow insertion of an EVENT later if needed. (For example, space them by 5.) Entry of a sequence EVENT # number will cause the display to return to the TRANSIENT screen.

#### 4.2.6.5 START/VIEW TRANSIENT SEQUENCE sub menu

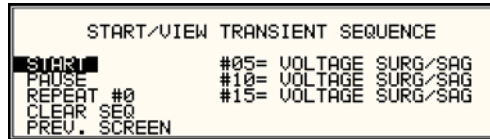

Figure 4-16: START/VIEW TRANSIENT SEQUENCE Screen

The START/VIEW TRANSIENT SEQUENCE screen is used to control transient execution. It also provides an overview of available transient list events. This list appears in the order they were assigned event numbers. Editing an existing event can be accomplished from this screen by positioning the cursor on the event to be edited and pressing the ENTER key. This method can also be used to review the parameters of a previously entered event.

The START/VIEW TRANSIENT SEQUENCE screen has the following fields:

START / ABORT	The START field is used to start a transient execution. When the cursor is positioned on the START field and the ENTER key is pressed, transient execution starts. The output relay must be closed or an error message will appear and the transient will not start.  Once a transient is in progress, this field changes to ABORT and can be used to abort a transient in progress. If the transient completes execution, the field reverts back to START.
PAUSE / RESUME	The PAUSE field may be used to suspend execution of a transient list in progress. If the cursor is on the PAUSE field and the ENTER key is pressed, the transient is suspended and this field changes to RESUME. Pressing the ENTER key again will cause the transient list to resume execution from the point where it was suspended.
REPEAT #	This field determines the number of times a transient list is repeated. The default value is zero, which means the programmed list runs only once. The range for this field is from 0 through 99999. This repeat function should not be confused with the REPEAT function available for individual events. The event specific repeat value will cause only that event to be repeated, not the entire list.
CLEAR SEQ	Moving the cursor to this field and pressing the ENTER key will cause the entire programmed transient list to be erased. Be careful not to press ENTER accidentally while on this field as you will lose the programmed transient list. Note that a list may be stored as part of the front panel setup in the nonvolatile memory registers.

## 4.2.7 WAVEFORMS Menu

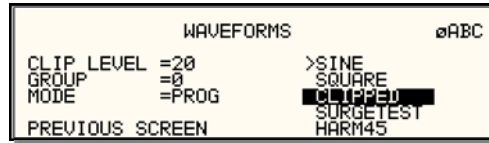

Figure 4-17: WAVEFORMS Menu

The WAVEFORMS menu allows selection of the wave shape for each phase individually or all phases at once. In three-phase mode, the mode is determined by the phase coupling.

The selected phase is shown in the top right corner of the display ( $\emptyset A$ ,  $\emptyset B$  or  $\emptyset C$ ). The selected wave shape will be applied to that phase. If all phases are selected (phase coupling), the selected waveform will apply to all three phases.

The following fields are available in the WAVEFORMS menu:

### CLIP LEVEL

This parameter determines the amount of total harmonic distortion of the built-in CLIPPED sine wave waveform. The range is 0 % through 20 % THD.

Note that changing the distortion level of the CLIPPED sine wave while the CLIPPED sine wave is used on the output of one or more phases, forces the output of the AC Source to be dropped momentarily. To avoid this, make sure none of the phases is using the CLIPPED sine wave function when changing the clip level.

### GROUP

The group field displays the currently selected waveform group. There are four groups of 50 user-defined waveforms each for a total of 200 waveforms. Only one group can be active at a time however. This field only displays the selected waveform group. It cannot be used to change the actual group selected. Group selection must occur at power up and is done from the INITIAL SETUP 3 screen. See section 4.2.11.3 for details.

### MODE

The mode field determines the operation mode of the WAVEFORMS display screen. Available options for this field are:

**PROG:** This mode is used to change the programmed wave shape function on the selected phase. This is also the default mode of operation.

**VIEW (T):** This mode can be used to display any of the available user defined waveforms in a time domain display. Previewing a waveform can be useful if you are unsure about the nature of the waveform that was stored.

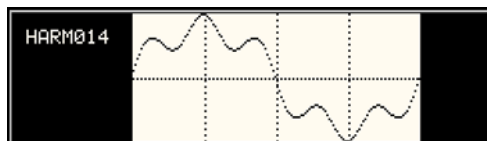

VIEW (F): This mode can be used to display any of the available user defined waveforms in a frequency domain display. Waveform data is shown by harmonic amplitude and phase relative to the fundamental frequency. Previewing a waveform can be useful if you are unsure about the nature of the waveform that was stored.

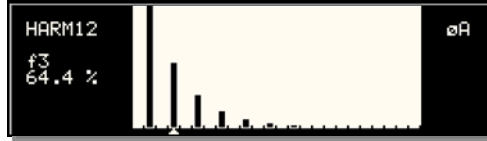

#### SINE

The SINE is a standard waveform that is always available. It does not consume any of the user defined waveform registers and is always displayed in the waveform list. A right arrow indicates the waveform is presently selected for the phase. If the cursor is moved to this field, the ENTER key will execute the selected MODE. If the mode is set to PROG, pressing ENTER while the cursor is on the SINE entry will select the sine wave for the phase shown in the top right corner of the display.

Note that the VIEW modes are not available for any of the three standard waveforms.

#### SQUARE

The SQUARE is a standard waveform that is always available. It does not consume any of the user defined waveform registers and is always displayed in the waveform list. A right arrow indicates the waveform is presently selected for the phase. If the cursor is moved to this field, the ENTER key will execute the selected MODE. If the mode is set to PROG, pressing ENTER while the cursor is on the SQUARE entry will select the square wave for the phase shown in the top right corner of the display.

Note that the VIEW modes are not available for any of the three standard waveforms.

#### CLIPPED

The CLIPPED is a standard waveform that is always available. It does not consume any of the user defined waveform registers and is always displayed in the waveform list. A right arrow indicates the waveform is presently selected for the phase. If the cursor is moved to this field, the ENTER key will execute the selected MODE. If the mode is set to PROG, pressing ENTER while the cursor is on the CLIPPED entry will select the clipped sine wave for the phase shown in the top right corner of the display. The CLIP LEVEL field determines the amount of clipping.

Note that the VIEW modes are not available for any of the three standard waveforms.

#### USER DEFINED

A list of user defined waveforms appears immediately below the three standard waveforms. If no user-defined waveforms were downloaded to the power source, this list will be blank. User defined waveforms can be given a symbolic name of up to twelve characters. The use of any of the three standard waveform names (SINE, SQUARE and CLIPPED) should be avoided, as the RS controller will reject it.



A right arrow indicates the waveform is presently selected for the phase. If the cursor is moved to this field, the ENTER key will execute the selected MODE. If the mode is set to PROG, pressing ENTER while the cursor is on the user defined entry will select the custom waveform for the phase shown in the top right corner of the display.

If the MODE is set to either VIEW option, the waveform data under the cursor will be displayed when the ENTER key is pressed. Press the ENTER key again to return to the WAVEFORMS menu.

#### 4.2.8 ADVANCE MEAS. Menu

This entry in the MENU 2 screen displays the HARMONICS/TRACE ANALYSIS screen which is covered in section 4.6. This field can be used in lieu of the MEAS key to directly bring up the advanced measurements screens.

#### 4.2.9 APPLICATIONS Menus

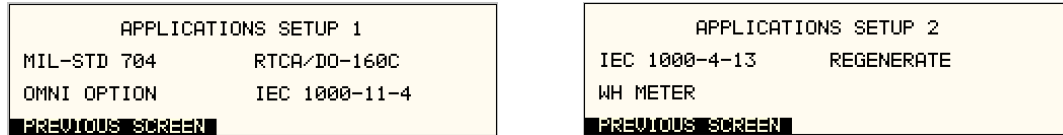

Figure 4-18: APPLICATIONS Menus

The APPLICATIONS menu provides access to the optional application specific pre-programmed test sequences. Since these test sequences are optional, this menu may have no choices if none of the options are installed. The following entries may be found in the APPLICATIONS menu:

Entry	Description
MIL-STD 704	Test sequence for MIL standard 704 AC and DC tests.
OMNI OPTION	This entry selects the OMNI control menu. The OMNI option provides a lumped reference impedance for use in IEC 61000-3-3 or IEC 61000-3-11 Flicker test applications. If the OMNI option is installed, this screen allows the impedance to be ENGAGED or BYPASSED.
RTCA/DO-160	Test sequence for RTCA DO160 commercial aviation AC and DC tests.
IEC-1000-4-11	Test sequences for IEC 61000-4-11 Voltage Dips and Variations test standard.
IEC-1000-4-13	Test sequence for IEC 61000-4-13 Harmonics and Inter harmonics test standard.
WH METER	Watt Hour meter measurement option. Tracks energy usage over a period of time and calculates Watt Hours used.
REGENERATE	The REGENERATE entry is enabled only if the –SNK option is installed. It provides access to the setting for driving regenerative load.

#### 4.2.10 SETUP REGISTERS Menu

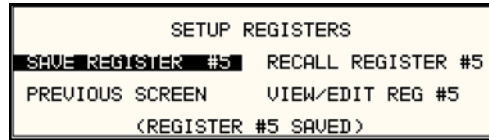

Figure 4-19: SETUP REGISTERS Menu

The SETUP REGISTERS menu allows the user to store and recall complete instrument setups, including transient program lists. A total of 16 non-volatile setup registers is available, numbered sequentially from 0 through 15.

The following entries can be found in the SETUP REGISTERS menu:

<b>Entry</b>	<b>Description</b>
SAVE REGISTER	Save present instrument setup to a register number selected by the user. The numeric data entry keypad should be used to enter a number between 0 and 15. Once the ENTER key is pressed, all settings are saved. A message will appear at the bottom of the screen to confirm the save operation.
RECALL REGISTER	Recall instrument setup from a register number selected by the user. The numeric data entry keypad should be used to enter a number between 0 and 15. Once the ENTER key is pressed, all settings are recalled. A message will appear at the bottom of the screen to confirm the recall operation.
VIEW/EDIT REGISTER	The View/Edit entry can be used to display the contents of a setup register before it is recalled. After the user enters a register number to view or edit and presses the ENTER key, the PROGRAM screen will appear. All parameters that will be changed by recalling the register will be blinking. If ENTER is pressed again, the register will be recalled and the new values take effect. To edit the register content, change all parameters that need to be changed. Pressing ENTER will save the new values and make them active.

### 4.2.11 UTILITY Menus

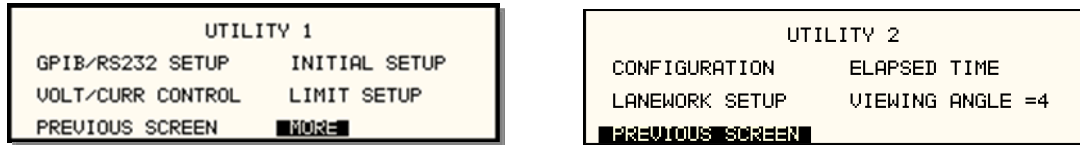

Figure 4-20: UTILITY Menus

The UTILITY menus provide access to less frequently used setup items. There is no connection between the various entries in the UTILITY menu other than there is no other logical place to put them. The following entries can be found in the UTILITY menu:

Entry	Description
<b>UTILITY 1</b>	
GPIB/RS232 SETUP	This entry provides access to the setup parameters for either the IEEE-488, RS232, USB or LAN interface. All parameters are saved in non-volatile memory so there is rarely a need to change these values.
VOLT/CURR CONTROL	<p>The voltage and current control menu can be used to select the current limit method, the voltage sense source.</p> <p>The standard available voltage range pairs are 150 Vac and 300 Vac in AC mode or 200 Vdc and 400 Vdc in DC mode.</p> <p>The two current limit choices are Constant Voltage and Constant Current. Constant Voltage mode will maintain the set voltage at the output until the load current exceeds the current limit setting at which time the voltage will be dropped to zero. This effectively shuts off the AC source output in case of an overload condition. This mode has user programmable trip delay, which is located in the same menu.</p> <p>Constant Current mode will maintain the load current at the maximum level set by the current limit value, even if the maximum power level is exceeded. This is done by reducing the voltage as needed. As such, the voltage will be reduced from the set level down to zero depending on the load requirement. This mode is useful for starting up motor or capacitor loads that may require a high inrush current. This mode also has a user programmable trip delay.</p> <p>Voltage sensing for regulation and measurement can be selected for internal or external. External voltage sensing can compensate for voltage drops caused by load cable impedance. To achieve the best output regulation select external sense and connect the voltage sense wires at the load.</p>
INITIAL SETUP	The initial setup menu can be used to determine the AC source settings at power up. CAUTION: The initial setup can be used to power up the AC source with the output on and a high voltage present at the output. For normal situations, this is not recommended due to the potential danger to operators. It is recommended that the initial voltage be set low and/or the output relay be programmed to OFF for most situations.

## LIMIT SETUP

The Limit menu shows the frequency, voltage and current limit capabilities of the AC source. Any attempt to program the output beyond these limits will result in a “-222 Data Out of Range error”. Note that these limits are hardware determined and cannot be changed by the user. They are shown for reference only.

**UTILITY 2**

## CONFIGURATION

The Configuration menu shows the installed options. This screen is for reference only and typically, no fields can be changed by the user.

## LANETWORK SETUP

Displays or sets LAN interface settings. If the LAN option is present, this screen may be used to view or change LAN parameters. The MAC address is fixed and cannot be changed. IP and Gateway addresses are normally assigned by the network DHCP server. Changes to the other fields can be made by pressing the SET button first. The indicator in the top right hand of the screen will change from “NC” to “SET”. Note that any setting changes made won’t take effect till after the unit has been powered down and back up.

To set the LAN interface to AUTO IP mode, set the IP and Gateway address to all zeros. This will cause the IP to be requested from the network the next time power is cycled. To manually set the IP and Gateway address, enter the address from the keypad.

The Port address is normally set to 5025. The number of host bits is a function of the network address range.

```

LANetwork Setup          NC
MAC Address =00:00:00:00:00:00
IP Address  =69.35.221.81
GWAddress   =27.205.119.223
PORT Address =5025      HostBits =24
PREVIOUS SCREEN

```

**ELAPSED TIME**

The elapsed time screen, when selected from the UTILITY menu, will appear for about 3 seconds. The elapsed time shown is the cumulative amount of time the power source has been on from its initial build. This value is read only and cannot be changed by the user.

The same screen also displays the internal AC source ambient temperature in degrees C.

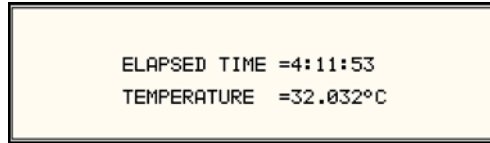
**VIEWING ANGLE**

The viewing angle can be used to change the contrast ratio of the LCD display. The range of the viewing angle parameter is from -10 to +10. Setting the right viewing angle is matter of personal taste. Set this parameter to a value that is most comfortable for the user. To save a new viewing angle setting, change the number to the desired value using the knob or the keypad and press the **ENTER** key. The new value will blink. To save it permanently, press the **SET** key.

#### 4.2.11.1 GPIB/RS232 (incl. USB/LAN) SETUP menu

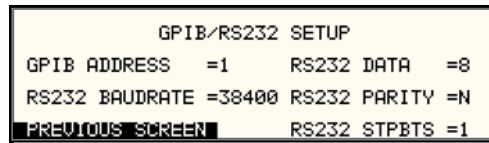

Figure 4-21: GPIB/RS232 SETUP Menu

The GPIB/RS232 SETUP menu may be used to change the interface parameter settings for both the IEEE-488 interface and the RS232, USB or LAN interface. The number of interfaces available will depend on the specific model and options as well as the time of manufacture. Older RS models do not offer USB or LAN interfaces. Newer models can be equipped with as many as 4 different interfaces although only one can be used at the same time.

Refer to the RS Series Programming Manual P/N 7003-961 distributed in Adobe PDF format on the same CD ROM as this user manual for more details on using the RS232, USB or LAN interface.

The following parameters can be set from this menu:

GPIB ADDRESS	Sets the IEEE-488 address used by the AC source. The address value can be set from 0 through 31. Address 0 is often reserved for the IEEE-488 controller. The factory setting is address 1. Once changed, the IEEE-488 address is retained in nonvolatile memory.
RS232 BAUDRATE	This field can be used to set the RS232 baud rate to either 9600, 19,200, 38,400, 57600 or 115,200 baud. The baud rate set on the AC source must match the one programmed for the communications port of the controller. Baud rates higher than 115200 are provided for the USB and LAN interface modes only. The same setting is used for USB and LAN modes. For use with either USB or LAN, the baud rate in this screen must be set to <b>460800</b> . See UTILITY 2 screen for other LAN setup parameters.
RS232 DATA	This field is used to set the number of data bits to either 7 or 8. Factory setting is 8 bits. This value must match the number of data bits set on the communications port of the controller. For USB or LAN use, always use factory settings.
RS232 PARITY	This field is used to set the parity. Available options are Even (E), Odd (O) or no parity (N). Factory setting is No parity. This value must match the parity set on the communications port of the controller. For USB or LAN use, always use factory settings.
RS232 STPBITS	This field is used to set the number of stop bits used on the serial port. Available options are 1 or 2 bits. Factory setting is 1 stop bit. This value must match the parity set on the communications port of the controller. For USB or LAN use, always use factory settings.

The number of start bits is always fixed to 1 bit.

#### 4.2.11.2 VOLTAGE/CURRENT CONTROL SETUP menu

```

VOLTAGE/CURRENT CONTROL SETUP
ALC MODE =ON      TRIP DELAY =0.10S
OL MODE  =CC      VOLT SENSE =INT
PREVIOUS SCREEN NO. OUTPUT =THREE

```

Figure 4-22: VOLTAGE/CURRENT CONTROL SETUP Menu

The VOLTAGE/CURRENT CONTROL SETUP menu may be used to set output voltage and current control parameters. These parameters are not frequently changed in the normal operation of the AC source and are thus located on the UTILITY rather than the PROGRAM menu.

The following options are available in this menu:

ALC MODE	Automatic Level Control of programmed output voltage. This mode will use the internal voltage measurements to adjust the output voltage continuously as needed. This effectively increases the output accuracy and regulation beyond what is possible with ALC off.
OL MODE	This field is used to select constant current (CC) or constant voltage (CV) mode. The constant current mode will limit the maximum amount of current drawn by the load to the set value. The voltage will be reduced as needed after the trip delay time to maintain the level of programmed current.  The constant voltage mode will maintain the set voltage as long as the current drawn by the load does not exceed the current limit programmed. If the current limit is exceeded, the output will be shut off after the trip delay time.
TRIP DELAY	The trip delay field may be used to set the amount of time to hold off the current limit trip point. The minimum amount of time is 100 ms or 0.1 sec. The maximum amount of time is 5.00 sec.
VOLT SENSE	This field selects the internal or external sense line inputs. Internal sense does not require the external sense lines to be connected as sensing occurs at the output relay of the AC source. For best results, connect the external sense lines and select the EXT sense mode in this field. This will compensate for voltage drop in the cables to the load. The measurements are also taken at the sense points, so the external sense mode should be used for best measurement results.
NO. OUTPUT	This field is always set to three to indicate the 3 phase output configuration of the RS Series.



### 4.2.11.3 INITIAL SETUP menu

INITIAL SETUP 1		INITIAL SETUP 2	
VOLTAGE = 5.0VAC	FREQ = 123.0Hz	VOLT RANGE =150V	OL MODE =CC
CURR LIMIT = 2.0A	PHASE = 0.0°	VOLT MODE =AC	OUTPUT RELAY =OFF
PREVIOUS SCREEN	MORE	PREVIOUS SCREEN	MORE

INITIAL SETUP 3	
VOLT SENSE =INT	CLOCK MODE =STAND
WAVE GROUP =0	NO. OUTPUT =LAST
PREVIOUS SCREEN	VOLT ALC =OFF

Figure 4-23: INITIAL SETUP Menus

Any time the power source is powered up, the output will reflect the values stored as the INITIAL setup values. This allows the unit to be powered up in a known state at all times. The INITIAL values can be set in the INITIAL SETUP menus.

The initial setup can be used to power up the power source with the output on and a high voltage present at the output. For normal situations, this is not recommended due to the potential danger to the operator. It is recommended that the initial voltage be set low and/or the output relay be programmed to OFF for most situations.

The following fields are provided in the INITIAL SETUP menus:

Entry	Description
<b>INITIAL SETUP 1</b>	
VOLTAGE	Sets the power-on AC voltage for AC and AC+DC modes or the DC voltage for DC mode.
CURR LIMIT	Sets the power-on current limit value.
FREQ	Sets the power-on frequency value.
PHASE	Sets the power-on frequency for phase A with respect to an external sync signal. If the internal oscillator is used (default) this setting has no effect.
<b>INITIAL SETUP 2</b>	
VOLT RANGE	Sets the power-on voltage range value.
VOLT MODE	Sets the power-on voltage mode. Available settings are AC mode, DC mode or AC+DC mode.
OL MODE	Sets the power-on overload mode. Available settings are Constant Current (CC) or Constant Voltage (CV) mode.
OUTPUT RELAY	Sets the power-on state of the output relay. Available settings are ON or OFF.
<b>INITIAL SETUP 3</b>	
VOLT SENSE	Sets the power-on state of the voltage sense mode. Available settings are Internal (INT) or External (EXT).

WAVE GROUP	Sets the user defined waveform group that will be loaded at power on. Available groups are 0, 1, 2 and 3. Each group can contain up to 50 user-defined waveforms. A waveform group can only be loaded at power up. To change groups, you must change this field to the desired new group and cycle the power to the AC source or issue a *RST command over one bus.
CLOCK MODE	Sets the clock source used at power up. Available settings are Stand Alone (STAND), MASTER (-LKM clock and lock master), and AUX (-LKS clock and lock auxiliary).
NO. OUTPUT	This field is always set to THREE can cannot be changed. It reflects the three phase output configuration of the RS Sereis.
VOLT ALC	Determines ALC mode at power on. The ALC mode adjusts the output voltage based on internal voltage measurement system and provides enhanced output regulation and accuracy. Available settings are ON, OFF or REG.

#### 4.2.11.4 LIMIT SETUP screen

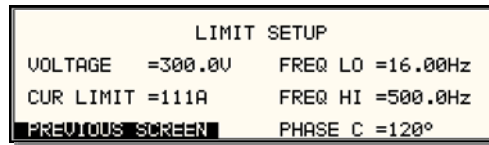

Figure 4-24: LIMIT SETUP Menu

The limit setup screen is not a menu but only serves to inform the user of the hardware capabilities of the AC source. The cursor can be moved to any of the fields in this screen but none of these fields can be changed. The following information is provided on this screen:

<b>Entry</b>	<b>Description</b>
VOLTAGE	Maximum AC rms or DC voltage available in the high voltage range.
CUR LIMIT	Maximum AC rms current limit available in the low voltage range.
FREQ LO	Lowest possible fundamental frequency that can be programmed.
FREQ HI	Highest possible fundamental frequency that can be programmed.
PHASE C	Phase angle of phase C with respect to phase A in three phase mode. If the AC source is a single phase model, this field will shown 0°. If the AC source is a split phase model, this field will shown 180°.

**4.2.11.5 CONFIGURATION SETUP screens**

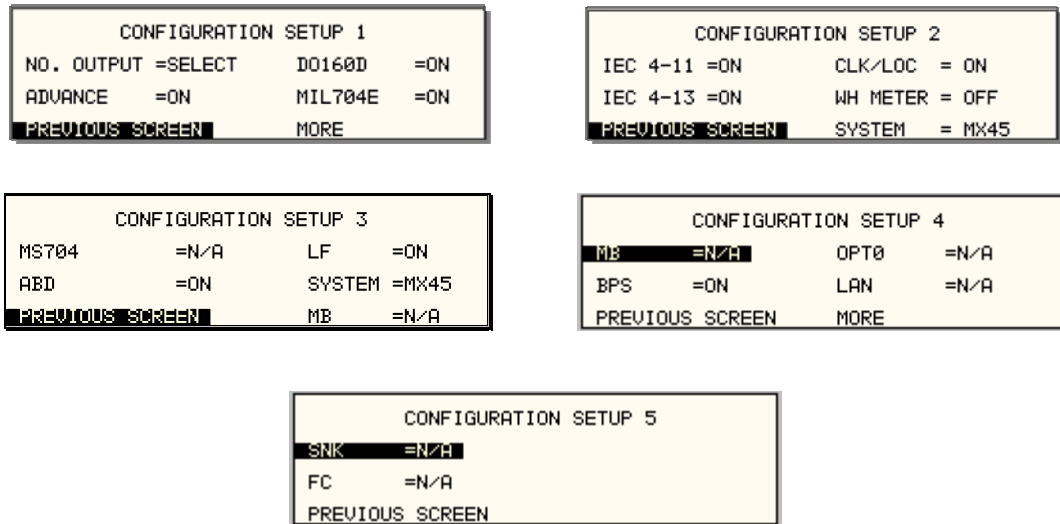

Figure 4-25: CONFIGURATION SETUP Menus

The configuration setup screens are not menus but only serve to inform the user of the software options installed in the AC source. The cursor can be moved to any of the fields in this screen but none of these fields can be changed. The following information is provided on this screen:

Entry	Description
<b>CONFIGURATION SETUP 1</b>	
NO. OUTPUT	Displays the phase mode option. SELECT indicates the phase mode option is installed and the user can select between single and three phase modes of operation.  FIXED indicates the phase mode option is not installed and only single phase or three phase mode of operation is possible.
ADVANCE	This field indicates the presence of advanced capabilities for waveform generation and measurement analysis are present.
DO160	Indicates the presence of the RTCA DO160 test option. If this option is installed, this field will show ON. If this option is not installed, this field will show N/A (not available).
MIL704	Indicates the presence of the MIL/STD-704 Revision D and E test option. If this option is installed, this field will show ON. If this option is not installed, this field will show N/A (not available).
<b>CONFIGURATION SETUP 2</b>	
IEC 4-11	Indicates the presence of the IEC 1000-4-11 test option. If this option is installed, this field will show ON. If this option is not installed, this field will show N/A (not available).
IEC 4-13	Indicates the presence of the IEC 1000-4-13 test option. If this option is installed, this field will show ON. If this option is not installed, this field will show N/A (not available).

CLOCK/LOCK	Indicates the presence of the -LKS clock and lock auxiliary option. For units without -LKS, this field is set to N/A. For units with the -LKS option installed, this field is set to ON. Note that master unit (with -LKM) also has this field set to N/A.														
WH METER	Indicates the presence of the Watt Hour Meter option.														
SYSTEM	Shown here on Series I models only. See CONFIGURATION SETUP 3 screen below.														
	<b>CONFIGURATION SETUP 3</b>														
MS704	Indicates the presence of the MIL/STD-704 Revision A through F test option. If this option is installed, this field will show ON. If this option is not installed, this field will show N/A (not available).														
ABD	Indicates the presence of the ABD0100.1.8 test option. If this option is installed, this field will show ON. If this option is not installed, this field will show N/A (not available).														
LF	Indicates the presence of the Low Frequency limit option. If this option is set, the maximum frequency that can be programmed is 500 Hz.														
SYSTEM	This field sets the controller for the correct RS system configuration. Available settings are: <table border="0" style="width: 100%;"> <tr> <td>RS90</td> <td>RS90 system Master</td> </tr> <tr> <td>RS180</td> <td>RS180 system Master</td> </tr> <tr> <td>RS270</td> <td>RS270 System Master</td> </tr> <tr> <td>RS360</td> <td>RS360 system Master</td> </tr> <tr> <td>RS450</td> <td>RS450 system Master</td> </tr> <tr> <td>RS540</td> <td>RS540 System Master</td> </tr> <tr> <td>AUX</td> <td>Auxiliary System.</td> </tr> </table> If this field is set incorrectly, the current limit scaling and current measurement will be off by a factor of three. Changes made to the SYSTEM field will not take effect until <b>AFTER</b> power on the RS system is cycled. (Off, the back on).	RS90	RS90 system Master	RS180	RS180 system Master	RS270	RS270 System Master	RS360	RS360 system Master	RS450	RS450 system Master	RS540	RS540 System Master	AUX	Auxiliary System.
RS90	RS90 system Master														
RS180	RS180 system Master														
RS270	RS270 System Master														
RS360	RS360 system Master														
RS450	RS450 system Master														
RS540	RS540 System Master														
AUX	Auxiliary System.														
MB	Indicates the presence of the Multi-box option. If this option is set, the SYSTEM field (above) can be changed to accommodate reconfiguration of the RS system. If this option is not set, the SYSTEM configuration is fixed and cannot be changed by the user.														

---

**NOTE:** If the MB option is enabled, great care **MUST** be taken to set the correct SYSTEM setting for the configured hardware. Failing to do so will result in incorrect operation of the RS system and could even result in damage of RS or the equipment under test.

---



---

**NOTE:** Options –A350, AMD24 and –B787 are only visible using the \*OPT? Bus command and do not have a visible field in the configuration screen for firmware revisions lower than 4.60. For FW revision of 4.60 or higher, see CONFIGURATION SETUP 4 screen.

---

	<b>CONFIGURATION SETUP 4</b>
MB	This entry was moved from CONFIGURATION SETUP 3 to CONFIGURATION SETUP 4. Its purpose remains the same. For details, see CONFIGURATION SETUP 3 manual section on previous page.

MANUAL	This field does not apply to RS products and is always set to N/A.
OPT0, OPT1, OPT2	This field indicates the presence of the following three options: OPT0 = A350 Avionics option (-A350) OPT1 = AMD24 Avionics option (-AMD) OPT2 = B787 Avionics option (-B787) The scroll through the three available OPTn fields, use the shuttle. ON indicates the option is present, N/A indicates the option is not installed.
LAN	This field indicates the presence of the LAN Ethernet interface option. ON indicates the option is present, N/A indicates the option is not installed.
SNK	This field indicates the presence of the Current Sink regenerative mode option. ON indicates the option is present, N/A indicates the option is not installed.
FC	This field indicate the presence of the FC option when is ON. The output frequency will step by $\pm 0.15\%$ of program value.

#### 4.2.12 MEASUREMENT CAL FACTORS Menu

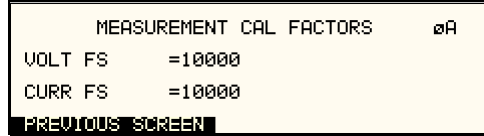

Figure 4-26: MEASUREMENT CAL FACTORS Menu.

The MEASUREMENT CAL FACTORS menu provides access to the measurement calibration parameters. The parameters apply to the selected mode of operation (AC or DC mode). For three phase configurations, the PHASE keys toggle between the three calibration screens for each phase. These parameters are password protected and can only be changed after the calibration password has been entered. Refer to the calibration section in this manual for details on performing a calibration.

<b>Entry</b>	<b>Description</b>
VOLT FS	Full scale voltage measurement calibration factor.
CURR FS	Full scale current measurement calibration factor.

### 4.2.13 OUTPUT CAL FACTORS Menu

```

      OUTPUT CAL FACTORS      mA
VOLT FS   =20000  IMP REAL FS =50
VOLT ZERO =60    IMP REACT FS =100
PHASE OFST=0.0°  IMP REAL MIN =10
IHARM FS  =200   IMP REACT MIN=60
PREVIOUS SCREEN
  
```

Figure 4-27: OUTPUT CAL FACTORS Menu (Series II only)

The OUTPUT CAL FACTORS menu provides access to the output calibration parameters. These parameters are password protected and can only be changed after the calibration password has been entered. For three phase configurations, the PHASE keys toggle between the three calibration screens for each phase. Refer to the calibration section in this manual for details on performing a calibration.

The following calibration factors are available from this menu:

Entry	Description
VOLT FS	Full scale voltage output calibration factor.
VOLT ZERO	Zero offset voltage calibration factor.
PHASE OFST	Phase offset calibration factor. Compensates for phase shift caused by AC amplifier.
IHARM FS	Option –413 Inter harmonic calibration coefficient.
IMP. REAL FS	Not available on RS Series.
IMP. REACT FS	Not available on RS Series.
IMP. REAL MIN	Not available on RS Series.
IMP. REACT MIN	Not available on RS Series.



## 4.3 Output Programming

### 4.3.1 Set the Output

Output parameters are all set from the PROGRAM screen.

1. Use the MENU key and select the PROGRAM entry.
  2. Press the ENTER key to bring up the PROGRAM menu.
- or
2. Use the PROG key to directly bring up the PROGRAM menu.

There are two methods for programming output parameters:

IMMEDIATE mode

SET mode

### 4.3.2 Slewing Output Values with the Knob in IMMEDIATE Mode

The default mode of operation is an immediate mode in which changes to output parameters made with the knob or the entry keypad are immediately reflected at the output.

To change the output voltage:

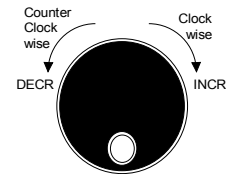
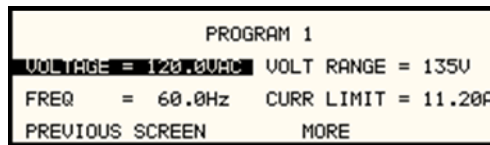

1. Place the cursor on the VOLTAGE entry
2. Rotate the knob clockwise to increase the value, counterclockwise to decrease the value

These changes take effect immediately.

To change the output frequency:

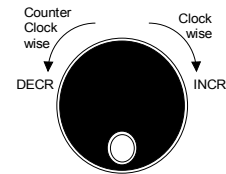
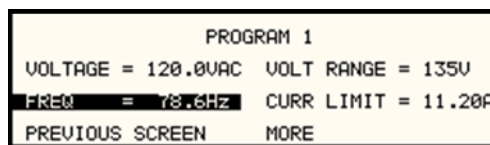

1. Place the cursor on the FREQ entry
2. Rotate the knob clockwise to increase the value, counterclockwise to decrease the value

These changes take effect immediately.

### 4.3.3 Change Output Values with the Knob in SET Mode

The SET mode of operation is a mode in which changes to output parameters made with the knob or the entry keypad do not affect the output until the ENTER key is pressed. The AC source is put in this SET mode by pressing the SET key.

To change the output voltage:

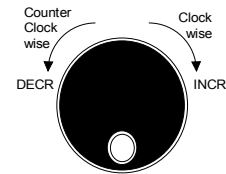
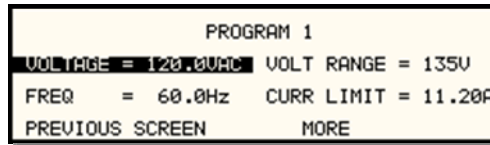

1. Press the SET key
2. Place the cursor on the VOLTAGE entry
3. Rotate the knob clockwise to increase the value, counterclockwise to decrease the value
4. The VOLTAGE field will be blinking to indicate a change in settings but the output remains unchanged.
5. Place the cursor on the FREQ entry
6. Rotate the knob clockwise to increase the value, counterclockwise to decrease the value
7. The FREQ field will be blinking to indicate a change in settings but the output remains unchanged.
8. Press the ENTER key.

Both new voltage and frequency output values are now present at the output. The unit has returned to immediate mode of operation until the SET key is pressed again.

#### 4.3.4 Change Output Values with the shuttle knob from the MEASUREMENT 1 screen

Basic output settings such as voltage and frequency can be changed from the MEAS 1 screen by using the following procedure:

1. Select the PROGRAM 1 screen by pressing the PROG key and position the cursor on either the Voltage or Frequency setting field.
2. Select the MEASUREMENT 1 screen by pressing the MEAS key. A small arrow will be showing in front of either the Voltage or Frequency measurement readout.
3. The shuttle knob can now be used to increment or decrement the selected parameter.

If three-phase mode is selected in the MEASUREMENT 1 screen, slewing the knob while the voltage is selected will change the output voltage on all three phases. If only one phase is selected, only the output of the selected phase will be affected.

#### 4.3.5 Changing Voltage Output Modes

The RS Series supports AC mode, DC mode and AC+DC mode. The voltage mode can be selected from the PROGRAM 2 screen, VOLT MODE field. The shuttle or +/- key will toggle between available modes. It is recommended to set the initialization settings to the required operating mode so the unit powers up in the correct voltage mode<sup>1</sup>. If not, the mode must be selected before applying output power to prevent applying to wrong type of voltage.

## 4.4 Waveform Management

The RS Series with 3Pi controller employs independent arbitrary waveform generators for each phase. This allows the user to create custom waveforms. In addition, three standard waveforms

<sup>1</sup> If the mode is changed after power up and after the output relay is closed for the first time after power up, the measurement offset calibration may not be correct. A phase mode change (-3Pi only) may be used to recalibrate the measurement offset.

are always available. This chapter covers issues that relate to defining, downloading and managing custom waveforms.

#### 4.4.1 Standard Waveforms

For most AC applications, a sine wave shape is used. The sine wave is one of the standard waveforms provided on all RS Series models. This standard sine wave is always available and is the default waveform at power-on. On RS models with the 3Pi controller, two more standard waveforms are available, square and clipped.

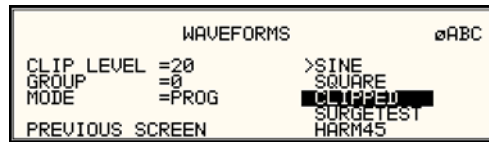

Figure 4-28: Selecting a Waveform

The square wave provides a high frequency content waveform with relative fast rise and fall times. Due to AC amplifier bandwidth limitations, the frequency content of the standard square wave has been kept within the amplifier's capabilities. As the fundamental frequency is increased, the relative contribution of higher harmonics is reduced.

The clipped sine wave may be used to simulate voltage distortion levels to the unit under test. The total harmonic distortion level may be programmed in percent using the CLIP LEVEL field of the WAVEFORMS menu. Changing the distortion level of the CLIP waveform forces the AC source to regenerate the CLIPPED sine wave's data points and reload the waveform register with the newly requested data. This process requires the output to be dropped briefly. To avoid interrupting the voltage output to the unit under test, select a different waveform such as the standard sine wave first, change the clip level and change the waveform back to the CLIPPED sine wave. This will avoid any output interruption.

#### 4.4.2 Phase Selection



Figure 4-29: Selecting Waveforms for Single Phase or All Phases

Different waveforms may be selected for each phase. The number of custom waveforms from which to select remains 50 but each phase can be assigned a different custom or standard waveform. The specific output phase for which the wave shape is programmed is selected with the PHASE key on the front panel. The selected phase is always shown in the top right hand corner of the WAVEFORMS display.

To select the same wave shape for all three phases in a three-phase configuration, press the PHASE key until the "øABC" enunciator appears in the top right corner of the WAVEFORMS menu. Waveform selections made in this mode will apply to all three phases.

#### 4.4.3 Creating Custom Waveforms

The 3Pi controller provides four groups of 50 custom defined waveforms each for a total of 200 waveforms in addition to the 3 standard waveforms. Of these four groups, one may be active at a time. The active group is selected in the INITIAL SETUP menu.

Custom waveforms cannot be created from the front panel of the RS Series. Rather, they have to be downloaded through one of the remote control interfaces. A Windows based program is included with the RS Series that allows waveforms to be created and downloaded easily. This

Graphical User Interface program allows waveforms to be created by specifying harmonic amplitudes and phase angles with respect to the fundamental. It also offers an arbitrary waveform data entry mode that allows individual data points to be specified.

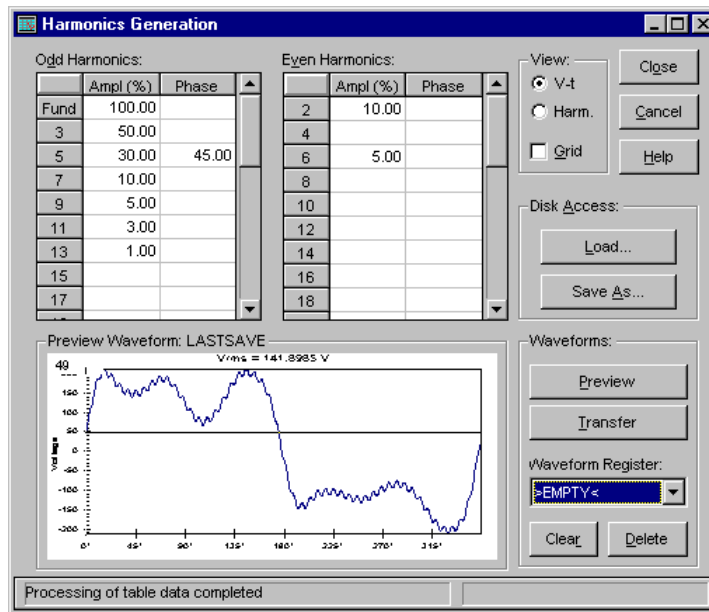

Figure 4-30: Custom Waveform Creation with GUI Program

Once downloaded, waveforms remain in non-volatile memory and will be visible in the WAVEFORMS menu for selection. The user can assign a 12-character name to each custom waveform. Avoid using any of the standard waveform names (SINE, SQUARE or CLIPPED) as these names will not be accepted.

Waveforms may be deleted using the remote control interface as well. Custom waveforms cannot be deleted from the front panel however to avoid accidental erasure.

#### 4.4.4 Waveform Groups

Waveform groups extend the number of available custom waveform to 200. Each group can contain up to 50 user-defined waveforms. Groups are numbered 0 through 3 and may be selected from the INITIAL SETUP 3 menu. To switch waveform groups, proceed as follows:

1. Press the MENU key three times to select the MENU 3 screen.
2. Move the cursor to the UTILITY entry and press ENTER. You are now in the UTILITY 1 menu.
3. Move the cursor to the INITIAL SETUP field and press ENTER. You are now in the INITIAL SETUP 1 menu.
4. Move the cursor to the MORE field at the end of this menu and press the ENTER key. You are now in the INITIAL SETUP 2 menu.
5. Move the cursor to the MORE field at the end of this menu and press the ENTER key. You are now in the INITIAL SETUP 3 menu.
6. Move the cursor to the WAVE GROUP = field. You can now use the knob or the 0 through 3 key on the front panel to select a different waveform group.
7. Press ENTER to confirm your new selection.

8. To activate your new selection, YOU MUST CYCLE THE POWER so the AC source re-initializes. If the source is operated over the bus, a IEEE-488 Device Clear or reset command (\*RST) command will have the same effect.

The new wave group will be active after you turn the power to the unit back on.

#### 4.4.5 RMS Amplitude Restrictions

The output of a sine wave may be programmed to the full rms value of the voltage range selected. If the AC source is in the 300 V range, the maximum programmable rms voltage is 300 Volt. If a custom waveform is used however, the maximum programmable rms voltage may be less than the maximum range value. The voltage range limit is based on the use of a sine wave with a 1.414 crest factor. A 300 V rms sine wave has a 424 Volt peak voltage. The AC source has a maximum peak voltage capability that is determined by the selected voltage range. If the user selects a custom waveform with a crest factor that is higher than 1.414, the peak voltage would exceed this maximum if the rms voltage were to be programmed at 300 V rms.

The RS Series power source automatically limits the maximum allowable programmed rms voltage of a any custom waveform by calculating the crest factor of the selected waveform and controlling the rms limit accordingly. Thus, each custom waveform may have a different maximum rms value. The 3Pi controller will prevent the user from programming the rms voltage above this limit. If a value is entered in the PROGRAM 1 menu above this value, a "Voltage peak error" message is generated.

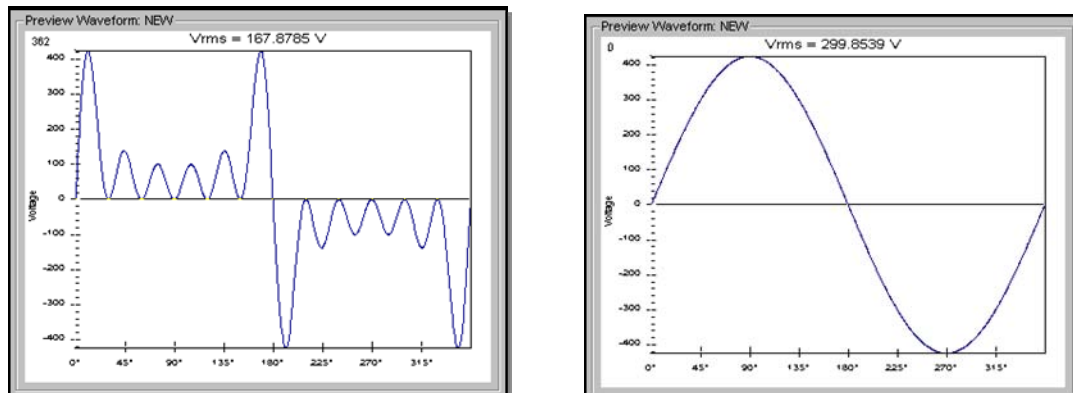

Figure 4-31: Waveform Crest Factor Affects Max. rms Voltage

The figure shown here illustrates the relationship between the crest factor of the wave shape (or its "peakiness") and the maximum peak voltage allowed for a given voltage range. Since the peak voltage cannot exceed the AC source's capabilities, the programmable rms voltage has to be restricted, in this case to only 167.8785 volt for the waveform on the left. The sine wave on the right can be programmed to the full 300 V rms as this still falls within the same peak voltage limitation of the AC source.

If the RS Series is used over the bus, the ":VOLT? MAX" query command can be used to determine the maximum allowable RMS voltage for the selected waveform. Using the returned value as part of a program will prevent range errors.

#### 4.4.6 Frequency Response Restrictions

The user may create a waveform that contains any number of harmonic frequencies of the fundamental. The AC Source itself however has a finite signal bandwidth and will attenuate higher frequency components of the signal. To limit the maximum frequency component of the output signal, the 3Pi controller automatically applies a band-pass filter to all custom waveforms as they are downloaded. The controller implements the following process for user defined waveforms:

Each down loaded waveform will have a computed frequency limit that is less than or equal the maximum frequency limit of the AC source. The frequency limit is a function of the harmonics content of the waveform and will follow the equation below.

$$F_{max_n} = F_{max}/(\text{level} * h_n)$$

If  $F_{max}$  is below the minimum frequency limit, the waveform will be rejected at down load time and the label will be deleted from the waveform catalogue.

If the RS Series is used over the bus, the “:FREQ? MAX” query command can be used to determine the maximum allowable fundamental frequency for the selected waveform. Using the returned value as part of a program will prevent range errors.

Limits assume a program of full-scale voltage. No adjustments for voltage setting are made below the full-scale value.

Waveform selection and frequency programming will be subject to the above limit. An error message will be generated to reflect this type of error:

"22,Waveform harmonics limit"

Transient editing will also generate the above error during keyboard entry. Remote transient entry will not check for the error until transient execution.

The frequency domain VIEW mode in the WAVEFORMS menu may be used to visualize the content of each custom waveform register on the LCD.

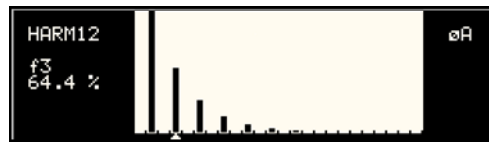

Figure 4-32: Waveform Frequency Domain View Mode

#### 4.4.7 Switching Waveforms

Waveforms can be switched as part of the transient system. Each transient type setup menu has a FUNCTION field. This field allows selection of any of the standard or custom waveforms available in the selected group. Refer to the section on transients for more details on using transient list to switch output waveforms.

## 4.5 Standard Measurements

Standard measurements are always available through the MEAS key on the front panel. These measurements are spread across two to four screens to enhance readability. Switching between these screens can be done by successively pressing the MEAS button on the front panel. This will cause the screen to cycle through all available measurement screens.

### 4.5.1 Standard Controller Measurements

For RS Series power sources, the following two measurement screens are available:

Mode	AC	DC	
MEASUREMENTS 1			
VOLTAGE	AC rms voltage	DC Voltage	
CURRENT	AC rms current	DC Current	
FREQUENCY	Frequency	n/a	
POWER	Real power	power	
MEASUREMENTS 2			
VA POWER	Apparent power	power	
PEAK CURR	Highest AC current found	Highest DC current found	
POWER FACT	Power factor	n/a	
CREST FACT	Crest factor	n/a	

#### 4.5.2 3Pi Controller Measurements

For RS Series with the -3Pi controller, the following four measurement screens are available:

Mode	AC	DC	AC+DC
MEASUREMENTS 1			
VOLTAGE	AC rms voltage	DC Voltage	AC rms voltage
CURRENT	AC rms current	DC Current	AC rms current
FREQUENCY	Frequency	n/a	Frequency
POWER	Real power	n/a	n/a
MEASUREMENTS 2			
VA POWER	Apparent power	power	Apparent power
PEAK CURR	Highest AC current found	Highest DC current found	Highest AC current found
POWER FACT	Power factor	n/a	Power factor
CREST FACT	Crest factor	n/a	Crest factor
MEASUREMENTS 3			
VOLT THD	Voltage distortion	n/a	Voltage distortion
CURR THD	Current distortion	n/a	Current distortion
INST PK CURR	Instantaneous peak current	Highest DC current found	Instantaneous peak current
PHASE	Phase angle	n/a	Phase angle

The 3Pi controller has a fourth measurement screen for harmonics and trace analysis measurements. This subject is covered in the next chapter.

Note: The V and I distortion calculations are based on H2 through H50 with the RMS current in the denominator. Note that some definitions of THD use the fundamental component (H1) as the denominator. This may result in different readings between instruments depending on the implementation chosen.

Measurements are always running in the background. When the user selects a measurement screen for display, the AC source first updates all the measurement parameters before displaying the requested screen. This process may take up to a second. Consequently, pressing the MEAS key may not always bring up the selected screen immediately. There will be a perceptible delay. This will prevent the screen from appearing with invalid or blank readouts.

The measurement method for voltage and current will depend on the power source's operating mode. The following table shows the return value type (rms or average) and method of coupling when the measurement command is initiated with a different extension at various operating modes (AC, DC or AC + DC).

Measurement Extension and Coupling	Operating Mode		
	AC	DC	AC + DC
AC	rms	rms	rms
DC	rms	rms	average
Coupling	AC	DC	DC



### 4.5.3 Accuracy Considerations

---

Any measurement system has a finite accuracy specification. Measurement specifications are listed in Section 2. When using the AC source for measurement purposes, always consider these specifications when interpreting results. Measurement inaccuracies become more pronounced as the signal being measured is at the low end of the measurement range. This is particularly relevant for low current measurements. The RS Series is a high power AC and DC source optimized for providing and measuring high load currents. When powering low power loads, measurement inaccuracies on rms and peak current measurements will greatly affect derived measurements such as power, power factor and crest factor.

The measurement system on the RS Series uses a data acquisition system with a 16 kHz bandwidth. This means that high frequency components of the measured signal are filtered out. Any contribution to the rms value of voltage and current above this cutoff frequency will not be reflected in the RS Series measurements. When using an external measurement reference, this may account for discrepancies in readings.

## 4.6 Advanced Measurements

---

The 3Pi controller offers advanced power analyzer measurement capabilities. These functions may be accessed from the MEAS button or the MENU 2 screen. The phase for which the analysis or waveform acquisition is done may be selected using the PHASE key in three phase configurations. This chapter covers the use and application of these advanced measurement functions.

### 4.6.1 Harmonic Analysis

---

The 3Pi controller's power analyzer performs fast Fourier transformation (FFT) on both voltage and current on each available phase. The resulting frequency spectrum can be displayed on the LCD display in a tabular as well as a graphical mode.

#### 4.6.1.1 Acquiring FFT data

---

To perform an FFT analysis on the output of the AC source, proceed as follows:

1. Press the MEAS button four times or until the HARMONICS/TRACE ANALYSIS screen appears.
2. Move the cursor to the FUNCTION field and select VOLT or CURR. (The BOTH selection will default to CURR as only one FFT result can be displayed at a time.)
3. Move the cursor to the VIEW field and select the TABLE or BAR display mode. The TRACE display mode does not apply to FFT results.
4. Move the cursor to the DATA MODE field and select ABS or REL. Absolute display mode will show all harmonic components in volts or amps. Relative display mode will use the fundamental as a 100 % reference and display all harmonics as a percentage of the fundamental. Phase angles are always shown with respect to the fundamental frequency. The phase angle of the fundamental is always shown with respect to phase A.
5. Skip the SCALE field as it only applies to the TRACE display mode.
6. Move the cursor to the TRIG MODE and select SINGLE or CONT. The SINGLE mode will acquire the data once and show the result. If you select CONT, the data will be updated continuously.
7. Move the cursor to the TRIG SOURCE field and select IMM. We will cover additional trigger modes later.

8. Move the cursor to the START field and press the ENTER key. The display that you selected will be shown. If you are in CONT trigger mode, the data will be updated about once per second.

You can return to the HARMONICS/TRACE ANALYSIS screen by pressing the ENTER key. To display the data in a different format, change to the selections you want and move the cursor to the VIEW field. Pressing the ENTER key will re-display the data without triggering a new acquisition. (This is true even if you were in CONT trigger mode.) To start a new acquisition, you must go through the START field instead.

#### 4.6.1.2 Analyzing FFT data

The data displays available for FFT data allow you to scroll through the entire data set. For table displays, the UP and DOWN arrow keys may be used to scroll through the table data vertically. The knob has no function while in this display mode. The triangle on the left edge of the LCD screen points to the current position in the table.

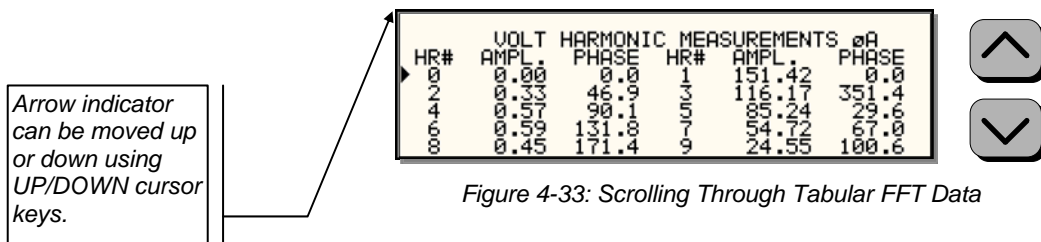

Figure 4-33: Scrolling Through Tabular FFT Data

Bar chart format FFT data displays show the same data in a graphical format. While the amplitude information is shown graphically, phase data is only displayed in numeric form to the left for the currently selected harmonic component. The display can show up to 24 components at a time. The triangle at the bottom of the display shows the currently selected component for which numeric data is shown on the left. This data includes the harmonic number (DC through 50), the absolute or relative amplitude (depending on selected VIEW mode) and the phase angle with respect to the fundamental. The knob can be used to scroll through the display horizontally. The UP and DOWN cursor keys have no effect in this display mode.

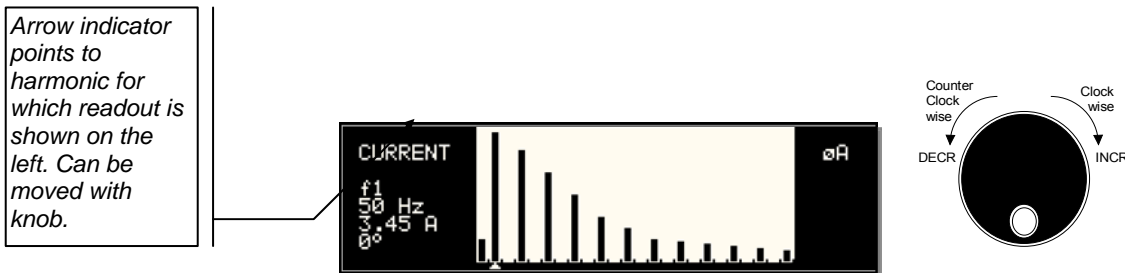

Figure 4-34: Scrolling through bar chart FFT Data

## 4.6.2 Waveform Acquisition

---

The waveform acquisition mode allows voltage and/or current data waveforms to be captured and displayed. This mode is selected by choosing the VIEW =TRACE mode in the HARMONICS/TRACE ANALYSIS screen. Voltage and current may be viewed separately or combined into a single display using the FUNCTION field.

### 4.6.2.1 Acquiring waveform data

---

To perform a waveform acquisition on the output of the AC source, proceed as follows:

1. Press the MEAS button four times or until the HARMONICS/TRACE ANALYSIS screen appears.
2. Move the cursor to the FUNCTION field and select VOLT, CURR or BOTH.
3. Move the cursor to the VIEW field and select the TRACE display mode.
4. Skip the DATA MODE field as it only applies to the TABLE and BAR display modes.
5. Move the cursor to the SCALE field and select a horizontal time base value to allow you to see at least one cycle of the output waveform. If the output is programmed at 50 Hz, a 20 ms scale would display exactly one signal period.
6. Move the cursor to the TRIG MODE and select SINGLE or CONT. The SINGLE mode will acquire the data once and show the result. If you select CONT, the data will be updated continuously.
7. Move the cursor to the TRIG SOURCE field and select IMM. We will cover additional trigger modes later.
8. Move the cursor to the START field and press the ENTER key. The display that you selected will be shown. If you are in CONT trigger mode, the data will be updated about once per second.

You can return to the HARMONICS/TRACE ANALYSIS screen by pressing the ENTER key. To display the data in a different format or to select voltage instead of current or current instead of voltage, change to the selections you want and move the cursor to the VIEW field. Pressing the ENTER key will re-display the data without triggering a new acquisition. (This is true even if you were in CONT trigger mode.) To start a new acquisition, you must go through the START field instead.

#### 4.6.2.2 Analyzing waveform data

The data displays available for acquired waveform data allow you to scroll through the entire acquisition buffer. For waveform displays, the knob can be used to scroll through the display horizontally. The UP and DOWN cursor keys have no effect in this display mode.

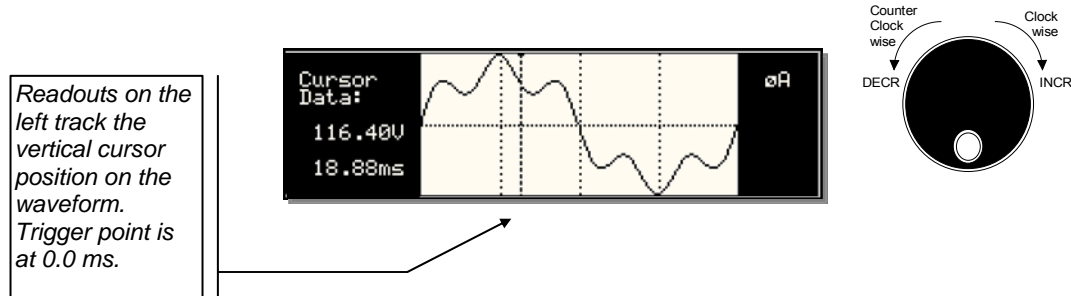

Figure 4-35: Scrolling Through Acquired Waveform Data

The acquisition buffer may be longer than the selected horizontal scale in which case only a portion of the acquisition window will be visible. The left portion of the LCD display is used to read out the data under the vertical cursor. This cursor is a dotted line that can be moved using the knob. If the left or right edge of the display window is reached, the entire display will shift so the cursor always remains visible. The time from the trigger point to the vertical cursor is displayed in the left hand portion of the LCD in ms. Also displayed here are the absolute voltage and/or current value under the cursor.

To change the horizontal display scale without re-triggering an acquisition, press the ENTER key to return to the HARMONICS/TRACE ANALYSIS screen, change the SCALE value, move the cursor to the VIEW field and press ENTER. This will display the same data set at the new scale without triggering a new acquisition.

### 4.6.3 Triggering Measurements

---

Both FFT results and waveform acquisitions may have to be positioned at a specific moment in time. To allow the data acquisition to coincide with user specified events, the measurement system can be triggered in different ways. Trigger modes are available from both the bus and the front panel. If one of the remote control interfaces is used, acquisitions may also be triggered from the transient list system. Refer to the programming manual for details on this mode of operation.

#### 4.6.3.1 Trigger mode

---

The following trigger modes are supported by the RS Series 3Pi controller:

Single (SINGLE)	This mode causes the acquisition system to be armed only once. The RS source waits for the user to press the ENTER key while on the START field. As soon as the trigger event specified occurs, data is acquired and the acquisition system is put in an idle state. A new user initiated START event must be given to trigger an new acquisition.
	This mode is appropriate for capturing events that occur only once such as the inrush current when turning on a load.
Continuous (CONT)	This mode causes the trigger system to re-arm itself after each trigger event. Every time a new trigger event occurs, new data is acquired and the LCD display is updated. No user intervention is required after the initial START event.
	This mode is appropriate for capturing repetitive events or to monitor the source output continuously. Display updates will occur about once per second.

#### 4.6.3.2 Trigger source

---

The RS Series 3Pi controller offers a choice of trigger sources in front panel operation mode. The following trigger sources are available from the HARMONICS/TRACE ANALYSIS, TRIG SOURCE field:

Immediate (IMM)	This mode causes a trigger to occur as soon as the ENTER key is pressed with the cursor on the START field. No trigger source needs to be specified for this trigger mode. This mode is equivalent to the INIT:IMM:ACQ bus command.
	This trigger source is appropriate if no trigger condition is known or desired. When using this trigger source, the acquisition is always triggered.
Phase (PHASE A)	This mode causes the RS acquisition system to wait for a specified phase angle on the phase A voltage output. This allows the acquisition to be positioned in time with respect to any phase angle on phase A, B or C. Note that phase A, B and C are typically at 0°, 240° and 120° with respect to the specified trigger phase in this field. An example of this trigger source mode is shown in Figure 4-37.
	When selecting this trigger source, the field below the TRIG SOURCE field changed to "TRIG PHASE =". Use this field to enter the desired voltage phase angle to trigger the measurement on.

This mode is appropriate when capturing analyzing events at a specific phase angle such as the zero crossing of the voltage. Note that the phase angle of the current with respect to the voltage is determined by the load, so triggering at a specific phase current angle is not possible as it is not controlled by the AC source. However, when capturing current waveform data, the phase relationship to the voltage can be determined easily by triggering at the 0° point on the voltage.

#### Voltage step (SET VOLT)

This mode performs two functions. It programs the output voltage for the selected phase or phases to the rms or DC value specified and it triggers the measurement acquisition at the same moment in time.

When selecting this trigger source, the field below the TRIG SOURCE field changed to "SET VOLT =". Use this field to enter the desired voltage to program the output to and trigger the measurement on. If only one phase in a three phase system is selected, only that phase's output will be programmed. If all phases are selected, all three phases' outputs will be programmed. Use the PHASE key to select the desired phase or all phases. Figure 4-36 shows an example of using the SET VOLT trigger source to capture the turn-on of the voltage. In this case, a negative trigger delay was specified and the voltage start phase angle was set to 90° in the PROGRAM 2 screen.

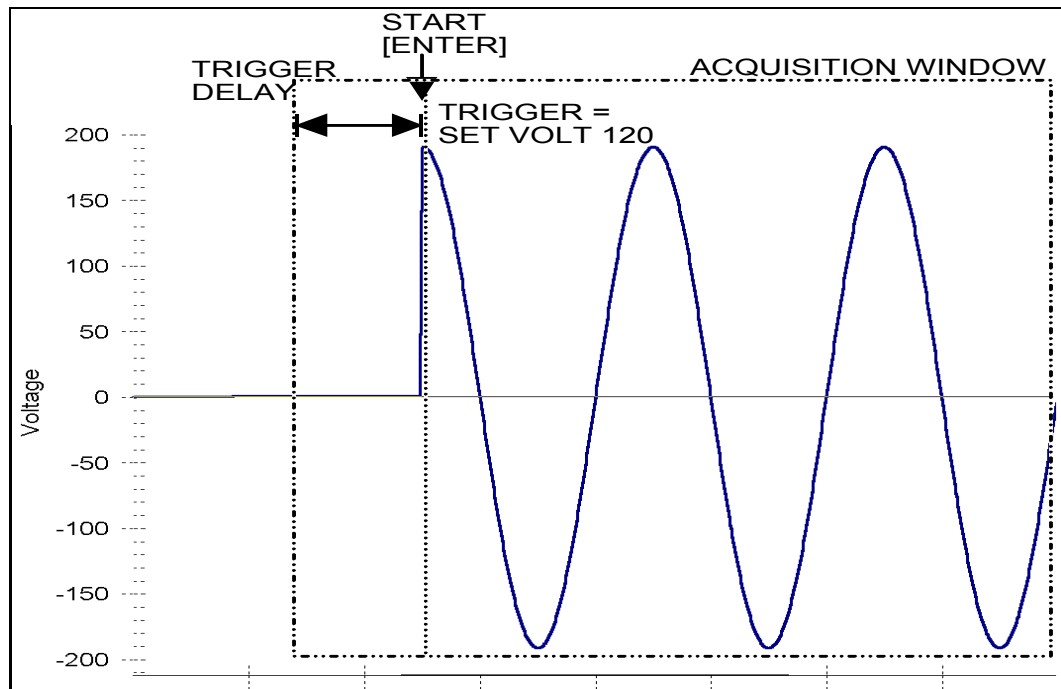

Figure 4-36: SET VOLT Trigger Source Acquisition

This mode is appropriate for capturing the inrush current of a load by programming the voltage to a specified value and capturing the voltage and current at that moment in time. A further refinement can be made by specifying the voltage start phase angle in the PROGRAM 2 screen. If this field is changed from RANDOM to 90°, the inrush current can be captured under worst case conditions. In this case, the voltage should be programmed to 0 volt before triggering the acquisition using the START field.

---

**Note:** *When using the SET VOLT trigger source, the output relay MUST be closed to generate a trigger. If the output is open, the acquisition will be armed when the START [ENTER] key is pressed but will wait for the trigger event. Closing the output relay will generate the trigger event. If the output relay was already closed when the START [ENTER] key is pressed, the trigger will occur immediately.*

---

### 4.6.3.3 Trigger delay

The trigger delay field allows the user to set the amount of pre- or post-trigger data that should be used when positioning the data acquisition window with respect to the trigger moment.

#### POST-TRIGGER DELAY

A positive trigger delay value means the acquisition window is delayed by the amount of time specified. In this case, the actual trigger moment itself is no longer present in the acquisition buffer. This situation is shown in Figure 4-37 where a 20 ms trigger delay is used after triggering on phase A = 180°. The fundamental frequency of the output is 50 Hz. The dashed line indicates the trigger point. It occurs on the first 180 degree point that occurs after the user presses the ENTER key while on the START field. Once the trigger occurs, the acquisition holds off the specified 20 ms at which point the data requested is captured. Using a positive trigger delay value always yields post trigger data.

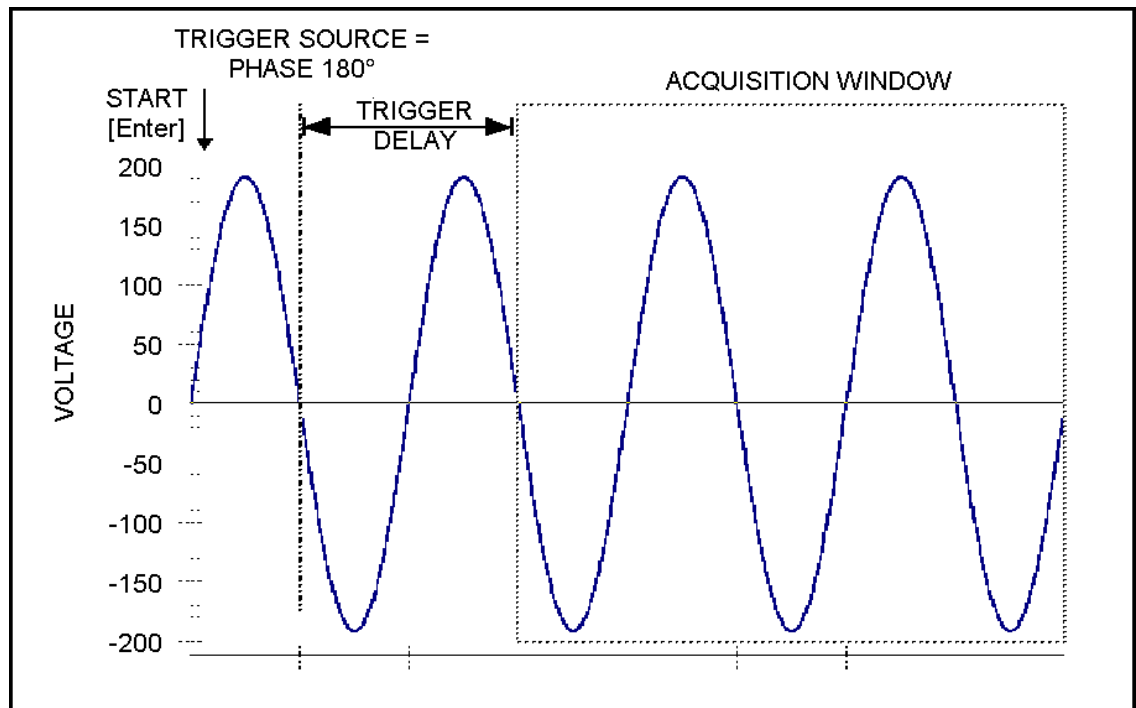

Figure 4-37: Positive Trigger Delay (Post Trigger Data)

Positive trigger delay values may be set from 0.0 ms to 1000.0 ms (1 second) in 0.1 ms increments. The value may be entered directly from the keyboard or using the knob.



### PRE TRIGGER DELAY

Alternatively, a negative trigger delay value may be specified up to the maximum time window depth of the acquisition window. The value may be entered directly from the keyboard or using the knob. The following time interval range is available:

128 msec to 1280 msec.

This situation is shown in Figure 4-38. The example shows a similar scenario as before, only this time the trigger delay was set a -20 ms. Notice that the data acquisition window now contains data that occurred before the user pressed the ENTER key to start the acquisition.

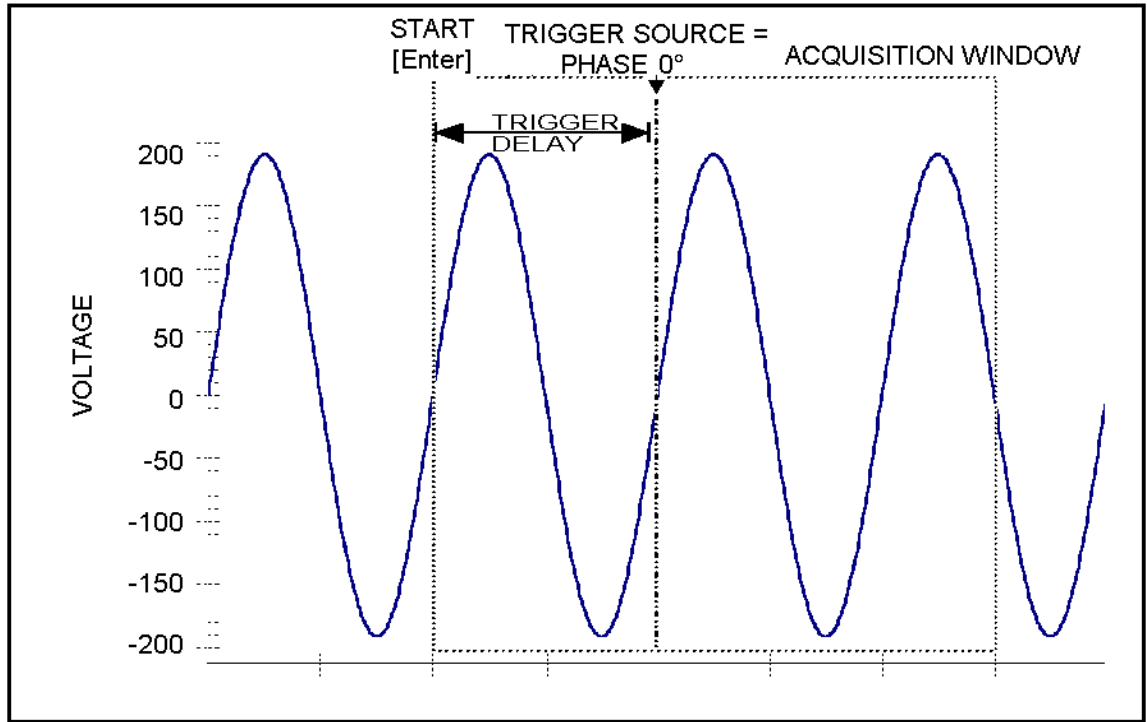

Figure 4-38: Negative Trigger Delay (Pre-Trigger Data)

## 4.7 Transient Programming

---

### 4.7.1 Introduction

---

Transient programming provides a precise timing control over output voltage and frequency changes. This mode of operation can be used to test a product for susceptibility to common AC line conditions such as surges, sags, brownouts and spikes. By combining transient programming with custom waveforms, virtually any AC condition can be simulated on the output of the AC source.

The default voltage mode is FIXED which means the output voltage is constant and remains at the level set by the user. Changes made to the output voltage made from the PROGRAM 1 menu take effect immediately. In front panel operation mode, the voltage and frequency slew rates (rate of change) are always at their maximum of 1E9 V/s and 1E9 Hz/s. Slew rate programming is only possible over the remote control interface. On power up, the AC source always reverts to the maximum slew rate for both voltage and frequency.

### 4.7.2 Using Transient Modes

---

The voltage can be programmed in the following transient operating modes:

- |       |   |
|-------|---|
| STEP  | causes the output to permanently change to its triggered value.   |
| PULSE | causes the output to change to its triggered value for a specific time, as determined by the Pulse menu parameters. |
| LIST  | causes the output to sequence through a number of values, as determined by points entered in the List menu.         |
| FIXED | disables transient operation for the selected function.   |

### 4.7.3 Step Transients

---

Step transients let you specify an alternate or triggered voltage level that the AC source will apply to the output when it receives a trigger. Because the default transient voltage level is zero volts, you must first enter a triggered voltage before you can trigger the AC source to change the output amplitude. Step transients can only be programmed through the bus, not the front panel. Refer to the SCPI Programming Manual for more information about programming Step transients and triggers.

#### 4.7.4 Pulse Transients

Pulse transients let you program the output to a specified value for a predetermined amount of time. At the end of the Pulse transient, the output voltage returns to its previous value. Parameters required to set up a Pulse transient include the pulse count, pulse period, and pulse duty cycle. An example of a Pulse transient is shown in Figure 4-39. In this case, the count is 4, the pulse period is 16.6 ms or 60 Hz and the duty cycle is 33%.

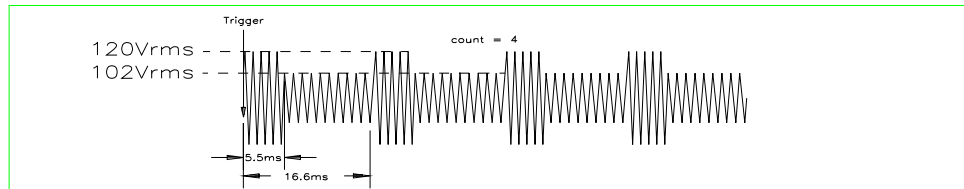

Figure 4-39: Pulse Transients

Note that Pulse transients can only be programmed over the bus, not the front panel. Refer to the SCPI Programming Manual for more information about programming Pulse transients and triggers.

### 4.7.5 List Transients

List transients provide the most versatile means of controlling the output in a specific manner as they allow a series of parameters to be programmed in a timed sequence. The following figure shows a voltage output generated from a list. The output shown represents three different AC voltage pulses (160 volts for 33 milliseconds, 120 volts for 83 milliseconds, and 80 volts for 150 milliseconds) separated by 67 millisecond, zero volt intervals.

Transient list programming is supported from the front panel and may be accessed by selecting the TRANSIENTS entry in the MENU 1 screen. Transient lists can also be programmed over the bus. Refer to the SCPI Programming Manual for more information about programming List transients and triggers over the bus.

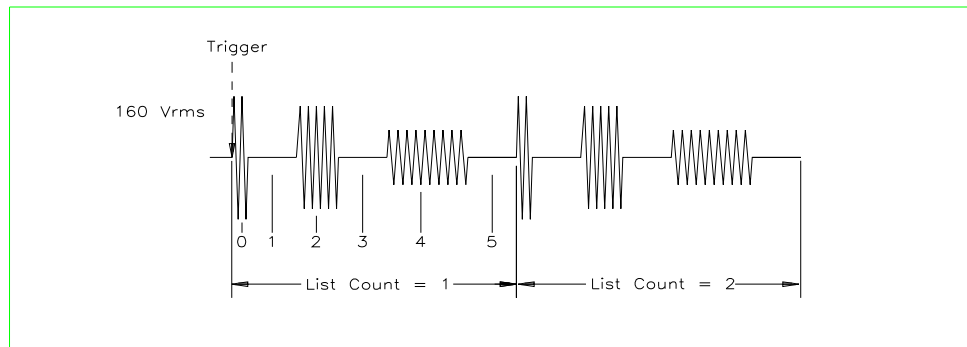
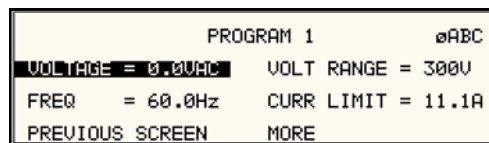

Figure 4-40: List Transients

The list specifies the pulses as three voltage points (point 0, 2, and 4), each with its corresponding dwell point. The intervals are three zero-voltage points (point 1, 3, and 5) of equal intervals. The count parameter causes the list to execute twice when started by a single trigger.

To set up this type of transient list, proceed as follows:

1. Press the PROG key to bring up the PROGRAM 1 menu.
2. Move the cursor to the VOLTAGE field and enter 0 Volt. Press ENTER to confirm your setting.
3. Make sure you are in the HIGH voltage range as we will program a surge to 160 V rms. The low range would only allow 150 V rms.



4. Press the MENU key to bring up MENU 1.
5. Move the cursor to the TRANSIENTS entry and press the ENTER key. You are now in the TRANSIENTS menu.
6. Move the cursor to the VOLT SURGE/SAG entry and press the ENTER key. You are now in the VOLT SURGE/SAG SETUP menu.
7. If you have a three-phase configuration and are in the three-phase mode, use the PHASE key to select all three phases. (⊘ABC will be displayed in the top right corner of the screen.)

8. The START  $\phi$  may be left at RANDOM as we are not interested in starting at a specific phase angle. If a number is already present in this field, use the BACKSPACE (<-) key to clear it.
9. Move the cursor to the GO TO VOLT field and enter 160.0
10. Move the cursor to the DUR SCALE field and set this field to TIME. We will be entering delays in time rather than cycles since this example was stated in ms.
11. Move the cursor to the DURATION field and enter 0.033 seconds. Be sure not to enter 33 as this field is specified in seconds, not milliseconds. The highest time resolution available for list transients is 1 ms or 0.001 s.
12. Move to the END VOLT field and enter 0.0. We want the voltage to return to 0 Volt after the first burst.
13. Move the cursor to the END DELAY field and enter 0.067 for a interval delay of 67 ms. Notice that we effectively combined steps 0 and 1 from Figure 4-40 into a single list event.
14. If you have an RS Series AC source, move down to the FUNCTION field and use the knob to select SINE. The knob will allow you to scroll through all available wave shapes in the active WAVE GROUP. If you have a -1 or -3 standard controller, this field will not be visible.
15. Move the cursor to the REPEAT field and enter 0. This means this event will be executed once and not repeated. Do not confuse this event level repeat capability with the entire list level repeat field, which we will use later.
16. Move the cursor down to the EVENT # field and enter a number from 1 through 99. The transient list will be executed in order of event number. Leaving a gap between event numbers allows you to insert events at different places later in the sequence. Deleting events is always possible regardless of the event number. For the purpose of this exercise, we will start with EVENT # 5. Enter 5 and press the ENTER key. This brings you back to the TRANSIENTS menu.

```

VOLT SURGE/SAG SETUP      @ABC
START  $\phi$    =RANDOM      END VOLT   =0.0
GO TO VOLT=160.0      END DELAY  =0.067S
DUR SCALE =TIME      FUNCTION   =SINE
DURATION  =0.033S    REPEAT    =0
PREVIOUS SCREEN      EVENT #   =5

```

17. Repeat steps 6 through 16 two more times using 120 V, 83 ms and 80 V, 150 ms as values for EVENT # 10 and EVENT #15.
18. Once you have programmed these three events, move the cursor in the TRANSIENTS menu to the START/VIEW SEQUENCE field and press the ENTER key. This will get you to the START/VIEW TRANSIENT SEQUENCE menu from which you can run transient programs. This screen shows all available events in the transient list on the right hand side. If more than five events are programmed, you can scroll through the list using the UP and DOWN arrow keys. To edit an existing event, move the cursor to the relevant event number and press the ENTER key.
19. Move the cursor to the REPEAT #0 field and enter 1. This will cause the transient program to repeat once and thus run two times total. Do not confuse this global list level repeat capability with the list event level repeat field we skipped in step 15.
20. Make sure the output relay is closed using the OUTPUT ON/OFF key. If you start a transient program with the relay open, an error message will appear.
21. Move the cursor to the START field and press the ENTER key. The transient program you just created will execute two times. If you have an oscilloscope connected to the output, you may be able to see the output voltage change per Figure 4-40.

```

START/VIEW TRANSIENT SEQUENCE
START          #05= VOLTAGE SURG/SAG
PHASE         #10= VOLTAGE SURG/SAG
REPEAT #0     #15= VOLTAGE SURG/SAG
CLEAR SEQ
PREV. SCREEN

```

---

**Note:** *The AC source output remains at the last programmed values at the completion of the list.*

---

In three-phase mode, the voltage lists are phase selectable. You can set up a different voltage list for each phase. To do this, use the PHASE key to choose the desired phase, as described in the example. Note that fields common to all phases such as DURATION, END DELAY and REPEAT always apply to all three phases in three-phase mode. When the cursor is moved to any of these fields, the phase enunciator in the top right-hand corner always reverts to  $\emptyset$ ABC. Frequency transients are identical to voltage transients except they apply to all three phases at all times in a three-phase configuration.

#### 4.7.6 Programming Slew Rates

---

As shown in the previous examples there are a number of ways that you can generate custom waveforms. Programmable slew rates provide additional flexibility when customizing waveforms. Slew rates determine how fast the voltage or frequency is changed by the controller when a step, pulse, or list transient is triggered. Slew rates cannot be programmed from the front panel and are always set to their maximum values at power on. To use programmable slew rates, the AC source must be programmed over the bus. Refer to the SCPI Programming Manual for more information about programming slew rates.

### 4.7.7 Switching Waveforms

The FUNCTION field available in each transient list event setup menu may be used to dynamically switch waveforms during transient execution. This allows different waveforms to be used during transient execution. Waveforms may be switched without the output of the source being turned off. For three phase configurations, each phase has its own waveform list so different waveforms may be programmed on different phases during transient execution.

Figure 4-41 illustrates the concept of using different waveforms at different steps in a transient list. In this case, the change was programmed to occur at the zero crossing. Any phase angle can be used to start the transient execution however. To keep the phase angle synchronization, the dwell times have to be set to an integer number of periods. Over long periods of time, phase synchronization may get lost due to timing skew between the waveform generator and the transient state machine.

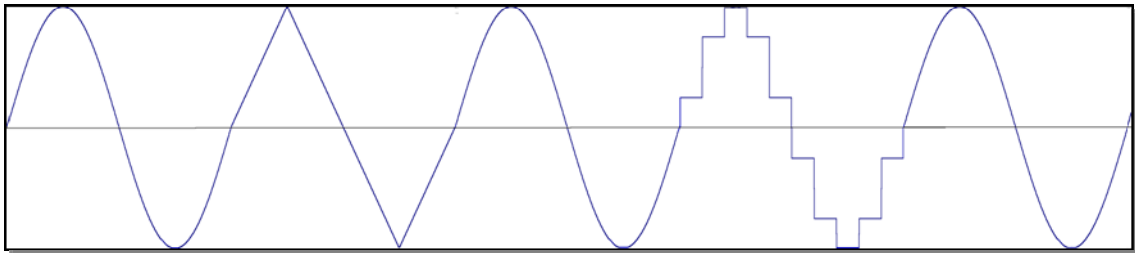

Figure 4-41: Switching Waveforms in a Transient List

### 4.7.8 Transient Execution

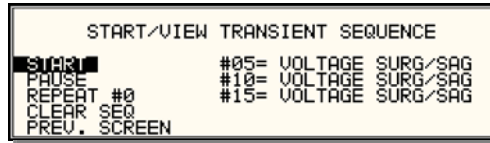

Figure 4-42: START/VIEW TRANSIENT SEQUENCE Menu

A transient list can be executed from the START/VIEW TRANSIENT SEQUENCE menu. To start a transient list, position the cursor on the START field as shown in Figure 4-42 and press the ENTER key. Transients may be aborted by pressing the ENTER key again while on the same field as the field changes to ABORT while a transient execution is in progress. For short duration transients, this will likely not be visible, as the transient will complete before the screen is updated. Longer duration transients however may be aborted in this fashion.

Longer duration transients may also be suspended using the PAUSE field located below the START/ABORT field. Pressing the ENTER key while on the PAUSE field will suspend the transient execution. Once suspended, it can be resumed using the same field as the field changes to RESUME while the transient execution is suspended. Suspending a transient may be useful when running slowly changing output transients to 'hold' the output at a specific setting while observing the effect on the unit under test.

### 4.7.9 Saving Transient List Programs

When the AC source is turned off, the transient list that was programmed is not automatically retained. Thus, if you turn the unit off, you will lose your programmed transient list. However, transient programs may be saved in nonvolatile memory for later recall. This allows multiple transient list programs to be recalled quickly without the need to enter all parameters each time. Transient lists are stored as part of the overall instrument front panel setup in any of the available setup registers.

To save the transient list you created in the previous example, proceed as follows:

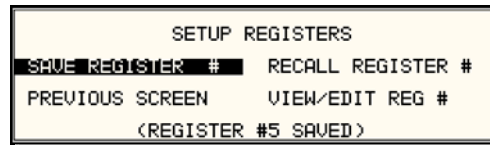

1. Press the MENU key two times to bring up the MENU 2 screen.
2. Move the cursor to the SETUP REGISTERS entry and press the ENTER key.
3. The cursor will default to the SAVE REGISTER # position. Enter a number from 0 through 7 and press the ENTER key.
4. A message will appear at the bottom of the screen indicating that the front panel settings and the transient list data have been saved in the setup register you selected.



## 5. Principle of Operation

### 5.1 General

An explanation of the circuits in the RS Series is given in this section. Refer to Figure 5-1 for a basic functional block diagram of the system.

Figure 5-2 shows a more detailed system inter connect for a RS-45-1 single-phase output unit. Other models have slightly different output configurations.

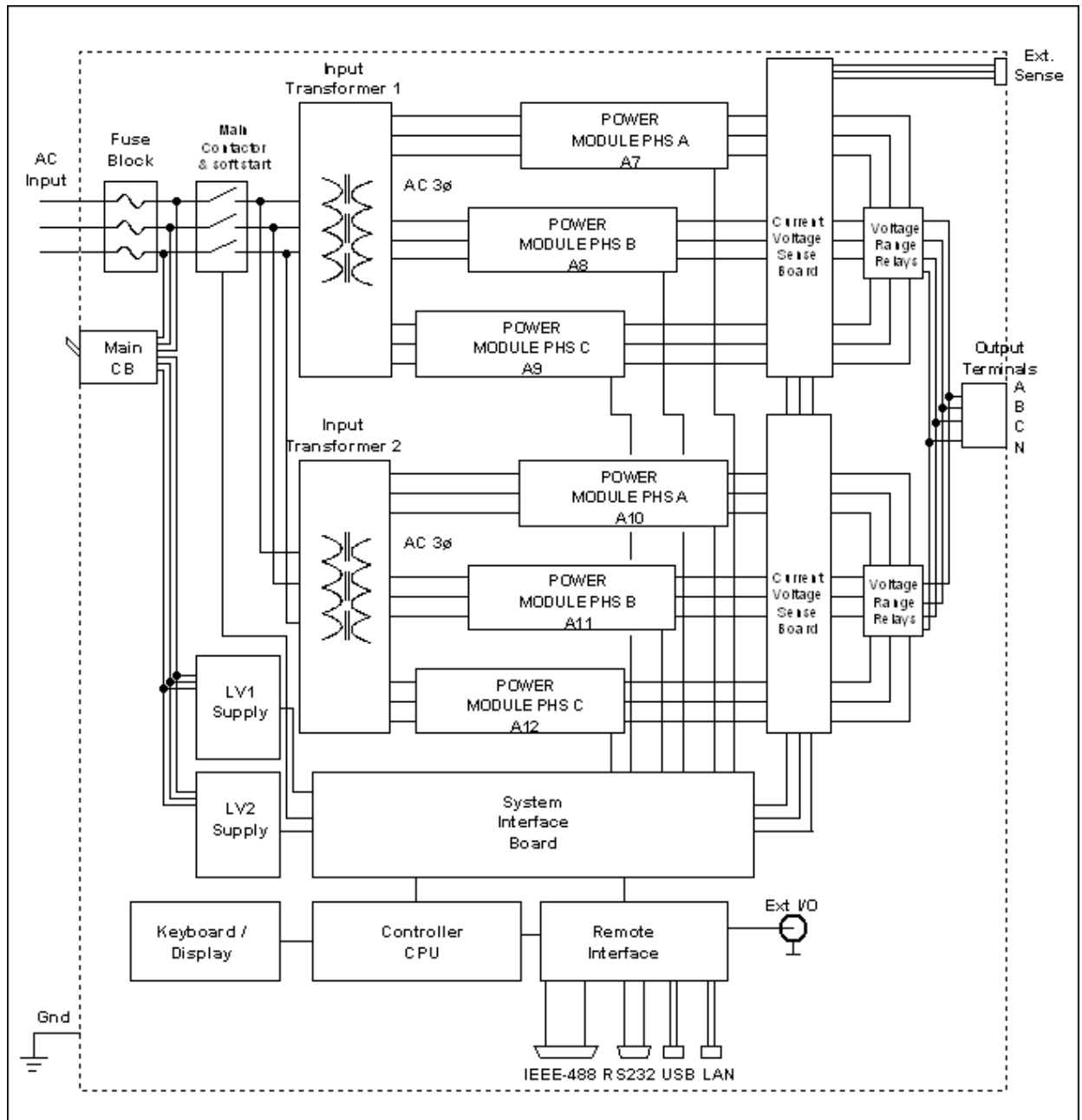

Figure 5-1: RS Series Functional Block Diagram

## 5.2 Overall Description

---

Three-phase input power is routed from the back of the cabinet to a fuse holder terminal block located in the bottom front of the unit. The lower front access panel has to be removed to gain access to the AC input connection fuse block. From the fuse block, the AC input is connected to the three-phase input transformer primary. The input transformer provides the required isolation between input and output of the RS and accommodates various input voltage ranges by employing multiple taps. Three sets of three-phase output secondaries are provided by the transformer to produce three 140 VAC unregulated output AC buses. Each of these outputs is fed into one of the power modules. (A, B and C) The power modules can be individually removed although for most configurations, all three are required. The power modules are located in the middle of the RS chassis and can be pulled out from the front after removing the top access panel and disconnecting the power input and output wiring.

Each power module contains a three-phase PFC power input module. The PFC module acts as a boost converter using a PWM converter topology to generate a 450 VDC regulated bus. A bank of high capacity electrolytic capacitors for each DC bus ensures ride through capability during brown-outs and high current demands.

The DC bus provides power to the AC amplifier. Each amplifier in turn consists of four amplifier modules labeled #1 (A1, A2) and #2 (A1, A2). These four amplifier modules are identical and interchangeable but all four must always be present.

The output of the amplifier can be either AC, DC or a combination of AC and DC. The mode is controller by the CPU controller based on user selection. All four amplifier modules within each power module are controlled by a single Modulator board. The modulator board contains a high frequency PWM modulator and additional control circuitry.

The CPU controller / oscillator assembly generates the reference waveforms and provides frequency, amplitude, and impedance control. A current and voltage sense board is located at the left bottom of the unit and is used to sense all output current and voltage for both control and measurement purposes. The current sensor board, in conjunction with the CPU controller, also supports the programmable RMS current limit function.

The system interface board controls all interaction between controller, power modules and current sensor board. The system interface board is located in the top compartment of the RS along with the controller.

Low voltage Power to the controller, amplifiers, system interface board and sensor board is provided by a separate Low Voltage DC supply (LV Supply). This LV Supply takes three-phase AC input directly from the AC input line through circuit breaker CB1 located on the front on the RS. This circuit breaker functions as the main power on/off switch of the RS unit.

The LV Power Supply board converts the AC input into a number of isolated low voltage regulated DC supplies that are distributed throughout the RS chassis. The LV power supply also supplies coil power for all contactors, including the AC mains contactor (K2). A small fan is located near the LV Supply to provide sufficient cooling of the supply and the other modules in the top section of the RS.

The individual assemblies are described in more detail in the following paragraphs. Refer to Figure 5-1 for an overall functional block diagram.

---

## 5.3 Controller Assembly

---

The Controller Assembly is located in the top section of the RS unit. To access this assembly, the top cover needs to be removed. The controller assembly consists of three printed circuit boards connected by a ribbon cable. The controller contains the main oscillator, which generates the sine wave signal setting the frequency, amplitude and current limit level. It also senses the output voltage to provide closed loop control of the output. The controller also handles all user interface and remote control related tasks.

The controller uses a two board set assembly (7003-718-2 or 7003-718-4). The function of each of the boards that make up the controller module is described in the following paragraphs.

---

### 5.3.1 CPU Controller

---

This board assembly, A2-A7, consists of the components for the CPU (DSP), generating the Phase waveform signal to the power amplifier and all of the program, waveform and data memory. In addition, the waveform board contains the circuits for all measurements. The clock and lock circuit required to support the clock and lock mode of operation of multiple RS units is also on this board assembly.

All three phases are contained on the same board. If the -413 option is present, a separate inter harmonic generator board is connected to the CPU board.

---

### 5.3.2 Keyboard / Display Board

---

The keyboard/display assembly is assembly A2-A9. It is mounted to the front panel and holds the 23 rubber keys. It also has the LCD graphics display. A shaft encoder is mounted on the board that is used as a shuttle input to allow slewing of setup parameters. If the RS system is used over one of the remote control interfaces, the keyboard functions can be locked out by asserting the REMOTE state. See the RS Series Programming Manual (P/N 9003-961) for details.

---

### 5.3.3 GPIB / RS232 or GPIB / RS232 / USB / LAN IO Board

---

This board assembly is identified as A1. It has the IEEE 488, RS232 and USB transceivers and optionally an Ethernet interface (-LAN option). USB and LAN are available on top assembly 7003-427 RS models only. It also has isolators to provide safety isolation for both interfaces and additional user accessible I/O lines. Additional user accessible inputs and outputs available through this assembly are:

- Trigger Input BNC
- Trigger Output BNC
- Function Strobe BNC
- Remote Inhibit (terminal strip)
- External Sync (terminal strip)
- Clock BNC (option)
- Lock BNC (option)
- Output Status (Available on top assembly 7003-427 only.)

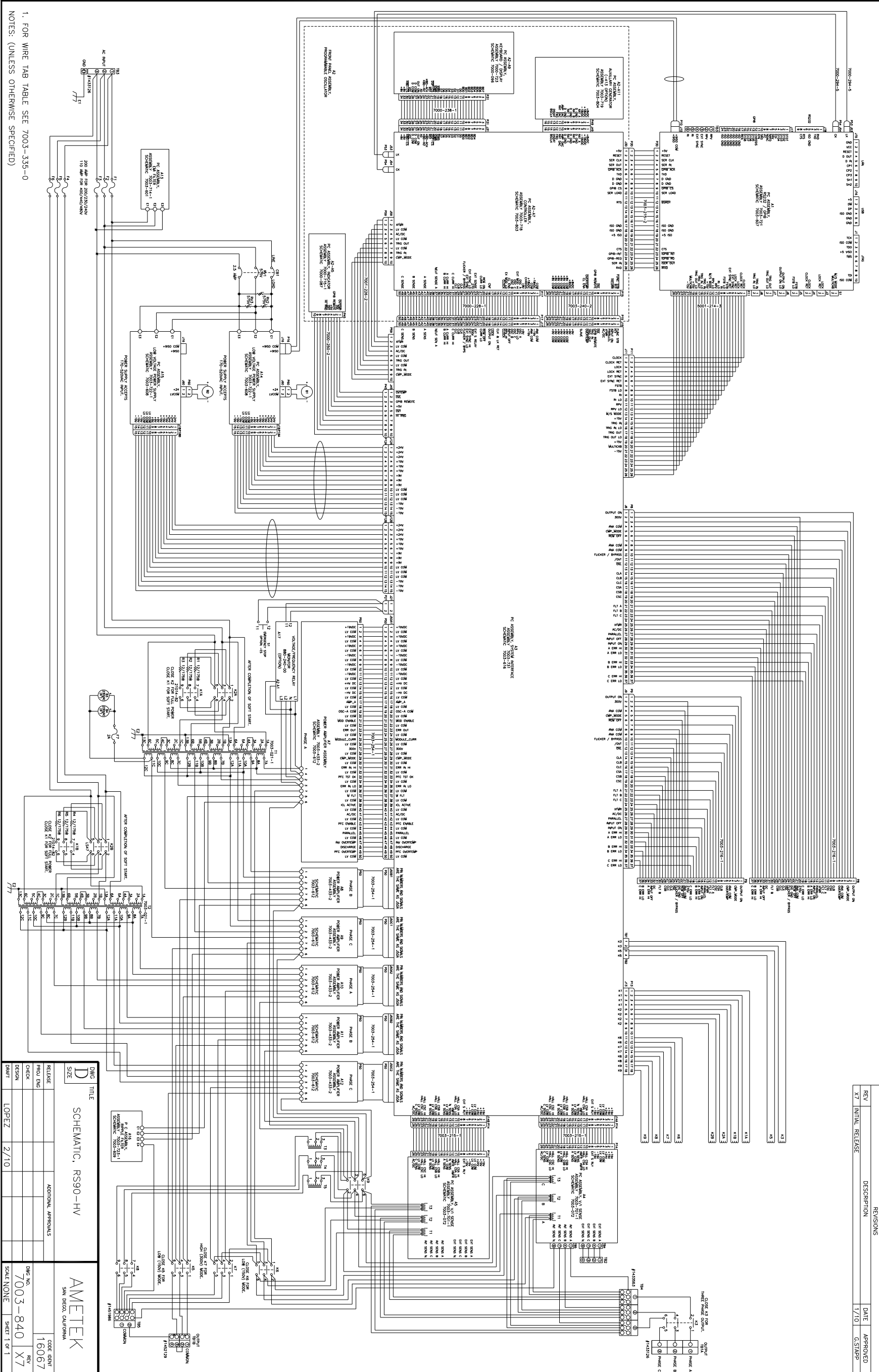

1. FOR WIRE TAB TABLE SEE 7003-335-0  
 NOTES: (UNLESS OTHERWISE SPECIFIED)

DWG TITLE		SCHEMATIC, RS90-HV	
SIZE		D	
RELEASE	PROJ ENG	ADDITIONAL APPROVALS	CODE IDENT
CHECK	DESIGN		16067
DATE	LOPEZ 2/10	DWG NO.	7003-840
		REV	X7
		SCALE	NONE
		SHEET	1 OF 1

REVISIONS		DATE	APPROVED
REV	DESCRIPTION		
X7	INITIAL RELEASE	1/10	G-SHAPP

Figure 5-2: RS Series Detailed Block Diagram

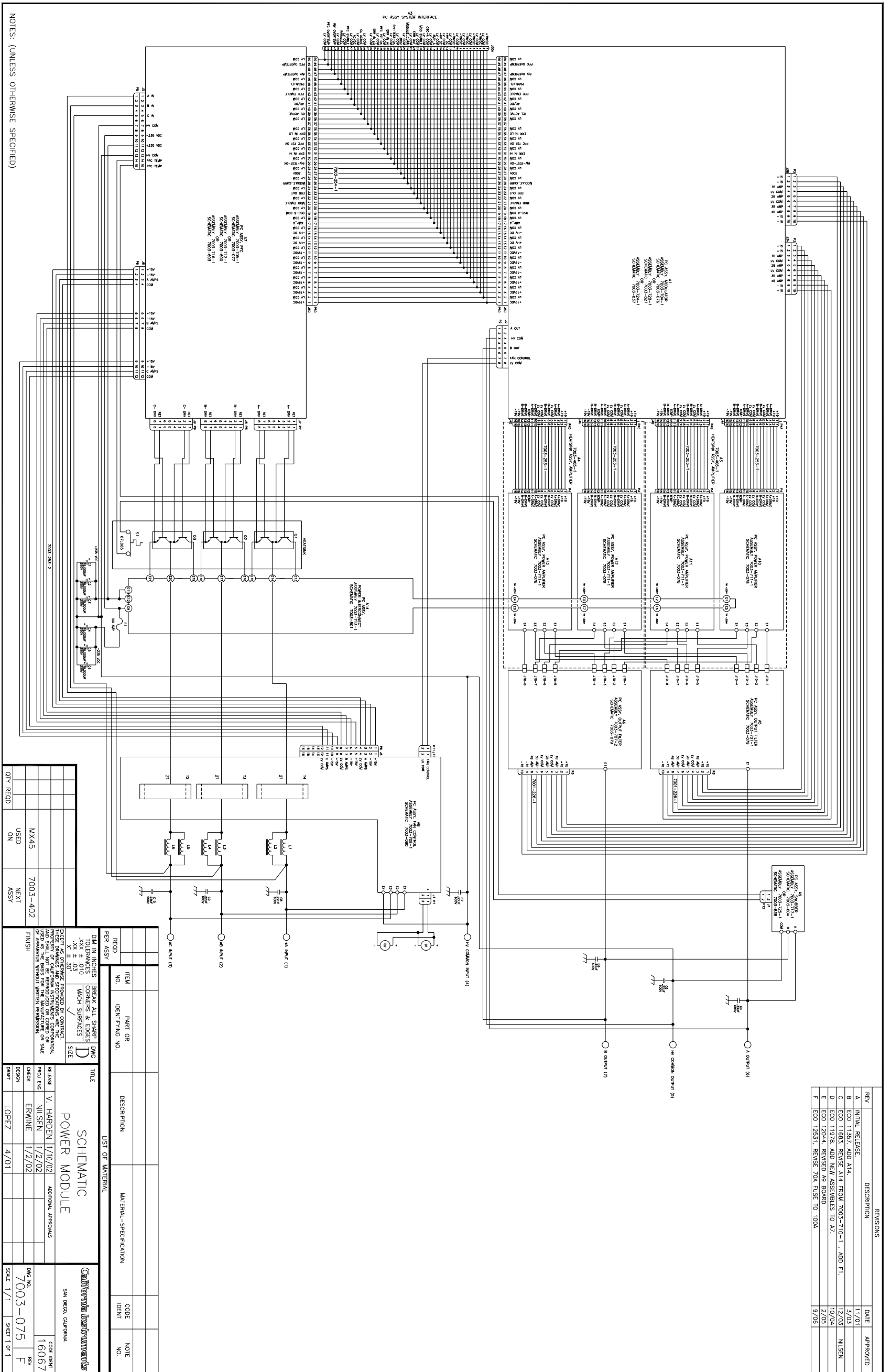

REV	DESCRIPTION	DATE	APPROVED
A	INITIAL RELEASE	11/01	
B	ECO 11357, ADD A14	3/03	
C	ECO 11683, REVISE A14 FROM 7003-710-1. ADD F1.	12/03	NILSEN
D	ECO 11978, ADD NEW ASSEMBLES TO A7.	10/04	
E	ECO 12044, REVISED A9 BOARD	2/05	
F	ECO 12531, REVISE 70A FUSE TO 100A	9/06	

NOTES: (UNLESS OTHERWISE SPECIFIED)

LIST OF MATERIAL		TITLE	
ITEM NO.	PART OR IDENTIFYING NO.	DESCRIPTION	MATERIAL-SPECIFICATION
1	PC ASSY	PC ASSY	
2	DIODE BRIDGE	DIODE BRIDGE	
3	TRANSFORMER T1	TRANSFORMER T1	
4	MOSFET	MOSFET	
5	TRANSFORMER T2	TRANSFORMER T2	
6	DIODE	DIODE	
7	CAPACITOR	CAPACITOR	
8	RESISTOR	RESISTOR	
9	POTENTIOMETER	POTENTIOMETER	
10	DRIVER IC	DRIVER IC	
11	INDUCTOR	INDUCTOR	
12	DIODE	DIODE	
13	CAPACITOR	CAPACITOR	
14	INDUCTOR	INDUCTOR	
15	RESISTOR	RESISTOR	
16	TRANSFORMER T3	TRANSFORMER T3	
17	DIODE	DIODE	
18	CAPACITOR	CAPACITOR	
19	RESISTOR	RESISTOR	
20	INDUCTOR	INDUCTOR	
21	TRANSFORMER T4	TRANSFORMER T4	
22	DIODE	DIODE	
23	CAPACITOR	CAPACITOR	
24	RESISTOR	RESISTOR	
25	INDUCTOR	INDUCTOR	
26	TRANSFORMER T5	TRANSFORMER T5	
27	DIODE	DIODE	
28	CAPACITOR	CAPACITOR	
29	RESISTOR	RESISTOR	
30	INDUCTOR	INDUCTOR	

Figure 5-3: Power Module Detailed Block Diagram

---

## 5.4 System Interface Board

---

The System Interface Board is located in the top section of the RS unit. To access this assembly, the side and front covers need to be removed. The System Interface board, A6, receives the oscillator signal from the CPU controller assembly for all phases and passes it through to all three amplifiers whose gains are controlled by a signal from the over current circuit. The over current circuit senses the RMS value of the current. If the load current exceeds the programmed value, the output of this sensing circuit reduces the amplitude of the oscillator drive signal. The output of the unit then becomes a constant current output, with the output voltage dropping as the load increases.

The System interface also monitors a variety of status signals from the amplifiers. This includes PFC good, over temperature signals and DC bus regulation good signals. If any status signal is false, the system interface board will shut down the RS. At power on, all status signals have to return good (TRUE) or the RS system power up sequence will be halted.

Finally, the System interface assembly also routes the required system interface bus signals between multiple RS90 chassis for multi-box configurations (RS180 through RS540). A DB-37 to DB-37 system interface cable is used to connect two or more RS units in a multi-box configuration. Each RS90 provides two sets of system interface connectors on the rear-panel. One is the master out (unit with CPU controller assembly installed), the other the Auxiliary in. (unit without CPU controller or with CPU controller disabled.) The CPU controller can be disabled using the internal DIP switch located on the GPIB / RS232C / IO assembly. (Requires removal of the rear cover).

---

## 5.5 Current / Voltage Sensor Board

---

The current and voltage sensor boards, A4 & A5, sense the output current and voltage of all six amplifiers and feeds this information back to the system interface board. These same signals are also used by the controller for all measurement functions. Voltage sense is accomplished either internally or externally. For best voltage regulation at the EUT, external sense connections should be made using the External Sense terminal block located at the top of the back-panel.

Alternatively, internal sense mode may be selected. In this case, the voltage is sensed at the sensor board.

---

## 5.6 Low Voltage Power Supply

---

The Low Voltage power supplies A14 & A15 are mounted behind the system interface board in the center section of the RS chassis. These two assemblies generate all required low voltage DC outputs. These outputs from the LV Power supplies provide analog and logic power to all the modules.

- a) +/- 19 V to the System Interface board and power modules.
- b) + 9 V to the oscillator.
- c) + 24 V to all contactors and LV cooling fan.
- d) Isolated + 8 V for the GPIB/RS232 board.

Four green LED's on the system interface board are lit when the  $\pm 15$  V and  $\pm 19$  V are in regulation. If an overload condition causes the output to drop more than 10% or the output has failed, the corresponding LED will extinguish. This feature is helpful in troubleshooting the unit. See Service section 6.

### 5.7 Power Module

Each RS chassis accommodates three power modules. These power modules are located in the center of the chassis and can be removed from the front after removing the front cover. Each power module is fully self-contained and forms a complete AC to AC or AC to DC converter. The three power modules are identical and can be interchanged if needed although this is not recommended under normal use.

The power module is depicted in Figure 5-4.

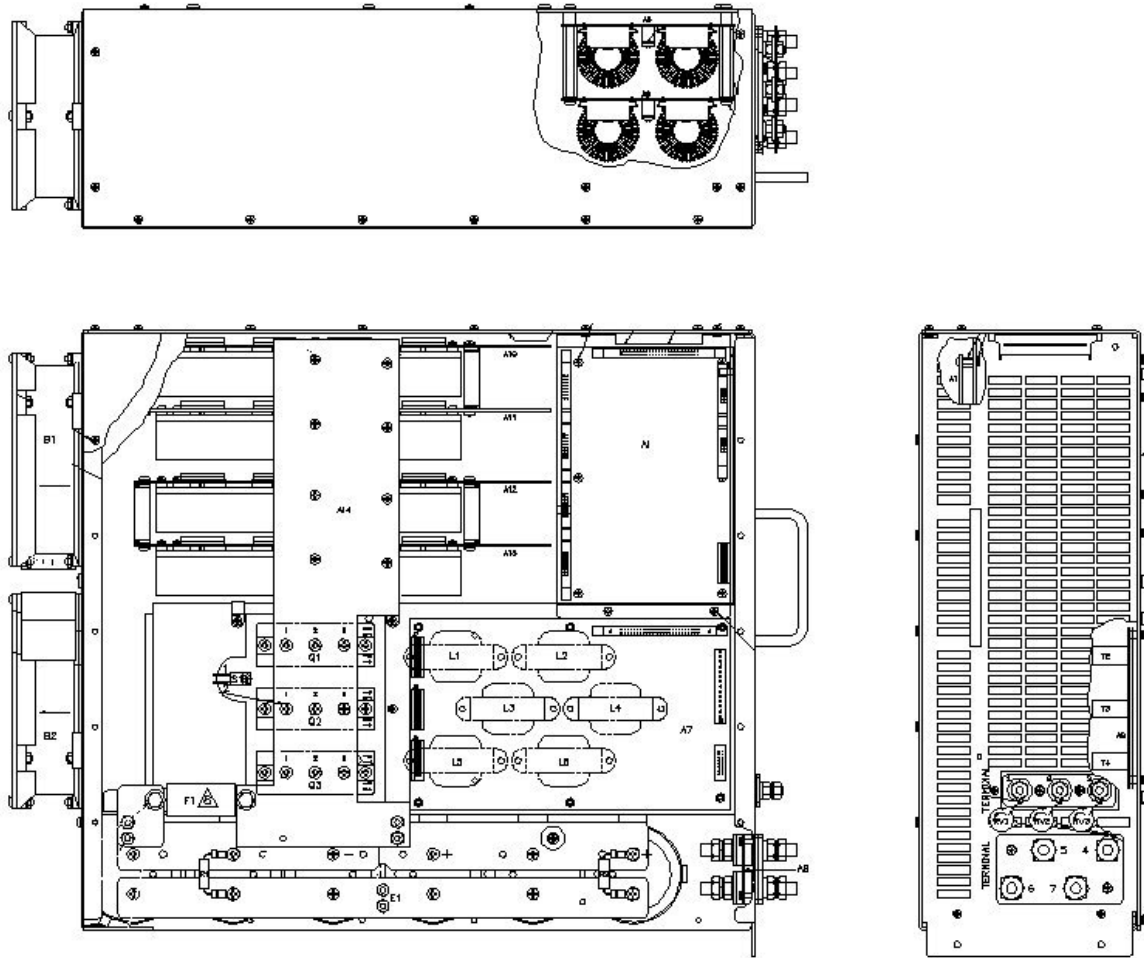

Figure 5-4: Power Module Layout

### 5.7.1 PFC Input Power Converter

---

The PCF section is located at the bottom of each power module. AC power enters the power module at the PFC input section. The PFC section using a PWM boost converter to turn the unregulated three phase 140 V AC into a regulated  $\pm 225$  V DC bus. A bank of capacitors is used to provide ride-through and to support high peak current demands from the amplifier boards. The PFC PWM circuit drives a set of three high capacity IGBT's. These IGBT's connect directly to the DC bus bars, which connect the PFC output to the Amplifier boards.

The condition of the PFC section is constantly monitored and reported to the system interface board. If the DC bus goes out of acceptable operating range, a fault is generated. Furthermore, in any of the three AC input phases fails, the RS will shut itself down.

### 5.7.2 Modulator Board

---

The modulator board is located directly above the PFC board and next to the four-board Amplifier stack. The modulator board accepts an oscillator output reference signal as input and drives the four amplifier boards using a high frequency PWM technique. The modulator has the ability to drive the amplifiers in either parallel or series configuration, thus producing either a high (300 Vac / 400 Vdc) or low (150 Vac / 200 Vdc) output voltage range. Note that some configurations of the RS Series may be hardwired for single range use.

The modulator contains several feedback loops that control the current sharing and output regulation of the four power amplifier boards. The Modulator boards connects to one of the three connectors on the System interface through a 50 pin ribbon cable located at the top front of each power module.



### 5.7.3 Amplifier Boards

The Amplifier boards are each attached to a heat sink and stacked on top of each other at the top portion of the power module enclosure. Sets of two boards are held together by a bracket which screws into the back wall of the power module enclosure. Power to each amplifier board is supplied from the PFC section through a set of DC bus bars. Each amplifier board connects to the modulator board via a small ribbon cable. Each Amplifier board has four outputs (A+, A-, B+ and B-). These four outputs connect to a set of Inductor boards using stranded wires with Anderson style connectors. The connection between the Amplifier boards and the Inductor boards is specific and should not be reversed or damage could result. The output wire connectors of each amplifier board are color coded to help identify the correct connections. The connections between the Modulator board and the Amplifier boards are one to one. (Connectors line up with amplifier boards).

The layout of the Amplifier board is shown in Figure 5-5.

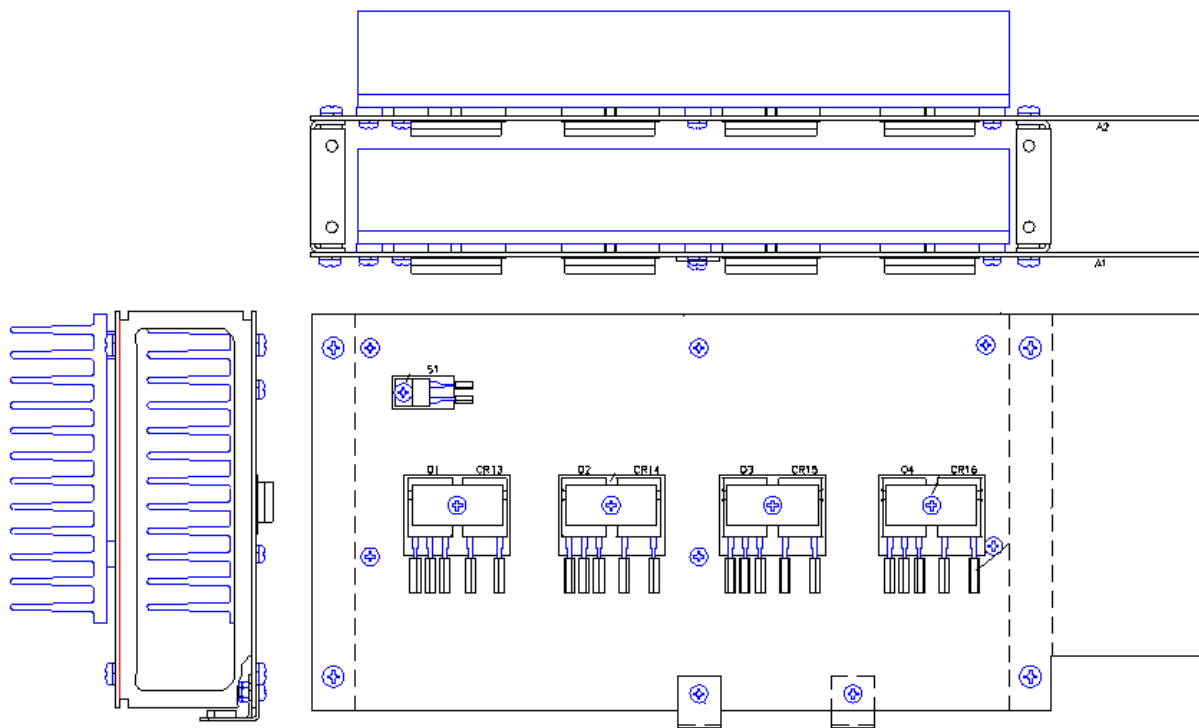

Figure 5-5: Amplifier Board Layout

#### **5.7.4 Filter Boards**

---

A set of two identical inductor boards is located behind the Modulator board and next to the four amplifier boards. One filter board handles the "A" output, the other handles the "B" output. In addition to the filtering function performed by these boards, the inductor boards also contain current sensors that are used in the feedback loop of the amplifier. The output of these current sensors is routed to the modulator board to regulate current sharing and peak current limiting.

#### **5.7.5 Fan Supply Board**

---

The Fan Supply board is located in the wind tunnel of the PFC section at the bottom of the power module. This board provides variable speed control for the dual fans of the power module. Fan speed is a function of the load current sensed. This provides for lower levels of audible noise during minimal load conditions.

#### **5.7.6 Output Snubber Board**

---

A small output snubber board is attached to the output terminals of each power module. This snubber provides the required operating stability of the amplifiers.

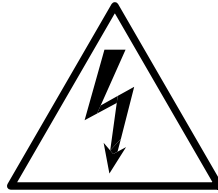

## **CAUTION**

**VOLTAGES UP TO 480 VAC AND 500 VDC ARE PRESENT IN CERTAIN SECTIONS OF THIS POWER SOURCE. THIS EQUIPMENT GENERATES POTENTIALLY LETHAL VOLTAGES.**



## **DEATH**

**ON CONTACT MAY RESULT IF PERSONNEL FAIL TO OBSERVE SAFETY PRECAUTIONS. DO NOT TOUCH ELECTRONIC CIRCUITS WHEN POWER IS APPLIED.**

## 6. Calibration

---

The Routine Calibration should be performed every 12 months. Non-routine Calibration is only required if a related assembly is replaced or if the periodic calibration is unsuccessful. Calibration of the RS system can be performed from the front panel or over the bus. The RSGUI program provides several calibration screens for this routine calibration but not for non-periodic calibration. This section covers calibration from the front panel. Refer to the RSGUI on line help for information on using the RSGUI program to perform routine calibration.

Full-scale output calibration is done using the internal measurement system. As such, it is important to calibrate the AC and DC voltage measurements before performing an AC and DC full-scale output calibration.

---

**Note:** *Perform the Measurement calibration first.*

---

The cardinal calibration points used during calibration are chosen to obtain optimal performance at the typical operating points of the RS Series. If the typical application in which the RS system is used is unusual, it may be better to calibrate it at different operating points than the ones used in this manual. Also, if the required load values for current calibration are not available, the programmed voltage may be adjusted to obtain the approximate current (typically close to maximum available current per phase).

### 6.1 Recommended Calibration Equipment

---

Digital Multimeter:	Agilent 3458A or equivalent / better.
1 mOhm Current Shunt:	Isotek Model RUG-Z-R001-0.1.
Load Bank:	Various high power load resistors or a resistive load bank will be needed. (E.g. Avtron ) Size of the load bank depends on model and phase mode. A load is required to perform the current measurement calibration near full scale. Current measurement calibration should be done on the lowest available voltage range. The accuracy and value of the load resistor is not critical as long as the current drawn is sufficient to operate the AC Source in the upper current range (80-100 %). Suggested values of load bank settings are shown in Table 6-1.
PC with CI RSGUI:	Optional.

## 6.2 Front Panel Calibration Screens

---

The calibration screens for output or measurement calibration can be selected from the MENU 3 screen. (Press MENU button several times to toggle to MENU 3 screen.)

To select the OUTPUT CALIBRATION screen press the ↑ or ↓ key several times to highlight OUTPUT CAL. Then press the ENTER key. This will bring up the PASSWORD screen. To prevent unauthorized access to calibration data, a password must be entered to access any calibration screen. The calibration password is always "**5000**" and may be entered using the numeric keypad. Once entered, the calibration screens remain accessible until the RS unit is powered down.

Type 5000 and press the ENTER key to show the OUTPUT CALIBRATION screen.

On RS systems with three-phase output capability, use the PHASE key on the front panel to select the phase to be calibrated.

To select the MEASUREMENT CALIBRATION screen, follow the same steps as outlined above but select the MEASUREMENT CAL entry instead of OUTPUT CAL. If another CALIBRATION screen has been accessed since power-up, no password is needed. Otherwise, enter the same password as indicated above.

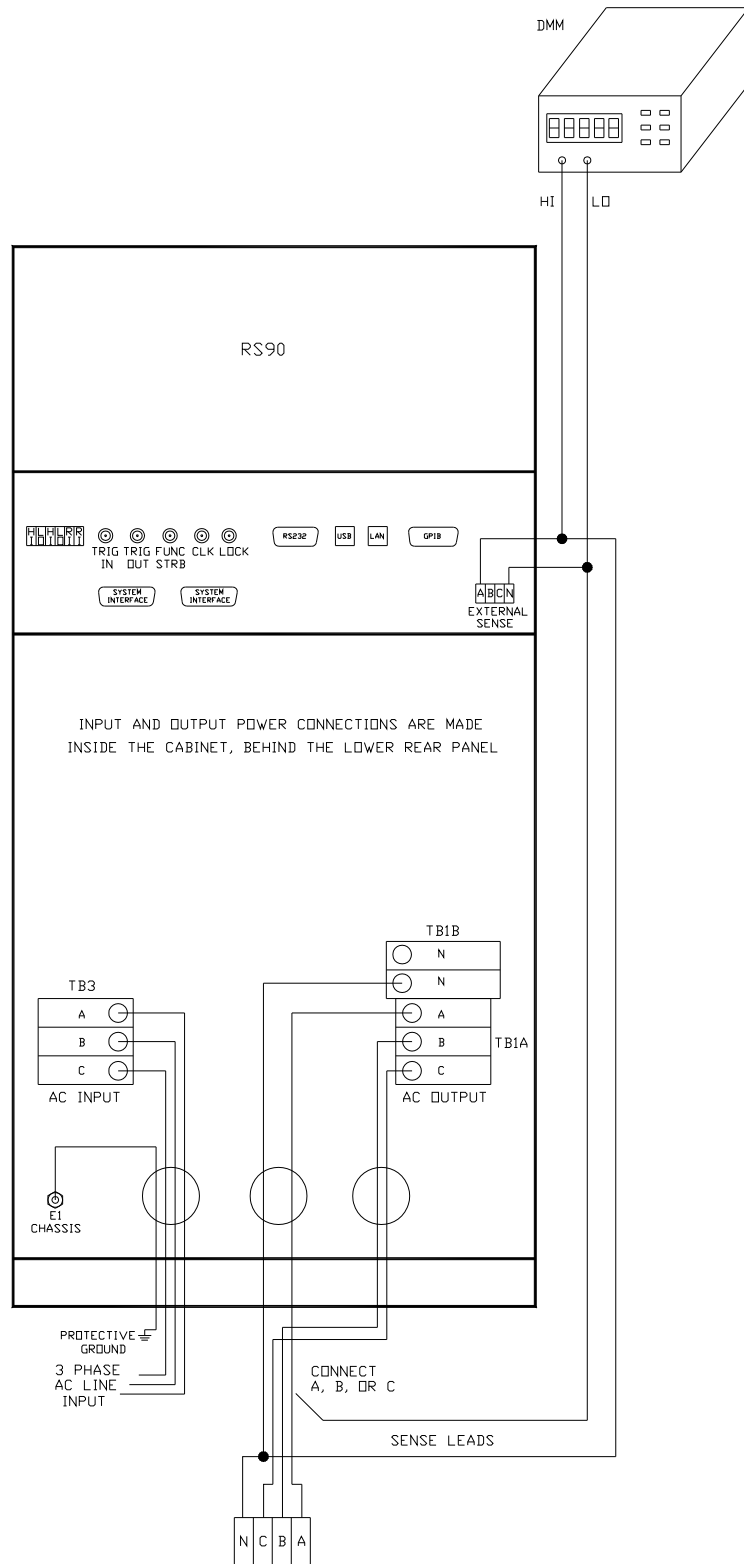

Figure 6-1: Voltage Calibration Setup RS90 (Rear view)

### 6.3 Routine Measurement Calibration

---

The RS Series controller measures voltage and current by digitizing both voltage and current waveforms on each available output phase. This data is subsequently processed and used to calculate all measurement parameters such as VRMS, IRMS, Power, VA, Frequency etc. To calibrate all measurements, only the voltage and current measurement functions need to be calibrated. All other measurements are derived from these.

Connect the test equipment to the power source as shown in Figure 6-1. The DVM for calibrating the measurement voltage should always be connected to the Remote Sense connector on the Master cabinet.

---

**Note:** *The Agilent 3458A Digital Multimeter or equivalent must be used for the following calibration.*

---

The shunt must be connected to the power source as shown in Figure 6-2. If the Current Measurement can't be successfully performed, adjust the Current Measurement Pot on the System Interface board. This adjustment is described in the Non-routine Calibration section of this manual. If the DC current measurement displays more than 70 counts on the display, perform the non-routine current monitor adjustment.

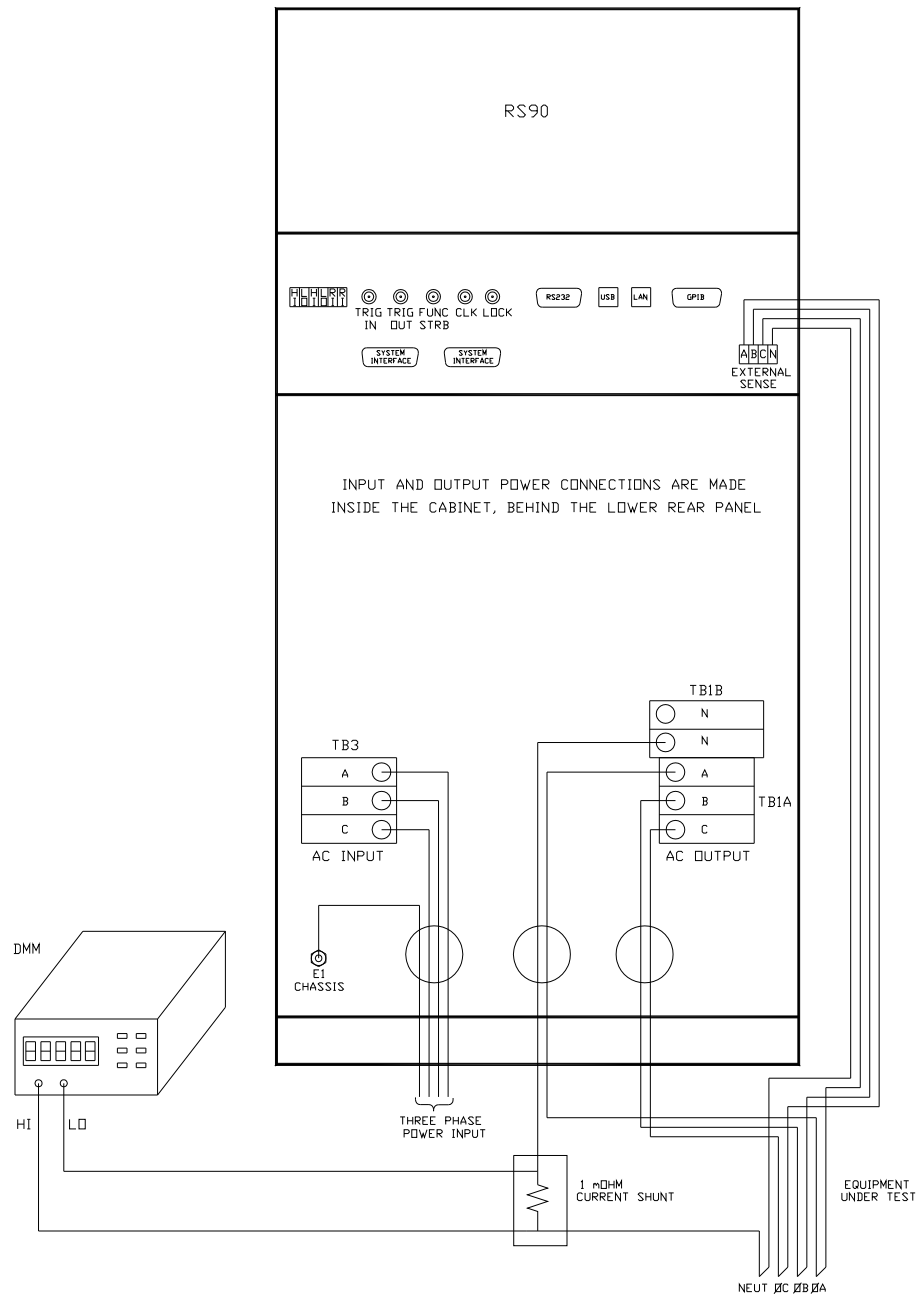

Figure 6-2: Current Measurement Calibration Setup (Rear view)



Connect the load to the output. Use the 1 mOhm current shunt in series with the load to measure the AC and DC load current. When programming a DC load always program the output voltage to 0 volts before changing the output load. This will prevent load switch contacts from being damaged.

To calibrate all measurement functions, the desired value for the measurement value of current or voltage must be entered for the corresponding calibration value. Make the indicated adjustments by typing in the desired display value. This should be the value indicated by the external DVM. If a 1 mOhm current shunt is used for current, 300 mV represents 300 amps.

The Calibration Load Table shows required load bank settings for the current measurement calibration procedure. The following text is a detailed explanation of the procedure.

Note that the voltage measurement calibration is only required on the high voltage range. The same voltage measurement calibration coefficients are used on both voltage ranges.

Note that the current measurement calibration is only required on the low voltage range – maximum available current range. The same current measurement calibration coefficients are used on both voltage ranges (if available). Suggested load values are shown for either voltage range in case the RS is only used in a single voltage range.

PARAMETER	POWER SYSTEM		
<b>Model ---&gt; Lowest Range</b>	<b><u>RS90-3(Pi)</u></b>	<b><u>RS180-3(Pi)</u></b>	<b><u>RS270-3(Pi)</u></b>
<b><u>150 VAC / 200 VDC</u></b>			
AC Current Full Scale	0.5 $\Omega$ , 30KW	0.25 $\Omega$ , 60KW	0.16 $\Omega$ , 90KW
DC Current Full Scale	1.33 $\Omega$ , 20KW	0.64 $\Omega$ , 40KW	0.43 $\Omega$ , 60KW
<b><u>300 VAC / 400 VDC</u></b>			
AC Current Full Scale	2.0 $\Omega$ , 30KW	1.0 $\Omega$ , 60KW	0.65 $\Omega$ , 90KW
DC Current Full Scale	5.2 $\Omega$ , 20KW	2.6 $\Omega$ , 40KW	1.8 $\Omega$ , 60KW
PARAMETER	POWER SYSTEM		
<b>Model ---&gt; Lowest Range</b>	<b><u>RS360-3(Pi)</u></b>	<b><u>RS450-3(Pi)</u></b>	<b><u>RS540-3(Pi)</u></b>
<b><u>150 VAC / 200 VDC</u></b>			
AC Current Full Scale	0.12 $\Omega$ , 120KW	0.1 $\Omega$ , 150KW	0.08 $\Omega$ , 180KW
DC Current Full Scale	0.33 $\Omega$ , 80KW	0.26 $\Omega$ , 100KW	0.22 $\Omega$ , 120KW
<b><u>300 VAC / 400 VDC</u></b>			
AC Current Full Scale	0.5 $\Omega$ , 120KW	0.4 $\Omega$ , 150KW	0.33 $\Omega$ , 180KW
DC Current Full Scale	1.3 $\Omega$ , 80KW	1.1 $\Omega$ , 100KW	0.9 $\Omega$ , 120KW

Table 6-1: Calibration Load Values

### 6.3.1 Measurement Cal - AC

---

To calibrate AC measurements, set the power source to the AC mode. Select the MEASUREMENT CAL entry from the MENU 3 screen. Refer to section 4.2.12 for relevant LCD screen.

---

**Note:** *For the following calibration steps put the external Digital Multimeter into AC mode.*

---

AC Volt Full-scale:	Program the output to the 300 VAC range. Close the output relay. Program the output to 240 VAC and 60 Hz. Go to the MEASUREMENT CALIBRATION screen. Enter the actual AC output voltage for the VOLT FS parameter and press the ENTER key.
AC Current Full-scale:	Apply a load to the output. Refer to Table 6-1. Program the output to 120 VAC on the 150 VAC range and 60 Hz. (If a 150 VAC range is not available, select the 300 VAC range and program the same 120 VAC output.) Observe the actual output current and enter this value for the CURR FS parameter. Press the ENTER key.

### 6.3.2 Measurement Cal - DC

---

To calibrate DC measurements, set the power source to the DC mode. Select the MEASUREMENT CAL entry from the MENU 3 screen. Refer to section 4.2.12 for relevant LCD screen.

---

**Note:** *For the following calibration steps put the external Digital Multimeter into DC mode.*

---

DC Volt Full-scale:	Program the output to +320 volts. Go to the MEASUREMENT CALIBRATION screen. Enter the actual DC output voltage displayed on the external multimeter for the VOLT FS parameter and press the ENTER key.
DC Current Full-scale:	Program the output to 0 volts on the 200 range. Apply load resistor to the output. Refer to Table 6-1. Program 160 volts. Enter the actual output current for the CURR FS parameter in the MEASUREMENT CALIBRATION screen.

Repeat the preceding steps for the Phase B and C outputs. The order in which the outputs for each phase are calibrated is not important.

Press the PHASE key to select each output to be calibrated. Monitor the output of the respective phase by moving the HI input of the Digital Multimeter and the current shunt as needed. The LO input should remain connected to the common LO of the sense connector.

### 6.3.3 Measurement Calibration Summary

The following Table is a summary of the preceding calibration steps. The value indicated by the External DVM is called  $V_{AC}$  or  $V_{DC}$ . The current measured by the current shunt is called  $I_{AC}$  or  $I_{DC}$ .

TITLE	PROGRAM/LOAD PARAMETERS	PARAMETER	ADJUST TO
<b>AC MODE</b> AC Volt Full-scale AC Current Full-scale	300 VAC Range, 240 VAC, 60 Hz, no load 150 VAC Range, 120 VAC, 60 Hz, full load to 90% of max current range.	VOLT FS CURR FS	$V_{AC}$ $I_{AC}$
<b>DC MODE</b> DC Volt + Full-scale DC Current Full-scale	400 VDC Range, + 320 VDC, no load 200 VDC Range, 160 VDC, full load to 90% of max. current range.	VOLT FS CURR FS	$V_{DC}$ $I_{DC}$

Table 6-2: Measurement Calibration Table - TBD

Repeat Paragraph 6.3 for each phase. Move the external test equipment to the phase that is being calibrated. Refer to Figure 6-2..

While viewing the calibration screen, press the PHASE key to select the respective phase.

## 6.4 Routine Output Calibration

For best results, it is recommended to perform the measurement calibration procedure first. See section 6.3.

Follow the steps outlined in this section to perform a routine output calibration. Note that each available output range (except -HV and -XV options) has its own output calibration coefficients and must be calibrated. Table 6-3 shows the individual calibration points in a summary format. The following text is a more detailed explanation of the procedure.

The full-scale calibration should be done in the AC and DC mode for both the low and high range if available. The option -HV range can be done only if the high range (300VAC) is not available. If both the standard high range and the -HV or -XV optional ranges are available, calibrate the standard range.

**Note:** Selecting the calibration screen (by entering the Cal Password) will turn off the ALC mode. Conversely, turning on the ALC mode will turn off the Calibration mode. If the ALC mode is turned off during calibration, the cal password will have to be re-entered to allow calibration.

### Setup:

Connect the test equipment to the power source depending on model configurations as shown in Figure 6-1. For multi-phase systems, each phase has to be calibrated individually. Note that no load is required for most output calibrations.

### DC Offset measurements:

If the DMM used to perform DC offset calibration has trouble rejecting AC noise in VDC mode (measurement not stable), it may be necessary to use a small filter circuit at the output of the amplifier to measure the DC offset. A 100Kohm RN60 1/4W (CI P/N 560131) and 22uF, 35V (CI P/N 611267) series network can be used in this case as shown below. Use this circuit only while performing DC offset checks and remove for other calibrations.

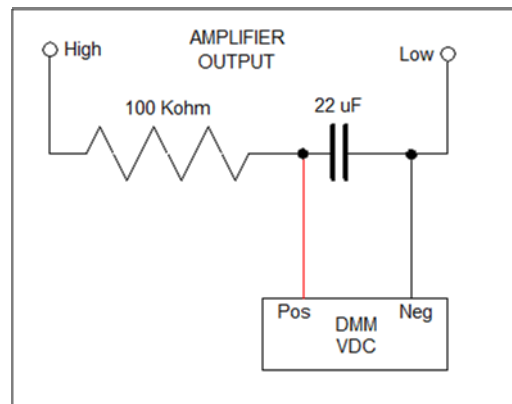

Figure 6-3: DC offset AC filter

---

### 6.4.1 Output Cal

---

300 VAC Range DC Zero: Program the output to the 300 VAC Range by pressing and selecting the 300 Range with the shuttle. Program the output to 0.0 volts and 60 Hz. Go to the OUTPUT CAL screen, select the VOLT ZERO parameter and adjust the output to  $0.0 \pm 0.005$  VDC. **Save this value by pressing the ENTER key.**

300 VAC Range High Freq DC Zero: Required for Series II models with –HF option only. Program the output to the 300 VAC Range by pressing and selecting the 300 Range with the shuttle. Program the output to 0.0 volts and **820** Hz. Go to the OUTPUT CAL screen, select the VOLT ZERO parameter and adjust the output to  $0.0 \pm 0.005$  VDC. **Save this value by pressing the ENTER key.**

To calibrate AC output, set the power source to the AC mode, high voltage range. For RS units with the –HV optional range, use the 300V range for all calibrations. Select the OUTPUT CAL entry from the MENU 3 screen. Refer to section 4.2.13 for relevant LCD screen.

300 VAC Range Full-scale: Before programming the output voltage, first set the **ALC** mode to **OFF** in the UTILITY, VOLT/CURR CONTROL screen. Then select the 300 VAC Range from the Program 1 screen. Program the output to 240.0 volts and 60 Hz and close the output relay. Go to the OUTPUT CAL screen, select the VOLT FS and enter 20000. With the shuttle, adjust this value to obtain  $240 \pm 0.05$  volts at the output as measured with an external DMM. Use the ENTER key to save this value.

---

### 6.4.2 Three Phase Mode

---

As indicated earlier, for 3-Phase power system, repeat the preceding steps for the Phase B and C outputs. The order in which the outputs for each phase are calibrated is not important.

Press the PHASE key to select each output to be calibrated. Monitor the output of the respective phase by moving the HI input of the Digital Multimeter. The LO input should remain connected to the common LO of the sense connector.

### 6.4.3 Phase Angle Calibration

---

Output phase angle calibration is required only on RS Series models capable of three-phase mode operation. A phase meter is required to perform this calibration.

This calibration can be done in either high or low voltage range as long as the maximum input voltage of the phase meter input is not exceeded. Select AC mode, three-phase mode, 120Vac, 60 Hz. Program all three-phase outputs to the same voltage.

For best results, the output of all amplifiers should be loaded to at least 80% of full scale voltage current on all phases at the same time. This requires a three-phase load. If no such load is available, perform this calibration with no load.

Proceed as follows:

1. Program AC mode, 3 phase, low voltage range, 120Vac, 50 or 60 Hz. Close output relay.
2. Select the OUTPUT CAL screen.
3. Connect phase meter between phase A and B outputs.
4. Use the PHASE key to select phase B in the upper right corner of the CAL screen.
5. Close output relay and measure the phase angle between phase A and Phase B.
6. Adjust PHASE OFST cal coefficient up or down and press ENTER key until phase B offset is  $240^\circ \pm 0.5^\circ$  or better.
7. Connect phase meter between phase A and C outputs.
8. Use PHASE key to select phase C in the upper right corner of the CAL screen.
9. Adjust PHASE OFST cal coefficient up or down and press ENTER key until phase C offset is  $120^\circ \pm 0.5^\circ$  or better.

#### 6.4.4 Option -413 Calibration

If the IEC61000-4-13 auxiliary generator option is installed, the following calibration procedure applies. Refer to for the locations of the adjustment pots on the Aux. Waveform Generator (CI P/N 7004-719-1).

**CAUTION:** *This will require the top cover to be removed. Always use caution when removing the top panel to not touch the LV supply. This procedure should be performed by qualified personnel only*

1. Select AC mode, 300V range, 0.0 Vac, 50 Hz. Do not apply a load. Close output relay.
2. Select **INTER HARMONICS** the **MENU 2** screen. The following values will be displayed:

INTER HARMONICS	
REF. VOLT = 0.0 VAC	FREQUENCY = 400 Hz
VOLTAGE = 0.0%	REF. COUPL = OFF
	REFERENCE = OFF

3. Select **REFERENCE** and program **ON** with the shuttle.
4. Select **REF VOLT** and program 230.0.
5. Select **VOLTAGE** and program 8.7%.
6. Select **FREQUENCY** and program 400 Hz. This combination of values should generate a 20.0 Vac RMS output from the **AUX.** Generator. See sample below:

INTER HARMONICS	
REF. VOLT = <b>230.0</b> VAC	FREQUENCY = <b>400</b> Hz
VOLTAGE = <b>8.7%</b>	REF. COUPL = OFF
	REFERENCE = <b>ON</b>

7. Adjust the respective pot for the output phase being calibrated for a  $20.0 \pm 1.0$  volt output on the external **AC DVM**.

PHASE	ADJUSTMENT POT
A	R9
B	R10
C	R11

8. Select **FREQUENCY** in the **INTER HARMONIC** screen and program the frequency to 1800 Hz.
9. Select the **OUTPUT CALIBRATION** screen.
10. Select the **INTER HARM FS** value.
11. Use the shuttle to calibrate the output voltage to  $20.00 \pm 1.0$  volts rms.
12. Select **REFERENCE** and program **OFF** with the shuttle.
13. Open output relay. This completes the -413 option calibration.

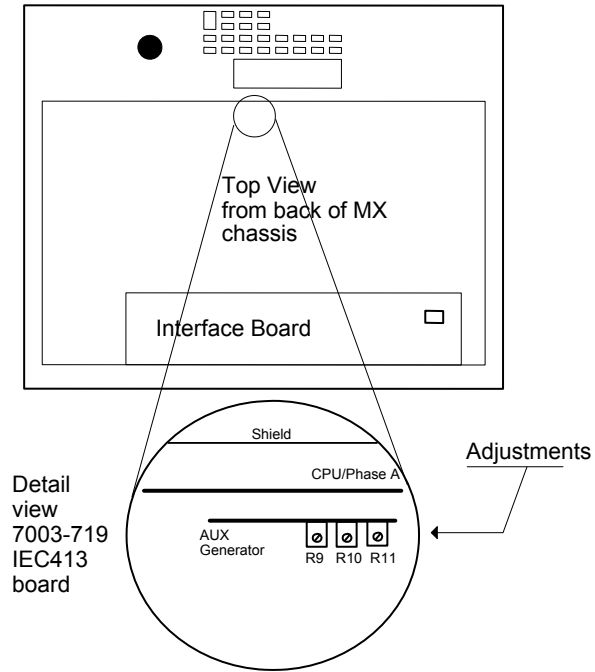

Figure 6-4: -413 Option Aux Generator Adjustments - TBD



### 6.4.5 Output Calibration Summary

The following Table is a summary of the preceding calibration steps. Program the following values in the table and make the adjustments in the OUTPUT CALIBRATION screen. Select the phase to be calibrated by pressing the PHASE key.

CALIBRATION	PROGRAM VALUES	CALIBRATION VALUE	ADJUST TO
300 VAC range DC Zero	300 VAC range, 0.0 V, 60 Hz	VOLT ZERO	0 ± 5 mV DC
300 VAC range High Freq DC Zero, -HF models only.	300 VAC range, 0.0 V, 820 Hz	VOLT ZERO	0 ± 5 mV DC
300 VAC range Volt FS	240.0 V, 60 Hz	VOLT FS	240 ± 0.05 VAC
400 VDC range DC Zero	400 VDC range, 0.0 V	VOLT ZERO	0 ± 5 mV DC
Phase Offset B, C	150 VAC range, 120V, 60 Hz	PHASE OFST	± 0.5°
Option -413	400 Hz, 20VAC 1800 Hz, 20VAC	R9, R10, R11 INTER HARM FS	20 ± 1.0 Vrms 20 ± 1.0 Vrms

Table 6-3: Output Calibration Table – RS Series

---

## 6.5 Non-Routine Calibration

---

The non-routine calibration may involve removing the front or top cover of the power source. Use extreme caution when performing any of these tasks while the system is connected to AC mains and/or powered up.

### 6.5.1 Power Source Gain Adjustment

---

For any RS configuration that requires two or more amplifiers to be operated in parallel for increased current output, the amplifier gains have to be matched as closely as possible to ensure equal current sharing. If an unbalance exists between amplifier outputs, one or the other amplifier will deliver more current and may run into its current limit protection before full output power can be attained.

This procedure details the gain adjustment. Generally, RS units are shipped with the gains already set correctly so this task should only be undertaken if an amplifier has been replaced or if two RS units are to be combined that were not originally shipped from the factory as such.

To make this adjustment the front cover must first be removed in order to get access to the power module output terminals.

If the power system to be adjusted is an RS180 through RS540, the procedure involves matching the output voltage of the A, B and C power modules in the master cabinet to the A, B and C power modules in the auxiliary cabinet(s). Proceed as follows:

1. Shut off all power to the cabinets. Disconnect the two wires going to Terminal 6 and Terminal 7 on the lower front of the power modules. Do this to module A, A', B, B', C and C' in the auxiliary cabinet(s) only. Place some temporary insulation over the lug ends.
2. Connect a DMM between terminals 6 and 7 on the A module in the **master cabinet**. Power up the cabinet. Set the controller to the 300V range, program 230V at 60Hz. Enable the output by pressing the OUTPUT ON/OFF key. Measure the A module output voltage and write it down. Press the OUTPUT ON/OFF key to disable the output.
3. Move DMM leads to the B module terminals 6 and 7. Press the OUTPUT ON/OFF key to enable the output. Measure the B module output and write it down, Press the OUTPUT ON/OFF key to disable the output.
4. Move DMM leads to the C module terminals 6 and 7. Press the OUTPUT ON/OFF key to enable the output. Measure the C module output and write it down, Press the OUTPUT ON/OFF key to disable the output.
5. Move the DMM leads to the A module terminals 6 and 7 in the **auxiliary cabinet**. Press the OUTPUT ON/OFF key again to enable the output. Verify the phase A module output is within 50mVolts of the A module in the master cabinet. If it is not, adjust the pot behind the hole in the upper left corner of the module so the A output matches the A master output within 50mVolts. Repeat for the A' module. Press the OUTPUT ON/OFF key to disable the output.
6. Move the DMM leads to the B module terminals 6 and 7 in the **auxiliary cabinet**. Press the OUTPUT ON/OFF key again to enable the output. Verify the phase B module output is within 50mVolts of the B module in the master cabinet. If it is not, adjust the pot behind the hole in the upper left corner of the module so the B output matches the B master output within 50mVolts. Repeat for the B' module. Press the OUTPUT ON/OFF key to disable the output.
7. Move the DMM leads to the C module terminals 6 and 7 in the **auxiliary cabinet**. Press the OUTPUT ON/OFF key again to enable the output. Verify the phase C module output is within 50mVolts of the C module in the master cabinet. If it is not, adjust the pot behind the hole in the upper left corner of the module so the C output matches the C master output

within 50mVolts. Repeat for the C' module. Press the OUTPUT ON/OFF key to disable the output.

8. If power system under adjustment is an RS270 through RS540, then repeat steps 5, 6 and 7 above for the additional auxiliary cabinets.
9. Power down system and replace the wires to terminals 6 and 7 on the auxiliary power modules.

## 7. Service

---

### 7.1 Cleaning

---

The exterior of the power source may be cleaned with a cloth dampened with a mild detergent and wrung out. Disconnect mains power to the source before cleaning. Do not spray water or other cleaning agents directly on the power source.

### 7.2 General

---

This section describes the suggested maintenance and troubleshooting procedures. The troubleshooting procedure is divided into two sections. The first section deals with basic operation and connection of the equipment. The second section requires opening the unit and using LED indicators and a simple multimeter to troubleshoot the unit down to the module level. Only a qualified electronic technician should attempt this level troubleshooting.

### 7.3 Basic operation

---

PARAGRAPH	PROBLEM
0	Excessive Output Voltage
7.3.2	Poor Output Voltage Regulation
7.3.3	Overload Light On
7.3.4	Distorted Output
7.3.5	Unit Shuts Down After 1-2 Seconds
7.3.6	No Output and no lights on front panel
7.3.7	No output, but front panel controller is active.

Table 7-1: Basic Symptoms

#### 7.3.1 Excessive Output Voltage

---

CAUSE	SOLUTION
External sense not connected (If used)	Connect external sense wires from TB2 on rear panel to the AC power outlet TB1A and TB1B

#### 7.3.2 Poor Output Voltage Regulation

---

CAUSE	SOLUTION
Unit is overloaded	Remove overload
Unit is programmed to wrong voltage range.	Select correct voltage range.
Input line has fallen below spec. limit.	Check input supply voltage.

### 7.3.3 Overload Light is On

---

CAUSE	SOLUTION
Unit is overloaded	Remove overload or check CL setting
Unit is switched to high voltage range.	Select correct voltage range.

### 7.3.4 Distorted Output

---

CAUSE	SOLUTION
Power source is grossly overloaded.	Reduce load
The crest factor of the load exceeds 3:1 on the low range or 5:1 on the high range.	Reduce load current peaks by reducing load.

### 7.3.5 Unit Shuts Down after 1-2 Seconds

---

CAUSE	SOLUTION
Output shorted	Remove output short
Output grossly overloaded.	Remove overload.
PFC IGBT module failure	Have power module serviced
Operating load with too high inrush or start up currents.	Consult factory for application advice.

### 7.3.6 No Output and No Lights on Front Panel

---

CAUSE	SOLUTION
Input circuit breaker switched off.	Switch the breaker on.
No input power to F1, F2 and F3.	Ensure 3 phase power is getting to input fuses.
LV Power Supply failure	Have LV supply serviced.

### 7.3.7 No Output But Front Panel controller is active

---

CAUSE	SOLUTION
“OUTPUT ON” button is turned off.	Press OUTPUT ON so that “ON” LED is lit.
REMOTE INHIBIT pins 5 & 6 at TB3 on rear panel are shorted together.	Check polarity setting or RI Mode. Use OUTPUT:RI[:LEVel] LOW/HIGH command to set RI mode to high or low.
Current limit programmed down or to zero.	Program current limit higher.
Voltage programmed down or to zero.	Turn amplitude control up.

---

## 7.4 Advanced Troubleshooting.

---



**WARNING:** Do not connect 400-480V into the 208-240V unit, the result could be a severely damaged unit.

---



**CAUTION:** VOLTAGES UP TO 480 VAC AND 450 VDC ARE PRESENT IN CERTAIN SECTIONS OF THIS POWER SOURCE.

---



**WARNING:** THIS EQUIPMENT GENERATES POTENTIALLY LETHAL VOLTAGES. DEATH ON CONTACT MAY RESULT IF PERSONNEL FAIL TO OBSERVE SAFETY PRECAUTIONS. DO NOT TOUCH ELECTRONIC CIRCUITS WHEN POWER IS APPLIED

---

### 7.4.1 Switch Off Unit

---

Switch off the unit at the circuit breaker on the front panel as well as removing the input power from the unit.

---



**WARNING:** Wait 10 minutes for all internal capacitors to discharge.

---

### 7.4.2 Removing Covers

---

Remove the screws securing the front cover and remove it.

Remove the screws securing the top cover and remove it.

### 7.4.3 Initial Inspection

---

Make a visual inspection of the unit and ensure all the connectors are properly mated and there are no loose wires.

### 7.4.4 Fuse Check

---

Using an ohmmeter, check input fuses F1 through F6 for continuity.

### 7.4.5 Power-on Troubleshooting Using the LED's.

---



**WARNING:** *Do not touch any parts inside the unit during this test as they will be live and dangerous. Always wear safety glasses.*

---

If the three input fuses are OK, then reconnect the main AC input power to the cabinet.

#### **LV Supply (CI P/N 7003-722):**

Turn the main breaker on and check green LED DS2 and DS3 on the system interface board. Both LEDs should be lit indicating the +/-19Vdc and +/-15Vdc supplies are OK.

If one or both of the LEDs is not lit, then there is something wrong with the LV power supply and it will have to be serviced.

#### **Oscillator (Front Panel):**

If LV supply appears good, then program 150Vac on the low range and connect a DMM to TP2 (phase A) on the system interface board with the low side of the meter connected to TP1. There should be a 2 – 3 volt rms signal present on TP2. Check TP3 (phase B) for the same signal. Check TP4 (phase C) for the same signal.

#### **AC power module (CI P/N 7003-433-X):**

If the oscillator drive signals are present on the system interface board, connect the DMM to brass terminals 5 & 6 located near the bottom of the power module. Program 100 Volts.

There should be about 100Vac between terminals 5 and 6. If no voltage at all is measured it is possible that the AC power stage inside the module has failed and it will be necessary to remove the power module from the chassis for closer inspection.

---



**WARNING:** *Wait 10 minutes for all internal capacitors to discharge.*

---

To remove the power module proceed as follows:

1. Disconnect the 7 wires going to the brass terminals on the lower front panel of the module. Label the wires so they can be reinstalled correctly later.
2. Remove screws securing the upper and lower straps holding the module in the chassis slot.
3. Remove the 50-pin ribbon connector at J50A, B or C.
4. Carefully slide module outward and lift out of cabinet. Use caution, module weighs 66 LBS (30Kg).
5. With the power module out of the cabinet and lying flat on a bench, remove the screws on the bottom and sides of the left hand cover as seen from the front when module is installed normally.
6. Inspect the three IGBT transistor modules Q1, Q2 and Q3 for any visible damage.
7. Using an ohmmeter check the 30A fuses on the positive and negative side of the power distribution board that connects the four amplifier modules to the DC bus. If any of them are open, then one or more of the amplifier sections has a damaged device on the heat sink assemblies and the power module assembly will have to be serviced.

### 7.4.6 Other No Output Conditions

---

If one or more outputs (phase A, B or C) do not produce an output, it may be caused by an amplifier failure. Amplifier failures can either be input (PFC) or output related (Amp). To

determine if this is the case, the cover of the amplifier has to be removed. Contact customer service [service.ppd@ametek.com](mailto:service.ppd@ametek.com) before attempting to diagnose on your own.

PFC failure denotes one or all three of the IGBT power modules on the large PFC heat sink have shorted, and damaged the devices. This type of failure is sometimes accompanied by a popping sound as the large PFC power devices give out. To diagnose this failure mode, the amplifiers must be removed and the cover removed for inspection.

If there is any sign of damage, the PFC power devices must be replaced. If not, they need to be checked for continuity using a DMM or diode checker.

In case of a PFC failure, older generation PFC control boards (7003-705 or 7003-712) may have sustained damaged in the isolated gate drive section of the board and the board itself may have to be replaced. RS Systems with later generation 7003-716 PFC control boards generally will only require replacement of the 2A gate fuses to restore functionality.

If the PFC section looks intact, one of the output amplifier switches may have shorted.

The usual scenario is one or two of the IGBT switch devices on one of the 4 heat sinks get shorted. Usually if the B+ device is failed, the B- device will also short. When these devices short, one or more of the 30A fuses (F1 through F8) on the DC power distribution board will be open.

An amplifier device failure is not audible at all so there may be no indication of this other than checking as follows:

1. Measure the output voltage with Zero AC volts programmed.
2. Remove any EUT from the output connections.
3. Turn output ON and measure the AC and DC output. It should be close to zero.
4. If the output reads  $-225\text{VDC}$  on the low range and close to 0 Vdc on the high range, then it is almost certain that the fuse is blown and 1 or 2 IGBT devices are shorted.

Note that the measurement screen will not report the DC faulty output voltage in the AC mode, as the measurements in this mode are AC coupled. Therefore, it is necessary to measure at the output terminals with a DMM to determine the actual output. Alternatively, the RS can be switched to AC+DC mode in which case the internal measurements can be used instead.

If it is determined that it is an amplifier failure, the affected power MOSFET's need to be replaced. If no local service support is available, the amplifier may be exchanged completely. Contact customer service [service.ppd@ametek.com](mailto:service.ppd@ametek.com) for module exchange information.

---

## 7.5 Factory Assistance

---

If the problem with the cabinet or one of the power modules cannot be isolated, contact the factory for assistance.



## 7.6 Fuses

---

FUSE #	FUNCTION	FUSE VALUE	CI #
F1 thru F6	AC mains input, 208 - 240V.	200A	270246
F1 thru F6	AC mains input, 400 - 480V	110A	270226
F1	Power Module PFC Fuse	100A	270249
F1 – F8	AMP Heat Sink Fuses	30A	270168
F7	Fan Fuse, 250V	2A	270134

Table 7-2: RS Fuse Ratings

## 7.7 Firmware Updates

---

All RS Series units shipped with firmware revision 1.00 or higher support firmware updates over the RS232C interface. If your unit came with a firmware revision less than 1.00 (0.XX), contact customer service at [service.ppd@ametek.com](mailto:service.ppd@ametek.com) for information on firmware upgrades. (Refer to Service Bulletin SB-0043 for required controller modifications to support firmware updates over the RS232 interface.)

Units that support firmware updates over the RS232 interface will have a longer initial delay at power up. This additional time delay at power-up allows the firmware erase and upload process to be engaged if needed.

### 7.7.1 Requirements

---

This section provides basic instructions for updating firmware on RS series AC power sources. The following items are required to download new firmware:

- A copy of the new firmware in HEX format. Typically named “cic637rn.nn.hex” where “n.nn” represents the revision of the firmware. The file may be downloaded from the AMETEK Programmable Power website ([www.programmablepower.com](http://www.programmablepower.com)) or may have been distributed through email. If the file is archived to a zip, it must be unzipped to its original HEX format (.hex extension) before it can be used.
- The FlashLoaderComm utility program. This Windows program can be downloaded from the AMETEK Programmable Power website ([www.programmablepower.com](http://www.programmablepower.com)) under GUI/Software. You need to be a registered user to do so.
- A Windows 2000/XP PC with available RS232 serial port (COM port).
- A RS232<sup>1</sup> serial cable, CI P/N 7000-263-2. This cable is provided in the RS Series ship kit. If lost, refer to the RS Series programming manual (PN 7003-961) for cable pin-out information or contact customer service ([service.ppd@ametek.com](mailto:service.ppd@ametek.com)) to order a replacement.

### 7.7.2 Download Instructions

---

Copy both FlashLoaderComm.exe and cic637rn.nn.hex files to a temporary folder on your PC. If the FlashLoaderComm.exe was downloaded from the CI web site, it will have to be installed. This is a self-extracting program installation. Just double click on the exe file to perform the installation and follow the user prompts.

Cic637rn.nn.exe is the hex file that contains the firmware update. The n.nn will be the revision number of the firmware. The hex file may be distributed as a WinZip archive with a .zip extension. In that case, unzip the .zip file to its native .hex format before attempting to upgrade the RS unit.

Please record the revision of the previous firmware before the update for reference. The firmware revision is displayed during power up sequence of the RS AC source.

Connect the 7000-263-2 RS232 cable (9 pin to 9 pin) between the power source and an available COM port of the PC.

---

<sup>1</sup> The GPIB interface cannot be used for this purpose, as the Flash boot loader is a small resident program that does not support GPIB communications.

Power up the AC source using its on/off switch. A message will appear on the LCD once the power comes on:

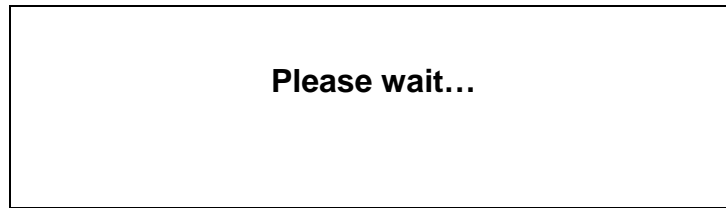

After about 30 seconds, this message changes to:

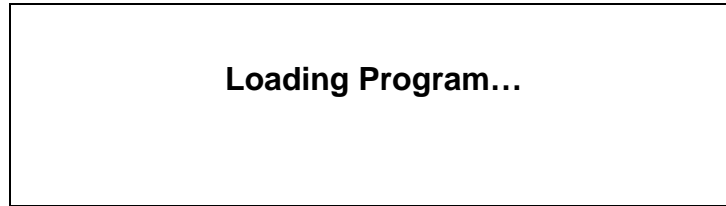

**When** this "Loading Program..." message appears on the LCD of the RS front panel, **press the ENTER key on the keypad of the RS unit once**. If you wait too long, you may have missed the window and you will have to recycle power on the AC source and try again.

This will put the source controller into the Flash down load mode. Wait until the screen shown below appears. This screen shows the RS232 setup parameters that are used in the boot loader mode.

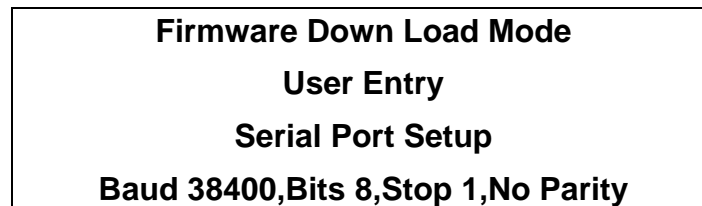

Now launch the Flash Loader utility program "FlashLoaderComm.exe".

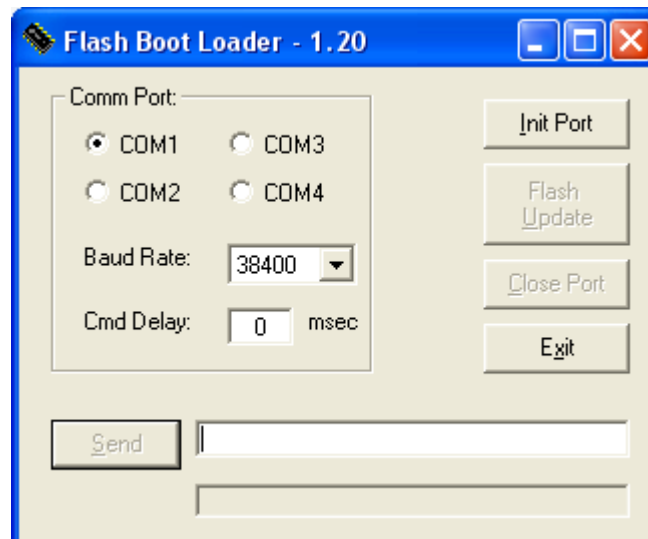

Select the COM port to be used (default is COM1). Leave "Baud rate" and "Cmd Delay" set to their default values of 38400 baud and 0 msec.

Click on the “Init Port” button. If the selected port can be initialized, the “Flash Update” button will be enabled. If not, check the selected COM port and make sure it is the one connected to the RS.

Press the “Flash Update” button. This will display the file download screen shown below.

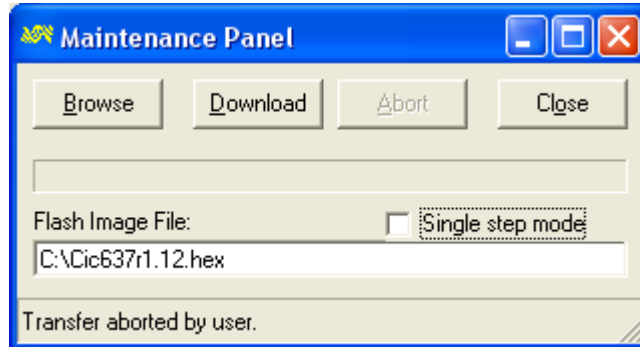

Select Browse and locate the file Cic637rn.nn.hex at the location on the PC where you stored it before.

Click on the “Download” button. This will start the firmware update procedure. The front panel display for the AC source will display the message “Erasing Flash” first, followed by “Flash erase complete” and “Programming Flash”. The download will be completed in about 5 to 10 minutes depending on the size of the .hex file.

After the download completes successfully, the power source will initialize with the new firmware. Observe the LCD display for the firmware revision displayed during initialization to confirm the new firmware is now installed.

### 7.7.3 Flash download Messages

One or more messages may appear during this process. The table below shows some of the possible message and their meaning.

Message	Description	Remedy
Flash erase complete	Erase operation successful.	
Flash erase fail	Firmware download capability not supported by CPU board..	Refer to Service Bulletin SB-0043
Flash write fail	Unable to write to flash. This message is unlikely as it generally is preceded by the Flash Erase Fail message.	Refer to Service Bulletin SB-0043
Firmware download fail	Data error. Incorrect checksum read-back from Flash block. Communication interrupted or problem with RS232 interface.	1. Check cable connection. 2. Try setting CmdDelay in Flash loader program to 100 msec and try again.

Table 7-3: Flash Download Messages

## 8. Top Assembly Replaceable Parts

Note that different generation RS units may use different sub assemblies. Check the serial tag on the back of the RS to determine the applicable top assembly number to determine the correct sub assembly or part required. For amplifiers, refer to the amplifier serial tag for the relevant amplifier top assembly part number.

Ref.	CI P/N	Description	Vendor	Qty	Location
<b>Oscillator Assembly 7003-442</b>					
A2	7003-442-1	Front Panel Assy. Prog. Osc.	AMETEK PP	1	
A2-A9	7000-723-4	Keyboard/Display assy.	AMETEK PP	1	
A2-A5	7003-715-3	PC Assy. Indicator	AMETEK PP	1	
A2-A7	7003-718-7	CPU board assy. All 3 phase	AMETEK PP	1	
A2-A11	7003-719-1	PC Assy. Aux Generator	AMETEK PP	1	
<b>Top Assembly 5440001</b>					
A1	7003-721-6	PC Assy, RS232/GPIB/USB	AMETEK PP	1	
A14	7003-722-1	PC Assy, Low Volt PSU	AMETEK PP	1	
A15	7003-722-1	PC Assy, Low Volt PSU	AMETEK PP	1	
A16	7003-723-1	Ripple Filter	AMETEK PP	1	
A3	7003-731-1	PC Assy., System Interface	AMETEK PP	1	
A4	7003-701-1	PC Assy., V / I Sense	AMETEK PP	1	
A14	7003-713-1	PC Assy., PWR Interconnect	AMETEK PP	1	
A15	7003-713-1	PC Assy., PWR Interconnect	AMETEK PP	1	
A13	7003-714-1	PC Assy., EMI Filter	AMETEK PP	1	
A7	7003-433-5	Amplifier Assy., 15kVA	AMETEK PP	1	
A8	7003-433-5	Amplifier Assy., 15kVA	AMETEK PP	1	
A9	7003-433-5	Amplifier Assy., 15kVA	AMETEK PP	1	
A10	7003-433-5	Amplifier Assy., 15kVA	AMETEK PP	1	
A11	7003-433-5	Amplifier Assy., 15kVA	AMETEK PP	1	
A12	7003-433-5	Amplifier Assy., 15kVA	AMETEK PP	1	
B1, B2	241186	Fan, 3", 24VDC	NMB Technology 3110KLO5WB50-P00	2	
B3, B4	853-230-77	Fan, 6-3/4", 230VAC	Orion OA172SAP-22-1TB	2	
CB1	270224	Circuit Breaker, 2.5A, 300V	AIRPAX IELH111-1-61-2-50-D-01-V	1	
K1A K1B	245235	Relay, 3C, 30A, 24VDC	Deltrol Controls 21014 - 82	2	
K8	245235	Relay, 3C, 30A, 24VDC	Deltrol Controls 21014 - 82	1	
K2A K2B K6, K7, K9	245248	Relay, 3C, 100A, 24VDC	ABB AE75-30-00-81	5	
K3, K5	852-145-00	Contactora, 3 Pole, 230A	ABB AF145-30-00-72	2	
R1-R6	811-12R-17	Res, 12 ohm, 175W, Ribwound	Milwaukee Resistor 061807212.000EBRKT	6	

Table 8-1&amp; 8-2: Replaceable Parts &amp; Fuses

Ref.	CI P/N	Description	Vendor	Qty	Location
<b>Amplifier Assy. 15Kva 7003-433-5</b>					
A1	7003-730-1	PC Assy., Modulator (-5) –SNK	AMETEK PP	1	A7 thru A12
A2	7003-716-1	PC Assy, PFC	AMETEK PP	1	A7 thru A12
A5	7003-726-1	PC Assy., Output Filter	AMETEK PP	1	A7 thru A12
A6	7003-726-2	PC Assy., Output Filter	AMETEK PP	1	A7 thru A12
A8	7003-708-1	PC Assy, Fan Control	AMETEK PP	1	A7 thru A12
A14	7003-729-1	PC Assy, Pwr Interconnect	AMETEK PP	1	A7 thru A12
Q1	330450	Transistor, FET	INFINEON, IPW60R045CPXK	4	A7 thru A12
Q2	330450	Transistor, FET	INFINEON, IPW60R045CPXK	4	A7 thru A12
Q3	330450	Transistor, FET	INFINEON, IPW60R045CPXK	4	A7 thru A12
Q4	330450	Transistor, FET	INFINEON, IPW60R045CPXK	4	A7 thru A12
CR13	845-360-60	Rec, Pwr, 600V, 30A	Fairchild, RHRG3060	1	A7 thru A12
CR14	845-360-60	Rec, Pwr, 600V, 30A	Fairchild, RHRG3060	1	A7 thru A12
CR15	845-360-60	Rec, Pwr, 600V, 30A	Fairchild, RHRG3060	1	A7 thru A12
CR16	845-360-60	Rec, Pwr, 600V, 30A	Fairchild, RHRG3060	1	A7 thru A12
Q1	330437	Transistor, IGBT	FUJI, 2MBI150NC-060	1	A7-PFC
Q2	330437	Transistor, IGBT	FUJI, 2MBI150NC-060	1	A8-PFC
Q3	330437	Transistor, IGBT	FUJI, 2MBI150NC-060	1	A9-PFC

Seq #	CI P/N	Description	Vendor	Qty	Assy. Number and Location
<b>Top Assembly 5440001</b>					
F1-F2	270246	FUSE, 200A, 600V	Ferraz Shawmut A6T200 Littelfuse JLLS 200	2	For 208V / 230V Input
F3-F4	270246	FUSE, 200A, 600V	Ferraz Shawmut A6T200 Littelfuse JLLS 200	2	
F5-F6	270246	FUSE, 200A, 600V	Ferraz Shawmut A6T200 Littelfuse JLLS 200	2	
F1-F2	270226	FUSE, 110A, 600V	Ferraz Shawmut A6T110 Littelfuse JLLS 110	2	For 400V / 480V Input
F3-F4	270226	FUSE, 110A, 600V	Ferraz Shawmut A6T110 Littelfuse JLLS 110	2	
F5-F6	270226	FUSE, 110A, 600V	Ferraz Shawmut A6T110 Littelfuse JLLS 110	2	
F7	270134	FUSE, 2A, 250V	Littelfuse, 313002	1	
<b>Amplifier Assy. 15kVA 7003-433-5</b>					
F1	270249	FUSE, 100A, 500V	Ferraz Shawmut A50QS100-4	3	A7 thru A12
F1-F8	270168	FUSE, 30A, 600V	Bussmann KTK-30 Littelfuse KLK-30	24	A7 thru A12 7003-713-1
<b>Low Voltage Power Supply 7003-722-1</b>					
F1	270192	FUSE, Poly switch	Raychem RUE250	1	A6
F2	270192	FUSE, Poly switch	Raychem RUE250	1	A6
F3	270189	FUSE, Poly switch	Raychem RXEF110	1	A6
<b>Fan Control 7003-708-1</b>					
F1	270183	FUSE, 3A, 250V	Bussmann PCC3	1	A7-A8
F1	270183	FUSE, 3A, 250V	Bussmann PCC3	1	A8-A8
F1	270183	FUSE, 3A, 250V	Bussmann PCC3	1	A9-A8
F2	270192	FUSE, Poly switch	Raychem RUE250	1	A7-A8
F2	270192	FUSE, Poly switch	Raychem RUE250	1	A8-A8
F2	270192	FUSE, Poly switch	Raychem RUE250	1	A9-A8

## **9. Options**

---

### **9.1 Introduction**

---

There are a number of options available for the RS Series, both hardware and software. While not all or no options may be present on your specific unit, this section of the manual incorporates the user documentation for all available options. There is no separate manual for these options except possible manual addenda for special engineering request (SER) systems. If your system has an SER number as part of the model number, refer to any manual addendum that was shipped with the unit.

## 9.2 Option -HV: Additional AC Voltage Range

---

The -HV option provides an additional AC only output voltage range of 0-400 VRMS. There is no equivalent 200 VRMS range associated with the -HV option but the standard 0-150 V RMS and 0-300 V RMS remain available even if the -HV option is installed.

If the -HV option is installed, there will be three voltage ranges that can be selected from the PROGAM 1 menu. (150/300/400). Other than the range values, all other operations remain the same. Note however that the -HV range is AC coupled and as such offers no DC output capability. Thus, whenever the 400 V range is selected, the output mode is automatically set to AC MODE and other modes cannot be selected.

Since the -HV option range is AC coupled, the lower frequency limit on the -HV range is 45 Hz and not the 16 Hz that applies to the standard 150/300V ranges. The upper frequency limit remains the same.

### **Arbitrary waveforms**

As stated before, the -HV (and -XV) range is AC (transformer) coupled and as such cannot pass any DC component from the waveform generator. This means that any arbitrary waveform created by the user that is to be used in the -HV range cannot have any DC offset. The RS firmware will generate an error message if an attempt is made to select a custom waveform with DC offset while in the -HV range.



## 9.3 Option –160: RTCA/DO-160 Tests

---

The RTCA/DO-160 Option is made up of both firmware that resides in the power source and the RSGui Windows application program. The firmware covers revision D and can be used from the front panel or under RSGui control. Revision E is implemented through the RSGui only.

The user interface for each implementation is different. The revision D tests can be operated directly from the power source's front panel or through the supplied RSGui program. The Revision E tests can only be operated through the RSGui windows software. Thus, for Rev E use, a Windows PC and interface – RS232 ,USB, LAN or GPIB (recommend) - is required.

Section 9.3.1 covers operation of the firmware based revision D tests.

For information regarding the operation of the DO160 revision E tests with the RSGui, please refer to the Avionics Software Manual (CI part no. 4994-971 included on CDROM). Note that future updates of the RSGui may include overlapping coverage for revision D in the software as the RSGui program is designed to support all revisions. For now, revision D has no associated data files in the RSGui but does have it's own user interface control screen.

### 9.3.1 Option –160: RTCA/DO160 rev D Tests (Firmware)

---

#### 9.3.1.1 General

---

The RTCA/DO-160 option is capable of performing all sections of RTCA/DO-160D, Section 16 and EUROCAE-14D / RTCA DO160D, Section 16 for the AC Source signal. A selection is made available to specify the type of standard, and groups.

Through out this document, Groups 1 through 3 will be used to refer to EUROCAE-14D standard.

#### 9.3.1.2 Initial Setup

---

Nominal parameters for the AC Power source are as follows:

Output Voltage	115V L-N or 230V L-N
Output Frequency	360 Hz to 800 Hz

Nominal parameters for the DC Power source are as follows:

Output Voltage	28V or 14V L-N
----------------	----------------

A setting outside these nominal values will disable the test and will prevent accessing to its Menu screens. To access the test for the 230V L-N, the power source must be capable of programming 360V.

#### 9.3.1.3 Tests Performed

---

Available tests are divided into Normal, Abnormal and Emergency.

##### 9.3.1.3.1 NORMAL STATE

###### AC Source:

1. Normal State Voltage and Frequency test
2. Voltage unbalance test
3. Waveform Distortion test
4. Voltage Modulation test
5. Frequency Modulation test
6. Momentary Power Interrupt (Undervoltage) test

7. Voltage Surge (Overvoltage) test
8. Frequency Transients test(Group 1 only)  
Frequency Variation test (Group 2 and 3 only)

**DC Source:**

1. Normal State Voltage test
2. Momentary Power Interrupt (Undervoltage) test
3. Voltage Surge and Under

**9.3.1.3.2 EMERGENCY TEST****AC Source:**

1. Emergency Voltage and Frequency minimum
2. Emergency Voltage and Frequency maximum
3. Voltage unbalance

**DC Source:**

1. Emergency Voltage

**9.3.1.3.3 ABNORMAL TEST****AC Source:**

1. Abnormal Voltage minimum
2. Abnormal Voltage maximum
3. Voltage Drop
4. Voltage Surge
5. Frequency Transients test (group 1 only)

**DC Source:**

1. Abnormal Voltage minimum
2. Abnormal Voltage maximum
3. Abnormal Voltage low
4. Voltage Drop
5. Voltage Surge

**9.3.1.4 Front Panel Entry**

To perform a test from the keyboard, from the MENU 2 screen, select the APPLICATIONS screen. The APPLICATIONS screen will appear as shown in Figure 9-1.

APPLICATIONS SETUP	
MIL-STD-704	RTCA/DO-160D
QMIN OPTION	IEC 1000-4-11
PREVIOUS SCREEN	IEC 1000-4-13

Figure 9-1: Application Menu

Scroll to the RTCA/DO-160D entry using the up and down cursor keys. Press the ENTER key to select the RTCA/DO 160D main menu. The screen will appear as shown in Figure 9-2.

**Note:** The user has to turn on the Output relay before starting a test.

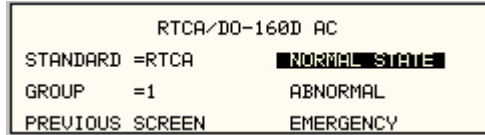

Figure 9-2: DO160 Main Menu

**9.3.1.5 AC TESTS**

Note: Prior to test selection the standard and the group selection are required. Use the shuttle to select the standard and the group if applicable.

**9.3.1.5.1 Normal state test**

Scroll to the NORMAL STATE AC entry using the up and down cursor keys. Press the ENTER key to select the NORMAL STATE screens. The screen will appear as shown in Figure 9-3.



Figure 9-3: Normal State

The DO160 NORMAL 1 and NORMAL 2 screens have the following tests:

- 1 VOLT FREQ MIN
- 2 VOLT FREQ MAX
- 3 VOLT UNBALANCE
- 4 WAVEFORM DISTORTION
- 5 VOLT MODULATION
- 6 FREQ MODULATION
- 7 POWER INTERRUPT
- 8 VOLTAGE SURGE
- 9 FREQ TRANSIENT (group 1)
- FREQ VARIATION (group 2 & 3)

The above tests can be selected by scrolling to the highlighted selection using the up and down key and the ENTER key to start the selected test. For some of these tests, numeric data entry may be required to define the test number or the modulation rate.

**VOLT FREQ MIN**

Standard/Group		RTCA	Group1	Group2	Group3
Voltage	1	100	104	104	104
	3	101.5	105.5	105.5	105.5
Frequency		380	390	360	360

Table 9-1: Normal Voltage and Frequency Minimum

Standard/Group		RTCA	Group1	Group2	Group3
----------------	--	------	--------	--------	--------

Voltage	1	122	122	122	122
	3	120.5	120.5	120.5	120.5
Frequency		420	410	650	800

Table 9-2: Normal Voltage and Frequency Maximum

This test will set the voltage and frequency to levels defined by Table 9-1. The test will last for 30 minutes. The test will be repeated for the Group 2 and 3 using the Voltage setting from Table 9-2 and the frequency from Table 9-1. The ← key (backspace) will terminate the test at any time.

### VOLT FREQ MAX

This test will set the voltage and frequency to levels defined by Table 9-2. The test will last for 30 minutes. The test will be repeated for the EURO standard using the Voltage setting from Table 9-1 and the frequency from Table 9-2. The CLR Key in local operation will terminate the test at any time. Group execute trigger will terminate the test remotely. The unselected phases will remain at 115 volts. The ← key (backspace) will terminate the test at any time.

### VOLT UNBALANCE

Standard/Group	RTCA	Group1	Group2	Group3
Voltage offset	6	6	6	9
Frequency	400	400	360/650	360/800

Table 9-3: Normal Voltage Unbalance

This test will change the output voltage for each phase from 115 volts to 115V + offset. Refer to Table 9-3 for the offset value and the Frequency. The test will last 30 minutes. The test will be repeated for a second Frequency if applicable. The test can be terminated at any time. The ← key will terminate the test at any time.

### WAVEFORM DISTORTION

This test will generate a 5% THD voltage distortion on the output voltage waveform. The distortion is generated by using a clipped sine wave. The test will last for 30 minutes. The ← key (backspace) will terminate the test at any time.

### VOLTAGE MODULATION

This test requires a numeric value entry equal to the modulation rate in Hz. This entry value must be between 1 Hz and 200 Hz. The amplitude modulation is calculated based on the modulation rate as defined in Figure 9-4. This test will last for 2 minutes.

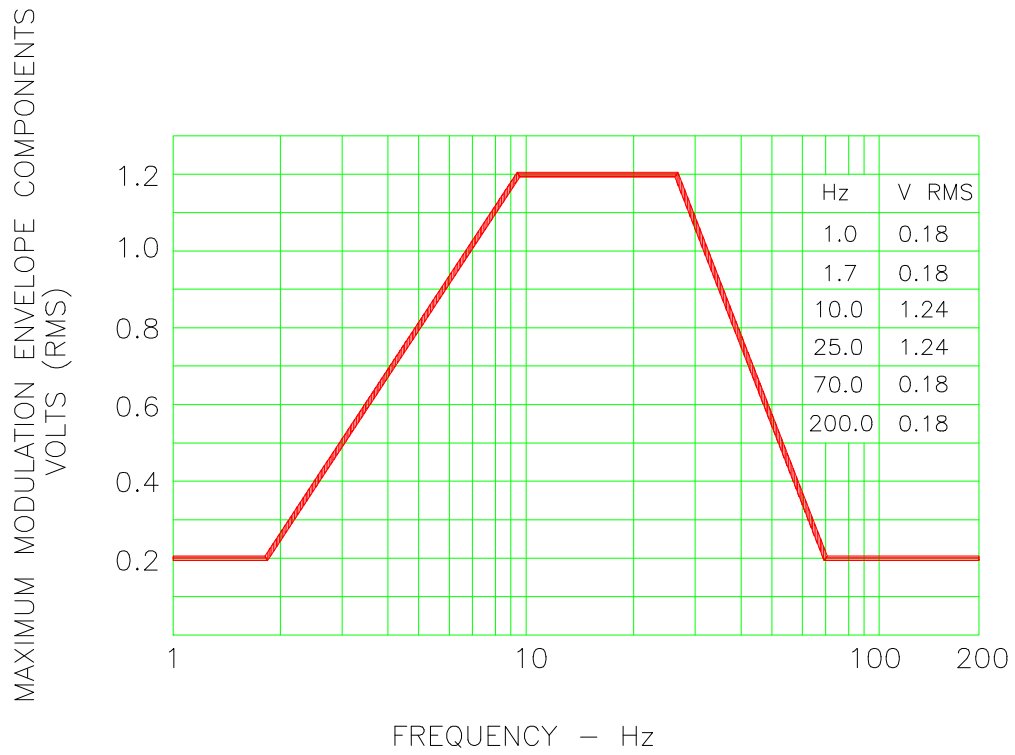

FREQUENCY CHARACTERISTICS OF AC VOLTAGE MODULATION ENVELOPE

Figure 9-4: Voltage Modulation

### FREQUENCY MODULATION

This test requires a numeric value equal to the modulation rate in Hz. This value must be between 0.01 Hz and 100 Hz. The frequency modulation is calculated based on the modulation rate as defined in Figure 9-5. This test will last for a minimum of 2 minutes.

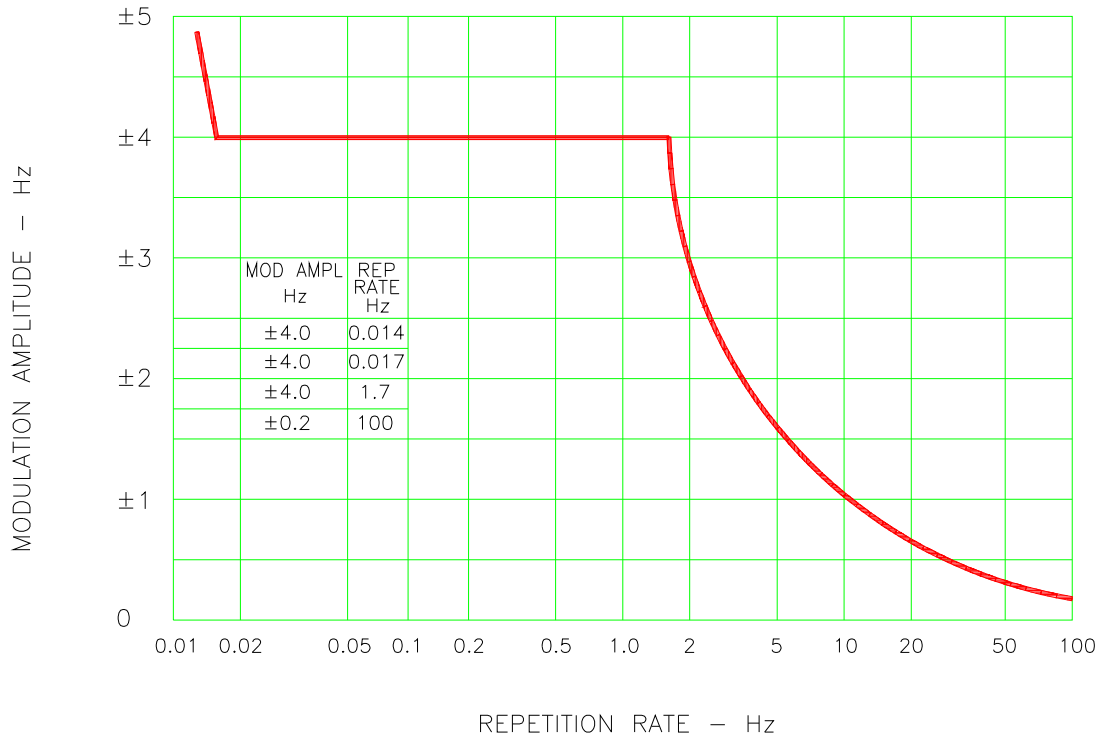

CHARTACTERISTICS OF AC FREQUENCY MODULATION

Figure 9-5: Frequency Modulation

**POWER INTERRUPT**

This test requires a numeric entry value equal to the test number. The tests are grouped as follows:

- Test numbers 1 through 15 are for all Standard and Groups. See Figure 9-6 for details of the tests.
- Test numbers 16 and 17 for all equipment that does not incorporate digital circuit. Test number 16 will drop the output to zero voltage for 50 ms. Test number 17 will drop the output to zero voltage for 200 ms. Test number 18 is used for DC equipment and will drop the output for 1 sec.
- Test numbers 21 through 26 are applicable for Groups 2 and 3 only. Output frequency will be set to the F1 value for 1 second prior to the test. The output frequency will remain set to the F2 value when the test is completed. This will allow the user to apply sequence of power interrupts. See Figure 9-7 for detail of the tests.

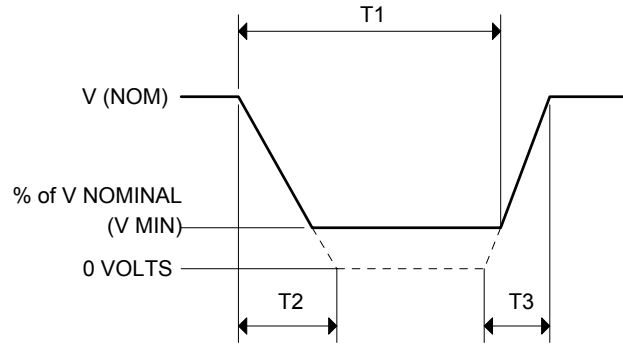

DO160 Table 16-1: Test conditions for equipment with digital circuits.

- NOTES
- 1: Definitions:  
 T1 Power interrupt time  
 T2 Time it would take for the applied voltage to decay from V (nom) to zero volts.  
 T3 Time it would take for the applied voltage to rise from zero to V (nom) volts.  
 V MIN The minimum level (expressed as a percentage of V NOMINAL) to which the applied voltage is permitted to decay.
  - 2: Tolerance to T1, T2, T3 = ± 10%
  - 3: Test condition numbers 8 and 15 are for category Z, dc powered equipment only.

Applicable Category:	A				A, Z			Z	A, B, Z			A, Z			Z
Test Condition No.	1**	2	3	4	5	6	7	8	9	10	11	12	13	14	15
T1 (ms)	2**	10	25	50	75	100	200	1000	10	25	50	75	100	200	1000
T2 (ms)	<1	20*	20	20	20	20	20	20	50*	50*	50	50	50	50	50
T3 (ms)	<1	5	5	5	5	5	5	5	20	20	20	20	20	20	20
%V Nom. (V min)	0	50	15	10	5	0	0	0	80	50	0	15	5	0	0

\* Voltage will not reach zero in this test condition.

\*\* Equipment performance standards may require to repeat test n<sup>o</sup>1 with T1 varying from 5 to 200 ms by step defined in the test equipment performance standards (step typically comprised between 5 ms and 20 ms depending on equipment design).

Figure 9-6: Power Interrupt

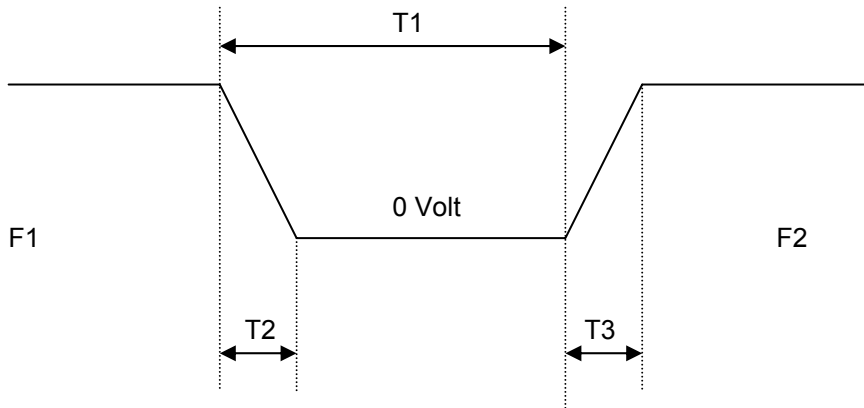

Test no.	21(I)	22(II)	23(III)	24(IV)	25(V)	26(VI)
T1 (ms)	50	50	100	100	200	200
F1 (Hz)	360	Fmax	360	Fmax	360	Fmax
F2 (Hz)	Fmax	360	Fmax	360	Fmax	360

Fmax = 650 Hz for Group 2  
 Fmax = 800 Hz for Group 3  
 T2 = 20 msec  
 T3 = 5 msec

Figure 9-7: Power Interrupt for Group 2 and 3

**VOLTAGE SURGE**

This test requires 160 volt output voltage. If the power source is set at the low voltage range, the high voltage range will be selected before the test starts. At the end of the test, the power source will be switched back to the low range automatically

Seq. No.	Voltage				Time
	RTCA	Group 1	Group 2	Group 3	ALL
1	115	115	115	115	5 Minute
2	160	160	160	170	30msec
3	115	115	115	115	5 Sec.
4	60	70	70	70	30msec
5	115	115	115	115	5 Sec.

Table 9-4: Normal VoltageSurge Sequence

The output voltage will follow the sequence in Table 9-4. The above sequence will repeat itself three times. Each repeat will start from sequence two. US and Group 1 will run at 400 Hz. Group 2 and Group 3 will run at 360 Hz and 650 Hz for Group 2 and 800 Hz for Group 3. The frequency will return to the nominal setting when the test is completed. The ← key (backspace) will terminate the test at any time.



## FREQUENCY TRANSIENTS (Group 1 only)

Seq. No	Frequency	Time
1	400	5 Minute
2	440	150msec
3	400	5Sec.
4	350	150msec
5	400	5Sec.

Table 9-5: Normal Frequency Transient Sequence

This test applies to Group 1 only. At 115 voltage, change the frequency per sequence listed in Table 9-5. The test will cycle 5 times starting from sequence 2.

## FREQUENCY VARIATION (Group 2 and 3 only)

Seq. No	Initial Frequency		Slew rate Hz/Sec	Final Frequency	
	Group2	Group3		Group2	Group3
1	360	360	100	650	800
2	650	800	100	360	360
3	360	360	Pause 5 sec	360	360

Table 9-6: Normal Frequency Variation Sequence

This test will apply to Group 2 and 3 only. At 115 voltage, the frequency is set to 360Hz for 5 minutes. The frequency is slowed per sequence listed in Table 9-6. The test will cycle 3 times. The frequency will return to nominal after the test is completed.

**9.3.1.5.2 EMERGENCY TEST**

From the DO160 MENU scroll to the EMERGENCY AC entry using the up and down cursor keys. Press the ENTER key to select the EMERGENCY screens. The screen will appear as shown in Figure 9-8.

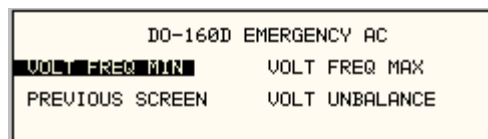

Figure 9-8: Emergency Screen

The EMERGENCY SCREEN has the following tests:

- 1 VOLT FREQ MIN
- 2 VOLT FREQ MAX
- 3 VOLT UNBALANCE

The above tests can be selected by scrolling to the highlighted selection using the up and down key and the ENTER key to start the selected test.

**VOLT FREQ MIN**

Standard/Group		RTCA	Group1	Group2	Group3
Voltage	1Φ	100	104	104	104
	3Φ	101.5	105.5	105.5	105.5
Frequency		360	360	360	360

Table 9-7: Emergency Voltage and Frequency Minimum

Standard/Group		RTCA	Group1	Group2	Group3
Voltage	1Φ	122	122	122	122
	3Φ	120.5	120.5	120.5	120.5
Frequency		440	440	650	800

Table 9-8: Emergency Voltage and Frequency Maximum

This test will set the voltage and frequency for a level defined by Table 9-7. The test will last for 30 minutes. The test will be repeated using the voltage from Table 9-8 and frequency from Table 9-7. The ← key (backspace) will terminate the test at any time.

**VOLT FREQ MAX**

This test will set the voltage and frequency for a level defined by Table 9-8. The test will last for 30 minutes. The test will be repeated using the voltage from Table 9-7 and frequency from Table 9-8. The ← key (backspace) will terminate the test at any time.

**VOLT UNBALANCE**

Standard/Group	RTCA	Group1	Group2	Group3
Voltage offset	8	8	8	12
Frequency	400	400	360/650	360/800

Table 9-9: Emergency Voltage Unbalance

This test will change the output voltage for each phase from 115 volts to 115V + offset. Refer to Table 9-9 for the offset value and the Frequency. The test will last 30 minutes. The test will be repeated for a second Frequency if applicable. The ← key (backspace) will terminate the test at any time.

**9.3.1.5.3 ABNORMAL TEST**

From the DO160 MENU Scroll to the ABNORMAL AC entry using the up and down cursor keys. Press the ENTER key to select the ABNORMAL screens. The screen will appear as shown in Figure 9-9.

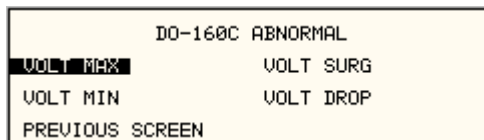

Figure 9-9: Abnormal Screen

The ABNORMAL SCREEN has the following tests:

- 1 VOLT MAX
- 2 VOLT MIN
- 3 VOLT SURG
- 4 VOLT DROP

## 5 FREQ TRANSIENTS

The above test can be selected by scrolling to the highlighted selection using the up and down key and the ENTER key to start the selected test.

### VOLT MAX

Standard/Group		RTCA	Group1		Group2	Group3
Voltage	1	97	97	104	97	97
	3	98.5	98.5	105.5	98.5	98.5
Frequency		400	400	370	360	360

Table 9-10: Abnormal Voltage Minimum

Standard/Group		RTCA	Group1		Group2	Group3
Voltage	1	134	134	122	134	134
	3	120.5	132.5	120.5	132.5	132.5
Frequency		400	400	430	650	800

Table 9-11: Abnormal Voltage Maximum

This test will set the voltage and frequency to levels defined by Figure 9-10 for 5 minutes. The test will be repeated for Group1 only as indicated in Table 9-10 for voltage and Table 9-11 for frequency. All Groups will repeat the test using Table 9-10 for the voltage setting and Table 9-10 or Table 9-11 for the frequency setting. The ← key (backspace) will terminate the test at any time.

### VOLT MIN

This test will set the voltage and frequency to levels defined by Table 9-11 for 5 minutes. The test will be repeated for Group1 only as indicated in Table 9-11. All Groups will repeat the test using Table 9-11 for the voltage setting and Table 9-10 for the frequency setting. The ← key (backspace) will terminate the test at any time.

### VOLT UNDER

This test will drop the output voltage from 115 volts to 60 volts for 7 seconds.

### VOLT SURGE

This test requires 180 volt output voltage. If the power source is set at the low voltage range, the high voltage range will be selected before the test starts. At the end of the test the AC source will be switched back to the low range.

The output voltage will surge to 180 volts for 100 ms. followed by drop to 148 volts for 1 sec before it returns to 115 volts. The ← key (backspace) will terminate the test at any time.

### FREQUENCY TRANSIENTS (Group 1 only)

Seq. No.	Frequency	Time
1	400	5 minutes
2	480	5 sec.
3	400	10 sec.
4	320	5 sec.
5	400	10 sec.

Table 9-12: Abnormal Frequency Transient

This test will set the voltage at 115V and will remain at this voltage through out the test. The test will cycle the frequency three times as shown in Table 9-12. Each repeat will start from sequence 2.

**9.3.1.6 DC TESTS**

If the output voltage is set for 24V DC or 14V DC the DO-160 DC Main selection screen will appear as seen in Figure 9-10.

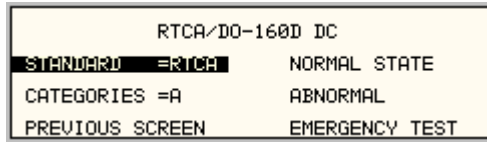

Figure 9-10: DO-160 DC Main Menu

Note: Prior to test selection the Standard selection and Category selection are required. Use the shuttle to select Standard RTCA or EUROCAE. Also, select equipment category A, B or Z.

**9.3.1.6.1 Normal State Test**

Scroll to the NORMAL STATE entry using the up and down cursor keys. Press the ENTER key to select the NORMAL STATE screen. The screen will appear as shown in Figure 9-11.

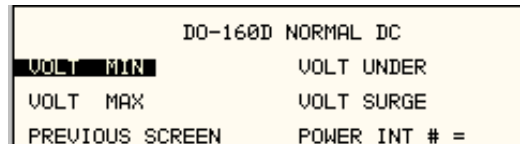

Figure 9-11: Normal State

The DO-160 NORMAL screen has the following tests:

1. VOLT MIN
2. VOLT MAX
3. VOLT UNDER
4. VOLT SURGE
5. POWER INTERRUPT

The above tests can be selected by scrolling to the highlighted selection using the up and down key and the ENTER key to start the selected test. For some of these tests, numeric data entry may be required to define the test number or the modulation rate.

**VOLT MIN**

Standard	Categories		
	A and Z	B 28V / 14V	
RTCA	22.0	22.0	11.0
EUROCAE	22.0	25.1	12.5

Table 9-13: Normal Voltage Minimum

This test will change the output voltage from 28V or 14V to 22V or 11V. The test will last for 30 minutes. The ← (backspace) will terminate the test at any time.

**VOLT MAX**

Standard	Categories		
	A and Z	B 28V / 14V	
RTCA	30.3	30.3	15.1
EUROCAE	30.3	29.3	14.6

Table 9-14: Normal Voltage Maximum

This test will change the output voltage from 28V or 14V to 30.3V or 15.1V. The test will last for 30 minutes. The ← (backspace) will terminate the test at any time.

**VOLT UNDER**

This test applies to category Z and 28 volt category B equipment. The output voltage will drop to 10 volts and will ramp up at a rate of 0.15 volt/sec for the US standard and at a rate of 0.30 volt/sec for EUROCAE standard for 30 seconds before it returns to nominal value.

**VOLT SURGE**

This test will surge and sag the voltage to a level and duration specified Table 9-15 with 5 seconds between transients. The test is repeated three times.

Category	Surge			Sags		
	Volt		Dwell(msec)	Volt		Dwell(msec)
	RTCA	EUR		US	EUR	
A	40	40	30	15	17	30
B	40	40	30	15	17	30
Z	50	50	50	12	12	30

Table 9-15: Voltage Surge

**POWER INTERRUPT**

Refer to section POWER INTERRUPT.

**9.3.1.6.2 Abnormal Test**

From the DO-160 MENU scroll to the ABNORMAL DC entry using the up and down cursor keys. Press the ENTER key to select the ABNORMAL screen. The screen will appear as shown Figure 9-12.

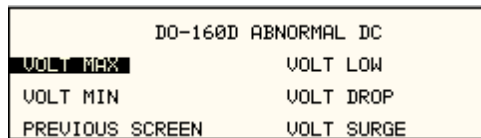

Figure 9-12: Abnormal State

The Abnormal Test has the following tests:

1. VOLT MIN
2. VOLT MAX
3. VOLT LOW
4. VOLT DROP
5. VOLT SURGE

The above tests can be selected by scrolling to the highlighted selection using the up and down key and the ENTER key to start the selected test.

**VOLT MIN**

This test will change the output voltage from 28V or 14V to 20.5V or 10V. The test will last for 30 minutes. The ← key (backspace) will terminate the test at any time.

**VOLT MAX**

This test will change the output voltage from 28V or 14V to 32.2V or 16V. The test will last for 30 minutes. The ← key (backspace) will terminate the test at any time.

**VOLT LOW**

This test applies for category B equipment.

This test will change the output voltage to the voltage minimum for one minute. The voltage will decay linearly to zero voltage in a ten minute period before returning to its nominal voltage.

#### **VOLT DROP**

This test will change the output to 12V from 28V or to 6V from 14V for seven seconds. The output voltage will return to nominal voltage after seven seconds.

#### **VOLT SURGE**

This test will produce voltage surge defined by Table 9-16. This test will be repeated three times with ten seconds intervals. The voltage values are halved for 14.0V category B equipment.

Category	Surge 1		Surge 2	
	Volt	Dwell(msec)	Volt	Dwell(msec)
A	46.3	100	37.8	1000
B	60	100	40	1000
Z	80	100	48	1000

*Table 9-16: Abnormal Voltage Surge*

#### **9.3.1.6.3 Emergency Test**

The Emergency test is selected from the DO-160 DC Main Menu. This test will set the output voltage to 18V for 28V equipment and to 9V for 14V equipment. The test will last for 30 minutes. The ← key (backspace) will terminate the test at any time.

## 9.4 Option –411: IEC 61000-4-11 Voltage Dips and Interruptions

---

### 9.4.1 General

---

The IEC 61000-4-11 option is capable of performing IEC 61000-4 section 11 voltage dips, short interruptions and voltage variations immunity tests. On three phase RS Series AC sources, the user can select one, two or all three phases to be active during the IEC 61000-4-11 tests in this configuration.

### 9.4.2 Standard Revisions and EUT Classes

---

The –411 option supports both the first (1994-06) and the second edition (2004-03) of the IEC 61000-4-11 test standard as of firmware revision 0.31. Older firmware revisions only support the first edition. Contact [service.ppd@ametek.com](mailto:service.ppd@ametek.com) for upgrade information. If Edition 2.0 is supported, the standard revision can be selected when using the RSGui Windows program. From the front panel, there is no need to select the revision but data values can be set that support either version of the standard.

Generic tests files are distributed with the RSGui program for both editions of the test standard. Files applicable to Edition 2.0 have ED20 in their file name. Do not mix these files, as the data setup will not be correct if you do. To load a test file, select the Mode (Dips or Vars) and test standard revision first, then use the File, Open menu to load the test parameters. Test parameters can be a function of the EUT class. The different files provided with the program cover the various EUT classes. The relevant EUT class 1, 2, 3 or X is listed in the file names.

When using front panel operation, the user has to set levels for each individual test step in SINGLE mode.

### 9.4.3 Initial Setup

---

The user must set the operating frequency and voltage and close the output relay prior to the start of test. It is possible to change the normal voltage ( $U_t$ ) from the IEC1000-4-11 menus before running each test.

### 9.4.4 Phase Selection

---

On three phase power source models, phase selection for individually executed dips or the preset RUN ALL selection can be made using the PHASE key on the front panel. The phase or phases selected will be displayed in the upper right hand corner of the LCD as either A, B, C, AB, AC, BC or ABD.

With the introduction of Edition 2.0, three phase voltage dips testing has been redefined for both Wye and Delta loads.

For Star (Wye) connected three-phase EUT's, voltage dips should be performed on both individual Line-to-Neutral voltages as well as on all three Line-to-Line voltages. Thus, each test should be run 6 times, each time selecting a different phase option: A, B, C, A+B, A+C and B+C.

For Delta connected three-phase EUT's, voltage dips, only Line-to-Line voltages dips have to be run. Thus, each test can be run 3 times, each time selecting a different phase A+B, A+C and B+C.

Note that the –411 option in RS Series AC sources with Firmware revision lower than 1.13 will not support 2 phase out of 3 selections. RS Series I systems with firmware revision 1.17 or higher and RS Series II systems with firmware revision 4.17 or higher support three phase dips testing using the preferred method referenced in figure 4b) (A) of IEC 61000-4-11, Edition 2.0. RS units with revisions prior to this will change the L-N amplitude by the set dip level but retain

the normally programmed phase angle relationship. For firmware upgrades, contact [service.ppd@ametek.com](mailto:service.ppd@ametek.com).

Note that required phase angles and amplitudes are automatically set for dips of 0, 40, 70, 80 and 100% to conform with method (A). For all other dip levels, method (A) can be used by programming the required phase angles to be used during the programmed dips. The amplitude and phase angles required to obtain the correct line-to-line voltage dip per method (A) for standard dip levels of 40, 70 and 80% are embedded in the firmware and conform to table C.2 of IEC 61000-4-34.

Since all phase programming on the RS series is referenced to phase A, voltage dip with a phase angle for A other than 0° are implemented by offsetting all three phases by the required number of degrees to get phase A at 0°. This is reflected in the actual output settings shown on the RS versus the data in table C.2 of the IEC61000-4-34. The actual output settings are shown in the last 3 columns.

**Phase Mapping**

The phase rotation on the RS series is ACB. This means phase A is mapped to L1, phase B is mapped to L3 and phase C is mapped to L2. The required phase selection letter combination for the required Line-to-line dip is shown in table C.2 for reference.

IEC Tables	RS Reference
L1	A
L2	C
L3	B

Table 9-17: Phase mapping

To select the desired phase-to-phase dip, select the phase selection as shown in column 8 and either 80, 70 or 40 % dip level from the IEC411 screen or the Gui. Table C.2

	Line to Line			Line to Neutral			Phase	RS Setting		
	L1-L2	L2-L3	L3-L1	L1-N	L2-N	L3-N	Selection	A-N	C-N	B-N
<b>100% dip</b>	100 %	100 %	100 %	100 %	100 %	100 %	n/a	100 %	100 %	100 %
<b>(no dip)</b>	150°	270°	30°	0°	120°	240°		0°	120°	240°
<b>80% dip</b>	80%	100%	92%	72%	100%	100%	AC	72%	100%	100%
<b>L1-L2</b>	150°	270°	41°	14°	120°	240°		0°	106°	226°
<b>80% dip</b>	92%	80%	100%	100%	72%	230	BC	100%	72%	100%
<b>L2-L3</b>	161°	270°	30°	0°	134°	240°		0°	134°	240°
<b>80% dip</b>	100%	92%	80%	100%	100%	72%	AB	100%	100%	72%
<b>L1-L3</b>	150°	281°	30°	0°	120°	254°		0°	120°	254°
<b>70% dip</b>	70%	100%	89%	61%	100%	100%	AC	61%	100%	100%
<b>L1-L2</b>	150°	270°	47°	25°	120°	240°		0°	95°	215°
<b>70% dip</b>	89%	70%	100%	100%	61%	100%	BC	100%	61%	100%
<b>L2-L3</b>	167°	270°	30°	0°	145°	240°		0°	145°	240°
<b>70% dip</b>	100%	89%	70%	100%	100%	61%	AB	100%	100%	61%
<b>L1-L3</b>	150°	287°	30°	0°	120°	265°		0°	120°	265°
<b>40% dip</b>	40%	100%	87%	53%	100%	100%	AC	53%	100%	100%
<b>L1-L2</b>	150°	270°	67°	79°	120°	240°		0°	41°	161°
<b>40% dip</b>	87%	40%	100%	100%	53%	100%	BC	100%	53%	100%
<b>L2-L3</b>	187°	270°	30°	0°	199°	240°		0°	199°	240°
<b>40% dip</b>	100%	87%	40%	100%	100%	53%	AB	100%	100%	53%
<b>L1-L3</b>	150°	307°	30°	0°	120°	319°		0°	120°	319°

Table 9-18: IEC 61000-3-34 Table C.2



### Other Dip levels for 2 phase selections.

Note that any other dip level not listed in this table will result in voltage dips conform method (B) so both phases will dip by the actual dip percentage set.

To implement user defined three phase dips other than those listed in this table, the IEC411 phase setting for phases A, B and C may be used to set the desired phase angle for each dips. This setting is ignored if the dip levels is set to 80, 70 or 40 but otherwise controls the phase angle of the selected phase during the dip.

To set the phase angle for a voltage dip, select the individual phase using the PHASE key and use the PHASE = field in the 411 screen to set the required phase angle. Note that this is not the start phase angle for the dip but rather the phase offset with respect to phase A. (Requires FW 1.17 on Series I RS units or 4.17 on Series II RS units.

## 9.4.5 Tests Performed

### 9.4.5.1 DIPS AND INTERRUPTIONS

1. Run All  
Run predefined sequence of tests.
2. Run Single  
Run user defined test.

### 9.4.5.2 VOLTAGE VARIATIONS

1. Run All  
Run predefined sequence of tests.
2. Run Single  
Run user defined test.

## 9.4.6 Front Panel Entry

To perform a test from the keyboard, select the APPLICATIONS screen from the MENU 2 screen. The APPLICATIONS screen will appear as shown in Figure 9-13

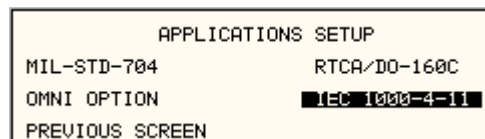

Figure 9-13: Application Menu

Scroll to the IEC 1000-4-11 entry using the up and down cursor keys. Press the ENTER key to select the IEC 1000-4-11 main menu. The screen will appear as shown in Figure 9-14.

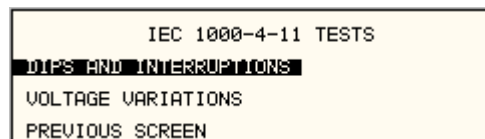

Figure 9-14: IEC1000-4-11 Menu

### 9.4.6.1 DIPS AND INTERRUPTIONS TEST

Scroll to the DIPS AND INTERRUPTIONS entry using the up and down cursor keys. Press the ENTER key to select the DIPS AND INTERRUPTIONS menu. The screen will appear as shown in Figure 9-15.

```

IEC 1000-4-11 DIPS/INTERRUPTIONS  oA
STATE = ON
RUN ALL          NOMINAL Ut =230.0V
RUN SINGLE      DIP TO   =0.0%
EOS ST. =ACTIVE NO CYCLES =0.5
PREVIOUS SCREEN START ANGLE =0.0

```

Figure 9-15: IEC Dips and Interrupts

**STATE**

This field enables or disables the -411 test mode.

**EOS STATE**

This field is not available on RS Series systems.

**RUN ALL**

The RUN ALL selection will cause the following automated test sequence suggested by the standard to be run:

Step	Output in % of $U_T$	No of Cycles	Start angle (Degrees)	Repeat # times	Delay between repeats (s)
1	0	0.5	0	3	10
2	0	0.5	180	3	10
3	0	1	0,45,90	3 at diff $\emptyset$	10
4	0	5	45,90,135	3 at diff $\emptyset$	10
5	0	10	90,135,180	3 at diff $\emptyset$	10
6	0	25	180,225,270	3 at diff $\emptyset$	10
7	0	50	270,315,0	3 at diff $\emptyset$	10
8	40	0.5	0	3	10
9	40	0.5	180	3	10
10	40	1	0,45,90	3 at diff $\emptyset$	10
11	40	5	45,90,135	3 at diff $\emptyset$	10
12	40	10	90,135,180	3 at diff $\emptyset$	10
13	40	25	180,225,270	3 at diff $\emptyset$	10
14	40	50	270,315,0	3 at diff $\emptyset$	10
15	70	0.5	0	3	10
16	70	0.5	180	3	10
17	70	1	0,45,90	3 at diff $\emptyset$	10
18	70	5	45,90,135	3 at diff $\emptyset$	10
19	70	10	90,135,180	3 at diff $\emptyset$	10
20	70	25	180,225,270	3 at diff $\emptyset$	10
21	70	50	270,315,0	3 at diff $\emptyset$	10

Table 9-19: Dips and Interruptions Tests Performed During RUN ALL

The user can change the NOMINAL  $U_t$  voltage for this. The RUN ALL Command line will change to ABORT during the test. Selecting ABORT and pressing the ENTER key will terminate the test at any time and the output voltage will return to the nominal value.

**PHASE SELECTION**

Voltage Dips and Interruptions can be run on an individual phase, two phases or all three phases. The PHASE key on the front panel can be used to select the desired phase mode. The active phase mode is indicated in the upper right hand corner of the LCD display.

On RS Series with firmware revision 1.13 or higher, it is also possible to select two out of three phases. This allows line-to-line voltage drops as called out in Edition 2.0 of the IEC 61000-4-11 to be performed as well.

**RUN SINGLE**

RUN SINGLE command will run a single test once. The Dip or Interrupt test is defined by the DIP TO, NO CYCLES, and START ANGLE parameters. These parameters must be set before starting the test. The following is a description of these parameters.

DIP TO:                    The dip voltage level as a percentage of the nominal voltage.

NO CYCLES:              The dip duration in cycles.

START ANGLE:          The start phase angle of the dip

Note: After each individual run, a 10 second delay is inserted.

### 9.4.6.2 VOLTAGE VARIATION TESTS

From the IEC1000-4-11 Main Menu screen shown in Figure 9-14, scroll to the VOLTAGE VARIATIONS entry using the up and down cursor keys. Press the ENTER key to select the VOLTAGE VARIATIONS menu. The screen will appear as shown in Figure 9-16.

IEC 1000-4-11 VOLTAGE VARIATIONS	
RUN ALL	NOMINAL $U_T$ =230.0V
RUN SINGLE	REDUCE TO =40.0%
	FALL TIME =2.0S
	HOLD TIME =1.0S
PREVIOUS SCREEN	RISE TIME =2.0S

Figure 9-16: Voltage Variation Screen

#### RUN ALL

The RUN ALL selection will cause the following automated test sequence suggested by the standard to be run:

Step	Type	Start V in % of $U_T$	Dwell time	End V in % of $U_T$	Delay between steps (s)
1	VSweep	100	2	40	0
2	Hold	40	1	40	0
3	VSweep	40	2	100	10
4	VSweep	100	2	40	0
5	Hold	40	1	40	0
6	VSweep	40	2	100	10
7	VSweep	100	2	40	0
8	Hold	40	1	40	0
9	VSweep	40	2	100	10
10	VSweep	100	2	0	0
11	Hold	0	1	0	0
12	VSweep	0	2	100	10
13	VSweep	100	2	0	0
14	Hold	0	1	0	0
15	VSweep	0	2	100	10
16	VSweep	100	2	0	0
17	Hold	0	1	0	0
18	VSweep	0	2	100	10

Table 9-20: Voltage Variations Test Performed During RUN ALL

The user can change the NOMINAL  $U_T$  voltage for this test. The RUN ALL Command line will change to ABORT during the test. Selecting ABORT and pressing the ENTER key will terminate the test at any time and the output voltage will return to the nominal value.

**RUN SINGLE**

RUN SINGLE command will run the test once. The Variation test is defined by the REDUCE TO, FALL TIME, HOLD TIME and RISE TIME parameters. These parameters must be set before starting the test. The following is a description of these parameters.

- REDUCE TO: The lowest voltage level as a percentage of the nominal voltage.
- FALL TIME: The time in seconds it will take the output to reach the REDUCE TO voltage.
- HOLD TIME: The time in seconds the output will hold at the REDUCE TO voltage.
- RISE TIME: The time in seconds the output will reach the NOMINAL voltage from the REDUCE TO voltage

The timing of voltage variations is different between editions 1.0 and 2.0 of the IEC 61000-4-11 test standard. While the original standard used voltage ramps on both sides of the variation test level, the Edition 2.0 standard calls out an abrupt drop to the test level, followed by a voltage ramp back to the nominal voltage. Thus, for Edition 2.0, the fall time must be set to 0.000 seconds. This requires firmware revision 0.31 or higher. Older firmware revision will not accept 0.000 sec for fall time. The shortest allowable fall time for older revision firmware is 0.02 sec.

Furthermore, where under Edition 1.0 rise and fall times were specified in seconds, they are specified in number of cycles in Edition 2.0. This is an effort to normalize both 50 Hz and 60 Hz voltage variations.

Refer to Figure 9-17 and Figure 9-18 for an illustration of how these parameters affect the V RMS output under the different standard revisions.

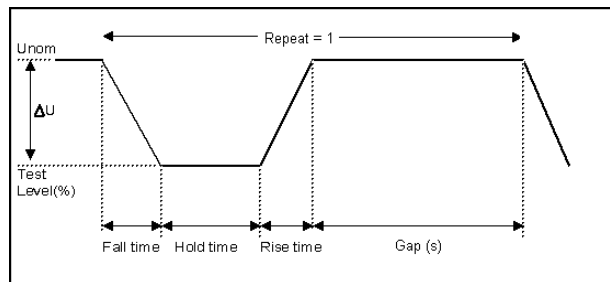

Figure 9-17: EN 61000-4-11 Voltage Variation specification- Edition 1.0

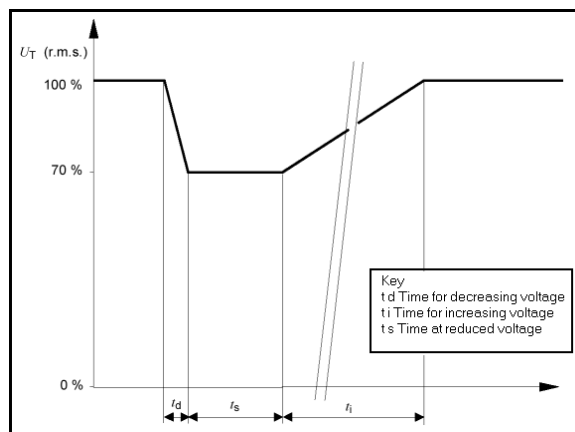

Figure 9-18: EN 61000-4-11 Voltage Variation specification- Edition 2.0

### 9.4.7 Using the RSGui Windows Program for IEC 61000-4-11 Testing

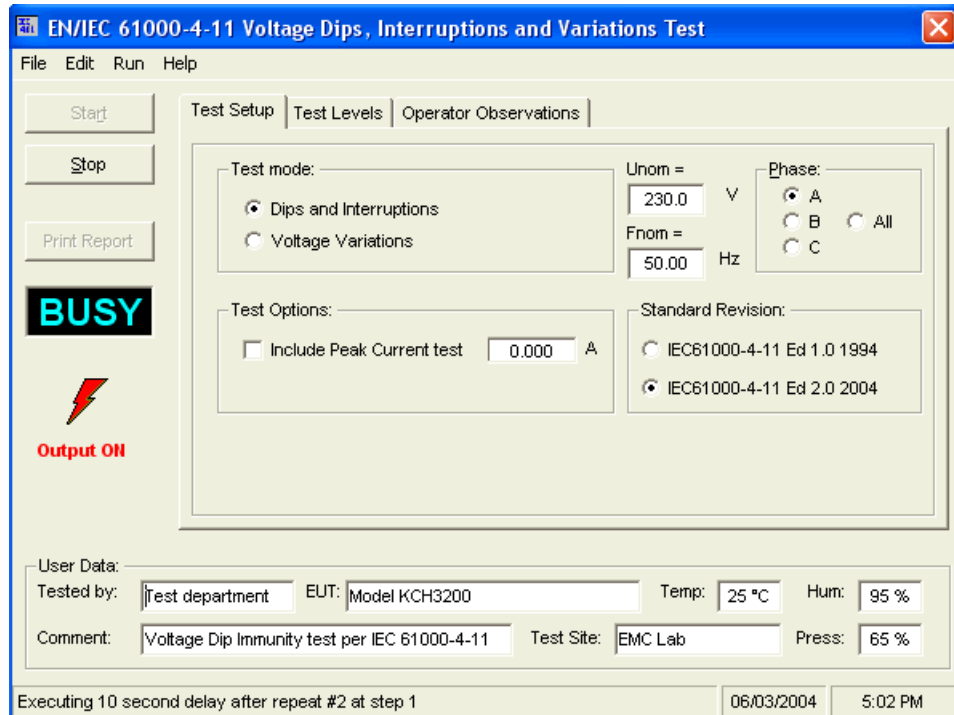

Figure 9-19: IEC 61000-4-11 GUI screen.

The RSGui Windows control program will detect the presence of the –411 option on the RS AC power source. Test reports can be generated at the end of a test for documentation purposes.

To support Edition 2.0 of the IEC 61000-4-11 test standard, version 1.20 or higher of the RSGui is required. Older versions of the RSGui will only support Edition 1.0 tests. The desired Edition can be selected by the user and provides the relevant data entry mode for the Edition selected.

Generic tests files are distributed with the RSGui program for both editions of the test standard. Files applicable to Edition 2.0 have ED20 in their file name. Do not mix these files, as the data setup will not be correct if you do. To load a test file, select the Mode (Dips or Vars) and test standard revision first, then use the File, Open menu to load the test parameters. Test parameters can be a function of the EUT class. The different files provided with the program cover the various EUT classes. The relevant EUT class 1, 2, 3 or X is listed in the file names.

The user must select the desired test type before executing the test. Since both test types require a number of test parameters, the test sequence parameters must be entered in the data entry grid or loaded from disk using the File, Open menu entry.

For complete details on how to use the RSGui –411 option test screen, refer to the on-line help of the RSGui program available from the Help menu.

---

## 9.5 Option –413: IEC 61000-4-13 Interharmonics Test

---

### 9.5.1 General

---

The IEC413 option is capable of performing IEC 61000-4 section 13 Harmonics and inter harmonics low frequency immunity tests. The tests are based on IEC 61000-4-13:2002-03, First Edition. It is assumed that the user has a copy of the test standard available. This manual section only covers operation of the –413 option from the front-panel of the RS Series power source.

**Note 1:** The initial release of the –413 option for the RS Series power sources was based on a draft version (CDV) of the IEC 61000-4-13 standard. Minor changes were made between the CDV draft and the final released version. Units with firmware revision 0.31 or higher conform to the official released IEC standard. Units with older firmware conform to the draft version. A firmware upgrade can be ordered through AMETEK Programmable Power's service department by contacting [service.ppd@ametek.com](mailto:service.ppd@ametek.com) and requesting part number C1C637. Provide the model and serial number of the unit (master unit in multi-box systems) to ensure the correct firmware is provided. The firmware revision is displayed on the LCD screen immediately after power up for a few seconds. It can also be queried over the bus using the “\*IDN?” command.

Where relevant, the requirement for the correct firmware revision to obtain specific test modes is indicated in this manual.

**Note 2:** The –413 option is only available on RS90-3Pi Series AC power sources, not RS90-3 Series as it requires arbitrary waveform capability.

### 9.5.2 Initial Setup

---

The user must set the operating voltage and close the output relay prior to the start of test. The following set of parameters must be set before the start of test.

1. Frequency to 50 or 60 Hz.
2. Voltage mode to AC.
3. Waveform to sine wave.

### 9.5.3 Tests Performed

---

The IEC1000-4-13 test consists of several types of tests. These tests can be run individually or in sequence (ALL). The following tests are available:

1. Harmonic combination test flat curve and over swing.
2. Sweep in frequency and resonance frequency detection.
3. Individual harmonics and inter harmonics.
4. Meister curve test (Firmware revision 0.31 or higher required)

### 9.5.4 Front Panel Entry

While it is possible to perform IEC 61000-4-13 testing from the front panel of the RS Series AC power source, it is recommended to use the provided RSGui Windows program for report generation. This also provides a more convenient way to perform Class 1 and User class tests as test levels can be saved to disk.

To perform a test from the keyboard, select the APPLICATIONS screen from the MENU 2 screen. The APPLICATIONS SETUP 1 screen will appear. Move to the MORE field to proceed to the APPLICATIONS SETUP 2 screen as shown in Figure 9-20. (Note: On Series I RS models, the IEC 1000-4-13 option is located on the APPLICATIONS SETUP screen instead as there is only one APPLICATIONS SETUP screen.)

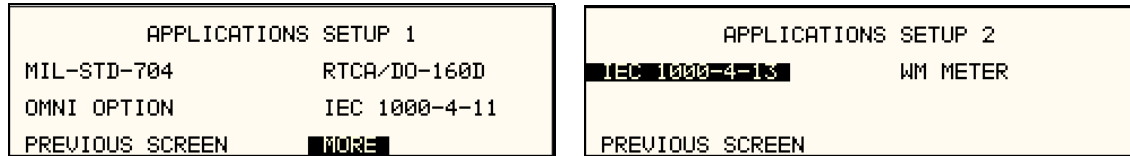

Figure 9-20: Application Setup Menus

Scroll to the IEC 1000-4-13 entry using the up and down cursor keys. Press the ENTER key to select the IEC 1000-4-13 main menu. The screen will appear as shown in Figure 9-21.

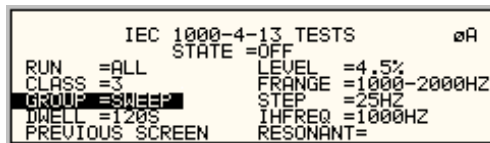

Figure 9-21: IEC1000-4-13 Menu

#### 9.5.4.1 IEC Screen Parameters

The IEC 1000-4-13 has the following common fields for all IEC1000-4-13 test groups.

##### STATE

The STATE field must be set to ON before the test can run. Initial setup conditions must be met to run the test. See section 9.5.2.

##### RUN

The RUN field has the following selections:

1. ALLRun all IEC 1000-4-13.
2. GROUP Run the selected group.
3. RANGE Run the selected range for the selected group.
4. POINT Run the selected frequency for the selected range and selected group.

Note: The RANGE and POINT do not apply to all groups. See individual groups for details.

When the test is running, this field will have the following selection:

1. ABORT The test will stop running and all parameters will return to the state prior to the start of the test.
2. PAUSE The test will pause at the time the ENTER key is pressed while the PAUSE field is selected. The field will change to RESUME. When the ENTER key is pressed again, the test will resume from the point it stopped.



**EUT CLASS**

This field selects the desired product or EUT class. There are three EUT classes. Class 2 and 3 are predefined by the standard and its level parameters cannot be changed. The user class can be edited at any time. Changing between class 2 and 3 can be done while the state is on. Changing to the user class requires the state to be in the off position.

For Class 1 EUT, the user class must be used. Only class 2 and 3 test levels are pre-programmed. When using the provided, RSGui Windows program, class 1 tests are set up by the RSGui program automatically.

**GROUP**

This field selects the GROUPs. Selecting a group is required for editing the data fields associated with the group as well as running the individual group if run group is selected. The field has the following groups:

1. FCURVE This is the first part of harmonic combination test.
2. OSWING This is the second part of harmonic combination test.
3. SWEEP This is the sweep in frequency and resonance frequency detection.
4. HRAM This is the first part of the Individual harmonics and interharmonics test.
5. IHARM This is the second part of the Individual harmonics and interharmonics test.
6. MCURVE This is the Meister test. (Firmware revision 0.31 or higher required)

See the appropriate sections for details on each group.

**DWELL**

This field will show the dwell time in seconds for each group during the test and will allow changes to the dwell time to be made.

The dwell time for the Meister curve group is the dwell time for each inter harmonics. This combined with the frequency step size results in a 5-minute test time per frequency decade.

The dwell time for the sweep group is the dwell time for each frequency decade.

### 9.5.4.2 IEC GROUPS

This section will describe the groups and parameters associated with IEC 1000-4-13. Refer to paragraph 9.5.4.1 for groups associated with the test.

#### FCURVE GROUP

If the FCURVE group is selected, the screen will appear as shown in Figure 9-22. The screen has the following parameters that are unique to the group:

```

IEC 1000-4-13 TESTS      @A
STATE =OFF
RUN  =ALL                LEVEL =80.0%
CLASS =3                 PAUSE =10S
GROUP =FCURVE
DWELL =120S
PREVIOUS SCREEN

```

Figure 9-22: IEC 1000-4-13 FCURVE

1. LEVEL Set the Flat curve clip level. This field can be set when the IEC 1000-4-13 is in the OFF state and the Class is set for USER class.
2. PAUSE Time in seconds the test will pause prior to proceeding to the following test. This field can be set at any time when the test is not running.

#### OSWING GROUP

If the OSWING group is selected, the screen will appear as shown in Figure 9-23. The screen has the following parameters that are unique to the group:

```

IEC 1000-4-13 TESTS      @A
STATE =OFF
RUN  =ALL                LEVEL =8.0%
CLASS =3                 HARM NO=3
GROUP =OSWING           PHASE =180.0°
DWELL =120S             PAUSE =10S
PREVIOUS SCREEN

```

Figure 9-23: IEC 1000-4-13 OSWING

1. LEVEL The level of the harmonics relative to the fundamental in percent. There are two levels, one for harmonic #3 and the other for harmonic #5. The harmonic number must be selected prior to the harmonic level entry. To change levels, the test state must be off and USER class must be selected.
2. HARM NO There are only two harmonic numbers. This field is used to set the harmonics level that corresponds to the harmonics number.
3. PHASE Sets the phase angle of the harmonics relative to the fundamental. The phase can be set when the test state is off and USER class is selected.
4. PAUSE Sets the time in seconds. The test will pause prior to proceeding to the following test. This field may be changed at any time as long as the test is not running.

## SWEEP GROUP

If the SWEEP group is selected, the screen will appear as shown in Figure 9-24. The screen has the following parameters that are unique to the group:

```

IEC 1000-4-13 TESTS      0A
STATE =OFF
RUN  =ALL                LEVEL =4.5%
CLASS =3                 FRANGE =1000-2000HZ
GROUP =SWEEP            STEP  =25HZ
DWELL =120S             IHFREQ =1000HZ
PREVIOUS SCREEN        RESONANT=

```

Figure 9-24: IEC 1000-4-13 SWEEP

1. LEVEL Sets the percentage level of the interharmonics relative to the fundamental. The level is fixed for the entire frequency range, which is defined by FRANGE. To change level, the test state must be off and user class must be selected.
2. FRANGE The range is selected by rotating the shuttle. The range selection is required to change the level for the selected range. Also, an individual range sweep is possible by selecting the desired range and selecting RUN RANGE from the RUN field.
3. STEP The step size defines the interharmonics sweep points. Step size is fixed for the entire sweep range. The STEP size can be changed when the test state is off.
4. IHFREQ This field will show the current interharmonic frequency when the test is running. An interharmonic frequency can be selected using the shuttle. To run a frequency without sweeping through the entire range, a RUN POINT can be selected.
5. RESONANT This field is used to report the resonant points, if any, after running the sweep test. No editing is allowed in this field. When the test is completed, a display of harmonics current versus frequency plot is available. To view the graph, select the field and press the ENTER key.

## HARMONICS GROUP

If the Harmonics group is selected, the screen will appear as shown in Figure 9-25. The screen has the following parameters that are unique to the group:

```

IEC 1000-4-13 TESTS      0A
STATE =OFF
RUN  =ALL                LEVEL =5.0%
CLASS =3                 HARM NO=2
GROUP =HARM              PHASE =0.0°
DWELL =120S             PAUSE =10
PREVIOUS SCREEN

```

Figure 9-25: IEC 1000-4-13 Harmonics

1. LEVEL Sets the percentage level of the harmonic relative to the fundamental. Each level is associated with a harmonic number. To change levels, the test state must be off and user class must be selected.
2. HARM NO Selecting a harmonic number using the shuttle knob will allow examination of the LEVEL and PHASE of each harmonic and changing the level and phase angle when USER class is selected.
3. PHASE Sets the phase angle of the harmonics relative to the fundamental. To change phase, the test state must be off and user class must be selected.
4. PAUSE Sets the pause time in seconds between harmonics tests. There is only one value for the entire test. The PAUSE value can be changed when the test is not running.

## IINTERHARMONICS GROUP

If the Harmonics group is selected, the screen will appear as shown in Figure 9-26. The screen has the following parameters that are unique to the group:

```

IEC 1000-4-13 TESTS      ⓂA
STATE =OFF
RUN =ALL                 LEVEL =4.0%
CLASS =3                FRANGE =1000-2000HZ
GROUP =IHHMM           STEP =25HZ
DWELL =120S            IHFREQ =1000HZ
PREVIOUS SCREEN        PAUSE =10S
  
```

Figure 9-26: IEC 1000-4-13 INTERHARMONICS

1. LEVEL Sets the percentage level of the inter harmonics relative to the fundamental. The level is fixed for the entire frequency range defined by FRANGE. To change levels, the test state must be off and user class must be selected.
2. FRANGE The range is selected by rotating the shuttle. The range selection is required to change the level. An individual range step can be run by selecting the desired range, followed by RUN RANGE from the RUN field.
3. STEP The step size defines the inter harmonics sweep points. This step size is fixed for the entire range of the sweep. The STEP size can be changed when the test state is off.
4. IHFREQ This field shows the current inter harmonic frequency when the test is running. An inter harmonic frequency can be selected with the shuttle. To run an inter harmonic frequency without sweeping through the entire range, RUN POINT must be selected.
5. PAUSE Sets the time in seconds for which the test will pause between inter harmonic frequencies. There is only one value for the entire test. The PAUSE can be set when the test is not running.

## MEISTER CURVE GROUP

If the Meister curve group is selected, the screen will appear as shown in Figure 9-27. The screen has the following parameters that are unique to the group:

```

IEC 1000-4-13 TESTS      ⓂA
STATE =OFF
RUN =ALL                 LEVEL =4.0%
CLASS =3                FRANGE =1000-2000HZ
GROUP =IHHMM           STEP =25HZ
DWELL =120S            IHFREQ =1000HZ
PREVIOUS SCREEN        PAUSE =10S
  
```

Figure 9-27: IEC 61000-4-13 Meister Curve

1. LEVEL Sets the percentage level of the inter harmonics relative to the fundamental. The level is fixed for the entire frequency range defined by FRANGE. To change levels, the test state must be off and user class must be selected.
2. FRANGE The range is selected by rotating the shuttle. The range selection is required to change the level. An individual range step can be run by selecting the desired range, followed by RUN RANGE from the RUN field.
3. STEP The step size defines the inter harmonics sweep points. This step size is fixed for the entire range of the sweep. The STEP size can be changed when the test state is off.
4. PAUSE Sets the time in seconds for which the test will pause between ranges. There is only one value for the entire test. The PAUSE can be set when the test is not running. For the Meister curve test, the pause time is normally set to 0 secs. If a value other than 0 is entered, the inter harmonics are set to 0% during the pause times.

5. RESONANT This field is used to report the resonant points, if any, after running the Meister curve test. No editing is allowed in this field. When the test is completed, a display of harmonics current versus frequency plot is available. To view the graph, select the field and press the ENTER key.

**9.5.4.3 RUNNING THE TEST**

The test sequence used is a function of the EUT class. The end user needs to determine the appropriate class of EUT. The test protocol is document in the IEC 61000-4-13 test standard. For reference, the test flow charts are shown here. It is assumed that the end user has a copy of the actual test standard however.

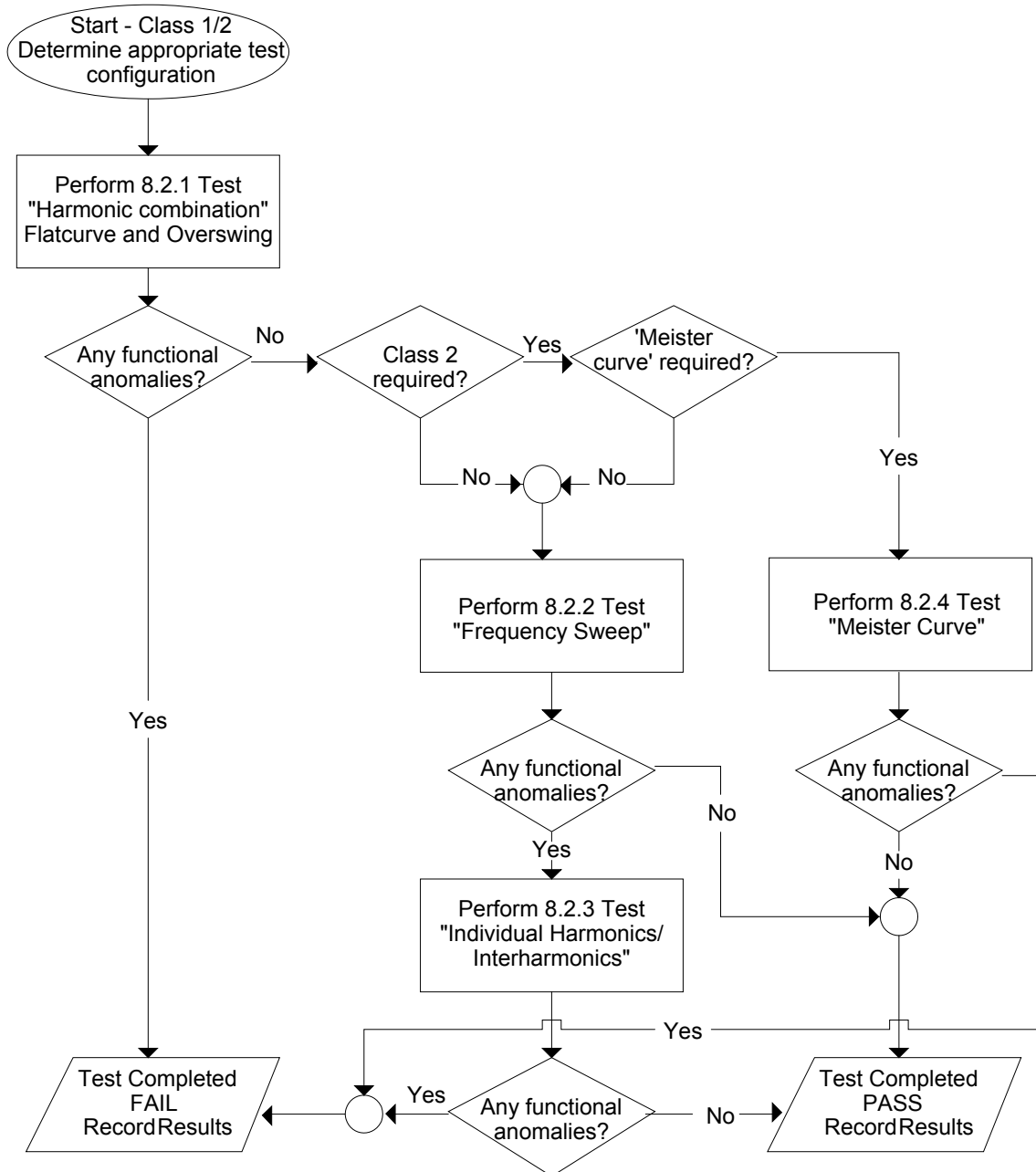

Figure 9-28: IEC 61000-4-13 Test Flowchart Class 1 and 2

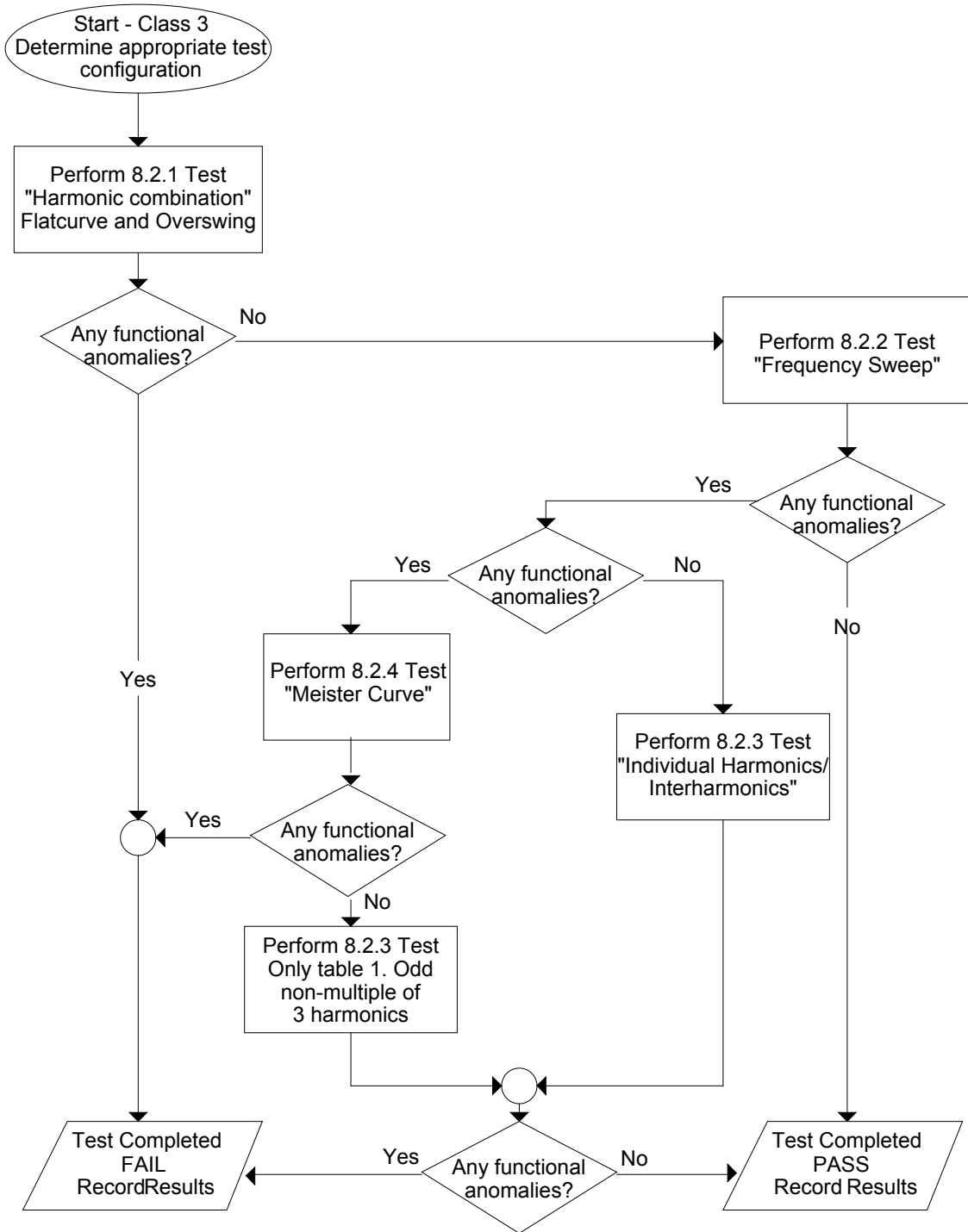

Figure 9-29:IEC 61000-4-13 Test Flowchart Class 3

To run the test, the IEC 1000-4-13 mode must be selected. Refer to paragraph 4 for access to the screen. The following conditions have to be met before running the test:

1. Prior to the test, set the nominal voltage, frequency, and phase angle. The frequency must be 50 or 60 Hz. Function must be set to sine wave.
2. Select EUT CLASS 2, 3 or USER. The default parameters for the USER class are identical to those for class 3. If USER class is selected, the level and phase parameters can be edited.
3. Set the STATE to ON. It will take a few seconds to initialize data required to perform the test.
4. If it is desired to run all tests, select ALL from the RUN parameter with the shuttle knob and press the ENTER key. The tests will run in the following sequence:

FCURVE, OSWING, SWEEP, HARM, IHARM

**Note:** The test for class 3 will take about 25 minutes, class 2 slightly less.

5. While the test is running, the ABORT and PAUSE selection is accessible from the RUN field by rotating the shuttle.
6. If it is desired to run a specific group, the group must be selected from the group screen. Also, the RUN GROUP must be selected prior to the start of test.
7. To run an individual range, applicable for sweep and individual harmonics only, the desired range and the RUN RANGE mode must be selected prior to the start of the test. In case the harmonics group is selected, RUN RANGE will run the harmonics from the second harmonics to the harmonics number specified by the HARM NO field. See Figure 9-25.
8. To run individual harmonics or individual inter harmonics, set the harmonic number or the inter harmonics frequency and select RUN POINT prior to running the test.



#### 9.5.4.4 INTERHARMONICS

A single inter harmonic frequency may be generated using the INTERHARMONICS screen. This screen allows insertion of any inter harmonic from 1Hz to 2400Hz in 1Hz steps. The amplitude level of the harmonics range is from 0 to 20% of the programmed voltage. To select the inter harmonics screen, press the menu screen until the MENU 2 screen appears as shown in Figure 9-30. Select INTERHARMONICS using the up or down key.



Figure 9-30: MENU 2 SCREEN

#### INTERHARMONICS SCREEN

The inter harmonics screen will appear as shown in Figure 9-31. This screen has the following parameters:



Figure 9-31: INTERHARMONICS SCREEN

1. REFERENCE This field will enable the Inter harmonics generator if ON is selected and will disable the inter harmonics generation if OFF is selected.
2. REF. COUPL If turned on, the REF. VOLT will follow the programmed voltage value.
3. REF. VOLT This field must be programmed to a value if REF. COUPL is off. This value has a range from 0 to 230 volts. This value is set to a value equal to the phase A voltage if the REF. COUPL is turned on.
4. VOLTAGE This field programs the Inter harmonic level in percentage of the REF.VOLT. This value has a range from 0 to 20%

## 9.6 Option –704: MilStd704 Tests

---

The MIL704 option is made up of both firmware that resides in the power source and the RSGui Windows application program. The firmware covers revision D and E of the Mil-Std704 standard. The RSGui covers the remaining revisions A, B, C and F. This provides coverage of all available standard revisions.

The user interface for each implementation is different however. The revision D and E tests can be operated directly from the power source's front panel or through the supplied RSGui program. The revision A-C, F tests can only be operated through the supplied RSGui program. Thus, for rev A-C and F, a Windows PC and interface is required.

Section 9.6.1 covers operation of the firmware based revision D and E tests.

For information regarding the operation of the MIL-STD-704 revision A, B, C, and F tests with the RSGui, please refer to the Avionics Software Manual (CI part no. 4994-971 included on CDROM). Note that future updates of the RSGui may include overlapping coverage for revisions D and E in the software as the RSGui program is designed to support all revisions. For now, revisions D and E have no associated data files in the RSGui.

---

## 9.6.1 Option –704: MIL-STD-704 rev D & E Tests. (Firmware)

---

### 9.6.1.1 General

---

The MIL704 option is capable of performing most sections of MIL-STD-704 rev D and E in either of the AC or DC mode.

---

**Note:** *The Distortion Spectrum tests:*

*Table I and II, Figure 7*

*Table III, Figure 12*

*Table IV, Figure 18*

*are not supported by the –704 option. These tests require the use of additional external equipment.*

---

### 9.6.1.2 Initial Setup

---

Nominal parameters for the AC Power source are as follows:

Output Voltage                      115V L-N

Output Frequency                  400 Hz

Nominal parameters for the DC Power source are as follows:

Output Voltage                      28V or 270V L-N

A setting outside these nominal values will disable the test and will prevent access to its Menu screens.

### 9.6.1.3 Revision

---

The MIL704 option defaults to Revision E. The System is capable of performing Revision D test by changing the selection to Revision D. All Revision D tests can be performed except for the 270V DC TRANSIENT and ABNORMAL. For these tests, Revision E test levels are used despite the revision D selection.

**All levels and timing in this document refers to Revision E. For Revision D, refer to MIL-STD-704D date 9/30/1980**

### 9.6.1.4 Tests Performed

---

#### 9.6.1.4.1 STEADY STATE

AC Mode:

1. Steady State Voltage and Frequency test
2. Waveform Distortion test
3. Voltage Modulation test
4. Voltage Unbalance test
5. Phase Unbalance test
6. Frequency Modulation test
7. Transient Voltage low and high test
8. Transient Frequency low and high test

DC Mode:

1. Steady State Voltage test
2. Ripple test

9.6.1.4.2 EMERGENCY TEST

AC Mode:

1. Emergency Voltage minimum and maximum test
2. Emergency Frequency minimum and maximum test

DC Mode:

1. Emergency Voltage minimum and maximum test

9.6.1.4.3 ABNORMAL TEST

AC Mode:

1. Abnormal Voltage under
2. Abnormal Voltage over
3. Abnormal Frequency under
4. Abnormal Frequency over

DC Mode:

1. Abnormal Voltage under
2. Abnormal Voltage over

**9.6.1.5 Front Panel Entry**

To perform a test from the keyboard, from the MENU 2 screen, select the APPLICATIONS screen. The APPLICATIONS screen will appear as shown in Figure 9-32.



Figure 9-32: Application Menu

Scroll to the MIL-STD-704 entry using the up and down cursor keys. Press the ENTER key to select the MIL704 main menu. One of the screens will appear as shown in Figure 9-33. The voltage mode and setting will define which menu to select. Refer to Section 9.6.1.2

**Note:** The user has to turn on the Output relay before starting a test and set the steady state setup for the test.



Figure 9-33: MIL704 Menu

### 9.6.1.6 Revision Selection

The default Revision is E. Revisions supported are D and E. The Revision can be changed from the front panel. Scroll to the REVISION entry using the up and down cursor keys (see Figure 9-33). Use the shuttle to change the selection.

### 9.6.1.7 AC MODE TESTS

#### 9.6.1.7.1 Steady State Test

Scroll to the STEADY STATE AC entry using the up and down cursor keys. Press the ENTER key to select the STEADY STATE screens. The screen will appear as shown in Figure 9-34.



Figure 9-34: Steady State Menu

The MIL704 Steady state 1 and Steady state 2 screens have the following tests:

- 1 VOLTAGE
- 2 FREQUENCY
- 3 VOLT UNBALANCE
- 4 PHASE DIFFERENCE
- 5 VOLT MODULATION
- 6 FREQ MODULATION
- 7 DISTORTION

The above tests can be selected by scrolling to the highlighted selection using the up and down cursor keys and the ENTER key to start the selected test.

#### VOLTAGE

This test will change the output voltage in the following sequence:

- 108V for 1 minute.
- 118V for 1 minute.
- 115V for 1 minute.

The ← key (backspace) will terminate the test at any time.

**FREQUENCY**

This test will change the output frequency in the following sequence:

- 393Hz for 1 minute.
- 407Hz for 1 minute.
- 400Hz for 1 minute.

The ← key (backspace) will terminate the test at any time.

**VOLT UNBALANCE**

This test will change the output voltage for the selected phase only in the following sequence:

- 112V for 1 minute.
- 118V for 1 minute.
- 115V for 1 minute.

The test will be repeated on three phase systems to include all three phases if the coupling is set to all.

The ← key (backspace) will terminate the test at any time.

**PHASE DIFFERENCE**

This test applies to three phase systems only. The phase angle for the selected phase will change relative to phase A in the following sequence:

If phase B is selected:

- 236° for 1 minute.
- 244° for 1 minute.
- 240° for 1 minute.

If phase C is selected:

- 116° for 1 minute.
- 124° for 1 minute.
- 120° for 1 minute

**VOLTAGE MODULATION**

This test will vary the output voltage by  $\pm 2.5V$  rms over a period of one second. The test will last for 2 minutes. The ← key (backspace) will terminate the test at any time.

**FREQUENCY MODULATION**

This test will vary the output frequency by  $\pm 4Hz$  over a period of one minute. The test will last for 4 minutes. The ← key (backspace) will terminate the test at any time.

**WAVEFORM DISTORTION**

This test will generate a 5% THD voltage distortion on the output voltage waveform. The distortion is caused by using a clipped sine wave. The test will last for 1 minute. The ← key (backspace) will terminate the test at any time.

### 9.6.1.7.2 TRANSIENT TEST

From the MIL704 main menu (Figure 9-33) scroll to the TRANSIENT AC entry using the up and down cursor keys. Press the ENTER key to select the TRANSIENT screens. The screen will appear as shown in Figure 9-35.

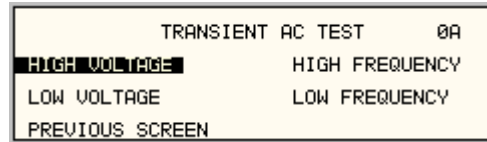

Figure 9-35: Transient Menu

The MIL704 Transient screen has the following tests:

- 1 HIGH VOLTAGE
- 2 LOW VOLTAGE
- 3 HIGH FREQUENCY
- 4 LOW FREQUENCY

The above tests can be selected by scrolling to the highlighted selection using the up and down key and the ENTER key to start the selected test.

#### HIGH VOLTAGE

This test will change the output voltage for the selected phase in the following sequence:

- 180V for 10 msec.
- Linearly reduced to 118V in 78msec.
- Stay at 118V for 87msec before returning to 115V.

Prior to the test, a range change may take place if the power source is set for the low voltage range.

The ← key (backspace) will terminate the test at any time.

**Note:** A range change will result in momentary loss of power to the EUT. If this is not acceptable, the power source must be left in high range at all times.

#### LOW VOLTAGE

This test will change the output voltage for the selected phase only in the following sequence:

- 80V for 10 msec.
- Linearly increase to 108V in 70msec.
- Stay at 108V for 95msec before returning to 115V.

The ← key (backspace) will terminate the test at any time.

#### HIGH FREQUENCY

This test will change the output frequency in the following sequence:

- 425Hz for 1 sec.
- 420Hz for 4 sec.
- 410Hz for 5 sec.
- 407Hz for 4 sec.

#### LOW FREQUENCY

This test will change the output frequency in the following sequence:

- 375Hz for 1 sec.
- 380Hz for 4 sec.
- 390Hz for 5 sec.
- 393Hz for 4 sec.

#### 9.6.1.7.3 EMERGENCY TEST

From the MIL704 main menu (Figure 9-33) scroll to the EMERGENCY AC entry using the up and down cursor keys. Press the ENTER key to select the EMERGENCY screens. The screen will appear as shown in Figure 9-36.

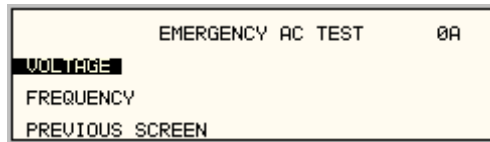

Figure 9-36: Emergency Menu

The EMERGENCY SCREEN has the following tests:

- 1 VOLTAGE
- 2 FREQUENCY

The above tests can be selected by scrolling to the highlighted selection using the up and down key and the ENTER key to start the selected test.

#### **VOLTAGE**

This test will change the output voltage in the following sequence:

- 108V for 1 minute.
- 118V for 1 minute.
- 115V for 1 minute.

The ← key (backspace) will terminate the test at any time.

#### **FREQUENCY**

This test will change the output frequency in the following sequence:

- 393Hz for 1 minute.
- 407Hz for 1 minute.
- 400Hz for 1 minute.

The ← key (backspace) will terminate the test at any time.



#### 9.6.1.7.4 ABNORMAL TEST

From the MIL704 main menu (Figure 9-33) scroll to the ABNORMAL AC entry using the up and down cursor keys. Press the ENTER key to select the ABNORMAL screens. The screen will appear as shown in Figure 9-37.

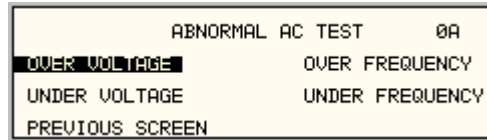

Figure 9-37: Abnormal Screen

The ABNORMAL SCREEN has the following tests:

- 1 OVER VOLTAGE
- 2 UNDER VOLTAGE
- 3 OVER FREQUENCY
- 4 UNDER FREQUENCY

The above test can be selected by scrolling to the highlighted selection using the up and down key and the ENTER key to start the selected test.

#### OVER VOLTAGE

This test will change the output voltage for the selected phase in the following sequence:

- 180V for 50msec.
- The voltage gradually decays with time to 125 volt by the following equation:  

$$V = 124.6 + 2.77/t \text{ for } 0.05 \leq t \leq 6.925$$
- Stay at 125V for 93 seconds before returning to 115V.

Prior to the test, a range change may take place if the power source is set at the low voltage range.

The ← key (backspace) will terminate the test at any time.

**Note:** A range change will result in momentary loss of power to the EUT. If this is not acceptable, the power source must be left in high range at all times.

#### UNDER VOLTAGE

This test will change the output voltage for the selected phase in the following sequence:

- 0V for 7 seconds.
- 100V for 93 seconds.
- The ← key (backspace) will terminate the test at any time.

#### OVER FREQUENCY

This test will change the output frequency in the following sequence:

- 480Hz for 5 seconds.
- 420Hz for 9 seconds.

The ← key (backspace) will terminate the test at any time.

#### UNDER FREQUENCY

This test will change the output frequency in the following sequence:

- 0Hz for 7 seconds.
- 380Hz for 7 seconds.

The ← key (backspace) will terminate the test at any time.

### 9.6.1.8 DC TESTS

If the output voltage is set for 28V DC or 270V DC the MIL704 DC Main selection screen will appear as seen in Figure 9-38.

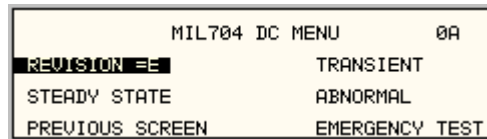

Figure 9-38: MIL704 DC Menu

#### 9.6.1.8.1 Steady State Test

Scroll to the STEADY STATE entry using the up and down cursor keys. Press the ENTER key to select the STEADY STATE screen. The screen will appear as shown

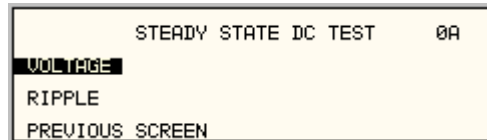

Figure 9-39: Steady State DC

The MIL704 STEADY STATE screen has the following tests:

- 1 VOLTAGE
- 2 RIPPLE

The above tests can be selected by scrolling to the highlighted selection using the up and down key and the ENTER key to start the selected test.

#### VOLTAGE

This test will change the output voltage for the selected phase in the following sequence:

1. 28V system:
  - 22V for 1 minute.
  - 29V for 1 minute.
  - 28V for 1 minute.
2. 270V system:
  - 250V for 1 minute.
  - 280V for 1 minute.
  - 270V for 1 minute.

The ← key (backspace) will terminate the test at any time.

#### RIPPLE

This test will impose a 400Hz frequency component to the output voltage. The test will last for 2 minutes. The level of the ripple is as follows:

1. 28V system:

±1.5V.

2. 270V system:

±6.0V.

The ← key (backspace) will terminate the test at any time.

#### 9.6.1.8.2 Transient Test

From the MIL704 DC MENU scroll to the TRANSIENT DC entry using the up and down cursor keys. Press the ENTER key to select the TRANSIENT screen. The screen will appear as shown in Figure 9-40.

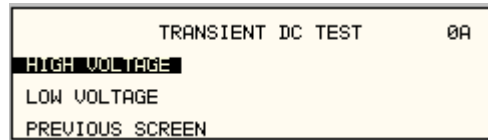

Figure 9-40: Transient Menu

The Transient Test has the following tests:

- 1 HIGH VOLTAGE
- 2 LOW VOLTAGE

#### HIGH VOLTAGE

This test will change the output voltage for the selected phase in the following sequence:

1. 28V System
  - 50V for 12.5 msec.
  - Linearly reduce to 29V in 70msec.
  - Stay at 29V for 92.5msec before returning to 28V.
2. 270V System
  - 330V for 20 msec.
  - Linearly reduce to 280V in 20msec.
  - Stay at 280V for 135msec before returning to 270V.

Prior to the test, a range change may take place if the power source is set for the low voltage range.

The ← key (backspace) will terminate the test at any time.

**Note:** A range change will result in momentary loss of power to the EUT. If this is not acceptable, the power source must be left in high range at all times.

#### LOW VOLTAGE

This test will change the output voltage for the selected phase in the following sequence:

1. 28V System
  - 18V for 15 msec.
  - Linearly increase to 22V in 85msec.
  - Stay at 22V for 75msec before returning to 28V.
2. 270V System

- 200V for 10 msec.
- Linearly increase to 250V in 30msec.
- Stay at 250V for 135msec before returning to 270V.

The ← key (backspace) will terminate the test at any time.

#### 9.6.1.8.3 Abnormal Test

From the MIL704 DC MENU scroll to the ABNORMAL DC entry using the up and down cursor keys. Press the ENTER key to select the ABNORMAL screen. The screen will appear as shown in Figure 9-41.

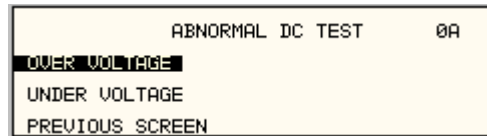

Figure 9-41: Abnormal Test Screen

The Abnormal Test has the following tests:

- 1 OVER VOLTAGE
- 2 UNDER VOLTAGE

The above tests can be selected by scrolling to the highlighted selection using the up and down cursor keys and the ENTER key to start the selected test.

#### OVER VOLTAGE

This test will change the output voltage for the selected phase in the following sequence:

1. 28V system:
  - 50V for 50msec.
  - The voltage gradually decays with time to 31.5 volts by the following equation:  
 $V = 31.38 + 0.93/t$  for  $0.05 \leq t \leq 7.758$
  - Stay at 31.5V for 92.242 seconds before returning to 28V.
2. 270V system:
  - 350V for 50msec.
  - The voltage gradually decays with time to 290 volts by the following equation:  
 $V = 289.6 + 3.02/t$  for  $0.05 \leq t \leq 7.55$
  - Stay at 290V for 92.45 seconds before returning to 270V.

Prior to the test, a range change may take place if the power source is set at the low voltage range. Note: See Section 9.6.1.7.2 under HIGH VOLTAGE.

The ← key (backspace) will terminate the test at any time.

**Note:** A range change will result in momentary loss of power to the EUT. If this is not acceptable, the power source must be left in high range at all times.

#### UNDER VOLTAGE

This test will change the output voltage for the selected phase in the following sequence:

1. 28V system:
  - 0V for 7sec.
  - 20V for 93sec.

2. 270V system:

- 0V for 7sec.
- 240V for 93sec.

The ← key (backspace) will terminate the test at any time.

9.6.1.8.4 Emergency Test

From the MIL704 DC MENU scroll to the EMERGENCY DC entry using the up and down cursor keys (Figure 9-42). Press the ENTER key to start the EMERGENCY TEST.

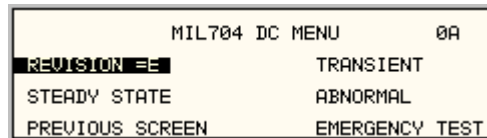

Figure 9-42: Emergency Test

**VOLTAGE**

This test will change the output voltage for the selected phase in the following sequence:

1. 28V system:

- 18V for 1 minute.
- 29V for 1 minute.
- 28V for 1 minute.

2. 270V system:

- 250V for 1 minute.
- 280V for 1 minute.
- 270V for 1 minute.

The ← key (backspace) will terminate the test at any time.

### **9.7 Option –ABD: Airbus ABD0100.1.8 Test**

---

For information regarding the operation of the ABD0100.1.8 tests with the RSGui, please refer to the Avionics Software Manual (CI part no. 4994-971 included on CDROM).

### **9.8 Option –AMD: Airbus AMD24C Test**

---

For information regarding the operation of the AMD24C tests with the RSGui, please refer to the Avionics Software Manual (CI part no. 4994-971 included on CDROM).

### **9.9 Option –787: Boeing B787-0147 Test**

---

For information regarding the operation of the Boeing B787-0147 tests with the RSGui, please refer to the Avionics Software Manual (CI part no. 4994-971 included on CDROM).

## 9.10 Option –WHM: Watt Hour Measurement

### 9.10.1 General

This section describes the WHM option available for the RS Series Power Source.

### 9.10.2 Specification

All specifications are the same as the standard RS Power Source specifications in addition to the following specifications:

Watt-hour

0-6.000KW	0.2%FS +0.1%R	<100 Hz
	0.5%FS +0.1%R	100-819 Hz
>6.000KW	Times three of the above specification	

### 9.10.3 Local Operation

- From the Menu screen 2, select the APPLICATIONS SETUP 2 screen. The screen will appear as shown in Figure 9-43. Use the up and down key to position the cursor to the WH METER field. Press the Enter Key.

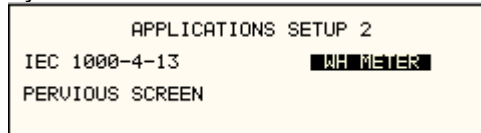

Figure 9-43: Application Screen

- The WATT-HOUR METER screen shown in Figure 9-44 has the following fields:

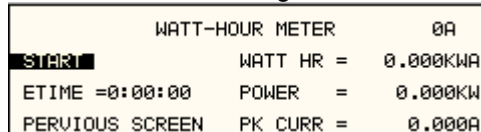

Figure 9-44: Watt-Hour Meter Screen

- START: This field will activate the watt-hour measurements. Moving the shuttle clockwise when the field is highlighted will activate the watt-hour function and the field will change to STOP as shown in Figure .
- ETIME: This field will accumulate the time in hours, minutes and seconds.
- WATT HR: This field will accumulate the watt-hour in KWH.
- POWER: This field will report the instantaneous power in KW.
- PK CURR: This field will report the peak current and will hold the maximum reading.

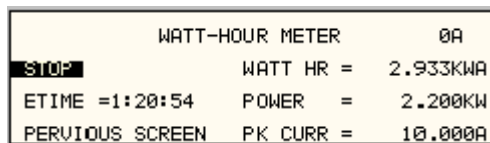

Figure 9-45: WH-Meter Screen with Function Active

**Note:** Changing from stop to start will stop the measurement and will maintain the last data record for the watt-hour meter. To restart the measurements, the field is toggled to the stop position from the start position and the previous data will be reset to zeros.

WATT HR, POWER and PK CURR will display the data for the phase selected with the phase key. If the phase is selected for all phases in a two or three phase system, the WATT HR and POWER fields will show the sum of all phases. PK CURR will remain at the last selected phase.

**Note:** Changing Mode of operation from single phase to three phases while the Watt-hour meter is in the active state will generate an error: "Input buffer full". This error will halt the measurements. To clear the error, the Watt-hour meter must be switched to the stopped state. It is advised that the Watt-hour meter should be set to the stop state before changing the mode of operation.



---

## 9.11 Option –SNK: Current Sink

---

### 9.11.1 General

---

This section describes the SNK option available for the RS Series Power Source.

### 9.11.2 General Description

---

The –SNK or current sink option enables the RS power source to sink current from the unit under test. This mode of operation is particularly useful when testing grid-tied products that feed energy back onto the grid. The ability of the RS to simulate the grid provides unique opportunities to test the EUT for immunity to commonly occurring line anomalies like voltage and/or frequency fluctuations. Typical examples of these types of EUT's are solar and/or wind power inverters.

The SNK option requires special amplifiers that have a different control loop from the standard RS amplifiers. This different control loop ensures greater stability under regenerative load conditions. Due to this modified characteristic however, the upper frequency limit of an RS configured with the –SNK option is reduced to 500Hz from the standard 819Hz.

RS units without the SNK will generate an error message if more than 20% of available power (per phase) is regenerated by the load. It will shut off if the negative power reaches 30% of available power.

**Regenerative Mode of operation** The RS will automatically operate in regenerative mode when the Regenerative state is enabled and the measured power is negative, indicating energy is being fed back into the RS amplifiers. In this mode of operation, the current limit mode will behave differently than it does under normal load conditions.

When the absolute value of the current exceeds the regenerative programmable current limit set point (current limit is set in the REGENERATE CONTROL screen), the output voltage of the RS will be increased gradually in an attempt to reduce the amount of current being fed back. Note that there is no other way for the RS to limit the current as the current is not generated by the RS itself but rather by the load (inverter). Consequently, normal current limit operation does not apply in this mode of operation. The voltage will continue to be raised until the user set over voltage trip point is reached. This trip level can be set in the REGENERATE CONTROL screen located under the APPLICATIONS SETUP 2 screen. At this point, and after the delay set by the "DELAY F" parameter is reached, the AC frequency will be shifted by the amount set in the dFREQ parameter field. Most inverters will shut down when detecting a sudden change in frequency. If the frequency shift (dFREQ) is set to zero however, the output voltage will be dropped to the under voltage limit setting (UNDER VOLT) set in the REGENERATE CONTROL screen instead of the frequency shift. At this point, the EUT should shut down due to an under voltage condition. Finally, the output relay is opened after the user set delay expires and the current still exceed the current limit set in the REGENERATE CONTROL screen.

### 9.11.3 REGENERATE Control Screen

REGENERATE CONTROL		ΦABC
STATE = ON		
UNDER VOLT = 108.00	dFREQ	= 0.50Hz
OVER VOLT = 240.00	DELAY	= 7.000S
PREVIOUS SCREEN	CURR	= 20.0A

Figure 9-46: REGENERATE CONTROL screen

The –SNK option mode of operation is controlled by parameters set in the REGENERATE CONTROL SCREEN. Access to this screen is from the APPLICATIONS SETUP 2 screen by selecting the SNK entry and pressing the ENTER key.

The following parameters are available to be programmed by the user.

Field	Description	Setting Range	Purpose
STATE	Enable the Regenerate Function	ON / OFF	This field allows the regenerative mode of operation to be enabled. The regenerative state can only be enabled if the output relay is open and the frequency is set between 40Hz and 80Hz. If the state is OFF, the RS operates like a normal RS without the SNK option installed. In normal mode, only 20% of available current can be sunk and the RS will generate an error 31 and 32. fault.
UNDER VOLT	EUT under voltage limit	0.0 to max V range value	Sets the EUT shut off voltage, Active only if the dFREQ listed below is set to zero. This is the voltage (AC or DC) at which the EUT will shut off. If set to a value that will allow the EUT to continue operating, the RS may be unable to limit the current being fed back by the EUT.
OVER VOLT	EUT over voltage limit	0.0 to max V range value	Sets the EUT over voltage limit. This is the maximum allowable voltage (AC or DC) at which the EUT can operate. The output voltage may be increased up to this level if the current limit is exceeded in an effort to keep the current below the set current limit value. This over-voltage threshold also triggers the power source to either change the programming frequency or reduce the output voltage depending on the delta frequency setting (0.0Hz to reduce the output voltage and any delta frequency to change the programming frequency) after the DELAY F delay is reached.
dFREQ	Delta Frequency	0.0 to 6.0 Hz	This setting determines the size of the frequency shift that will be applied to the EUT after the current limit has been exceeded. If set to 0.0 Hz, no frequency shift will be applied.
DELAY	Delay	0.25 to 5.00 sec	This delay setting field is used to set the delay time for both the Frequency shift event (Delay F) and the Output relay open event (Delay R).
		Frequency Shift application delay time. (Delay F)	This delay determines how long the RS waits to apply the programmed frequency shift to the EUT after the set current limit level has been exceeded.
		Output Relay Open delay time.	This delay determines how long the RS waits to open the output relay after the frequency shift has been

Field	Description	Setting Range	Purpose
		(Delay R)	applied and the current still exceeds the set current limit level. If the frequency shift is set to 0.0Hz, this setting determines the time the output relay will be opened after the UNDER VOLTAGE is applied
CURR	Regen Current Limit		This is the regenerate current limit set point that the power source tries to limit the current to that is fed back from the inverter. It is different from the normal current limit set value shown in the PROGRAM screen.
PREVIOUS SCREEN			Returns to previous screen.

#### 9.11.4 SNK Setting Retention

---

Parameters set in the REGENERATE CONTROL screen are retained in non-volatile memory between uses except for the STATE field which always powers up in the OFF state. They are NOT part of the setup registers however. Thus, only one set of parameters is retained reflecting the last used settings.

#### 9.11.5 SNK Remote Control

---

The same SNK parameters can also be programmed over any of the available remote control interfaces using SCPI commands. Refer to the RS Programming Manual for details on programming syntax.

#### 9.11.6 SNK and Phase Modes

---

On RS models operating in three phase mode, the protection shut down mechanisms are implemented on a phase by phase basis. This means that these parameters can be different for each phase. To set all parameters to the same value for all three phases, use the PHASE button on the front panel to select the ABC indication in the upper right corner of the LCD display. This will allow you to set these values for all three phases. To set values by individual phase, use the PHASE button to select either A, B, or C. The PHASE button cycles between A,B,C and ABC.

For three phase EUT's, it is generally recommended to set the same values for all three phases.

#### 9.11.7 Output Relay control while in Regen Mode

---

For some PV inverter tests, it may be necessary to 'disconnect' the inverter from the grid (simulated by the power source). When the SNK state is ON, the OUTPUT relay control (Output On/Off) will cause the output relay to open without the output voltage being dropped first. It is important to make sure the inverter is in a balanced state with respect to its load so minimal current flows into the power source. If not, the relay of the power source will be hot switched which should be avoided.

#### 9.11.8 FC Option

---

When this option is enabled the output frequency will step  $\pm 0.15\%$  of program value

## 9.12 Option –EXTD: External Drive

The RS90 series power source system EXTD option can be used to drive the RS amplifier outputs with a customer supplied external signal, apart from the standard drive signal from the programmable controller. Using the EXTD allows a quick, low cost and simple way of direct real-time control of the output of the power supply.

Each input is optically isolated from each other and the LV supplies inside the RS cabinet. If desired, the COM inputs for A, B and C can be tied together when a three-phase drive signal is used

External Oscillator connector

Input Pin	Label	Description
1	A HI	0-7Vrms Phase A Input
2	ACOM	Phase A Common
3	B HI	0-7Vrms Phase B Input
4	BCOM	Phase B Common
5	C HI	0-7Vrms Phase C Input
6	CCOM	Phase C Common



The input signal level is 0 – 7.00Vrms for FS output on 300V range

The input signal level is 0 – 7.00Vrms for FS output on 150V range

If voltage, current or frequency exceeds the system specifications the internal controller will automatically take control and shut down the output and an error message will be generated. Short circuit and over temperature protection is included during EXTD operation.

To enable the EXT drive option from the front panel controller, proceed as follows:

Go to MENU3  
Go to UTILITY  
Select VOLT/CURR CONTROL field

Now set ALC = OFF  
Now toggle VOLT REF = EXT Use shuttle, or, +/- key to change field.

Once the RS is set to EXTD mode turn the output ON then apply the external signal. If the external signal is applied prior to the output being turned ON, ringing can occur and the controller will shut down the system. Ensure the EXTD is enabled and the output is ON prior to applying the external signal.

The RS EXTD circuit includes high frequency protection circuitry that results in a 100µsec delay from Internal EXTD input the amplifier output.

Caution should be taken to minimize DC voltage when equipment under test includes a transformer. Any DC voltage present on the external signal will be amplified, causing transformer saturation and automatic shutdown of the RS Series.

The RS voltage slew rate is approximately 0.5V/µsec. External drive signal slew rates should be set to similar speeds to avoid overshoot or ringing of the amplifier during voltage transient generation.

It's recommended to discontinue use of the RSGUI while in EXTD mode of operation.

## 10. Error Messages

Any errors that occur during operation from either the front panel or the remote control interface will result in error messages. Error messages are displayed in the upper left hand corner of the LCD display. They are also stored in the error message queue from which they can be queried using the SYST:ERR? Query. The error queue has a finite depth. If more error messages are generated than can be held in the queue, a queue overflow message will be put in the last queue location. To empty the queue, use the error query until the No Error result is received.

Errors appearing on the LCD will generally remain visible until the user moves to another screen. If multiple error messages are generated in succession, only the last message will be visible as there is only space for one error message on the LCD display.

The same area of the display is also used to display status messages. While error messages always have a negative error number, status messages have a positive number.

The table below displays a list of possible error and status messages along with their possible cause and remedy.

Number	Message String	Cause	Remedy
0	"No error"	No errors in queue	
-100	"Command error"	Unable to complete requested operation	Unit may be in a mode inconsistent with request.
-102	"Syntax error"	Command syntax incorrect.	Misspelled or unsupported command
-103	"Invalid separator"	SCPI separator not recognized	See SCPI section of programming manual.
-104	"Data type error"	Data type invalid.	Check command for supported data types
-108	"Parameter not allowed"	One or more additional parameters were received.	Check programming manual for correct number of parameters
-109	"Missing parameter"	Too few parameters received for requested operation	Check programming manual for correct number of parameters
-110	"Command header error"	Command header incorrect	Check syntax of command.
-111	"header separator error"	Invalid command separator used.	Use semi-colon to separate command headers
-112	"Program mnemonic too long"	Syntax error	Check programming manual for correct command syntax
-113	"Undefined header"	Command not recognized error	Check programming manual for correct command syntax
-120	"Numeric data error"	Data received is not a number	Check programming manual for correct command syntax
-121	"Invalid character in number"	Number received contains non-numeric character(s)	Check programming manual for correct command syntax
-123	"Exponent too large"	Exponent in number exceeds limits	Check programming manual for correct parameter range
-128	"Numeric data not allowed"	Number received when number is not allowed.	Check programming manual for correct command syntax
-168	"Block data not allowed"	Block data was sent.	Check programming manual for correct command syntax
-200	"Execution error"	Command could not be	Command may be inconsistent

Number	Message String	Cause	Remedy
		executed	with mode of operation such as programming frequency when in DC mode.
-201	"Invalid while in local"	Command issued but unit is not in remote state	Put instrument in remote state before issuing GPIB commands.
-203	"Command protected"	Command is locked out	Some commands are supported by the unit but are locked out for protection of settings and are not user accessible.
-210	"Trigger error"	Problem with trigger system.	Unit could not generate trigger for transient execution or measurement.
-211	"Trigger ignored"	Trigger request has been ignored.	Trigger setup incorrect or unit was not armed when trigger was received. Check transient system or measurement trigger system settings.
-213	"Init ignored"	Initialization request has been ignored	Unit was told to go to armed state but was unable to do so. Could be caused by incorrect transient system or measurement acquisition setup.
-220	"Parameter error"	Parameter not allowed.	Incorrect parameter or parameter value. Check programming manual for allowable parameters
-221	"Setting conflict"	Requested setting conflicts with other setting in effect.	Check other settings. E.g. trying to program a DC offset while in AC mode
-222	"Data out of range"	Parameter data outside of allowable range.	Check programming manual for allowable parameter values
-223	"Too much data"	More data received than expected	Check programming manual for number of parameters or data block size
-224	"Illegal parameter value"	Parameter value is not supported	Check programming manual for correct parameters
-226	"Lists not same length"	One or more transient lists programmed has different length.	All lists must be of same length or transient cannot be compiled and executed.
-241	"Hardware missing"	N/A	N/A
-254	"Media full"	No storage space left to save settings or data.	Delete other settings or data to make room.
-255	"Directory full"	Too many waveform directory entries	Delete one or more waveforms from waveform memory to make room.
-256	"File name not found"	Waveform requested not in directory	Check waveform directory for waveform names present.
-257	"File name error"	Incorrect filename	Too many or non ASCII characters used in waveform file definition.
-283	"Illegal variable name"	Variable name illegal.	Use ASCII characters only
-300	"Device specific error"	Hardware related error	Check hardware for proper

Number	Message String	Cause	Remedy
			operation.
-311	"Memory error"	Waveform memory checksum error.	May be the result of incomplete user-defined waveform download. Check interface and try downloading waveform again. Successful download may clear this error condition. Alternatively, use TRAC:DEL:ALL command to clear waveform memory.
-314	"Save/recall memory lost"	User setup register contents lost	Store setup in same register again.
-315	"Configuration memory lost"	Hardware configuration settings lost.	Contact CI service department at <a href="mailto:service.ppd@ametek.com">service.ppd@ametek.com</a> to obtain instructions on restoring configuration data.
-330	"Self-test failed"	Internal error	Contact CI service department at <a href="mailto:service.ppd@ametek.com">service.ppd@ametek.com</a>
-350	"Queue overflow"	Message queue full.	Too many messages. Read status using SYST:ERR query until 0, "No Error" is received indicating queue empty.
-400	"Query error"	Unable to complete query.	Check programming manual for correct query format and parameters
-410	"Query INTERRUPTED"	Query issued but response not read.	Check application program for correct flow. Response must be read after each query to avoid this error.
-420	"Query UNTERMINATED"	Query incomplete.	Check for terminator after query command.
-430	"Query DEADLOCKED"	Query cannot be completed	Check application program for multiple queries
-440	"Query UNTERMINATED"	Query incomplete.	Check for terminator after query command.
1	"Output volt fault"	Output voltage does not match programmed value.	Load exceeds current limit and unit is in Constant Voltage (CV) mode of operation. Reduce load or increase CL setting. Output voltage is driven above programmed voltage by external influence (Load, voltage kickback, etc.)
2	"Current limit fault"	Current limit exceeded.	Load exceeds current limit and unit is in Constant Voltage (CV) mode of operation. Reduce load or increase CL setting
3	"Temperature fault"	Temperature of heat sink too high.	Reduce load. Ensure proper airflow and exhaust clearance. Check fan(s) for operation.
4	"External sync. error"	Could not sync to external sync signal.	External sync signal missing, disconnected or out of range.
5	"Initial memory lost"	Power on settings could	Save power on settings again to

Number	Message String	Cause	Remedy
		not be recalled.	overwrite old content.
6	"Limit memory lost"	Hardware configuration settings lost.	Contact CI service department at <a href="mailto:service.ppd@ametek.com">service.ppd@ametek.com</a> to obtain instructions on restoring configuration data.
7	"System memory lost"	Memory corrupted.	Recycle power.
8	"Calibration memory lost"	Calibration data lost.	Contact CI service department at <a href="mailto:service.ppd@ametek.com">service.ppd@ametek.com</a> to obtain instructions on restoring calibration data or recalibrate unit.
9	"Start angle must be first sequence"	Start phase angle in wrong place..	Start phase angles can only be programmed at the start of a transient list. Once a transient is in progress, phase angle cannot be changed.
10	"Illegal for DC"	Operation not possible in DC mode.	Switch to AC or AC+DC mode.
11	"Duplicate sequence"	Transient list sequence number already used.	User new or available sequence number instead.
12	"Too many sequence"	Number of transient list steps exceeds maximum.	Reduce the number of steps in the transient list. (Max = 32 for Series I or 100 for Series II).
13	"Missing list parameter"	One or more transient list parameters missing.	Check programmed lists.
14	"Voltage peak error "	Peak voltage exceeds internal bus voltage	This error may occur when selecting user defined wave shapes with higher crest factors. Reduce programmed RMS value.
15	"Slew time exceed dwell"	Time needed to slew to final value is less than dwell time.	Check dwell times in transient list settings. Increase dwell time or change slew rate for affected parameter.
16	"Illegal during transient"	Operation requested not available while transient is running.	Wait till transient execution is completed or abort transient execution first.
17	"Output relay must be closed"	Operation not possible with open relay	Close relay before attempting operation. E.g. transient execution requires output relay to be closed.
18	"Trans. duration less than 1msec"	Dwell time below minimum or 1 msec	Increase dwell time to at least 1 msec.
19	"Clock and sync must be internal"	Operation not possible with external clock	Switch to internal sync. (Default)
20	"Input buffer full"	Too much data received.	Break up data in smaller blocks.
21	"EOS Fault"	Hardware error reported by EOS option. This option is not available on RS Series products.	Cycle power on EOS to reset error. If error persists, contact CI service at <a href="mailto:service.ppd@ametek.com">service.ppd@ametek.com</a> for repair.
22	"Waveform harmonics"	Harmonic contents of user	Reduce harmonic content or



Number	Message String	Cause	Remedy
	limit"	defined wave shape are too high and could damage amplifier.	reduce fundamental frequency programmed.
23	"ALC or Impedance must be off"	Conflict between ALC and programmable impedance mode.	Turn off ALC to use programmable impedance. Turn off programmable impedance to use ALC.
24	"Output relay must be open"	Attempting to change voltage range while output relay is closed.	Open output relay first, then change range. This ensures the load is physically disconnected during voltage range change.
25	"Over voltage prot trip"	Over voltage protection trip.	Output voltage exceeds voltage range value. Check sense connections if external sense mode is used.
26	"Peak curr prot trip"	Maximum available peak current capability of power source exceeded. Note: Firmware rev 4.52 or higher.	This error will trip if PONS:CURR:PEAK:PROT status is set to 1 and the peak current drawn by the load exceeds the maximum specified peak current capability for more than 30 seconds. To avoid this error, reduce the load on the power source or upgrade to a larger power configuration.
27	"Frequency error"	Frequency is out of allowable range.	Indicates a problem with programmable controller.
28	"Phase error"	Incorrect phase	
29	"DC component exceeds limit"	The waveform selected contains a DC offset that exceeds the AC mode capability.	Select AC+DC mode.
30	"Amplifier fault"	Amplifier fault.	Contact customer service.
31	"Warning negative power near limit"	Approaching limit on the amount of power that can be fed back into the supply by an active load. This is a warning only.	Stop increasing power feedback into the power supply. Typically occurs when using AC inverters. If power increases further, an error 32 will be generated.
32	"Negative power fault"	Too much power fed back. Power source output disconnected.	Reduce the amount of power being fed back into the power source.

Table 10-1: Error Messages

## Index

<b>+</b>	
+/- key.....	65
<b>1</b>	
160.....	169
<b>7</b>	
704.....	202, 203
<b>A</b>	
ABD0100.1.8.....	101
AC	
input.....	33
Acoustic.....	21, 30
active group.....	107
Arbitrary waveforms	
Frequency response restrictions .....	109
arrow keys .....	63
<b>B</b>	
blinking	
parameter entry .....	63
BNC	
ES connector .....	51
<b>C</b>	
calibration	
password .....	141
calibration factors .....	104
CE <sup>®</sup> mark .....	21
circuit breaker.....	61
clip level.....	87
Clock and Lock	
Initialization .....	56
-LKS configuration .....	100
Clock and Lock mode.....	55
Clock and Lock Mode	
Configuration .....	55
clock mode .....	73
constant current.....	134
Constant Power.....	30
Construction	
internal .....	20
controller assembly .....	131
Controllers	
programmable.....	22
Cooling .....	20
current / voltage sensor.....	134
current limit.....	130
custom waveforms .....	107
creating .....	107
deleting .....	108
downloading .....	108
<b>D</b>	
DC offset.....	73
-HV range.....	168
Dimensions .....	20
DIP switch .....	52
Distorted output .....	157
DO-160 .....	169
DVM .....	134
<b>E</b>	
Efficiency.....	12
Emissions.....	21
error messages .....	220
-ES .....	23
ES option	
BNC.....	51
Ethernet .....	95
External Sync	
Clock/Lock.....	56
<b>F</b>	
FFT	
analysis .....	113
data displays .....	114
Finish	
paint.....	20
firmware	
downloads.....	162
Frequency Range .....	14, 15, 26, 29
front panel.....	61
Front panel	
Lock.....	62
Function Strobe.....	18
Functional Test .....	57
Fuse check.....	158
Fuses	
Input .....	130
<b>G</b>	
GPIB .....	95
<b>H</b>	
-HF .....	23
Hold-Up Time.....	12
-HV	
restrictions.....	168
<b>I</b>	
IEC 1000-4-11.....	100
IEC 61000-4-11	
Edition 1.0 .....	183

Edition 2.0 .....	183	<b>O</b>	
IEEE-488 .....	19, 95	Offset Voltage	
Immunity .....	21	DC .....	13
Inrush Current .....	12	Option	
installation .....	33	-MB .....	52
Introduction.....	11	oscillator.....	130
Isolation Voltage.....	12	output	
<b>J</b>		frequency.....	72
junction box .....	23, 60	junction .....	60
<b>K</b>		voltage.....	72
keypad .....	64	output calibration .....	104
function .....	64	Output Coupling.....	13, 24
Keys		output mode .....	73
ES Option .....	23	OUTPUT ON/OFF key.....	65
knob.....	63	Output Status.....	18
<b>L</b>		over current.....	134
LAN.....	19, 95	Overcurrent.....	20
Configuration .....	93	overload .....	62
connector .....	50	Overtemperature.....	20
MAC Address.....	50	Overvoltage.....	20
Settings.....	93	<b>P</b>	
-LAN option .....	23	Parallel .....	22
LCD display .....	67	password	
LED.....	134, 156	calibration.....	141
LED indicators .....	156	phase angle .....	73
-LF .....	23	PHASE key .....	65
Line Current:.....	12	Power Factor.....	12
Line Frequency.....	12	power-down .....	54
Line VA:.....	12	PROG key.....	64
list transient .....	124	Programming manual .....	11
-LKM .....	23	pulse transient.....	123
-LKS.....	23	<b>R</b>	
Low Voltage PS.....	134	registers .....	86
<b>M</b>		Relay	
MAC Address .....	50	output .....	22
maintenance .....	156	Remote control.....	62
Material		Remote Inhibit.....	59
chassis.....	20	repeat.....	86
-MB .....	23	replacement parts .....	165
MB option .....	52	RJ45	
-MB option .....	52	connector.....	50
-MB Option .....	23	RS232 .....	95
MEAS key.....	64	RS232 connector .....	48
measurement calibration.....	103	RS232C .....	19
MENU key .....	64	RTCA DO160.....	100
MIL/STD-704 .....	100	RTCA/DO-160.....	169
Modulator .....	130	<b>S</b>	
MS704 .....	101	Safety.....	21
Multi-cabinet .....	52	sense .....	156
<b>N</b>		wiring .....	38
Noise .....	13	SET key .....	65
		SET mode .....	63

Shock.....	21	input BNC.....	18
Short Circuit		output BNC.....	18
current.....	20	troubleshooting .....	156
shutdown .....	54	Turn on.....	54
shuttle .....	63		
SET mode.....	63	<b>U</b>	
Shuttle		UP key .....	66
IMMEDIATE mode.....	63	USB.....	19, 95
slew rates .....	126	connector.....	49
-SNK.....	23		
SNK option .....	217	<b>V</b>	
status .....	62	Vibration.....	21
step transient.....	122	viewing angle .....	22, 94
system interconnect .....	129	volt mode .....	73
System Interface .....	134	voltage drop	
		cables.....	36, 39
<b>T</b>		voltage rating .....	31
temperature			
over.....	62	<b>W</b>	
Temperature		WAVE key.....	64
operating,storage.....	20	waveform	
Three phase .....	130	data displays .....	116
top cover		Waveform	
removal .....	158	acquisition .....	115
transient		waveform group .....	98
execution .....	128	Weight.....	20
transient execution .....	86	WHM.....	100
transients		Wire Sizes.....	36, 39
list.....	124	wiring	
pulse .....	123	input.....	33
slew rate .....	126		
step .....	122	<b>X</b>	
switching waveforms.....	127	-XV range	
Transients		restrictions.....	168
Input.....	20		
Trigger			