

Lx \ Ls Series AC Power Source User Manual



Contact Information

Telephone: 800 733 5427 (toll free in North America)

858 450 0085 (direct)

Fax: 858 458 0267

Email:

Domestic Sales: domorders.sd@ametek.com

International Sales: intlorders.sd@ametek.com

Customer Service: service.ppd@ametek.com

Web: www.programmablepower.com

Refers to Lx Series AC Power Source/Analyzers and Ls Series AC Power Sources.

Models:

Single chassis: 3000Lx, 4500Lx, 6000Lx
Multiple chassis: 9000Lx/2, 12000Lx/2, 13500Lx/3, 18000Lx/3

Single chassis: 3000Ls, 4500Ls, 6000Ls
Multiple chassis: 9000Ls/2, 12000Ls/2, 13500Ls/3, 18000Ls/3

Manual revision: H, March 2011

About AMETEK

AMETEK Programmable Power, Inc., a Division of AMETEK, Inc., is a global leader in the design and manufacture of precision, programmable power supplies for R&D, test and measurement, process control, power bus simulation and power conditioning applications across diverse industrial segments. From bench top supplies to rack-mounted industrial power subsystems, AMETEK Programmable Power is the proud manufacturer of Elgar, Sorensen, California Instruments and Power Ten brand power supplies.

AMETEK, Inc. is a leading global manufacturer of electronic instruments and electromechanical devices with annualized sales of \$2.5 billion. The Company has over 11,000 colleagues working at more than 80 manufacturing facilities and more than 80 sales and service centers in the United States and around the world.

Trademarks

AMETEK is a registered trademark of AMETEK, Inc.

Other trademarks, registered trademarks, and product names are the property of their respective owners and are used herein for identification purposes only.

Notice of Copyright

Lx|Ls Series AC Power Source, User Manual © 2010 AMETEK Programmable Power, Inc. All rights reserved.

Exclusion for Documentation

UNLESS SPECIFICALLY AGREED TO IN WRITING, AMETEK PROGRAMMABLE POWER, INC. ("AMETEK"):

- (a) MAKES NO WARRANTY AS TO THE ACCURACY, SUFFICIENCY OR SUITABILITY OF ANY TECHNICAL OR OTHER INFORMATION PROVIDED IN ITS MANUALS OR OTHER DOCUMENTATION.
- (b) ASSUMES NO RESPONSIBILITY OR LIABILITY FOR LOSSES, DAMAGES, COSTS OR EXPENSES, WHETHER SPECIAL, DIRECT, INDIRECT, CONSEQUENTIAL OR INCIDENTAL, WHICH MIGHT ARISE OUT OF THE USE OF SUCH INFORMATION. THE USE OF ANY SUCH INFORMATION WILL BE ENTIRELY AT THE USER'S RISK, AND
- (c) REMINDS YOU THAT IF THIS MANUAL IS IN ANY LANGUAGE OTHER THAN ENGLISH, ALTHOUGH STEPS HAVE BEEN TAKEN TO MAINTAIN THE ACCURACY OF THE TRANSLATION, THE ACCURACY CANNOT BE GUARANTEED. APPROVED AMETEK CONTENT IS CONTAINED WITH THE ENGLISH LANGUAGE VERSION, WHICH IS POSTED AT WWW.PROGRAMMABLEPOWER.COM.

Date and Revision

March 2011 Revision H

Part Number

7004-960



Contact Information

Telephone: 800 733 5427 (toll free in North America)
858 450 0085 (direct)
Fax: 858 458 0267
Email: sales@programmablepower.com
service@programmablepower.com
Web: www.programmablepower.com

This page intentionally left blank.

Important Safety Instructions

Before applying power to the system, verify that your product is configured properly for your particular application.

	<p>Hazardous voltages may be present when covers are removed. Qualified personnel must use extreme caution when servicing this equipment. Circuit boards, test points, and output voltages also may be floating above (below) chassis ground.</p>
	<p>The equipment used contains ESD sensitive ports. When installing equipment, follow ESD Safety Procedures. Electrostatic discharges might cause damage to the equipment.</p>

Only *qualified personnel* who deal with attendant hazards in power supplies, are allowed to perform installation and servicing.

Ensure that the AC power line ground is connected properly to the Power Rack input connector or chassis. Similarly, other power ground lines including those to application and maintenance equipment *must* be grounded properly for both personnel and equipment safety.

Always ensure that facility AC input power is de-energized prior to connecting or disconnecting any cable.

In normal operation, the operator does not have access to hazardous voltages within the chassis. However, depending on the user's application configuration, **HIGH VOLTAGES HAZARDOUS TO HUMAN SAFETY** may be normally generated on the output terminals. The customer/user must ensure that the output power lines are labeled properly as to the safety hazards and that any inadvertent contact with hazardous voltages is eliminated.

Guard against risks of electrical shock during open cover checks by not touching any portion of the electrical circuits. Even when power is off, capacitors may retain an electrical charge. Use safety glasses during open cover checks to avoid personal injury by any sudden component failure.

Neither AMETEK Programmable Power Inc., San Diego, California, USA, nor any of the subsidiary sales organizations can accept any responsibility for personnel, material or inconsequential injury, loss or damage that results from improper use of the equipment and accessories.

SAFETY SYMBOLS



WARNING
Risk of Electrical Shock



CAUTION
Refer to Accompanying Documents



Off (Supply)



Direct Current (DC)



Standby (Supply)



Alternating Current (AC)



On (Supply)



Three-Phase Alternating Current



Protective Conductor Terminal



Earth (Ground) Terminal



Fuse



Chassis Ground

Product Family: Lx \ Ls Series

Warranty Period: One Year

WARRANTY TERMS

AMETEK Programmable Power, Inc. ("AMETEK"), provides this written warranty covering the Product stated above, and if the Buyer discovers and notifies AMETEK in writing of any defect in material or workmanship within the applicable warranty period stated above, then AMETEK may, at its option: repair or replace the Product; or issue a credit note for the defective Product; or provide the Buyer with replacement parts for the Product.

The Buyer will, at its expense, return the defective Product or parts thereof to AMETEK in accordance with the return procedure specified below. AMETEK will, at its expense, deliver the repaired or replaced Product or parts to the Buyer. Any warranty of AMETEK will not apply if the Buyer is in default under the Purchase Order Agreement or where the Product or any part thereof:

- is damaged by misuse, accident, negligence or failure to maintain the same as specified or required by AMETEK;
- is damaged by modifications, alterations or attachments thereto which are not authorized by AMETEK;
- is installed or operated contrary to the instructions of AMETEK;
- is opened, modified or disassembled in any way without AMETEK's consent; or
- is used in combination with items, articles or materials not authorized by AMETEK.

The Buyer may not assert any claim that the Products are not in conformity with any warranty until the Buyer has made all payments to AMETEK provided for in the Purchase Order Agreement.

PRODUCT RETURN PROCEDURE

1. Request a Return Material Authorization (RMA) number from the repair facility (**must be done in the country in which it was purchased**):
 - **In the USA**, contact the AMETEK Repair Department prior to the return of the product to AMETEK for repair:
Telephone: 800-733-5427, ext. 2295 or ext. 2463 (toll free North America)
858-450-0085, ext. 2295 or ext. 2463 (direct)
 - **Outside the United States**, contact the nearest Authorized Service Center (ASC). A full listing can be found either through your local distributor or our website, www.programmablepower.com, by clicking Support and going to the Service Centers tab.
2. When requesting an RMA, have the following information ready:
 - Model number
 - Serial number
 - Description of the problem

NOTE: Unauthorized returns will not be accepted and will be returned at the shipper's expense.

NOTE: A returned product found upon inspection by AMETEK, to be in specification is subject to an evaluation fee and applicable freight charges.

Table of Contents

1. Introduction	9
1.1 General Description	9
1.2 Lx Series and Ls Series Differences	9
1.3 Manual organization and format	10
2. Specifications	11
2.1 Electrical	11
2.2 Mechanical	22
2.3 Environmental	22
2.4 Front Panel Controls	23
2.5 Special Features	23
2.6 Available Options – Lx Series	24
2.7 Available Options – Ls Series	30
3. Unpacking and Installation	35
3.1 Unpacking	35
3.2 Power Requirements	35
3.3 Mechanical Installation	35
3.4 AC Input Wiring - INPUT	38
3.5 Output Connections	38
3.6 Connectors - Rear Panel	44
3.7 Basic Initial Functional Test	49
3.8 Multi-box Configurations (-MB Option)	51
3.9 Clock and Lock Mode (-LKM/-LKS Option)	52
4. Front Panel Operation	54
4.1 Tour of the Front Panel	54
4.2 Menu Structure	60
4.3 Output Programming	80
4.4 Waveform Management	82
4.5 Measurements	85
4.6 Harmonic Analysis	86
4.7 Transient Programming	86
4.8 Setting the Power-on Initialization Values	91
4.9 Remote Inhibit Function	92
5. Principle of Operation	93
5.1 Overall Description	93
5.2 Controller Assembly	93
6. Calibration	95
6.1 Recommended Calibration Equipment	95
6.2 Calibration Screens	95
6.3 Measurement Calibration	96
6.4 Output Calibration	97
6.5 Phase Offset Calibration	98
6.6 Non-Routine Output Gain Calibration	99
6.7 Non-Routine Amplifier Balance Adjustment	101

7. Service.....	102
7.1 Cleaning.....	102
7.2 General.....	102
7.3 Basic operation.....	102
7.4 Isolating amplifier failures in multi-box systems.....	104
7.5 Advanced Troubleshooting.....	105
7.6 Factory Assistance.....	105
7.7 Fuses.....	105
7.8 Replaceable Parts.....	106
8. Option -160: RTCA / DO-160D.....	108
8.1 General.....	108
8.2 Initial Setup.....	108
8.3 Tests Performed.....	108
8.4 Front Panel Operation -160.....	109
8.5 Normal State tests.....	110
8.6 EMERGENCY TEST.....	118
8.7 ABNORMAL TEST.....	120
9. Option -704: MIL-STD 704 Rev D through F (MIL704 Mode).....	123
9.1 General.....	123
9.2 Initial Setup.....	123
9.3 Test Revision.....	123
9.4 Tests Performed.....	124
9.5 Front Panel Operation MIL704.....	125
9.6 Steady State Tests.....	126
9.7 EMERGENCY TEST.....	129
9.8 ABNORMAL TEST.....	130
10. Option -704F: MIL-STD 704 Rev A through F (MS704 mode).....	132
10.1 General.....	132
10.2 Initial Setup.....	132
10.3 Test Revision.....	132
10.4 Test Standard Reference.....	133
10.5 Available Tests.....	133
10.6 Front Panel Operation MS704.....	135
10.7 Test Steps and Execution Times Summary.....	138
10.8 MS704 Operation Using the LxGui Software.....	185
11. Error Messages.....	193
12. Index.....	199

List of Figures

Figure 2-1: 3000Lx Voltage / Current Rating Chart for 150V AC Range in 3 phase mode.	16
Figure 2-2: 4500Lx Voltage / Current Rating Chart for 150V AC Range in 3 phase mode.	17
Figure 2-3: 6000Lx Voltage / Current Rating Chart for 150V AC Range in 3 phase mode.	17
Figure 2-4: 3000Ls Voltage / Current Rating Chart for 135V AC Range in 3 phase mode.	18
Figure 2-5: 4500Ls Voltage / Current Rating Chart for 135V AC Range in 3 phase mode.	18
Figure 2-6: 6000Ls Voltage / Current Rating Chart for 135V AC Range in 3 phase mode.	19
Figure 3-1: Rear Panel Connector Locations – Lx Series	36
Figure 3-2: Rear Panel Connector Locations – Ls Series	37
Figure 3-3: 9000Lx/2 and 9000Ls/2 Output Wiring	41
Figure 3-4: 9000Lx/2, 9000Ls/2, 12000Lx/2 or 12000Ls/2 Wiring diagram - 3 Phase mode	42
Figure 3-5: 13500Lx/2, 13500Ls/3, 18000Ls/3 or 18000Ls/3 Wiring diagram - 3 Phase mode	43
Figure 3-6: Clock and Lock Connections	53
Figure 4-1: Shuttle Knob	56
Figure 4-2: Menu Keys	57
Figure 4-3: Measurement Screen	59
Figure 4-4: PROGRAM Menu	63
Figure 4-5: CONTROL Menus	64
Figure 4-6: MEASUREMENT Screen	68
Figure 4-7: Selecting a Waveform	82
Figure 4-8: Selecting Waveforms for Single Phase or All Phases	82
Figure 4-9: Waveform Crest Factor Affects Max. rms Voltage	83
Figure 4-10: Pulse Transients	87
Figure 4-11: List Transients	87
Figure 4-12: Sample Transient Output Sequence	89
Figure 4-13: Switching Waveforms in a Transient List	90
Figure 4-14: TRANSIENT Menu	90
Figure 6-1: Location of Gain pot adjustments	99
Figure 8-1: Application Menu	109
Figure 8-2: DO160 Main Menu	109
Figure 8-3: Normal state screens	110
Figure 8-4: Voltage Modulation - Frequency characteristics	113
Figure 8-5: Frequency Modulation	114
Figure 8-6: Power Interrupt	115
Figure 8-7: Power Interrupt for Group2/A(NF) and Group3/A(WF)	116
Figure 8-8: Emergency Screens	118
Figure 8-9: Abnormal Screen	120
Figure 9-1: Applications Menu	125
Figure 9-2: MIL704 Menu	125
Figure 9-3: Steady State Menu	126
Figure 9-4: Emergency Menu	129
Figure 9-5: Abnormal Screens	130
Figure 10-1: Applications Menu	135
Figure 10-2: MIL704 Run/Status	135
Figure 10-3: Mil704 Run/Status	135
Figure 10-4: Revision/Group Menu	136
Figure 10-5: Test selection Menu	136
Figure 10-6: Section and Test Condition	137
Figure 10-7: Steady State frequency	137
Figure 10-8: Required SAC-106 Test Setup	140
Figure 10-9: Required TAC-106 Test Setup	153
Figure 10-10: Required SVF-106 Test Setup	166
Figure 10-11: Required TVF-106 Test Setup	174
Figure 10-12: Required SXF-106 Test Setup	181
Figure 10-13: LxGui MS704 Option Screen	186
Figure 10-14: LxGui MS704 Option EUT Performance Test Screen - Measurements	187
Figure 10-15: LxGui MS704 Option EUT Performance Test Screen - Waveforms	189

List of Tables

Table 3-1: Output Terminal connections.....	40
Table 3-2: Rear Panel Connectors	45
Table 3-3: AC Input Terminal Block Connection Description	45
Table 3-4: SMA Connectors – Lx Series.....	46
Table 3-5: SMA Connectors – Ls Series.....	46
Table 3-6: BNC Connectors.....	47
Table 3-7: External Sense Connector	47
Table 3-8: RS232C Connector.....	47
Table 3-9: Full Load Resistance – Lx Series	50
Table 3-10: Full Load Resistance – Ls Series	50
Table 4-1: Menu Tree.....	63
Table 4-2: Sample Transient List.....	89
Table 4-3: Factory Default Power on Settings	91
Table 4-4: Factory Default Power on Settings	92
Table 6-1: Calibration Load Values- Single-chassis configurations.....	96
Table 6-2: Calibration Load Values- Multi-chassis configurations	96
Table 6-3: Output Calibration Coefficients - Factory Defaults.....	97
Table 6-4: Output Calibration Coefficients - Factory Defaults.....	100
Table 6-5: Amplifier balance adjustments.....	101
Table 7-1: Basic Symptoms	102
Table 7-2: Replaceable Parts and Assemblies	107
Table 8-1: Normal Voltage and Frequency minimum	111
Table 8-2: Normal Voltage and Frequency Maximum	111
Table 8-3: Normal Voltage Unbalance.....	112
Table 8-4: Airbus mode voltage modulation.	112
Table 8-5: Normal VoltageSurge Sequence	116
Table 8-6: Normal Frequency Transient Sequence	117
Table 8-7: Normal Frequency Variation Sequence	117
Table 8-8: Emergency Voltage and Frequency Minimum	118
Table 8-9: Emergency Voltage and Frequency Maximum	118
Table 8-10: Emergency Voltage Unbalance	119
Table 8-11: Abnormal Voltage Minimum.....	120
Table 8-12: Abnormal Voltage Maximum.....	120
Table 8-13: Abnormal Voltage Unbalance	121
Table 8-14: Abnormal Frequency Transient.....	122
Table 9-1: Steady state voltage	126
Table 9-2: Steady state frequency	127
Table 9-3: Frequency Modulation	127
Table 9-4: Abnormal Over Frequency.....	131
Table 9-5: Abnormal Under Frequency.....	131
Table 10-1: DO160 Test Groups.....	133
Table 10-2: Test Selections	136
Table 10-3: Steady state frequency	137
Table 11-1: Error Messages.....	198

1. Introduction

This instruction manual contains information on the installation, operation, calibration and maintenance of the Lx Series and Ls Series AC power sources.

1.1 General Description

The Lx Series of AC Power Source is a family of high efficiency, rack mountable, AC Power Source/Analyzer combinations that provide a precise output with low distortion and advanced measurements. Standard output voltage ranges are 150 Vac and 300 Vac RMS. The Lx Series can operate in either single or three-phase mode.

The Ls Series of AC Power Source is a family of high efficiency, rack mountable, AC Power Sources that provide a precise output with low distortion. Standard output voltage ranges are 135 Vac and 270 Vac RMS. The Ls Series is available in either single (-1) or three-phase mode (3). A –MODE option is available on –3 Ls models.

For power levels above 4500 VA, two or more Lx or Ls series units can be combined using the system interface in a parallel mode of operation. These multi chassis systems consist of one master unit with controller and one or two auxiliary units without controllers. Only the master unit has a front panel keyboard and display.

Read the installation instructions carefully before attempting to install and operate the Lx / Ls Series power systems.

1.2 Lx Series and Ls Series Differences

The Lx Series and Ls Series of AC power sources are both based on the same AC power source hardware platform and share many common components. The differences are primarily in configuration and options. This manual covers both model series. Some menus and screen shown in this manual may not apply to Ls Series AC sources without the –ADV option and / or –MODE option.

1.2.1 Firmware differences

The Lx Series is fully featured and supports all commands listed in the programming manual.

The Ls Series provides most basic functions in its standard configurations. More advanced features can be added by specifying the –ADV (advanced) option. If the –ADV option is installed, all commands listed in this programming manual are supported. If not, commands related to arbitrary waveforms and harmonic analysis measurements are not supported and will generate a “-113 Syntax Error” message.

1.2.2 Hardware differences

In addition to the firmware differences described, the following hardware differences exist between the standard Lx Ac source and the Ls AC source.

- Lx has a 150V / 300 V rms output range pair. Optional ranges of 135/270 (-HV option) and 200/400 (-EHV option) are available at time of order.
- Ls has a 135 V / 270 V rms output range pair. Optional ranges of 156/312 (-HV option) and 200/400 (-EHV option) are available at time of order.
- The Lx rear panel connector labeling is compliant with the California Instruments iL Series which it replaces and the HP/Agilent model 6834B.

- The Ls rear panel connector labeling is compliant with the California Instruments L Series.
- The Lx Series comes standard with both GPIB and RS232C interfaces.
- The Ls Series comes standard with an RS232C only, An optional GPIB interface (-GPIB option) is available.

Note: Both interfaces use the SCPI command syntax as described in the programming manual.

- The Lx Series provides both three phase and single phase output modes which can be selected from the front panel or over the bus.
- The Ls Series provides either three phase (-3 models) or single phase (-1 models). Three phase Ls Series sources may optionally be equipped with the -MODE option which provides the same phase mode switching as the Lx Series.

1.3 Manual organization and format

All user documentation for California Instruments power sources is provided on CDROM in electronic format. (Adobe Portable Document Format) The required Adobe PDF viewer is supplied on the same CDROM. This manual may be printed for personal use if a hardcopy is desired. To request a hardcopy from California Instruments, contact customer service at support@calinst.com. There will be an additional charge for printed manuals.

This manual contains sections on installation, normal use, maintenance and calibration. The Lx Series is equipped with both GPIB and RS232C interfaces. The Ls Series is equipped with a RS232C interface. An optional GPIB interface can be specified at the time of order. Refer to the Lx / Ls Series Programming manual for information on using the remote control interface and command syntax. The programming manual (P/N 7004-961) is provided on the same CDROM as this user manual.

California Instruments may make updated versions of this manual available from time to time in electronic format through it's website. To obtain an updated manual revision if available, check the California Instruments Manual download page at www.calinst.com. You need to register as a customer to obtain free access to manual and software downloads.

2. Specifications

Specifications shown are valid over an ambient temperature range of $25 \pm 5^\circ \text{C}$ and apply after a 30 minute warm-up time. Unless otherwise noted, all specifications are per phase for sine wave output into a resistive load. For three phase configurations or mode of operation, all specifications are for Line to Neutral (L-N) and phase angle specifications are valid under balanced load conditions only.

Specifications for Ls models are identical to those for the Lx except where noted.

2.1 Electrical

2.1.1 Input

Parameter	Specification	
Line Voltage: (3 phase, 3 wire + ground (PE))	3000Lx, 4500Lx, 9000Lx/2, 13500Lx/3: Std: 208 - 230 VLL $\pm 10\%$ -400: 400 V _{LL} $\pm 10\%$ 6000Lx, 12000Lx/2, 18000Lx/3: Std: 208 - 230 VLL + 10% ¹	Note: Each Lx/ Ls chassis requires its own AC service. Note: 3000Lx/Ls may be operated from 208-230 V L-N single phase AC input between L2 and L3 on TB3 for 3000Lx or ØB- ØC on TB3 for 3000Ls.
Line VA: (total)	3000Lx / Ls 5900 VA / 4100 W 4500Lx / Ls 8900 VA / 5900 W (x2 for 9000Lx/2, x3 for 13500Lx/3) 6000Lx / Ls 11900 VA / 7900 W (x2 for 12000Lx/2, x3 for 18000Lx/3)	
Line Current: (per phase)	3000Lx / Ls Std: 19 Arms @ 187 VLL, 3 phase AC input. [32 Arms @ 187 VLN single phase AC input. Connect between TB3 L2-L3 on 3000Lx or TB3 ØB- ØC on 3000Ls] -400: 10 Arms @ 360 VLL, 3 phase AC input. 4500Lx / Ls Std: 31 Arms @ 187 VLL -400: 16 Arms @ 360 VLL 6000Lx / Ls Std: 38 Arms @ 208 VLL Currents shown are for single chassis models. For multi-chassis configurations, currents are per chassis.	

¹ Note that operation below 208V L-L AC input is available with the following derating considerations:

- 1) If operating at less than a 5000 VA output power there will be no affect on the output.
- 2) If operating in 3-phase mode, with a full-scale output voltage and a frequency less than three times the line frequency, the voltage distortion may exceed specification between 5500 and 6000 VA output.
- 3) If operating in 1-phase mode above 5000 VA, above 85% of full-scale output voltage and an output frequency less than three times the line frequency, the voltage distortion may exceed specification and the output may fault with a crest factor load more than 2.

In most applications, these conditions are not likely to exits. At AC input voltages of 208 V or higher, the 6000Lx/Ls meets specifications under all conditions.

Parameter	Specification	
Line Frequency:	47-440 Hz	
Efficiency:	75 % (typical) depending on line and load	
Power Factor:	0.65 (typical)	
Inrush Current:	50 A _{pk} @ 253V _{LL} per chassis 83 A _{pk} @ 400 V _{LL} per chassis	Note: Each Lx chassis requires its own AC service.
Hold-Up Time:	> 10 ms	
Isolation Voltage:	300 VAC RMS input to output 1350 VAC input to chassis	

2.1.2 Output

Output Parameter	Specification					
Modes	AC					
Voltage:						
Ranges (L-N):	Lx Series			Ls Series		
Low range	0 - 150 Vrms			0 - 135 Vrms		
High range	0 - 300 Vrms			0 - 270 Vrms		
Resolution:	0.1 V			0.1 V		
Programming Accuracy:	± (0.05% + 0.25 V) from 5V to FS.					
Distortion THD ¹ :	Standard: < 1 % [45 - 1000 Hz] < 1 % + 1%/kHz [> 1000 Hz] (harmonics and noise to 300 kHz) With –HF and –LKM option: < 2 % [45 - 1000 Hz] < 2 % + 1%/kHz [> 1000 Hz] (harmonics and noise to 300 kHz)					
Load Regulation: ALC mode ON	0.1 % FS					
External Sense	Up to 10Vrms can be dropped across each load lead Fout < 400 Hz. Up 2.5 Vrms can be dropped across each load lead Fout > 400 Hz Internal or External sense selectable.					
Line Regulation:	0.02% for 10% input line change					
DC Offset Voltage:	0.0 V					
Output Noise: (20 kHz to 1 MHz)	< 100 mV _{RMS} typical					
Output Coupling	Transformer coupled					
Output Impedance (Z)	$Z = V_{range} * 0.001 / I_{load}$					
Power – Lx Series (total power for all phases, either range, at full scale voltage)						
	35° C Ambient			50° C Ambient		
Model	3000Lx	4500Lx	6000Lx	3000Lx	4500Lx	6000Lx
Single Phase Mode	3 KVA	4.5 KVA	5.76 KVA	3 KVA	4 KVA	5 KVA
Three Phase Mode (per phase)	1 KVA	1.5 KVA	1.9 KVA	1 KVA	1.35 KVA	1.7 KVA
Model		9000Lx/2	12000Lx/2		9000Lx/2	12000Lx/2
Single Phase Mode		9 KVA	11.5 KVA		8 KVA	10 KVA
Three Phase Mode (per phase)		3 KVA	3.8 KVA		2.7 KVA	3.3 KVA
Model		13500Lx/3	18000Lx/3		13500Lx/3	18000Lx/3

¹ The distortion specification for the Lx Series applies at full-scale voltage, full resistive load conditions.

Output Parameter	Specification					
Single Phase Mode		13.5 KVA	5.76 KVA		12 KVA	15 KVA
Three Phase Mode (per phase)		4.5 KVA	17.3 KVA		4 KVA	5 KVA
Power – Ls Series (total power for all phases, either range, at full scale voltage)						
	35° C Ambient			50° C Ambient		
Model	3000Ls	4500Ls	6000Ls	3000Ls	4500Ls	6000Ls
Single Phase Mode	3 KVA	4.5 KVA	6 KVA	3 KVA	4 KVA	5 KVA
Three Phase Mode (per phase)	1 KVA	1.5 KVA	2 KVA	1 KVA	1.35 KVA	1.7 KVA
Model		9000Ls/2	12000Ls/2		9000Ls/2	12000Ls/2
Single Phase Mode		9 KVA	12 KVA		8 KVA	10 KVA
Three Phase Mode (per phase)		3 KVA	4 KVA		2.7 KVA	3.3 KVA
Model		13500Ls/3	18000Ls/3		13500Ls/3	18000Ls/3
Single Phase Mode		13.5 KVA	6 KVA		12 KVA	15 KVA
Three Phase Mode (per phase)		4.5 KVA	18 KVA		4 KVA	5 KVA
Maximum Current at Full Power – Lx Series						
<p>Note: Current, maximum amps per phase available at on low voltage range. 3000Lx and 4500Lx operate in constant power mode up to currents shown at reduced voltage. See Figure 2-1. For 9000Lx/2 and 12000Lx/2, currents are 2 x 4500Lx and 6000Lx. For 13500Lx/3 and 18000Lx/3, currents are 3 x 4500Lx and 6000Lx</p>						
Model	3000Lx	4500Lx	6000Lx			
Single Phase Mode: Max. RMS, low Vrange	38.4 A	38.4 A	38.4 A			
Three Phase Mode: Max. RMS, low Vrange per phase	12.8 A	12.8 A	12.8 A			
<p>Note: Current derates linearly from 50% of voltage range to 20% of specified current at 10% of voltage range. Current in High voltage range is reduced by a factor of 2.</p> <p>Note: For 9000Lx/2 and 12000Lx/2, currents are 2 x 4500Lx and 6000Lx. For 13500Lx/3 and 18000Lx/3, currents are 3 x 4500Lx and 6000Lx</p>						
Maximum Current at Full Power – Ls Series						
<p>Note: Current, maximum amps per phase available at on low voltage range. 3000Ls and 4500Ls operate in constant power mode up to currents shown at reduced voltage. See Figure 2-1. For 9000Ls/2 and 12000Ls/2, currents are 2 x 4500Ls and 6000Ls. For 13500Ls/3 and 18000Ls/3, currents are 3 x 4500Ls and 6000Ls</p>						
Model	3000Ls	4500Ls	6000Ls			
Single Phase Mode: Max. RMS, low Vrange	44.4 A	44.4 A	44.4 A			
Three Phase Mode: Max. RMS, low Vrange per phase	14.8 A	14.8 A	14.8 A			
<p>Note: Current derates linearly from 50% of voltage range to 20% of specified current at 10% of</p>						

Output Parameter	Specification		
	voltage range. Current in High voltage range is reduced by a factor of 2.		
Note:	For 9000Ls/2 and 12000Ls/2, currents are 2 x 4500Ls and 6000Ls. For 13500Ls/3 and 18000Ls/3, currents are 3 x 4500Ls and 6000Ls		
Maximum Current at Full Scale Voltage – Lx Series			
Model	3000Lx	4500Lx	6000Lx
Single Phase Mode: Max. RMS, low Vrange	20 A	30 A	38.4 A
Three Phase Mode: Max. RMS, low Vrange per phase	6.67 A	10 A	12.8 A
Current Limit mode	Programmable, CC or CV mode		
Maximum Current at Full Scale Voltage – Ls Series			
Model	3000Ls	4500Ls	6000Ls
Single Phase Mode: Max. RMS, low Vrange	22.2 A	33.3 A	44.4 A
Three Phase Mode: Max. RMS, low Vrange per phase	7.4 A	11.1 A	14.8 A
Current Limit mode	Programmable, CC or CV mode		
Repetitive Peak Current			
Model	3000Lx / Ls	4500Lx / Ls	6000Lx / Ls
Max. Peak Current:	6 x RMS current at FS	4 x RMS current at FS	3 x RMS current at FS
Note:	For 9000Lx / Ls /2 and 12000Lx / Ls /2, currents are 2 x 4500Lx/Ls and 6000Lx/Ls. For 13500Lx / Ls/3 and 18000Lx / Ls /3, currents are 3 x 4500Lx/Ls and 6000Lx/Ls		
Frequency			
Range:	45 Hz - 1000 Hz		
Resolution ¹ :	0.01 Hz	[< 81.91 Hz]	
	0.1 Hz	[> 82.0 to 819.1 Hz]	
	1 Hz ²	[> 819 Hz]	
Accuracy:	± 0.025 %		
Temp. Coefficient	± 5 ppm of value / °C		
Stability:	± 15 ppm of value		
Phase (3 phase mode)			
Range:	Phase B/C relative to phase A 0.0 to 360.0°		
Resolution:	0.1° < 819.1 Hz 0.5° > 819.1 Hz		
Accuracy:	< 1°	[45 Hz - 1000 Hz]	
	< 1° + 1°/kHz	[> 1000 Hz]	

¹ Programming resolution reduced if –LKM-LKS option is installed. See paragraphs 2.6.5 and 2.7.5.

² Programming resolution of 0.5 Hz above 819.1 Hz may be used over the remote control bus with ± 0.5 Hz accuracy.

Note: All output specifications apply below the Current / Voltage rating line shown in the V/I rating charts of section 2.1.2.1 for Lx Series and section 2.1.2.2 for Ls Series. Data is shown for 3-phase mode, low voltage range. For 1-phase mode, multiply current by 3. For high voltage range, divide current by 2 and multiply voltage by 2.

2.1.2.1 Voltage versus Current Rating Charts - Lx Series

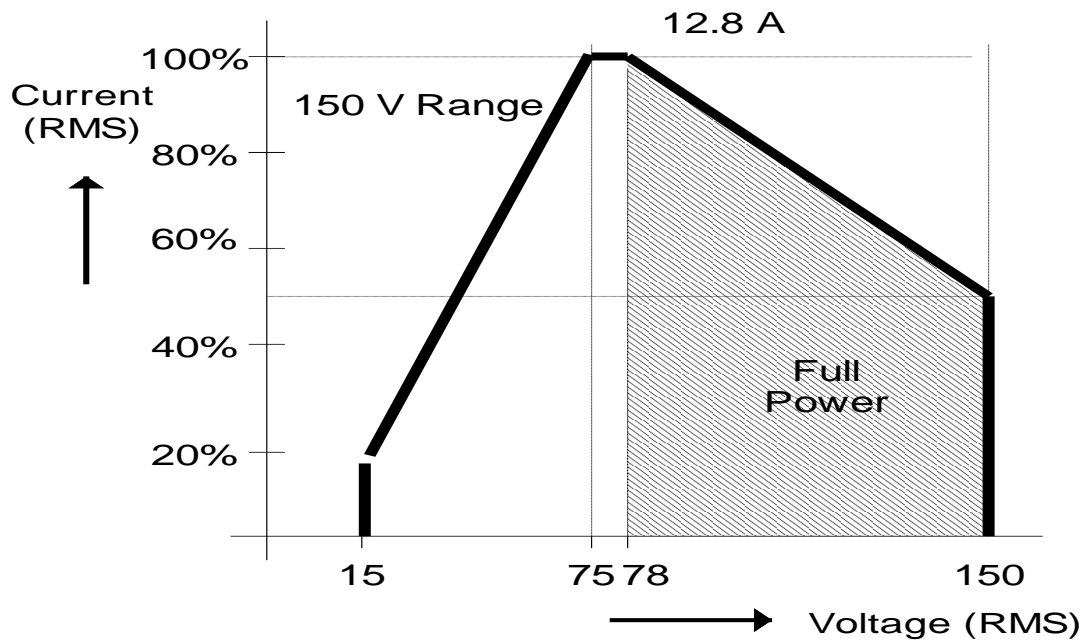

Figure 2-1: 3000Lx Voltage / Current Rating Chart for 150V AC Range in 3 phase mode.

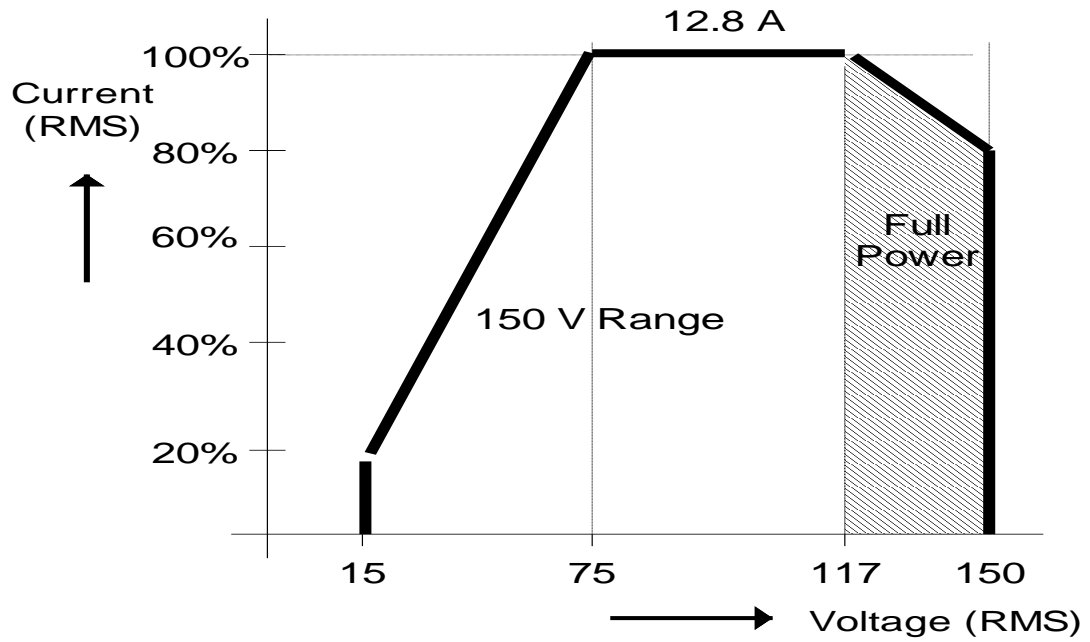

Figure 2-2: 4500Lx Voltage / Current Rating Chart for 150V AC Range in 3 phase mode.

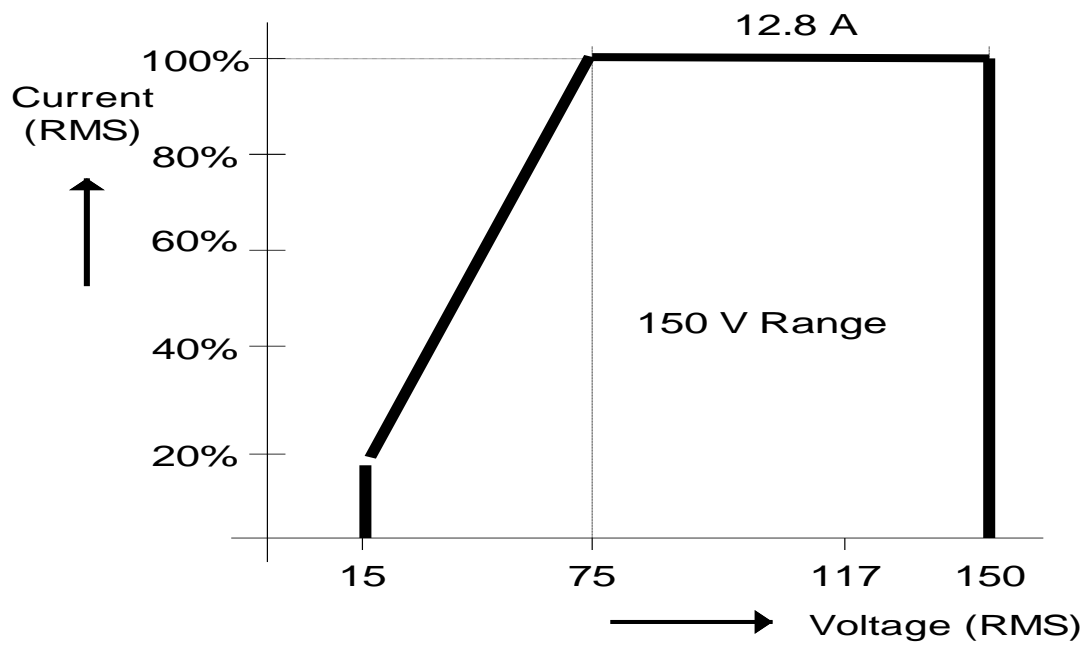

Figure 2-3: 6000Lx Voltage / Current Rating Chart for 150V AC Range in 3 phase mode.

2.1.2.2 Voltage versus Current Rating Charts - Ls Series

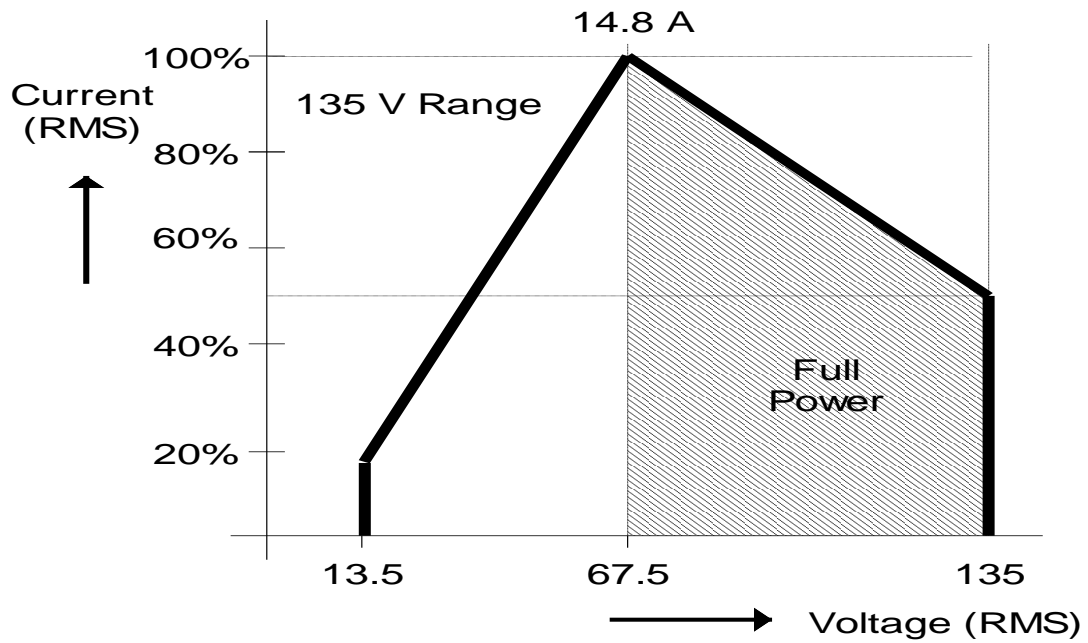

Figure 2-4: 3000Ls Voltage / Current Rating Chart for 135V AC Range in 3 phase mode.

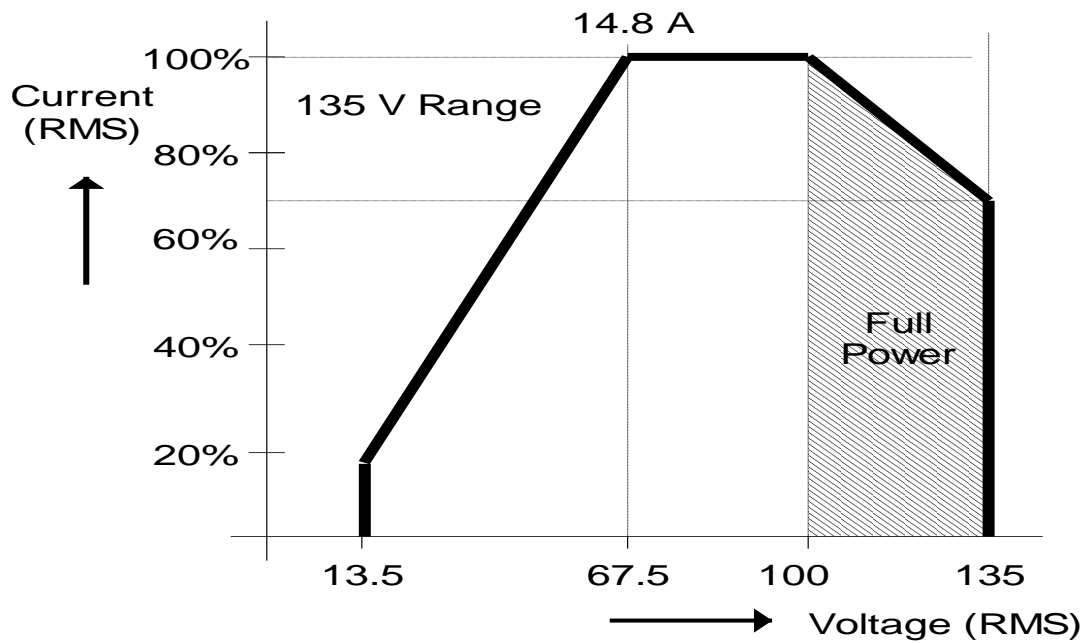

Figure 2-5: 4500Ls Voltage / Current Rating Chart for 135V AC Range in 3 phase mode.

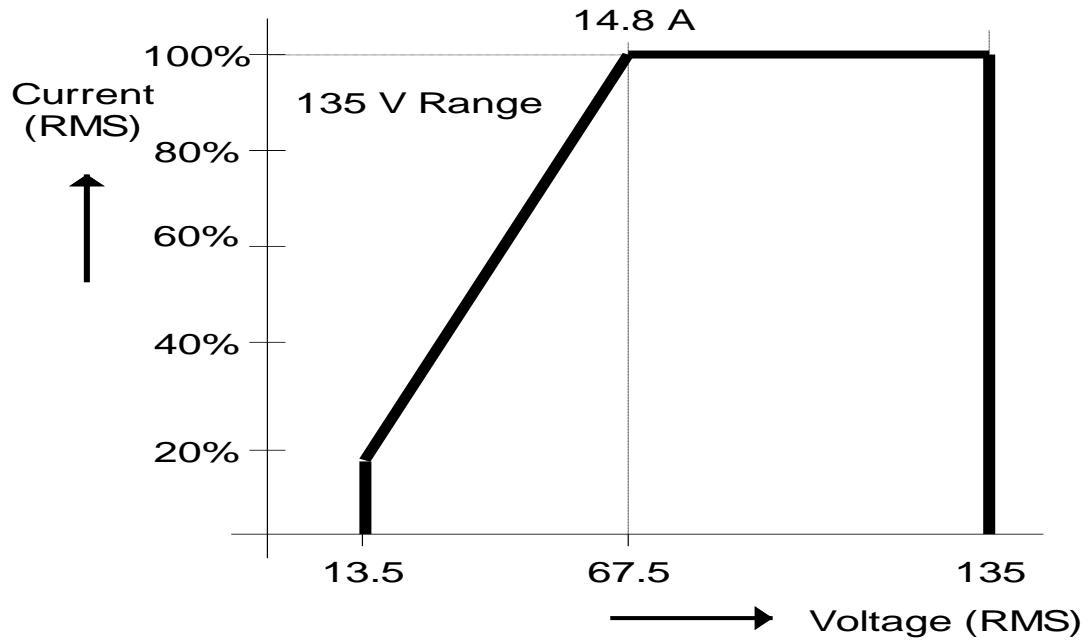

Figure 2-6: 6000Ls Voltage / Current Rating Chart for 135V AC Range in 3 phase mode.

2.1.3 AC Measurements

Measurement specifications apply to single chassis Lx / Ls Series AC source in single or three-phase mode. See notes for other models and configurations.

Parameter	Range	Accuracy (\pm)		Resolution
		1 Phase Mode	3 Phase Mode	
Frequency ¹	45.00-1000.0 Hz	0.1% \pm 1 digit		0.01 Hz to 81.91 Hz 0.1 Hz to 819.1 Hz 1 Hz > 819.1 Hz
Phase	45.00 - 100.0 Hz 100.0 - 1000 Hz	0.5° 2°		0. 1°
RMS Voltage	0 - 400 Volts	0.05% + 0.25V		0.01 Volt
RMS Current	0 - 50 Amps	0.1% + 0.15A	0.1% + 0.05A	0.001 Amp
Peak Current	0 - 150 Amps	0.2% + 0. 5A	0.1% + 0.15A	0.001 Amp
Crest Factor	1.00 – 10.00	1.5 %	1.5 %	0.01
VA Power	0 - 6 KVA	0.15% + 9 VA	0.15% + 3 VA	1 VA
Real Power	0 - 6 KW	0.15% + 9 W	0.15% + 3 W	1 W
Power Factor	0.00 - 1.00	0.03	0.01	0.01

Note: Accuracy specifications are valid above 100 counts. For multi-chassis configurations, Current and Power range and accuracy specifications are times the number of chassis.

Note: Frequency measurement specification valid for output > 20 Vrms.

Note: Crest Factor accuracy applies for Irms > 50% of max.

Note: Power Factor accuracy applies for PF > 0.5 and VA > 50% of max.

2.1.4 Harmonic Measurements

Harmonic measurement specifications apply to Lx Series or Ls Series –3 with –ADV option AC sources in three-phase mode. See notes for single-phase mode or Ls –1 with –ADV option.

Parameter	Range	Accuracy (\pm)	Resolution
Frequency fundamental	45.00 - 81.91 Hz 82.0 - 819.1 Hz > 819.1 Hz	0.1% \pm 1 digit	0.01 Hz 0.1 Hz 1 Hz
Frequency harmonics	45.00 Hz – 16 kHz	0.1% + 2 digits	0.1 Hz
Voltage			
Fundamental	0 - 400 Volts	0.05% + 0.25V	0.01V
Harmonic 2 - 50		0.1% + 0.1%/kHz + 0.25	0.01V
Current			
Fundamental	0 - 20 Amps	0.1% + 0.05A	0.01A
Harmonic 2 - 50		0.1% + 0.1%/kHz + 0.05A	0.01A

Note: Current range and accuracy specifications are times three in single-phase mode. For multi-chassis configurations, current accuracy specifications are times the number of chassis.

¹ Frequency measurement specifications valid with output voltage of 30Vrms or higher. If output relay is open, frequency measurement will return 0.0 Hz.

2.1.5 System Specification

Parameter	Specification
Trigger Input:	External trigger source input. Requires TTL level input signal. Triggers on negative edge. Response time 80 - 100 μ s.
Non volatile memory storage:	16 complete instrument setups and transient lists, 100 events per list. 50 User defined waveforms.
Waveforms	Lx Series: Sine, square, clipped, user defined Ls Series standard: Sine, square, clipped Ls Series w –ADV option: Sine, square, clipped, user defined
Transients	Voltage: drop, step, sag, surge, sweep Frequency: step, sag, surge, sweep Voltage and Frequency: step, sweep
IEEE-488 Interface: (Requires –GPIB option on Ls Series)	AH1, DC1, DT1, L3, RL2, SH1, SR1, T6 IEEE 488.2 and SCPI Response time is 10 ms (typical)
RS232C Interface:	Baud rates, 9600, 19200, 38400, 57600 and 115200 Data bits: 8 Start bits: 1 Stop bits: 1 Parity: None SCPI Response time is 10 ms (typical @ 115200 baud)
Current Limit Modes:	Two selectable modes of operation: 1. Constant current mode (voltage folds back with automatic recovery) 2. Constant voltage mode with trip-off (Relays open).

2.1.6 Unit Protection

Parameter	Specification
Input Over current:	Input Circuit breaker. This breaker protects the equipment only and is not a branch protection device. AC input connection should be made using a suitable branch protection device per local electrical code.
Input Over voltage Transients:	Surge protection to withstand EN50082-1 (IEC 801-4, 5) levels.
Output Over current:	Adjustable level constant current mode with programmable set point.
Output Short Circuit:	Peak and RMS current limit.
Over temperature:	Automatic shutdown.

2.2 Mechanical

Parameter	Specification									
Dimensions:	Height:: 10.5 inches (26.7 cm) 3000Lx, 4500Lx, 6000Lx 21 inches (53.4 cm) 9000Lx/2, 12000Lx/2 31.5 inches (80.1 cm) 13500Lx, 18000Lx/3 Depth: 23 inches (58.4 cm) Width: 19 inches (48.3 cm) <i>All dimensions are per chassis. For /2 or /3 model configurations, multiply height by 2 or 3 for total height. Width includes integrated front panel rack mount ears.</i>									
Equipment Rack depth requirement	25 inches (63.5 cm)									
Unit Weight: Per chassis	Net: 193 lbs / 87.7 Kg <i>approximately</i> Shipping: 280 lbs / 127.3 Kg <i>approximately</i> <i>All weights are per chassis. For /2 or /3 model configurations, each chassis is packaged individually.</i>									
Material:	Steel chassis with aluminum top cover									
Finish:	Anodized external surfaces. Front panel color medium gray.									
Cooling:	Fan cooled with air intake on the sides and exhaust to the rear. Variable speed fan control.									
Acoustic Noise (Supplemental specification)	Measured at 1 m distance: <table border="1"> <thead> <tr> <th>Fan speed:</th> <th>Low power mode</th> <th>Full power mode</th> </tr> </thead> <tbody> <tr> <td>Front of unit:</td> <td>47 dBA</td> <td>50 dBA</td> </tr> <tr> <td>Rear of unit:</td> <td>62 dBA</td> <td>67 dBA</td> </tr> </tbody> </table>	Fan speed:	Low power mode	Full power mode	Front of unit:	47 dBA	50 dBA	Rear of unit:	62 dBA	67 dBA
Fan speed:	Low power mode	Full power mode								
Front of unit:	47 dBA	50 dBA								
Rear of unit:	62 dBA	67 dBA								
Internal Construction:	Modular sub assemblies.									
Rear Panel Connections:	(See section 3 for description of connections) <ul style="list-style-type: none"> • AC input wiring • AC output wiring • External sense terminal block (Remote voltage sense) • System interface (2x) • GPIB and RS232C • Trigger In and Out SMA's (Master Lx chassis only) 									

2.3 Environmental

Parameter	Specification
Operating Temp:	0° to +35° C, full power, 0° to +50° C, reduced power +32° to +95° F, full power, +32° to +122° F, reduced power.
Storage Temp:	-40° to +85 °C. -40° to +185° F.
Altitude:	< 2000 meters < 6000 feet

Parameter	Specification
Relative Humidity:	0-95 % RAH, non-condensing maximum for temperatures up to 31°C decreasing linearly to 50% at 40°C.
	Indoor Use Only
Vibration:	Designed to meet NSTA project 1A transportation levels.
Shock:	Designed to meet NSTA project 1A transportation levels.

2.4 Front Panel Controls

Controls:	
Shuttle knobs:	Voltage and Frequency shuttle knobs may be used to adjust voltage and frequency for selected phase or all three phases while in the SET menu. In all other menu's, the shuttles may be used to change parameter values and settings.
Up/down arrow keys:	A set of up and down arrow keys is used to move the cursor position in all menus. This allows quick selection of the desired function or parameter.
Function keys:	<p>Set key will show output voltage and frequency setting.</p> <p>Meas key displays the measurement screens. Measure key will display measurement values for selected phase or phase A if all three phases are selected.</p> <p>Menu key selects main menu.</p> <p>Enter key is used to confirm selections.</p> <p>Back key is used to back up to previous screen.</p> <p>Output on/off key for output relay control.</p> <p>Phase key toggles between phase A, B, C or all phases selection.</p>
Displays:	
LCD graphics display:	Large high contrast backlit LCD display. An adjustable viewing angle makes it easy to read from all practical locations.
Status indicators:	<p>Large and bright status indicators inform the user of important power source conditions.</p> <p>The Remote lamp informs the user that the unit is under remote control.</p> <p>The Overload lamp indicates that excessive current is being drawn at the output.</p> <p>The Over temperature lamp illuminates when internal heat sink temperatures are too high.</p> <p>The Hi Range indicator is lit any time the unit is switched to the high voltage range.</p> <p>The Output On/Off indicator is on when the power source output relays are closed.</p> <p>The Phase A, B and C indicators are lit when the relevant phase is selected with the Phase key.</p>

2.5 Special Features

Controller Features

Mode:	Switches between 1 and 3 phase outputs.
Parallel Operation:	9000Lx/2 and 13500Lx/2 systems use two or three 4500Lx chassis in parallel operation. The two or three chassis must be connected using the system interface cable supplied with the system. 12000Lx/3 and 18000Lx/3 systems use two or three 6000Lx chassis in parallel operation. The two or three chassis must be connected using the system interface cable supplied with the system
Controller:	Programmable controller front panel assembly.
Output Relay:	Standard output relay feature to isolate power source from the load.
Output On/Off:	The output relay can be used to quickly disconnect the load. A yellow status indicator displays the status of the output relay.
External Trigger Output or Function Strobe	An external TTL output is available which may be used to trigger other equipment. The TTL output can be controlled by the transient programming system. This requires the trigger mode to be set to EXT (factory default). This can only be done over the bus using the OUDP:TTLT:MODE TRIG command. This mode is compatible with the Agilent HP6834B. It can also be configured to generate an output pulse any time the voltage, frequency, current limit or phase programming is updated. This requires the trigger mode to be set to FSTR. This can only be done over the bus using the OUDP:TTLT:MODE FSTR command. This mode is compatible with the CI L Series. The Trigger Output (Trig Out1) / function strobe is an active low ¹ TTL signal with a duration of no less than 400 usec.
Clock and Lock Mode	Enables two or more independent Ls/Lx power systems to be phase synchronized to each other. One system (-LKM) acts as the master, the other(s) (-LKS) as auxiliaries. The -LKS units are synced to the -LKM unit. Refer to section 3.9 for details on Clock and Lock mode.
Trigger Input	A TTL input signal may be used as an external trigger source for output changes programmed on the AC power source transient system. This requires the trigger source to be set to EXT. This can only be done over the bus.

2.6 Available Options – Lx Series

Output Options	
-AX	Auxiliary outputs, 5 VAC and 26 VAC, 400 Hz. (Output D and E)
-HV	135 / 270 V range output
-EHV	200 / 400 V range output
-HF	High frequency option. Increases output frequency to 5000 Hz (single chassis configurations) or 2000 Hz (multi-chassis models).
-LF	Low frequency option. Limits maximum output frequency to 500 Hz.
Firmware Options	
- 704	Mil Std 704 test firmware. Includes AC tests for Revisions D and E
- 704F	Mil Std 704 test firmware. Includes AC tests for Revisions A through F

¹ Note: Early production models may have an active high Trig Out1 polarity.

- 160	RTCA/DO-160D test firmware. Includes RCTA-DO160D, section 16, Change #2 and EURO/CAE-14D AC tests only.
Misc. Options	
-L22	Locking Knobs. Shaft lock screws replace knobs to prevent turning of Voltage and Frequency shuttles.
-LKM	Clock and Lock Master. Enables synchronizing outputs of two Lx AC sources, one acting as master. This mode supports a frequency range of 45 to 819 Hz on standard Lx/Ls models. See section 3.9.
-LKS	Clock and Lock Auxiliary. See -LKM for details. (see Notes) See section 3.9.
-LNS	Line Sync (see Notes)
-EXS	External Sync (see Notes)
-RMS	Set of 2 Rack mount slides. (Left and Right) Recommended to mount Lx Chassis in 19 inch instrument cabinet.
Notes:	External Trigger input is standard. Line sync and External sync are mutually exclusive. External Trigger input and External sync are mutually exclusive. Units with -LKS (auxiliary) cannot have Line Sync or External Sync.

2.6.1 -HV Option Lx Series - Supplemental Specifications

Specifications for Lx units with -HV voltage range option installed are same as standard Lx unit except where noted below.

Voltage:			
Ranges (L-N):			
Low range	0 - 135 Vrms		
High range	0 - 270 Vrms		
Maximum Current at Full Power			
Note: Current, maximum amps per phase available at on low voltage range. 3000Lx and 4500Lx operate in constant power mode up to currents shown at reduced voltage. See Figure 2-1. For 9000Lx/2 and 12000Lx/2, currents are 2 x 4500Lx and 6000Lx. For 13500Lx/3 and 18000Lx/3, currents are 3 x 4500Lx and 6000Lx			
Model	3000Lx-HV	4500Lx-HV	6000Lx-HV
Single Phase Mode: Max. RMS, low Vrange	44.4 A	44.4 A	44.4 A
Three Phase Mode: Max. RMS, low Vrange per phase	14.8 A	14.8 A	14.8 A
Note: Current derates linearly from 50% of voltage range to 20% of specified current at 10% of voltage range. Current in High voltage range is reduced by a factor of 2.			
Note: For 9000Lx/2-HV and 12000Lx/2-HV, currents are 2 x 4500Lx-HV and 6000Lx-HV. For 13500Lx/3-HV and 18000Lx/3-HV, currents are 3 x 4500Lx-HV and 6000Lx-HV			
Maximum Current at Full Scale Voltage			

Model	3000Lx-HV	4500Lx-HV	6000Lx-HV
Single Phase Mode: Max. RMS, low Vrange	22.2 A	33.3 A	44.4 A
Three Phase Mode: Max. RMS, low Vrange per phase	7.4 A	11.1 A	14.8 A

2.6.2 -EHV Option Lx Series - Supplemental Specifications

Specifications for Lx units with -EHV voltage range option installed are same as standard Lx unit except where noted below.

Voltage:			
Ranges (L-N):			
Low range	0 - 200 Vrms		
High range	0 - 400 Vrms		
Maximum Current at Full Power			
Note: Current, maximum amps per phase available at on low voltage range. 3000Lx and 4500Lx operate in constant power mode up to currents shown at reduced voltage. See Figure 2-1. For 9000Lx/2 and 12000Lx/2, currents are 2 x 4500Lx and 6000Lx. For 13500Lx/3 and 18000Lx/3, currents are 3 x 4500Lx and 6000Lx			
Model	3000Lx-EHV	4500Lx-EHV	6000Lx-EHV
Single Phase Mode: Max. RMS, low Vrange	30.0 A	30.0 A	30.0 A
Three Phase Mode: Max. RMS, low Vrange per phase	10.0 A	10.0 A	10.0 A
Note: Current derates linearly from 50% of voltage range to 20% of specified current at 10% of voltage range. Current in High voltage range is reduced by a factor of 2.			
Note: For 9000Lx/2-EHV and 12000Lx/2-EHV, currents are 2 x 4500Lx-EHV and 6000Lx-EHV. For 13500Lx/3-EHV and 18000Lx/3-EHV, currents are 3 x 4500Lx-EHV and 6000Lx-EHV			
Maximum Current at Full Scale Voltage			
Model	3000Lx-EHV	4500Lx-EHV	6000Lx-EHV
Single Phase Mode: Max. RMS, low Vrange	15.0 A	22.5 A	30.0 A
Three Phase Mode: Max. RMS, low Vrange per phase	5.0 A	7.5 A	10.0 A

2.6.3 -HF Option Lx Series - Supplemental Specifications

Specification for Lx units with -HF frequency range option installed are same as standard Lx unit except where noted below.

Frequency Range		
Model	3000Lx-HF, 4500Lx-HF, 6000Lx-HF	9000Lx/2-HF, 13500Lx/3-HF 12000Lx/3-HF, 18000Lx/3-HF
Three phase mode	45 Hz - 5000 Hz	45 Hz - 2000 Hz
Single phase mode	45 Hz - 5000 Hz	45 Hz - 2000 Hz
Output		
Programming Accuracy:	< 1000 Hz > 1000 Hz	$\pm (0.05\% + 0.25 \text{ V})$ from 5V to FS. $\pm (0.1\% + 0.1\% / \text{KHz} + 0.3\text{V})$ from 5V to FS
Output Noise: (20 kHz to 1 MHz)	< 250 mV _{RMS} typical	

For output frequencies up to 1000 Hz, refer to standard measurement specifications. For output frequencies above 1000 Hz, see table below.

Parameter	Range	Accuracy (\pm)		Resolution
		1 Phase Mode	3 Phase Mode	
Frequency ¹	45.00 - 5000.0 Hz	0.1% \pm 1 digit		0.01 Hz to 81.91 Hz 0.1 Hz to 819.1 Hz 1 Hz > 819.1 Hz
Phase	45.00 - 100.0 Hz 100.0 - 2000 Hz > 2000 Hz	0.5° 2° 5°		0. 1°
RMS Voltage	0 - 400 Volts < 1000 Hz > 1000 Hz	0.05% + 0.25V 0.1% + 0.1% / KHz + 0.3V		0.01 Volt
RMS Current	0 - 50 Amps	0.5% + 0.15A	0.5% + 0.05A	0.001 Amp
Peak Current	0 - 150 Amps	0.5% + 0. 5A	0.5% + 0.15A	0.001 Amp
Crest Factor	1.00 – 10.00	1.5 %	1.5 %	0.01
VA Power	0 - 6 KVA	0.5% + 9 VA	0.5% + 3 VA	1 VA
Real Power	0 - 6 KW	0.5% + 9 W	0.5% + 3 W	1 W
Power Factor	0.00 - 1.00	0.03	0.01	0.01
<p><i>Note: Accuracy specifications are valid above 100 counts. For multi-chassis configurations, Current and Power range and accuracy specifications are times the number of chassis.</i></p> <p><i>Note: Frequency measurement specification valid for output > 20 Vrms.</i></p> <p><i>Note: Crest Factor accuracy applies for Irms > 50% of max.</i></p> <p><i>Note: Power factor accuracy applies for PF > 0.5 and VA > 50 % of max.</i></p>				

¹ Frequency measurement specifications valid with output voltage of 30Vrms or higher. If output relay is open, frequency measurement will return 0.0 Hz.

2.6.4 -AX Option Lx Series - Supplemental Specifications

Specifications for -AX auxiliary output voltage option on the Lx units are listed below. This output is available on the Phase D and E terminal strip. There is no external sense connection for the –AX outputs. Sense is internal only. Specifications apply for programmed frequency range of 360 Hz to 440 Hz.

Parameter	Supplemental Specification
Phase D Output	
Voltage	26.0 Vrms \pm 0.52 V
Load Regulation	< 1.5 %
Voltage Distortion	< 1.0 % THD
Max. Current	3.0 Arms
Frequency range:	360 – 440 Hz, locked to programmed frequency. If programmed exceeds 819 Hz, -AX outputs will turn off.
Phase error to phase 1	< 3.0°
Phase E Output	
Voltage	5.0 Vrms \pm 0.25 V
Load Regulation	< 10 %
Max. Current	1.0 Arms
Frequency range:	360 – 440 Hz, locked to programmed frequency. If programmed exceeds 819 Hz, -AX outputs will turn off.
Phase error to phase 1	< 3.0°

2.6.5 -LKM and -LKS Options Lx Series - Supplemental Specifications

The Clock and Lock option enables two or more independent Ls/Lx power systems to be phase synchronized to each other. One system (-LKM) acts as the master, the other(s) (-LKS) as auxiliaries. The –LKS units are synced to the –LKM unit. Refer to section 3.9 for details on Clock and Lock mode.

The following supplemental specifications apply when the Lx is configured with the Clock and Lock option. (-LKM or –LKS).

Parameter	Supplemental Specification
Voltage	
Voltage Distortion	Standard: standard specifications apply. With –HF option: < 2 % [45 - 1000 Hz] < 2 % + 1%/kHz [> 2000 Hz] (harmonics and noise to 300 kHz)
Frequency	
Range	Standard Lx: 45 – 819 Hz With –HF option: 45 - 5000 Hz.
Resolution	Standard Lx: 0.1 Hz With –HF option: 1 Hz

Parameter	Supplemental Specification
Accuracy	$\pm 0.025\%$
Phase	
Phase Resolution	Standard: standard specifications apply. With –HF option: 0.5°
Phase Accuracy	Standard: standard specifications apply. With –HF option: $< 2^\circ + 1^\circ/\text{kHz}$

2.6.6 –EXS Option Lx Series - Supplemental Specifications

The –EXS (External Sync) option allows the output frequency of the AC source to be synchronized to an external TTL level clock signal.

The following supplemental specifications apply when the Lx is configured with the external sync option. (-EXS).

Parameter	Supplemental Specification
Input	
Voltage Input	TTL Level square wave.
Impedance	10 KOhm.
Frequency	
Range	Same as internal clock mode. See configuration limits.
Max Sync Input Slew Rate	$< 80 \text{ Hz / sec.}$ Changes in sync input frequency occurring faster than this rate will result in Error 804: External Sync Error. Output relay is opened on Error.
Max Sync Step	$< 20 \text{ Hz.}$ Sudden changes in sync input frequency greater than 20 Hz will result in Error 804: External Sync Error. Output relay is opened on Error.
Mode Selection	When switching between INT and EXT sync mode, the output of the AC source will be dropped momentarily.
Restrictions	Frequency cannot be programmed in external sync mode. Frequency transient list system is not available in sync mode. Transient list dwell times are not correlated to external sync but based on internal timebase.

2.7 Available Options – Ls Series

Output Options	
-AX	Auxiliary outputs, 5 VAC and 26 VAC, 400 Hz. (Output D and E)
-HV	156 / 312 V range output
-EHV	200 / 400 V range output
-HF	High frequency option. Increases output frequency to 5000 Hz (single chassis configurations) or 2000 Hz (multi-chassis models).
-LF	Low frequency option. Limits maximum output frequency to 500 Hz.
-MODE	Adds single phase and three phase mode switching capability to –3 LS models. Not available on –1 models.
Firmware Options	
- 704	Mil Std 704 test firmware. Includes AC tests for Revisions D and E
- 704F	Mil Std 704 test firmware. Includes AC tests for Revisions A through F
- 160	RTCA/DO-160D test firmware. Includes RCTA-DO160D, section 16, Change #2 and EURO/CAE-14D AC tests only.
Misc. Options	
-ADV	Advanced features package. Adds arbitrary waveform generation and harmonic analysis measurements. For specifications, see Lx Series.
-GPIB	GPIB interface. Also adds APE command language support for backward compatibility with L Series. See Lx/Ls Programming Manual P/N 7004-961 for detail on APE command language.
-L22	Locking Knobs. Shaft lock screws replace knobs to prevent turning of Voltage and Frequency shuttles.
-LKM	Clock and Lock Master. Enables synchronizing outputs of two Lx AC sources, one acting as master. This mode supports a frequency range of 45 to 819 Hz on standard Lx/Ls models. See section 3.9.
-LKS	Clock and Lock Auxiliary. See -LKM for details. (See Notes, see section 3.9.)
-LNS	Line Sync (see Notes)
-EXS	External Sync (see Notes)
-RMS	Set of 2 Rack mount slides. (Left and Right) Recommended to mount Lx Chassis in 19 inch instrument cabinet.
Notes:	External Trigger input is standard. Line sync and External sync are mutually exclusive. External Trigger input and External sync are mutually exclusive. Units with -LKS (auxiliary) cannot have Line Sync or External Sync.

2.7.1 -HV Option Ls Series - Supplemental Specifications

Specifications for Ls units with -HV voltage range option installed are same as standard Ls unit except where noted below.

Voltage:			
Ranges (L-N):			
Low range	0 - 156 Vrms		
High range	0 - 312 Vrms		
Maximum Current at Full Power			
Note: Current, maximum amps per phase available at on low voltage range. 3000Ls and 4500Ls operate in constant power mode up to currents shown at reduced voltage. See Figure 2-1. For 9000Ls/2 and 12000Ls/2, currents are 2 x 4500Ls and 6000Ls. For 13500Ls/3 and 18000Ls/3, currents are 3 x 4500Ls and 6000Ls			
Model	3000Ls-HV	4500Ls-HV	6000Ls-HV
Single Phase Mode: Max. RMS, low Vrange	38.4 A	38.4 A	38.4 A
Three Phase Mode: Max. RMS, low Vrange per phase	12.8 A	12.8 A	12.8 A
Note: Current derates linearly from 50% of voltage range to 20% of specified current at 10% of voltage range. Current in High voltage range is reduced by a factor of 2. Note: For 9000Ls/2-HV and 12000Ls/2-HV, currents are 2 x 4500Ls-HV and 6000Ls-HV. For 13500Ls/3-HV and 18000Ls/3-HV, currents are 3 x 4500Ls-HV and 6000Ls-HV			
Maximum Current at Full Scale Voltage			
Model	3000Ls-HV	4500Ls-HV	6000Ls-HV
Single Phase Mode: Max. RMS, low Vrange	19.2 A	28.8 A	38.4 A
Three Phase Mode: Max. RMS, low Vrange per phase	6.4 A	9.6 A	12.8 A

2.7.2 EHV Option Ls Series -Supplemental Specifications

Specifications for Ls units with -EHV voltage range option installed are same the Lx with –EHV option. See paragraph 2.6.2.

2.7.3 -HF Option Supplemental Specifications

Specification for Ls units with -HF frequency range option installed are same as standard Ls unit except where noted below.

Frequency Range		
Model	3000Ls-HF, 4500Ls-HF , 6000Ls-HF	9000Ls/2-HF, 13500Ls/3-HF 12000Ls/3-HF, 18000Ls/3-HF
Three phase mode	45 Hz - 5000 Hz	45 Hz - 2000 Hz
Single phase mode	45 Hz - 5000 Hz	45 Hz - 2000 Hz
Output		
Programming Accuracy:	$< 1000 \text{ Hz} \quad \pm (0.05\% + 0.25 \text{ V})$ from 5V to FS. $> 1000 \text{ Hz} \quad \pm (0.1\% + 0.1\% / \text{KHz} + 0.3\text{V})$ from 5V to FS	
Output Noise: (20 kHz to 1 MHz)	$< 250 \text{ mV}_{\text{RMS}}$ typical	

For output frequencies up to 1000 Hz, refer to standard measurement specifications. For output frequencies above 1000 Hz, see table below.

Parameter	Range	Accuracy (\pm)		Resolution
		1 Phase Mode	3 Phase Mode	
Frequency ¹	45.00 - 5000.0 Hz	0.1% \pm 1 digit		0.01 Hz to 81.91 Hz 0.1 Hz to 819.1 Hz 1 Hz > 819.1 Hz
Phase	45.00 - 100.0 Hz 100.0 - 2000 Hz > 2000 Hz	0.5° 2° 5°		0. 1°
RMS Voltage	0 - 400 Volts < 1000 Hz > 1000 Hz	0.05% + 0.25V 0.1% + 0.1% / KHz + 0.3V		0.01 Volt
RMS Current	0 - 50 Amps	0.5% + 0.15A	0.5% + 0.05A	0.001 Amp
Peak Current	0 - 150 Amps	0.5% + 0. 5A	0.5% + 0.15A	0.001 Amp
Crest Factor	1.00 – 10.00	1.5 %	1.5 %	0.01
VA Power	0 - 6 KVA	0.5% + 9 VA	0.5% + 3 VA	1 VA
Real Power	0 - 6 KW	0.5% + 9 W	0.5% + 3 W	1 W
Power Factor	0.00 - 1.00	0.03	0.01	0.01

¹ Frequency measurement specifications valid with output voltage of 30Vrms or higher. If output relay is open, frequency measurement will return 0.0 Hz.

Note: Accuracy specifications are valid above 100 counts. For multi-chassis configurations, Current and Power range and accuracy specifications are times the number of chassis.

Note: Frequency measurement specification valid for output > 20 Vrms.

Note: Crest Factor accuracy applies for Irms > 50% of max.

Note: Power factor accuracy applies for PF > 0.5 and VA > 50 % of max.

2.7.4 -AX Option Ls Series - Supplemental Specifications

Specifications for -AX auxiliary output voltage option on the Ls units are listed below. This output is available on the Phase D and E terminal strip. There is no external sense connection for the –AX outputs. Sense is internal only. Specifications apply for programmed frequency range of 360 Hz to 440 Hz.

Parameter	Supplemental Specification
Phase D Output	
Voltage	26.0 Vrms \pm 0.52 V
Load Regulation	1.5 %
Voltage Distortion	< 1.0 % THD
Max. Current	3.0 Arms
Frequency range:	360 – 440 Hz, locked to programmed frequency. If programmed frequency exceeds 819 Hz, -AX outputs will turn off.
Phase error to phase A	< 3.0°
Phase E Output	
Voltage	5.0 Vrms \pm 0.25 V
Load Regulation	< 10 %
Max. Current	1.0 Arms
Frequency range:	360 – 440 Hz, locked to programmed frequency. If programmed frequency exceeds 819 Hz, -AX outputs will turn off.
Phase error to phase A	< 3°

2.7.5 -LKM and -LKS Options Ls Series - Supplemental Specifications

The Clock and Lock option enables two or more independent Ls/Lx power systems to be phase synchronized to each other. One system (-LKM) acts as the master, the other(s) (-LKS) as auxiliaries. The –LKS units are synced to the –LKM unit. Refer to section 3.9 for details on Clock and Lock mode.

The following supplemental specifications apply when the Ls is configured with the Clock and Lock option. (-LKM or –LKS).

Parameter	Supplemental Specification
Voltage	
Voltage Distortion	Standard: standard specifications apply. With –HF option: < 2 % [45 - 1000 Hz] < 2 % + 1%/kHz [> 2000 Hz] (harmonics and noise to 300 kHz)

Parameter	Supplemental Specification
Frequency	
Range	Standard Lx: 45 – 819 Hz With –HF option: 45 - 5000 Hz.
Resolution	Standard Lx: 0.1 Hz With –HF option: 1 Hz
Accuracy	± 0.025%
Phase	
Phase Resolution	Standard: standard specifications apply. With –HF option: 0.5°
Phase Accuracy	Standard: standard specifications apply. With –HF option: < 2° + 1°/kHz

2.7.6 –EXS Option Ls Series - Supplemental Specifications

The –EXS (External Sync) option allows the output frequency of the AC source to be synchronized to an external TTL level clock signal.

The following supplemental specifications apply when the Ls is configured with the external sync option. (-EXS).

Parameter	Supplemental Specification
Input	
Voltage Input	TTL Level square wave.
Impedance	10 KOhm.
Frequency	
Range	Same as internal clock mode. See configuration limits.
Max Sync Input Slew Rate	< 80 Hz / sec. Changes in sync input frequency occurring faster than this rate will result in Error 804: External Sync Error. Output relay is opened on Error.
Max Sync Step	< 20 Hz. Sudden changes in sync input frequency greater than 20 Hz will result in Error 804: External Sync Error. Output relay is opened on Error.
Mode Selection	When switching between INT and EXT sync mode, the output of the AC source will be dropped momentarily.
Restrictions	Frequency cannot be programmed in external sync mode. Frequency transient list system is not available in sync mode. Transient list dwell times are not correlated to external sync but based on internal timebase.

3. Unpacking and Installation

3.1 Unpacking

Inspect the unit for any possible shipping damage immediately upon receipt. If damage is evident, notify the carrier. **DO NOT** return an instrument to the factory without prior approval. Do not destroy the packing container until the unit has been inspected for damage in shipment. If possible, retain the container in the event the system ever has to be returned to the factory for either repair or upgrades



WARNING: This power source weighs approximately 175 lbs / 79.2 Kg per chassis (2 chassis total) Obtain adequate help when moving or installing the unit. Make sure the cabinet and rack slides used to install the Lx or Ls Series unit(s) can support the weight of the unit(s).

3.2 Power Requirements

The Lx / Ls Series power Source has been designed to operate from a three-phase, three wire (Wye or Delta) AC input line. A protective earth connection is required as well. (PE).

Available three-phase input setting is 208 to 230 V_{LL} nominal for standard Lx / Ls models or 400 V_{LL} nominal for Lx / Ls Series with option –400. All three phase input is three wire plus ground.

The 3000Lx/Ls model with standard 208V L-L AC input may be operated from a single phase 208-230 V L-N AC input as well. In this case, the single phase AC must be connected between TB3 L2-L3 inputs for 3000Lx or TB3 ØB – ØC inputs for 3000Ls. Note that input current will be significantly higher than for a 3 phase AC input connection so wire size and AC disconnects used must be sized accordingly.



CAUTION: Do not connect 400V into a unit designed for 208 use. The result could be a severely damaged unit. Always check the input rating on the model number tag before connecting AC input power. AC voltage input settings CANNOT be changed in the field.

3.3 Mechanical Installation

The Lx / Ls Series AC power sources can be used free standing on a solid surface or mounted in a 19" instrument cabinet. The units are fan cooled, drawing air in from the side and exhausting at the rear. The back of each unit must be kept clear of obstruction and a 3" clearance must be maintained to the rear. Special consideration of overall airflow characteristics and the resultant internal heat rise must be considered at all times to avoid self heating and over temperature problems.

Multi chassis configurations such as the 9000Lx/2 or 9000Ls/2 consist of two self-contained 4500Lx or 4500Ls power sources. They must be connected through the system interface using the supplied DB25 to DB25 cable. Output wiring from each chassis to the EUT must be of **equal wire gage and length** to ensure proper current sharing between units.

Note that for multi-chassis systems, it is recommended to turn the Master unit ON first and then the Auxiliary unit(s). To turn the system off, turn OFF the Auxiliary unit(s) first and then the Master unit.

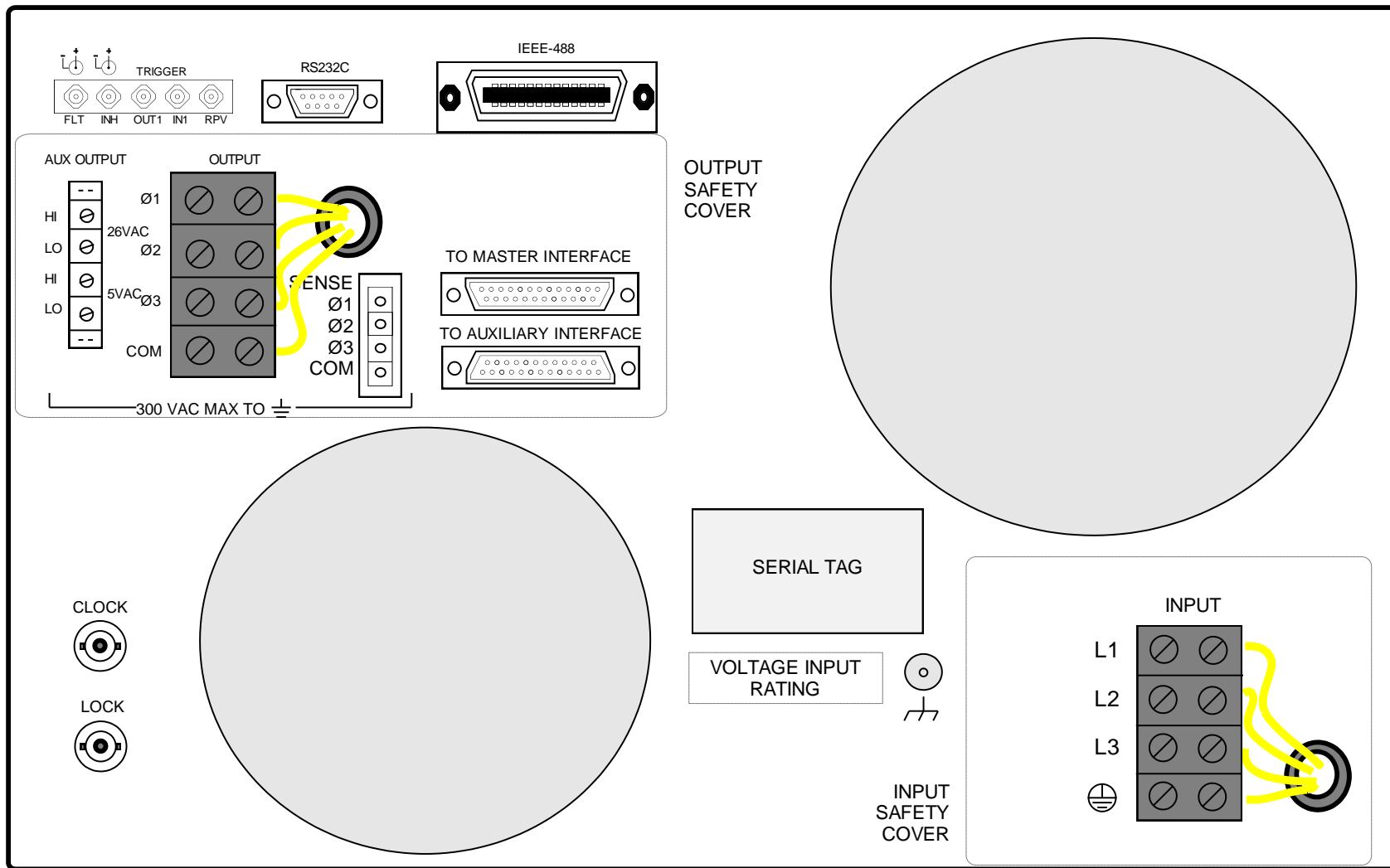

Figure 3-1: Rear Panel Connector Locations – Lx Series

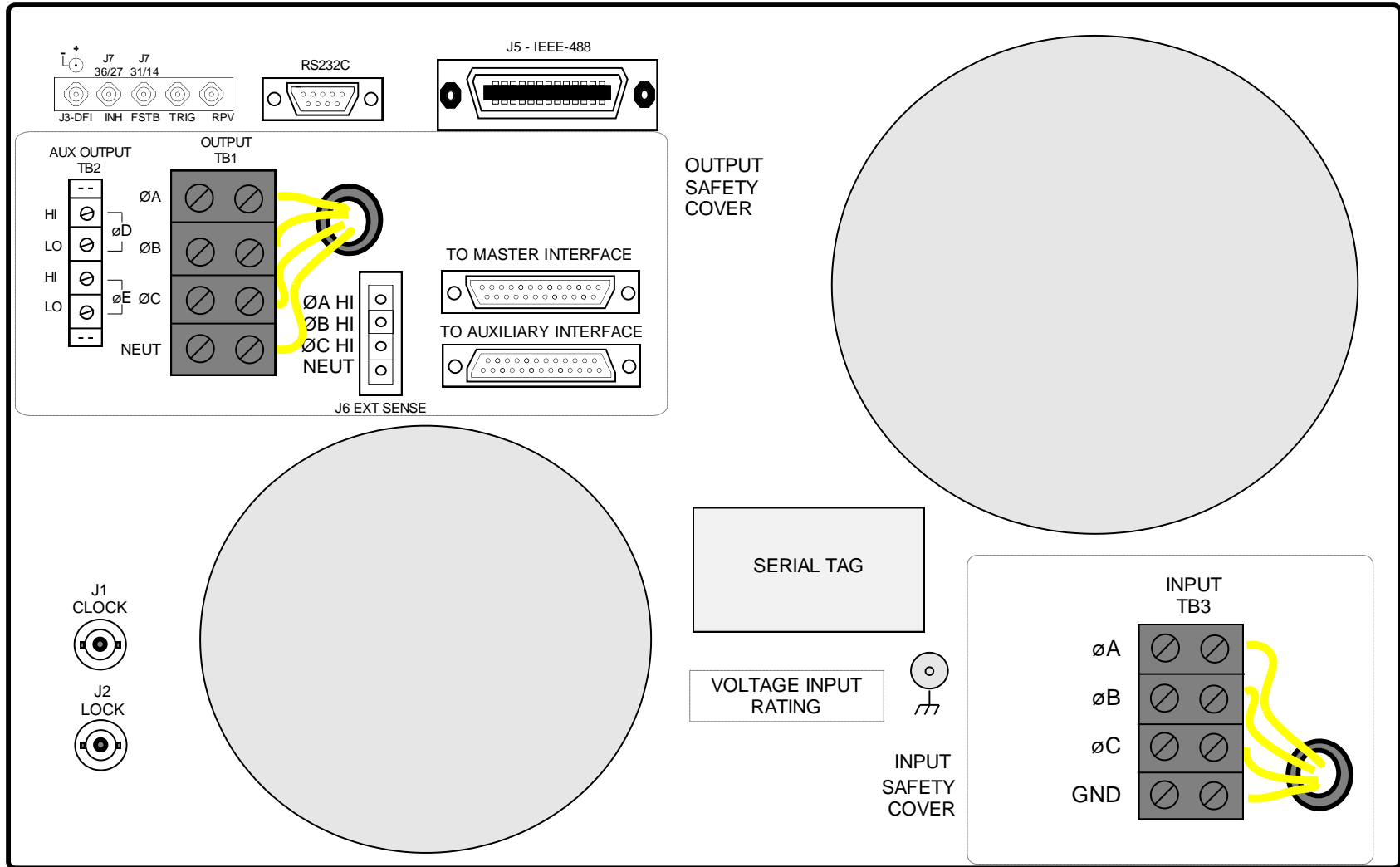

Figure 3-2: Rear Panel Connector Locations – Ls Series

3.4 AC Input Wiring - INPUT

AC input connections are to be made directly to the input fuse block of all units that make up a Lx / Ls system. The input block is located on the lower right hand corner of the back of the 4500Lx/Ls and 4500Lx/Ls-NO chassis. It is labeled "INPUT" on the Lx and "INPUT TB3" on the Ls models.

Ground (earth) wire must be connected to the chassis of the AC power system using the ground connection of the AC input fuse block. The mains source must have a current rating equal to or greater than the input fuses and the input wiring must be sized to satisfy the applicable electrical codes.

The input power cables must be large enough to handle the input current of the power source and must conform to local electrical codes. Consult a qualified electrician prior to installation. Note that all wires must be sized to accommodate the worst-case maximum current that may occur under low line conditions. Local electrical codes may also require different wire types and sizes.

Cable lengths must not exceed twenty-five (25) feet. For lengths greater than 25 feet, calculate the voltage drop from the following formula:

$$2 \times \text{DISTANCE} \times \text{CABLE RESISTANCE PER FT.} \times \text{CURRENT} = \text{VOLT DROP}$$

Note: *If possible, keep input cable lengths for Master and Auxiliary chassis equal.*



CAUTION: *Capacitors in the power source may hold a hazardous electrical charge even if the power source has been disconnected from the mains supply. Allow capacitors to discharge to a safe voltage before touching exposed pins of mains supply connectors.*

Power modules need at least 10 Minutes to discharge to safe levels before they can be removed.

3.5 Output Connections

3.5.1 Output Wiring

The output terminal blocks for each unit are located at the rear of the unit. Three phase output connections are made to the terminal block labeled OUTPUT. For a 9000Lx/2 or 9000Ls/2two box system, the output terminals from both the master 4500Lx or 4500Ls and Auxiliary 4500Lx or 4500Ls must be connected together. See Figure 3-3.

On Lx Series, the phase outputs are labeled $\phi 1$, $\phi 2$, $\phi 3$ and COM. (Same labeling as Hewlett Packard / Agilent HP6834 and California Instruments iL Series) The common (neutral) connection (if needed) can be made on the same terminal block labeled COM. If the power source is operated in single-phase mode, all power is available from the $\phi 1$ output connection. The neutral connection (COM) is always required for single-phase output mode on a 9000Lx/2 and may be used if needed for the EUT for all three-phase output modes.

On Ls Series, the phase outputs are labeled ϕA , ϕB , ϕC and NEUT. (Same labeling as California Instruments L Series) The neutral connection (if needed) can be made on the same terminal block labeled COM. If the power source is a single-phase model or operated in single phase mode, all power is available from the ϕA output connection. The neutral connection (COM) is

always required for single-phase output mode on a 9000Ls/2 and may be used if needed for the EUT for all three-phase output modes.

The external sense inputs allow the power system output voltages to be monitored directly at the load and must be connected at external sense connector. The external sense wires should be run as a twisted pair for short lengths. Sense leads over three (3) feet long should be run as a twisted shielded pair.

Note: *The output of the power source is isolated from the input line and floating with respect to chassis ground. If needed, either side (HI or LO) may be grounded.*

The output power cables must be large enough to prevent a total voltage drop exceeding 1% of the rated output voltage between the power source and the load. Note that wires must be sized to accommodate the maximum current that is available. This may be a function of the voltage range and phase mode of the Lx \ Ls model on hand. Always use the current available on the low voltage range to size the wires.

Cable lengths must not exceed twenty-five (25) feet. For lengths greater than 25 feet, calculate the voltage drop from the following formula:

$$2 \times \text{DISTANCE} \times \text{CABLE RESISTANCE PER FT.} \times \text{CURRENT} = \text{VOLT DROP}$$

Note: *Ensure that output cable lengths from Master and Auxiliary chassis to EUT are of identical length.*

3.5.2 Output Terminal Block - OUTPUT

Each 3000/4500/6000Lx\Ls chassis has a single AC output terminal block. For tabletop operation of a single chassis system, the output terminal block must be covered using the supplied AC Output safety cover. The terminal blocks are large enough to accommodate required wire gauge sizes. The terminal block is located in the upper left corner on the rear panel of the unit. (Looking from the back).

Multi-chassis configurations have two or more output terminal blocks, one on the master Lx \ Ls chassis and one of the auxiliary Lx \ Ls chassis.

For operation as a multi-chassis system, the outputs of all Lx \ Ls chassis' must be connected together using the additional terminal blocks provided in the Lx \ Ls ship kit. **Keep the wire lengths between each chassis and this common terminal block the same.**

See Figure 3-3 for output wiring diagram.

Connector	Terminal	Mode	Lx Output OUTPUT	Ls Output TB1
	1	3 Phase & 1 Phase	Ø1	ØA
	2	3 Phase	Ø2	ØB
	3	3 Phase	Ø3	ØB
	4	Common / Neutral	COM	NEUT

Table 3-1: Output Terminal connections.

3.5.3 Multi-chassis Output Wiring Diagram

Figure 3-3 shows the required output connections for a 9000Lx/2 or 9000Ls/2 two chassis system (rear-view perspective). **Always turn off AC mains power to the 9000Lx/2 or 9000Ls/2 by turning off the circuit breakers on both the Master and Auxiliary 4500Lx / Ls power source before making or changing output connections.** The terminal block shown to connect the outputs of both chassis together is provided in the 9000Lx/2 or 9000Ls/2 ship kit. The System Interface cable is a DB25 to DB25 M/F cable approximately 2 meters in length. (CI P/N 250778). This cable connects between the male DB25 connector on the Master unit rear panel labeled TO AUXILIARY INTERFACE and the female DB25 connector on the Auxiliary unit rear panel labeled TO MASTER INTERFACE as shown in Figure 3-3. The OUTPUT SAFETY COVER must be removed to use the System Interface and the AC Source must be installed in a cabinet with a protective rear screen or door.

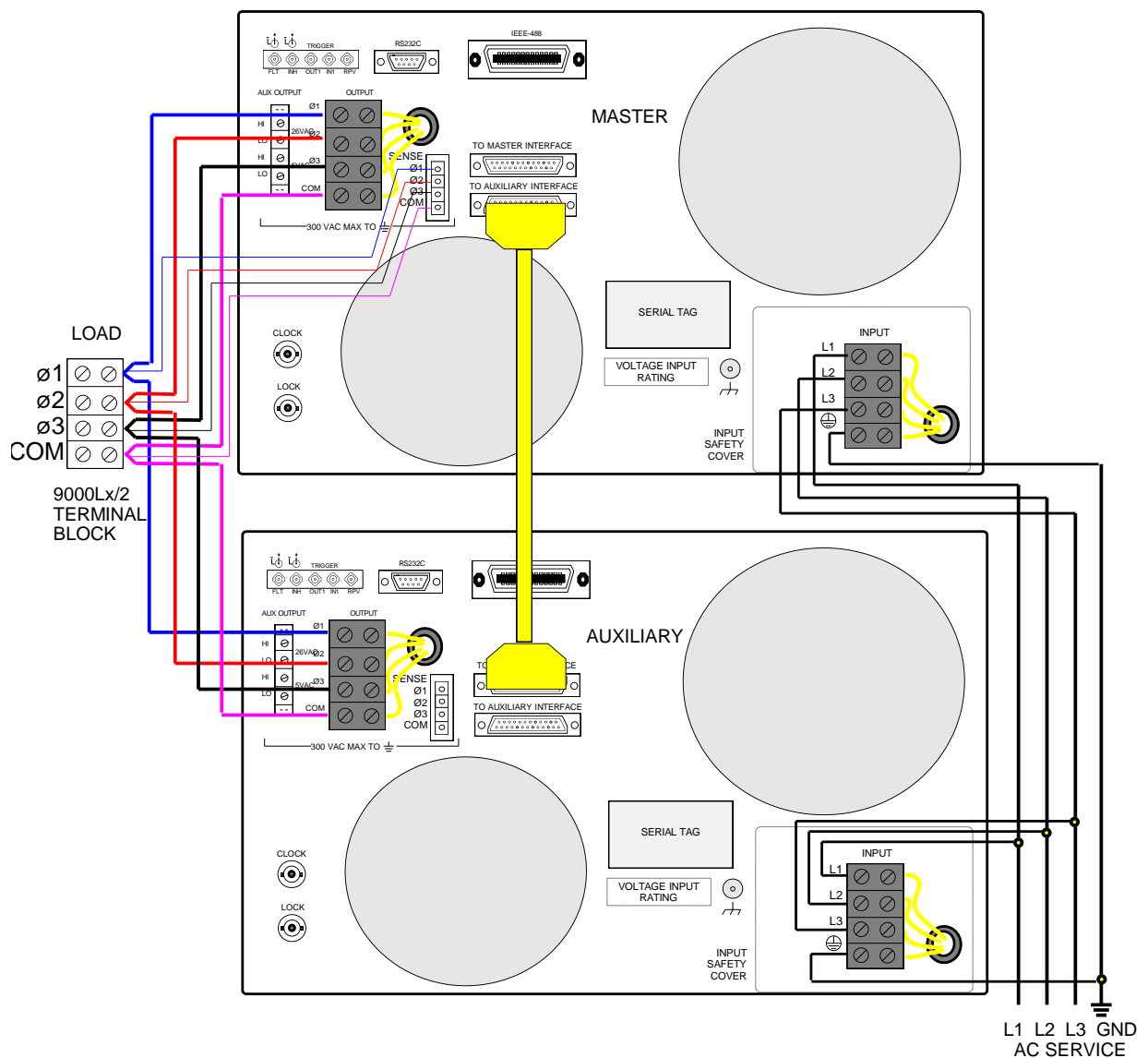

Figure 3-3: 9000Lx/2 and 9000Ls/2 Output Wiring

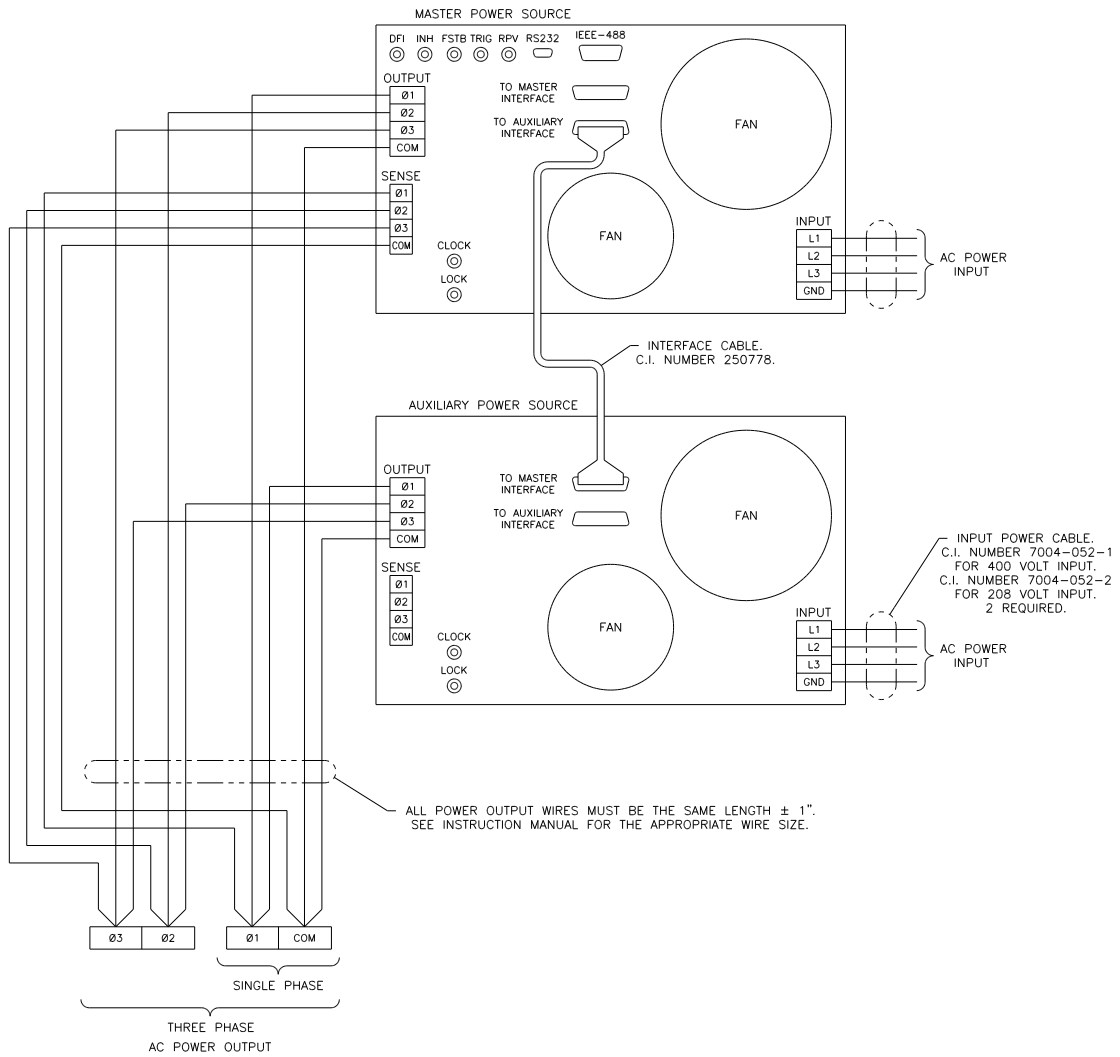

Figure 3-4: 9000Lx/2, 9000Ls/2, 12000Lx/2 or 12000Ls/2 Wiring diagram - 3 Phase mode

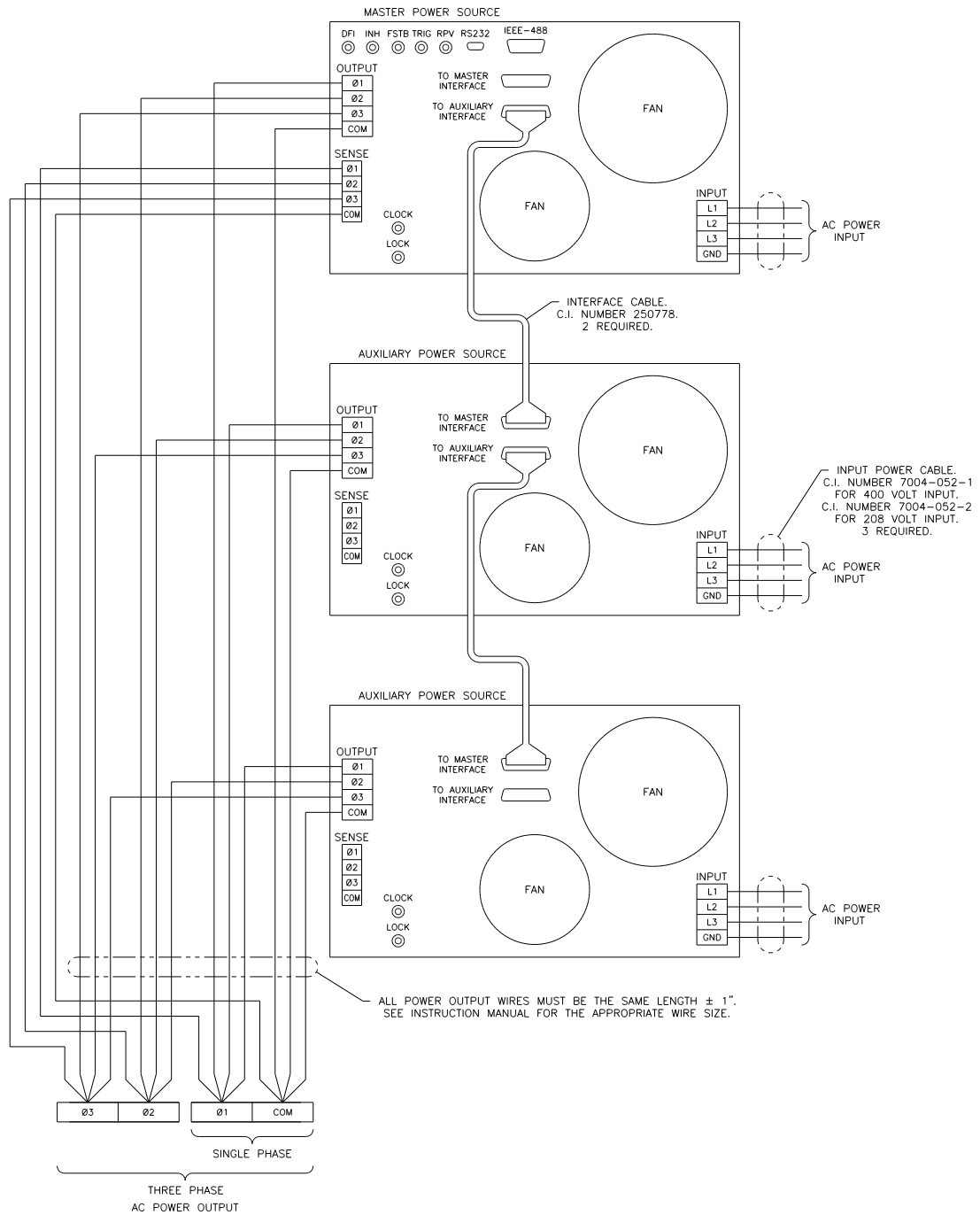

Figure 3-5: 13500Lx/2, 13500Ls/3, 18000Ls/3 or 18000Ls/3 Wiring diagram - 3 Phase mode

3.6 Connectors - Rear Panel

A number of connectors are located along the top rear covers. These connectors are in a recessed area to protect them from shipment damage. A summary of available connectors is provided in the table below.

Connector	Function	Connects To
Lx Series		
AC Input (INPUT)	Function	Connects To
L1 – AC in L2 – AC in L3 – AC in CHASSIS - GND	Primary AC Power Input	208 - 230 VAC nominal (Std) 400 VAC nominal (-400 option) Note: For 3000Lx/Ls operated from single-phase AC input, use L2-L3.
AC Output (OUTPUT)	Function	Connects To
Ø1 Ø2 Ø3 COM	AC output	User Load
External Sense	Function	Table
Sense Ø1, Ø2, Ø3, COM	External Sense	Table 3-7
Ls Series		
AC Input (INPUT TB3)	Function	Connects To
ØA – AC in ØB – AC in ØC – AC in CHASSIS - GND	Primary AC Power Input	208 - 230 VAC nominal (Std) 400 VAC nominal (-400 option) Note: For 3000Lx/Ls operated from single-phase AC input, use ØB- ØC.
AC Output (OUTPUT TB1)	Function	Connects To
ØA ØB ØC NEUT	AC output	User Load
External Sense	Function	Table
Sense ØA HI, ØB HI, ØC HI, NEUT	External Sense	Table 3-7
Lx and Ls Series		
Remote Control	Function	Table
RS232	Serial Control Interface	Table 3-8
IEEE-488	GPIOB Control Interface	See IEEE-488 standard for pin out.
System Interface	Function	Table
Master	Connects to Master	DB25, MALE
Auxiliary	Connects to Auxiliary	DB25, FEMALE
Lx Series		
Other	Function	Table
SMA Connectors	Discrete Fault Indicator	Table 3-4
	Remote Inhibit	Table 3-4
	Trigger Out1 (Function Strobe)	Table 3-4
	Trigger In1	Table 3-4

Connector		
	RPV (N/A)	Table 3-4
BNC Connectors	Clock	Table 3-6 -LKM / -LKS option
	Lock	Table 3-6
Ls Series		
Other	Function	Table
SMA Connectors	Discrete Fault Indicator	Table 3-4
	J7-36+ / J7-27- (Remote Shutdown)	Table 3-4
	Function Strobe	Table 3-4
	Trigger	Table 3-4
	RPV (N/A)	Table 3-4
BNC Connectors	J1 - Clock	Table 3-6 -LKM / -LKS option
	J2 - Lock	Table 3-6

Table 3-2: Rear Panel Connectors

3.6.1 AC Input Connector – INPUT

See section 3.4 for details on connecting AC input power. Labeled INPUT on Lx models, INTPUT TB3 on Ls models.

INPUT.	Designator Lx Series	Designator Ls Series	Direction	Connection Description
1	L1	ØA	Input	AC Line
2	L2	ØB	Input	AC Line
3	L3	ØC	Input	AC Line
4	GND	Gnd symbol		Chassis Ground

Table 3-3: AC Input Terminal Block Connection Description

3.6.2 SMA Connectors – Lx Series

SMA connectors. Functions are called out on rear panel decal. Table 3-4 shows connections from left to right when standing at the rear of the Lx cabinet. SMA connectors are small high frequency capable coax connectors that can be screwed down securely to prevent signal loss. Adaptor for SMA to BNC conversion are readily available.

To connect these signals using more conventional BNC cables, SMA Male to BNC Female adapters may be used. These are available from www.pasternack.com , P/N PE9074.

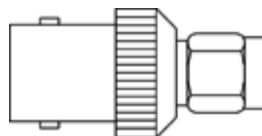

PE9074 Adaptor.

SMA	Description
FLT	Discrete Fault Indicator output. Isolated Open Collector. Can be used to signal external devices when a fault condition is detected.
INH	Remote Inhibit. (TTL input)
TRIGGER	Trigger Output (TTL output)

SMA	Description
OUT1	(Can be set to Function Strobe for compatibility with CI L Series)
TRIGGER IN1	Trigger Input (TTL input)
RPV	Not Used.

Table 3-4: SMA Connectors – Lx Series

3.6.3 SMA Connectors – Ls Series

SMA connectors. Functions are called out on rear panel decal. Table 3-5 shows connections from left to right when standing at the rear of the Ls cabinet. SMA connectors are small high frequency capable coax connectors that can be screwed down securely to prevent signal loss. Adaptor for SMA to BNC conversion are readily available.

To connect these signals using more conventional BNC cables, SMA Male to BNC Female adapters may be used. These are available from www.pasternack.com , P/N PE9074.

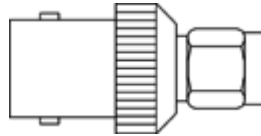

PE9074 Adaptor.

SMA	Description
J3 DFI	Discrete Fault Indicator output. Isolated Open Collector. Can be used to signal external devices when a fault condition is detected.
J7 36/27 INH	Remote Shutdown. (Inhibit) (TTL input) Equivalent to J7-36 (+) and J7-27 (-) on CI L Series.
J7 31/14 FSTB	Function Strobe (Can be set to Trigger Output (TTL output) for compatibility with CI iL Series) Equivalent to J7-31 (+) and J7-14 (-) on CI L Series.
TRIG	Trigger Input (TTL input)
RPV	Not Used.

Table 3-5: SMA Connectors – Ls Series

3.6.4 BNC Connectors (-LKM / -LKS options)

BNC connectors. Functions are called out on rear panel decal. Table 3-6 shows connections for the optional -LKM and -LKS clock and lock mode. Refer to section 3.9 for more details.

BNC	Ls Series Ref.	Description
CLOCK	J1	Clock Option (TTL output on Master / TTL input on Auxiliary) N/A
LOCK	J2	Lock Option (TTL output on Master / TTL input on Auxiliary) N/A

Table 3-6: BNC Connectors

3.6.5 External Sense Connector – SENSE

The external sense connections for Phase 1, 2 and 3 (A, B and C) in three-phase mode and Phase 1 (A) in single phase mode MUST be connected for correct operation. Sense connections must be made at the MASTER 4500Lx/Ls unit for a multi-box Lx/Ls system.

Pin	Description - Lx Series	Description - Ls Series
1	Phase 1 sense Hi	Phase A sense Hi
2	Phase 2 sense Hi	Phase B sense Hi
3	Phase 3 sense Hi	Phase C sense Hi
4	Neutral sense	Neutral sense
5	-AX Option Phase D Hi – N/A	-AX Option Phase D Hi – N/A
6	-AX Option Phase D Lo – N/A	-AX Option Phase D Lo – N/A

Table 3-7: External Sense Connector

3.6.6 RS232C Serial Interface – RS232C

A standard RS232C DB9 connector is located on the rear panel for serial control. A straight thru DB9 male to DB9 female interface cable to 9-pin PC serial port connector may be used

Pin	Designator	Dir.	Description
1	Not used		N/C
2	TxD	Output	Transmit data
3	RxD	Input	Receive data
4	Not used		N/C
5	Common		Common
6	Not used		N/C
7	CTS	Input	Clear to send
8	RTS	Output	Request to send
9	Not used		N/C

Table 3-8: RS232C Connector

3.6.7 System Interface Connectors – MASTER and AUXILIARY



WARNING: The system interface connectors are for use with California Instruments supplied cables, and only between California Instruments equipment.

A set of two System Interface connectors is located on the rear panel of each 4500Lx/Ls chassis. The system interface is used to connect the multiple 4500Lx/Ls or 6000Lx/Ls power sources in a Master/Auxiliary configuration to create a 9000Lx/Ls/2, 12000Lx/Ls/2, 13500Lx/Ls/3 or 18000Lx/Ls/3 AC power source configuration. In this configuration, only the Master power source has a built-in controller and front panel. The System Interface cable provided in the Lx or Ls Series ship kit (CI P/N 250778) MUST be used to connect both chassis as shown in Figure 3-3.

Note that no user accessible signals are provided on the System Interface connections and they should only be used for their intended purpose. To use the System Interface capability, the output safety cover has to be removed. As such, multi-chassis configurations cannot be used outside of a cabinet with proper rear screens.

Note that for multi-chassis systems, it is recommended to turn the Master unit ON first and then the Auxiliary unit(s). To turn the system off, turn OFF the Auxiliary unit(s) first and then the Master unit.

3.7 Basic Initial Functional Test



CAUTION: *Work carefully when performing these tests; hazardous voltages are present on the input and output during this test.*

Refer to Figure 3-3 for the required functional test set up. Proceed as follows to perform a basic function check of the power system:

1. Verify the correct AC line input rating on the nameplate of the Lx/Ls unit(s) and make sure the correct three-phase line voltage is wired to the input of the Lx/Ls before applying input power.
2. Connect a suitable resistive or other type load to the output of the Lx or Ls. Suggested load values for the low voltage range rounded up to the nearest 0.1 Ohm are shown in Table 3-9 for the Lx Series and Table 3-10 for the Ls Series.
For the high voltage range, the resistor values must be multiplied by four. For models with –HV or –EHV voltage range option, recalculate these values by adjusting for the voltage range value. Make sure the power resistor has sufficient power dissipation capability for full load test and that the load used does not exceed the maximum power rating of the AC source. For three phase configurations, this test can be performed on one phase at a time if needed.
3. Connect an oscilloscope and DMM / voltmeter to the AC source output. Set both for AC mode.
4. If the correct voltage is present, turn on the Lx/Ls unit(s) by closing the On/Off circuit breaker on the front panel of both chassis.
5. Set the output voltage to 0 volt and close the output relay with the OUTPUT ON/OFF button. There should be little or no output although the DMM may show a noise level, especially if the DMM is in auto ranging mode.
6. Select the **Set** screen and use the voltage shuttle to program a small voltage (20 VAC). Observe the DMM reading. The reading should track the programmed voltage.
7. Also monitor the scope. The output should be a sinusoidal voltage waveform.
8. If the output tracks, increase the voltage till you reach 80 % of the voltage range or more. Check the output voltage reading and waveform.
9. Select the measurement screen by pressing the **Meas** button. The output voltage, current and power will be displayed. For three phase configurations, use the PHASE button to select individual phase data. If all phases are loaded equally, the same current and power should be visible for all three unless the voltages are not programmed to the same level. If only one phase is loaded, current and power will only be shown for the loaded phase.

In the unlikely event the power source does not pass the functional test, refer to the calibration procedure in Section 6 or call California Instrument's customer satisfaction department for further assistance.

Model	3 Phase Mode, 150 V range	1 Phase Mode, 150 V range
3000Lx	22.5 Ohm	7.5 Ohm
4500Lx	15 Ohm	5.0 Ohm
6000Lx	11.8 Ohm	4.0 Ohm
9000Lx	7.5 Ohm	2,5 Ohm
12000Lx	5.9 Ohm	2.0 Ohm
13500Lx	5.0 Ohm	1.7 Ohm
18000Lx	4.0 Ohm	1.4 Ohm

Table 3-9: Full Load Resistance – Lx Series

Model	3 Phase Mode, 135 V range	Model	1 Phase Mode, 135 V range
3000Ls-3	18.3 Ohm	3000Ls-1	6.1 Ohm
4500Ls-3	12.2 Ohm	4500Ls-1	4.1 Ohm
6000Ls-3	9.2 Ohm	6000Ls-1	3.1 Ohm
9000Ls-3	6,1 Ohm	9000Ls-1	2.1 Ohm
12000Ls-3	4.6 Ohm	12000Ls-1	1.6 Ohm
13500Ls-3	4.1 Ohm	13500Ls-1	1.4 Ohm
18000Ls-3	3.1 Ohm	18000Ls-1	1.1 Ohm

Table 3-10: Full Load Resistance – Ls Series

3.8 Multi-box Configurations (-MB Option)

Multi-box configurations are identical to a two or three box system except each chassis (box) has its own controller. When connected as a multi-chassis system through the system interface, the controller in the auxiliary chassis is disabled and the entire system is controlled from the master unit. Operation is identical to a normal multi-box model. E.g. a 9000Lx/2-MB is connected and operated the same way as a 9000Lx/2. While a 9000Lx/2 will have one chassis with a blank front panel, a 9000Lx/2-MB will have a controller on both front panels of which only one is used when configured as a 9000Lx/2. The other controller will display a message indicating it is operating as an auxiliary unit¹.

The benefit of the -MB option is that both units can be separated and operated independently. To do so, proceed as follows:

1. Turn off both units.
2. Disconnect the output terminals (1,2,3, COM or A,B,C, NEUT) from each other.
3. Disconnect the system interface cable between the two (or three) units.

When powered up, each unit will power up as a stand-alone unit. Connection diagrams for a -MB system are identical to those for a 9000Lx/Ls/2, 12000Lx/Ls/2, 13500Lx/Ls/2 or 1800Lx/Ls/3. See section 3.5.3, Figure 3-4 and Figure 3-5 for wiring diagrams.

3.8.1 Power Up and Power Down sequence.

A multi-box Lx/Ls system can be turned on in either order. Generally, it is recommended to turn on the auxiliary unit before turning on the master unit and turn off in the opposite order but no damage will occur if the order is reversed.

Note: *It is not recommended to turn off either unit without turning off the other unit and then turning it back on. This may result in miscellaneous error messages occurring on the unit that was not powered down. If one unit has been turned off, turn off all units first before turning the system back on.*

If a master unit is to be used by itself, it is not sufficient to just leave the auxiliary unit off while the system interface cable remains connected. Disconnect the system interface from the back of the master unit and then turn the unit on for stand-alone use.

¹ This message will disappear when the controls on the auxiliary unit are operated. However, changing settings on the auxiliary unit controller will not affect the output. Use the master unit controller and/or remote control interface to operate the system.

3.9 Clock and Lock Mode (-LKM/-LKS Option)

Clock and lock mode operation of two or more Lx or Ls AC power sources is available only if the -LKM and -LKS options have been installed at the factory. With these options installed, it is possible to lock an auxiliary unit (-LKS) to a master unit (-LKM). The master unit controls the frequency. This configuration can be used to create multiphase power systems such as split-phase or six phases. The auxiliary unit must be set to external clock mode from the Control screen. See section 4.2.5.

Two BNC connectors are provided on the rear panel of the Lx/Ls for clock and lock mode. Both need to be connected between the master and auxiliary unit. On the master unit (-LKM), both are outputs. On the slave unit (-LKS), both are inputs. Do not connect these BNC's between two master units (-LKM's) or damage to the unit could result.

Refer to Figure 3-6 for the required connections between the -LKM and -LKS units. The example is shown for two units, one master, one auxiliary. More than one auxiliary can be used to create additional phase outputs. In this case, the BNC cables can be daisy chained using BNC T connectors.

WARNING: DO NOT CONNECT THE AC OUTPUTS OF THE -LKM AND -LKS UNITS TOGETHER. CLOCK AND LOCK OUTPUTS CANNOT BE PARALLELED TO OBTAIN HIGHER OUTPUT CURRENTS.

Do not use clock and lock mode to obtain higher power capability on the same phase(s). For higher power configurations, use the multi-chassis configuration through the system interface connection instead. Refer to section 3.5.3 for multi-chassis configuration and connection information.

The frequency of the auxiliary unit will track that of the master. The output phase angle of phase 1/A will be locked to the auxiliary unit as well to within 3°. This allows split phase or six phase configurations to be created.

3.9.1 Configuration settings

Units configured with the -LKM option will show the Clock as INT (internal) and the mode as CLK/LOC on the CONTROL screen. Units configured with the -LKS option can be set to INT (internal) or EXT (external) clock from the CONTROL screen. The MODE setting on the CONTROL screen of the -LKS unit determines the power on state for the clock setting. When set to STAN (Stand-alone operation), the unit powers up with INT clock. When set to CLK/LOC mode, it powers up in EXT clock mode suitable to clock and lock system operation. See section 4.2.5 for details.

3.9.2 Frequency measurements on -LKS units

Lx or Ls models configured with the -LKS option used in a clock and lock configuration will not accurately measure frequency if the programmed frequency of the master unit (-LKM) exceeds 2000 Hz unless the frequency setting of the -LKS is set to the a value close to the programmed frequency of the -LKM master unit. Setting the -LKS programmed frequency when it is operating as a clock and lock auxiliary does not affect its actual output frequency as it is controlled by the -LKM master unit. This provides the controller with the required information to accurately measure the frequency.

3.9.3 Lx versus Ls Differences

The Lx and Ls Series differ in how to control the phase angle of phase 1/A. On the Ls series, setting the phase angle for phase A on the auxiliary unit will result in all three phases of the auxiliary unit shifting by the same amount. Thus, programming the auxiliary unit to 60° on phase A will result in a 60 degree offset between the two phase A outputs, B outputs and C outputs.

On the Lx Series, programming phase 1 of the auxiliary unit does not rotate phase B and C on the auxiliary unit as well. There are two ways to accomplish this:

1. Program all three phases on the auxiliary unit with the same phase offset. Eg. Program phase 1 to 60°, phase 2 to 300° and phase 3 to 180°.
2. Set the phase 1/A offset calibration coefficient for phase 1/A to the desired offset. This will rotate all three phases, similar to setting the phase A angle on the Ls Series.

This discrepancy is caused by the requirement to maintain backward compatibility with the HP6834B, which did not support Clock and Lock capability.

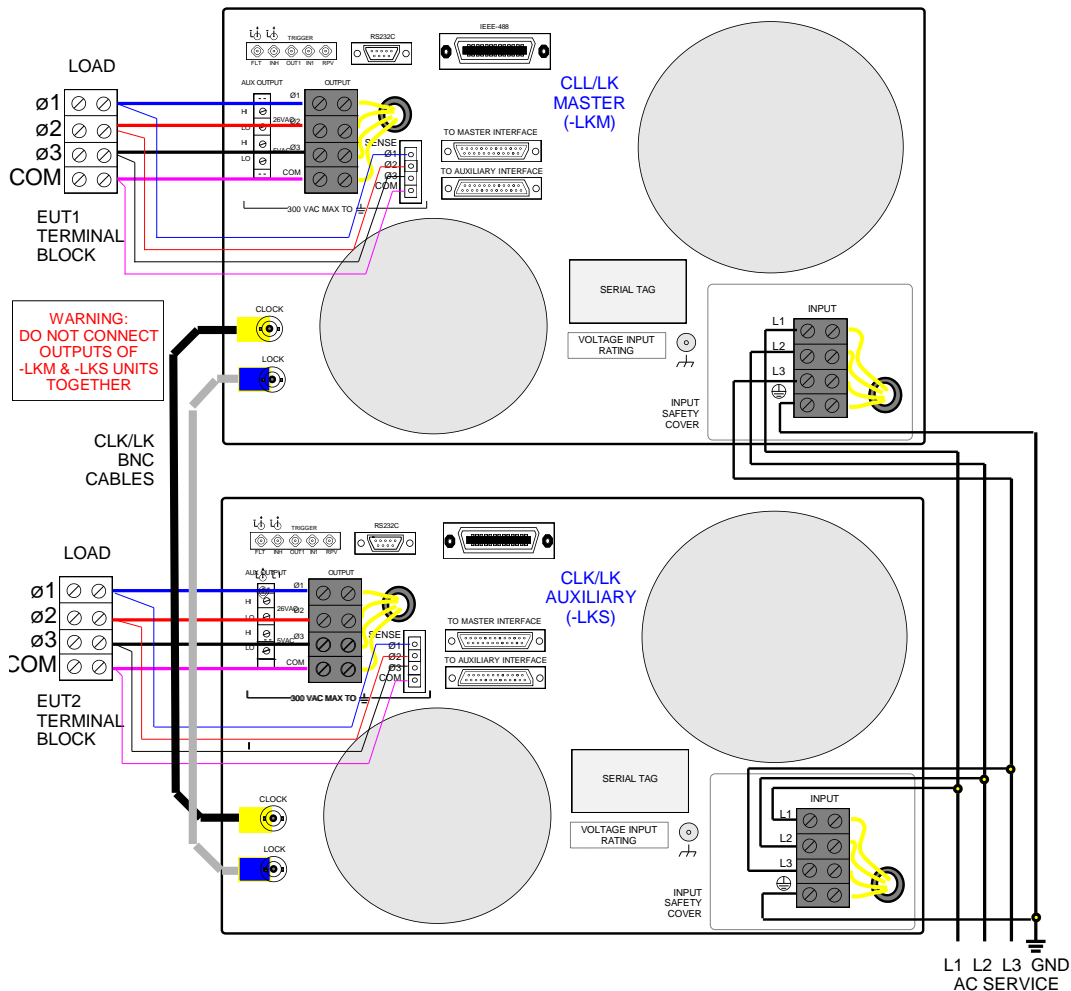

Figure 3-6: Clock and Lock Connections

4. Front Panel Operation

4.1 Tour of the Front Panel

Before operating the AC source using the front panel, it helps to understand the operation of the front panel controls. Specifically, the operation of the knob, keyboard and the menu layout are covered in the next few paragraphs.

4.1.1 Front Panel Controls and Indicators



The front panel can be divided in a small number of functional areas:

- Mains circuit breaker
- Keyboard/ Display panel:
 - Status Indicator lights
 - Shuttle knobs (Voltage / Frequency)
 - LCD display
 - MENU and CURSOR keys

4.1.2 System On/Off Circuit Breaker

The circuit breaker located on the top left side of the front panel of the unit and disconnects the three phase Line input. As such, the circuit breaker acts as a power on/off switch for the Lx Series unit.

When the input current rating of the Lx/Ls Series AC power source is exceeded or an input over voltage condition occurs, the circuit breaker will trip.

Note that for multi-chassis systems, it is recommended to turn the Master unit ON first and then the Auxiliary unit(s). To turn the system off, turn OFF the Auxiliary unit(s) first and then the Master unit.

4.1.3 Status Indicator Lights

Eight yellow LED status indicators are located on the left hand side of the keyboard/display panel. These LED's correspond to the following conditions:

Hi Range	The Hi Range LED is on when the high voltage output range has been selected.
Overtemp	The Overtemp LED indicates an overheating problem inside the unit. This is an abnormal condition, which will cause the unit to shut off. Check the air openings to make sure they are not blocked.
Overcurrent	The Overcurrent LED indicates an output overload condition. This condition can be controlled by setting the current limit value in the PROGRAM menu. Removing the load using the OUTPUT ON/OFF button will recover from an overload condition when in CV mode.
Remote	The Remote LED indicates that the unit is in remote control mode. If the IEEE-488 interface is used, this indicator will be lit whenever the ATN line (Attention) line is asserted by the IEEE controller. If the RS232C interface is used, the REMOTE state can be enabled by the controller using the SYST:REM command. Any time the Remote LED is lit, the front panel of the power source is disabled. Note: The BACK button doubles as a GOTO LOCAL button (LOCAL) while the unit is in remote state. This allows the user to regain control of the front panel. The LOCAL button can be disabled by sending a Local Lockout bus command. This prevents unauthorized changes of settings in ATE applications.
Output on/off	The Output on/off LED indicates the output relay status. If the LED is off, the output relays for all output phases are open and the external sense lines are wrapped around internally. If the LED is on, the output relays are closed and the external sense lines are connected to the SENSE terminal block.
ØA, ØB, ØC	The ØA, ØB, ØC LED indicates the output phase selection for either settings or measurements. Phase selection can be changed using the Phase button to the right of the MEMU keys. Pressing the Phase button repeatedly will cycle through phase A, B, C and ALL PHASES. The ØA, ØB, ØC indicators correspond to outputs Ø1, Ø2 and Ø3 on the Lx Series rear panel and ØA, ØB, ØC on the Ls Series rear panel respectively. If all three phase selection LED's are lit, all three phases are selected and changes made to voltage and current limit settings will apply to all three phases. Note that in single phase mode, the ØA LED is always lit and the Phase button is inactive.

4.1.4 The Shuttle Knobs

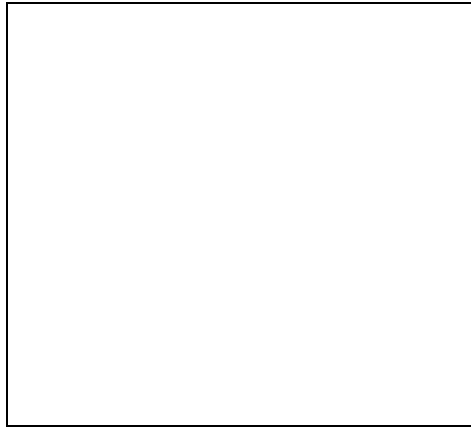

Figure 4-1: Shuttle Knob

The shuttle knobs are located to the right of the LCD screen and are used to change setup parameters. Note that it cannot be used to move the cursor position between menu fields. Use the UP and DOWN arrow keys for this.

The shuttle knob can operate in one of two distinct modes of operation:

MODE	DESCRIPTION
IMMEDIATE mode	Any time the ENTER key is pressed, the Lx/Ls Series returns to its normal mode of operation. In this mode, changes made with the shuttle knob will take immediate effect. The IMMEDIATE mode is useful for slewing output values such as voltage and frequency and observing the effect on the load.
SET mode	When the Set key is pressed again while the PROGRAM screen is already displayed, changes made with the shuttle to any output parameter will not take effect until the ENTER key is pressed. In this mode, any changes made to a setup menu will have a blinking cursor to indicate the pending change condition. This mode allows changes to be made to all output parameters and executing them all at once by pressing the ENTER key.

4.1.5 Menu Keys

The Lx/Ls Series is operated through a series of menu's. These menus can be reached by using a number of menu keys located along the bottom of the LCD display and the UP/DOWN cursor keys. Several menus have more than two entries. Since the LCD display only has two display lines, additional entries may not be visible and can be reached only by scrolling up or down using the UP/DOWN cursor keys. The following menu keys are available:

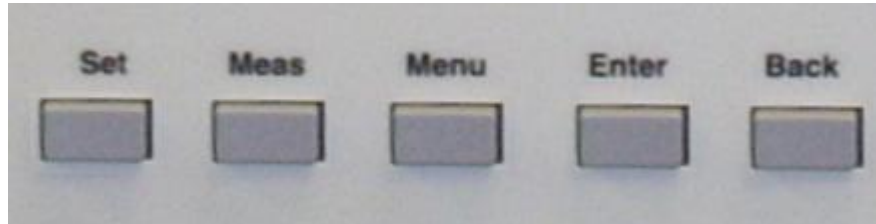

Figure 4-2: Menu Keys

KEY	DESCRIPTION
Set	<p>The Set key selects the output setting screen. While this screen is displayed, the voltage and frequency shuttle knobs can be used to change voltage and frequency for the selected phase(s). Additional output settings such as current limit can be reached by using the down ▼ cursor key.</p> <p>For tests implemented in firmware such as the –160 and –704 options, the SET key can be used to skip to the next test in a test sequence.</p>
Meas	<p>The Meas key selects the measurement screen for the selected phase. If all three phases are selected, the measurement data for phase A will be displayed. There are no user changeable fields in the measurement screen. The voltage and frequency shuttles are active while the measurement screen is displayed. Additional measurement data can be displayed by using the up ▲ and down ▼ cursor keys.</p>
Menu	<p>The top level menu is accessed by pressing the Menu key. Refer to section 4.2 for details on available menus.</p>
Enter	<p>The Enter key is used to confirm selections made in menu's or to active settings made in SET mode.</p>
Back	<p>The Back key may be used to back up to the previous menu level or previously selected screen. It can also be used as a backspace key to delete the last digit entered.</p> <p>For tests implemented in firmware such as the –160 and –704 options, the BACK key can be used to abort a test in progress.</p> <p>If the unit is in remote mode, (Remote LED is lit), the front panel of the power source is disabled. The BACK button doubles as a GOTO LOCAL button (LOCAL) while the unit is in remote state. This allows the user to regain control of the front panel. This LOCAL button can be disabled by sending a Local Lockout bus command. This prevents unauthorized changes of settings in ATE applications.</p>

4.1.6 Cursor Keys

The cursor keys can be used to scroll through a list of menu entries.:

CURSOR UP (▲)

The UP key moves the cursor position upwards one position to the previous available cursor position. If the present cursor position is at the top of the right hand column, the cursor is moved to the bottom position of the left hand column. If the present cursor is at the top of the left hand column, the cursor is moved to the bottom of the right hand column.

CURSOR DOWN (▼)

The DOWN key moves the cursor position downwards one position to the next available cursor position. If the present cursor position is at the bottom of the left hand column, the cursor is moved to the top position of the right hand column. If the present cursor is at the bottom of the right hand column, the cursor is moved to the top of the left hand column.

4.1.7 Output on/off Key

The **Output on/off** key located to the left of the Menu keys may be used to control the state of the output relays. The active state is indicated by the LED directly above the on/off key. If the output relays are open (LED is off), the output is floating. The ON/OFF button provides a convenient way to disconnect the load without having to remove any wires.

4.1.8 Phase Key

The **Phase** key may be used to select the desired output phase. (ØA, ØB, ØC or Ø1, Ø2, Ø3). Pressing the **Phase** button repeatedly will cycle through phase A, B, C and ALL PHASES. The **ØA, ØB, ØC** indicators correspond to outputs Ø1, Ø2 and Ø3 respectively.

If all three phase selection LED's are lit, all three phases are selected and changes made to voltage and current limit settings will apply to all three phases.

Note that in single-phase mode, the ØA LED is always lit and the Phase button is inactive.

4.1.9 LCD Display

The LCD display of the Lx/Ls Series power source provides information on instrument settings and also guides the user through the various menus. A sample of the measurement display screen is shown in Figure 4-3. Due to the two line (x 20 characters) display limitation of the LCD display, most menus are accessed by scrolling through two or more entries. Alternatively, the Menu key may be pressed repeatedly to access additional available menu entries.

The active cursor position is indicated by a LEFT POINTING ARROW (←) and can be moved by using the UP (▲) and DOWN (▼) keys located to the right of the LCD display.



Figure 4-3: Measurement Screen

4.2 Menu Structure

The next few pages show a map of the available menus in the Lx/Ls Series. All menus can be reached by repeatedly pressing the **Menu** key. Frequently used menus have a short cut key that provides direct access. Examples of such menus are Program and Measurements. In any case, there are never more than two levels of menus although some menus may be spread across more than one screen.

4.2.1 Power on screens

At initial power up, the Lx/Ls Series power supply will display important configuration information in a series of power on screens. These displays are only visible for a short period of time and will not re-appear until the next time the unit is turned on.

There are three screens that will appear in the same order:

1. Company and firmware information. Displays the manufacturer (Cal Inst., which is short for California Instruments and the firmware part number and revision. The firmware part number starts with CIC followed by a three-digit code and dash number. The firmware revision has a major revisions before the decimal point and a minor revision after the decimal point.

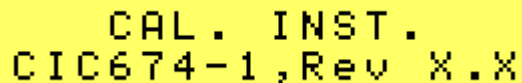

```
CAL . INST .  
CIC674-1,Rev X.X
```

2. Model and Serial number information. The model will be a function of the configuration and will include the series designation (LX). The serial number is a 5 digit number. This number should match the model type sticker located on the back of the unit.

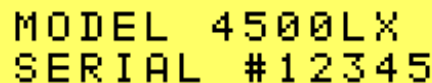

```
MODEL 4500LX  
SERIAL #12345
```

3. Self test result. If all internal functions pass the power-on self-test, the message "SELF TEST PASSED" will appear. If any part of the internal self-test fails, an error message will be displayed instead. This information may be useful when calling in for service support.



```
SELF TEST PASSED
```

Once the power on sequence is completed, the power source will always revert to the PROGRAM screen shown here.



```
VOLT          0.00V⚡  
FREQ          400.0HZ
```

The power source is now ready to be used.

4.2.2 Top Level Menus

The following top-level menu choices can be accessed using the **Menu** key:

ENTRY	DESCRIPTION
PROGRAM	The PROGRAM menu allows primary output parameters such as voltage, frequency, current limit, waveform shape and voltage range to be changed.
CONTROL	The CONTROL menu allows secondary setting parameters such as sense mode, phase mode and ALC mode to be changed.
MEASUREMENTS	The MEASUREMENT screen is not a menu in that no user entries are required. It displays read-back data.
TRANSIENTS	The TRANSIENTS menu allows output transients to be programmed.
REGISTERS	The SETUP REGISTERS menu allows complete instrument settings and transient list programs to be saved to nonvolatile memory.
CONFIGURATION	The CONFIGURATION menu allows changes to be made to configuration settings such as the IEEE-488 address, RS232C baudrate, power on state and Master/Auxiliary control mode.
OUTPUT CAL	The OUTPUT CAL menu provides access to the LCD viewing angle and Calibration password entry. If the correct calibration password is entered, additional Calibration screens can be accessed.
MEAS CAL	The MEAS CAL menu allows for calibration of the AC source measurement system.
APPLICATIONS	The APPLICATIONS menu provides access to the optional firmware application programs that may be installed in the Lx/Ls Series AC source.
OPTIONS	The OPTIONS menu provides access optional functions that may be present on the Lx/Ls unit.
ETIME/TEMP	The ETIME/TEMP screen displays the Elapsed time (Time the unit has been in operation) in hours, minutes and seconds. It also displays the internal temperature of the unit in degrees Celsius.
LIMITS	The LIMITS screen display the hardware configuration limits of the AC power source. It is for display purposes only and the user can change none of these fields.

4.2.3 Menu Tree

Lx/Ls Series

Menu Structure

LEVEL 1

PROGRAM
CONTROL

LEVEL 2

VOLT 120.0V
FREQ 400.0HZ

VRANGE 150.0V
PHASE 0.0°

FUNC >SINE
CLIP LEV 0

CURR 24.34A
OL MODE CV

SENSE INT
SYNC INT

CLOCK INT
MODE STAN

ALC STATE ON
VOLT REF INT

IMP STATE OFF
LEVEL 200mΩ

NO OUTP THREE
ST PHASE RAND

MEASUREMENT
TRANSIENT

100.00V 2.349A
400.0HZ 234.9W

238.7VA 1.00Cf
2.349Ap 0.98Pf

0.18%A 10.559A
0.19%V 120.0°

TRAN ST IDLE
COUNT 10

TRIG SOURCE IMM
TRAN STEP AUTO

LEVEL 1

REGISTERS
CONFIGURATION

LEVEL 2

SAVE REG #
RECALL REG #

ADDRESS 01
BAUD RATE 38400

PON REG RST
CONTROL MASTER

LANGUAGE SCPI

OUTP CAL
MEAS CAL

VIEW ANGLE -5
CAL PWORD 100

VOLT F/S 450
PHASE OFST 1.0

MVOLT F/S 1100
MCURR F/S 1200

APPLICATIONS
OPTIONS

MIL704 ON
DO160 ON

MS704

LANGUAGE ON
ADVANCE ON

MODE ON
CLOCK/LOC N/A

ETIME/TEMP
LIMITS

ETIME 21:20:03
TEMP 25:33°C

LIM LVOLT 150.0V
HVOLT 300.0V

LIM LFREQ 45.00HZ
HFREQ 1200HZ

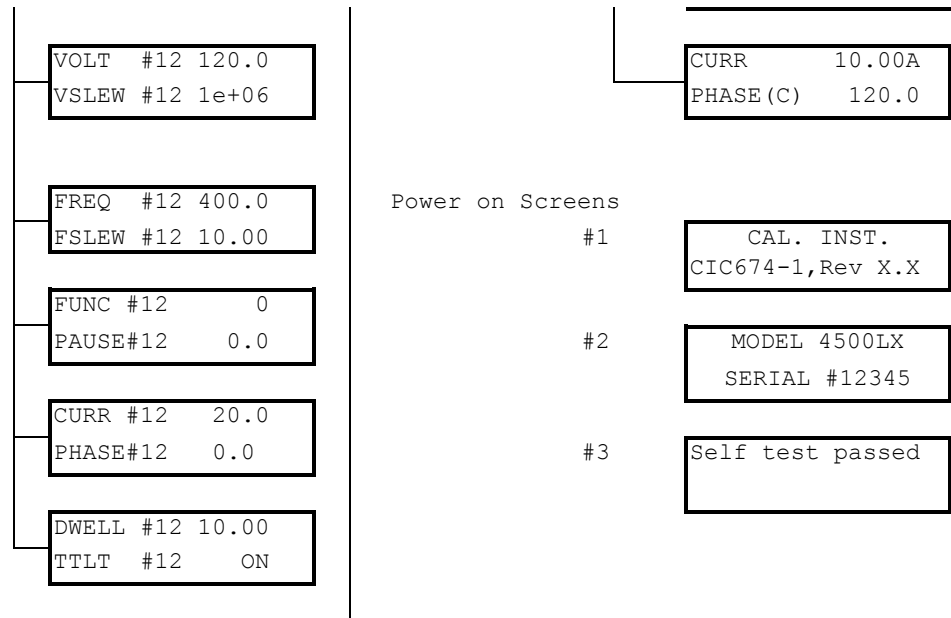

Table 4-1: Menu Tree

4.2.4 PROGRAM Menu

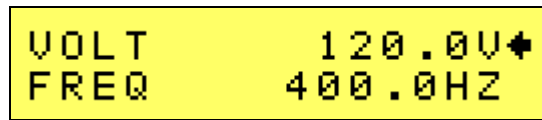

Figure 4-4: PROGRAM Menu

The PROGRAM menu is shown in Figure 4-4. It can be reached in one of two ways:

1. by selecting the **Menu** key, selecting the PROGRAM entry and pressing the **Enter** key.
2. by pressing the **Set** key.

The PROGRAM menu is used to change primary output parameters. Less frequently used parameters are located in the CONTROL menu.

The following choices are available in the PROGRAM menus:

ENTRY	DESCRIPTION
VOLTAGE	Programs the output voltage in Vrms. The voltage can be changed from 0 to its max range value as determined by the configuration settings and the selected voltage range using the Voltage shuttle.
FREQ	Programs the output frequency The frequency can be changed from its min to its max value as determined by the configuration settings using the Frequency shuttle.
VRANGE	Selects 150V or 300V voltage range (if available). The actual range values may be different depending on the configuration. The value of this field can be changed with either Voltage or Frequency shuttle as long as the active pointer (←) points to the VRANGE entry. If only one voltage range is available, this field

ENTRY	DESCRIPTION
	cannot be changed.
PHASE	Selects the phase angle between the external clock and the output of the AC source. If the clock source is internal, this parameter has no effect.
FUNC	Selects the waveform for the selected phase. Available choices are SINE, SQUARE and CLIPPED or any user defined waveform that was downloaded to the AC source waveform memory using the IEEE-488 or RS232C interface.
CLIP LEVEL	Sets the clip level for the CLIPPED sine wave in percent VTHD. The range is 0 to 20 %.
CURR	Sets the current limit value for the current detection system. When the load current value exceeds the set current limit, a fault condition is generated. The actual response of the AC Source to a current limit fault is determined by the protection mode selected in the OL MODE field. (CC = Constant Current, CV = Constant Voltage).
OL MODE	Sets the current limit over load mode. The actual response of the AC Source to a current limit fault is determined by this setting. Available settings are CC for Constant Current mode or CV for Constant Voltage mode. In CV mode, the AC source output will trip off and stay off until re-engaged. In CC mode, the voltage will be reduced to maintain the set current level.

4.2.5 CONTROL Menus

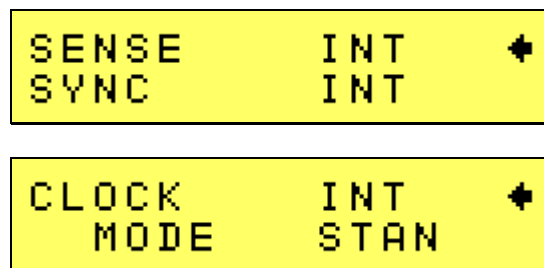

Figure 4-5: CONTROL Menus

The CONTROL menu is shown in Figure 4-5 and can be reached by selecting the **Menu** key, selecting the CONTROL entry using the DOWN cursor key and then pressing the **Enter** key.

The CONTROL menu is used to change secondary output parameters. The following choices are available in the CONTROL menu:

ENTRY	DESCRIPTION
SENSE	Selects internal or external remote sense mode. If INT is selected, the voltage is sensed at the output terminal block. If EXT is selected, the voltage is sensed at the external sense connector. If external sense is selected, care must be taken to connect the external sense lines at the load. For sense leads longer than 1 meter, twisted pairs

ENTRY	DESCRIPTION	
	should be used.	
SYNC	Selects the external sync mode if available. Default is internal sync, which means a free running time base. The timebase can be synchronized to either the AC line frequency (-LNS option) or an external sync signal (-EXS option) depending on the installed option.	
CLOCK	Selects internal or external clock source. The Lx/Ls Series controller uses an open-air crystal time base with an accuracy of 100 ppm. The external clock mode is used to support the -LKS option. For use as an auxiliary unit in a clock and lock system, this field must be set to EXT. A unit with -LKS option can be used stand-alone if needed by setting the INT clock mode.	
	INT	Default, internal clock.
	EXT	Auxiliary unit (-LKS) driven by master (-LKM) clock input. Note: When selecting EXT mode, make sure the Clock and Lock BNC cables are connected to the Master (-LKM) unit. If not, there will be no output on the -LKS unit. See section 3.9 for connection information.
MODE	Power on clock mode. The following two modes can be selected.	
	STAND	Power up in INT (internal) clock mode for stand-alone operation. This is the only mode for Lx/Ls unit without the -LKS option. For units with the -LKM option installed, this field is fixed to CLK/LOCK. For units with the -LKS option installed, this field can be changed to CLK/LOCK for use as an auxiliary unit in a clock and lock system or to STAND for use as a stand alone unit.
	CLK/LOCK	Fixed on master (-LKM) unit configuration in a clock and lock system. Power up with EXT (external) clock mode on unit with -LKS option. (See OPTION menu section.). Note that this field cannot be changed if the -LKM option is installed. The frequency resolution below 81.9 Hz in MAST clock and lock mode is reduced to 0.1 Hz from the normal 0.01 Hz. If the -HF option is installed, frequency resolution on the -LKM unit is fixed at 1 Hz.

ENTRY	DESCRIPTION				
ALC STATE	<p>Sets the Auto Level Control (ALC) mode. This mode uses the internal measurement system to zero regulate the output. There are three modes of operation:</p> <p>OFF No measurement based output regulation.</p> <p>REG Output regulation is enabled. AC source will continuously regulate output but will not trip off output. (Note: This mode requires firmware revision 0.98 or higher).</p> <p>ON Output regulation is enabled and output will fault (trip off) with Error 801 "Output Voltage fault" if regulation cannot be maintained and the programmed output voltage is 10Vrms or higher. No error is generated for settings below 10 volt.</p> <p>In most situations, the ALC mode should be set to REG or ON for optimal performance.</p> <p>Note: The ALC mode only functions for programmed output voltages above 5 Vrms.</p>				
VOLT REF	<p>Selects internal or external voltage programming. Select INT for programming of voltage from the front panel or over the bus. Select EXT to use the RPV (remote programming voltage). The RPV input expects a 0-10 Vdc signal for 0 to full-scale voltage.</p>				
IMP STATE	<p>Sets output impedance mode. Available settings are:</p>				
	<table border="1"> <tr> <td data-bbox="587 1123 776 1207">OFF</td> <td data-bbox="776 1123 1408 1207">The output impedance is at its minimum possible value and the source zero-regulates.</td> </tr> <tr> <td data-bbox="587 1207 776 1323">ON</td> <td data-bbox="776 1207 1408 1323">The output impedance is maintained at the set level by reducing the output voltage as a function of the load current as needed.</td> </tr> </table>	OFF	The output impedance is at its minimum possible value and the source zero-regulates.	ON	The output impedance is maintained at the set level by reducing the output voltage as a function of the load current as needed.
OFF	The output impedance is at its minimum possible value and the source zero-regulates.				
ON	The output impedance is maintained at the set level by reducing the output voltage as a function of the load current as needed.				
LEVEL	<p>This field is only valid is the IMP STATE is set to ON. It sets the desired output impedance level. The available range is a function of the voltage and current ranges of the AC source.</p>				
NO OUTP	<p>Selects SINGLE or THREE phase mode of operation. In SINGLE phase mode, all current is delivered to the ø1 and COM terminals of the OUTPUT terminal block.</p> <p>Note that even in SINGLE phase mode, a voltage is present at ø2 and ø3 terminals. Connect only a single phase load when operating in single phase mode.</p>				

ENTRY	DESCRIPTION
ST PHASE	Selects the start phase angle for output changes made to either voltage or frequency. This allows changing the output at a specific phase angle. The Output on/off key also uses this phase angle setting to program the output voltage up to the set level after the output relay is closed. The default value for this field is RAND. To set the start phase angle, set the cursor to the ST PHASE field and use either shuttle knob to adjust between $\pm 360^\circ$. To set to RAND, use the BACK key.

4.2.6 MEASUREMENTS Screens

The Lx/Ls Series uses a DSP based data acquisition system to provide extensive information regarding the output of the Source. This data acquisition system digitizes the voltage and current waveforms and calculates several parameters from this digitized data. The results of these calculations are displayed in a series of measurement data screens. A total of three measurement screens are used to display all this information.

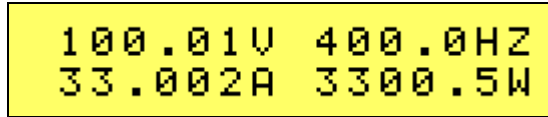

Figure 4-6: MEASUREMENT Screen

The three Measurement screens available on the Lx Series are not menus in that no changes can be made anywhere. Instead, these three screens provide load parameter readouts. The measurement screens can be reached by successively pressing the **Meas** key, which will toggle to all available screens. For Ls Series, only the first two screens are available unless the –ADV option is installed.

In three-phase mode, measurements are available for each phase individually. To select the desired phase, use the PHASE key to toggle through phase A, B, C, or ABC. The ABC mode displays the data for phase A only.

The following parameters are available in the measurement screens:

ENTRY	DESCRIPTION
MEASUREMENTS 1	
VOLTAGE	This value is the true rms output voltage measured at the voltage sense lines.
CURRENT	This value is the true rms output current drawn by the load.
FREQ	The output frequency is measured at the sense lines. For Lx/Ls units with –LKS option, see note below.
POWER	This value is the real power.
MEASUREMENTS 2	
VA POWER	This value is the apparent power.
VAR POWER	This value is the reactive power.
POWER FACTOR	This readout shows the power factor of the load.
CREST FACTOR	This readout displays the ratio between peak current and rms current.
MEASUREMENTS 3	
VOLT THD	This readout displays the total voltage distortion for the selected phase. The distortion calculation is based on the H2 through H50 with the RMS voltage in the denominator. Note that some definitions

ENTRY	DESCRIPTION
	<p>of THD use the fundamental component (H1) of the voltage as the denominator.</p> <p>Lx/Ls units with firmware revision 0.88 or higher can be programmed to use the fundamental component as the denominator. This mode can only be programmed over the bus by sending the “MEAS:THD:MODE FUND” command. At power up or after a reset command, the mode will revert back to RMS.</p>
CURR THD	<p>This readout displays the total current distortion for the selected phase. The distortion calculation is based on the H2 through H50 with the RMS current in the denominator. Note that some definitions of THD use the fundamental component (H1) of the current as the denominator.</p> <p>Lx/Ls units with firmware revision 0.88 or higher can be programmed to use the fundamental component as the denominator. This mode can only be programmed over the bus by sending the “MEAS:THD:MODE FUND” command. At power up or after a reset command, the mode will revert back to RMS.</p>
PEAK CURR	<p>This readout reflects the peak current value detected at the output. To measure inrush current for a unit under test, open the output relay and reset the peak current value using the PEAK CURR RESET entry. Then program the output voltage and frequency and turn on the output relay. The peak current measurement will continuously track the maximum current value detected until reset.</p>
PHASE	Relative voltage phase angle measurement with respect to phase A.

Update Program Functions from Measurement Screen

The Shuttles can be used to update voltage and frequency settings from the measurement screen. While the measurement screens is visible, the **Voltage** and **Frequency** shuttle continue to operate.

Frequency measurements on –LKS units

Lx or Ls models configured with the –LKS option used in a clock and lock configuration will not accurately measure frequency if the programmed frequency of the master unit (-LKM) exceeds 2000 Hz unless the frequency setting of the –LKS is set to the a value close to the programmed frequency of the –LKM master unit. Setting the –LKS programmed frequency when it is operating as a clock and lock auxiliary does not affect its actual output frequency as it is controlled by the –LKM master unit. It does provide the controller with the required information to accurately measure the frequency.

4.2.7 TRANSIENT Menu

TRAN ST COUNT	IDLE 1	TRIG SOURCE IMM TRAN STEP AUTO
VOLT #12 120.4 VSLEW #12 20.00	CURR #12 30.00 PHASE#12 120.0	

The transient menu is used to program and execute user-defined output sequences. These output sequences are defined as a sequential list of voltage and/or current settings that can be executed in a time controlled manner.

Each step in these lists is assigned a sequence number ranging from #0 through #99. The numbering determines the order in which each step is executed.

Each step can control the voltage setting, voltage slew rate, frequency setting, frequency slew rate and dwell time. The dwell time determines how long the output dwells at the current step before progressing to the next step. Dwell times can range from 1 msec up to 900000 secs.

Transient lists can be set up from the front panel or over the bus. The transient list can be saved with the rest of the front panel settings in one of the setup registers. (See Register Menu).

ENTRY	DESCRIPTION	
TRAN ST	Indicates the status of the transient system. Available modes of operation are:	
	IDLE	Transient system is in IDLE or inactive state. To start a transient list, press the ENTER key while on the TRAN STATE field. Note that the output must be ON to run a transient program or an error message will be displayed.
	WTRIG	Transient system is armed and waiting for a trigger event.
	BUSY	Transient system is active. A transient list execution is in progress.
COUNT	Sets the execution count for the transient system. A count of 1 indicates the transient will run 1 times. The count value can be set with either voltage or current knob while the cursor is on this field. The count range is from 1 through 2E+08. Values below 200,000 are displayed in fixed point notation. Value higher than 200,000 are displayed as a floating point number (2E+05). The display has insufficient characters to display the entire mantissa so entering values above 2E+05 from the keyboard is not recommended.	
TRIG SOURCE	Indicates the trigger source for transient system. Available trigger sources are:	
	IMM	Immediate mode. The transient is started from

ENTRY	DESCRIPTION	
		the front panel using the ENTER key.
	BUS	Bus mode. The transient system is started by a bus command or a group execute trigger (GET).
	EXT	External mode. The transient system is started by a user-provided external TTL trigger signal on TRIGGER IN1.
TRAN STEP	Indicates the transient system execution mode. Available modes are:	
	AUTO	When triggered, the transient system will automatically execute each list point sequentially without waiting for a trigger between list points. This execution is paced by the dwell time set for each data point.
	ONCE	When triggered, the transient system will execute the first list point and wait for a new trigger once the dwell time expires. This allows triggered execution of each step in the transient list.
List parameters:		
VOLT	Step #	Voltage set point
VSLEW	Step #	Voltage slew rate in V/sec
FREQ	Step #	Frequency set point
FSLEW	Step #	Frequency slew rate in Hz/sec
FUNC	Step #	Waveform selection. Available choices are Sine, Square, Clipped or any of the user provided waveforms in waveform memory.
PAUSE	Step #	Delay
CURR	Step #	Current set point
PHASE	Step #	Phase angle set point. (Not relevant for phase A if clock mode is internal.)
DWELL	Step #	Dwell time in seconds. Range is 0.001 to 900000
TTLT	Step #	ON: Generates an output trigger pulse at this list step. OFF: No output trigger. The output trigger is available on the TRIG

ENTRY	DESCRIPTION	
		OUT1 SMC connector on the rear panel.

Transient List points data entry method.

Transient list points are numbered sequentially from 0 through 99 and executed in this order. Each list point or list entry has 6 parameters as shown in the table above. To enter list point data, the right hand knob (**Frequency**) is used to increment or decrement the parameter value. The left-hand knob (**Voltage**) is used to increment or decrement the list point sequence number (#). The sequence number can only be increased to the next available empty (new) list point.

To move to the next or previous parameter, use the UP (▲) or DOWN (▼) cursor keys

The voltage and frequency slew parameters can be set to their maximum slew rates by turning the **Frequency** knob counter clock-wise past 0. This will cause the slew parameter to 'wrap around' to its maximum available value.

It is not necessary to use all list points, only as many needed to accomplish the desired output sequence.

Setting Data Values

Data values can be set for each point in a list. If all data values in a specific list are going to be the same value (e.g. the current limit parameter is set to the same value for the entire transient program), only the first data value for that parameter has to be set. Setting only the first data point will automatically repeat that value for all subsequent points in the transient list.

Setting Slew Rates

Very often, output changes must be done as fast as the power source can make them. This means the transient list slew rate is set to its maximum value. If this is the case for all the data points in the list, it is sufficient to set just the first data point's slew rate for either voltage and/or current. Setting only the first point of any parameter in the list will automatically cause all points for that parameter to be set to the same value. This saves a lot of data entry time.

If however, one or more data points require a specific slew rate such as needed to do a ramp, all other points have to be specifically set to their required slew rates, including the maximum slew rate.

Saving Transient Lists

Once completed, a transient sequence can be saved along with the steady state setup of the instrument by using the REGISTER, SAVE menu. Registers that may be used for this purpose are 1 through 15. It is advisable to do so, especially for longer transient lists.

4.2.8 REGISTERS Menu

```
SAVE   REG #1
RECALL REG #0
```

The registers menu provides access to the non-voltage setup storage of the power source. A total of 8 front panel setups can be stored in registers numbered from 0 through 7. Each register except register 0 can hold the complete front panel setup, including the programmed transient list. This allows for quick recall of different setups and transient programs.

Register 0 is reserved to be used as the power-on setting as assigned by the user. To have the power source start in a specific setting, save the desired setting to Register 0 and assign register zero as the power-on default in the CONFIGURATION menu. Alternatively, the Lx/Ls can be set to power up with the RST factory default settings. See 4.9 for factory default settings.

ENTRY	DESCRIPTION	
SAVE	REG 0 – 7	<p>Saves the selected setup and transient list from memory. (Setup only for Reg 0) The left knob (Voltage) may be used to scroll through the available list of setup register numbers. Use the ENTER key to perform the save operation.</p> <p>Register 0 can be assigned as the power-on state setup from the CONFIGURATION menu. A valid setup must be saved in REG0 to do so.</p> <p>Note that REG0 only saves the setup, not the transient list. All other registers also save the transient list.</p>
RECALL	REG 0 – 7	<p>Recalls the selected setup and transient list to memory. (Setup only for Reg 0) The left knob (Voltage) may be used to scroll through the available list of setup register numbers. Use the ENTER key to perform the recall operation.</p> <p>Register 0 can be assigned as the power-on state setup from the CONFIGURATION menu. A valid setup must be saved in REG0 to do so.</p> <p>Note that REG0 only saves the setup, not the transient list. All other registers also save the transient list.</p>

4.2.9 CONFIGURATION Menu

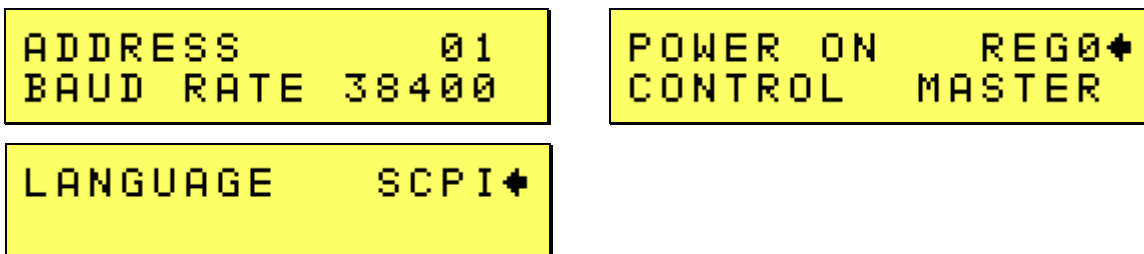

The configuration menu may be used to configure various aspects of the instrument such as the serial port, IEEE-488/GPIB address and the power-on settings of the supply.

ENTRY	DESCRIPTION	
ADDRESS	0 - 31	Sets the selected IEEE / GPIB bus address for the optional IEEE/GPIB interface. Factory default is address 1. The left knob (Voltage) can be used to scroll through the 0 through 31 address range. Do not use address 0 as this address is typically reserved for the GPIB controller.
BAUD RATE	9600 19200 38400 57600 115200	Sets the baud rate for the RS232C serial communications port. Factory default is 38400 baud. Available settings are 9600 through 115200 baud. Either shuttle knob can be used to scroll through these selections.
POWER ON	REG0 RST	Selects either non-volatile REG0 to be recalled automatically at power-on or factory default (RST). Factory default is RST, which recalls the factory settings. Note that to use REG0 for power-on default, the contents of the register must be programmed first. See section 4.2.8. If an empty register is selected, the power source will revert back to RST (factory setting).
CONTROL	MASTER AUX	This is an information-only field that displays the controller operation mode. For a single stand-alone Lx/Ls unit, the mode is always MASTER. Alternatively, the auxiliary mode may be detected if the system interface cable at the rear panel is plugged in and connected to another Lx/Ls unit. In AUX mode, the AC source is controlled by another unit (Master unit). The controller will be disabled and has no control over the amplifiers, the measurements or any other function. A

ENTRY	DESCRIPTION	
		message will be displayed at power indicating it is in Auxiliary mode. You can press any key to get in the menus but no control is possible.
LANGUAGE	SCPI Reserved	The standard bus syntax used by the Lx/Ls Series is the Standard Commands for Programmable Instruments (SCPI). If an alternative syntax such as APE (Abbreviated Plain English) is available, it can be selected from this menu. The APE language is part of the Ls Series –GPIB option.

4.2.10 CALIBRATION Menus

```
VIEW ANGLE    -2
CAL PWORD     0*
```

```
MVOLT F/S    -1242
MCURR F/S    2312
```

The measurement calibration menu can be used to perform routine calibration of the internal measurement system. The recommended calibration interval is 12 months. To enter the calibration screens, the calibration password must be entered first.

Note: Refer to chapter 6 for details on routine calibration procedures and equipment requirements. Do not attempt calibration without consulting the user manual.

This menu also contains the LCD viewing angle adjustment.

ENTRY	DESCRIPTION	
VIEW ANGLE	-10 to +10	LCD viewing angle adjustment.
CAL PWORD	V range	Calibration password required to access all calibration screens. The calibration password is the high voltage range value. [300] The password can be entered using the Voltage shuttle followed by the ENTER key.
		Measurement Calibration Screens
MVOLT F/S	± 9999	Calibration coefficient for full-scale voltage measurement.
MCURR F/S	± 9999	Calibration coefficient for full-scale current measurement.
		Output Calibration Screens
VOLT F/S	± 9999	Calibration coefficient for full-scale voltage output. (calibrated by measurement)
CURR F/S	± 9999	Calibration coefficient for full-scale current output. (calibrated by measurement)

4.2.11 APPLICATIONS Menu

```
APPLICATIONS  ↵
OPTIONS
```

The Applications menu provides access to application specific firmware functions if available. Note that there may be no applications installed in which case this screen will still be shown but has no function.

```
MIL704      ON  ↵
DO160       ON
```

Possible applications are DO160 and MIL704. To access either of the application screens, position the cursor on the APPLICATIONS entry and press the ENTER key. Select the desired application and press ENTER. For information on using these applications, see sections 8 and 9.

4.2.12 OPTIONS Menu

```
APPLICATIONS  ↵
OPTIONS
```

The Options menu provides access to available optional features. Note that there may be no options installed in which case this screen will still be shown but has no function. The option setting are protected and cannot be changed by the user. These screens are provided for information purposes only.

```
LANGUAGE     SCPI  ↵
ADVANCE      ON
```

```
MODE         ON  ↵
CLOCK/LOC    N/A
```

ENTRY	DESCRIPTION	
LANGUAGE	N/A	Standard SCPI command language.
	ON	Ls Model may be equipped with the APE (Abbreviated Plain English) language option for backward compatibility with California Instrument's L Series AC power source. If APE is installed, the language mode can be selected over the bus or from the CONFIGURATION screen. (see section

ENTRY	DESCRIPTION	
		4.2.9).
ADVANCE	ON	Standard on all Lx Series models.
	N/A	This feature is optional on Ls Series models. If installed, this field will display ON. If not, N/A is shown instead.
MODE	ON	Standard on all Lx Series models. Allows the output to be switched between single and three phase modes of operation.
	N/A	This feature is optional on Ls Series models. If installed, this field will display ON. If not, N/A is shown instead.
CLOCK/LOC	N/A	Clock and lock is an option. If no -LKM option is installed, this field will show N/A.
	MAST	-LKM Option installed. The unit can be used as a Clock and Lock system master or stand alone.
	AUX	-LKS option installed. The unit can be used as a Clock and Lock system auxiliary or stand alone.

4.2.13 Elapsed Time and Temperature Screen

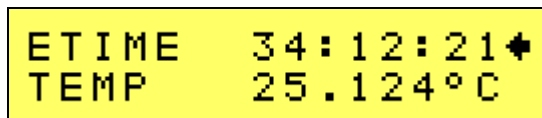

```

ETIME  34:12:21
TEMP   25.124°C

```

The Etime/Temp screen displays the elapsed time since the power source has first been turned on. This is an accumulated total time in hours, minutes and seconds.

The same screen also displays the internal temperature of the power supply.

ENTRY	DESCRIPTION	
ETIME	01:23:45	The ETIME field displays the total accumulated elapsed time for the instrument since it's initial manufacture. This value cannot be changed or reset.
TEMP	37.342°	The TEMP field is not a user selectable parameter but rather a read-out of the internal temperature in degrees Celsius. It is provided for informational purposes only.

4.2.14 LIMIT Menu

```
LIM VOLT 300.0*
LIM CURR 12.8
```

The Limit menu displays the maximum available value for voltage, frequency and current range of the power supply. This screen is used for information only and contains no user changeable fields. The limit values shown cannot be changed.

ENTRY	DESCRIPTION	
LIM LVOLT	Low Voltage Range	Displays maximum available output voltage in the low voltage range.
HVOLT	High Voltage Range	Displays maximum available output voltage in the high voltage range.
LIM LFREQ	Low Frequency Limit	Displays minimum available output frequency.
HFREQ	High Frequency Limit	Displays maximum available output frequency
CURR	C range	Displays maximum available current in low voltage range and single phase mode. If only 2 or 3 phase mode is available, this value is the maximum available current per phase.
PHASE (C)	Phase Setting	Displays phase angle for phase C. Valid values are 120 for three phase or mode configuration, 0 for single phase only configuration. Any other value indicates split (2) phase configuration.

4.3 Output Programming

4.3.1 Set the Output

Output parameters are all set from the PROGRAM screen.

1. Use the MENU key and select the PROGRAM entry.
 2. Press the ENTER key to bring up the PROGRAM menu.
- or
2. Use the PROG key to directly bring up the PROGRAM menu.

There are two methods for programming output parameters:

IMMEDIATE mode

SET mode

4.3.2 Slewing Output Values with the Knob in IMMEDIATE Mode

The default mode of operation is an immediate mode in which changes to output parameters made with the knob or the entry keypad are immediately reflected at the output.

To change the output voltage:

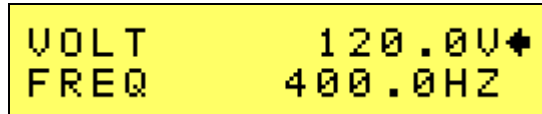

```

VOLT      120.0V
FREQ      400.0HZ
  
```

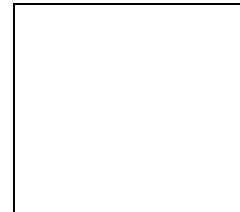

1. Place the cursor on the VOLT entry
2. Rotate the **Voltage** knob clockwise to increase the value, counterclockwise to decrease the value

These changes take effect immediately.

To change the output frequency:

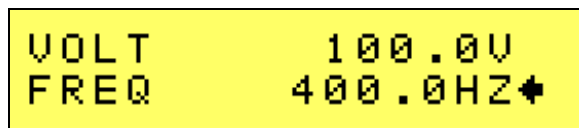

```

VOLT      100.0V
FREQ      400.0HZ
  
```

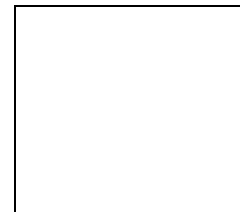

1. Place the cursor on the FREQ entry
2. Rotate the **Frequency** knob clockwise to increase the value, counterclockwise to decrease the value

These changes take effect immediately.

4.3.3 Change Output Values with the Knob in SET Mode

The SET mode of operation is a mode in which changes to output parameters made with the knob or the entry keypad do not affect the output until the **Enter** key is pressed. The AC source is put in this SET mode by pressing the **Set** key twice.

To change the output voltage:

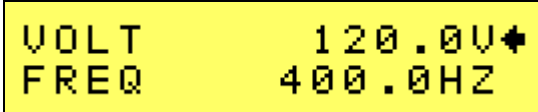

```
VOLT      120.0V
FREQ      400.0HZ
```

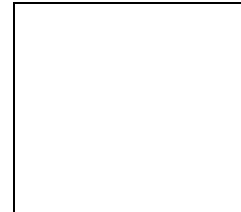

1. Press the **Set** key twice
2. Place the cursor on the VOLT entry
3. Rotate the **Voltage** knob clockwise to increase the value, counterclockwise to decrease the value
4. A blinking underline cursor will appear in the data for the VOLT field to indicate a change in settings but the output remains unchanged.
5. Place the cursor on the FREQ entry
6. Rotate the **Frequency** knob clockwise to increase the value, counterclockwise to decrease the value
7. A blinking underline cursor will appear in the data for the FREQ field to indicate a change in settings but the output remains unchanged.
8. Press the **Enter** key.

Both new voltage and frequency output values are now present at the output. The unit has returned to immediate mode of operation until the **Set** key is pressed again.

Note that output settings such as voltage and frequency can be changed from the measurement screen as well. If all three phases are selected, slewing the **Voltage** knob will change the output voltage on all three phases. If only one phase is selected, only the output of the selected phase will be affected.

4.4 Waveform Management

The Lx Series employs independent arbitrary waveform generators for each phase. This allows the user to create custom waveforms. In addition, three standard waveforms are always available. This chapter covers issues that relate to defining, downloading and managing custom waveforms.

Ls Series model only support arbitrary waveform generation if the –ADV option is installed. If not, you can skip forward to section 4.5 as the next sections do not apply.

4.4.1 Standard Waveforms

For most AC applications, a sine wave shape is used. The sine wave is one of the standard waveforms provided on all Lx Series models. This standard sine wave is always available and is the default waveform at power-on. Two more standard waveforms are available, square and clipped.

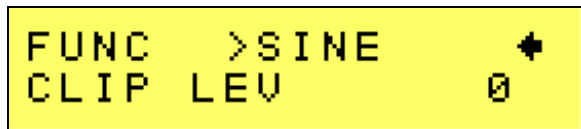

Figure 4-7: Selecting a Waveform

The square wave provides a high frequency content waveform with relative fast rise and fall times. Due to AC amplifier bandwidth limitations, the frequency content of the standard square wave has been kept within the amplifier's capabilities. As the fundamental frequency is increased, the relative contribution of higher harmonics is reduced.

The clipped sine wave may be used to simulate voltage distortion levels to the unit under test. The total harmonic distortion level may be programmed in percent using the CLIP LEV field directly below the FUNC entry.

Note that changing the distortion level of the clipped waveform forces the AC source to regenerate the clipped sine wave's data points and reload the waveform register with the newly requested data. This process requires the output to be dropped briefly. To avoid interrupting the voltage output to the unit under test, set the clip level needed before closing the output relay and do not change it while the EUT is under power. You can then toggle between the clipped sine wave and any other waveform in memory without interrupting the output.

4.4.2 Phase Selection



Figure 4-8: Selecting Waveforms for Single Phase or All Phases

Different waveforms may be selected for each phase. The number of custom waveforms from which to select remains 50 but each phase can be assigned a different custom or standard waveform. The specific output phase for which the wave shape is programmed is selected with the **Phase** key on the front panel. To select the same wave shape for all three phases in a three-

phase configuration, press the **Phase** key until all phase enunciators (ϕA , ϕB and ϕC) are lit. Waveform selections made in this mode will apply to all three phases.

4.4.3 Creating Custom Waveforms

The Lx controller supports up to 50 user defined waveforms in addition to the 3 standard waveforms. Custom waveforms cannot be created from the front panel of the Lx Series. Rather, they have to be downloaded through the IEEE-488 or RS232C interface.

Each waveform is defined by 1024 data points. Each data point can range between -1 and $+1$ (floating point number). See Lx Series programming Manual (P/N 7004-961) for details on downloading waveforms.

Once downloaded, waveforms remain in non-volatile memory and will be visible in the WAVEFORMS menu for selection. The user can assign a 12-character name to each custom waveform. Avoid using any of the standard waveform names (SINE, SQUARE or CLIPPED) as these names will not be accepted.

Waveforms may be deleted using the IEEE-488 or RS232C interface as well. Custom waveforms cannot be deleted from the front panel however to avoid accidental erasure.

4.4.4 RMS Amplitude Restrictions

The output of a sine wave may be programmed to the full rms value of the voltage range selected. If the AC source is in the 300 V range, the maximum programmable rms voltage is 300 Volt. If a custom waveform is used however, the maximum programmable rms voltage may be less than the maximum range value. The voltage range limit is based on the use of a sine wave with a 1.414 crest factor. A 300 V rms sine wave has a 424 Volt peak voltage. The AC source has a maximum peak voltage capability that is determined by the selected voltage range. If the user selects a custom waveform with a crest factor that is higher than 1.414, the peak voltage would exceed this maximum if the rms voltage were to be programmed at 300 V rms.

The Lx Series power source automatically limits the maximum allowable programmed rms voltage of a any custom waveform by calculating the crest factor of the selected waveform and controlling the rms limit accordingly. Thus, each custom waveform may have a different maximum rms value. The controller will prevent the user from programming the rms voltage above this limit. If a value is entered in the PROGRAM menu above this value, a "Voltage peak error" message is generated.

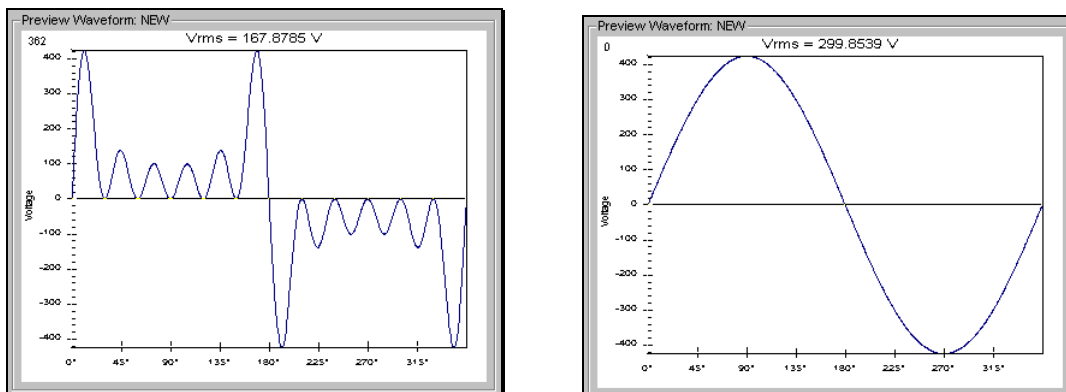

Figure 4-9: Waveform Crest Factor Affects Max. rms Voltage

The figure shown here illustrates the relationship between the crest factor of the wave shape (or its "peakiness") and the maximum peak voltage allowed for a given voltage range. Since the peak voltage cannot exceed the AC source's capabilities, the programmable rms voltage has to be restricted, in this case to only 167.8785 volt for the waveform on the left. The sine wave on the

right can be programmed to the full 300 V rms as this still falls within the same peak voltage limitation of the AC source.

If the Lx Series is used over the bus, the “:VOLT? MAX” query command can be used to determine the maximum allowable RMS voltage for the selected waveform. Using the returned value as part of a program will prevent range errors.

4.4.5 Frequency Response Restrictions

The user may create a waveform that contains any number of harmonic frequencies of the fundamental. The AC Source itself however has a finite signal bandwidth and will attenuate higher frequency components of the signal. To limit the maximum frequency component of the output signal, the controller automatically applies a band-pass filter to all custom waveforms as they are downloaded. The controller implements the following process for user-defined waveforms:

Each down loaded waveform will have a computed frequency limit that is less than or equal the maximum frequency limit of the AC source. The frequency limit is a function of the harmonics content of the waveform and will follow the equation below.

$$F_{max_h} = F_{max}/(\text{level} * h_n)$$

If F_{max_h} is below the minimum frequency limit, the waveform will be rejected at down load time and the label will be deleted from the waveform catalogue.

If the Lx Series is used over the bus, the “:FREQ? MAX” query command can be used to determine the maximum allowable fundamental frequency for the selected waveform. Using the returned value as part of a program will prevent range errors.

Limits assume a program of full-scale voltage. No adjustments for voltage setting are made below the full-scale value.

Waveform selection and frequency programming will be subject to the above limit. An error message will be generated to reflect this type of error:

"22, Waveform harmonics limit"

Transient editing will also generate the above error during keyboard entry. Remote transient entry will not check for the error until transient execution.

4.4.6 Switching Waveforms

Waveforms can be switched as part of the transient system. Each transient type setup menu has a FUNC field. This field allows selection of any of the standard or custom waveforms available in waveform memory. Refer to the section on transients for more details on using transient list to switch output waveforms.

4.5 Measurements

Standard measurements are always available through the **Meas** key on the front panel. These measurements are spread across multiple screens to enhance readability. Switching between these screens can be done by successively pressing the **Meas** button on the front panel. This will cause the screen to cycle through all available measurement screens.

4.5.1 Basic Measurements

The following three measurement screens are available:

Parameter	
<i>MEASUREMENTS 1</i>	
VOLTAGE	AC rms voltage
CURRENT	AC rms current
FREQUENCY	Frequency
POWER	Real power
<i>MEASUREMENTS 2</i>	
VA POWER	Apparent power
VAR POWER	Reactive power
POWER FACT	Power factor
CREST FACT	Crest factor
<i>MEASUREMENTS 3</i>	
VOLT THD	Voltage distortion
CURR THD	Current distortion
PEAK CURR	Highest AC current found
PHASE	Phase angle (relative to phase A (ø1))

Note: The V and I distortion calculations are based on H2 through H50 with the fundamental component (H1) in the denominator.

Measurements are always running in the background. When the user selects a measurement screen for display, the AC source first updates all the measurement parameters before displaying the requested screen. Consequently, pressing the MEAS key may not always bring up the selected screen immediately. There will be a perceptible delay. This will prevent the screen from appearing with invalid or blank readouts.

Note that all measurements are AC coupled only so any DC offset will not be reported.

4.5.2 Accuracy Considerations

Any measurement system has a finite accuracy specification. Measurement specifications are listed in Section 2. When using the AC source for measurement purposes, always consider these specifications when interpreting results. Measurement inaccuracies become more pronounced as the signal being measured is at the low end of the measurement range. This is particularly relevant for low current measurements. The Lx/Ls Series is a high power AC source optimized for providing and measuring high load currents. When powering low power loads, measurement inaccuracies on rms and peak current measurements will greatly affect derived measurements such as power, power factor and crest factor.

The measurement system on the Lx Series uses a digital data acquisition system with a 96 Ks/sec sampling rate and 16 KHz bandwidth. This means that higher frequency components of the measured signal are filtered out. Any contribution to the rms value of voltage and current

above this cutoff frequency will not be reflected in the Lx Series measurements. When using an external measurement reference, this may account for discrepancies in readings.

4.6 Harmonic Analysis

The Lx Series controller offers advanced power analyzer measurement capabilities. These functions may be accessed from the **Meas** screen. The phase for which the analysis or waveform acquisition is done may be selected using the **Phase** key when in three-phase mode.

The controller's power analyzer performs fast Fourier transformation (FFT) on both voltage and current on each available phase. The resulting frequency spectrum can be obtained over the bus only.

The Ls Series provides this capability only if the –ADV option is present.

4.7 Transient Programming

4.7.1 Introduction

Transient programming provides a precise timing control over output voltage and frequency changes. This mode of operation can be used to test a product for susceptibility to common AC line conditions such as surges, sags, brownouts and spikes. By combining transient programming with custom waveforms, virtually any AC condition can be simulated on the output of the AC source.

The default voltage mode is FIXED which means the output voltage is constant and remains at the level set by the user. Changes made to the output voltage made from the PROGRAM menu take effect immediately. In front panel operation mode, the voltage and frequency slew rates (rate of change) are always at their maximum of 2E5 V/s and 2E5 Hz/s. Slew rate programming is only possible over the IEEE-488 or RS232C bus. On power up, the AC source always reverts to the maximum slew rate for both voltage and frequency.

4.7.2 Using Transient Modes

The voltage can be programmed in the following transient operating modes:

- | | |
|-------|---|
| STEP | Causes the output to permanently change to its triggered value. |
| PULSE | Causes the output to change to its triggered value for a specific time, as determined by the Pulse menu parameters. |
| LIST | Causes the output to sequence through a number of values, as determined by points entered in the List menu. |
| FIXED | Disables transient operation for the selected function. |

4.7.3 Step Transients

Step transients let you specify an alternate or triggered voltage level that the AC source will apply to the output when it receives a trigger. Because the default transient voltage level is zero volts, you must first enter a triggered voltage before you can trigger the AC source to change the output amplitude. Step transients can only be programmed through the bus, not the front panel. Refer to the SCPI Programming Manual for more information about programming Step transients and triggers.

4.7.4 Pulse Transients

Pulse transients let you program the output to a specified value for a predetermined amount of time. At the end of the Pulse transient, the output voltage returns to its previous value. Parameters required to set up a Pulse transient include the pulse count, pulse period, and pulse duty cycle. An example of a Pulse transient is shown in Figure 4-10. In this case, the count is 4, the pulse period is 16.6 ms or 60 Hz and the duty cycle is 33%.

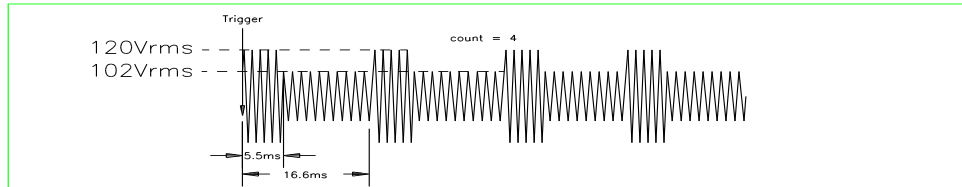

Figure 4-10: Pulse Transients

Note that Pulse transients can only be programmed over the bus, not the front panel. Refer to the SCPI Programming Manual for more information about programming Pulse transients and triggers.

4.7.5 List Transients

List transients provide the most versatile means of controlling the output in a specific manner as they allow a series of parameters to be programmed in a timed sequence. The following figure shows a voltage output generated from a list. The output shown represents three different AC voltage pulses (160 volts for 33 milliseconds, 120 volts for 83 milliseconds, and 80 volts for 150 milliseconds) separated by 67 millisecond, zero volt intervals.

Transient list programming is supported from the front panel and may be accessed by selecting the TRANSIENTS screen. Transient lists can also be programmed over the bus. Refer to the SCPI Programming Manual for more information about programming List transients and triggers over the bus.

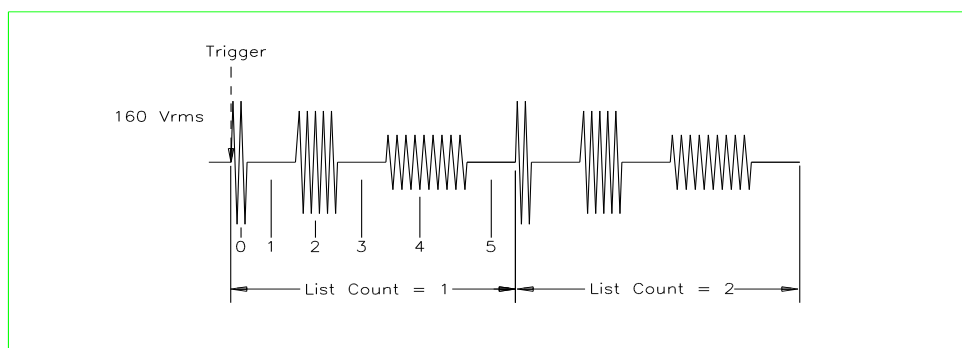

Figure 4-11: List Transients

The list specifies the pulses as three voltage points (point 0, 2, and 4), each with its corresponding dwell point. The intervals are three zero-voltage points (point 1, 3, and 5) of equal intervals. The count parameter causes the list to execute twice when started by a single trigger.

4.7.6 Programming list transients from the front panel

The output transient system allows sequences of programmed voltage and or frequency changes to be executed in a time controlled manner. Changes can be either step changes (maximum slew rate) or ramps (specified slew rates).

The section provides some examples of programming output changes (transients). Transients are defined as a series of numbered steps in a list. The list is executed sequentially. Each step has a number of fields that can be set by the user:

Voltage, Voltage slew rate, Frequency, Frequency slew rate, Current, Function, Dwell time, Trigger out, Phase.

The voltage, current and frequency settings are the same as one would do from the setup screen using the knobs. At each step, the output will be set to the specified voltage, current and/or frequency. The rate of change for voltage and frequency is determined by the slew rate set. Current slew is fixed at MAX and cannot be programmed.

If the voltage is changed from 10 Vac to 20 Vac and the V slew is set to 100 V/sec, the voltage will ramp from 10 to 20 Vac in 100 msec. ($[20 - 10] / 100 = 0.1$ sec). The dwell time is the time the output will remain at this setting. In this example, it should be set long enough to reach the final programmed value of 20 Vac, e.g. it should be at least 0.1 sec. If not, the voltage will never reach the final value of 20 Vac before the next step in the transient list is executed. The dwell time may be set longer than 0.1 sec in this example. If for example the dwell time is set to 1.0 sec, the voltage will ramp from 10 Vac to 20 Vac over a 0.1 sec period and then remain at 20 Vac for 0.9 sec.

Once the dwell time set for a step in the list expires, the next step is entered (if available, if not, execution stops and the output remains at the final values set in the last step of the list.)

Note that while there are parameters for both voltage and frequency level and slew rates, there is only one dwell time, which applies to each step in the transient list.

Front panel entry only supports the LIST mode of operation. For Pulse and Triggered modes, the remote control interface must be used.

When entering transient lists, each list must be entered sequentially starting with step #0. If a list point is not yet set, the step number cannot be increased past it.

The following sample illustrates the use of transient system to program controlled output changes.

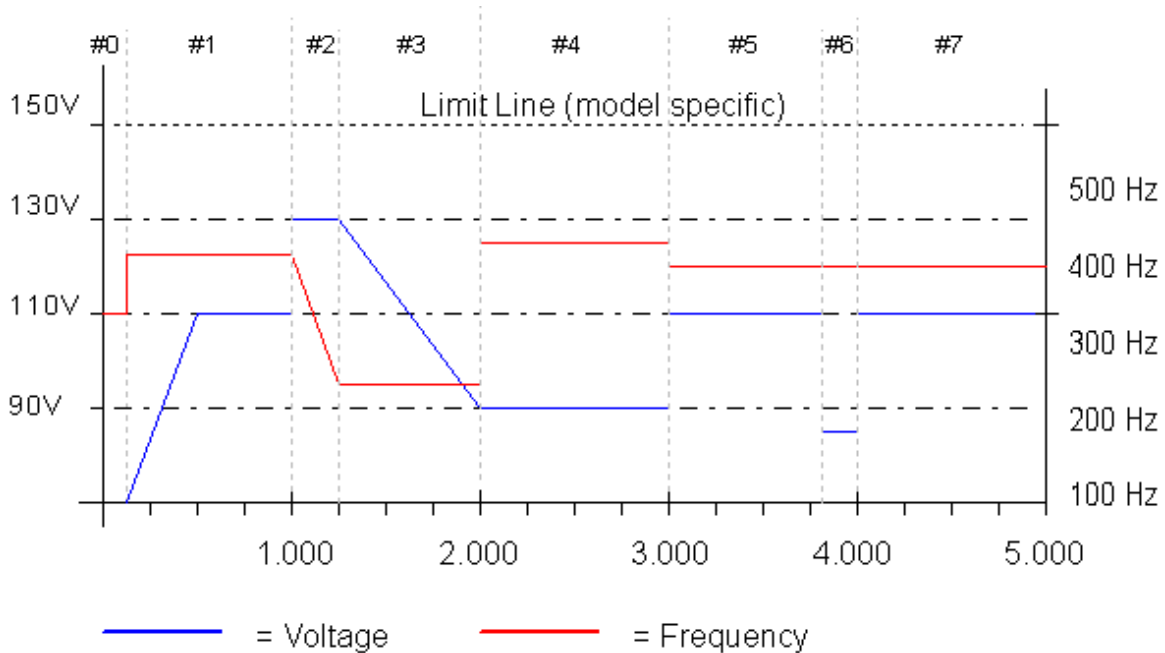

Figure 4-12: Sample Transient Output Sequence

This output can be accomplished using the following transient list.

Step # (data point)	Volt	VSlew	Frequency	FSlew	Dwell
0	70.00	MAX	360.0	MAX	0.100
1	110.00	100.0	440.0	MAX	0.900
2	130.00	MAX	240.0	800.00	0.250
3	90.00	53.3	240.0	MAX	0.750
4	90.00	MAX	460.0	MAX	1.000
5	110.00	MAX	400.0	MAX	0.800
6	88.00	MAX	400.0	MAX	0.200
7	110.00	MAX	400.0	MAX	1.000

Table 4-2: Sample Transient List

4.7.7 Waveforms Function List

The FUNCTION field available in each transient list event setup menu may be used to dynamically switch waveforms during transient execution. This allows different waveforms to be used during transient execution. Waveforms may be switched without the output of the source being turned off. For three phase configurations, each phase has its own waveform list so different waveforms may be programmed on different phases during transient execution.

Figure 4-13 illustrates the concept of using different waveforms at different steps in a transient list. In this case, the change was programmed to occur at the zero crossing. Any phase angle can be used to start the transient execution however. To keep the phase angle synchronization, the dwell times have to be set to an integer number of periods. Over long periods of time, phase

synchronization may get lost due to timing skew between the waveform generator and the transient state machine.

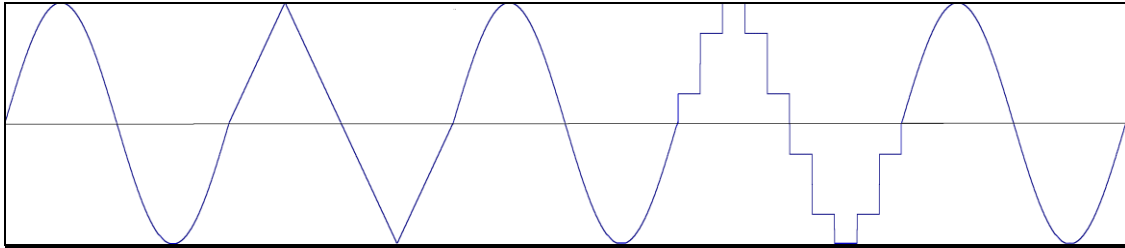

Figure 4-13: Switching Waveforms in a Transient List

4.7.8 Transient Execution

```

TRAN ST      IDLE
COUNT      1
  
```

Figure 4-14: TRANSIENT Menu

A transient list can be executed from the TRANSIENT menu. To start a transient list, position the cursor on the TRAN ST field as shown in Figure 4-14 and press the ENTER key. Transients may be aborted by pressing the ENTER key again while on the same field as the field changes to ABORT while a transient execution is in progress. For short duration transients, this will likely not be visible, as the transient will complete before the screen is updated. Longer duration transients however may be aborted in this fashion.

4.7.9 Saving Transient List Programs

When the AC source is turned off, the transient list that was programmed is not automatically retained. Thus, if you turn the unit off, you will lose your programmed transient list. However, transient programs may be saved in nonvolatile memory for later recall. This allows multiple transient list programs to be recalled quickly without the need to enter all parameters each time. Transient lists are stored as part of the overall instrument front panel setup in any of the available setup registers.

To save the transient list you created in the previous example, proceed as follows:

```

SAVE      REG #1
RECALL   REG #0
  
```

1. Press the **Menu** key repeatedly until the REGISTERS / CONFIGURATION menu is displayed.
2. Move the cursor to the REGISTERS entry and press the ENTER key.
3. The cursor will default to the SAVE REGISTER # position. Enter a number from 1 through 15 and press the ENTER key. **DO NOT USE REGISTER 0 (REG0)** as it is reserved for power-on setting recall and does not include a transient list.
4. A message will appear indicating that the front panel settings and the transient list data have been saved in the setup register you selected.

4.8 Setting the Power-on Initialization Values

The power source is shipped with default factory settings when the unit is powered up. The factory settings are:

Parameter	Factory default setting
Voltage	0.0 Volt
Frequency	50 Hz
Current limit	Maximum available current.
Output state	OFF
Local / Remote State	Local. Front panel unlocked.

Table 4-3: Factory Default Power on Settings

It is possible to change the power on initialization values in one of two ways:

1. Using the RS232 or IEEE-488 bus interface.
2. Using the front panel.

To change the power on initialization values from the front panel, proceed as follows:

1. Set the AC power source output parameters from the front panel as you want to power up the unit.
2. Save this setting to setup register 0 from the REGISTERS menu.
3. Select the CONFIGURATION menu and move to the POWER ON field.
4. Change the POWER ON field to REG0.
5. This will recall the settings contained in register 0 at power up.

4.9 Remote Inhibit Function

The remote inhibit input on the rear panel can be used to disable the output of the AC source. This SMC input takes either a low level TTL signal or a contact closure. The mode of operation can be programmed over the remote control interface using the `OUTP:RI:MODE` command. See 7004-961 programming manual for details.

The following modes are supported.

MODE	OPERATION
LATCHING	A TTL low at the RI input latches the output in the protection shutdown state, which can only be cleared by an <code>OUTPut:PROTection:CLEar</code> command or by manually resetting the output.
LIVE	The output state follows the state of the RI input. A TTL low at the RI input turns the output off; a TTL high turns the output on. This mode is equivalent to using the Output On/Off button on the front panel. Default mode. This mode is active at power up.
OFF	The instrument ignores the RI input.

Table 4-4: Factory Default Power on Settings

The RI output state is saved as part of an instrument setup using the `REGISTERS` menu. It can be made part of the power on setting if needed. The default state is LIVE.

5. Principle of Operation

5.1 Overall Description

Three-phase input power is routed from the back of the cabinet to a fuse holder terminal block located in the bottom front of the unit. AC power is converted to a 300 VDC bus using a switching buck converter. The DC bus is used to power all three DC/AC invertors (amplifiers), one for each phase. The AC input converter also generates the required DC bias supply voltages to power the auxiliary circuits of the power source such as the programmable controller and keyboard display.

The output of each amplifier is fed through an output transformer which steps the output voltage to the required 150 V AC RMS or 300 V AC RMS output range. The output transformers provide the required isolation between input and output and also block any DC at the output of the power source.

The CPU controller / oscillator assembly generates the reference waveforms and provides frequency, amplitude, and current limit control. A current and voltage sense board is located at the top right of the unit above the transformers and is used to sense all output current and voltage for both control and measurement purposes. The current sensor board, in conjunction with the CPU controller, also supports the programmable RMS current limit function.

To obtain higher power levels, two 4500Lx (4500 VA) power sources are paralleled together to form a 9000V VA three-phase AC source. This is accomplished through the system interface, which routes the required analog and digital signals from the 4500Lx master (unit with controller front panel) to the 4500Lx auxiliary.

5.2 Controller Assembly

The Controller Assembly is located on the front panel the Lx/Ls master unit. The controller assembly consists of a single printed circuit board that plugs into the backplane motherboard. The controller contains the main oscillator, which generates the sine wave signal setting the frequency, amplitude and current limit level. It also senses the output voltage to provide closed loop control of the output. The controller also handles all user interface and remote control related tasks. The function of each of the two boards that make up the controller module is described in the following paragraphs.

5.2.1 Programmable Controller

This board assembly, A7, consists of the components for the CPU (DSP), generating all three Phase waveform signals to the power amplifier and all of the program, waveform and data memory. In addition, this board contains the circuits for all measurements. The clock and lock circuit required to support the clock and lock mode of operation of multiple Lx/Ls units is also on this board assembly.

5.2.2 Keyboard / Display Board

The keyboard/display assembly is assembly A9 and is mounted to the front panel. If the Lx/Ls system is used over one of the remote control interfaces, the keyboard functions can be locked out by asserting the REMOTE state. See the Lx/Ls Series Programming Manual (P/N 9003-961) for details.

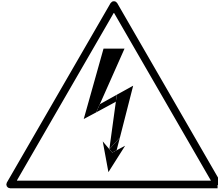

CAUTION

VOLTAGES UP TO 480 VAC AND 500 VDC ARE PRESENT IN CERTAIN SECTIONS OF THIS POWER SOURCE. THIS EQUIPMENT GENERATES POTENTIALLY LETHAL VOLTAGES.



DEATH

ON CONTACT MAY RESULT IF PERSONNEL FAIL TO OBSERVE SAFETY PRECAUTIONS. DO NOT TOUCH ELECTRONIC CIRCUITS WHEN POWER IS APPLIED.

6. Calibration

The Routine Calibration should be performed every 12 months. Non-routine Calibration is only required if a related assembly is replaced or if the periodic calibration is unsuccessful. Calibration of the Lx/Ls system can be performed from the front panel or over the bus. This section covers calibration from the front panel.

6.1 Recommended Calibration Equipment

Digital Multimeter:	Fluke 8506A or equivalent / better. HP 34401A or equivalent / better
100 mOhm Current Shunt:	Isotek Model RUG-Z-R100-0.1.calibrated to 0.25% - OR -
10 mOhm Current Shunt:	Isotek Model RUG-Z-R010-0.1.calibrated to 0.25% (For single phase mode or multi-chassis Lx/Ls configurations, a 10 mOhm shunt may be needed .
Load Bank:	Various high power load resistors or a resistive load bank will be needed. (E.g. Avtron) Size of the load bank depends on model and phase mode. A load is required to perform the current measurement calibration near full scale. Current measurement calibration should be done on the lowest available voltage range. The accuracy and value of the load resistor is not critical as long as the current drawn is sufficient to operate the AC Source in the upper current range (80-100 %). Suggested values of load bank settings are shown in Table 6-1 and Table 6-2.
Phase Meter	Krohn-Hite Model 6620 or equivalent phase meter (0.01° resolution, 0.02° accuracy).

6.2 Calibration Screens

The calibration screens for output or measurement calibration can be selected from the **MENU** screen. (Press MENU button several times to toggle to select the CALIBRATION screen.)

To select the CALIBRATION screen press the \uparrow or \downarrow key several times to select PASSWORD. Then press the **ENTER** key. This will bring up the PASSWORD screen. To prevent unauthorized access to calibration data, a password must be entered to access any calibration screen. The calibration password is a numeric value equal to the high voltage range limit, typically 300 on a Lx Series and 270 on a Ls Series. Units with a –HV or –EHV output range option may have a different high voltage range value and corresponding calibration password. Check the serial tag label or the LIMIT screen when in doubt.

The password can be entered using the **Voltage** shuttle to dial in the number. Once the correct value is reached, press the **ENTER** key. Once set, the calibration screens remain accessible until the Lx unit is powered down. If you leave the calibration screen and return, toggle the value up or down and back, followed by the **ENTER** key to re-engage the calibration mode.

On Lx systems or Ls systems with three-phase output capability, use the PHASE key on the front panel to select the phase to be calibrated.

To select the MEASUREMENT CALIBRATION screen, follow the same steps as outlined above but select the MEASUREMENT CAL entry instead of OUTPUT CAL. If another CALIBRATION screen has been accessed since power-up, no password is needed. Otherwise, enter the same password as indicated above.

6.3 Measurement Calibration

The Lx/Ls Series controller measures voltage and current by digitizing both voltage and current waveforms on each available output phase. This data is subsequently processed and used to calculate all measurement parameters such as VRMS, IRMS, Power, VA, Frequency etc. To calibrate all measurements, only the voltage and current measurement need to be calibrated specifically. All other measurements are derived from these.

Connect the test equipment to the power source. If the power system is a master/auxiliary multi-box system with one controller, the DVM for calibrating the measurement voltage should always be connected to the Remote Sense connector on the Master cabinet.

Note: *The Fluke 8506A or Agilent HP 34401A Digital Multi meter (or higher AC accuracy DMM) must be used for the following calibration. The DMM must be set to the AC HI ACCUR mode for all AC measurements.*

The shunt must be connected in series with the load. Connect the load to the output. Use a 10 mOhm current shunt of sufficient power rating in series with the load to measure the AC load current.

To calibrate all measurement functions, the desired value for the measurement value of current or voltage must be entered for the corresponding calibration value. Make the indicated adjustments by typing in the desired display value. This should be the value indicated by the external DVM. If a 10 mOhm current shunt is used for current, 300 mV represents 30 amps.

The Calibration Load Table shows required load bank settings for the current measurement calibration procedure. The current should be calibrated in the lowest voltage range only. (Highest current range). The current measurement calibration must be performed for Phase A in both single and three phase mode and for phase B and C in three phase mode only.

PARAMETER	POWER SYSTEM					
	3000Lx 1 Phs	3000Lx 3 Phs	4500Lx 1 Phs	4500Lx 3 Phs	6000Lx 1 Phs	6000Lx 3 Phs
Max current, 120 V, Lo Vrange	4.8 Ω 3 kW	14.4 Ω 1 kW	3.2 Ω 4.5 kW	9.6 Ω 1.5 kW	2.4 Ω 6 kW	7.2 Ω 6 kW

Table 6-1: Calibration Load Values- Single-chassis configurations

PARAMETER	POWER SYSTEM			
	9000Lx/2 1 phs mode	9000Lx/2 3 phs mode	12000Lx/2 1 phs mode	12000Lx/2 3 phs mode
Max current, 120 V, Lo Vrange	1.6 Ω 9 kW	4.8 Ω 3 kW	1.2 Ω 12 kW	3.6 Ω 4 kW
Model --->	13500Lx/3 1 phs mode	13500Lx/3 3 phs mode	18000Lx/2 1 phs mode	18000Lx/3 3 phs mode
Max current, 120 V, Lo Vrange	0.96 Ω 13.5 kW	3.2 Ω 4.5 kW	0.8 Ω 18 kW	7.2 Ω 6 kW

Table 6-2: Calibration Load Values- Multi-chassis configurations

6.3.1 Measurement Cal - AC

AC Volt Full-scale: Program the output to 300 Volt AC and 400 Hz. Close the output relay. Go to the MEASUREMENT CALIBRATION screen. Enter the actual AC output voltage for the MVOLT FS parameter and press the ENTER key. **Save this value by pressing the ENTER key.**

AC Current Full-scale: Calibrate the measurement current under a constant current condition or a voltage fault may be generated. Apply a load to the output. Program the output to 120 volts on the 150 volt range and 400 Hz. Observe the actual output current and enter this value for the MCURR FS parameter. Press the ENTER key. **Save this value by pressing the ENTER key.**

6.3.2 Single and Three Phase Modes

As indicated earlier, for 3-Phase power system, repeat the preceding steps for the Phase B and C outputs. The order in which the outputs for each phase are calibrated is not important.

Press the PHASE key to select each output to be calibrated. Monitor the output of the respective phase by moving the HI input of the Digital Multimeter and the current shunt as needed. The LO input should remain connected to the common LO of the sense connector.

The current measurement calibration for Phase A (ø1) should be done in both single and three phase modes as separate calibration coefficients apply to each phase mode. Voltage measurement calibration for phase A (ø1) can be done in either phase mode.

6.4 Output Calibration

The output calibration is performed automatically when the measurement calibration takes place. As such, there is no need to perform this calibration again. The output calibration coefficients may be viewed by selecting the OUTPUT CAL screen.

Output gain is set at the factory and the output calibration coefficients are pre-set. They is no need to change the factory default settings unless any of the following conditions occurs:

1. Replacement of one or more amplifiers as a result of a service action.
2. Replacement of the current limit board. (CI P/N 7004-703-1)
3. Replacement of the controller board. (CI P/N 7004-708-1)

If the output gains are found to be out of tolerance, they need to be adjusted. This requires removal of the top cover and should only be done by qualified service personnel. In that case, refer to the non-routine gain calibration section.

The factory output calibration coefficients are shown in the table below.

Output Phase	Current Limit Board Adjustment Pots	OUTP CAL value	
		Standard	-HF option
A or 1	R1	450	450
B or 2	R2	450	450
C or 3	R3	450	450

Table 6-3: Output Calibration Coefficients - Factory Defaults.

6.5 Phase Offset Calibration

The phase offsets for phase B and C can be calibrated using the OUTPUT CALIBRATION screen. The same calibration can be done over the RS232 or GPIB bus if needed. Refer to the Lx/ Ls programming manual (P/N 7004-961) for command syntax on bus calibration.

Phase offset calibration requires a phase meter for reference. See section 6.1 for recommended equipment list.

For front panel calibration, proceed as follows.

1. Program the output frequency to 400 Hz.
2. Select the phase to be checked/calibrated (Phase B or C) using the PHASE key. Phase A calibration is only relevant if the Lx/Ls unit is used in External Sync, Line Sync or LKS mode. In that case, phase A offset is with respect to the external reference signal.
3. Program full-scale voltage and measure phase angle between phase A and B or A and C using a phase meter.
4. Press the MENU key several times to display OUTP CAL, then press the ENTER key.
5. Again you must enter the password, which will be the value for the highest voltage range and press ENTER.
6. Press the ↓ key to point to the PHASE OFST value. This will be the phase calibration value for the phase selected.
7. Adjust the calibration value as needed while monitoring the external phase meter reading so the output phase angle is calibrated. Press the ENTER key to save the calibration.
8. Repeat for the other phase.

6.6 Non-Routine Output Gain Calibration

If the Current Limit board assembly (P/N 7004-703-1) is replaced in the field or one of the amplifiers has been replaced, it is necessary to check the gain of each phase and adjust as needed.

WARNING: *This requires the top cover to be removed and should be done by qualified service personnel only. Dangerous Voltages are present inside the AC power source.*

To adjust amplifier output gains, proceed as follows:

1. Turn **OFF** the front panel circuit breaker.
2. Loosen the top cover and slide back until the Current Limit board assembly (P/N 7004-703-1) is uncovered. This is the vertical board directly behind the CPU/Controller board. Refer to Figure 6-1.

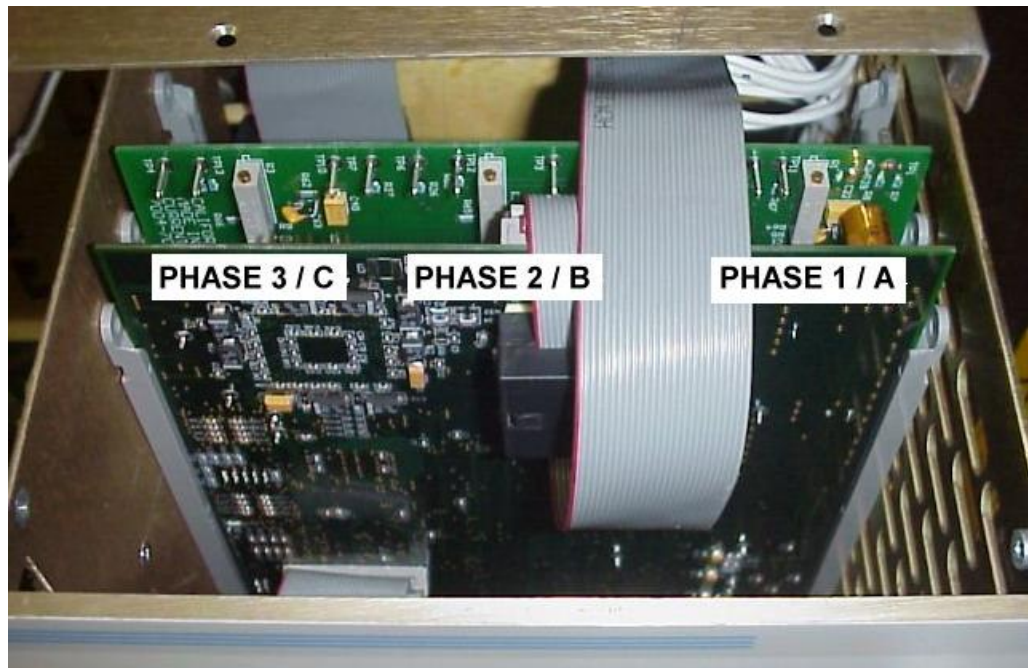

Figure 6-1: Location of Gain pot adjustments

3. Go to the Output Calibration screen by repeatedly pressing the MENU key until OUTP CAL is displayed.
4. Select this function by pressing the cursor until the arrow on the right side of the display point to OUTP CAL. Press the ENTER key.
5. A Calibration Password (CAL PWORD) will be required. The password will be the value of the high voltage range. Enter this value with the Front Panel encoder and press the ENTER key.
6. Select Phase A and check the output calibration coefficient setting. The value should be 450 for both standard Ls/Lx models and for Lx/Ls models with the -HF (high frequency) option. (Refer to table below). If not, adjust as needed and press the ENTER key.
7. Select Phase B and check for the correct value or set it as needed.

8. Repeat the entry for Phase C. Make sure the ENTER key is pressed each time a value has to be reset to the factory default setting to store this value
9. If three-phase mode is available, select the three-phase mode from the CONFIGURATION menu. If the Ls unit has one-phase only, adjust only phase A.
10. Select the Low Voltage range.
11. Select the SETUP screen and scroll to the ALC setting entry. Turn off the ALC mode by selecting OFF and then set the program value for the output voltage for all three phases to 115.00 volts and 400 Hz with respect to Neut (Ls) or Com (Lx).
12. Close the output relay.
13. Connect the external AC DVM to the respective output and use the adjustment indicated below so set the output voltage to 115 ± 0.115 volts.
14. Repeat for Phase B and C as needed.
15. Open the output relays when done.

Output Phase	Current Limit Board Adjustment Pots	OUTP CAL value	
		Standard	-HF option
A or 1	R1	450	450
B or 2	R2	450	450
C or 3	R3	450	450

Table 6-4: Output Calibration Coefficients - Factory Defaults.

6.7 Non-Routine Amplifier Balance Adjustment

If an amplifier has been replaced on Lx/Ls models that have single-phase mode, it will be necessary to check the amplifier current share balance and adjust if needed. For single box Ls-3 models, this adjustment is not required.

WARNING: *This requires the top cover to be removed and should be done by qualified service personnel only. Dangerous Voltages are present inside the AC power source.*

To adjust amplifier balance, proceed as follows:

1. Remove all loads from the output.
2. Program the output to the 1-phase mode and 400 Hz.
3. Program the output voltage to 100 volts on the low voltage range with ALC off.
4. Check the amplifier gain balance by measuring the circulating current between amplifiers. This current can be measured by monitoring the voltage at the test points indicated in the table below on the current limit board. All test point measurements are with respect to TP1 (common).
5. The voltage at each test point with no-load should be less than 20 millivolts. Make any correction necessary by adjusting the Amplifier Gain on each amplifier. The gain adjustment pot is indicated in the same table.
6. Check the balance at 50 Hz and again at the high frequency limit of the unit.
7. Contact California Instruments at support@calinst.com if the load balance exceeds 50 millivolts at the frequency extremes as the amplifier may be defective in this case.

Output Phase	Current Limit Board Test Point	Adjustment Pot R104 on Amplifier assembly:
A or 1	TP2	Phase A (A1)
B or 2	TP3	Phase B (A2)
C or 3	TP4	Phase C (A3)
	Common = TP1	

Table 6-5: Amplifier balance adjustments

7. Service

7.1 Cleaning

The exterior of the power source may be cleaned with a cloth dampened with a mild detergent and wrung out. Disconnect mains power to the source before cleaning. Do not spray water or other cleaning agents directly on the power source.

7.2 General

This section describes the suggested maintenance and troubleshooting procedures. The troubleshooting procedure is divided into two sections. The first section deals with basic operation and connection of the equipment. The second section requires opening the unit and using LED indicators and a simple multimeter to troubleshoot the unit down to the module level. Only a qualified electronic technician should attempt this level troubleshooting.

7.3 Basic operation

Table 7-1: Basic Symptoms

PARAGRAPH	PROBLEM
7.3.1	Excessive Output Voltage
7.3.2	Poor Output Voltage Regulation
7.3.3	Overload Light On
7.3.4	Distorted Output
7.3.5	Unit Shuts Down After 1-2 Seconds
7.3.6	No Output and no lights on front panel
7.3.7	No output, but front panel controller is active.

7.3.1 Excessive Output Voltage

CAUSE	SOLUTION
External sense not connected(If used)	Connect external sense wires from TB2 on rear panel to the AC power outlet TB1A and TB1B

7.3.2 Poor Output Voltage Regulation

CAUSE	SOLUTION
Unit is overloaded	Remove overload
Unit is programmed to wrong voltage range.	Select correct voltage range.
Input line has fallen below spec. limit.	Check input supply voltage.

7.3.3 Overload Light is On

CAUSE	SOLUTION
Unit is overloaded	Remove overload or check CL setting
Unit is switched to high voltage range.	Select correct voltage range.

7.3.4 Distorted Output

CAUSE	SOLUTION
Power source is grossly overloaded.	Reduce load
The crest factor of the load exceeds 3:1.	Reduce load current peaks by reducing load.

7.3.5 Unit Shuts Down after 1-2 Seconds

CAUSE	SOLUTION
Output shorted	Remove output short
Output grossly overloaded.	Remove overload.
-400 Input module failure	Have power module serviced
Operating load with too high inrush or start up currents.	Consult factory for application advice.

7.3.6 No Output and No Lights on Front Panel

CAUSE	SOLUTION
Input circuit breaker switched off.	Switch the breaker on.
No input power.	Ensure 3 phase power is present at AC input terminal block
-400 Input Power Supply failure	Have -400 input supply serviced.

7.3.7 No Output But Front Panel controller is active

CAUSE	SOLUTION
"OUTPUT ON" button is turned off.	Press OUTPUT ON so that "ON" LED is lit.
Current limit programmed down or to zero.	Program current limit higher.
Voltage programmed down or to zero.	Turn amplitude control up.

7.4 Isolating amplifier failures in multi-box systems

A self test can be performed over the bus by sending the *TST? query command. The self test will run until the first error is encountered and terminate. The response to the query will either be the first error encountered or 0 if no error was found. (Selftest passed).

On multi-box model configurations such as 9000Lx/2 or 18000Ls/3, it is possible to isolate certain failures to a particular chassis. This can be done using the *TST? Self test error codes.

Note: The self test should always be run in 3 phase mode on all Lx models and Ls models with the -MODE option. If the self test is run in single phase mode, not all aspects of the Phase 2/B and 3/C hardware will be tested as a result. If the power source is a Ls-1 single phase only configuration, the self test can only be run in single phase mode.

To execute a self test, the IEEE-488 or RS232 interface must be used. The LxGui command line can be used to send the *TST? Command. The following rules apply:

1. If a voltage error is reported on phase 1, 2 or 3, it indicates the corresponding amplifier in the Master chassis has most likely failed.
2. If a current error is reported on phase 1, 2 or 3, it indicates one of the auxiliary chassis amplifiers on the phase indicated has failed. On a 2 box configuration, there is only one auxiliary chassis. On a three box configuration, it is not possible to tell which of the two auxiliary amps have failed. They could also both have failed in this case.

To further isolate the failed amplifier in a three-box configuration, the outputs of all three chassis must be disconnected from each other. Then program each phase and close the output relay. Check the output of each chassis for the expected output voltage. The chassis with no output(s) will have the failed amplifier.

7.5 Advanced Troubleshooting.



WARNING: Do not connect 400-480V into the 208-240V unit, the result could be a severely damaged unit.



CAUTION: VOLTAGES UP TO 400 VAC AND 450 VDC ARE PRESENT IN CERTAIN SECTIONS OF THIS POWER SOURCE.



WARNING: THIS EQUIPMENT GENERATES POTENTIALLY LETHAL VOLTAGES. DEATH ON CONTACT MAY RESULT IF PERSONNEL FAIL TO OBSERVE SAFETY PRECAUTIONS. DO NOT TOUCH ELECTRONIC CIRCUITS WHEN POWER IS APPLIED

Switch Off Units

Switch off each unit at the circuit breaker on the front panel as well as removing the input power from the unit.



WARNING: Wait 10 minutes for all internal capacitors to discharge.

Removing Cover

Remove the screws securing the top cover and remove it.

Initial Inspection

Make a visual inspection of the unit and ensure all the connectors are properly mated and there are no loose wires.

7.6 Factory Assistance

If the problem with the cabinet or one of the power modules cannot be isolated, contact the factory for assistance.

7.7 Fuses

See Table 7-2 for replaceable fuses and ratings for each of the sub assemblies in the Lx/Ls Power source.

7.8 Replaceable Parts

In order to ensure prompt, accurate service, please provide the following information, when applicable for each replacement part ordered.

- a. Model number and serial number of the instrument.
- b. Argantix part number for the sub-assembly where the component is located. (California Instruments PART #)
- c. Component reference designator if applicable (REF #)
- d. Component description.
- e. Component manufacturers (VENDOR)

All replaceable part orders should be addressed to:

California Instruments Corporation.

Attention: Customer Service
9689 Towne Centre Drive
San Diego, California 92121-1964
United States of America

Orders may also be placed using the following fax number: 1 858 677 0904 or via email: support@calinst.com

REF #	Sub	CI PART #	DESCRIPTION	MNF, P/N	QTY
Common Assemblies					
A1-2,3		4009-456-4	Heatsink assembly (Amplifier)	CI	3
	A1	5001-725-2	Amplifier Power board	CI	1
	A2	7004-702-1	Amplifier Control board	CI	1
A5		7004-700-1	Power Mother board	CI	1
	F1,2,3	270176	Fuse, 20A / 250V	Bussmann, ABC20	3
A6		7004-705-1	Control Mother board	CI	1
A8		4009-737-1	EMI board, 208V & 400V	CI	1
A9		7004-703-1	Current Limit board	CI	1
A12		7004-716-1	Range Relay board	CI	1
A13		7004-704-1	System Interface board	CI	1
A18		7004-401-1	Controller Assembly, Single Phase	CI	1
A18		7004-401-3	Controller Assembly, Three Phase	CI	1
A19		4009-737-3	EMI board, 400V	CI	1
	A1	7004-715-1	Controller Board	CI	1
	A2	7004-709-1	Keyboard / Display board	CI	1
B1		241182	Fan, 4" 24 VDC	Rotron, MD24B2 Nidec, B31257-10 EBM, 4292H	1
B2		241183	Fan, 6" 24 VDC	Rotron, JQ24B4 NMB, 5920PL-05W-	1

REF #	Sub	CI PART #	DESCRIPTION	MNF, P/N	QTY
				B50-D00 EBM, 6424	
208 V Input Models (-208)					
A7		7004-706-1	DC Power Supply	CI	1
	F1	270193	Fuse, 7A / 250V SB	LittleFuse, 313007	1
	F2	270174	Fuse, 1A / 250V	Bussmann, PCC1	1
	F4	270230	Polyfuse, 9A / 30V	Raychem, RUE600	1
	CB1	270220	Circuit breaker, 40A, 240V	Airpax, IELK1111- 31311-2-V	1
DS1		250412	Lamp, neon, amber, 125V	IDI, 1050QN3	1
C1		611295	Electrolytic Cap, 3900uF, 400V	CDE, 500R392T400DE2B 500X442T450DF2A	1
400 V Input Models (-400)					
A7		7004-712-1	Input Power Supply	CI	1
	F1	270193	Fuse, 7A / 250V Slow Blow	LittleFuse, 313007	1
	CB1	270221	Circuit breaker, 15A, 415V	Airpax, IELK1111- 31311-1-V	1
	C27	611305	Electrolytic Cap, 3900uF / 350V	CDC, 550392T350DC2B	1
	C17,18	611306	Electrolytic Cap, 1600uF / 350V	CDC, 550162T350BC2B	2
A16		7004-710-1	Bias Startup Supply board	CI	1
A17		7004-711-1	LV Supply board	CI	1
	F1	270174	Fuse, 1A / 250V	Bussmann, PCC1	1
	F4	270230	Polyfuse, 9A / 30V	Raychem, RUE600	1
DS1		250786	Lamp, neon, amber, 12V	IDI, 1050N3	1

Table 7-2: Replaceable Parts and Assemblies

8. Option -160: RTCA / DO-160D

8.1 General

This user manual assumes that the user is familiar with the text of the relevant DO160, section 16 test standard. No attempt is made to explain or elaborate on the actual test specification.

The RTCA/DO-160D option is capable of performing all sub-sections of RTCA/DO-160D, Section 16, RTCA/DO-160D change No2 and EUROCAE-14D / RTCA DO160D, Section 16 for the AC Source signal. A selection is made available to specify the type of standard to be applied to the EUT and the available EUT groups.

The voltage modulation tests for Airbus ABD0100.8 are supported by this option as well. The voltage modulation levels for the Airbus version are specified differently from DO160. All other tests are the same for Airbus and DO160.

Through out this document, RTCA/DO-160D change No2 will be referred to as RTCA2. Groups 1 through 3 will be used to refer to the EUROCAE-14D standard. Category A(CF), A(NF) and A(WF) will be used to refer to the RTCA2 standard.

8.2 Initial Setup

Nominal parameters for the AC Power source are as follows:

Output Voltage	115V L-N or 230V L-N
Output Frequency	360 Hz to 800 Hz

Note: *A setting outside these nominal values will disable the test and will prevent access to the DO160 Menu screens. To execute all tests for the 230V L-N, the power source must be capable of programming 360V RMS. This requires the -EHV option output range pair (200/400V). If this option is not installed, some tests will be skipped.*

8.3 Tests Performed

8.3.1 NORMAL STATE

AC Source:

1. Normal State Voltage and Frequency test
2. Voltage unbalance test
3. Waveform Distortion test
4. Voltage Modulation test
5. Frequency Modulation test
6. Momentary Power Interrupt (Under voltage) test
7. Voltage Surge (Over voltage) test
8. Frequency Transients test(Group 1 only)
Frequency Variation test (Group 2 and 3 only)

8.3.2 EMERGENCY TEST

AC Source:

1. Emergency Voltage and Frequency minimum
2. Emergency Voltage and Frequency maximum
3. Voltage unbalance

8.3.3 ABNORMAL TEST

AC Source:

1. Abnormal Voltage minimum
2. Abnormal Voltage maximum
3. Voltage Drop
4. Voltage Surge
5. Frequency Transients test (group 1 only)

8.4 Front Panel Operation -160

To perform a test from the keyboard, Press the MENU key several times until the APPLICATIONS/OPTIONS Menu appears, select the APPLICATIONS screen. The APPLICATIONS screen will appear as shown in Figure 8-1.



Figure 8-1: Application Menu

Scroll to the RTCA/DO-160D entry using the up and down cursor keys. Press the ENTER key to select the RTCA/DO 160D main menu. The screen will appear as shown in Figure 8-2.

Note: The user has to turn on the Output relay before starting a test.

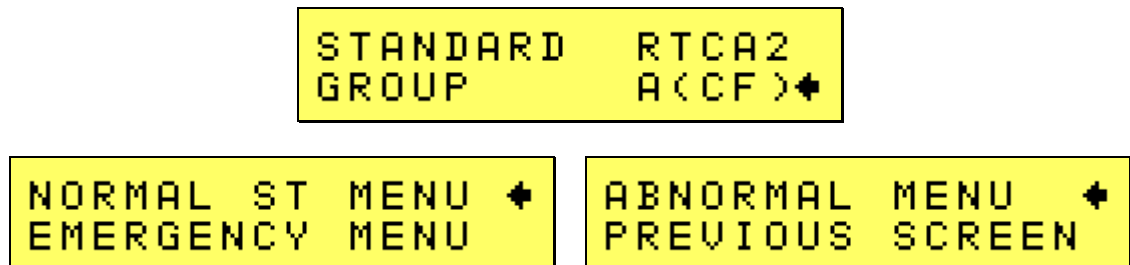

Figure 8-2: DO160 Main Menus

Prior to executing a test, selection of the desired test standard and group is required. Use the shuttle to select the standard and the group if applicable.

8.5 Normal State tests

Scroll to the NORMAL STATE entry using the up and down cursor keys. Press the ENTER key to select the NORMAL STATE screens. The screen will appear as shown in Figure 8-3.

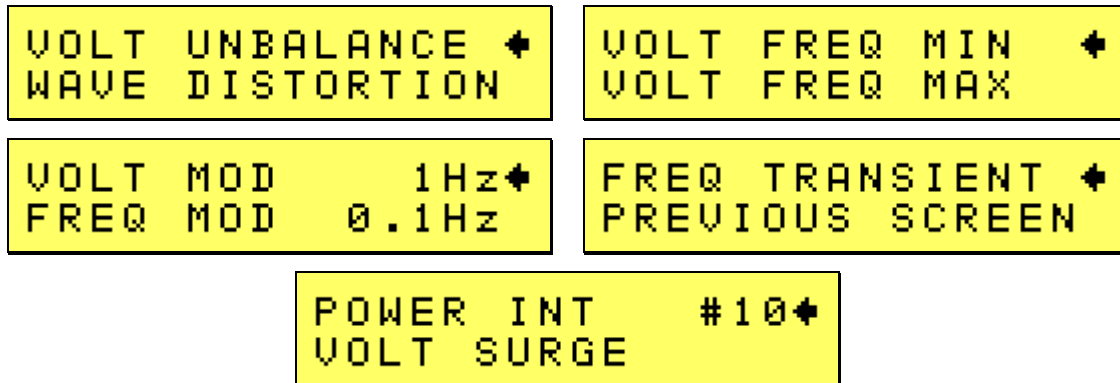

Figure 8-3: Normal state screens

The DO160 NORMAL screens have the following tests:

- 1 VOLT FREQ MIN
- 2 VOLT FREQ MAX
- 3 VOLT UNBALANCE
- 4 WAVEFORM DISTORTION
- 5 VOLT MODULATION
- 6 FREQ MODULATION
- 7 POWER INTERRUPT
- 8 VOLTAGE SURGE
- 9 FREQ TRANSIENT (group 1/A(CF))
FREQ VARIATION (group 2 & 3/A(NF) & A(WF))

The above tests can be selected by scrolling to the highlighted selection using the up and down key and the ENTER key to start the selected test. For some of these tests, numeric data entry may be required to define the test number or the modulation rate.

VOLT FREQ MIN

Standard/Group		RTCA	A(CF)	A(NF)	A(WF)
Voltage	1	100	100	100	100
	3	101.5	101.5	101.5	101.5
Frequency		380	390	360	360

Standard/Group		Group1	Group2	Group3
Voltage	1	104	104	104
	3	105.5	105.5	105.5
Frequency		390	360	360

Table 8-1: Normal Voltage and Frequency minimum

Standard/Group		RTCA	A(CF)	A(NF)	A(WF)
Voltage	1	122	122	122	122
	3	120.5	120.5	120.5	120.5
Frequency		420	410	650	800

Standard/Group		Group1	Group2	Group3
Voltage	1	122	122	122
	3	120.5	120.5	120.5
Frequency		410	650	800

Table 8-2: Normal Voltage and Frequency Maximum

This test will set the voltage and frequency to levels defined by Table 8-1. The test will last for 30 minutes. The test will be repeated, except group1, using the Voltage setting from Table 8-2 and the frequency from Table 8-1. The ← key (backspace) will terminate the test at any time.

VOLT FREQ MAX

This test will set the voltage and frequency to levels defined by Table 1-2. The test will last for 30 minutes. The test will be repeated, except group1, using the Voltage setting from Table 1-1 and the frequency from Table 1-2. The unselected phases will remain at 115 volts. The ← key (backspace) will terminate the test at any time.

VOLT UNBALANCE

Standard/Group	RTCA	A(CF)	A(NF)	A(WF)
Voltage offset	6	6	6	8
Frequency	400	390/410	360/650	360/800

Standard/Group	Group1	Group2	Group3
Voltage offset	6	6	9
Frequency	400	360/650	360/800

Table 8-3: Normal Voltage Unbalance

This test will change the output voltage for phase A and B to 122V and phase C to a voltage lower by a value specified by an offset. Refer to Table 8-3 for the offset value and the Frequency. The test will repeat with the same frequency and phase A and B volt is set to 100V and phase C set to a higher voltage specified by the offset value. The test will last 30 minutes. The test will be repeated for a second Frequency if applicable. The test can be terminated at any time.

The ← key will terminate the test at any time.

WAVEFORM DISTORTION

This test will generate a 5% THD voltage distortion on the output voltage waveform at the nominal voltage set. (115 V or 230 V) A clipped sine wave generates the required distortion. The test will last for 30 minutes. The ← key (backspace) will terminate the test at any time.

VOLTAGE MODULATION

This test requires a numeric value entry equal to the modulation rate in Hz. This entry value must be between 1 Hz and 200 Hz. The amplitude modulation is calculated based on the modulation rate as defined in Figure 8-4. This test will last for 2 minutes.

Note that the Airbus voltage modulation test levels are specified in peak to peak voltage instead of Vrms. Table 4-4 shows the levels for the Airbus mode versus the DO160 and EUROCAE modes as implemented in Lx/Ls firmware revision 0.98. The actual requirement for Airbus ABD0100.8 is now specified in Vpeak peak instead of Vrms so the Airbus mode should not be used. Use the DO160 or EURO/CAE mode instead.

Modulation Frequency (Hz)	DO160 / EUROCAE Volt RMS	Modulation Frequency (Hz)	AIRBUS Volt RMS
1	0.18	1	0.5
1.7	0.18	1.7	0.5
10	1.24	10	3.5
25	1.24	25	3.5
70	0.18	70	0.5
100	0.18	100	0.5
200	0.18	N/A	N/A

Table 8-4: Airbus mode voltage modulation.

Note: Voltage modulation levels change linearly from frequency 1.7Hz to 10Hz and again from 25Hz to 75Hz. See Figure 8-4.

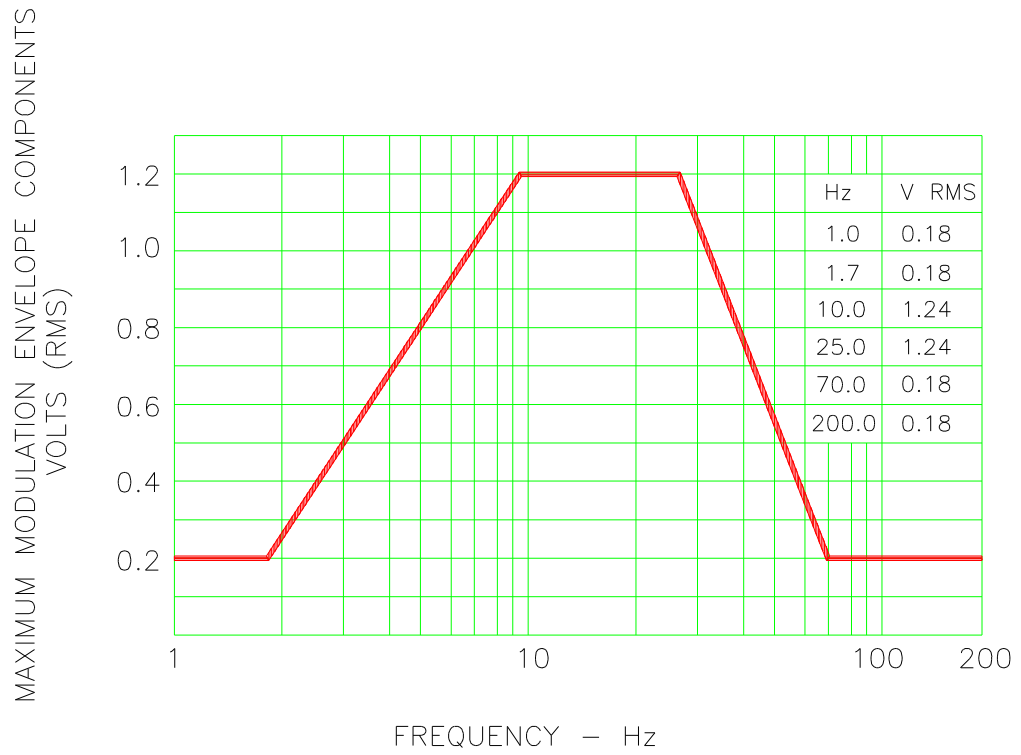

Figure 8-4: Voltage Modulation - Frequency characteristics

FREQUENCY MODULATION

This test requires a numeric value equal to the modulation rate in Hz. This value must be between 0.01 Hz and 100 Hz. The frequency modulation is calculated based on the modulation rate as defined in Figure 8-5. This test will last for a minimum of 2 minutes.

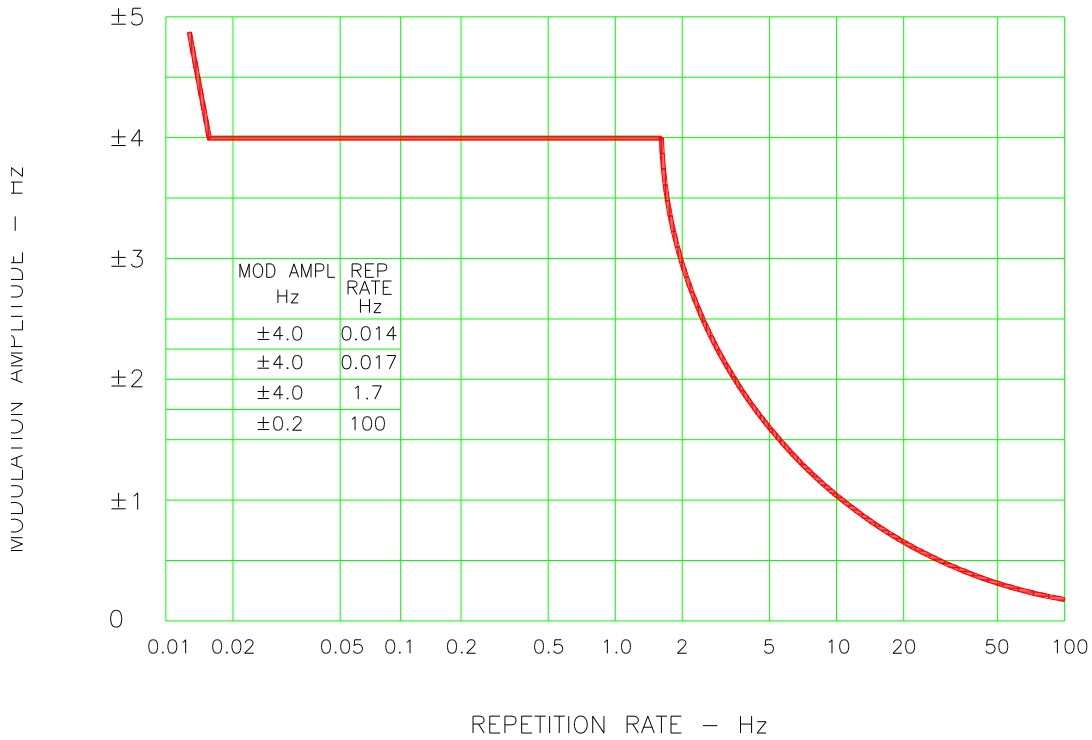
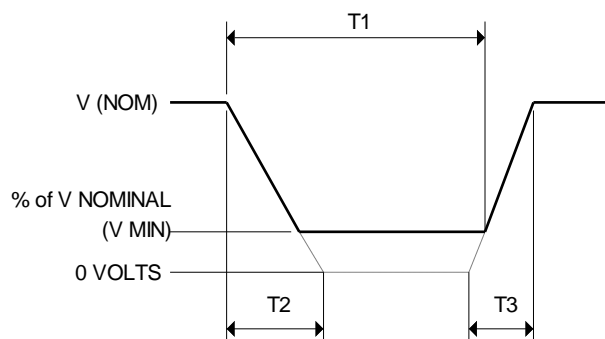

Figure 8-5: Frequency Modulation

POWER INTERRUPT

This test requires a numeric entry value equal to the test number. The tests are grouped as follows:

- Test numbers 1 through 15 are for all Standard and Groups. See Figure 8-6 for details of the tests.
- Test numbers 16 and 17 for all equipment that does not incorporate digital circuit. Test number 16 will drop the output to zero voltage for 50 ms. Test number 17 will drop the output to zero voltage for 200 ms. Test numbers 21 through 26 are applicable for Groups 2 and 3 only for EUROCAE standard and category A(NF) and A(WF) for RTCA2. Output frequency will be set to the F1 value for 1 second prior to the test. The output frequency will remain set to the F2 value when the test is completed. This will allow the user to apply sequence of power interrupts. See Figure 8-7 for detail of the tests.



DO160 Table 16-1: Test conditions for equipment with digital circuits.

- NOTES
- 1: Definitions:
 - T1 Power interrupt time
 - T2 Time it would take for the applied voltage to decay from V (nom) to zero volts.
 - T3 Time it would take for the applied voltage to rise from zero to V (nom) volts.
 - V MIN The minimum level (expressed as a percentage of V NOMINAL) to which the applied voltage is permitted to decay.
 - 2: Tolerance to T1, T2, T3 = ± 10%
 - 3: Test condition numbers 8 and 15 are for category Z, dc powered equipment only.

Applicable Category:	A				A, Z			Z	A, B, Z			A, Z			Z
	1**	2	3	4	5	6	7	8	9	10	11	12	13	14	15
Test Condition No.	1**	2	3	4	5	6	7	8	9	10	11	12	13	14	15
T1 (ms)	2**	10	25	50	75	100	200	1000	10	25	50	75	100	200	1000
T2 (ms)	<1	20*	20	20	20	20	20	20	50*	50*	50	50	50	50	50
T3 (ms)	<1	5	5	5	5	5	5	5	20	20	20	20	20	20	20
%V Nom. (V min)	0	50	15	10	5	0	0	0	80	50	0	15	5	0	0

* Voltage will not reach zero in this test condition.

** Equipment performance standards may require to repeat test n°1 with T1 varying from 5 to 200 ms by step defined in the test equipment performance standards (step typically comprised between 5 ms and 20 ms depending on equipment design).

Figure 8-6: Power Interrupt

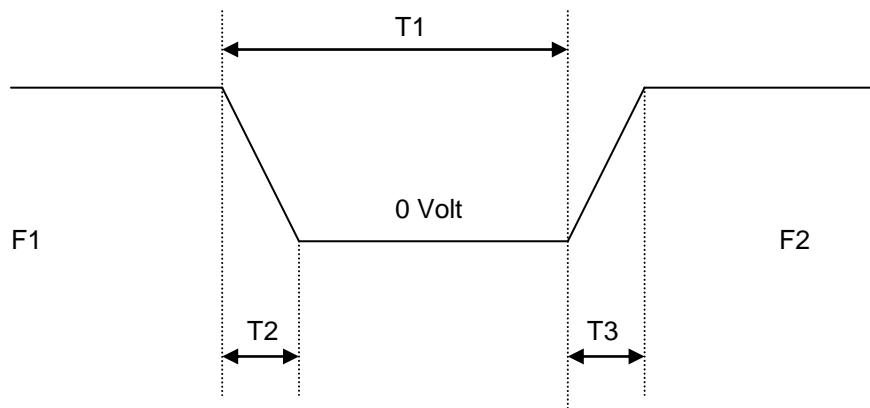

Test no.:	21	22	23	24	25	26
Standard:	I	II	III	IV	V	VI
T1 (ms)	50	50	100	100	200	200
F1 (Hz)	360	Fmax	360	Fmax	360	Fmax
F2 (Hz)	Fmax	360	Fmax	360	Fmax	360

Fmax = 650 Hz for Group2/A(NF)

Fmax = 800 Hz for Group3/A(WF)

T2 = 20 msec

T3 = 5 msec

Figure 8-7: Power Interrupt for Group2/A(NF) and Group3/A(WF)

VOLTAGE SURGE

This test requires 160V output voltage. If the power source is set at the low voltage range, the high voltage range will be selected before the test starts. At the end of the test, the power source will be switched back to the low range automatically.

Seq. No.	Voltage				Time
	RTCA	Group 1	Group 2	Group 3	ALL
1	115	115	115	115	5 Minute
2	160	160	160	170	30msec
3	115	115	115	115	5 Sec.
4	60	70	70	70	30msec
5	115	115	115	115	5 Sec.

Table 8-5: Normal VoltageSurge Sequence

The output voltage will follow the sequence in Table 8-5. The above sequence will repeat itself three times. Each repeat will start from sequence two. RTCA and Group 1 will run at 400 Hz. Group 2 and A(NF) will run at 360 Hz and 650 Hz. Group 3 and A(WF) will run at 360Hz and 800Hz. The frequency will return to the nominal setting when the test is completed. The ← key (backspace) will terminate the test at any time.

FREQUENCY TRANSIENTS (Group 1 and A(CF) only)

Seq. No	Frequency	Time
1	400	5 Minute
2	440	150msec
3	420	1.5sec
4	400	5Sec.
5	350	150msec
6	380	1.5sec
7	400	5Sec.

Table 8-6: Normal Frequency Transient Sequence

This test applies to Group1 and A(CF) only. The output voltage is set to Vnom (115 V) while the frequency is changed per the sequence listed in Table 8-6. The test will cycle 5 times starting from sequence 2. Steps 3 and 6 apply to A(CF) only.

FREQUENCY VARIATION (Group2 / A(NF) and Group3 / A(WF) only)

Seq. No	Initial Frequency		Slew rate	Final Frequency	
	Group2	Group3		Group2	Group3
1	360	360	100	650	800
2	650	800	100 or 200	360	360
3	360	360	Pause 5 sec	360	360

Table 8-7: Normal Frequency Variation Sequence

This test will apply to Group2/A(NF) and Group3/A(WF) only. . The output voltage is set to Vnom (115 V) while the frequency is set to 360Hz for 5 minutes. The frequency is slowed per the sequence listed in Table 8-7. The test will cycle 3 times. The frequency will return to nominal after the test is completed. Slew rates of 200Hz apply to RTCA2 only.

8.6 EMERGENCY TEST

From the DO160 MENU scroll to the EMERGENCY AC entry using the up and down cursor keys. Press the ENTER key to select the EMERGENCY screens. The screen will appear as shown in Figure 8-8.

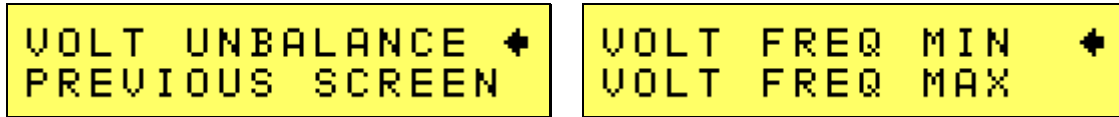

Figure 8-8: Emergency Screens

The EMERGENCY SCREEN has the following tests:

- 1 VOLT FREQ MIN
- 2 VOLT FREQ MAX
- 3 VOLT UNBALANCE

The above tests can be selected by scrolling to the highlighted selection using the up and down key and the ENTER key to start the selected test.

VOLT FREQ MIN

Standard/Group		RTCA	A(CF)	A(NF)	A(WF)
Voltage	1Φ	100	100	100	100
	3Φ	101.5	101.5	101.5	101.5
Frequency		360	360	360	360

Standard/Group		Group1	Group2	Group3
Voltage	1Φ	104	104	104
	3Φ	105.5	105.5	105.5
Frequency		360	360	360

Table 8-8: Emergency Voltage and Frequency Minimum

Standard/Group		RTCA	Group1	Group2	Group3
Voltage	1Φ	122	122	122	122
	3Φ	120.5	120.5	120.5	120.5
Frequency		440	440	650	800

Standard/Group		Group1	Group2	Group3
Voltage	1Φ	122	122	122
	3Φ	120.5	120.5	120.5
Frequency		440	650	800

Table 8-9: Emergency Voltage and Frequency Maximum

This test will set the voltage and frequency to a level defined by Table 8-8. The test will last for 30 minutes. The test will be repeated using the voltage from Table 8-9 and frequency from Table 8-8. The ← key (backspace) will terminate the test at any time.

VOLT FREQ MAX

This test will set the voltage and frequency to a level defined by Table 8-9. The test will last for 30 minutes. The test will be repeated using the voltage from Table 8-8 and frequency from Table 8-9. The ← key (backspace) will terminate the test at any time.

VOLT UNBALANCE

Standard/Group	RTCA	A(CF)	A(NF)	A(WF)
Voltage offset	8	8	8	10
Frequency	400	360/440	360/650	360/800

Standard/Group	Group1	Group2	Group3
Voltage offset	8	8	12
Frequency	400	360/650	360/800

Table 8-10: Emergency Voltage Unbalance

This test will change the output voltage for phase A and B to 122V and phase C to a voltage lower by a value specified by an offset. Refer to Table 8-10 for the offset value and the Frequency. The test will repeat with the same frequency and phase A and B volt is set to 100V and phase C set to a higher voltage specified by the offset. The test will last 30 minutes. The test will be repeated for a second Frequency if applicable. The test can be terminated at any time.

The ← key (backspace) will terminate the test at any time.

8.7 ABNORMAL TEST

From the DO160 MENU Scroll to the ABNORMAL AC entry using the up and down cursor keys. Press the ENTER key to select the ABNORMAL screens. The screen will appear as shown in Figure 8-9.

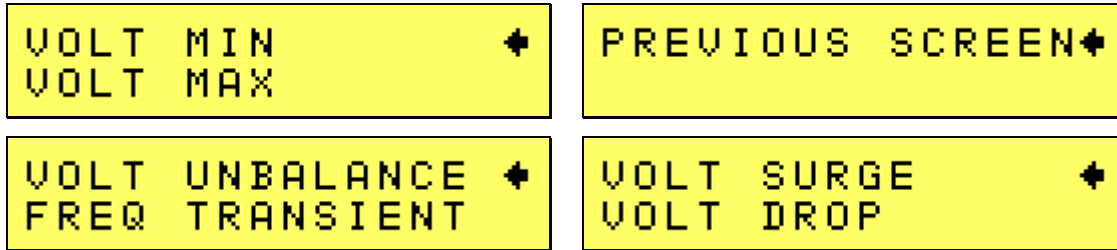

Figure 8-9: Abnormal Screen

The ABNORMAL SCREEN has the following tests:

- 1 VOLT MAX
- 2 VOLT MIN
- 3 VOLT UNBALNCE
- 4 VOLT SURG
- 5 VOLT DROP
- 6 FREQ TRANSIENTS

The above test can be selected by scrolling to the highlighted selection using the up and down key and the ENTER key to start the selected test.

VOLT MAX

Standard/Group		RTCA	Group1/A(CF)		Group2/A(NF)	Group3/A(WF)
Voltage	1	97	97	104/100	97	97
	3	98.5	98.5	105.5/101.5	98.5	98.5
Frequency		400	400	370	360	360

Table 8-11: Abnormal Voltage Minimum

Standard/Group		RTCA	Group1/ACF)		Group2/A(NF)	Group3/A(WF)
Voltage	1	134	134	122	134	134
	3	132.5	132.5	120.5	132.5	132.5
Frequency		400	400	430	650	800

Table 8-12: Abnormal Voltage Maximum

This test will set the voltage and frequency to levels defined by Table 8-11 for 5 minutes. The test will be repeated for Group1 and A(CF) only as indicated in Table 1-10 for voltage and Table 8-12 for frequency. All Groups will repeat the test using Table 1-10 for the voltage setting and Table 1-10 or Table 1-11 for the frequency setting. The ← key (backspace) will terminate the test at any time.

VOLT MIN

This test will set the voltage and frequency to levels defined by Table 8-12 for 5 minutes. The test will be repeated for Group1 only as indicated in Table 8-12. All Groups will repeat the test using Table 8-12 for the voltage setting and Table 8-11 for the frequency setting. The ← key (backspace) will terminate the test at any time.

VOLT UNBALANCE

This test applies only to RTCA2 standard.

Standard/Group	A(CF)	A(NF)	A(WF)
Voltage offset	6	6	8
Frequency	400	360/650	360/800

Table 8-13: Abnormal Voltage Unbalance

This test will change the output voltage for phase A and B to 134V and phase C to a voltage lower by a value specified by an offset. Refer to Table 8-13 for the offset value and the Frequency. The test will repeat with the same frequency and phase A and B volt is set to 97V and phase C set to a higher voltage specified by the offset. The test will last 5 minutes. The test will be repeated for a second Frequency if applicable. Additional test for A(CF) category is applied with phase A and voltage set at 122V and phase C at 116V. The frequency is set at 430V. The test is repeated with the same frequency but phase A and B are set at 100V and phase C set at 106V. Both tests are repeated for 370Hz. The test can be terminated at any time. The ← key (backspace) will terminate the test at any time.

VOLT UNDER

This test will drop the output voltage from 115 volts to 60 volts for 7 seconds.

VOLT SURGE

This test requires 180 volt output voltage. If the power source is set at the low voltage range, the high voltage range will be selected before the test starts. At the end of the test the AC source will be switched back to the low range.

Note: To avoid switching to the high voltage range which provides only half the current of the low voltage range, the -EHV option range pair must be installed (200/400V).

The output voltage will surge to 180 volts for 100 ms. followed by drop to 148 volts for 1 sec before it returns to 115 volts. The ← key (backspace) will terminate the test at any time.

FREQUENCY TRANSIENTS (A(CF) only)

Test 1

Seq. No.	Volt/Frequency	Time
1	115/400	5 minutes
2	115/350	5 sec.
3	115/320	0.2 sec.
4	0/320	0.2 sec.
5	115V/400	10 sec.

Test 2

Seq. No.	Volt/Frequency	Time
1	115/400	5 minutes
2	115/480	0.2 sec.
3	115/440	5 sec.
4	0/440	0.2 sec.
5	115V/400	10 sec.

FREQUENCY TRANSIENTS (Group 1 only)

Seq. No.	Frequency	Time
1	400	5 minutes
2	480	5 sec.
3	400	10 sec.
4	320	5 sec.
5	400	10 sec.

Table 8-14: Abnormal Frequency Transient

This test will set the voltage at 115V and will remain at this voltage through out the test except for the A(CF) category. The test will cycle the frequency three times as shown in Table 8-14. Each repeat will start from sequence 2. Test1 and test2 for the A(CF) category are done in succession as a single test.

9. Option -704: MIL-STD 704 Rev D through F (MIL704 Mode)

9.1 General

This user manual assumes that the user is familiar with the text of the relevant MIL-STD 704, test standard. No attempt is made to explain or elaborate on the actual test specification.

The -704 option as implemented on the Lx/Ls Series only supports AC power applications. DC mode is not available on the Lx/Ls Series so no DC tests are provided in the -704 option.

The Lx/Ls supports two different implementations of the MIL-STD 704. This chapter covers the legacy implementation referred to on the menu screens as MIL704. This implementation (Option -704) pre-dates the release of the test protocol handbook that accompanied revision F of the standard. To test conform the suggested test protocol, use the MS704 test mode instead. (Option -704F, Refer to Chapter 10.)

Test Execution Considerations

Several of the MIL-STD 704 test steps take considerable time to execute. Tests in progress may be aborted by using the BACK button on the Lx/Ls front panel.

9.2 Initial Setup

Nominal parameters for the AC Power source are as follows:

Output Voltage	115V L-N or 230V L-N
Output Frequency	360 Hz to 800 Hz for all revisions. 60 Hz for revision F only.

Note: *A setting outside these nominal values will disable the test and will prevent access to the 704 Menu screens or execution of any test step. To execute all tests for the 230V L-N, the power source must be capable of programming 360V RMS. This requires the -EHV option output range pair (200/400V). If this option is not installed, some tests will be skipped.*

9.3 Test Revision

The MIL-STD 704 option is capable of performing all sub-sections of MIL-STD 704 revision D, E or F. A selection is made available to specify the revision of standard to be applied to the EUT. The MIL704 option defaults to Revision E.

9.4 Tests Performed

9.4.1 STEADY STATE

AC Source:

Steady State Voltage and Frequency test

Waveform Distortion test

Voltage Modulation test

Voltage Unbalance test

Phase Unbalance test

Frequency Modulation test

Voltage Modulation test

Transient Voltage low and high test

Transient Frequency low and high test

9.4.2 EMERGENCY STATE

Emergency Voltage minimum and maximum test

Emergency Frequency minimum and maximum test

9.4.3 ABNORMAL STATE

Abnormal Voltage under

Abnormal Voltage over

Abnormal Frequency under

Abnormal Frequency under

9.5 Front Panel Operation MIL704

To perform a test from the keyboard, from the MENU 2 screen, select the APPLICATIONS screen. The APPLICATIONS screen will appear as shown in Figure 9-1.

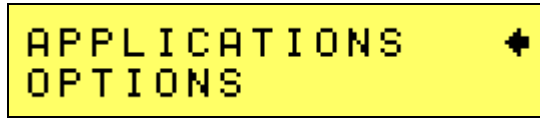

Figure 9-1: Applications Menu

Scroll to the MIL-STD-704 entry using the up and down cursor keys. Press the ENTER key to select the MIL704 main menu. One of the screens will appear as shown in.

Note: The user has to turn on the Output relay before starting a test and set the steady state setup for the test. NOM FREQ must be set to match the desired steady state frequency. All MIL704 revisions will accept 400Hz as a nominal frequency. Revision F only will accept 60Hz and VFREQ.

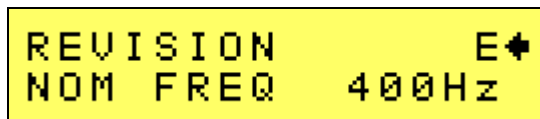

Figure 9-2: MIL704 Menu

9.5.1 Revision Selection

The default Revision is E. Revisions supported is D, E and F. The Revision can be changed from the front panel. Scroll to the REVISION entry using the up and down cursor keys (Figure 9-2). Use the shuttle to change the selection.

9.5.2 Nominal Frequency Selection

Three selections are available for the nominal frequency to be used:

- 400Hz, this selection is active in all revisions. Program frequency must be set to 400Hz.
- VFREQ, this selection is active for revision F only. Program frequency must be set between 360Hz and 800Hz to run the tests.
- 60Hz, this selection is active for revision F only. Program frequency must be set to 60Hz to run the tests.

Note that the programmed frequency of the AC source must be the same as the selected nominal test frequency selected in the 704 screen. If not, a Setting Conflict error will be generated when attempting to run a test. The programmed frequency can only be changed from the normal setup screen. Selecting the nominal test frequency in the 704 Application screen does not change the output frequency programmed.

9.6 Steady State Tests

Scroll to the STEADY STATE entry using the up and down cursor keys. Press the ENTER key to select the STEADY STATE screens. The screen will appear as shown in Figure 9-3

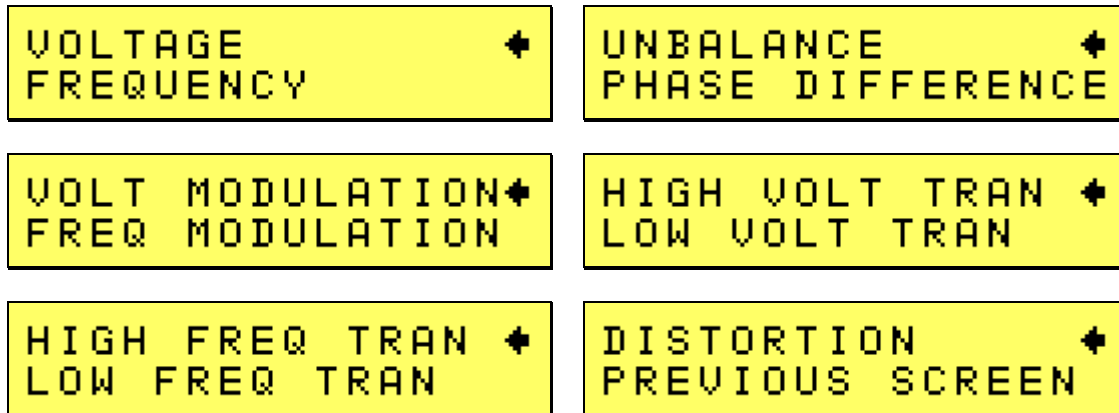

Figure 9-3: Steady State Menu

The MIL704 Steady state screens have the following tests:

1. VOLTAGE
2. FREQUENCY
3. VOLT UNBALANCE
4. PHASE DIFFERENCE
5. VOLT MODULATION
6. FREQ MODULATION
7. VOLT TRANSIENT
8. FREQ TRANSIENT
9. DISTORTION

The above tests can be selected by scrolling to the highlighted selection using the up and down cursor keys and the ENTER key to start the selected test.

VOLTAGE

This test will change the output voltage in the sequence shown in Table 9-1.

SEQUENCE	VOLTAGE		TIME
	400Hz/VFREQ	60Hz only	
1	108	110	1 minute
2	118	125	1 minute
3	115	115	1 minute

Table 9-1: Steady state voltage

The ← key (backspace) will terminate the test at any time.

FREQUENCY

This test will change the output frequency in the sequence shown in Table 9-2.

SEQUENCE	FREQUENCY	TIME
----------	-----------	------

	400Hz	VFREQ	60 Hz	
1	393	360	59	1 minute
2	407	800	61	1 minute
3	400	SSF	60	1 minute

Table 9-2: Steady state frequency

The ← key (backspace) will terminate the test at any time.

VOLT UNBALANCE

This test will change the output voltage for the selected phase only in the following sequence:

- 112V for 1 minute.
- 118V for 1 minute.
- 115V for 1 minute.

The test will be repeated on three phase systems to include all three phases if the coupling is set to all.

The ← key (backspace) will terminate the test at any time.

PHASE DIFFERENCE

This test applies to three phase systems only. The phase angle for the selected phase will change relative to phase A in the following sequence:

If phase B is selected:

- 236° for 1 minute.
- 244° for 1 minute.
- 240° for 1 minute.

If phase C is selected:

- 116° for 1 minute.
- 124° for 1 minute.
- 120° for 1 minute

VOLTAGE MODULATION

This test will vary the output voltage by $\pm 2.5V$ rms over a period of one second. The test will last for 2 minutes. The ← key (backspace) will terminate the test at any time.

FREQUENCY MODULATION

REVISION	D	E	F (400Hz /VFREQ)	F (60HZ)
MODULATION	$\pm 7Hz$	$\pm 4Hz$	$\pm 4Hz$	$\pm 0.5Hz$

Table 9-3: Frequency Modulation

This test will vary the output frequency as defined by Table 9-3 over a period of one minute. The test will last for 4 minutes. The ← key (backspace) will terminate the test at any time.

WAVEFORM DISTORTION

This test will generate a 5% THD voltage distortion on the output voltage waveform. Using a clipped sine wave causes the distortion. The test will last for 2 minutes. The ← key (backspace) will terminate the test at any time.

HIGH VOLTAGE TRANSIENT

This test will change the output voltage for the selected phase in the following sequence:

For 400 Hz and VFREQ:

- 180V for 10msec.
- Linearly reduced to 118V in 78msec.
- Stay at 118V for 87msec before returning to 115V.

For 60 Hz only:

- 170V for 1.67msec
- Linearly reduced to 130V in 14msec.
- Linearly reduced to 120V in 83.3msec.
- Stay at 120V for 75msec.

Note: Prior to the test, a voltage range change may take place if the power source is set for the low voltage range. This will cause the EUT to lose power momentarily. If this is not acceptable, the power source must be left in high range at all times.

After this sequence, a 5 second delay will be inserted at the nominal test voltage. The ← key (backspace) will terminate the test at any time.

LOW VOLTAGE TRANSIENT

This test will change the output voltage for the selected phase only in the following sequence:

For 400 Hz and VFREQ:

- 80V for 10msec.
- Linearly increase to 108V in 70msec.
- Stay at 108V for 95msec before returning to 115V.

For 60Hz only:

- 0V for 1.67msec.
- Linearly increase to 70V in 14msec.
- Linearly increase to 105V in 83.3msec
- Stay at 105V for 75msec.

After this sequence, a 5 second delay will be inserted at the nominal test voltage. The ← key (backspace) will terminate the test at any time.

HIGH FREQUENCY TRANSIENT

This test will change the output frequency in the following sequence:

For 400Hz and VFREQ:

- 425Hz for 1 sec.
- 420Hz for 4 sec.

- 410Hz for 5 sec.
- 407Hz for 4 sec.

For 60Hz only:

- 61Hz for 0.5 sec.
- 60.5Hz for 0.5 sec.

After this sequence, a 5 second delay will be inserted at the nominal test frequency. The ← key (backspace) will terminate the test at any time.

LOW FREQUENCY TRANSIENT

This test will change the output frequency in the following sequence:

For 400Hz and VFREQ:

- 375Hz for 1 sec.
- 380Hz for 4 sec.
- 390Hz for 5 sec.
- 393Hz for 4 sec.

For 60Hz only:

- 59Hz for 0.5 sec.
- 59.5Hz for 0.5 sec.

After this sequence, a 5 second delay will be inserted at the nominal test frequency. The ← key (backspace) will terminate the test at any time.

9.7 EMERGENCY TEST

From the MIL704 main menu (Figure 9-2) scroll to the EMERGENCY entry using the up and down cursor keys. Press the ENTER key to select the EMERGENCY screens. The screen will appear as shown in Figure 9-4.

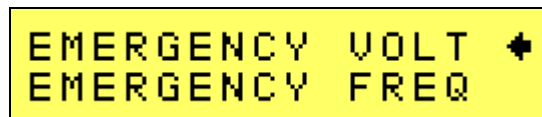

Figure 9-4: Emergency Menu

The EMERGENCY SCREEN has the following tests:

- 1 VOLTAGE
- 2 FREQUENCY

The above tests can be selected by scrolling to the highlighted selection using the up and down key and the ENTER key to start the selected test.

Note: *These tests are only required for revision D. See steady state voltage and frequency tests for all other revisions.*

VOLTAGE

This test will change the output voltage in the following sequence:

- 104V for 1 minute.
- 122V for 1 minute.
- 115V for 1 minute.

The ← key (backspace) will terminate the test at any time.

FREQUENCY

This test will change the output frequency in the following sequence:

- 360Hz for 1 minute.
- 440Hz for 1 minute.
- 400Hz for 1 minute.

The ← key (backspace) will terminate the test at any time.

9.8 ABNORMAL TEST

From the MIL704 main menu (Figure 9-2) scroll to the ABNORMAL AC entry using the up and down cursor keys. Press the ENTER key to select the ABNORMAL screens. The screen will appear as shown in Figure 9-5.



Figure 9-5: Abnormal Screens

The ABNORMAL SCREEN has the following tests:

1. OVER VOLTAGE
2. UNDER VOLTAGE
3. OVER FREQUENCY
4. UNDER FREQUENCY

The above test can be selected by scrolling to the highlighted selection using the up and down key and the ENTER key to start the selected test.

OVER VOLTAGE

This test will change the output voltage for the selected phase in the following sequence:

For 400Hz and VFREQ:

- 180V for 50msec.
- The voltage gradually decays with time to 125 volt by the following equation:

$$V = 124.6 + 2.77/t. \text{ For } 0.05 \leq t \leq 6.925$$
- Stay at 125V for 93 seconds before returning to 115V.

For 60Hz only:

- 180V for 3.34msec
- The Voltage gradually decays with time to 122 volt by the following equation:

$$V = 121.7 + 0.583/t. \text{ For } 0.00334 \leq t \leq 1.947$$

- Stay at 122V for 8 seconds before returning to 115V.

Note: Prior to the test, a voltage range change may take place if the power source is set for the low voltage range. This will cause the EUT to loose power momentarily. If this is not acceptable, the power source must be left in high range at all times.

The ← key (backspace) will terminate the test at any time.

UNDER VOLTAGE

This test will change the output voltage for the selected phase in the following sequence:

For 400Hz and VFREQ:

- 0V for 7 seconds.
- 100V for 93 seconds.

For 60Hz only

- 0V for 2 seconds.
- 100V for 8 seconds.

The ← key (backspace) will terminate the test at any time.

OVER FREQUENCY

This test will change the output frequency in the sequence shown in Table 9-4 before returning to the steady state frequency.

The ← key (backspace) will terminate the test at any time.

Revision	D		E		F		F 60Hz only	
	FREQ	Time	FREQ	Time	FREQ	TIME	FREQ	TIME
Seq1	480Hz	5sec.	480Hz	5sec.	480Hz	5sec	61Hz	7sec
Seq2	420Hz	5sec	420Hz	9sec	420Hz	5sec	60.5Hz	8sec

Table 9-4: Abnormal Over Frequency

After this sequence, a 5 second delay will be inserted at the nominal test frequency. The ← key (backspace) will terminate the test at any time.

UNDER FREQUENCY

This test will change the output frequency in the sequence shown in Table 9-5 before returning to steady state frequency.

The ← key (backspace) will terminate the test at any time.

Revision	D		E		F		F 60Hz only	
	FREQ	Time	FREQ	Time	FREQ	TIME	FREQ	TIME
Seq1	0	5sec.	0Hz	7sec.	0Hz	7sec	0Hz	7sec
Seq2	375Hz	5sec	380Hz	7sec	380Hz	3sec	59.5Hz	8sec

Table 9-5: Abnormal Under Frequency

After this sequence, a 5 second delay will be inserted at the nominal test frequency. The ← key (backspace) will terminate the test at any time.

10. Option –704F: MIL-STD 704 Rev A through F (MS704 mode)

10.1 General

This user manual assumes that the user is familiar with the text of the relevant MIL-STD 704, test standard. No attempt is made to explain or elaborate on the actual test specification.

The –704F option as implemented on the Lx/Ls Series only supports AC power applications. DC mode is not available on the Lx/Ls Series so no DC tests are provided in the –704 option.

The Lx/Ls supports two different implementations of the MIL-STD 704. This chapter covers the implementation that follows the test protocol handbook released with revision F of the standard. This mode is selected by scrolling down in the APPLICATIONS menu to the MS704 entry and pressing the ENTER key.

To test conform the legacy protocol instead, use the MIL704 mode from the APPLICATIONS screen. (Refer to Chapter 9.)

Note: *The MS704 mode was added with revision 0.99 firmware. If your Lx/Ls has an older firmware revision, the –704F option will not be available but MIL704 mode will be available as long as the –704 option was purchased. Check the California Instruments website at www.calinst.com for available firmware upgrades.*

10.2 Initial Setup

Nominal parameters for the AC Power source are as follows:

Output Voltage	115V L-N or 230V L-N
Output Frequency	360 Hz to 800 Hz for all revisions. 60 Hz for revision F only.

Note: *A setting outside these nominal values will disable the test and will prevent access to the 704 Menu screens or execution of any test step. To execute all tests for the 230V L-N, the power source must be capable of programming 360V RMS. This requires the -EHV option output range pair (200/400V). If this option is not installed, some tests will be skipped.*

10.3 Test Revision

The MIL-STD 704 option is capable of performing all sub-sections of MIL-STD 704 revision A, B, C, D, E or F. A selection is made available to specify the revision of standard to be applied to the EUT.

The MIL704 option defaults to Revision E.

10.4 Power Group Reference

The following power groups are supported by the –704F option.

Test Group	Description
704F_TP_SAC	Single phase, AC mode, 400 Hz nominal frequency
704F_TP_SVF	Single phase, AC mode, variable nominal frequency
704F_TP_SXF	Single phase, AC mode, 60 Hz nominal frequency
704F_TP_TAC	Three phase, AC mode, 400 Hz nominal frequency
704F_TP_TVF	Three phase, AC mode, variable nominal frequency

Table 10-1: DO160 Test Groups

10.5 Available Tests

Available tests at the Group level are shown in this section. For details on test levels and test times for various test conditions in each group, refer to section 10.7 in this manual.

10.5.1 Normal Operation

AC Mode:

Test	Section
Steady State Limits for Voltage and Frequency (Includes Unbalance)	102
Voltage Phase Difference	103
Voltage Modulation	104
Frequency Modulation	105
Total Voltage Distortion	107
Normal Voltage Transient	109
Normal Frequency Transient	110

10.5.2 Transfer Operation

AC Mode:

Test	Section
Power Interrupt	201

10.5.3 Abnormal Operation

AC Mode:

Test	Section
Abnormal Limits for Voltage and Frequency	301
Abnormal Voltage Transients	302
Abnormal Frequency Transients	303

10.5.4 Emergency Operation

AC Mode:

Test	Section
Emergency Limits for Voltage and Frequency	401

10.5.5 Power Failure Operation

AC Mode:

Test	Section
Power Failure (Three Phase)	601
One Phase and Two Phase Power Failures	602
Phase Reversal	603

10.6 Front Panel Operation MS704

This section covers operating the –704 option from the front panel keyboard. For remote control operation, refer to the Lx/Ls Series Programming Manual (P/N 7004-961).

To perform a test from the keyboard, from the MENU 2 screen, select the APPLICATIONS screen. The APPLICATIONS screen will appear as shown in Figure 10-1.

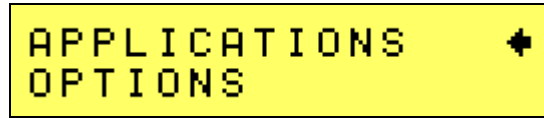

Figure 10-1: Applications Menu

Use the ENTER Key and scroll to the MS704 entry using the up and down cursor keys. Press the ENTER key to select the MS704 main menu. The Run/Status screen will appear shown in Figure 10-2.

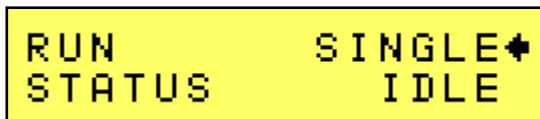

Figure 10-2: MIL704 Run/Status

Note: Prior to starting any tests, you must turn on the Output relay and set the desired steady state output settings for the test. Also select the appropriate parameters that define revision, and test type before starting the test.

The RUN field has two parameters that can be selected by the shuttle, SINGLE and CONT. Scroll to the RUN entry using the up and down cursor keys. Use the shuttle to change the selection. Use the ENTER Key to Run the test. The screen will appear as shown in Figure 10-3 while the test is running.

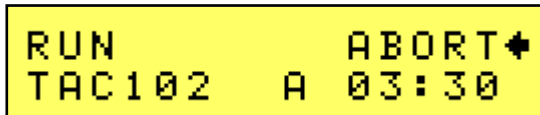

Figure 10-3: Mil704 Run/Status

The status line will show the type of test that is running followed by the Test condition and the remaining time to complete the test condition. Test condition may be repeated several times before moving to the next test condition. Run Single will terminate the test once the test condition is completed. Run Continuous will terminate the test only when all remaining test condition is completed.

Note: *Several of the MIL-STD 704 test steps take considerable time to execute. Tests in progress may be aborted by using the BACK button on the Lx/Ls front panel.*

10.6.1 Revision and Group Selection

Revision and Group selection must be selected prior to running the test. Use the up and down key to access the screen as shown in Figure 10-4

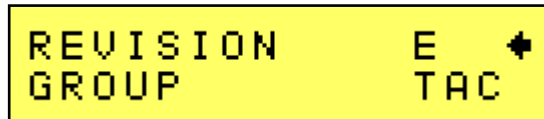

Figure 10-4: Revision/Group Menu

The default Revision is E. Revisions supported are A, B, C, D, E and F. Scroll to the REVISION entry using the up and down cursor key. Use the shuttle to change the selection.

The default GROUP is TAC. Groups supported are SAC, TAC, SVF, TVF and SXF. Use the shuttle to change the group selection.

10.6.2 Operating Area and Test Selection

Operating area and test define the test to perform. Use the up and down key to access the screen as shown in Figure 10-5

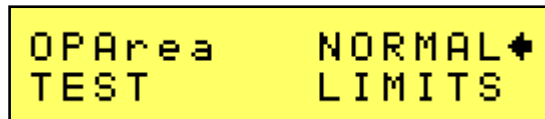

Figure 10-5: Test selection Menu

Scroll to the OPArea (Operating Area) and or TEST entry using the up and down cursor keys. Use the shuttle to change the selection. The OPArea and Test selection offer the choices shown in Table 10-2.

OPArea	NORMAL	TRANSFER	ABNORMAL	EMERGENCY	PFAILURE
TEST:	LIMITS	POW INT	LIMITS	LIMITS	THREE
	PH DIFF		VTRANS		COMB
	VOLT MOD		FTRANS		PREVERSAL
	FREQ MOD				
	DIST TH				
	VTRANS				
	FTRANS				

Table 10-2: Test Selections

10.6.3 Section and Test Condition Selection

The test section and test condition of the test to be performed is selected from section and test condition entry screen. Use the up and down key to access the screen as shown in Figure 10-6.

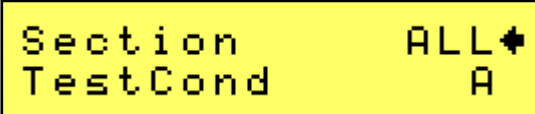

```

Section      ALL
TestCond    A
  
```

Figure 10-6: Section and Test Condition

The start and end of Test Condition will be within the tested Section.

Note: All MIL704 tests start with condition A, even if the specification specifies the start test condition as AA.

10.6.4 Steady State Frequency Selection

The applicable Steady State Frequency can be selected from the SSTFreq screen by rotating the shuttle. The available frequency selections will depend on the group selected. Figure 10-7 shows the steady state frequency entry. The test must be repeated for each available frequency selection to satisfy the test requirements. Table 10-3 shows the available steady state frequencies for each group.

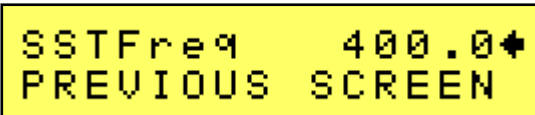

```

SSTFreq    400.0
PREVIOUS SCREEN
  
```

Figure 10-7: Steady State frequency

GROUP	Steady State Frequency in Hz			
SAC	400			
TAC	400			
SVF	400	360	600	800
TVF	400	360	600	800
SXF	60			

Table 10-3: Steady state frequency

10.6.5 Test Execution

Once Power group (Section) and test step (Condition) has been selected, execution can be started by moving the cursor to the RUN/STATUS screen RUN field. Press the ENTER key to start the test.

Note: Prior to starting any tests, you must turn on the Output relay.

The RUN field has two parameters that can be selected by the shuttle, SINGLE and CONT. Scroll to the RUN entry using the up and down cursor keys. Use the shuttle to change the selection. Use the ENTER Key to Run the test.

Several of the MIL-STD 704 test steps take considerable time to execute. Tests in progress may be aborted by using the BACK button on the Lx/Ls front panel.

10.7 Test Steps and Execution Times Summary

With the release of revision F and the accompanying test protocol handbook, the MIL-STD 704 has grown in scope considerably. Rather than duplicating all this information in this user manual, the user is referred to the MIL-STD 704 Specification documentation for test details on each specific test.

A summary of tests arranged by group is provided in this section. Approximate test times are shown for each tests. Where tests differ by standard revisions, separate tables are shown for revisions that differ in test levels and or execution times.

10.7.1 SAC Group - Single phase 400 Hz AC tests

SAC 102 Tests - Revisions C, D, E, F

SAC102	Steady State Voltage and Frequency - Rev C-F	
Condition		Duration (s)
Nominal Voltage		
A	Vnom=115V, Fnom=400 Hz - Nominal	1800
B	Vnom=115V, Flow=393 Hz - Nominal	1800
C	Vnom=115V, Fhigh=407 Hz - Nominal	1800
Low Voltage		
D	Vlow =108V, Fnom=400 Hz - Low	1800
E	Vlow=108V, Flow= 393 Hz- Low	1800
F	Vlow=108V, Fhigh=407 Hz - Low	1800
High Voltage		
G	Vhigh=118V, Fnom=400 Hz - High	1800
H	Vhigh=118V, Flow=393 Hz- High	1800
I	Vhigh=118V, Fhigh=407 Hz - High	1800

SAC 102 Tests - Revision B

SAC102	Steady State Voltage and Frequency - Rev B	
Condition		Duration (s)
Nominal Voltage		
A	Vnom=115V, Fnom=400 Hz - Nominal	1800
B	Vnom=115V, Flow=395 Hz - Nominal	1800
C	Vnom=115V, Fhigh=405 Hz - Nominal	1800
Low Voltage		
D	Vlow =108V, Fnom=400 Hz - Low	1800
E	Vlow=108V, Flow= 395 Hz- Low	1800
F	Vlow=108V, Fhigh=405 Hz - Low	1800
High Voltage		
G	Vhigh=118V, Fnom=400 Hz - High	1800
H	Vhigh=118V, Flow=395 Hz- High	1800
I	Vhigh=118V, Fhigh=405 Hz - High	1800

SAC 102 Tests - Revision A

SAC102	Steady State Voltage and Frequency - Rev A	
Condition		Duration (s)
Nominal Voltage		
A	Vnom=115V, Fnom=400 Hz - Nominal	1800
B	Vnom=115V, Flow=380 Hz - Nominal	1800
C	Vnom=115V, Fhigh=420 Hz - Nominal	1800
Low Voltage		
D	Vlow =108V, Fnom=400 Hz - Low	1800
E	Vlow=108V, Flow= 380 Hz- Low	1800
F	Vlow=108V, Fhigh=420 Hz - Low	1800

SAC102		Steady State Voltage and Frequency - Rev A	
Condition			Duration (s)
	High Voltage		
G	Vhigh=118V, Fnom=400 Hz - High		1800
H	Vhigh=118V, Flow=380 Hz- High		1800
I	Vhigh=118V, Fhigh=420 Hz - High		1800

SAC 103 Tests

Voltage Phase Difference tests do not apply for single-phase EUT's.

SAC 104 Tests - Revisions B, C, D, E, F

SAC104		Voltage Modulation Rev B - F	
Condition			Duration (s)
A	Vmod F = 1.0 Hz, V = 0.375 Vrms		1800
B	Vmod F = 1.7 Hz, V = 0.375 Vrms		1800
C	Vmod F = 10 Hz, V = 2.5 Vrms		1800
D	Vmod F = 25 Hz, V = 2.5 Vrms		1800
E	Vmod F = 70 Hz, V = 0.375 Vrms		1800
F	Vmod F = 100 Hz, V = 0.375 Vrms		1800
G	Vmod F = 200 Hz, V = 0.375 Vrms		1800

SAC 104 Tests - Revisions A

SAC104		Voltage Modulation Rev A	
Condition			Duration (s)
A	Vmod F = 1.0 Hz, V = 0.5 Vpp		1800
B	Vmod F = 1.7 Hz, V = 0.5 Vpp		1800
C	Vmod F = 10 Hz, V = 3.5 Vpp		1800
D	Vmod F = 25 Hz, V = 3.5 Vpp		1800
E	Vmod F = 70 Hz, V = 0.5 Vpp		1800
F	Vmod F = 100 Hz, V = 0.5 Vpp		1800
G	Vmod F = 200 Hz, V = 0.5 Vpp		1800

SAC 105 Tests – Revisions E, F

SAC105		Frequency Modulation Rev E, F	
Condition			Duration (s)
A	Fmod F = 1 Hz/sec, Fmod Amp = 4 Hz± 2 Hz		1800
B	Fmod F = 5 Hz/sec, Fmod Amp = 4 Hz± 2 Hz		1800
C	Fmod F = 10 Hz/sec, Fmod Amp = 4 Hz± 2 Hz		1800
D	Fmod F = 25 Hz/sec, Fmod Amp = 4 Hz± 2 Hz		1800
E	Fmod F = 100 Hz/sec, Fmod Amp = 4 Hz± 2 Hz		1800

SAC 105 Tests – Revisions B, C, D

SAC105 Condition	Frequency Modulation Rev B, C, D	Duration (s)
A	Fmod F = 1 Hz/sec, Fmod Amp = ±5 Hz	1800
B	Fmod F = 5 Hz/sec, Fmod Amp = ±1.75 Hz	1800
C	Fmod F = 10 Hz/sec, Fmod Amp = ±1.20 Hz	1800
D	Fmod F = 25 Hz/sec, Fmod Amp = ±0.85 Hz	1800
E	Fmod F = 100 Hz/sec, Fmod Amp = ±0.58 Hz	1800

SAC 105 Tests – Revisions A

SAC105 Condition	Frequency Modulation Rev A	Duration (s)
A	Fmod F = 1 Hz/sec, Fmod Amp = ±4 Hz	1800
B	Fmod F = 5 Hz/sec, Fmod Amp = ±4 Hz	1800
C	Fmod F = 10 Hz/sec, Fmod Amp = ±4 Hz	1800
D	Fmod F = 25 Hz/sec, Fmod Amp = ±4 Hz	1800

SAC 106 Tests

Voltage distortion spectrum test require the use of additional external equipment. In particular, a high bandwidth (100Khz) AC source, a high frequency coupling transformer and coupling network as shown in figure SAC106-1 of the Mil-Std 704 standard. For this test, the Lx/Ls Series AC source can be programmed to a steady state condition of 400 Hz and Vnominal of 115 Vrms or 230 Vrms.

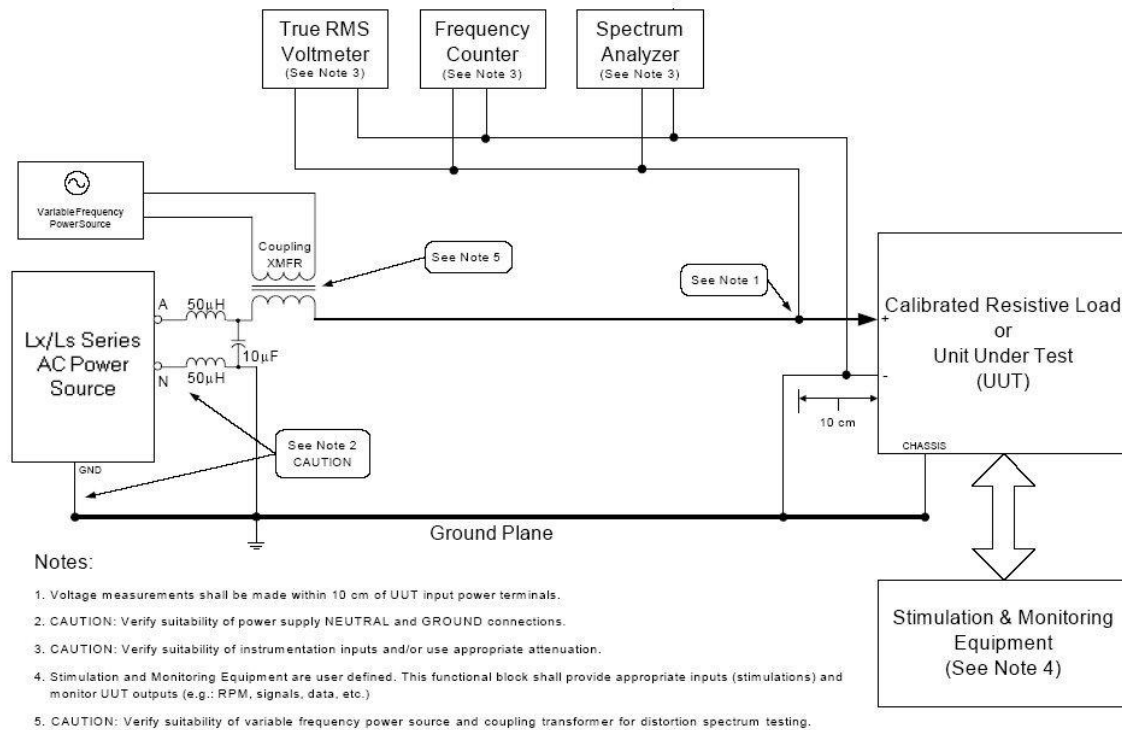

Figure 10-8: Required SAC-106 Test Setup.

SAC 107 Tests – Revisions B, C, D, E, F

SAC107	Total Voltage Distortion Rev B,C,D,E,F	Duration (s)
Condition		
A	0.05 % VTHD	1800
	F = 100%	
	H3 = 2.75%	
	H5 = 2.75%	
	H7 = 1.97%	
	H9 = 1.53%	
	H11 = 1.25%	
	H13 = 1.06%	
H15 = 0.92%		

SAC 107 Tests – Revisions A

SAC107	Total Voltage Distortion Rev A	Duration (s)
Condition		
A	0.08 % VTHD	1800
	F = 100%	
	H3 = 5.00%	
	H5 = 4.12%	
	H7 = 2.94%	
	H9 = 2.29%	
	H11 = 1.87%	
	H13 = 1.06%	
H15 = 1.37%		

SAC 108 Tests

SAC108 are DC offset tests and are not supported by the Lx/Ls Series AC Power sources. Contact California Instruments for DC Supply information. (sales@calinst.com)

SAC 109 Tests – Revisions B, C, D, E, F

SAC109 Condition	Normal Voltage Transients Rev B,C,D,E,F	Duration (s)
Over Voltage		
A	140Vrms, 60 msec, tf < 1.25 ms, tr < 1.25 ms	52
B	140Vrms, 60 msec, tf < 1.25 ms, tr = 25 ms	52
C	160Vrms, 34 msec, tf < 1.25 ms, tr < 1.25 ms	52
D	160Vrms, 34 msec, tf < 1.25 ms, tr = 25 ms	52
E	180Vrms, 10 msec, tf < 1.25 ms, tr < 1.25 ms	52
F	180Vrms, 10 msec, tf < 1.25 ms, tr = 77 ms	52
G	180Vrms, 3 x 10 msec, 0.5 apart, tf < 1.25 ms, tr < 1.25 ms	56
Under Voltage		
H	90Vrms, 35 msec, tf < 1.25 ms, tr < 1.25 ms	52
I	90Vrms, 35 msec, tf < 1.25 ms, tr = 45 ms	52
J	80Vrms, 10 msec, tf < 1.25 ms, tr < 1.25 ms	52
K	80Vrms, 10 msec, tf < 1.25 ms, tr = 70 ms	52
L	80Vrms, 3 x 10 msec, 0.5 sec apart, tf < 1.25 ms, tr < 1.25 ms	56
Combined Transient		
M	80Vrms, 10 msec, tf < 1.25 ms, tr < 1.25 ms	52
	180Vrms, 10 msec, tf < 1.25 ms, tr = 77 ms	

SAC 109 Tests – Revisions A

SAC109 Condition	Normal Voltage Transients Rev A	Duration (s)
Over Voltage		
A	135Vrms, 210 msec, tf < 1.25 ms, tr < 1.25 ms	52
B	135Vrms, 145 msec, tf < 1.25 ms, tr = 130 ms	52
C	145Vrms, 130 msec, tf < 1.25 ms, tr < 1.25 ms	52
D	145Vrms, 90 msec, tf < 1.25 ms, tr = 80 ms	52
E	160Vrms, 48 msec, tf < 1.25 ms, tr < 1.25 ms	52
F	160Vrms, 30 msec, tf < 1.25 ms, tr = 40 ms	52
G	160Vrms, 3 x 25 msec, 0.5 apart, tf < 1.25 ms, tr < 1.25 ms	56
Under Voltage		
H	90Vrms, 300 msec, tf < 1.25 ms, tr < 1.25 ms	52
I	90Vrms, 210 msec, tf < 1.25 ms, tr = 180 ms	52
J	70Vrms, 140 msec, tf < 1.25 ms, tr < 1.25 ms	52
K	70Vrms, 95 msec, tf < 1.25 ms, tr = 85 ms	52
L	58Vrms, 48 msec, tf < 1.25 ms, tr < 1.25 ms	56
M	58Vrms, 30 msec, tf < 1.25 ms, tr = 40 ms	56
N	58Vrms, 3 x 25 msec, 0.5 apart, tf < 1.25 ms, tr < 1.25 ms	56
Combined Transient		
O	58Vrms, 25 msec, tf < 1.25 ms, tr < 1.25 ms	52
	160Vrms, 25 msec, tf < 1.25 ms, tr = 50 ms	

SAC 110 Tests – Revisions B, C, D, E, F

SAC110 Condition	Normal Frequency Transients, Rev B, C, D, E, F	Duration (s)
Over Frequency		
A	410 Hz, 10 sec, tr = 40 msec, tf = 40 msec	100
B	420 Hz, 5 sec, tr = 80 msec, tf = 80 msec	80
C	425 Hz, 1 sec, tr = 100 msec, tf = 100 msec	60
D	425 Hz, 1 sec, tr = 100 msec, tf = 10 msec	100
	420 Hz, 4 sec, tr = 10 msec, tf = 20 msec	
	410 Hz, 5 sec, tr = 20 msec, tf = 40 msec	
Under Frequency		
E	390 Hz, 10 sec, tr = 40 msec, tf = 40 msec	100
F	380 Hz, 5 sec, tr = 80 msec, tf = 80 msec	80
G	375 Hz, 1 sec, tr = 100 msec, tf = 100 msec	60
H	375 Hz, 1 sec, tr = 100 msec, tf = 10 msec	100
	380 Hz, 4 sec, tr = 10 msec, tf = 20 msec	
	390 Hz, 5 sec, tr = 20 msec, tf = 40 msec	
Combined		
I	375 Hz, 1 sec, tr = 100 msec, tf = 100 msec	62
	425 Hz, 1 sec, tr = 100 msec, tf = 100 msec	

SAC 110 Tests – Revisions A

SAC110 Condition	Normal Frequency Transients, Rev A	Duration (s)
Over Frequency		
A	430 Hz, 0.5 cycle, tr = 120 msec, tf = 120 msec	100
B	430 Hz, 0.5 cycle, tr = 300 msec, tf = 1.2 sec	80
C	450 Hz, 0.5 cycle, tr = 200 msec, tf = 200 msec	60
D	450 Hz, 0.5 cycle, tr = 250 msec, tf = 3 sec	100
Under Frequency		
E	370 Hz, 0.5 cycle, tr = 120 msec, tf = 120 msec	100
F	370 Hz, 0.5 cycle, tr = 300 msec, tf = 1.2 sec/	80
G	350 Hz, 0.5 cycle, tr = 200 msec, tf = 200 msec	60
H	350 Hz, 0.5 cycle, tr = 250 msec, tf = 3 sec	100
Combined		
I	350 Hz, 0.5 cycle, tr = 200 msec, tf = 200 msec	62
	450 Hz, 0.5 cycle, tr = 200 msec, tf = 200 msec	

SAC 201 Tests – All Revisions

SAC201	Power Interrupt, Rev A, B, C, D, E, F	
Condition		Duration (s)
A	Vnom 115V, 50 msec	62
B	Vlow 108V, 50 msec	62
C	Vhigh 118V, 50 msec	62
D	Vnom 115V, 30 msec	62
E	Vlow 108V, 30 msec	62
F	Vhigh 118V, 30 msec	62
G	Vnom 115V, 10 msec	62
H	Vlow 108V, 10 msec	62
I	Vhigh 118V, 10 msec	62
J	Vnom 115V, 3 x 50 msec, 0.5 sec apart	62
K	Vnom 115V, 50 msec	62
	160Vrms, 30 msec, tr = 40 msec	
L	Vnom 115V, 50 msec	62
	70Vrms, 30 msec, tr = 40 msec	

SAC 301 Tests – Revisions C, E, F

SAC301	Abnormal SS Limits Volt and Freq Rev C, E, F	
Condition		Duration (s)
	Nominal Voltage	
A	Vnom 115V, Flow 380 Hz	1800
B	Vnom 115V, Fhigh 420 Hz	1800
	Low Voltage	
C	Vlow 100V, Fnom 400 Hz	1800
D	Vlow 100V, Flow 380 Hz	1800
E	Vlow 100V, Fhigh 420 Hz	1800
	High Voltage	
F	Vhigh 125V, Fnom 400 Hz	1800
G	Vhigh 125V, Flow 380 Hz	1800
H	Vhigh 125V, Fhigh 420 Hz	1800

SAC 301 Tests – Revisions B, D

SAC301	Abnormal SS Limits Volt and Freq Rev B, D	
Condition		Duration (s)
	Nominal Voltage	
A	Vnom 115V, Flow 375 Hz	1800
B	Vnom 115V, Fhigh 425 Hz	1800
	Low Voltage	
C	Vlow 100V, Fnom 400 Hz	1800
D	Vlow 100V, Flow 375 Hz	1800
E	Vlow 100V, Fhigh 425 Hz	1800
	High Voltage	
F	Vhigh 125V, Fnom 400 Hz	1800
G	Vhigh 125V, Flow 375 Hz	1800
H	Vhigh 125V, Fhigh 425 Hz	1800

SAC 301 Tests – Revisions A

SAC301	Abnormal SS Limits Volt and Freq Rev A	
Condition		Duration (s)
	Nominal Voltage	
A	Vnom 115V, Flow 370 Hz	1800
B	Vnom 115V, Fhigh 430 Hz	1800
	Low Voltage	
C	Vlow 102V, Fnom 400 Hz	1800
D	Vlow 102V, Flow 370 Hz	1800
E	Vlow 102V, Fhigh 430 Hz	1800
	High Voltage	
F	Vhigh 124V, Fnom 400 Hz	1800
G	Vhigh 124V, Flow 370 Hz	1800
H	Vhigh 124V, Fhigh 430 Hz	1800

SAC 302 Tests – Revisions B, C, D, E, F

SAC302	Abnormal Voltage Transients. Rev B, C, D, E, F	Duration (s)
Condition		
Over Voltage		
A	140Vrms, 180 msec, tf < 1.25 ms, tr < 1.25 ms	54
B	140Vrms, 180 msec, tf < 1.25 ms, tr = 87 ms then 135Vrms, ramp down, tr = 253 msec then 130Vrms, ramp down, tr = 6.41 sec then 125Vrms, ramp down, tr > 10 sec then 115Vrms.	135
C	160Vrms, 78 msec, tf < 1.25 ms, tr < 1.25 ms	54
D	160Vrms, 78 msec, tf < 1.25 ms, tr = 31 ms then 150Vrms, ramp down, tr = 71 msec then 140Vrms, ramp down, tr = 87 sec then 135Vrms, ramp down, tr > 253 sec. then 130Vrms, ramp down, tr = 6.41 sec then 125Vrms, ramp down, tr > 10 sec then 115Vrms.	135
E	180Vrms, 50 msec, tf < 1.25 ms, tr < 1.25 ms	54
F	180Vrms, 50 msec, tf < 1.25 ms, tr = 11 ms then 170Vrms, ramp down, tr = 17 msec then 160Vrms, ramp down, tr = 31 msec then 150Vrms, ramp down, tr = 71 msec then 140Vrms, ramp down, tr = 87 sec then 135Vrms, ramp down, tr > 253 sec. then 130Vrms, ramp down, tr = 6.41 sec then 125Vrms, ramp down, tr > 10 sec then 115Vrms.	135
G	180Vrms, 3 x 20 msec, 0.5 sec apart, tf < 1.25 ms, tr < 1.25 ms	54
Under Voltage		
H	85Vrms, 180 msec, tf < 1.25 ms, tr < 1.25 ms	54
I	85Vrms, 180 msec, tf < 1.25 ms, tr = 87 ms then 90Vrms, ramp up, tr = 253 msec then 95Vrms, ramp up, tr = 6.41 sec then 100Vrms, ramp up, tr > 10 sec then 115Vrms.	135
J	66Vrms, 78 msec, tf < 1.25 ms, tr < 1.25 ms	54
K	65Vrms, 78 msec, tf < 1.25 ms, tr = 31 ms then 75Vrms, ramp up, tr = 71 msec then 85Vrms, ramp up, tr = 87 msec then 90Vrms, ramp up, tr = 253 msec then 95Vrms, ramp up, tr = 6.41 sec then 100Vrms, ramp up, tr > 10 sec then 115Vrms.	135
L	45Vrms, 50 msec, tf < 1.25 ms, tr < 1.25 ms	54
M	45Vrms, 50 msec, tf < 1.25 ms, tr = 11 ms then 55Vrms, ramp up, tr = 17 msec then 65Vrms, ramp up, tr = 31 msec then 75Vrms, ramp up, tr = 71 msec then 85Vrms, ramp up, tr = 87 msec then 90Vrms, ramp up, tr = 253 msec then 95Vrms, ramp up, tr = 6.41 sec then 100Vrms, ramp up, tr > 10 sec then 115Vrms.	135
N	45Vrms, 3 x 20 msec, 0.5 sec apart, tf < 1.25 ms, tr < 1.25 ms	54
Combined Transient		
O	45Vrms, 20 msec, tf < 1.25 ms, tr < 1.25 ms 180Vrms, 50 msec, tf < 1.25 ms, tr = 11 ms then 170Vrms, ramp down, tr = 17 msec then 160Vrms, ramp down, tr = 31 msec then 150Vrms, ramp down, tr = 71 msec then 140Vrms, ramp down, tr = 87 sec then 135Vrms, ramp down, tr > 253 sec. then 130Vrms, ramp down, tr = 6.41 sec then 125Vrms, ramp down, tr > 10 sec then 115Vrms.	135

SAC 302 Tests – Revision A

SAC302	Abnormal Voltage Transients. Rev A	
Condition		Duration (s)
	Over Voltage	
A	140Vrms, 1450 msec, tf < 1.25 ms, tr < 1.25 ms	54
B	140Vrms, 1025 msec, tf < 1.25 ms, tr = 850 ms	135
C	160Vrms, 520 msec, tf < 1.25 ms, tr < 1.25 ms	54
D	160Vrms, 390 msec, tf < 1.25 ms, tr = 250 ms	135
E	180Vrms, 98 msec, tf < 1.25 ms, tr < 1.25 ms	54
F	180Vrms, 75 msec, tf < 1.25 ms, tr = 50 ms	135
G	180Vrms, 3 x 20 msec, 0.5 apart, tf < 1.25 ms, tr < 1.25 ms	54
	Under Voltage	
H	85Vrms, 1450 msec, tf < 1.25 ms, tr < 1.25 ms	54
I	85Vrms, 1025 msec, tf < 1.25 ms, tr = 850 ms	135
J	75Vrms, 520 msec, tf < 1.25 ms, tr < 1.25 ms	54
K	75Vrms, 390 msec, tf < 1.25 ms, tr = 250 ms	135
L	45Vrms, 98 msec, tf < 1.25 ms, tr < 1.25 ms	54
M	45Vrms, 75 msec, tf < 1.25 ms, tr = 50 ms	135
N	45Vrms, 3 x 20 msec, 0.5 apart, tf < 1.25 ms, tr < 1.25 ms	54
	Combined Transient	
O	45Vrms, 20 msec, tf < 1.25 ms, tr < 1.25 ms	135
	180Vrms, 75 msec, tf < 1.25 ms, tr = 50 ms	

SAC 303 Tests – Revisions B, C, D, E, F

SAC303	Abnormal Frequency Transients. Rev B, C, D, E, F	Duration (s)
Condition		
	Over Frequency	
A	480 Hz, 0.5 cycle, tr = 160 msec, tf = 160 msec	55
B	480 Hz, 4.78 sec, tr = 160 msec, tf = 160 msec	76
	Under Frequency	
C	320 Hz, 0.5 cycle, tr = 160 msec, tf = 160 msec	55
D	320 Hz, 4.78 sec, tr = 160 msec, tf = 160 msec	76
	Combined	
E	320 Hz, 0.5 cycle, tr = 160 msec, tf = 160 msec	56
	480 Hz, 0.5 cycle, tr = 160 msec, tf = 160 msec	

SAC 303 Tests – Revision A

SAC303	Abnormal Frequency Transients. Rev A	Duration (s)
Condition		
	Over Frequency	
A	480 Hz, 0.5 cycle, tr = 333 msec, tf = 60 msec	55
B	480 Hz, 6.69 sec, tr = 333 msec, tf = 60 msec	76
	Under Frequency	
C	320 Hz, 0.5 cycle, tr = 333 msec, tf = 60 msec	55
D	320 Hz, 6.69 sec, tr = 333 msec, tf = 60 msec	76
	Combined	
E	320 Hz, 0.5 cycle, tr = 333 msec, tf = 333 msec	56
	480 Hz, 0.5 cycle, tr = 333 msec, tf = 333 msec	

SAC 401 Tests – Revision E, F

SAC401	Emergency SS Limits Volt and Freq. Rev E, F	Duration (s)
Condition		
	Nominal Voltage	
A	Vnom 115V, Flow 393 Hz	1800
B	Vnom 115V, Fhigh 407 Hz	1800
	Low Voltage	
C	Vlow 108V, Fnom 400 Hz	1800
D	Vlow 108V, Flow 393 Hz	1800
E	Vlow 108V, Fhigh 407 Hz	1800
	High Voltage	
F	Vhigh 118V, Fnom 400 Hz	1800
G	Vhigh 118V, Flow 393 Hz	1800
H	Vhigh 118V, Fhigh 407 Hz	1800

SAC 401 Tests – Revision B, D

SAC401	Emergency SS Limits Volt and Freq. Rev B, D	Duration (s)
Condition		
	Nominal Voltage	
A	Vnom 115V, Flow 360 Hz	1800
B	Vnom 115V, Fhigh 440 Hz	1800
	Low Voltage	
C	Vlow 102V, Fnom 400 Hz	1800
D	Vlow 102V, Flow 360 Hz	1800
E	Vlow 102V, Fhigh 440 Hz	1800
	High Voltage	
F	Vhigh 124V, Fnom 400 Hz	1800
G	Vhigh 124V, Flow 360 Hz	1800
H	Vhigh 124V, Fhigh 440 Hz	1800

SAC 401 Tests – Revision A, C

SAC401	Emergency SS Limits Volt and Freq. Rev A, C	Duration (s)
Condition		
	Nominal Voltage	
A	Vnom 115V, Flow 360 Hz	1800
B	Vnom 115V, Fhigh 440 Hz	1800
	Low Voltage	
C	Vlow 104V, Fnom 400 Hz	1800
D	Vlow 104V, Flow 360 Hz	1800
E	Vlow 104V, Fhigh 440 Hz	1800
	High Voltage	
F	Vhigh 122V, Fnom 400 Hz	1800
G	Vhigh 122V, Flow 360 Hz	1800
H	Vhigh 122V, Fhigh 440 Hz	1800

SAC 501 Tests

Starting operations are not applicable to AC Utilization Equipment.

SAC 601 Tests – Revision F only.

SAC601	Power Failure - One Phase	
Condition		Duration (s)
A	100 msec	52
B	500 msec	54
C	3 sec	66
D	7 sec	86

SAC 602 Tests – Revision F only.

Not applicable for single-phase EUT's.

SAC 603 Tests – Revision F only.

SAC603	Power Failure – Phase Reversal	
Condition		Duration (s)
N/A	Use physical L-N connection reversal Apply Vnom = 115 V, Fnom = 400 Hz	1800

10.7.2 TAC Group Tests

Three phase 400 Hz AC tests

TAC 102 Tests - Revisions A, B, C, D, E, F

TAC102	Steady State Voltage and Frequency - Rev A through F	Duration (s)
Condition		
	Balanced Voltage	
	Nominal Voltage	
A	Vnom=115V, Fnom=400 Hz - Nominal	1800
B	Vnom=115V, Flow=393 Hz - Nominal	1800
C	Vnom=115V, Fhigh=407 Hz - Nominal	1800
	Low Voltage	
D	Vlow =108V, Fnom=400 Hz - Low	1800
E	Vlow=108V, Flow= 393 Hz- Low	1800
F	Vlow=108V, Fhigh=407 Hz - Low	1800
	High Voltage	
G	Vhigh=118V, Fnom=400 Hz - High	1800
H	Vhigh=118V, Flow=393 Hz- High	1800
I	Vhigh=118V, Fhigh=407 Hz - High	1800
	Unbalanced Voltage	
J	Va, Vb+3V, Vc+3V, Fnom	1800
K	Va, Vb-3V, Vc-3V, Fnom	1800

TAC 103 Tests - Revisions A, B, C, D, E, F

TAC103	Voltage Phase Difference - Rev A through F	Duration (s)
Condition		
A	A = 0, B = 116, C = 240	1800
B	A = 0, B = 124, C = 240	1800

TAC 104 Tests - Revisions B, C, D, E, F

TAC104	Voltage Modulation - Rev B through F	Duration (s)
Condition		
A	Vmod F = 1.0 Hz, V = 0.375 Vrms	1800
B	Vmod F = 1.7 Hz, V = 0.375 Vrms	1800
C	Vmod F = 10 Hz, V = 2.5 Vrms	1800
D	Vmod F = 25 Hz, V = 2.5 Vrms	1800
E	Vmod F = 70 Hz, V = 0.375 Vrms	1800
F	Vmod F = 100 Hz, V = 0.375 Vrms	1800
G	Vmod F = 200 Hz, V = 0.375 Vrms	1800

TAC 104 Tests – Revision A

TAC104	Voltage Modulation - Rev A	Duration (s)
Condition		
A	Vmod F = 1.0 Hz, V = 0.5 Vpp	1800
B	Vmod F = 1.7 Hz, V = 0.5 Vpp	1800
C	Vmod F = 10 Hz, V = 3.5 Vpp	1800
D	Vmod F = 25 Hz, V = 3.5 Vpp	1800
E	Vmod F = 70 Hz, V = 0.5 Vpp	1800
F	Vmod F = 100 Hz, V = 0.5 Vpp	1800
G	Vmod F = 200 Hz, V = 0.5 Vpp	1800

TAC 105 Tests – Revision E, F

TAC105 Condition	Frequency Modulation Rev E, F	Duration (s)
A	Fmod F = 1 Hz/sec, Fmod Amp = 4 Hz± 2 Hz	1800
B	Fmod F = 5 Hz/sec, Fmod Amp = 4 Hz± 2 Hz	1800
C	Fmod F = 10 Hz/sec, Fmod Amp = 4 Hz± 2 Hz	1800
D	Fmod F = 25 Hz/sec, Fmod Amp = 4 Hz± 2 Hz	1800
E	Fmod F = 100 Hz/sec, Fmod Amp = 4 Hz± 2 Hz	1800

TAC 105 Tests – Revision B, C, D

TAC105 Condition	Frequency Modulation Rev B, C, D	Duration (s)
A	Fmod F = 1 Hz/sec, Fmod Amp = ±5 Hz	1800
B	Fmod F = 5 Hz/sec, Fmod Amp = ±1.75 Hz	1800
C	Fmod F = 10 Hz/sec, Fmod Amp = ±1.20 Hz	1800
D	Fmod F = 25 Hz/sec, Fmod Amp = ±0.85 Hz	1800
E	Fmod F = 100 Hz/sec, Fmod Amp = ±0.58 Hz	1800

TAC 105 Tests – Revision A

TAC105 Condition	Frequency Modulation Rev A	Duration (s)
A	Fmod F = 1 Hz/sec, Fmod Amp = ±4 Hz	1800
B	Fmod F = 5 Hz/sec, Fmod Amp = ±4 Hz	1800
C	Fmod F = 10 Hz/sec, Fmod Amp = ±4 Hz	1800
D	Fmod F = 25 Hz/sec, Fmod Amp = ±4 Hz	1800

TAC 106 Tests

Voltage distortion spectrum test require the use of additional external equipment. In particular, a high bandwidth (100Khz) AC source, a high frequency coupling transformer and coupling network as shown in figure TAC106-1 of the Mil-Std 704 standard. For this test, the Lx/Ls Series AC source can be programmed to a steady state condition of 400 Hz and Vnominal of 115 Vrms or 230 Vrms.

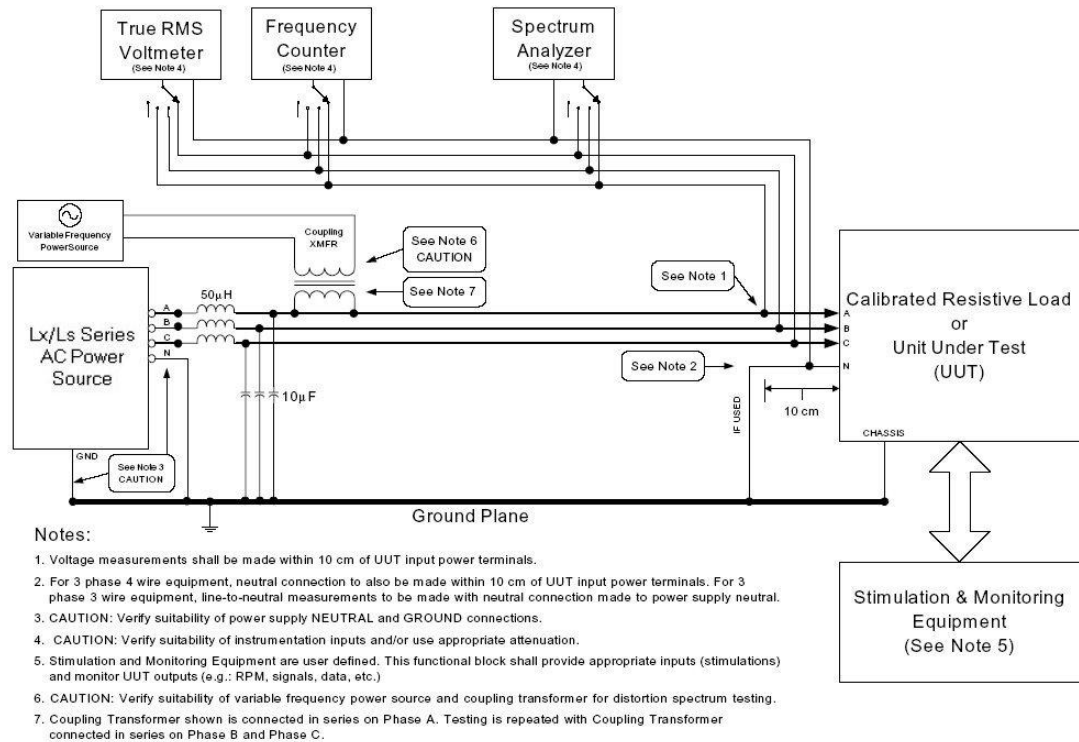

Figure 10-9: Required TAC-106 Test Setup.

TAC 107 Tests – Revisions B, C, D, E, F

TAC107	Total Voltage Distortion Rev B,C,D,E,F	Duration (s)
Condition		
A	0.05 % VTHD	1800
	F = 100%	
	H3 = 2.75%	
	H5 = 2.75%	
	H7 = 1.97%	
	H9 = 1.53%	
	H11 = 1.25%	
	H13 = 1.06%	
H15 = 0.92%		

TAC 107 Tests – Revisions A

TAC107	Total Voltage Distortion Rev A	Duration (s)
Condition		
A	0.08 % VTHD	1800
	F = 100%	
	H3 = 5.00%	
	H5 = 4.12%	
	H7 = 2.94%	
	H9 = 2.29%	
	H11 = 1.87%	
	H13 = 1.06%	
H15 = 1.37%		

TAC 108 Tests

TAC108 are DC offset tests and are not supported by the Lx/Ls Series AC Power sources. Contact California Instruments for DC Supply information. (sales@calinst.com)

TAC 109 Tests – Revisions B, C, D, E, F

TAC109 Condition	Normal Voltage Transients Rev B,C,D,E,F	Duration (s)
Over Voltage		
A	140Vrms, 60 msec, tf < 1.25 ms, tr < 1.25 ms	52
B	140Vrms, 60 msec, tf < 1.25 ms, tr = 25 ms	52
C	160Vrms, 34 msec, tf < 1.25 ms, tr < 1.25 ms	52
D	160Vrms, 34 msec, tf < 1.25 ms, tr = 25 ms	52
E	180Vrms, 10 msec, tf < 1.25 ms, tr < 1.25 ms	52
F	180Vrms, 10 msec, tf < 1.25 ms, tr = 77 ms	52
G	180Vrms, 3 x 10 msec, 0.5 apart, tf < 1.25 ms, tr < 1.25 ms	56
Under Voltage		
H	90Vrms, 35 msec, tf < 1.25 ms, tr < 1.25 ms	52
I	90Vrms, 35 msec, tf < 1.25 ms, tr = 45 ms	52
J	80Vrms, 10 msec, tf < 1.25 ms, tr < 1.25 ms	52
K	80Vrms, 10 msec, tf < 1.25 ms, tr = 70 ms	52
L	80Vrms, 3 x 10 msec, 0.5 sec apart, tf < 1.25 ms, tr < 1.25 ms	56
Combined Transient		
M	80Vrms, 10 msec, tf < 1.25 ms, tr < 1.25 ms	52
	180Vrms, 10 msec, tf < 1.25 ms, tr = 77 ms	

TAC 109 Tests – Revisions A

TAC109 Condition	Normal Voltage Transients Rev A	Duration (s)
Over Voltage		
A	135Vrms, 210 msec, tf < 1.25 ms, tr < 1.25 ms	52
B	135Vrms, 145 msec, tf < 1.25 ms, tr = 130 ms	52
C	145Vrms, 130 msec, tf < 1.25 ms, tr < 1.25 ms	52
D	145Vrms, 90 msec, tf < 1.25 ms, tr = 80 ms	52
E	160Vrms, 48 msec, tf < 1.25 ms, tr < 1.25 ms	52
F	160Vrms, 30 msec, tf < 1.25 ms, tr = 40 ms	52
G	160Vrms, 3 x 25 msec, 0.5 apart, tf < 1.25 ms, tr < 1.25 ms	56
Under Voltage		
H	90Vrms, 300 msec, tf < 1.25 ms, tr < 1.25 ms	52
I	90Vrms, 210 msec, tf < 1.25 ms, tr = 180 ms	52
J	70Vrms, 140 msec, tf < 1.25 ms, tr < 1.25 ms	52
K	70Vrms, 95 msec, tf < 1.25 ms, tr = 85 ms	52
L	58Vrms, 48 msec, tf < 1.25 ms, tr < 1.25 ms	56
M	58Vrms, 30 msec, tf < 1.25 ms, tr = 40 ms	56
N	58Vrms, 3 x 25 msec, 0.5 apart, tf < 1.25 ms, tr < 1.25 ms	56
Combined Transient		
O	58Vrms, 25 msec, tf < 1.25 ms, tr < 1.25 ms	52
	160Vrms, 25 msec, tf < 1.25 ms, tr = 50 ms	

TAC 110 Tests – Revisions B, C, D, E, F

TAC110 Condition	Normal Frequency Transients, Rev B, C, D, E, F	Duration (s)
	Over Frequency	
A	410 Hz, 10 sec, tr = 40 msec, tf = 40 msec	100
B	420 Hz, 5 sec, tr = 80 msec, tf = 80 msec	80
C	425 Hz, 1 sec, tr = 100 msec, tf = 100 msec	60
D	425 Hz, 1 sec, tr = 100 msec, tf = 10 msec	100
	420 Hz, 4 sec, tr = 10 msec, tf = 20 msec	
	410 Hz, 5 sec, tr = 20 msec, tf = 40 msec	
	Under Frequency	
E	390 Hz, 10 sec, tr = 40 msec, tf = 40 msec	100
F	380 Hz, 5 sec, tr = 80 msec, tf = 80 msec	80
G	375 Hz, 1 sec, tr = 100 msec, tf = 100 msec	60
H	375 Hz, 1 sec, tr = 100 msec, tf = 10 msec	100
	380 Hz, 4 sec, tr = 10 msec, tf = 20 msec	
	390 Hz, 5 sec, tr = 20 msec, tf = 40 msec	
	Combined	
I	375 Hz, 1 sec, tr = 100 msec, tf = 100 msec	62
	425 Hz, 1 sec, tr = 100 msec, tf = 100 msec	

TAC 110 Tests – Revisions A

TAC110 Condition	Normal Frequency Transients, Rev A	Duration (s)
	Over Frequency	
A	430 Hz, 0.5 cycle, tr = 120 msec, tf = 120 msec	100
B	430 Hz, 0.5 cycle, tr = 300 msec, tf = 1.2 sec	80
C	450 Hz, 0.5 cycle, tr = 200 msec, tf = 200 msec	60
D	450 Hz, 0.5 cycle, tr = 250 msec, tf = 3 sec	100
	Under Frequency	
E	370 Hz, 0.5 cycle, tr = 120 msec, tf = 120 msec	100
F	370 Hz, 0.5 cycle, tr = 300 msec, tf = 1.2 sec/	80
G	350 Hz, 0.5 cycle, tr = 200 msec, tf = 200 msec	60
H	350 Hz, 0.5 cycle, tr = 250 msec, tf = 3 sec	100
	Combined	
I	350 Hz, 0.5 cycle, tr = 200 msec, tf = 200 msec	62
	450 Hz, 0.5 cycle, tr = 200 msec, tf = 200 msec	

TAC 201 Tests – All Revisions

TAC201	Power Interrupt, Rev A, B, C, D, E, F	
Condition		Duration (s)
A	Vnom 115V, 50 msec	62
B	Vlow 108V, 50 msec	62
C	Vhigh 118V, 50 msec	62
D	Vnom 115V, 30 msec	62
E	Vlow 108V, 30 msec	62
F	Vhigh 118V, 30 msec	62
G	Vnom 115V, 10 msec	62
H	Vlow 108V, 10 msec	62
I	Vhigh 118V, 10 msec	62
J	Vnom 115V, 3 x 50 msec, 0.5 sec apart	62
K	Vnom 115V, 50 msec	62
	160Vrms, 30 msec, tr = 40 msec	
L	Vnom 115V, 50 msec	62
	70Vrms, 30 msec, tr = 40 msec	

TAC 301 Tests – Revisions C, E, F

TAC301 Condition	Abnormal SS Limits Volt and Freq Rev C, E, F	Duration (s)
	Nominal Voltage	
A	Vnom 115V, Flow 380 Hz	1800
B	Vnom 115V, Fhigh 420 Hz	1800
	Low Voltage	
C	Vlow 100V, Fnom 400 Hz	1800
D	Vlow 100V, Flow 380 Hz	1800
E	Vlow 100V, Fhigh 420 Hz	1800
	High Voltage	
F	Vhigh 125V, Fnom 400 Hz	1800
G	Vhigh 125V, Flow 380 Hz	1800
H	Vhigh 125V, Fhigh 420 Hz	1800

TAC 301 Tests – Revisions B, D

TAC301 Condition	Abnormal SS Limits Volt and Freq Rev B, D	Duration (s)
	Nominal Voltage	
A	Vnom 115V, Flow 375 Hz	1800
B	Vnom 115V, Fhigh 425 Hz	1800
	Low Voltage	
C	Vlow 100V, Fnom 400 Hz	1800
D	Vlow 100V, Flow 375 Hz	1800
E	Vlow 100V, Fhigh 425 Hz	1800
	High Voltage	
F	Vhigh 125V, Fnom 400 Hz	1800
G	Vhigh 125V, Flow 375 Hz	1800
H	Vhigh 125V, Fhigh 425 Hz	1800

TAC 301 Tests – Revisions A

TAC301 Condition	Abnormal SS Limits Volt and Freq Rev A	Duration (s)
	Nominal Voltage	
A	Vnom 115V, Flow 370 Hz	1800
B	Vnom 115V, Fhigh 430 Hz	1800
	Low Voltage	
C	Vlow 102V, Fnom 400 Hz	1800
D	Vlow 102V, Flow 370 Hz	1800
E	Vlow 102V, Fhigh 430 Hz	1800
	High Voltage	
F	Vhigh 124V, Fnom 400 Hz	1800
G	Vhigh 124V, Flow 370 Hz	1800
H	Vhigh 124V, Fhigh 430 Hz	1800

TAC 302 Tests – Revisions B, C, D, E, F

TAC302	Abnormal Voltage Transients. Rev B, C, D, E, F	Duration (s)
Condition		
Over Voltage		
A	140Vrms, 180 msec, tf < 1.25 ms, tr < 1.25 ms	54
B	140Vrms, 180 msec, tf < 1.25 ms, tr = 87 ms then 135Vrms, ramp down, tr = 253 msec then 130Vrms, ramp down, tr = 6.41 sec then 125Vrms, ramp down, tr > 10 sec then 115Vrms.	135
C	160Vrms, 78 msec, tf < 1.25 ms, tr < 1.25 ms	54
D	160Vrms, 78 msec, tf < 1.25 ms, tr = 31 ms then 150Vrms, ramp down, tr = 71 msec then 140Vrms, ramp down, tr = 87 sec then 135Vrms, ramp down, tr > 253 sec. then 130Vrms, ramp down, tr = 6.41 sec then 125Vrms, ramp down, tr > 10 sec then 115Vrms.	135
E	180Vrms, 50 msec, tf < 1.25 ms, tr < 1.25 ms	54
F	180Vrms, 50 msec, tf < 1.25 ms, tr = 11 ms then 170Vrms, ramp down, tr = 17 msec then 160Vrms, ramp down, tr = 31 msec then 150Vrms, ramp down, tr = 71 msec then 140Vrms, ramp down, tr = 87 sec then 135Vrms, ramp down, tr > 253 sec. then 130Vrms, ramp down, tr = 6.41 sec then 125Vrms, ramp down, tr > 10 sec then 115Vrms.	135
G	180Vrms, 3 x 20 msec, 0.5 apart, tf < 1.25 ms, tr < 1.25 ms	54
Under Voltage		
H	85Vrms, 180 msec, tf < 1.25 ms, tr < 1.25 ms	54
I	85Vrms, 180 msec, tf < 1.25 ms, tr = 87 ms then 90Vrms, ramp up, tr = 253 msec then 95Vrms, ramp up, tr = 6.41 sec then 100Vrms, ramp up, tr > 10 sec then 115Vrms.	135
J	66Vrms, 78 msec, tf < 1.25 ms, tr < 1.25 ms	54
K	65Vrms, 78 msec, tf < 1.25 ms, tr = 31 ms then 75Vrms, ramp up, tr = 71 msec then 85Vrms, ramp up, tr = 87 msec then 90Vrms, ramp up, tr = 253 msec then 95Vrms, ramp up, tr = 6.41 sec then 100Vrms, ramp up, tr > 10 sec then 115Vrms.	135
L	45Vrms, 50 msec, tf < 1.25 ms, tr < 1.25 ms	54
M	45Vrms, 50 msec, tf < 1.25 ms, tr = 11 ms then 55Vrms, ramp up, tr = 17 msec then 65Vrms, ramp up, tr = 31 msec then 75Vrms, ramp up, tr = 71 msec then 85Vrms, ramp up, tr = 87 msec then 90Vrms, ramp up, tr = 253 msec then 95Vrms, ramp up, tr = 6.41 sec then 100Vrms, ramp up, tr > 10 sec then 115Vrms.	135
N	45Vrms, 3 x 20 msec, 0.5 apart, tf < 1.25 ms, tr < 1.25 ms	54
Combined Transient		
O	45Vrms, 20 msec, tf < 1.25 ms, tr < 1.25 ms 180Vrms, 50 msec, tf < 1.25 ms, tr = 11 ms then 170Vrms, ramp down, tr = 17 msec then 160Vrms, ramp down, tr = 31 msec then 150Vrms, ramp down, tr = 71 msec then 140Vrms, ramp down, tr = 87 sec then 135Vrms, ramp down, tr > 253 sec. then 130Vrms, ramp down, tr = 6.41 sec then 125Vrms, ramp down, tr > 10 sec then 115Vrms.	135

TAC 302 Tests – Revision A

TAC302	Abnormal Voltage Transients. Rev A	
Condition		Duration (s)
	Over Voltage	
A	140Vrms, 1450 msec, tf < 1.25 ms, tr < 1.25 ms	54
B	140Vrms, 1025 msec, tf < 1.25 ms, tr = 850 ms	135
C	160Vrms, 520 msec, tf < 1.25 ms, tr < 1.25 ms	54
D	160Vrms, 390 msec, tf < 1.25 ms, tr = 250 ms	135
E	180Vrms, 98 msec, tf < 1.25 ms, tr < 1.25 ms	54
F	180Vrms, 75 msec, tf < 1.25 ms, tr = 50 ms	135
G	180Vrms, 3 x 20 msec, 0.5 apart, tf < 1.25 ms, tr < 1.25 ms	54
	Under Voltage	
H	85Vrms, 1450 msec, tf < 1.25 ms, tr < 1.25 ms	54
I	85Vrms, 1025 msec, tf < 1.25 ms, tr = 850 ms	135
J	75Vrms, 520 msec, tf < 1.25 ms, tr < 1.25 ms	54
K	75Vrms, 390 msec, tf < 1.25 ms, tr = 250 ms	135
L	45Vrms, 98 msec, tf < 1.25 ms, tr < 1.25 ms	54
M	45Vrms, 75 msec, tf < 1.25 ms, tr = 50 ms	135
N	45Vrms, 3 x 20 msec, 0.5 apart, tf < 1.25 ms, tr < 1.25 ms	54
	Combined Transient	
O	45Vrms, 20 msec, tf < 1.25 ms, tr < 1.25 ms	135
	180Vrms, 75 msec, tf < 1.25 ms, tr = 50 ms	

TAC 303 Tests – Revisions B, C, D, E, F

TAC303	Abnormal Frequency Transients. Rev B, C, D, E, F	
Condition		Duration (s)
	Over Frequency	
A	480 Hz, 0.5 cycle, tr = 160 msec, tf = 160 msec	55
B	480 Hz, 4.78 sec, tr = 160 msec, tf = 160 msec	76
	Under Frequency	
C	320 Hz, 0.5 cycle, tr = 160 msec, tf = 160 msec	55
D	320 Hz, 4.78 sec, tr = 160 msec, tf = 160 msec	76
	Combined	
E	320 Hz, 0.5 cycle, tr = 160 msec, tf = 160 msec	56
	480 Hz, 0.5 cycle, tr = 160 msec, tf = 160 msec	

TAC 303 Tests – Revision A

TAC303	Abnormal Frequency Transients. Rev A	
Condition		Duration (s)
	Over Frequency	
A	480 Hz, 0.5 cycle, tr = 333 msec, tf = 60 msec	55
B	480 Hz, 6.69 sec, tr = 333 msec, tf = 60 msec	76
	Under Frequency	
C	320 Hz, 0.5 cycle, tr = 333 msec, tf = 60 msec	55
D	320 Hz, 6.69 sec, tr = 333 msec, tf = 60 msec	76
	Combined	
E	320 Hz, 0.5 cycle, tr = 333 msec, tf = 333 msec	56
	480 Hz, 0.5 cycle, tr = 333 msec, tf = 333 msec	

TAC 401 Tests – Revision E, F

TAC401 Condition	Emergency SS Limits Volt and Freq. Rev E, F	Duration (s)
	Nominal Voltage	
A	Vnom 115V, Flow 393 Hz	1800
B	Vnom 115V, Fhigh 407 Hz	1800
	Low Voltage	
C	Vlow 108V, Fnom 400 Hz	1800
D	Vlow 108V, Flow 393 Hz	1800
E	Vlow 108V, Fhigh 407 Hz	1800
	High Voltage	
F	Vhigh 118V, Fnom 400 Hz	1800
G	Vhigh 118V, Flow 393 Hz	1800
H	Vhigh 118V, Fhigh 407 Hz	1800

TAC 401 Tests – Revision B, D

TAC401 Condition	Emergency SS Limits Volt and Freq. Rev B, D	Duration (s)
	Nominal Voltage	
A	Vnom 115V, Flow 360 Hz	1800
B	Vnom 115V, Fhigh 440 Hz	1800
	Low Voltage	
C	Vlow 102V, Fnom 400 Hz	1800
D	Vlow 102V, Flow 360 Hz	1800
E	Vlow 102V, Fhigh 440 Hz	1800
	High Voltage	
F	Vhigh 124V, Fnom 400 Hz	1800
G	Vhigh 124V, Flow 360 Hz	1800
H	Vhigh 124V, Fhigh 440 Hz	1800

TAC 401 Tests – Revision A, C

TAC401 Condition	Emergency SS Limits Volt and Freq. Rev A, C	Duration (s)
	Nominal Voltage	
A	Vnom 115V, Flow 360 Hz	1800
B	Vnom 115V, Fhigh 440 Hz	1800
	Low Voltage	
C	Vlow 104V, Fnom 400 Hz	1800
D	Vlow 104V, Flow 360 Hz	1800
E	Vlow 104V, Fhigh 440 Hz	1800
	High Voltage	
F	Vhigh 122V, Fnom 400 Hz	1800
G	Vhigh 122V, Flow 360 Hz	1800
H	Vhigh 122V, Fhigh 440 Hz	1800

TAC 501 Tests

Starting operations are not applicable to AC Utilization Equipment.

TAC 601 Tests – Revision F only.

TAC601	Power Failure - One Phase	
Condition		Duration (s)
A	100 msec	52
B	500 msec	54
C	3 sec	66
D	7 sec	86

TAC 602 Tests – Revision F only.

TAC601	Power Failure – One, Two Phase	
Condition		Duration (s)
	One Phase	
A	Phase A, 7 sec - 5x	86
B	Phase B, 7 sec - 5x	86
C	Phase C, 7 sec - 5x	86
D	Phase A, 30 min - 1x	1800
E	Phase B, 30 min - 1x	1800
F	Phase C, 30 min - 1x	1800
	Two Phase	
G	Phase A&B, 7 sec - 5x	86
H	Phase B&C, 7 sec - 5x	86
I	Phase A&B, 30 min - 1x	1800
J	Phase B&C, 30 min - 1x	1800

TAC 603 Tests – Revision F.

TAC603	Power Failure – Phase Reversal	
Condition		Duration (s)
A	Phase rotation C-B-A	1800
	Phase rotation A-B-C	1800

10.7.3 SVF Group Tests

Three phase variable frequency AC tests.

Note: *Variable frequency test are part of revision F only. There are no equivalent tests in revision A through E.*

SVF 102 Tests – Revision F

SVF102	Steady State Voltage and Frequency - Rev F	Duration (s)
Condition		
Balanced Nominal Voltage		
A	Vnom, 360 Hz	1800
B	Vnom, 400 Hz	1800
C	Vnom, 600 Hz	1800
D	Mlow, 800 Hz	1800
Balanced Low Voltage		
E	108V, 360 Hz	1800
F	108V, 400 Hz	1800
G	108V, 440 Hz	300
H	108V, 480 Hz	300
I	108V, 520 Hz	300
J	108V, 560 Hz	300
K	108V, 600 Hz	1800
L	108V, 520 Hz	300
M	108V, 540 Hz	300
N	108V, 560 Hz	300
O	108V, 570 Hz	300
P	108V, 580 Hz	300
Q	108V, 600 Hz	1800
R	108V, 640 Hz	300
S	108V, 680 Hz	300
T	108V, 720 Hz	300
U	108V, 760 Hz	300
V	108V, 800 Hz	1800
Balanced High Voltage		
W	118V, 360 Hz	1800
X	118V, 400 Hz	1800
Y	118V, 440 Hz	300
Z	118V, 480 Hz	300
AA	118V, 520 Hz	300
BB	118V, 560 Hz	300
CC	118V, 600 Hz	1800
DD	118V, 520 Hz	300
EE	118V, 540 Hz	300
FF	118V, 560 Hz	300
GG	118V, 570 Hz	300
HH	118V, 580 Hz	300
II	118V, 600 Hz	1800
JJ	118V, 640 Hz	300
KK	118V, 680 Hz	300
LL	118V, 720 Hz	300
MM	118V, 760 Hz	300
NN	118V, 800 Hz	1800

SVF 103 Tests

Voltage Phase Difference tests do not apply for single-phase EUT's.

SVF 104 Tests - Revision F

SVF104	Voltage Modulation Rev F	
Condition		Duration (s)
	Run at 400, Repeat at 360, 600 and 800 Hz	
A	Vmod F = 1.0 Hz, V = 0.375 Vrms	1800
B	Vmod F = 1.7 Hz, V = 0.375 Vrms	1800
C	Vmod F = 10 Hz, V = 2.5 Vrms	1800
D	Vmod F = 25 Hz, V = 2.5 Vrms	1800
E	Vmod F = 70 Hz, V = 0.375 Vrms	1800
F	Vmod F = 100 Hz, V = 0.375 Vrms	1800
G	Vmod F = 200 Hz, V = 0.375 Vrms	1800

SVF 105 Tests – Revision F

SVF105	Frequency Modulation Rev F	
Condition		Duration (s)
	Run at 400, Repeat at 362, 600 and 798 Hz	
A	Fmod F = 1 Hz/sec, Fmod Amp = 4 Hz± 2 Hz	1800
B	Fmod F = 5 Hz/sec, Fmod Amp = 4 Hz± 2 Hz	1800
C	Fmod F = 10 Hz/sec, Fmod Amp = 4 Hz± 2 Hz	1800
D	Fmod F = 25 Hz/sec, Fmod Amp = 4 Hz± 2 Hz	1800
E	Fmod F = 100 Hz/sec, Fmod Amp = 4 Hz± 2 Hz	1800

SVF 106 Tests

Voltage distortion spectrum test require the use of additional external equipment. In particular, a high bandwidth (100Khz) AC source, a high frequency coupling transformer and coupling network as shown in figure SVF106-1 of the Mil-Std 704 standard. For this test, the Lx/Ls Series AC source can be programmed to a steady state condition of 360, 400, 600 and 800 Hz and Vnominal of 115 Vrms or 230 Vrms.

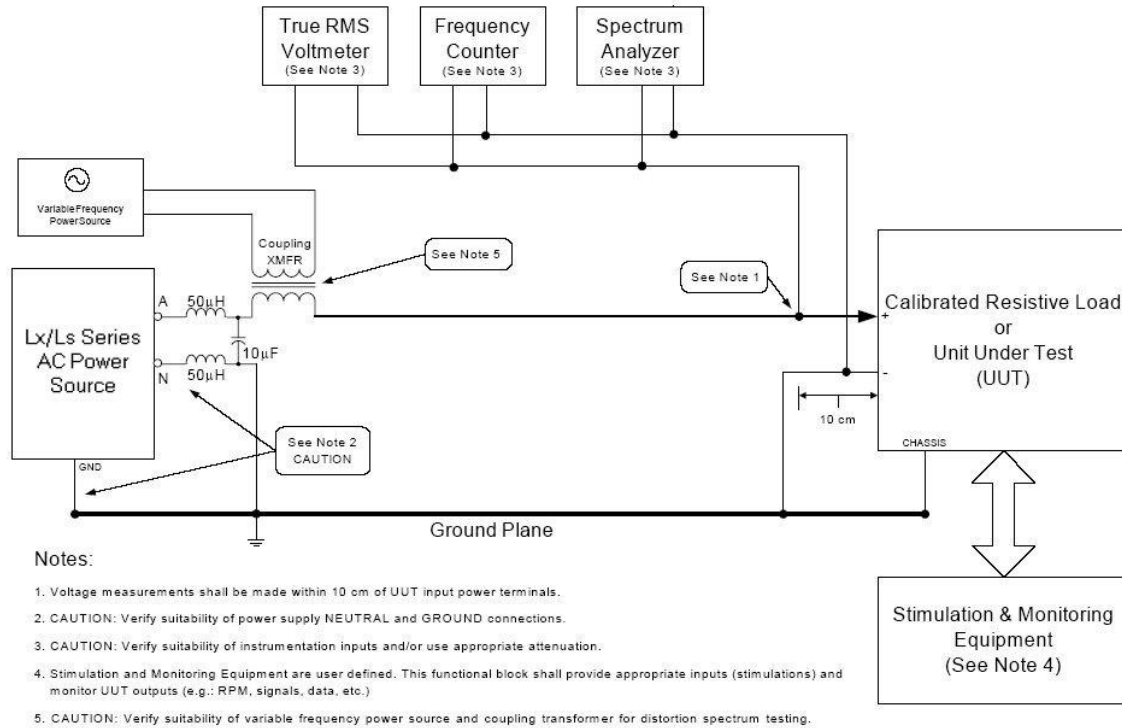

Figure 10-10: Required SVF-106 Test Setup.

SVF 107 Tests – Revision F

SVF107 Condition	Total Voltage Distortion Rev F	Duration (s)
	Run at 400, Repeat at 360, 600 and 800 Hz	
A	0.05 % VTHD	1800
	F = 100%	
	H3 = 2.75%	
	H5 = 2.75%	
	H7 = 1.97%	
	H9 = 1.53%	
	H11 = 1.25%	
	H13 = 1.06%	
	H15 = 0.92%	

SVF 108 Tests

SVF108 are DC offset tests and are not supported by the Lx/Ls Series AC Power sources. Contact California Instruments for DC Supply information. (sales@calinst.com)

SVF 109 Tests – Revision F

SVF109 Condition	Normal Voltage Transients Rev F	Duration (s)
	Run at 400, Repeat at 360, 600 and 800 Hz	
	Over Voltage	
A	140Vrms, 60 msec, tf < 0.5 cyc, tr < 0.5 cyc	52
B	140Vrms, 60 msec, tf < 0.5 cyc, tr = 25 ms	52
C	160Vrms, 34 msec, tf < 0.5 cyc, tr < 0.5 cyc	52
D	160Vrms, 34 msec, tf < 0.5 cyc, tr = 25 ms	52
E	180Vrms, 10 msec, tf < 0.5 cyc, tr < 0.5 cyc	52
F	180Vrms, 10 msec, tf < 0.5 cyc, tr = 77 ms	52
G	180Vrms, 3 x 10 msec, 0.5 sec apart, tf < 0.5 cyc, tr < 0.5 cyc	56
	Under Voltage	
H	90Vrms, 35 msec, tf < 0.5 cyc, tr < 0.5 cyc	52
I	90Vrms, 35 msec, tf < 0.5 cyc, tr = 45 ms	52
J	80Vrms, 10 msec, tf < 0.5 cyc, tr < 0.5 cyc	52
K	80Vrms, 10 msec, tf < 0.5 cyc, tr = 70 ms	52
L	80Vrms, 3 x 10 msec, 0.5 apart, tf < 0.5 cyc, tr < 0.5 cyc	56
	Combined Transient	
M	80Vrms, 10 msec, tf < 0.5 cyc, tr < 0.5 cyc	52
	180Vrms, 10 msec, tf < 0.5 cyc, tr = 77 ms	

SVF 110 Tests – Revision F

SVF110 Condition	Normal Frequency Transients, Rev F	Duration (s)
	Over Frequency	
A	360 Hz 800 Hz, ts = 1.76 sec, dur = 0.5 cyc, tf = 1.76 sec	100
B	360 Hz 800 Hz, ts = 1.76 sec, dur = 1 sec, tf = 1.76 sec	80
C	360 Hz 800 Hz, ts = 0.96 sec, dur = 0.5 cyc, tf = 0.96 sec	60
D	360 Hz 800 Hz, ts = 0.96 sec, dur = 1 sec, tf = 0.96 sec	100
	Under Frequency	
E	800 Hz 360 Hz, ts = 1.76 sec, dur = 0.5 cyc, tf = 1.76 sec	100
F	800 Hz 360 Hz, ts = 1.76 sec, dur = 1 sec, tf = 1.76 sec	80
G	800 Hz 600 Hz, ts = 0.80 sec, dur = 0.5 cyc, tf = 0.80 sec	60
H	800 Hz 600 Hz, ts = 0.80 sec, dur = 1 sec, tf = 0.80 sec	100
	Combined	
I	600 Hz 360 Hz, ts = 0.96 sec, dur = 0.5 cyc, tf = 0.96 sec	62
	600 Hz 800 Hz, ts = 0.80 sec, dur = 0.5 cyc, tf = 0.80 sec	

SVF 201 Tests –Revision F

SVF201 Condition	Power Interrupt, Rev F	Duration (s)
	Run at 400, Repeat at 360, 600 and 800 Hz	
A	Vnom 115V, 50 msec	62
B	Vlow 108V, 50 msec	62
C	Vhigh 118V, 50 msec	62
D	Vnom 115V, 30 msec	62
E	Vlow 108V, 30 msec	62
F	Vhigh 118V, 30 msec	62
G	Vnom 115V, 10 msec	62
H	Vlow 108V, 10 msec	62
I	Vhigh 118V, 10 msec	62
J	Vnom 115V, 3 x 50 msec, 0.5 sec apart	62
K	Vnom 115V, 50 msec	62
	160Vrms, 30 msec, tr = 40 msec	
L	Vnom 115V, 50 msec	62
	70Vrms, 30 msec, tr = 40 msec	

SVF 301 Tests – Revision F

SVF301	Abnormal SS Limits Volt and Freq Rev F	Duration (s)
Condition		
	Low Voltage	
A	Vlow 100V, Fnom 400 Hz	1800
B	Vlow 100V, Flow 360 Hz	1800
C	Vlow 100V, Fhigh 600 Hz	1800
D	Vlow 100V, Fhigh 800 Hz	1800
	High Voltage	
E	Vhigh 125V, Fnom 400 Hz	1800
F	Vhigh 125V, Flow 380 Hz	1800
G	Vhigh 125V, Fhigh 600 Hz	1800
H	Vhigh 125V, Fhigh 800 Hz	1800

SVF 302 Tests – Revision F

SVF302	Abnormal Voltage Transients. Rev F	Duration (s)
Condition		
	Run at 400, Repeat at 360, 600 and 800 Hz	
	Over Voltage	
A	140Vrms, 180 msec, tf < 0.5 cyc, tr < 0.5 cyc	52
B	140Vrms, 180 msec, tf < 0.5 cyc, tr = 87 ms then 135Vrms, ramp down, tr = 253 msec then 130Vrms, ramp down, tr = 6.41 sec then 125Vrms, ramp down, tr > 10 sec then 115Vrms.	135
C	160Vrms, 78 msec, tf < 0.5 cyc, tr < 0.5 cyc	54
D	160Vrms, 78 msec, tf < 0.5 cyc, tr = 31 ms then 150Vrms, ramp down, tr = 71 msec then 140Vrms, ramp down, tr = 87 sec then 135Vrms, ramp down, tr > 253 sec. then 130Vrms, ramp down, tr = 6.41 sec then 125Vrms, ramp down, tr > 10 sec then 115Vrms.	135
E	180Vrms, 50 msec, tf < 1.25 ms, tr < 1.25 ms	52
F	180Vrms, 50 msec, tf < 0.5 cyc, tr = 11 ms then 170Vrms, ramp down, tr = 17 msec then 160Vrms, ramp down, tr = 31 msec then 150Vrms, ramp down, tr = 71 msec then 140Vrms, ramp down, tr = 87 sec then 135Vrms, ramp down, tr > 253 sec. then 130Vrms, ramp down, tr = 6.41 sec then 125Vrms, ramp down, tr > 10 sec then 115Vrms.	135
G	180Vrms, 3 x 20 msec, 0.5 sec apart, tf < 0.5 cyc, tr < 0.5 cyc	54
	Under Voltage	
H	85Vrms, 180 msec, tf < 0.5 cyc, tr < 0.5 cyc	54
I	85Vrms, 180 msec, tf < 0.5 cyc, tr = 87 ms then 90Vrms, ramp up, tr = 253 msec then 95Vrms, ramp up, tr = 6.41 sec then 100Vrms, ramp up, tr > 10 sec then 115Vrms.	135
J	66Vrms, 78 msec, tf < 0.5 cyc, tr < 0.5 cyc	54
K	65Vrms, 78 msec, tf < 0.5 cyc, tr = 31 ms then 75Vrms, ramp up, tr = 71 msec then 85Vrms, ramp up, tr = 87 msec then 90Vrms, ramp up, tr = 253 msec then 95Vrms, ramp up, tr = 6.41 sec then 100Vrms, ramp up, tr > 10 sec then 115Vrms.	135
L	45Vrms, 50 msec, tf < 0.5 cyc, tr < 0.5 cyc	52
M	45Vrms, 50 msec, tf < 0.5 cyc, tr = 11 ms then 55Vrms, ramp up, tr = 17 msec then 65Vrms, ramp up, tr = 31 msec then 75Vrms, ramp up, tr = 71 msec	135

SVF302		Abnormal Voltage Transients. Rev F	
Condition			Duration (s)
	then 85Vrms, ramp up, tr = 87 msec then 90Vrms, ramp up, tr = 253 msec then 95Vrms, ramp up, tr = 6.41 sec then 100Vrms, ramp up, tr > 10 sec then 115Vrms.		
N	45Vrms, 3 x 20 msec, 0.5 sec apart, tf < 0.5 cyc, tr < 0.5 cyc		58
Combined Transient			
O	45Vrms, 20 msec, tf < 1.25 ms, tr < 1.25 ms 180Vrms, 50 msec, tf < 0.5 cyc, tr = 11 ms then 170Vrms, ramp down, tr = 17 msec then 160Vrms, ramp down, tr = 31 msec then 150Vrms, ramp down, tr = 71 msec then 140Vrms, ramp down, tr = 87 sec then 135Vrms, ramp down, tr > 253 sec. then 130Vrms, ramp down, tr = 6.41 sec then 125Vrms, ramp down, tr > 10 sec then 115Vrms.		135

SVF 303 Tests – Revision F

SVF303		Abnormal Frequency Transients. Rev F	
Condition			Duration (s)
Over Frequency			
A	360 Hz 800 Hz, ts = 0.88 sec, dur = 0.5 cyc, tf = 0.88 sec		60
B	360 Hz 800 Hz, ts = 0.88 sec, dur = 1 sec, tf = 0.88 sec		65
C	360 Hz 800 Hz, ts = 0.48 sec, dur = 0.5 cyc, tf = 0.48 sec		56
D	360 Hz 800 Hz, ts = 0.48 sec, dur = 1 sec, tf = 0.48 sec		62
Under Frequency			
E	800 Hz 360 Hz, ts = 0.88 sec, dur = 0.5 cyc, tf = 0.88 sec		61
F	800 Hz 360 Hz, ts = 0.88 sec, dur = 1 sec, tf = 0.88 sec		68
G	800 Hz 600 Hz, ts = 0.40 sec, dur = 0.5 cyc, tf = 0.40 sec		56
H	800 Hz 600 Hz, ts = 0.40 sec, dur = 1 sec, tf = 0.40 sec		60
Combined			
I	600 Hz 360 Hz, ts = 0.48 sec, dur = 0.5 cyc, tf = 0.48 sec		60
	600 Hz 800 Hz, ts = 0.40 sec, dur = 0.5 cyc, tf = 0.40 sec		

SVF 401 Tests – Revision F

SVF401 Condition	Emergency SS Limits Volt and Freq. Rev F	Duration (s)
	Balanced Nominal Voltage	
A	Vnom, 360 Hz	1800
B	Vnom, 400 Hz	1800
C	Vnom, 600 Hz	1800
D	Vlow, 800 Hz	1800
	Balanced Low Voltage	
E	108V, 360 Hz	1800
F	108V, 400 Hz	1800
G	108V, 440 Hz	300
H	108V, 480 Hz	300
I	108V, 520 Hz	300
J	108V, 560 Hz	300
K	108V, 600 Hz	1800
L	108V, 520 Hz	300
M	108V, 540 Hz	300
N	108V, 560 Hz	300
O	108V, 570 Hz	300
P	108V, 580 Hz	300
Q	108V, 600 Hz	1800
R	108V, 640 Hz	300
S	108V, 680 Hz	300
T	108V, 720 Hz	300
U	108V, 760 Hz	300
V	108V, 800 Hz	1800
	Balanced High Voltage	
W	118V, 360 Hz	1800
X	118V, 400 Hz	1800
Y	118V, 440 Hz	300
Z	118V, 480 Hz	300
AA	118V, 520 Hz	300
BB	118V, 560 Hz	300
CC	118V, 600 Hz	1800
DD	118V, 520 Hz	300
EE	118V, 540 Hz	300
FF	118V, 560 Hz	300
GG	118V, 570 Hz	300
HH	118V, 580 Hz	300
II	118V, 600 Hz	1800
JJ	118V, 640 Hz	300
KK	118V, 680 Hz	300
LL	118V, 720 Hz	300
MM	118V, 760 Hz	300
NN	118V, 800 Hz	1800
	Unbalanced Nominal Voltage	
N/A		

SVF 501 Tests

Starting operations are not applicable to AC Utilization Equipment.

SVF 601 Tests – Revision F

SVF601	Power Failure - One Phase	
Condition		Duration (s)
	Run at 400, Repeat at 360, 600 and 800 Hz	
A	100 msec	52
B	500 msec	54
C	3 sec	66
D	7 sec	86

SVF 602 Tests – Revision F

Not applicable for single-phase EUT's.

SVF 603 Tests – Revision F

SVF603	Power Failure – Phase Reversal	
Condition		Duration (s)
	Run at 400, Repeat at 360, 600 and 800 Hz	
N/A	Use physical L-N connection reversal Apply Vnom = 115 V, Fnom = 400 Hz	1800

10.7.4 TVF Group Tests

Three phase, variable frequency tests

Note: *Variable frequency test are part of revision F only. There are no equivalent tests in revision A through E.*

TVF 102 Tests – Revision F

TVF102	Steady State Voltage and Frequency - Rev F	Duration (s)
Condition		
	Balanced Nominal Voltage	
A	Vnom, 360 Hz	1800
B	Vnom, 400 Hz	1800
C	Vnom, 600 Hz	1800
D	Vlow, 800 Hz	1800
	Balanced Low Voltage	
E	108V, 360 Hz	1800
F	108V, 400 Hz	1800
G	108V, 440 Hz	300
H	108V, 480 Hz	300
I	108V, 520 Hz	300
J	108V, 560 Hz	300
K	108V, 600 Hz	1800
L	108V, 520 Hz	300
M	108V, 540 Hz	300
N	108V, 560 Hz	300
O	108V, 570 Hz	300
P	108V, 580 Hz	300
Q	108V, 600 Hz	1800
R	108V, 640 Hz	300
S	108V, 680 Hz	300
T	108V, 720 Hz	300
U	108V, 760 Hz	300
V	108V, 800 Hz	1800
	Balanced High Voltage	
W	118V, 360 Hz	1800
X	118V, 400 Hz	1800
Y	118V, 440 Hz	300
Z	118V, 480 Hz	300
AA	118V, 520 Hz	300
BB	118V, 560 Hz	300
CC	118V, 600 Hz	1800
DD	118V, 520 Hz	300
EE	118V, 540 Hz	300
FF	118V, 560 Hz	300
GG	118V, 570 Hz	300
HH	118V, 580 Hz	300
II	118V, 600 Hz	1800
JJ	118V, 640 Hz	300
KK	118V, 680 Hz	300
LL	118V, 720 Hz	300
MM	118V, 760 Hz	300
NN	118V, 800 Hz	1800
	Unbalanced Nominal Voltage	
OO	Va = 108V, Vb = 111V, Vc = 111V, F = 360 Hz	1800
PP	Va = 118V, Vb = 115V, Vc = 115V, F = 360 Hz	1800
QQ	Va = 108V, Vb = 111V, Vc = 111V, F = 800 Hz	1800
RR	Va = 118V, Vb = 115V, Vc = 115V, F = 800 Hz	1800

TVF 103 Tests – Revision F

TVF103	Voltage Phase Difference - Rev F	
Condition		Duration (s)
A	A = 0, B = 116, C = 240	1800
B	A = 0, B = 124, C = 240	1800

TVF 104 Tests - Revision F

TVF104	Voltage Modulation - Rev B through F	
Condition		Duration (s)
	Run at 400, Repeat at 360, 600 and 800 Hz	
A	Vmod F = 1.0 Hz, V = 0.375 Vrms	1800
B	Vmod F = 1.7 Hz, V = 0.375 Vrms	1800
C	Vmod F = 10 Hz, V = 2.5 Vrms	1800
D	Vmod F = 25 Hz, V = 2.5 Vrms	1800
E	Vmod F = 70 Hz, V = 0.375 Vrms	1800
F	Vmod F = 100 Hz, V = 0.375 Vrms	1800
G	Vmod F = 200 Hz, V = 0.375 Vrms	1800

TVF 105 Tests – Revision F

TVF105	Frequency Modulation Rev F	
Condition		Duration (s)
	Run at 400, Repeat at 362, 600 and 798 Hz	
A	Fmod F = 1 Hz/sec, Fmod Amp = 4 Hz± 2 Hz	1800
B	Fmod F = 5 Hz/sec, Fmod Amp = 4 Hz± 2 Hz	1800
C	Fmod F = 10 Hz/sec, Fmod Amp = 4 Hz± 2 Hz	1800
D	Fmod F = 25 Hz/sec, Fmod Amp = 4 Hz± 2 Hz	1800
E	Fmod F = 100 Hz/sec, Fmod Amp = 4 Hz± 2 Hz	1800

TVF 106 Tests

Voltage distortion spectrum test require the use of additional external equipment. In particular, a high bandwidth (100Khz) AC source, a high frequency coupling transformer and coupling network as shown in figure TVF106-1 of the Mil-Std 704 standard. For this test, the Lx/Ls Series AC source can be programmed to a steady state condition of 360, 400, 600 and 800 Hz and Vnominal of 115 Vrms or 230 Vrms.

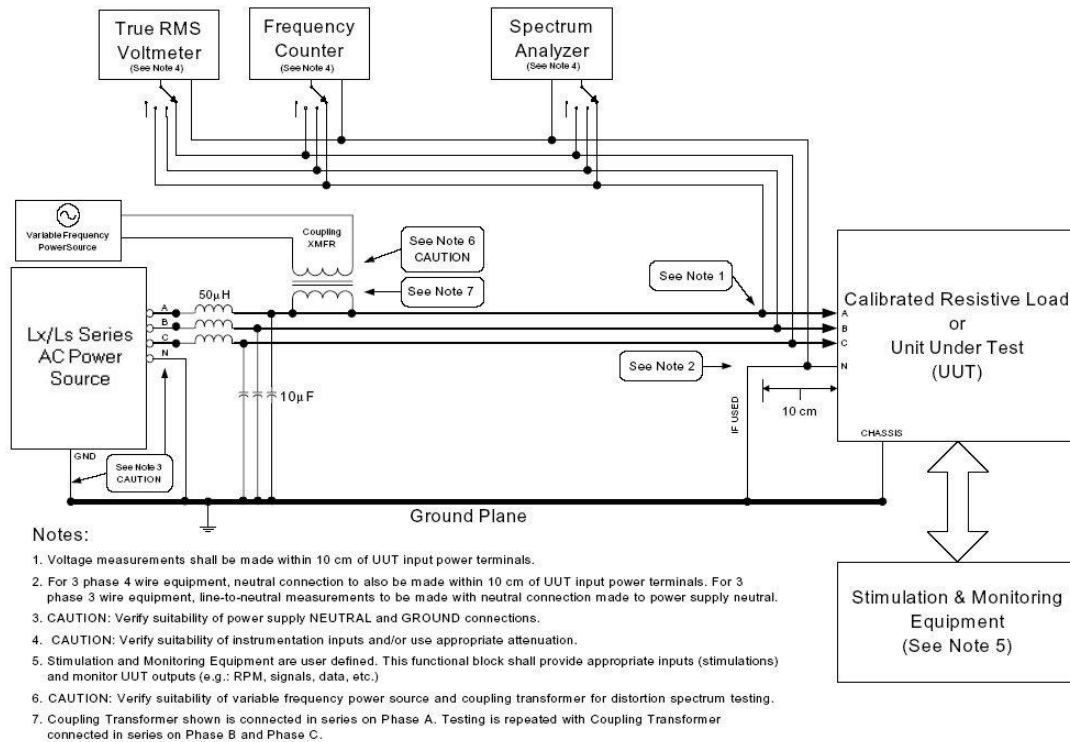

Figure 10-11: Required TVF-106 Test Setup.

TVF 107 Tests – Revision F

TVF107	Total Voltage Distortion Rev F	Duration (s)
Condition	Run at 400, Repeat at 360, 600 and 800 Hz	
A	0.05 % VTHD	1800
	F = 100%	
	H3 = 2.75%	
	H5 = 2.75%	
	H7 = 1.97%	
	H9 = 1.53%	
	H11 = 1.25%	
	H13 = 1.06%	
H15 = 0.92%		

TVF 108 Tests

TVF108 are DC offset tests and are not supported by the Lx/Ls Series AC Power sources. Contact California Instruments for DC Supply information. (sales@calinst.com)

TVF 109 Tests – Revision F

TVF109 Condition	Normal Voltage Transients Rev F	Duration (s)
	Run at 400, Repeat at 360, 600 and 800 Hz	
	Over Voltage	
A	140Vrms, 60 msec, tf < 0.5 cyc, tr < 0.5 cyc	52
B	140Vrms, 60 msec, tf < 0.5 cyc, tr = 25 ms	52
C	160Vrms, 34 msec, tf < 0.5 cyc, tr < 0.5 cyc	52
D	160Vrms, 34 msec, tf < 0.5 cyc, tr = 25 ms	52
E	180Vrms, 10 msec, tf < 0.5 cyc, tr < 0.5 cyc	52
F	180Vrms, 10 msec, tf < 0.5 cyc, tr = 77 ms	52
G	180Vrms, 3 x 10 msec, 0.5 sec apart, tf < 0.5 cyc, tr < 0.5 cyc	56
	Under Voltage	
H	90Vrms, 35 msec, tf < 0.5 cyc, tr < 0.5 cyc	52
I	90Vrms, 35 msec, tf < 0.5 cyc, tr = 45 ms	52
J	80Vrms, 10 msec, tf < 0.5 cyc, tr < 0.5 cyc	52
K	80Vrms, 10 msec, tf < 0.5 cyc, tr = 70 ms	52
L	80Vrms, 3 x 10 msec, 0.5 apart, tf < 0.5 cyc, tr < 0.5 cyc	56
	Combined Transient	
M	80Vrms, 10 msec, tf < 0.5 cyc, tr < 0.5 cyc	52
	180Vrms, 10 msec, tf < 0.5 cyc, tr = 77 ms	

TVF 110 Tests – Revision F

TVF110 Condition	Normal Frequency Transients, Rev F	Duration (s)
	Over Frequency	
A	360 Hz 800 Hz, ts = 1.76 sec, dur = 0.5 cyc, tf = 1.76 sec	100
B	360 Hz 800 Hz, ts = 1.76 sec, dur = 1 sec, tf = 1.76 sec	80
C	360 Hz 800 Hz, ts = 0.96 sec, dur = 0.5 cyc, tf = 0.96 sec	60
D	360 Hz 800 Hz, ts = 0.96 sec, dur = 1 sec, tf = 0.96 sec	100
	Under Frequency	
E	800 Hz 360 Hz, ts = 1.76 sec, dur = 0.5 cyc, tf = 1.76 sec	100
F	800 Hz 360 Hz, ts = 1.76 sec, dur = 1 sec, tf = 1.76 sec	80
G	800 Hz 600 Hz, ts = 0.80 sec, dur = 0.5 cyc, tf = 0.80 sec	60
H	800 Hz 600 Hz, ts = 0.80 sec, dur = 1 sec, tf = 0.80 sec	100
	Combined	
I	600 Hz 360 Hz, ts = 0.96 sec, dur = 0.5 cyc, tf = 0.96 sec	62
	600 Hz 800 Hz, ts = 0.80 sec, dur = 0.5 cyc, tf = 0.80 sec	

TVF 201 Tests –Revision F

TVF201 Condition	Power Interrupt, Rev F	Duration (s)
	Run at 400, Repeat at 360, 600 and 800 Hz	
A	Vnom 115V, 50 msec	62
B	Vlow 108V, 50 msec	62
C	Vhigh 118V, 50 msec	62
D	Vnom 115V, 30 msec	62
E	Vlow 108V, 30 msec	62
F	Vhigh 118V, 30 msec	62
G	Vnom 115V, 10 msec	62
H	Vlow 108V, 10 msec	62
I	Vhigh 118V, 10 msec	62
J	Vnom 115V, 3 x 50 msec, 0.5 sec apart	62
K	Vnom 115V, 50 msec	62
	160Vrms, 30 msec, tr = 40 msec	
L	Vnom 115V, 50 msec	62
	70Vrms, 30 msec, tr = 40 msec	

TVF 301 Tests – Revision F

TVF301	Abnormal SS Limits Volt and Freq Rev F	Duration (s)
Condition		Duration (s)
	Low Voltage	
A	Vlow 100V, Fnom 400 Hz	1800
B	Vlow 100V, Flow 360 Hz	1800
C	Vlow 100V, Fhigh 600 Hz	1800
D	Vlow 100V, Fhigh 800 Hz	1800
	High Voltage	
E	Vhigh 125V, Fnom 400 Hz	1800
F	Vhigh 125V, Flow 380 Hz	1800
G	Vhigh 125V, Fhigh 600 Hz	1800
H	Vhigh 125V, Fhigh 800 Hz	1800

TVF 302 Tests – Revision F

TVF302	Abnormal Voltage Transients. Rev F	Duration (s)
Condition		Duration (s)
	Run at 400, Repeat at 360, 600 and 800 Hz	
	Over Voltage	
A	140Vrms, 180 msec, tf < 0.5 cyc, tr < 0.5 cyc	52
B	140Vrms, 180 msec, tf < 0.5 cyc, tr = 87 ms then 135Vrms, ramp down, tr = 253 msec then 130Vrms, ramp down, tr = 6.41 sec then 125Vrms, ramp down, tr > 10 sec then 115Vrms.	135
C	160Vrms, 78 msec, tf < 0.5 cyc, tr < 0.5 cyc	54
D	160Vrms, 78 msec, tf < 0.5 cyc, tr = 31 ms then 150Vrms, ramp down, tr = 71 msec then 140Vrms, ramp down, tr = 87 sec then 135Vrms, ramp down, tr > 253 sec. then 130Vrms, ramp down, tr = 6.41 sec then 125Vrms, ramp down, tr > 10 sec then 115Vrms.	135
E	180Vrms, 50 msec, tf < 1.25 ms, tr < 1.25 ms	52
F	180Vrms, 50 msec, tf < 0.5 cyc, tr = 11 ms then 170Vrms, ramp down, tr = 17 msec then 160Vrms, ramp down, tr = 31 msec then 150Vrms, ramp down, tr = 71 msec then 140Vrms, ramp down, tr = 87 sec then 135Vrms, ramp down, tr > 253 sec. then 130Vrms, ramp down, tr = 6.41 sec then 125Vrms, ramp down, tr > 10 sec then 115Vrms.	135
G	180Vrms, 3 x 20 msec, 0.5 sec apart, tf < 0.5 cyc, tr < 0.5 cyc	54
	Under Voltage	
H	85Vrms, 180 msec, tf < 0.5 cyc, tr < 0.5 cyc	54
I	85Vrms, 180 msec, tf < 0.5 cyc, tr = 87 ms then 90Vrms, ramp up, tr = 253 msec then 95Vrms, ramp up, tr = 6.41 sec then 100Vrms, ramp up, tr > 10 sec then 115Vrms.	135
J	66Vrms, 78 msec, tf < 0.5 cyc, tr < 0.5 cyc	54
K	65Vrms, 78 msec, tf < 0.5 cyc, tr = 31 ms then 75Vrms, ramp up, tr = 71 msec then 85Vrms, ramp up, tr = 87 msec then 90Vrms, ramp up, tr = 253 msec then 95Vrms, ramp up, tr = 6.41 sec then 100Vrms, ramp up, tr > 10 sec then 115Vrms.	135
L	45Vrms, 50 msec, tf < 0.5 cyc, tr < 0.5 cyc	52
M	45Vrms, 50 msec, tf < 0.5 cyc, tr = 11 ms then 55Vrms, ramp up, tr = 17 msec	135

TVF302	Abnormal Voltage Transients. Rev F	
Condition		Duration (s)
	then 65Vrms, ramp up, tr = 31 msec then 75Vrms, ramp up, tr = 71 msec then 85Vrms, ramp up, tr = 87 msec then 90Vrms, ramp up, tr = 253 msec then 95Vrms, ramp up, tr = 6.41 sec then 100Vrms, ramp up, tr > 10 sec then 115Vrms.	
N	45Vrms, 3 x 20 msec, 0.5 sec apart, tf < 0.5 cyc, tr < 0.5 cyc	58
Combined Transient		
O	45Vrms, 20 msec, tf < 1.25 ms, tr < 1.25 ms 180Vrms, 50 msec, tf < 0.5 cyc, tr = 11 ms then 170Vrms, ramp down, tr = 17 msec then 160Vrms, ramp down, tr = 31 msec then 150Vrms, ramp down, tr = 71 msec then 140Vrms, ramp down, tr = 87 sec then 135Vrms, ramp down, tr > 253 sec. then 130Vrms, ramp down, tr = 6.41 sec then 125Vrms, ramp down, tr > 10 sec then 115Vrms.	135

TVF 303 Tests – Revision F

TVF303	Abnormal Frequency Transients. Rev F	
Condition		Duration (s)
Over Frequency		
A	360 Hz 800 Hz, ts = 0.88 sec, dur = 0.5 cyc, tf = 0.88 sec	60
B	360 Hz 800 Hz, ts = 0.88 sec, dur = 1 sec, tf = 0.88 sec	65
C	360 Hz 800 Hz, ts = 0.48 sec, dur = 0.5 cyc, tf = 0.48 sec	56
D	360 Hz 800 Hz, ts = 0.48 sec, dur = 1 sec, tf = 0.48 sec	62
Under Frequency		
E	800 Hz 360 Hz, ts = 0.88 sec, dur = 0.5 cyc, tf = 0.88 sec	61
F	800 Hz 360 Hz, ts = 0.88 sec, dur = 1 sec, tf = 0.88 sec	68
G	800 Hz 600 Hz, ts = 0.40 sec, dur = 0.5 cyc, tf = 0.40 sec	56
H	800 Hz 600 Hz, ts = 0.40 sec, dur = 1 sec, tf = 0.40 sec	60
Combined		
I	600 Hz 360 Hz, ts = 0.48 sec, dur = 0.5 cyc, tf = 0.48 sec 600 Hz 800 Hz, ts = 0.40 sec, dur = 0.5 cyc, tf = 0.40 sec	60

TVF 401 Tests – Revision F

TVF401 Condition	Emergency SS Limits Volt and Freq. Rev F	Duration (s)
Balanced Nominal Voltage		
A	Vnom, 360 Hz	1800
B	Vnom, 400 Hz	1800
C	Vnom, 600 Hz	1800
D	Vlow, 800 Hz	1800
Balanced Low Voltage		
E	108V, 360 Hz	1800
F	108V, 400 Hz	1800
G	108V, 440 Hz	300
H	108V, 480 Hz	300
I	108V, 520 Hz	300
J	108V, 560 Hz	300
K	108V, 600 Hz	1800
L	108V, 520 Hz	300
M	108V, 540 Hz	300
N	108V, 560 Hz	300
O	108V, 570 Hz	300
P	108V, 580 Hz	300
Q	108V, 600 Hz	1800
R	108V, 640 Hz	300
S	108V, 680 Hz	300
T	108V, 720 Hz	300
U	108V, 760 Hz	300
V	108V, 800 Hz	1800
Balanced High Voltage		
W	118V, 360 Hz	1800
X	118V, 400 Hz	1800
Y	118V, 440 Hz	300
Z	118V, 480 Hz	300
AA	118V, 520 Hz	300
BB	118V, 560 Hz	300
CC	118V, 600 Hz	1800
DD	118V, 520 Hz	300
EE	118V, 540 Hz	300
FF	118V, 560 Hz	300
GG	118V, 570 Hz	300
HH	118V, 580 Hz	300
II	118V, 600 Hz	1800
JJ	118V, 640 Hz	300
KK	118V, 680 Hz	300
LL	118V, 720 Hz	300
MM	118V, 760 Hz	300
NN	118V, 800 Hz	1800
Unbalanced Nominal Voltage		
OO	Va = 108V, Vb = 111V, Vc = 111V, F = 360 Hz	1800
PP	Va = 118V, Vb = 115V, Vc = 115V, F = 360 Hz	1800
QQ	Va = 108V, Vb = 111V, Vc = 111V, F = 800 Hz	1800
RR	Va = 118V, Vb = 115V, Vc = 115V, F = 800 Hz	1800

TVF 501 Tests

Starting operations are not applicable to AC Utilization Equipment.

TVF 601 Tests – Revision F

TVF601	Power Failure - One Phase – Rev F	
Condition		Duration (s)
	Run at 400, Repeat at 360, 600 and 800 Hz	
A	100 msec	52
B	500 msec	54
C	3 sec	66
D	7 sec	86

TVF 602 Tests – Revision F

TVF601	Power Failure – One, Two Phase – Rev F	
Condition		Duration (s)
	Run at 400, Repeat at 360, 600 and 800 Hz	
	One Phase	
A	Phase A, 7 sec - 5x	86
B	Phase B, 7 sec - 5x	86
C	Phase C, 7 sec - 5x	86
D	Phase A, 30 min - 1x	1800
E	Phase B, 30 min - 1x	1800
F	Phase C, 30 min - 1x	1800
	Two Phase	
G	Phase A&B, 7 sec - 5x	86
H	Phase B&C, 7 sec - 5x	86
I	Phase A&B, 30 min - 1x	1800
J	Phase B&C, 30 min - 1x	1800

TVF 603 Tests – Revision F

TVF603	Power Failure – Phase Reversal – Rev F	
Condition		Duration (s)
	Run at 400, Repeat at 360, 600 and 800 Hz	
A	Phase rotation C-B-A	1800
	Phase rotation A-B-C	1800

10.7.5 SXF Group Tests

Single phase 60 Hz AC tests

Note: 60 Hz frequency tests are part of revision F only. There are no equivalent tests in revision A through E.

SXF 102 Tests – Revision F

SXF102	Steady State Voltage and Frequency - Rev C-F	
Condition		Duration (s)
	Nominal Voltage	
A	Vnom=115V, Fnom=60 Hz - Nominal	1800
B	Vnom=115V, Flow=59.5 Hz - Nominal	1800
C	Vnom=115V, Fhigh=60.5 Hz - Nominal	1800
	Low Voltage	
D	Vlow =105V, Fnom=60 Hz - Low	1800
E	Vlow=105V, Flow= 59.5 Hz- Low	1800
F	Vlow=105V, Fhigh=60.5 Hz - Low	1800
	High Voltage	
G	Vhigh=125V, Fnom=60 Hz - High	1800
H	Vhigh=125V, Flow=59.5 Hz- High	1800
I	Vhigh=125V, Fhigh=60.5 Hz - High	1800

SXF 103 Tests

Voltage Phase Difference tests do not apply for single-phase EUT's.

SXF 104 Tests – Revision F

SXF104	Voltage Modulation Rev F	
Condition		Duration (s)
A	Vmod F = 1.0 Hz, V = 0.375 Vrms	1800
B	Vmod F = 1.5 Hz, V = 2.5 Vrms	1800
C	Vmod F = 4 Hz, V = 2.5 Vrms	1800
D	Vmod F = 10 Hz, V = 0.375 Vrms	1800
E	Vmod F = 15 Hz, V = 0.375 Vrms	1800
F	Vmod F = 30 Hz, V = 0.375 Vrms	1800

SXF 105 Tests – Revisions E, F

SXF105	Frequency Modulation Rev F	
Condition		Duration (s)
A	Fmod F = 0.1 Hz/sec, Fmod Amp = 0.5 Hz± 0.25 Hz	1800
B	Fmod F = 0.5 Hz/sec, Fmod Amp = 0.5 Hz± 0.25 Hz	1800
C	Fmod F = 4 Hz/sec, Fmod Amp = 0.5 Hz± 0.25 Hz	1800
D	Fmod F = 25 Hz/sec, Fmod Amp = 0.5 Hz± 0.25 Hz	1800
E	Fmod F = 15 Hz/sec, Fmod Amp = 0.5 Hz± 0.25 Hz	1800

SXF 106 Tests

Voltage distortion spectrum test require the use of additional external equipment. In particular, a high bandwidth (100Khz) AC source, a high frequency coupling transformer and coupling network as shown in figure SXF106-1 of the Mil-Std 704 standard. For this test, the Lx/Ls Series AC source can be programmed to a steady state condition of 400 Hz and Vnominal of 115 Vrms or 230 Vrms.

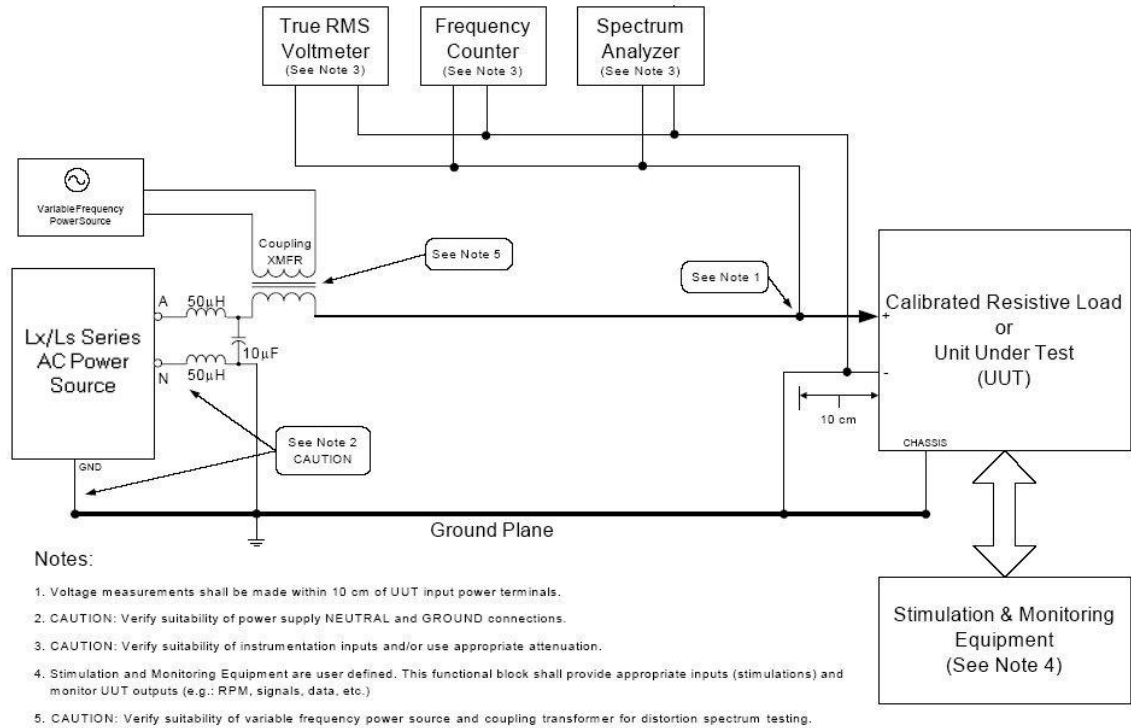

Figure 10-12: Required SXF-106 Test Setup.

SXF 107 Tests – Revision F

SXF107	Total Voltage Distortion Rev F	Duration (s)
Condition		
A	0.05 % VTHD	1800
	F = 100%	
	H3 = 2.75%	
	H5 = 2.75%	
	H7 = 1.97%	
	H9 = 1.53%	
	H11 = 1.25%	
	H13 = 1.06%	
	H15 = 0.92%	

SXF 108 Tests

SXF108 are DC offset tests and are not supported by the Lx/Ls Series AC Power sources. Contact California Instruments for DC Supply information. (sales@calinst.com)

SXF 109 Tests – Revision F

SXF109	Normal Voltage Transients Rev F	
Condition		Duration (s)
	Over Voltage	
A	152Vrms, 0.5 cyc, tf < n/a, tr <na	52
B	130Vrms, 1.0 cyc, tf < 8.333 ms, tr < 8.333 ms	52
C	130Vrms, 1.0 cyc, tf < 8.333 ms, tr = 250 ms	52
D	130Vrms, 3 x 1.0 cyc, 0.5 apart, tf < 8.333 ms, tr < 8.333 ms	56
	Under Voltage	
E	31Vrms, 0.5 cyc, tf < n/a, tr <na	52
F	70Vrms, 1.0 cyc, tf < 8.333 ms, tr < 8.333 ms	52
G	70Vrms, 1.0 cyc, tf < 8.333 ms, tr = 107 ms	52
H	70Vrms, 3 x 1.0 cyc, 0.5 apart, tf < 8.333 ms, tr < 8.333 ms	56
	Combined Transient	
I	70Vrms, 1.0 cyc, tf < 8.333 ms, tr < 8.333 ms	52
	130Vrms, 1.0 cyc, tf < 8.333 ms, tr = 250 ms	

SXF 110 Tests – Revision F

SXF110	Normal Frequency Transients, Rev F	
Condition		Duration (s)
	Over Frequency	
A	61 Hz, 0.5 cyc, tr = 10 msec, tf = 10 msec	100
B	61 Hz, 5 sec, tr = 10 msec, tf = 10 msec	80
	Under Frequency	
C	59 Hz, 0.5 cyc, tr = 10 msec, tf = 10 msec	100
D	59 Hz, 5 sec, tr = 10 msec, tf = 10 msec	80
	Combined	
E	59 Hz, 0.5 cyc, tr = 10 msec, tf = 10 msec	62
	61 Hz, 0.5 cyc, tr = 10 msec, tf = 10 msec	

SXF 201 Tests –Revision F

SXF201	Power Interrupt, Rev F	
Condition		Duration (s)
A	Vnom 115V, 50 msec	62
B	Vlow 105V, 50 msec	62
C	Vhigh 125V, 50 msec	62
D	Vnom 115V, 30 msec	62
E	Vlow 105V, 30 msec	62
F	Vhigh 125V, 30 msec	62
G	Vnom 115V, 10 msec	62
H	Vlow 105V, 10 msec	62
I	Vhigh 125V, 10 msec	62
J	Vnom 115V, 3 x 50 msec, 0.5 sec apart	62
K	Vnom 115V, 50 msec	62
	130Vrms, 0.5 cyc, tr = 250 msec	
L	Vnom 115V, 50 msec	62
	70Vrms, 1.0 cyc, tr = 107 msec	

SXF 301 Tests – Revision F

SXF301	Abnormal SS Limits Volt and Freq Rev F	Duration (s)
Condition		
	Nominal Voltage	
A	Vnom 115V, Flow 59.5 Hz	1800
B	Vnom 115V, Fhigh 60.5 Hz	1800
	Low Voltage	
C	Vlow 100V, Fnom 400 Hz	1800
D	Vlow 100V, Flow 380 Hz	1800
E	Vlow 100V, Fhigh 420 Hz	1800
	High Voltage	
F	Vhigh 128V, Fnom 60 Hz	1800
G	Vhigh 128V, Flow 59.5 Hz	1800
H	Vhigh 128V, Fhigh 60.5 Hz	1800

SXF 302 Tests – Revision F

SXF302	Abnormal Voltage Transients. Rev F	Duration (s)
Condition		
	Over Voltage	
A	180Vrms, 0.5 cyc, tf < 8.333 ms, tr < 8.333 ms	54
B	180Vrms, 0.5 cyc, tf < 8.333 ms, tr = 16.67 ms then 147Vrms, ramp down, tr = 16.67 msec then 140Vrms, ramp down, tr = 2.0 sec then 115Vrms.	135
C	160Vrms, 1.0 cyc, tf < 8.333 ms, tr < 8.333 ms	54
D	160Vrms, 0.5 cyc, tf < 8.333 ms, tr = 16.67 ms then 140Vrms, ramp down, tr = 2.0 sec then 115Vrms.	135
E	180Vrms, 3 x 0.5 cyc, 0.5 sec apart, tf < 8.333 ms, tr < 8.333 ms	54
	Under Voltage	
F	50Vrms, 0.5 cyc, tf < 8.333 ms, tr < 8.333 ms	54
G	50Vrms, 0.5 cyc, tf < 8.333 ms, tr = 16.67 ms then 83Vrms, ramp up, tr = 16.67 msec then 90Vrms, ramp up, tr = 2.0 sec then 115Vrms.	135
H	70Vrms, 1.0 cyc, tf < 8.333 ms, tr < 8.333 ms	54
I	70Vrms, 0.5 cyc, tf < 8.333 ms, tr = 16.67 ms then 90Vrms, up, tr = 2.0 sec then 115Vrms.	135
J	50Vrms, 3 x 0.5 cyc, 0.5 sec apart, tf < 8.333 ms, tr < 8.333 ms	54
	Combined Transient	
K	50Vrms, 0.5 cyc, tf < 8.333 ms, tr < 8.333 ms 180Vrms, 0.5 cyc, tf < 8.333 ms, tr = 16.67 ms then 147Vrms, ramp down, tr = 16.67 msec then 140Vrms, ramp down, tr = 2.0 sec then 115Vrms.	135

SXF 303 Tests – Revision F

SXF303	Abnormal Frequency Transients. Rev F	Duration (s)
Condition		
	Over Frequency	
A	61 Hz, 0.5 cycle, tr = 0.5 cyc, tf = 0.5 cyc	55
B	61 Hz, 6.968 sec, tr = 0.5 cyc, tf = 0.5 cyc	76
	Under Frequency	
C	59 Hz, 0.5 cycle, tr = 0.5 cyc, tf = 0.5 cyc	55
D	59 Hz, 6.968 sec, tr = 0.5 cyc, tf = 0.5 cyc	76
	Combined	
E	59 Hz, 0.5 cycle, tr = 0.5 cyc, tf = 0.5 cyc 61 Hz, 0.5 cycle, tr = 0.5 cyc, tf = 0.5 cyc	56

SXF 401 Tests – Revision F

SXF401	Emergency SS Limits Volt and Freq. Rev F	
Condition		Duration (s)
	Nominal Voltage	
A	Vnom=115V, Fnom=60 Hz - Nominal	1800
B	Vnom=115V, Flow=59.5 Hz - Nominal	1800
C	Vnom=115V, Fhigh=60.5 Hz - Nominal	
	Low Voltage	
D	Vlow =105V, Fnom=60 Hz - Low	1800
E	Vlow=105V, Flow= 59.5 Hz- Low	1800
F	Vlow=105V, Fhigh=60.5 Hz - Low	1800
	High Voltage	
G	Vhigh=125V, Fnom=60 Hz - High	1800
H	Vhigh=125V, Flow=59.5 Hz- High	1800
I	Vhigh=125V, Fhigh=60.5 Hz - High	1800

SXF 501 Tests

Starting operations are not applicable to AC Utilization Equipment.

SXF 601 Tests – Revision F

SXF601	Power Failure - One Phase	
Condition		Duration (s)
A	100 msec	52
B	500 msec	54
C	2 sec	66

SXF 602 Tests – Revision F

Not applicable for single-phase EUT's.

SXF 603 Tests – Revision F

SXF603	Power Failure – Phase Reversal	
Condition		Duration (s)
N/A	Use physical L-N connection reversal Apply Vnom = 115 V, Fnom = 60 Hz	1800

10.8 MS704 Operation Using the LxGui Software

The LxGui supplied with the Lx/Ls Series AC power sources can be used to operate the MS704 option. The LxGui detects the presence of this option and enables access to the relevant operating screens. If you are unable to access the MS704 option screens from within the LxGui, you do not have the -704F option (MS704) installed or the firmware in your unit pre-dates release of the MS704 version of this option. In that case, contact California Instruments for upgrade information. (sales@calist.com)

The information on use of the LxGui with the MS704 option is also contained in the on-line help file of the LxGui program.

Note: *For Ls Series AC sources without the –ADV option installed, the harmonic analysis and waveform acquisition functions described in this section are not available. Contact sales@calinst.com to upgrade the Ls AC Source with the –ADV option. The MIL-STD 704 stimulus can still be run however.*

10.8.1 Steady State Settings

To access the MS704 test screen, the steady state settings of the Lx/Ls AC source must meet the following conditions:

Parameter	Setting	Notes
Output voltage for all phases:	115Vrms or 230Vrms	Line to Neutral.
Frequency:	Between 360 and 800 Hz or 60 Hz.	
Phase Rotations:	A = 0°, B = 240°, C = 120°	Three phase mode only.

If one or more conditions is not met, the MS704 screen cannot be opened but instead an error message indicated the above conditions must be met will be displayed. The state of the output relay (open or closed) is not important. If needed, the output relay will be closed when the user starts a test.

The Mil-Std 704 tests can be selected from the LxGui toolbar or menu. There is a separate toolbar button for –704 and –704F options or an individual menu entry for each option. If the corresponding options are installed, the toolbar button and menu entry will be active.

10.8.2 LxGui MS704 Test Screen

The -704F option interface screen is shown below. (Figure 10-13). Settings can be made through a series of tabbed dialogs in the center of the screen. Any EUT information can be entered at the bottom. This information will be transferred to the test report.

Test execution is controlled using the Start / Abort buttons to the left. The right hand side of this window provides output monitoring for voltage (all three phases in 3 phase mode) and frequency. During a test run, this data is updated once a second. A log of readings is automatically kept.

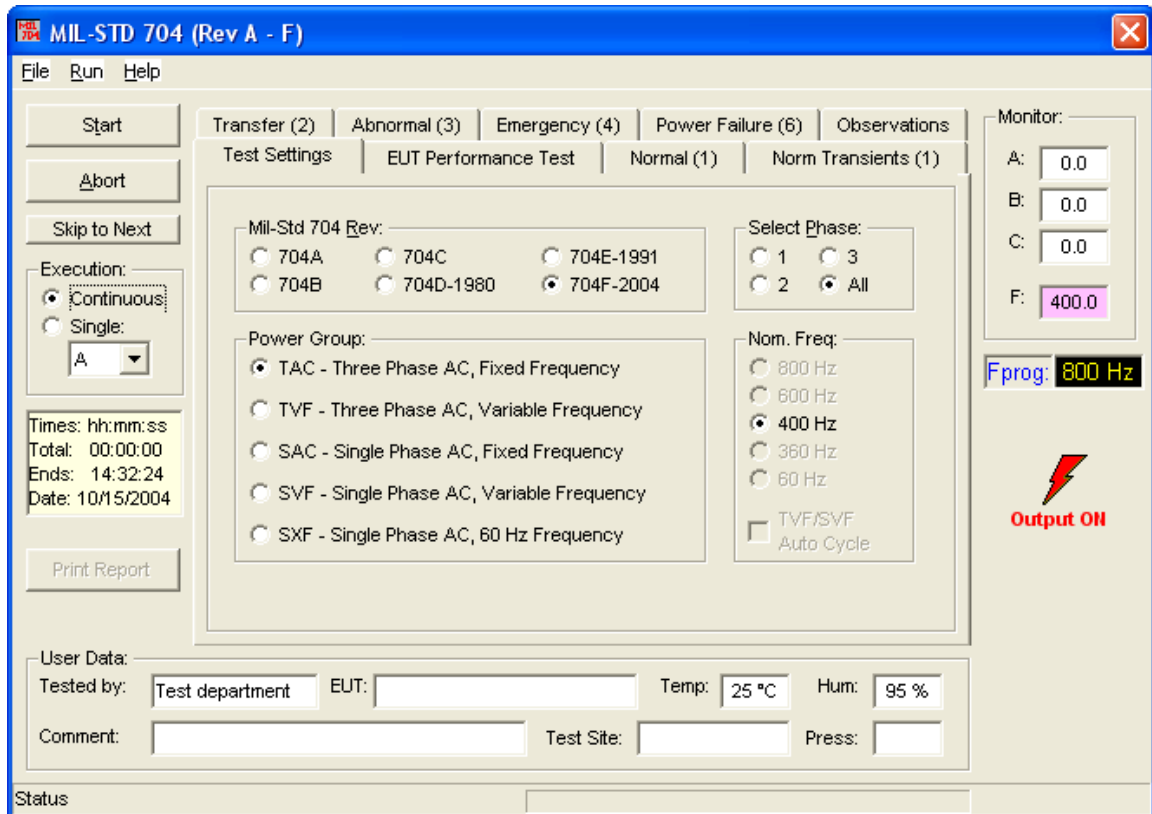

Figure 10-13: LxGui MS704 Option Screen

All test selection and execution modes are set from this screen.

10.8.3 LxGui MS704 Performance Test Screen

Note: For Ls Series AC sources without the –ADV option installed, the harmonic analysis and waveform acquisition functions described in this section are not available. Contact sales@calinst.com to upgrade the Ls AC Source with the –ADV option. The MIL-STD 704 stimulus can still be run however.

Revision F of the MIL-STD 704 provides additional detail on performance evaluation of the EUT after running an immunity test. This is covered in test method 101 of each of the power test groups. The Lx Series AC source and the Ls Series AC source with the –ADV option provides built-in measurement functions that can be used to evaluate EUT performance.

Note however that the maximum bandwidth requirement for current harmonic measurements of the Lx/Ls Series is limited to 48KHz in single-phase mode and 16 KHz in three-phase range. Harmonic components that fall outside this bandwidth are not reported (value of 0.00 is returned).

The requirement for MIL-STD 704 is 150 KHz so for EUT’s with high harmonic order currents, a higher bandwidth external power analyzer should be used in addition to the AC source’s measurement system.

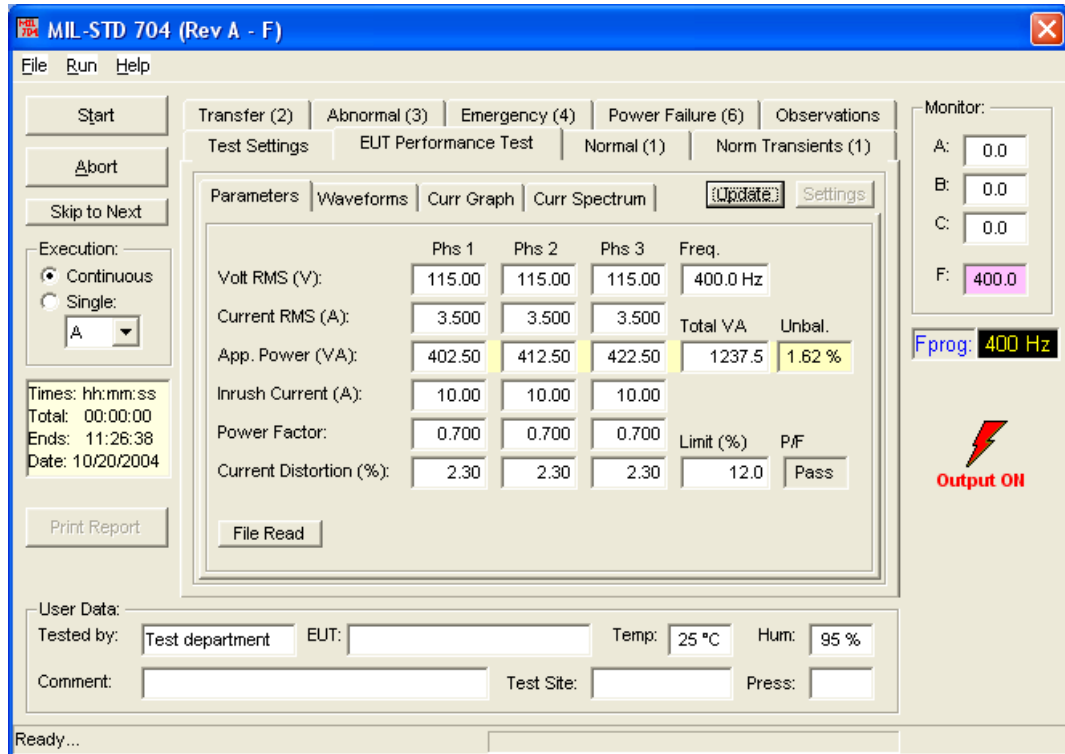

Figure 10-14: LxGui MS704 Option EUT Performance Test Screen - Measurements

The EUT measurement data collected for the 101 EUT performance test is divided among four separate tabs that can be displayed by clicking on each tab at the top of the test window. Available tabs are:

Tab	Description
Parameters	<p>This tab displays parametric measurement data for all phases (three-phase mode) or phase A only (single-phase mode). Data displayed includes Frequency (Hz), Voltage RMS (V), Current RMS (A), Apparent Power (VA), Inrush current (A), Power Factor and Total Current Distortion (%). The total VA for all three phases combined is shown for three phase EUT's. Any unbalance between phases is calculated and displayed next to the total VA readout. If the unbalance exceeds the MIL-STD 704 limit of 3%, this field will have a red background.</p> <p>The current distortion is compared to the user specified ITHD limit value shown to the right of the current distortion readout. If one of more of the phase currents exceeds this limit, a Fail result will be displayed on the right. The ITHD limit is set in the "MS704_Distortion_Limits.ini" text file located in the LxGui application directory. (See paragraph 10.8.3.1)</p>
Waveforms	<p>This tab displays at least one full cycle of both the voltage and current waveforms. (all waveforms are for L-N voltage and phase current). In three-phase mode, the phase to be displayed can be selected by using the phase selection radio buttons to the left of the graph. Only one phase is displayed at a time but all three phases are always acquired at the same time. The test report will include data for all three phases as well.</p> <p>The Settings button can be used to change display scaling and graph colors if needed.</p>
Curr Graph	<p>This tab displays the current harmonic spectrum in graphical form (Bar Chart - absolute). In three-phase mode, the phase to be displayed can be selected by using the phase selection radio buttons to the left of the graph. Only one phase is displayed at a time but all three phases are always acquired at the same time. The test report will include data for all three phases as well.</p> <p>The Settings button can be used to change display scaling and graph colors if needed.</p>
Curr Spectrum	<p>This tab displays the current harmonic spectrum in tabular form (Numeric – absolute and relative to fundamental). In three-phase mode, the phase to be displayed can be selected by using the phase selection radio buttons to the left of the graph. Only one phase is displayed at a time but all three phases are always acquired at the same time. The test report will include data for all three phases as well.</p> <p>The user can define relative limits for one or more current harmonics. If set, the LxGui will compare actual harmonic current components against the user defined limits and display pass or fail in the right hand column. This data is also part of the test report.</p> <p>The current harmonic limits can be set by editing the "MS704_Distortion_Limits.ini" text file located in the LxGui application directory. (See paragraph 10.8.3.1)</p>

The EUT performance measurements are taken at the start of a test run and again after the selected test or tests have been completed. If a variable frequency test group is selected, the data will be taken at 360 Hz, 400 Hz, 600 Hz and 800 Hz. Data for each frequency is saved and can be recalled for display if needed by using the "File Read" button in the lower left corner of the Parameters Tab. The last measurement data taken by the LxGui program is preserved in the

application subdirectory \Reports as a text file named MeasData_XXX_Hz.txt where XXX is either 360, 400, 600 or 800.

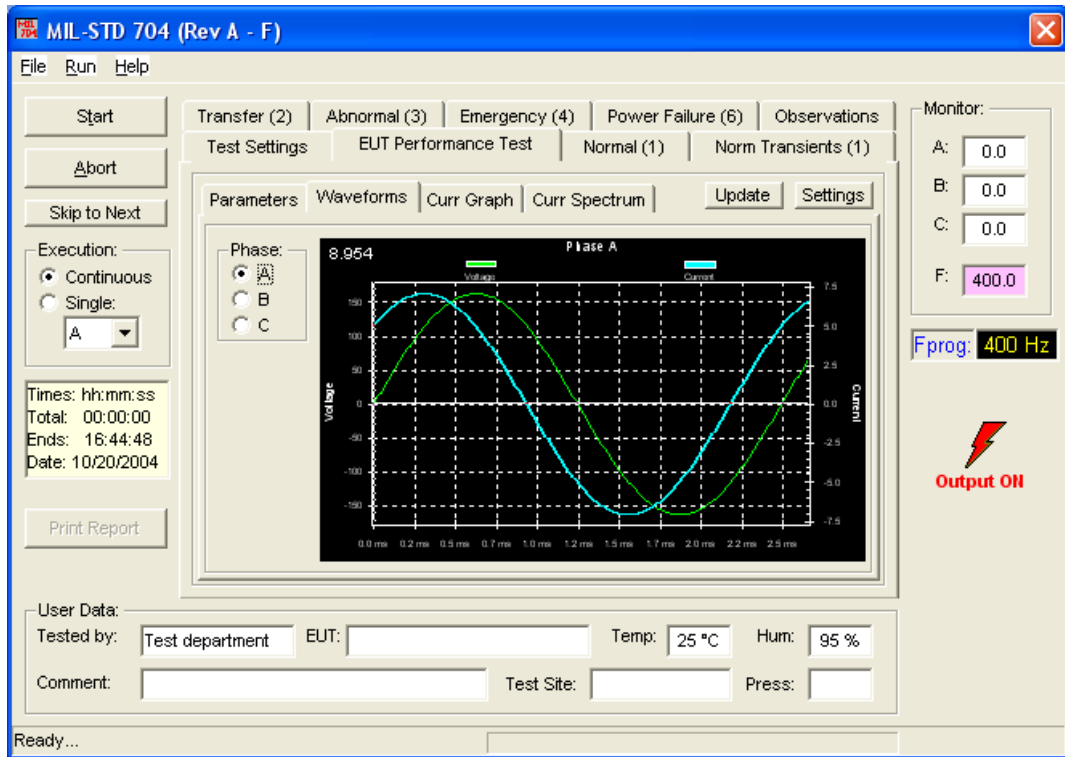

Figure 10-15: LxGui MS704 Option EUT Performance Test Screen - Waveforms

10.8.3.1 MS704 Current Harmonics Limits File

The user can define relative limits for one or more current harmonics. If set, the LxGui will compare actual harmonic current components against the user defined limits and display pass or fail in the right hand column. This data is also part of the test report. The current harmonic limits can be set by editing the “MS704_Distortion_Limits.ini” text file located in the LxGui application directory. To not set a limit for a specific harmonic component, remove its entry from the INI file or set its value to zero.

Limits can be defined for each of the five available power groups. The mapping is as follows:

INI File Section Header	Test Group
MS704_Group_0	TAC
MS704_Group_1	TVF
MS704_Group_2	SAC
MS704_Group_3	SVF
MS704_Group_4	SXF

The total harmonic current distortion level ITHD is set for each group with the entry “Ithd = nn.n” where nn.n is the limit in %.

For individual harmonic components, use the keyword, “IHarmLimit_x” where x = 1 through 50.

A sample “MS704_Distortion_Limits.ini” file shipped with LxGui program is shown below.

```
// Comments can be included for readability.
// Current Distortion Harmonics Limits by Power Group

[MS704_Group_0]
// Const MS_TAC = 0
Ithd = 12.0
IHarmLimit_3 = 65.00
IHarmLimit_5 = 4.00
IHarmLimit_7 = 3.00

[MS704_Group_1]
// Const MS_TVFF = 1
Ithd = 12.0
IHarmLimit_3 = 5.00
IHarmLimit_5 = 4.00
IHarmLimit_7 = 3.00

[MS704_Group_2]
// Const MS_SAC = 2
Ithd = 12.0
IHarmLimit_3 = 5.00
IHarmLimit_5 = 4.00
IHarmLimit_7 = 3.00

[MS704_Group_3]
// Const MS_SVFF = 3
Ithd = 12.0
IHarmLimit_3 = 5.00
IHarmLimit_5 = 4.00
IHarmLimit_7 = 3.00

[MS704_Group_4]
// Const MS_SXFF = 4
Ithd = 12.0
IHarmLimit_3 = 5.00
IHarmLimit_5 = 4.00
IHarmLimit_7 = 3.00
```

10.8.4 LxGui MS704 Test Settings Screen

Before running a Mil-Std 704 immunity test, the desired test revision and Power Group must be selected from the Test Settings tab. (See Figure 10-13) Note that not all power groups are available for all revisions of the Mil-Std 704. In particular, variable frequency power groups and the 60 Hz power group were added only with revision F. Only supported power groups can be selected for a specific test revision. Others will be disabled automatically.

For variable frequency power groups in Revision F (TVF and SVF), the Nominal frequency at which to perform the test can be selected on the left hand side. Available choices are 360 Hz, 400 Hz, 600 Hz and 800 Hz. The Auto-cycle setting if checked will cause the selected tests to be repeated for all four frequencies. This will increase the total test time by a factor of 4.

If the AC source is in three-phase mode, the phase selection radio buttons may be used to select a specific phase or all three phases. If a specific phase is selected, the other two phases remain at the nominal programmed voltage. If the AC source is in single-phase mode or a single-phase model only, this selection will be locked on phase 1 or A.

Note: *Any Frequency tests will affect all phase output, regardless of the phase selection made by the user.*

Once a test is in progress, the test selections cannot be changed and all frames in this tab are disabled. Tests can be aborted at any time using the Abort button or the Run, Stop menu.

10.8.5 LxGui MS704 Test Method Selections 2XX through 60X

Tests steps can be selected individually as desired. For each test method (2XX through 6XX), a separate tab is provided. Each tabs will show available test steps for the selected standard revision and power group. Test method numbers are shown for each step for reference to Mil-Std 704 rev F. A test method is selected by checking the check box in front of it. As each test method is selected, the total estimated execution time and expected date and time of completion is shown in the left hand yellow window. Note that several tests require the EUT to run for 30 minutes so the total test time can add up quickly.

To select all test methods on any given tab, use the Select All button at the bottom of the tab. To de-select all test methods on a tab, use the Unselect All button. These buttons work only on the displayed test method tab. Check the other tabs by clicking each one for other selections that have been made. Unless the total time in the left window shows 00:00:00, one or more test methods have been selected.

10.8.6 LxGui MS704 Test Execution

Each test method has several steps, generally labeled A through Z and AA through RR. The number of test steps will differ between test methods. Execution can be done for a complete test method. In this case, all test steps will run in sequence. This is the Continuous execution mode.

Alternatively, a single test steps can be executed by selecting the Single Execution mode. In this mode, the desired test step must be selected using the drop down list in the Execution selection frame. It is the user's responsibility to select a test step that actually exists for the selected test method. It is not recommended to select more than one test method at a time when using the Single mode as different test methods may not have the same step letter.

Note that the execution times shown in the right apply to the complete test method(s) selected. They do not reflect the execution time for a single step in Single mode. Refer to section 10.7 for specific test times per step.

10.8.7 LxGui MS704 Observations Data Entry

Observations of EUT behavior during the test can be entered by the operator in the Observations tab. This information will be included in the test report. This is a free form text entry field.

10.8.8 LxGui MS704 Reports

Upon completion of a test, it is possible to print a test report. There are two report formats available. The report format must be set in the Report Setup screen available from the Options, Test Report Setup... menu in the main LxGui window. This screen also allows entry of any custom report header and footers.

The simplest form is the direct printer format, which produces a short form report with textual information only. Select "Output directly to Windows printer."

A more comprehensive report is available if a copy of MS Word (version 8.0 or higher) is installed on the PC used to run the LxGui program. When selected, the word report file name can be assigned a random number or the user can set the program to prompt for a report name each time a report is generated.

Once the MS704 screen has been opened, the report format selection cannot be changed without closed the MS704 screen first.

Word reports are saved in the ...LxGui\Reports directory and can be printed from MS Word as needed. MS704 reports which are assigned a random sequence number by the LxGui will have a "MS704_XXX_NNNNNN.doc" file name where XXX stands for the selected power group (TAC, SAV, TVF, SVF or SXF) and NNNNNN is a random sequential number.

In addition to the test reports, the LxGui program creates a tab delimited text file during MS704 execution, which logs the voltage and frequency at the AC source output every second. The file is called "MS704_Meas_Log.txt" and is saved in the Reports sub directory. This text file may be opened in Excel for charting or reporting purposes. However, each time a new test is started, the data in this file will be overwritten.

.

11. Error Messages

Any errors that occur during operation from either the front panel or the remote control interface will result in error messages. Error messages are displayed on the LCD display. They are also stored in the error message queue from which they can be queried using the SYST:ERR? Query. The error queue has a finite depth. If more error messages are generated than can be held in the queue, a queue overflow message will be put in the last queue location. To empty the queue, use the error query until the No Error result is received.

Errors appearing on the LCD will generally remain visible until the user moves to another screen. If multiple error messages are generated in succession, only the last message will be visible as there is only space for one error message on the LCD display.

The same area of the display is also used to display status messages. While error messages always have a negative error number, status messages have a positive number.

The table below displays a list of possible error and status messages along with their possible cause and remedy.

Number	Message String	Cause	Remedy
0	"No error"	No errors in queue	
-100	"Command error"	Unable to complete requested operation	Unit may be in a mode inconsistent with request.
-102	"Syntax error"	Command syntax incorrect.	Misspelled or unsupported command
-103	"Invalid separator"	SCPI separator not recognized	See SCPI section of programming manual.
-104	"Data type error"	Data type invaled.	Check command for supported data types
-108	"Parameter not allowed"	One or more additional parameters were received.	Check programming manual for correct number of parameters
-109	"Missing parameter"	Too few parameters received for requested operation	Check programming manual for correct number of parameters
-110	"Command header error"	Command header incorrect	Check syntax of command.
-111	"Header separator error"	Invalid command separator used.	Use semi-colon to separate command headers
-112	"Program mnemonic too long"	Syntax error	Check programming manual for correct command syntax
-113	"Undefined header"	Command not recognized error	Check programming manual for correct command syntax
-120	"Numeric data error"	Data received is not a number	Check programming manual for correct command syntax
-121	"Invalid character in number"	Number received contains non-numeric character(s)	Check programming manual for correct command syntax
-123	"Exponent too large"	Exponent in number exceeds limits	Check programming manual for correct parameter range
-128	"Numeric data not allowed"	Number received when number is not allowed.	Check programming manual for correct command syntax
-168	"Block data not allowed"	Block data was sent.	Check programming manual for

Number	Message String	Cause	Remedy
			correct command syntax
-200	"Execution error"	Command could not be executed	Command may be inconsistent with mode of operation.
-201	"Invalid while in local"	Command issued but unit is not in remote state	Put instrument in remote state before issuing GPIB commands.
-203	"Command protected"	Command is locked out	Some commands are supported by the unit but are locked out for protection of settings and are not user accessible.
-210	"Trigger error"	Problem with trigger system.	Unit could not generate trigger for transient execution or measurement.
-211	"Trigger ignored"	Trigger request has been ignored.	Trigger setup incorrect or unit was not armed when trigger was received. Check transient system or measurement trigger system settings.
-213	"Init ignored"	Initialization request has been ignored	Unit was told to go to armed state but was unable to do so. Could be caused by incorrect transient system or measurement acquisition setup.
-220	"Parameter error"	Parameter not allowed.	Incorrect parameter or parameter value. Check programming manual for allowable parameters
-221	"Setting conflict"	Transient programmed with more than 1 mode.	Check other settings. E.g. Redefine transient mode. As result of *TST? execution, indicates ALC mode is off or waveform not set to Sine.
-222	"Data out of range"	Parameter data outside of allowable range.	Check programming manual for allowable parameter values
-223	"Too much data"	More data received than expected	Check programming manual for number of parameters or data block size
-224	"Illegal parameter value"	Parameter value is not supported	Check programming manual for correct parameters
-226	"Lists not same length"	One or more transient lists programmed has different length.	All lists must be of same length or transient cannot be compiled and executed.
-241	"Hardware missing"	N/A	N/A
-254	"Media full"	No storage space left to save settings or data.	Delete other settings or data to make room.
-255	"Directory full"	Too many waveform directory entries	Delete one or more waveforms from waveform memory to make room.
-256	"File name not found"	Waveform requested not in directory	Check waveform directory for waveform names present.
-257	"File name error"	Incorrect filename	Too many or non ASCII characters used in waveform file definition.
-283	"Illegal variable name"	Variable name illegal.	Use ASCII characters only
-300	"Device specific error"	Hardware related	Check hardware for proper operation.

Number	Message String	Cause	Remedy
		error	
-311	"Memory error"	Waveform memory checksum error.	May be the result of incomplete user-defined waveform download. Check interface and try downloading waveform again. Successful download may clear this error condition. Alternatively, use TRAC:DEL:ALL command to clear waveform memory.
-314	"Save/recall memory lost"	User setup register contents lost	Store setup in same register again.
-315	"Configuration memory lost"	Hardware configuration settings lost.	Contact CI service department at support@calinst.com to obtain instructions on restoring configuration data.
-330	"Self-test failed"	Internal error	Contact CI service department at support@calinst.com
-350	"Queue overflow"	Message queue full.	Too many message. Read status using SYST:ERR query until 0, "No Error" is received indicating queue empty.
-400	"Query error"	Unable to complete query.	Check programming manual for correct query format and parameters
-410	"Query INTERRUPTED"	Query issued but response not read.	Check application program for correct flow. Response must be read after each query to avoid this error.
-420	"Query UNTERMINATED"	Query incomplete.	Check for terminator after query command.
-430	"Query DEADLOCKED"	Query cannot be completed	Check application program for multiple queries
-440	"Query UNTERMINATED"	Query incomplete.	Check for terminator after query command.
0	"No error"	No errors in queue	
2	" Non-volatile RAM CONFIG section checksum failed"	Controller failure during Self-test.	Contact CI service department at support@calinst.com
3	" Non-volatile RAM CAL section checksum failed"	Controller failure during Self-test.	Contact CI service department at support@calinst.com
4	" Non-volatile RAM WAVEFORM section checksum failed"	Controller failure during Self-test.	Contact CI service department at support@calinst.com
10	"Ram self test	Controller failure during Self-test.	Contact CI service department at support@calinst.com
40	"Voltage self test error, output 1	No. 1/A amplifier in Master source has no output during Self-test.	Contact CI service department at support@calinst.com
41	"Voltage self test error, output 2	No. 2/B amplifier in Master source has no output during Self-test	Contact CI service department at support@calinst.com
42	"Voltage self test error,	No. 3/C amplifier in	Contact CI service department at

Number	Message String	Cause	Remedy
	output 3	Master source has no output during Self-test	support@calinst.com
43	"Current self test error, output 1	No. 1/A amplifier in Aux. Source has no output during Self-test.	Contact CI service department at support@calinst.com
44	"Current self test error, output 2	No. 2/B amplifier in Aux. Source has no output during Self-test.	Contact CI service department at support@calinst.com
45	"Current self test error, output 3	No. 3/C amplifier in Aux. Source has no output during Self-test.	Contact CI service department at support@calinst.com
216	" RS-232 receiver framing error"	Communication failure.	Check RS232 port settings and cable.
217	" RS-232 receiver parity error"	Communication failure.	Check RS232 port settings and cable.
218	" RS-232 receiver overrun error"	Communication failure.	Check RS232 port settings and cable.
402	"CAL password is incorrect"	Calibration password does not equal high voltage range value.	Re-enter correct password.
403	"CAL not enabled"	No password entered for calibration	Enter correct CAL password.
600	"Systems in mode:list have different list lengths"	Transient lists have unequal lengths	Check list settings and correct to same no of data points.
601	"Requested voltage and waveform exceeds peak voltage capability"	Wave shape selected and RMS voltage combine to exceed peak voltage capability.	Reduce RMS or crest factor of wave shape.
602	"Requested voltage and waveform exceeds transformer volt-second rating"	The selected wave shape exceeds output transformer capability.	The volt-second product of the wave form (magnitude and time in the + and – half of wave form).
603	"Command only applies to RS-232 interface"	Command not relevant for GPIB interface.	Do not use command.
604	"Trigger received before requested number of pre-trigger readings"	Data acquisition pre-trigger buffer not filled yet.	Hold off trigger or reduce pre-trigger delay.
605	"Requested RMS current too high for voltage range"	Max RMS current is function of voltage range selected.	Reduce programmed RMS current limit or select low voltage range.
606	"Waveform data not defined"	No waveform name specified	Specify waveform name before sending waveform data.
607	"VOLT,VOLT:SLEW, and FUNC:SHAPE modes incompatible"	Conflict between wave shape and programmed slew	Reduce slew or change waveform type.
608	"Measurement overrange"	Measurement data	

Number	Message String	Cause	Remedy
		out of range.	
609	"Output buffer overrun"	Too much data in output buffer.	Check receive mode on application program. Program is not reading data sent by AC source.
610	"Command cannot be given with present SYST:CONF setting"	Command conflicts with available hardware or firmware option settings.	Check configuration for available options and features.
801	"Output volt fault"	- Output voltage does not match program value when ALC is on. - Over load - Voltage kick-back - No output voltage	Load exceeds current limit and unit is in Constant Voltage (CV) mode of operation. - Reduce load or increase CL setting. Output voltage is driven above programmed voltage by external influence (Load, voltage kickback, etc.)
802	"Current limit fault"	Current limit exceeded.	Load exceeds current limit and unit is in Constant Voltage (CV) mode of operation. Reduce load or increase CL setting
803	"Temperature fault"	Amplifier heat sink temp. too high.	Reduce load. Ensure proper air flow and exhaust clearance. Check fan(s) for operation.
804	"External sync error"	Could not sync to external sync signal.	External sync signal missing, disconnected or out of range.
805	"Initial memory lost"	Initial settings could not be recalled at power-up.	Save power on settings again to overwrite old content.
806	"Limit memory lost"	Hardware configuration settings could not be recalled at power-up.	Contact CI service department at support@calinst.com to obtain instructions on restoring configuration data.
807	"System memory lost"	Memory corrupted during power-up.	Recycle power.
808	"Calibration memory lost"	Calibration data lost during power-up.	Contact CI service department at support@calinst.com to obtain instructions on restoring calibration data or recalibrate unit.
813	"Missing list parameter"	One or more transient list parameters missing.	Check programmed lists.
814	"Voltage peak error "	Peak voltage exceeds internal bus voltage	This error may occur when selecting user defined wave shapes with higher crest factors. Reduce programmed RMS value.
815	"Slew time exceed dwell"	Time needed to slew to final value is less than dwell time.	Check dwell times in transient list settings. Increase dwell time or change slew rate for affected parameter.
816	"Illegal during transient"	Operation requested not available while transient is running.	Wait till transient execution is completed or abort transient execution first.
817	"Output relay must be closed"	Transient programmed with	Close relay before attempting transient operation.

Number	Message String	Cause	Remedy
		output relay open.	
819	"Clock and sync must be internal"	Operation not possible with external clock	Switch to internal sync. (Default)
820	"Input buffer full"	Too much data received.	Break up data in smaller blocks.
821	"Amplifier unbalance"	Hardware error. An amplifier has an overload condition.	Check amplifier balance adjustment. If error persists contact CI service at support@calinst.com .
822	"Waveform harmonics limit"	Harmonic contents of user defined wave shape is too high and could damage amplifier output stage.	Reduce harmonic content or reduce fundamental frequency programmed.
823	"Amplifier fault"	An amplifier failure. Can be reported at any time.	Determine which amplifier is at fault with self-test or checking LED on Relay Board. Replace amplifier.
824	"Auxiliary down"	One or more auxiliary units is not powered up or not working.	Turn on all auxiliary units.
825	"Over voltage prot trip"	Over voltage detected on output	Check output voltage for correct RMS value.
826	"Peak current prot trip"	Peak current limit exceeded.	Peak current exceeded. Could be caused by switching EUT on or off.
827	"Frequency error"	Frequency error during self-test.	Correct frequency was not measured during self-test. May be result of 801 error.
828	"Phase error"	Self test error phase angle	Correct phase angle was not measured during self-test. May be result of 801 error.
829	"Dc component exceed limit"	Too much DC content in loaded ARB waveform.	Check waveform programming.

Table 11-1: Error Messages

12. Index

A

Acoustic Noise.....	23
address	
GPIB	75
IEEE	75
Airbus	
DO160.....	113
ALC	
state	67
APE command language	31
Arbitrary waveforms	
Frequency response restrictions.....	85
arrow keys	57

B

Back key	58
baud rate	75
blinking	
parameter entry.....	57
bus address	
setting	75

C

calibration	
password.....	96
Calibration password	77
circuit breaker	55
Clock and lock mode	53
clock mode	66
Construction	
internal	23
controller assembly.....	94
Controllers	
programable.....	25
Cooling	23
Copyright	2
current limit.....	94
custom waveforms	84
creating	84
deleting	84
downloading.....	84

D

Dimensions	23
Distorted output	104
DO160	
Airbus.....	113
Option	109

E

Efficiency.....	13
Enter key	58

error messages.....	190
Ext. Trig	25

F

factory	
default power on setting	92
Fault Indicator	47
Finish	
paint	23
Frequency Range	16, 17
front panel	55
lock.....	56, 58
Function Strobe	25, 47
Functional Test	50

H

Hold-Up Time	13
--------------------	----

I

IEEE-488	22
impedance	
output	67
programmable	67
Inhibit.....	47
initialization	
changing.....	92
Input	
AC	39
Inrush Current	13
installation	36
Introduction	10
Isolation Voltage.....	13

K

Keys	
Menu	58
knob	57

L

LCD	
viewing angle.....	77
LCD display.....	60
LED	103
LED indicators.....	103
Line Current:	12
Line Frequency	13
Line VA:.....	12
list transient.....	88
LOCAL key.....	58

M

maintenance	103
Material	

chassis	23	replacement parts	107
-MB Option	52	RS232C	22
Meas key	58	S	
Menu key	58	self-test	61
Menu keys	58	sense	103
MIL-STD 704		wiring	40
Option	124, 133	Set key	58
MS704		SET mode	57
Execution	188	setting	
Reports	189	baud rate	75
Multi-box option	52	GPIB address	75
N		Shock	24
Noise	14, 28, 33	Short Circuit	
O		current	22
Offset Voltage		shuttle	57
DC	14	SET mode	57
Options		Shuttle	
-160	109	IMMEDIATE mode	57
-704	124, 133	status	56
oscillator	94	step transient	87
output		T	
frequency	64	temperature	
impedance	67	over	56
on/off key	59	Temperature	
voltage	64	operating, storage	23
Output Coupling	14	Three phase	94
Output Impedance	14	top cover	
output relays	59	removal	106
Overcurrent	22	transient	
overload	56	execution	91
Overtemperature	22	Transient list	
P		execution	71
Parallel	25	transients	
password		list	88
calibration	96	pulse	88
Password		step	87
Calibration	77	switching waveforms	90
Phase		Transients	
key	59	Front panel data entry	73
phase angle	65	Input	22
Power Factor	13	Trigger	
power on screens	61	input SMA	22
power-on setting	74	troubleshooting	103
Programming manual	11	U	
pulse transient	88	UP key	59
R		V	
Regulation	67	Vibration	24
Relay		viewing angle	24
output	25	adjustment	77
remote control	56	voltage drop	
Remote Inhibit	45, 93	cables	39, 40
Remote Shutdown	46, 47	voltage rating	36

W

Weight23
Wiring

AC input..... 39