

**MXCTSL  
Compliance Test System  
User Manual**

TEL: +1 (858) 450-0085  
FAX: +1 (858) 458-0267  
Email: [sales.ppd@ametek.com](mailto:sales.ppd@ametek.com)  
Web Site: <http://www.programablepower.com>

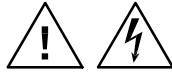

## SAFETY SUMMARY

These power system components contain high voltage and current circuits that are potentially lethal. The following safety guidelines must be followed when operating or servicing this equipment. These guidelines are not a substitute for vigilance and common sense. California Instruments assumes no liability for the customer's failure to comply with these requirements.

### APPLYING POWER AND GROUNDING

Verify the correct voltage is applied to the equipment.

Verify that the input power cord to the PACS-X unit is plugged into a properly grounded utility outlet.

Verify that the input power line to the AC power source used is connected to a properly grounded utility outlet.

### FUSES

Use only fuses of the specified current, voltage, and protection speed.

Do not short out the fuse holder or use a repaired fuse.

The PACS-3-75 unit uses a North-American ferrule type input fuse rated at 0.5A and 250Volts. (Fast Acting)

### DO NOT OPERATE IN A VOLATILE ATMOSPHERE

Do not operate the system in the presence of flammable gases or fumes.

### DO NOT TOUCH ENERGIZED CIRCUITS

Disconnect power cables before servicing this equipment. Even with the power cable disconnected, high voltage can still exist on some circuits. Discharge these voltages before servicing. Only qualified service personnel may remove covers, replace components or make adjustments.

### DO NOT SERVICE ALONE

Do not remove covers, replace components, or make adjustments unless another person, who can administer first aid, is present.

### DO NOT EXCEED INPUT RATINGS

Do not exceed the rated input voltage or frequency. Additional hazards may be introduced because of component failure or improper operation.

### DO NOT MODIFY INSTRUMENT OR SUBSTITUTE PARTS

Do not modify these instruments or substitute parts. Additional hazards may be introduced because of component failure or improper operation.

### MOVING THE POWER SOURCE

When moving the power source, observe the following:

1. Remove all AC power to system components.
2. Use two people to prevent injury.

## CTSMXL Software License

---

Your MX Series CTSL Test System was shipped with one copy of the CTSMXL Software. This software - model number CIC 652 - is owned by California Instruments and is protected by United States copyright laws and international treaty provisions. Therefore, you must treat the software like any other copyrighted material.

## Software Revisions

---

Revision codes in the Help About screen of the CTSMXL Software indicate the current revision. Minor changes to the software such as bug fixes usually do not require a change to the manual. Therefore, the revision number of the software you received with the CTS system may be higher than the software revision number shown below. In this case, the information in the manual still applies.

Software changes that require a manual change will be accompanied either by a new edition of the manual or an errata sheet documenting the changes.

This manual applies to software revision 2.9.0 (revision 1.3.0.0 includes the higher speed A/D card from Exacq Technologies). If you are using a software revision less than 2.9.0, contact [ci.ppd@ametek.com](mailto:ci.ppd@ametek.com) for upgrade information. The CTS software revisions can be shown by selecting the Help, About screen.

CTSMXL software revision 2.9.0 or higher supports only the National Instruments M Series cards (PCI-6220, PCI-6250).

## Printing History

The manual printing date indicates the current edition. The printing date changes with each new edition or update. Update packets or change sheets may be issued between editions to correct or add information. Minor corrections incorporated at reprint do not cause a new edition.

December 2015 Revision K

## Trademarks

---

AMETEK is a registered trademark of AMETEK, Inc. California Instruments is a trademark owned by AMETEK, Inc. Other trademarks, registered trademarks, and product names are the property of their respective owners and are used herein for identification purposes only.

Windows 7™, Windows XP™, MS Word™, and MS Excel™ are registered trademarks of Microsoft Corporation.

---

### Contacting AMETEK Programmable Power

---

To contact AMETEK Programmable Power, use any of the communication channels listed here:

Mail:	AMETEK Programmable Power 9250 Brown Deer Road San Diego, CA 92121 USA	
Phone:	858 450 0085	7:00 AM - 4:00 PM Pacific Standard Time
	Voice Mail 24 hours	
Fax:	858 458-0267	
Email:	ci.ppd@ametek.com	
Web site:	<a href="http://www.programmablepower.com/brands">www.programmablepower.com/brands</a>	

## WARRANTY INFORMATION

AMETEK PROGRAMMABLE POWER warrants each instrument manufactured by them to be free from defects in material and workmanship for a period of one year from the date of shipment to the original purchaser. Excepted from this warranty are fuses and batteries that carry the warranty of their original manufacturer where applicable. AMETEK PROGRAMMABLE POWER will service, replace, or adjust any defective part or parts, free of charge, when the instrument is returned freight prepaid, and when examination reveals that the fault has not occurred because of misuse, abnormal conditions of operation, user modification, or attempted user repair. Equipment repaired beyond the effective date of warranty or when abnormal usage has occurred will be charged at applicable rates. AMETEK PROGRAMMABLE POWER will submit an estimate for such charges before commencing repair, if so requested.

## SERVICE PROCEDURE

If a fault develops, notify AMETEK PROGRAMMABLE POWER at [repair.ppd@ametek.com](mailto:repair.ppd@ametek.com) or its local representative, giving full details of the difficulty, including the model number and serial number. On receipt of this information, service information or a Return Material Authorization (RMA) number will be given. Add the RMA number furnished to the shipping label. Pack the instrument carefully to prevent transportation damage, affix label to shipping container, and ship freight prepaid to the factory. AMETEK PROGRAMMABLE POWER shall not be responsible for repair of damage due to improper handling or packing.

Instruments returned without RMA No. or freight collect may be refused at AMETEK Programmable Power discretion. Instruments repaired under Warranty will be returned either via prepaid surface freight or low cost airfreight at AMETEK Programmable Power discretion. Instruments repaired outside the Warranty period will be returned freight collect,

If requested, an estimate of repair charges will be made before work begins on repairs not covered by the Warranty.

## DAMAGE IN TRANSIT

The instrument should be tested when it is received. If it fails to operate properly, or is damaged in any way, a claim should be filed immediately with the carrier. The claim agent should obtain a full report of the damage, and a copy of this report should be forwarded to us by fax or email (Fax: 858 677 0940, Email: [repair.ppd@ametek.com](mailto:repair.ppd@ametek.com)). AMETEK PROGRAMMABLE POWER will prepare an estimate of repair cost and repair the instrument when authorized by the claim agent. Please include model number and serial number when referring to the instrument.

## SPARE PARTS

To order spare parts, user manuals, or determine the correct replacement part for your California Instruments products, please contact the Customer Service department by phone at + 1 858 450 0085, press 2 or by email [repair.ppd@ametek.com](mailto:repair.ppd@ametek.com).

## LIMITATION OF WARRANTY

AMETEK Programmable Power believes the information contained in this manual is accurate. This document has been carefully reviewed for technical accuracy. In the event that technical or typographical errors exist, AMETEK Programmable Power reserves the right to make changes to subsequent editions of this document without prior notice to holders of this edition. The reader should consult AMETEK Programmable Power if errors are suspected. In no event shall AMETEK Programmable Power be liable for any damages arising out of or related to this document or the information contained in it.

AMETEK PROGRAMMABLE POWER PROVIDES NO WARRANTIES, EXPRESS OR IMPLIED, AND SPECIFICALLY DISCLAIMS ANY WARRANTY OF MERCHANTABILITY OR FITNESS FOR A PARTICULAR PURPOSE OF THIS SOFTWARE AND DOCUMENTATION. AMETEK PROGRAMMABLE POWER WILL NOT BE LIABLE FOR DAMAGES RESULTING FROM LOSS OF DATA, PROFITS, USE OF PRODUCTS, OR INCIDENTAL OR CONSEQUENTIAL DAMAGES, EVEN IF ADVISED OF THE POSSIBILITY THEREOF.

This limitation of liability of AMETEK Programmable Power will apply regardless of the form of action, whether in contract or tort, including negligence. The warranty provided herein does not cover damages, defects, malfunctions, or service failures caused by owner's failure to follow AMETEK Programmable Power' installation, operation, or maintenance instructions; owner's modification of the product; owner's abuse, misuse, or negligent acts; and power failures, surges, fire, flood, accident, actions of third parties, or other events outside reasonable control.

SOME STATES DO NOT ALLOW LIMITATIONS ON THE LENGTH OF AN IMPLIED WARRANTY OR THE EXCLUSION OR LIMITATION OF INCIDENTAL OR CONSEQUENTIAL DAMAGES, SO THE ABOVE LIMITATION OR EXCLUSIONS MAY NOT APPLY TO YOU. THIS WARRANTY GIVES YOU SPECIFIC LEGAL RIGHTS, AND YOU MAY ALSO HAVE OTHER RIGHTS WHICH VARY FROM STATE TO STATE.

If any part of this Agreement shall be determined by a court to be invalid, illegal or unenforceable, the remaining provisions shall in no way be affected or impaired thereby.

GOVERNING LAW. This Agreement and Limited Warranty are governed by the laws of the state of California without regard to conflict of law provisions.

INSTALLATION AND / OR USE OF THIS PROGRAM CONSTITUTES ACCEPTANCE OF THESE TERMS AND RESTRICTIONS BY THE USER.

### © 1997 - 2015 COPYRIGHT

Under the copyright laws, this publication may not be reproduced or transmitted in any form, electronic or mechanical, including photocopying, recording, storing in an information retrieval system, or translating, in whole or in part, without the prior written consent of AMETEK Programmable Power.

AMETEK Programmable Power, © 1997 - 2015

### **Warning regarding Medical and Clinical use of AMETEK Programmable Power products.**

AMETEK Programmable Power products are not designed with components and testing intended to ensure a level of reliability suitable for use in the treatment and diagnosis of human beings. AMETEK Programmable Power products are NOT intended to be used to monitor or safeguard human health and safety in medical or clinical treatment and AMETEK Programmable Power assumes no responsibility for this type of use of its products or software.

## Table of Contents

1.	Introduction.....	11
1.1	Manual Organization.....	11
1.2	Compliance Test System Description.....	12
2.	IEC Testing.....	15
2.1	About This Chapter.....	15
2.2	The EMC Directive.....	15
2.3	The EN 61000-3-2:2000 Standard.....	16
2.4	The EN 61000-3-2:1998 Standard.....	19
2.5	EN 61000-3-3 Flicker.....	21
2.6	EN 61000-4-11p Voltage Dips and Variations.....	22
2.7	EN 61000-4-13 Interharmonics and Harmonics Immunity Test.....	23
2.8	EN 61000-4-14 Voltage Fluctuations.....	24
2.9	EN 61000-4-17 DC Ripple.....	24
2.10	EN 61000-4-27p Three Phase Voltage Unbalance.....	25
2.11	EN 61000-4-28 Voltage Frequency Variations.....	25
2.12	EN 61000-4-29p DC Voltage Dips, Interruptions and Variations.....	25
2.13	References.....	26
3.	System Installation.....	27
3.1	About This Chapter.....	27
3.2	Hardware Installation.....	27
3.3	PC Requirements.....	28
3.4	OMNI-3-37MX Unit.....	29
3.5	OMNI-3-37MX Unit.....	32
3.6	PACS-3-75 Unit.....	41
3.7	Functional Test.....	46
3.8	Data Acquisition Card Installation - PCI Card Version.....	47
3.9	CTSMXL Software Installation.....	56
3.10	AC Source Control Software Installation.....	58
4.	Program Menus.....	59
4.1	About this Chapter.....	59
4.2	Main Menu.....	59
4.3	File Menu.....	59
4.4	Edit Menu.....	60
4.5	View Menu.....	61
4.6	Options Menu.....	61
4.7	Test Menu.....	62
5.	Harmonics Testing.....	63
5.1	About This Chapter.....	63
5.2	Test Standard Selection.....	63
5.3	Device Classes.....	63
5.4	Stationary or Transitory Harmonics Test.....	66
5.5	Running a Harmonics Test.....	67
5.6	Additional Setup Parameters for Harmonics.....	69
5.7	Main Harmonics Test Window Operation.....	71
5.8	Running the Harmonics Test.....	74
5.9	Printing Results.....	76
5.10	Harmonics Test Data Files.....	77
5.11	Three Phase Testing.....	77
5.12	Replay Mode.....	77
6.	Flicker Testing.....	80
6.1	About This Chapter.....	80
6.2	Principle of Operation.....	80
6.3	Running a Flicker Test.....	80
6.4	Printing Test Reports.....	84
6.5	Flicker Replay Mode.....	85

7.	EN 61000-4-11p Voltage Dips and Variations (Pre-compliance).....	88
7.1	About This Chapter.....	88
7.2	Standard Revisions and EUT Classes.....	88
7.3	Compliance Statement.....	89
7.4	Specifying test sequences for Dips and Variations.....	90
7.5	Test Setup.....	91
7.6	Test Options.....	92
7.7	Test Results.....	92
7.8	Report Format- 411 Test Files.....	92
8.	EN 61000-4-13 Harmonics and Inter harmonics Immunity Test.....	93
8.1	About this Chapter.....	93
8.2	Tab Controls.....	94
8.3	Test Setup.....	95
8.4	Test Sequence.....	95
8.5	Test Results.....	99
8.6	Measurements.....	100
8.7	EN 61000-4-13 Test Reports.....	100
9.	EN 61000-4-14 Voltage Fluctuations Immunity Testing.....	101
9.1	About This Chapter.....	101
9.2	Test Setup.....	102
9.3	Test Sequence.....	103
9.4	Test Levels.....	104
9.5	Voltage Fluctuation.....	105
9.6	Test Execution.....	106
9.7	Test Parameter File Creation and Limits.....	106
9.8	Test Results.....	106
9.9	Report Format- 414 Test Files.....	106
10.	EN 61000-4-17 DC Ripple Immunity Testing.....	108
10.1	About This Chapter.....	108
10.2	Test Setup.....	109
10.3	Test Sequence.....	109
10.4	Waveform Display.....	110
10.5	Test Results.....	110
10.6	User Observations.....	111
10.7	Report Format- 417 Test Files.....	111
10.8	Saving and Loading Test Setups.....	111
11.	EN 61000-4-27p Voltage Unbalance Immunity Testing.....	112
11.1	About This Chapter.....	112
11.2	Test Setup.....	113
11.3	Equipment Classifications.....	114
11.4	Test Levels.....	114
11.5	Waveform Display Tab.....	115
11.6	Operator Observations Tab.....	115
11.7	Source Regulation.....	115
11.8	Test execution.....	115
11.9	Test Implementation and Test Sequence.....	116
11.10	Test Reports.....	116
12.	EN 61000-4-28 Frequency Variations Immunity Testing.....	117
12.1	About This Chapter.....	117
12.2	Test Setup.....	118
12.3	Test Sequence.....	119
12.4	Test Levels.....	120
12.5	Test Options.....	120
12.6	Test Results.....	121
12.7	Test Reports.....	121



13.	EN 61000-4-29p DC Dips and Interruptions Immunity Test (Pre-compliance).....	122
13.1	Test Setup .....	123
13.2	Setting nominal values .....	124
13.3	Test sequence .....	124
13.4	Test Options.....	125
13.5	Test Execution .....	125
13.6	Test Results.....	125
13.7	EN 61000-4-29 Test Reports .....	126
13.8	Source Requirements.....	127
14.	Customizing EN 61000-4-13 Test Parameters .....	128
14.1	About This Chapter .....	128
14.2	Sample File IEC413.413 .....	129
15.	Specifications .....	131
15.1	About This Chapter .....	131
15.2	PACS-3-75 Measurement Specifications .....	131
15.3	PACS-3-75 General Specifications.....	133
15.4	PACS-3-75 Environmental .....	134
15.5	PACS-3-75 Regulatory.....	134
15.6	Flicker Reference Impedances.....	135
15.7	OMNI-3-37MX Specifications .....	135
15.8	OMNI-3-37MX Environmental .....	136
15.9	OMNI-3-37MX Regulatory .....	136
16.	Configuration Options .....	137
16.1	About this Chapter .....	137
16.2	Accessing the Calibration and Configuration Database.....	137
17.	Calibration .....	140
17.1	About This Chapter .....	140
17.2	Calibration .....	140
17.3	Install A/D Card in PC .....	141
17.4	PACS-3-75 Calibration Setup.....	141
17.5	Configuration Procedure .....	141
17.6	Installing New CTSMXL Calibration Data .....	144
18.	Principle Of Operation.....	145
18.1	General .....	145
18.2	AC Power.....	145
18.3	PACS-3-75 Measurement Unit.....	145
18.4	OMNI-3-37MX Impedance .....	145
18.5	CTSMXL Software .....	145
19.	Service .....	147
19.1	Cleaning.....	147
19.2	General .....	147
19.3	Basic Operation.....	147
19.4	Advanced Troubleshooting.....	150
	Index.....	152

## List of Figures

Figure 3-1: MX30-3Pi-CTSH and MX45-3Pi-CTSH with OMNI-3-75 Wiring Diagram – Version 2 .....	33
Figure 3-2: MX60-3Pi-CTSH and MX90-3Pi-CTSH with OMNI-3-75 Wiring Diagram – Version 2 .....	34
Figure 3-3: MX30-3Pi-CTSL and MX45-3Pi-CTSL with OMNI-3-37MX Wiring Diagram.....	35
Figure 3-4: MX60-3Pi-CTSL and MX90-3Pi-CTSL with OMNI-3-37MX Wiring Diagram.....	36
Figure 3-5: MX30-3Pi-CTSHL and MX45-3Pi-CTSHL with dual OMNI's Wiring Diagram – Version 2. ....	37
Figure 3-6: MX60-3Pi-CTSHL and MX90-3Pi-CTSHL with dual OMNI's Wiring Diagram. ....	38
Figure 3-7: MX30-3Pi-CTSH and MX45-3Pi-CTSH with OMNI-3-75 Wiring Diagram - version 1 .....	39
Figure 3-8: MX30-3Pi-CTSHL and MX45-3Pi-CTSHL with dual OMNI's Wiring diagram – version 1 .....	40
Figure 3-9: EUT Connection distance and wire gauge .....	42
Figure 3-10: Power Connections for PACS-3-75.....	44
Figure 3-11: Front and Rear Panel Views of the PACS-3-75 Module. ....	45
Figure 3-12: Exacq Control Center Screen. ....	51
Figure 3-13: Exacq Card Device Number.....	52
Figure 3-14: Exacq Test Panel.....	53
Figure 3-15: Exacq DMM Screen. ....	54
Figure 3-16: Exacq Scope Test Panel.....	55
Figure 5-1: Class D Current Wave Shape Template .....	64
Figure 5-2: EUT Class Determination Flowchart .....	65
Figure 5-3: Typical Class A test setup.....	67
Figure 5-4: Additional Settings for Harmonics Test.....	69
Figure 5-5: Harmonics Test Window .....	71
Figure 6-1: Flicker Test Window .....	81
Figure 7-1: EN 61000-4-11 Test Window .....	88
Figure 7-2: EN 61000-4-11 Voltage Variation specification .....	90
Figure 7-3: EN 61000-4-11 Voltage Variation specification – Edition 2.0. ....	90
Figure 8-1: EN 61000-4-13 Test Window .....	93
Figure 8-2: EN 61000-4-13 Flow Chart, Class 1 and 2 EUT's. ....	96
Figure 8-3: EN 61000-4-13 Flow Chart, Class 3 EUT.....	97
Figure 9-1: EN 61000-4-14 Test Window .....	101
Figure 9-2: EN 61000-4-14 Test Sequence.....	103
Figure 10-1: EN 61000-4-17 Test Window .....	108
Figure 10-2: EN 61000-4-17 Waveform Acquisition Window.....	110
Figure 10-3: EN 61000-4-17 User Observation Data Entry Window.....	111
Figure 11-1: EN 61000-4-27 Test Window .....	112
Figure 12-1: EN 61000-4-28 Test Window .....	117
Figure 12-2: EN 61000-4-28 Test Sequence.....	119
Figure 13-1: EN 61000-4-29 Test Window .....	122
Figure 17-1 : CTSMXL Calibration Program Main Screen.....	141
Figure 17-2: Three Phase Calibration Setup .....	143
Figure 19-1: Location of AC Sensor Assy. 5004-700 in PACS-3-75 .....	149

## List of Tables

Table 2-1: EN 61000-3-2 Class Limits .....	17
Table 2-2: Harmonics Amendment 14 Test Times.....	18
Table 2-3: EN 61000-3-2 Class Descriptions .....	20
Table 2-4: Average public utility disturbances per annum in Europe.....	23
Table 3-1: PC Pentium/Athlon Processor Clock Speed Requirement .....	28
Table 5-1: IEC Harmonics Setup Parameters .....	68
Table 5-2: IEC Harmonics Advanced Setup Parameters .....	70
Table 5-3: IEC Harmonics Replay Settings.....	79
Table 6-1: IEC Flicker Replay Settings .....	87
Table 17-1: Required Calibration Equipment .....	140

## 1. Introduction

---

### 1.1 Manual Organization

This manual describes the operation of the California Instruments Compliance Test System Software when used in conjunction with the CTS hardware. Its primary function is as a reference manual. If you have a question about a specific screen or how to perform a certain task, turn to the appropriate section of the manual. The manual is organized in accordance with the normal test procedure you would follow when testing for IEC compliance.

Some assumptions were made when producing this documentation. Specifically, it is assumed that you are familiar with the EN 61000-3-2 and EN 61000-3-3 standards and their requirements. Some background information on the IEC standards covered by the CTS system is included in chapter 2. This information is subject to change however as standards do change. We recommend you stay current with evolving test standards and regulations. Furthermore, it is also assumed that you are familiar with operating a personal computer under the Microsoft Windows™ environment.

The manual is organized as follows:

- Chapter 1** describes the organization of the user manual and provides a brief overview of the CTS system components.
- Chapter 2** provides an overview of the relevant IEC regulations and how compliance testing to these regulations is implemented in the CTSMXL Software.
- Chapter 3** covers installation of the hardware and software components required to operate the CTS system. Proper installation of both hardware and software is essential. This chapter walks the user through the hardware setup and the software installation, process one step at a time.
- Chapter 4** Overview of the program's menu structure
- Chapter 5** covers EN 61000-3-2 harmonics testing. This chapter provides step by step instructions on how to set up the correct test mode and perform the necessary steps to perform a quasi-stationary or transitory Harmonics test on the EUT.
- Chapter 6** covers EN 61000-3-3 Voltage fluctuations testing. This chapter provides step by step instructions on running a voltage fluctuation or flicker test.
- Chapter 7** covers EN 61000-4-11p Voltage Dips and Variations immunity testing.
- Chapter 8** covers EN 61000-4-13 standard Voltage Fluctuations immunity testing. [Draft version]
- Chapter 9** covers EN 61000-4-14 standard Voltage Fluctuations immunity testing.
- Chapter 10** covers EN 61000-4-17 standard DC Ripple immunity testing.
- Chapter 11** covers EN 61000-4-27p standard Voltage Unbalance immunity testing.
- Chapter 12** covers EN 61000-4-28 standard Frequency Variations immunity testing.
- Chapter 13** covers EN 61000-4-29p DC Voltage dips and Variations immunity testing.
- Chapter 14** covers EN 61000-4 customization to allow for future revisions of these standards and to accommodate different product categories.

**Chapter 15** provides the technical specifications for the Power Analysis and Conditioning System (PACS) unit, which is a key component of the CTS system. For technical specifications on the AC source supplied with the CTS system, refer to the AC source manual provided.

**Chapter 16** overview of available configuration options.

**Chapter 17** overview of calibration procedures

**Chapter 18** provides theory of operation information.

**Chapter 19** provides service and troubleshooting procedures.

## 1.2 Compliance Test System Description

The California Instruments Compliance Test System is a complete IEC AC power test system that covers many of the IEC regulatory test standards involving AC and/or DC powered equipment.

To ensure maximum flexibility of both the hardware and the software required to create a turn-key system, the CTS system uses a modular structure consisting of the following components:

- Programmable MX Series AC power source. The AC source provides AC power at the user specified frequency and voltage. The MX Series AC source also offers over current protection to avoid damaging a load that exhibits a failure. The MX power source is a three-phase unit.

The following power source configurations are currently supported on MX-CTSH systems:

- MX30-3Pi-CTSL
- MX45-3Pi-CTSL
- MX60-3Pi/2-CTSL      Two cabinet MX master/auxiliary power source.
- MX90-3Pi/2-CTSL      Two cabinet MX master/auxiliary power source.

This user manual generally refers to the power source as a MX45-3Pi model as it is most common. Where relevant, the other power source system configurations will be covered specifically. In general, operation of the MXCTSL system is the same for any of these four configurations.

- Power Analysis and Conditioning System unit. The PACS-3-75 unit creates the electrical and mechanical interface between the AC source, the Equipment Under Test (EUT) and the PC based data acquisition system. It provides the necessary signal conditioning and isolation for the acquisition system.
- PC Based data acquisition system. The data acquisition system uses a fast Analog to Digital conversion card that plugs into an available card slot in the user's PC. The CTSMXL Software controls all aspects of the A/D card and processes the data for IEC test purposes.
- CTSMXL Software. The CTSMXL Software implements the harmonics and flicker IEC tests. In addition to the CTSMXL Software, the California Instruments MXGUI program is used to control the AC and DC source used and to implement those IEC tests that run on the AC source, specifically the EN 61000-4 immunity tests.

The AC source output is connected to AC input terminal at the rear of the PACS-3-75 unit. The PACS-3-75 AC output rear terminals are used to connect the EUT. All user interactions with the CTS system are accomplished through the CTSMXL and MXGUI software. There are virtually no front panel controls required to operate the CTS system.

### 1.2.1 AC Source Models

The MXCTS system is supplied with one the following MX Series programmable AC power sources:

- MX30-3Pi-CTSL
- MX45-3Pi-CTSL
- MX60-3Pi/2-CTSL      Two cabinet MX master/auxiliary power source.
- MX90-3Pi/2-CTSL      Two cabinet MX master/auxiliary power source.

No other MX Series power source models are supported by the CTSMXL Software. This user manual generally refers to the power source as a MX45-3Pi model as it is most common. Where relevant, the other power source system configurations will be covered specifically. In general, operation of the MXCTSH system is the same for any of these four configurations.

---

**Note:** The MXCTS systems are rated for a maximum current of 75 amps rms per phase. Damage to the standard PACS-3-75 units can occur if higher currents are present. Care must be taken to not exceed this rating when using the system directly with the utility line or with the higher power sources.

---

### 1.2.2 PACS-3-75 Unit

The Power Analysis and Conditioning System provides the required electrical and mechanical interface between the AC source, the user's equipment under test and the data acquisition PC system. This allows all signal connections to be made easily and conveniently.

The PACS-3-75 unit has several AC power input and output connections as well as an interface connector to the PC based data acquisition system.

### 1.2.3 PC Based Data Acquisition System (updated for new PCI data acquisition)

All measurements required for IEC testing are performed by the data acquisition system that resides on the user's PC. The measurement card needs to be installed in an available slot and the software needs to be installed. All signal connections between the PC and the PACS-3-75 unit are made with a single 37 pin to 68 pin cable supplied with the system.

The following data acquisition cards are supported by the CTSMXL software:

CI400PCI	PCI card	NI 6032/4E. No longer provided on new system shipments but still supported by CTS30 software revision 1.3.X
CI401PCI	PCI card	Exacq Technologies CM2110 PCI A/D card, 250 Ks/sec for single phase systems (P/N 250803)
CI403PCI	PCI card	Exacq Technologies CM2210 PCI A/D card, 1 Ms/sec for three phase systems (P/N 250797)
CI401PCI	PCI card	National Instruments M Series PCI-6220 A/D card, 250 Ks/sec for single phase systems (P/N 250821) for software version 2.0.x or higher
CI403PCI	PCI card	National Instruments M Series PCI-6250 A/D card, 1 Ms/sec for three phase systems (P/N 250822) for software version 2.0.x or higher

The data acquisition system samples all voltage and current channels at a high sampling rate and provides the data to the CTSMXL Software for further processing. The PACS-3-75 provides a single voltage input channel and three current input channels for each phase, to the PC. This allows for current range changing

on the fly. There is no need for the user to select a current range as the software automatically uses the most suitable range available for the current signal.

#### 1.2.4 CTSMXL Software Functions

The CTSMXL software application supports EN 61000-3-2 and EN 61000-3-3 compliance testing requirements using an intuitive graphical user-interface from which you can:

- Set up and run compliance-level tests. The setting up of many IEC details is facilitated through the use of embedded standards expertise.
- Collect real-time test data from the MX-CTSL System.
- Display and monitor real-time test results.
- Save test results to disk for analysis using other programs.
- Replay previously recorded test data and single step through the data frame by frame.
- Print reports and graphs in MS Word™ formats.

#### 1.2.5 MXGUI Source GUI Functions

The CTS system also includes an AC source control software package. This Graphical User Interface program can be used to control the AC source from the same PC using either the RS232C or IEEE-488 interface. An IEEE-488 interface is not included with the CTS system. The PC must have an available RS232C port to use the RS232C control interface to the source.

In the absence of a suitable interface, the user can operate the AC source from the front panel. This does not affect the ability to run harmonics and flicker tests. It does however preclude the use of the EN 61000-4 immunity tests, which are only available through the MXGUI<sup>1</sup> AC source control program.

**Note on Interface conflicts:**

If the MXGUI program is set up to use the same serial or IEEE-488 port (any address) to communicate with the AC source as the CTSMXL Software, it is not possible to have both the CTSMXL Software and the MXGUI software running at the same time. This is due to the fact that both programs would attempt to use the same interface to control the AC source. If this is the case, close one program before opening the other.

If IEEE-488 is used to control the AC source with the MXGUI and RS232C is selected on the MXCTSL or vice versa, both programs can be open at the same time but care should be taken not to control the source from both programs at the same time. This setup is not recommended however.

Use either program in turn depending on the task at hand (MXCTSL for EN 61000-3 and MXGUI for EN 61000-4)

---

<sup>1</sup> Some EN 61000-4 tests are pre-compliance only

## 2. IEC Testing

---

### 2.1 About This Chapter

This chapter provides some background information on the various IEC test standards that apply to AC powered products. It also reviews some of the test equipment requirements that are important when testing for IEC compliance. Note that this information is subject to change as IEC standards change over time. This overview is by no means comprehensive and is only provided for reference. If the reader is not familiar with IEC test requirements for AC powered products, we strongly recommend consulting information on this subject that is available through other sources. References are provided at the end of this chapter.

The standards covered in this chapter include those, which the CTS system is capable of testing, specifically:

- EN 61000-3-2 Quasi Static and Transitory Harmonics
- EN 61000-3-3 Flicker
- EN 61000-4-11p Voltage Dips and Variations (pre-compliance, requires option -411 on MX)
- EN 61000-4-13 Interharmonics and Harmonics Immunity Test (requires option -413 on MX)
- EN 61000-4-14 Voltage Fluctuations
- EN 61000-4-17 DC Ripple
- EN 61000-4-27p AC Voltage Unbalance (pre-compliance)
- EN 61000-4-28 Frequency Variations
- EN 61000-4-29p DC Voltage Dips and Variations (pre-compliance)

### 2.2 The EMC Directive

As the world population grows and the overall energy consumption increases, industrialized nations have become increasingly concerned with the future availability of energy. Reducing energy consumption by using more energy efficient lighting and motor drive systems is one approach being taken by European, US and Japanese governments. The need of more efficient electrical systems however typically requires the use of sophisticated semi-conductor based electronic circuits that produce current harmonics. This in turn affects power quality which is an increasing problem on public utility networks. As lighting systems with electronic ballasts and equipment with switching power supplies such as computers, TV's, fax machines and printers proliferate, power quality deteriorates. The same is true for PWM controller motor drives. The International Electrical Committee (IEC) has released standards dealing with the low frequency public supply system. Initial standards were 555.2 (Harmonics) and 555.3 (Flicker) which have since been refined and are now available as EN 61000-3-2 and EN 61000-3-3 respectively. Effective January 1, 1996, most electrical devices sold within the member countries of the European Union (EU) must meet these standards as governed by the EMC directive.



### 2.2.1 Why do you have to test?

In general, these IEC directives do not have the legal force of law. However, the European Union (EU) has issued Euro Norms in the context of these IEC directives that are legally binding and are enforced by the EMC Police. The relevant enforceable standards are EN61000-3-2 and EN61000-3-3, which supersede EN60555.2 and EN60555.3 respectively. These standards are also known under the IEC designator EN 61000-3-2 and EN 61000-3-3. Recently, the universal EN 61000 convention has been adopted for all IEC standards.

Individual member countries have issued identical national norms, either in their native language or in English, which carry the same legal enforceability. Other countries such as Japan and the USA are in the process of adopting similar standards. Penalties for violating these norms range from hefty fines to jail time. In cases where the manufacturer is not located in the EU, his distributor or authorized agent will be held liable. Local customs agencies can stop equipment that does not meet these IEC norms at the border. Compliance testing of equipment is performed by accredited laboratories run by European government agencies assigned with enforcing these norms. Also, competing vendors have been known to submit failing test results on competitors' products to local governments to force prosecution and gain a competitive advantage in the market place.

Conformance to the EMC low voltage directive is indicated by the CE mark. Note however, that the CE mark includes more than just EN 61000-3-2 and EN 61000-3-3.

### 2.3 The EN 61000-3-2:2000 Standard

This standard is often referred to as Amendment 14. It is less stringent for class C and D products compared to the 1998 standard. Effective January 2001, products may be evaluated against this standard.

#### 2.3.1 Test Classes

CENELEC-A14 changes the definition of Class-D products. Per the amendment, only TV's, PC's and PC monitors are to be tested per Class-D limits. This means that many products migrate to Class-A. Note that there is no change in classification for Class-A, B, and C products, but the harmonic analysis method for products with fluctuating power is affected by A-14 for these products as well.

The limits for Class-C & D are proportional. Whereas this doesn't cause any difficulties for products with a constant current/power level, the situation was less clear for products with fluctuating load levels. Most test systems implemented so-called dynamic limits, with the limits constantly being adjusted per the measured power (or the fundamental current for Class-C) while others used some average power level to set the limits. The latter systems determine this average power/current using some arbitrary method, and pre-test period. Thus different test systems implement different limits for the same (fluctuating power) products, which can result in one system PASSING a product while the other REJECTS it.

A second issue for fluctuating loads is the way the existing standard (1998 edition) defines criteria for passing and failing the harmonics test. The existing standard permits the unit under test to occasionally exceed the 100 % limit, provided the harmonics never exceed 150 % of the limit. In fact, the unit under test is allowed to exceed the 100 % level for 10 % of the test time. The test time for fluctuating loads is to be at least 2.5 minutes, i.e. the harmonics can exceed the 100 % limit for 15 seconds in every 150-second (2.5 min) period. For longer test times, one can perform this test in 2.5 minutes "time blocks" but another interpretation is to just take 10 % of the overall test time. Thus, the testing method for fluctuating loads was somewhat subject to interpretation by the test equipment manufacturer.

Pass/Fail criteria under the new standard are as follows:

*The average value for the individual harmonic currents, taken over the entire test observation period shall be less than or equal to the applicable limits.*

*For each harmonic order, all 1,5 s smoothed r.m.s. harmonic current values shall be less than or equal to 150% of the applicable limits.*

*Harmonic currents less than 0,6% of the input current measured under the test conditions, or less than 5 mA, whichever is greater, are disregarded.*

*For the 21st and higher odd order harmonics, the average values obtained for each individual odd harmonic over the full observation period, calculated from the 1,5 s smoothed values may exceed the applicable limits by 50% provided that the following conditions are met:*

- *The measured partial odd harmonic current does not exceed the partial odd harmonic current, which can be calculated from the applicable limits.*
- *All 1,5 s smoothed individual harmonic current values shall be less than or equal to 150% of the applicable limits.*

### 2.3.2 EN 61000-3-2 Test Limits

The following table summarizes the current harmonic limits for each device class that are presently in effect. The limits are generally built into IEC test software programs such as California Instruments' CTSMXL Test System software. If the power level of a class D device drops below 75 W (configurable - see System Administrator Manual P/N 7003-794), no harmonic current limits are applied and the result will always show a pass.

Harmonic no. (n)	Class A	Class B	Class C	Class D	IEC 555-2
	A RMS	A RMS	% of fundamental RMS current	mA/Watt of input power (75 - 600 W)	A RMS TV Receivers > 165 W
2	1.080	1.620	2	-	0.300
3	2.300	3.450	30 x PF	3.400	0.800
4	0.430	0.645	-	-	0.150
5	1.140	1.710	10	1.900	0.600
6	0.300	0.450	-	-	-
7	0.770	1.155	7	1.000	0.450
8	0.230	0.345	-	-	-
9	0.400	0.600	5	0.500	0.300
10	0.184	0.276	-	-	-
11	0.330	0.495	3	0.350	0.170
12	0.153	0.230	-	-	-
13	0.210	0.315	3	0.296	0.120
Even 14-40	1.84 / n	2.760 / n	-	-	-
Odd 15-39	2.25 / n	3.338 / n	3	3.850 / n	1.500 / n

Table 2-1: EN 61000-3-2 Class Limits

The actual class limits for all classes have not changed with amendment 14. The power levels for Class D on which these limits are calculated however and the fundament current and power factor for class C have been changed however.

First of all, the manufacturer is required to declare the rated power (the fundamental current and Power Factor for Class-C) for the product. This “rated power” (current & PF) will be used as the basis for the limit calculation of Class-D (Class-C). Thus, a “rated power” of 150 Watt for example, will yield a third harmonic limit of  $150 \times 3.4 = 510$  mA. Similarly, a rated fundamental current of 0.4 Amp, and a rated PF of 0.98 for an electronic ballast will result in a third harmonic limit of  $0.4 \times 0.3 \times 0.98 = 117.6$  mA. Thus, the amendment requires that an automated compliance test system must allow the user to enter this rated power or rated current. Also, the test system must verify the power (fundamental current and PF) because these “rated vales” as declared by the manufacturer must be within +/- 10 % of the actual values. If not, the actually measured values are to be used for the limit calculation. The method to measure these actual power, fundamental current and PF differ from the “average method” used in existing test systems, and of course differ also from the “dynamic limit method”.

The Pass/Fail criterion is given above. The “10 % of the time over 100 % of the limits” no longer exists. The average harmonic level during the whole test must simply be below the limit, and individual values in each acquisition window (after 1.5 sec filtering) must be below 150 % of the limit. There is also an extra allowance for the higher harmonics from H<sub>21</sub> - H<sub>39</sub>.

The CTS fully supports and implements Amendment 14.

**2.3.3 EN 61000-3-2:2000 Test Time**

Under the new test standard, four test times (observation periods) are allowed depending on the nature of the EUT. All are aimed at ensuring repeatability of test results when tests are performed under the same conditions and on the same test system. Repeatability for this purpose is defined as results that are within 5 %. Available observation periods are shown in the table below.

Type of equipment behavior	Observation period
Quasi-stationary	T <sub>obs</sub> of sufficient duration to meet the requirements for repeatability.
Short cycles (T <sub>cycle</sub> < 2.5 min)	T <sub>obs</sub> > 10 cycles (reference method) or T <sub>obs</sub> of sufficient duration or synchronization to meet the requirements for repeatability. 'Synchronization' means that the total observation period is sufficiently close to including an exact integral number of equipment cycles such that the requirements for repeatability are met.
Random	T <sub>obs</sub> of sufficient duration to meet the requirements for repeatability.
Long cyclic (T <sub>cycle</sub> > 2.5 min)	Full equipment program cycle (reference method) or a representative 2.5-min period considered by the manufacturer as the operating period with the highest total harmonic content.

Table 2-2: Harmonics Amendment 14 Test Times

## 2.4 The EN 61000-3-2:1998 Standard

This section covers the 1998 standard including amendments 1 and 2. This standard may be used to test products until January 2004. After this date, only the 2000 revision of the standard including Amendment 14 should be used.

The purpose of enforcing the EN 61000-3-2 standard is to limit the amount of current harmonics produced by electronic loads. Since harmonic currents caused by a load in turn produce voltage harmonics across the public utilities impedance, they affect other equipment connected to the same circuit. In fact, most public utilities exhibit voltage distortion caused by non-linear loads. Because harmonics can have serious effects on many electrical devices, efforts to set standards to limit their presence date back to the 1930's. This resulted in the IEC's Technical Committee (TC) setting standards dealing with current harmonics as far back as 1977. These standards became the basis for IEC standards 1000-3-2 and 1000-3-3 adopted in 1993. Because of their long history, many people still refer to these standards as 555.2 and 555.3 although there are some differences between the older and newer versions and tests performed today should be done according to the new standards, not the old ones.

Another confusing issue that is rooted in history is the nature of the products that fall under these IEC norms. While the original 555 specifications focused primarily on consumer products and excluded many professional and industrial products, the new IEC 1000-3 norms expanded coverage to include all electrical products with a rated input current up to 16 A rms per phase. Presently, only products with a line input voltage of 220 V and above are included. Japan and the US are working towards similar requirements that would cover products that require 100 Volts and up. Due to the original scope of the IEC 555 norms, many manufacturers are still under the impression that their products are exempt since they are not considered consumer products. Especially manufacturers of switching power supplies - some of the worst "offenders" when it comes to generating harmonics currents - have been caught off guard.

### 2.4.1 Test Classes

The standard divides products to be tested in to four classes, A, B, C and D. Each class has its own harmonic current limits. Class A is the default class, meaning if a product does not fall into the categories for class B, C or D, it is by default class A. The product classes are defined as follows:

Table 2-3: EN 61000-3-2 Class Descriptions

Class	Description
A	All motor driven equipment, most “domestic” appliances and virtually all 3 phase equipment (<16 A rms per phase)
B	All portable electric tools
C	All lighting products, including dimmers, with an active input power above 25 Watts.
D	Products having a power range from 75 to 600 Watts AND a current waveform that has a special wave shape.

Test limits are most stringent for Class-C and Class-D equipment. These classes were established to cover the wide range of products that uses “cheap” switching power supplies with a rectifier capacitor input. These units typically exhibit relatively high odd harmonics. Since this type of supply is so commonly used, the effect of a large quantity of products like this can add up to significant problems. To limit this effect, the current harmonic limits for class-D equipment are specified in mA/W instead of an absolute current value as is done for class A and B. Many consumer and professional devices such as TV's, VCR's, stereos, PC's, fax machines, printers etc. may fall into the more stringent class D category.

Class-C limits are not specified in absolute values either but rather as a percentage of the fundamental current. The third harmonic limit is also a function of the power factor so is harder to meet as the power factor decreases. Neither class C nor D devices have to meet even current harmonics limits.

Since class C and D limits are load dependent, the power level and power factor have to be determined for each test. In case of fluctuating power levels, it may be necessary to measure the power level during the test and adjust the limits used to pass or fail the unit under test dynamically.

This dynamic nature of the class C and D limits resulted in some confusion and a possible problem of inconsistent test results when using IEC test systems for different vendors. The Standards body working group for harmonics has clarified some of the class and limit issues and these efforts have resulted in a revision of classes and limit calculations since the year 2014.

CTSMXL software makes dynamic classification for Classes A and D. The classification follows the following principle. If during either a Class A or D test the EUT becomes a Class A device, the EUT will be considered a Class A device. If the EUT is a Class D device through out the test, then the device is a Class D device. In other words, Class A is a latching classification. Please note that even though the classification may change during a test, a Class A (or D) test will still be performed according to Class A (or D) specification.

### 2.4.2 Steady State versus Transitory Harmonics

Two types of harmonics testing are called for in the EN 61000-3-2:2014 standard, a quasi steady state and a transitory one. The transitory harmonics tests allow for equipment that has power demands that vary over time to temporarily exceed the harmonic current limits by as much as 50 %, as long as such elevated levels do not occur for more than 10 % of the test period. Since the minimum test time required is 2.5 minutes or 150 seconds, this means the current harmonics can be as high as 150% of the standard limits for no more

than 15 seconds in any 150 second period. This requirement imposes more demands on the power analyzer being used than it does on the AC power source.

Steady state harmonics are those exhibited by equipment that has a constant current draw such as a fluorescent lighting fixture. Many pieces of equipment, such as Laser printers that have a heating element that kicks in any time a page is printed, have fluctuating power demands and may require transitory harmonics testing.

Note that Amendment 14 does away with the distinction between stationary and transitory harmonics.

**2.4.3 IEC 61000-4-7 Inter Harmonics Evaluation.**

IEC61000-3-2 Edition 2.1 (2001-10) references measurement methods per IEC61000-4-7 and Edition 2.0 of this measurement standard specifies the inclusion of inter harmonics. For the assessment of harmonics, the harmonic and inter-harmonic current levels are grouped to be the sum of squared intermediate lines between two adjacent harmonics according to the equation below, as visualized also in the accompanying figure. The resulting harmonic group component of order n (corresponding to the center line in the hatched area) has the magnitude C (rms value).

$$C_{ng}^2 = \frac{C_{10ng-5}^2}{2} + \sum_{i=-4}^4 C_{10ng+i}^2 + \frac{C_{10ng+5}^2}{2} \quad \{ 50 \text{ Hz system} \}$$

$$C_{ng}^2 = \frac{C_{12ng-6}^2}{2} + \sum_{i=-5}^5 C_{12ng+i}^2 + \frac{C_{12ng+6}^2}{2} \quad \{ 60 \text{ Hz system} \}$$

In these equations, “c” is the modulus of the spectral component corresponding to an output bin of the Fourier Transform of the data obtained from the 200 ms acquisition period , and “C” is the resulting modulus of the harmonic which is to be compared against the limits in IEC61000-3-2 for the selected test class.

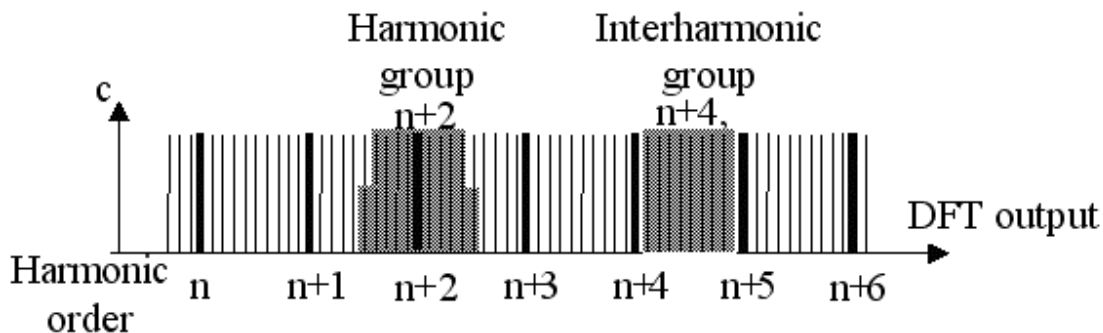

This inter harmonics measurement is not mandatory as of this writing, as the use of equipment meeting the previous version of IEC61000-4-7 (the older Edition 1) is permitted for a short period (until the existing IEC61000-4-7 Edition 2 has gone through its maintenance cycle). Therefore the user has the option to either disregard inter harmonics, or to group them into the assessment by selecting the appropriate field in the “Test Category” settings.

It should be noted that selecting this “inter harmonics grouping” has little impact on the measurement results for the vast majority of products. Only products with active power factor correction AND highly fluctuating power consumption will produce inter harmonic levels that would add to the level of “C” as given above. Most products do not produce inter harmonics, and therefore the measured harmonic currents will be the same either way.

**2.5 EN 61000-3-3 Flicker**

Flicker standards are imposed to limit voltage variations caused by loads connected to the low voltage supply network that would cause lights connected to the same circuit to flicker. A complex measurement

approach outlined in IEC 868, was devised to correlate voltage fluctuations to a human perceptibility factor (P). The EN 61000-3-3 standard sets limits for voltage fluctuations caused by electrical apparatus with a current level up to 16 Amps per phase. The standard describes a human flicker perceptibility curve that defines the upper limit for acceptable flicker. This curve plots the percentage of voltage fluctuation against the amount of voltage fluctuations per minute.

As is the case for the Harmonics standards, the Flicker standard dates back several years and was rooted in the IEC 555.3 specification. Today however, the EN 61000-3-3 standard should be used to evaluate equipment. Note that low power equipment generally does not cause Flicker and therefore often can be exempted from this requirement. The standard permits the equipment manufacturer to prove via analysis that their products are unlikely to cause voltage fluctuations. This analysis becomes part of a Technical Construction File (TCF) which in turn may be used to obtain product certification.

### 2.5.1 EN 61000-3-3 Flicker Test AC Source Requirements

As is the case with Harmonics testing, the IEC 61000-3-3 standard imposes requirements on the AC source that is used. Some of these requirements are similar and less severe than those imposed under IEC 61000-3-2. For example, total harmonic distortion of the voltage can be 3 % for Flicker testing as opposed to only 1.25% for harmonics testing. The voltage regulation needs to be better than 2 % which is not a problem for most AC sources. In rare cases, the line voltage may even be used for this purpose. More often than not, however, the use of an AC source with well-defined specifications is recommended to obtain repetitive test data and eliminate the possibility of flicker caused by line fluctuations, not load current fluctuations. The MXCTS system uses the MX Series power source, which meets these requirements.

To simulate the resistance and inductance of the low voltage distribution systems, the IEC 61000-3-3 requires a specific AC source output impedance to be used. This reference impedance, as specified in IEC-725, is defined in such a way that it approximates a typical distribution network impedance. Individual countries may require the use of a different reference impedance that more closely resembles the actual impedance of that countries' specific distribution network. Most European countries use the specified reference impedance value however.

The MXCTS uses a test impedance with the impedance values specified in IEC 725. The test impedance is provided by the OMNI-3-37MX unit, which is connected between the output of the MX power source and the PACS-3-75 measurement system. Note that this impedance is restricted to 37 A RMS per phase while the MX power source can deliver more current than that. High power EUT's should be tested to IEC 61000-3-11 using the OMNI-3-37 instead.

Note that the OMNI-3-37MX test impedance for the MXCTS system is matched to the California Instruments' MX power source output impedance. Do not use third party reference impedance networks with the MXCTS system as the combined AC source and network impedance may not match the IEC 61000-3-3 requirement.

### 2.5.2 When to Test for EN 61000-3-3

As mentioned, it may not be necessary to test every product for EN 61000-3-3. If it can be shown that maximum power consumption of the unit under test is low, and the surge current level at turn-on is limited, it can be shown that the product causes insignificant Flicker levels across the reference impedance. For loads having an rms current draw of more than 5 Amps, it is generally recommended to verify conformance to EN 61000-3-3 however.

## 2.6 EN 61000-4-11p Voltage Dips and Variations

The EN 61000-4-11 is an immunity test for low voltage equipment to ensure reliable operation when connected to the public distribution system. This test requires an AC source that is capable of generating specific voltage variations and voltage dips. The unit under test must not sustain any damage from such occurrences nor cause unsafe conditions.

Table 2-4: Average public utility disturbances per annum in Europe needed.

DEPTH	DURATION			
(Voltage drop in % of nominal Ut)	10 to < 100 ms	100 to < 500 ms	500 ms to 1 sec	1 sec to > 3 sec
10 %o < 30 %	61	66	12	6
30 % < 60 %	8	36	4	1
60 % < 100 %	2	17	3	2
100 %	0	12	24	5
Number of disturbances per year				

The need to test for immunity of products against voltage dips and interruptions was prompted by studies of electric utility availability. The results shown in Table 2-4 were found in this study (UNIPEDE study 91 en 50.02). From this data it is clear that most disruptions are short in nature (about 5 to 10 periods) and no more than 60 % below nominal. Occasionally however, extended periods of complete power loss occur. It is suggested that this test data also be used as a guide in selecting appropriate test levels.

### 2.6.1 Why Do You Have to Test?

The EN 61000-4-11 affects a large set of products, specifically; *"Electrical and electronic equipment having a rated input current not exceeding 16 A per phase."* Thus, most single and three phase AC powered equipment used in domestic and light industrial settings fall in this category. In fact, around 95 % of all electrical equipment in household and light industrial applications, require no more than 16 A per phase. In Europe, this implies real apparent levels of  $230\text{ V} * 16\text{ A} = 3680\text{ VA}$ , with real power either at the same or a lower level. Specifically excluded are all DC powered products (battery operated devices) and 400 Hz AC equipment. (Avionics) These products will be covered in future IEC standards. At this time meeting the EN 61000-4-11 standard is required for most products to obtain the CE Mark, required to market products in the European Union.

California Instruments' MXCTS system supports pre-compliance EN 61000-4-11 testing using the MX series AC power source with the addition of the -411 firmware option. The test sequencer and report generation for EN 61000-4-11 is provided through the MXGUI Windows<sup>→</sup> software. To accommodate changes in the specification, test levels and duration can be set by the operator or loaded from disk if

## 2.7 EN 61000-4-13 Interharmonics and Harmonics Immunity Test

The EN 61000-4-13 is presently only in draft form and the implementation used in the CTS system uses applies to the first draft of the immunity test specification. The purpose of this test is to verify a EUT's immunity to signaling frequencies that may be present on the AC line. These signaling frequencies are not always harmonically related to the fundamental frequency. As such, this test applies both harmonics and interharmonic frequencies in addition to the fundamental AC voltage.

The generation of interharmonics requires the addition of an independent signal generator in the MX power source. (Option -413) If this optional -413 interharmonics generator hardware option is present in the MX, the EN 61000-4-13 test window will be available from the MXGUI program.

The EN 61000-4-13 draft specification calls out test levels for three product classes, class 2, 3 and X. Class X involved user defined test levels. Test levels for class 2 and 3 are implemented in the MXGUI while test levels for class X may be set by the user in the IEC413.413 file.

Note that EN 61000-4-13 is presently only in draft form and as such, hardware and/ or software changes to this test option may be required at a future date.



## 2.8 EN 61000-4-14 Voltage Fluctuations

The EN 61000-4-14 is aimed at testing a product for immunity against voltage fluctuations that can occur on the public utility. The nature of the voltage fluctuations is different from those tested under EN 61000-4-11 however. The fluctuations covered in this standard are less severe and involve typical high and low line conditions.

California Instruments' CTS system supports full compliance EN 61000-4-14 testing. The EN 61000-4-14 test is implemented in the MXGUI Windows<sup>→</sup> software. To accommodate changes in the specification, test levels and duration can be changed by the operator or loaded from disk if needed.

## 2.9 EN 61000-4-17 DC Ripple

The EN 61000-4-17 is aimed at testing a DC powered product for immunity against voltage ripple. Ripple is often caused by feed-through from the AC input section of a DC supply and exhibits itself as a small AC signal riding on the DC output. The EN 61000-4-17 standards covers test levels and frequencies for testing the immunity of DC products against such phenomena.

The CTS system supports full compliance EN 61000-4-17 testing. The EN 61000-4-17 test is implemented in the MXGUI Windows<sup>→</sup> software. To accommodate changes in the specification, test levels and duration can be changed by the operator or loaded from disk if needed.

**2.10 EN 61000-4-27p Three Phase Voltage Unbalance**

Three phase CTS systems support pre-compliance EN61000-4-27 testing. The EN61000-4-27 test is implemented in the MXGUI Windows<sup>→</sup> software. To accommodate changes in the specification, test levels and duration can be changed by the operator or loaded from disk if needed.

**2.11 EN 61000-4-28 Voltage Frequency Variations**

The MXCTS system supports full compliance EN61000-4-28 testing. The EN61000-4-28 test is implemented in the MXGUI Windows<sup>→</sup> software. To accommodate changes in the specification, test levels and duration can be changed by the operator or loaded from disk if needed.

**2.12 EN 61000-4-29p DC Voltage Dips, Interruptions and Variations**

The MXCTS system supports pre-compliance EN61000-4-29 testing. The EN61000-4-29 test is implemented in the MXGUI Windows<sup>→</sup> software. To accommodate changes in the specification, test levels and duration can be changed by the operator or loaded from disk if needed.

## 2.13 References

Additional information on IEC norms and requirements may be obtained from the following sources. You may also check for the latest IEC related information on California Instruments' web site at [www.programmablepower.com/brands/california-instruments.htm](http://www.programmablepower.com/brands/california-instruments.htm).

Document Number	Date of Publ.	Title
IEC 725	(1981)	"Considerations on reference impedances for use in determining the disturbance characteristics of household appliances and similar electrical equipment."
IEC 868	(1986)	"Flicker meter, Functional and design specifications."
IEC 868 Amendment 1	(1990)	"Flicker meter, Functional and design specifications."
IEC 868-0	(1991)	"Part 0: Evaluation of flicker severity."
EN 61000-3-2	(2014)	"Part 3: Limits - Section 2: Limits for harmonic current emissions (equipment input current $\leq 16$ A per phase.)"
EN 61000-3-3	(2013)	"Part 3: Limits - Section 3: Limitation of voltage fluctuations and flicker in low-voltage supply systems for equipment with rated current $\leq 16$ A."
IEC 61000-3-11	2002	"Part 11: Limits - Section 3: Limitation of voltage fluctuations and flicker in low-voltage supply systems for equipment with rated current $\leq 75$ A."
IEC 61000-3-12	2005	"Part 12: Limits - Section 2: Limits for harmonic current emissions (equipment input current $\leq 75$ A per phase.)"
EN 61000-4-7	1996	"General guide on harmonics & inter-harmonics" New version expect early 2002.

Copies of complete IEC standards may be obtained from at:

International Electrotechnical Commission (IEC)  
P.O. Box 131  
1211 Geneva 20  
Switzerland  
Phone: +41 22 919 0300  
Fax: +41 22 919 0228  
Web: [www.iec.ch](http://www.iec.ch)

or in the USA:

American National Standards Institute (ANSI)  
Sales Department  
11 West 42nd Street  
New York, NY 10036  
Phone: +212 642 4900      Fax: +212 302 1286

### **3. System Installation**

---

#### **3.1 About This Chapter**

This chapter provides information on system installation and covers both the hardware connections that need to be made between the various components and the software setup. Proper installation of all hardware components and software modules is required to successfully use the MXCTS system. Some experience with AC power systems and PC's running Windows is assumed.

#### **3.2 Hardware Installation**

##### **3.2.1 Unpacking**

Inspect the unit for any possible shipping damage immediately upon receipt. If damage is evident, notify the carrier. DO NOT return an instrument to the factory without prior approval. Do not destroy the packing container until the unit has been inspected for damage in shipment.

##### **3.2.2 AC Source**

Refer to the MX Series User Manual provided with the AC Source.

The main power requirements for the MXCTS are dictated by the AC power sources used and the power levels that the Equipment Under Test will demand. Consult the MX Series Power source user manual for input current and input wiring requirements.

### 3.3 PC Requirements

The CTS system requires a PC to operate. The included CTSMXL Software must be installed on a PC capable of acquiring and processing data in real-time to ensure no-gap acquisition as required by both the harmonics and flicker test standards.

---

**NOTE:** It is recommended to purchase the required PC from California Instruments using the CIC-PC-PCX option. This ensures a suitable PC with the software pre-installed and tested will be furnished with the system for turnkey operation. This option also includes a monitor and printer. If this option is not ordered, the PC to be used with the system should be shipped to California Instruments prior to delivery for integration and test. In this case, it is the customer’s responsibility to ensure the provided PC meets the performance criteria outlined below.

---

The PC requirements will depend to some extent on the following factors:

- The phase mode. Three phase systems require more CPU power than single-phase systems.
- The type of A/D card used. A PCI slot is required.
- The Windows operating system used. Windows 7 imposes more overhead on data transfer than Windows XP operating systems. New versions are tested only with contemporary operating systems. As such, it may be required to upgrade to a newer operating system to support the latest version of the MXCTSL software. Presently, MXCTSL 2.9.0 has been tested only on Windows 7 32bit and XP platforms.
- For report generation, a copy of MS Word is required. The MS Word version supported is Word 2007. Older versions of MS Word may no longer work when upgrading to the latest MXCTSL software version. In that case, a newer version of MS Word may have to be installed.

The matrix below shows the required minimum process clock rate. These clock rates apply to Intel® Core i5 based PC's. The values shown are minimum values, not recommended values. To allow future expansion, it may be advisable to plan on using a faster PC.

Other minimum PC requirements are:

- Windows 7 32-bit, Windows XP. Other versions of Windows operating systems are no longer supported.
- RAM size 4 GB minimum.
- SVGA (800 x 600 resolution, 16 or more colors).
- IDE or SCSI hard disk drive of 200 GByte size or more.

PC Processor speed matrix shown minimum clock speeds, not recommended clock speeds for the PC. A faster PC can be used. This assumes other applications and/or screen savers that take up processor time are generally closed.

*Table 3-1: PC Intel® Dual Core Processor Clock Speed Requirement*

Mode	A/D Card	Win 7 32bit /XP
Single phase	PCI	i5 2.5 GHz
Three phase	PCI	i5 3.3 GHz

### 3.4 OMNI-3-37MX Unit

The OMNI-3-37MX Zref impedance provides  $0.24 + 0.15j$  Ohms for each phase and  $0.16 + 0.10j$  Ohm for the neutral. This Zref is required for IEC 61000-3-3 flicker test.

If only an OMNI-3-75 is present, the MX30-3Pi or MX45-3Pi programmable impedance must be used to increase the required resistive portion of the flicker reference impedance for IEC 61000-3-3 testing. In this case, either the OMNI-3-75 must be manually controlled or the programmable impedance must be manually set as the CTSMXL software can only control one impedance type at a time. If the CTSMXL software is configured to use the OMNI-3-75 control through the MX system interface, the MX30 or MX45 programmable impedance can be set manually while in flicker mode after selecting the test setup but before clicking on the START button as the front panel will be unlocked at this time. It is important to only set the Resistive portion of the programmable impedance as the inductive values of the OMNI-3-75 and OMNI-3-37MX are the same. See 15.6 for differences in impedance values of both OMNI's.

If both OMNI's are present (MXCTSH configurations with optional CTSMXL software added), only one OMNI can be connected at a time to prevent impedance build-up. A quick disconnect scheme is provided in this case to allow switching between OMNI units. Refer to Figure 3-8.

Only manual control of the flicker or BYPASS state on the OMNI-3-37MX is supported through the front panel push button.

#### 3.4.1 Mechanical Installation

The OMNI-3-37MX is contained in a separate 19" wide cabinet with a 5.25" height (3U). This cabinet should be placed as near the MX-45-3Pi as possible.

The OMNI-3-37MX has its own IEC320 AC power input for bias power. Check the input rating set at the back of the OMNI-3-37MX chassis. It can be set for either 115V or 230V AC. DO NOT CONNECT if the input rating is set incorrectly. The setting can be changed by pulling out the fuse holder. The set line input voltage is shown through the small window on the IEC320 connector.

If the OMNI-3-37MX is installed in an OMNI-3-75 cabinet as part of a MXCTSHL system, you must first turn on the power to the OMNI-3-37 using the front panel On/Off rocker switch located at the bottom of the cabinet. This ensures the OMNI-3-75 is engaged connected the MX output power. Then use the OMNI-3-37MX On/Off switch to turn the OMNI-3-37MX on or off. Note that if the OMNI-3-37MX is turned off, it disconnects the output. For both harmonics and flicker testing, the OMNI-3-37MX must be turned on and placed in either Bypass (for Harmonics) or Flicker mode using the front panel MODE button.

The OMNI-3-37MX can operate in one of two modes:

- Bypass mode This mode is used during harmonics test
- Flicker mode This mode is used during flicker test

---

**Note:** The OMNI-3-37MX mode is not controlled by the CTSMXL Software. Instead, the OMNI-37MX front panel control button is enabled to allow manual switching between modes.

---

3.4.2 Front Panel Controls

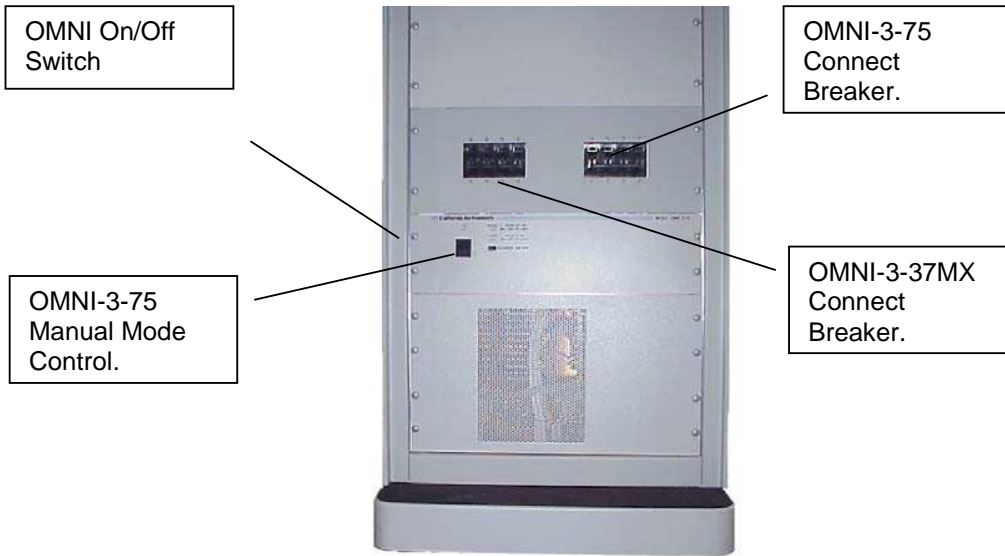

The front panel contains the AC power On/Off switch, the BYPASS or ENGAGE status lights and a manual MODE switch button. The mode switch button is normally enabled and the OMNI-3-37MX state is controlled through the use of this button. The “ON “ LED indicates the OMNI-3-37MX module is powered up.

The front panel power switch is located on the left hand side of the OMNI-3-37MX cabinet front. There is a built in delay for engaging or disengaging the contactors when turning the OMNI-3-37MX on and off.

If the OMNI-3-75MX is part of a MXCTSHL system, it will be mounted in the OMNI-3-75 cabinet. In that case, two circuit breakers will be present. (See illustration above). These are used to connect either OMNI to the PACS-3-75 input. Close only one breaker at a time. Refer to user manual P/N 7003-972 on MXCTSHL configuration details.

### 3.4.3 Wiring

Power from the MX three-phase output connector should be routed to the OMNI AC Input terminal block located at the rear of the OMNI-3-37MX. The recommended wire gauge is #4.

Output power from the OMNI-3-37MX must be routed to the PACS-3-75 input connector. (TB4) To access the PACS-3-75 AC input and output connections, the rear-top cover of the PACS-3-37MX must be removed. This wiring is generally provided with the system. Wire size used is AWG #6, which is the maximum size supported by the PACS-3-75 connectors. Note that the wire fits very tightly in the TB4 connector. It may be necessary to twist stranded wires firmly to make the wire fit the connector opening.

The EUT connections can be made at TB3 AC OUT of the PACS-3-75. The wire size should be AGW #6 also. To gain access to power connector TB3, the access panel located on the top rear of the PACS-3-75 unit must be removed. Remove the four screws holding the connector access panel in place and remove the panel. Once input and output wiring is complete, reattach the connector access panel.

The connection diagram is shown in *Figure 3-1*. Note that the PACS-3-37MX is installed between the MX45-3Pi and the PACS-3-75. Wiring diagrams for other possible systems configurations are shown in *Figure 3-2* through *Figure 3-6* (or *Figure 3-7* through *Figure 3-8* for older version OMNI-3-75 cabinet systems) depending on system configuration.

Note that the OMNI-3-75 is normally only present on MXCTSH or MXCTSHL system configurations.

---

**Note:** This wiring supports EUT load currents up to 75 Arms. For higher power EUT's used with the MX-45, the PACS-3-75 should not be left in the circuit. Instead, EUT's that require higher currents should be connected directly to either the MX output, which is rated for higher currents than the PACS-3-75. In this case, harmonics and flicker testing is not supported.

---

---

**Note:** The OMNI-3-37MX supports EUT load currents up to 37 Arms in FLICKER mode and 54 Arms in BYPASS mode. Any time the OMNI-3-37MX is connected between the MX and the EUT, the programmable current limit of the MX MUST BE SET TO NO MORE THAN 37 Amps per phase during flicker tests. If not, serious damage to the OMNI-3-37MX could result. This type of damage resulting from use above it's maximum current rating is not covered under the normal product warranty.

---



### 3.5 OMNI-3-37MX Unit

The OMNI-3-75 Ztest impedance provides  $0.15 + 0.15j$  Ohms for each phase and  $0.10 + 0.10j$  Ohm for the neutral. This Ztest is required for IEC 61000-3-11 flicker test. MXCTSHL system configurations will have both OMNI's installed in the OMNI-3-75 cabinet. Refer to user manual P/N 7003-972 on MXCTSHL configuration details.

#### 3.5.1 OMNI-3-75 Hardware Versions

Note that original versions of the OMNI-3-75 (version 1) did not have front panel circuit breakers that enable disconnection of the OMNI output to the PACS input. Later versions of the OMNI-3-75 (version 2) do have either one or two front panel breakers. These breakers replace the need to manually connect and disconnect one of the other OMNI in MXCTSHL systems that contain both an OMNI-3-75 and an OMNI-3-37MX.

---

**Note:** The MXCTSHL systems have both OMNI's, OMNI-3-75 and OMNI-3-37MX. Only one of the two circuit breakers should be turned on (connected) at one time. If both are on, the two OMNI's will be in parallel and the correct reference impedance will not be present. Thus, always connect (close) only one of the two circuit breakers on the OMNI-3-75 cabinet at a time.

---

The circuit breakers provide additional protection against over current for each of the relevant OMNI circuits and PACS.

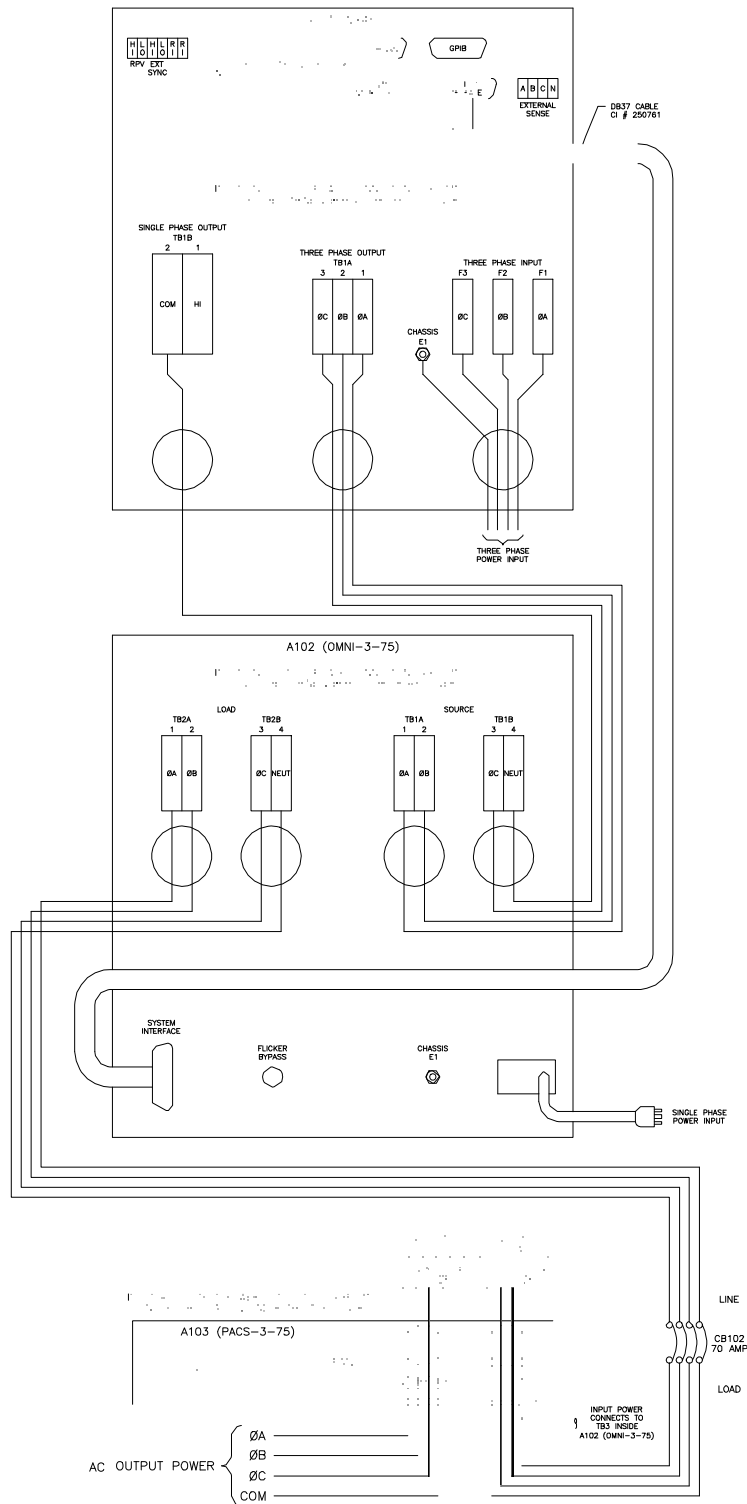

Figure 3-1: MX30-3Pi-CTSH and MX45-3Pi-CTSH with OMNI-3-75 Wiring Diagram – Version 2

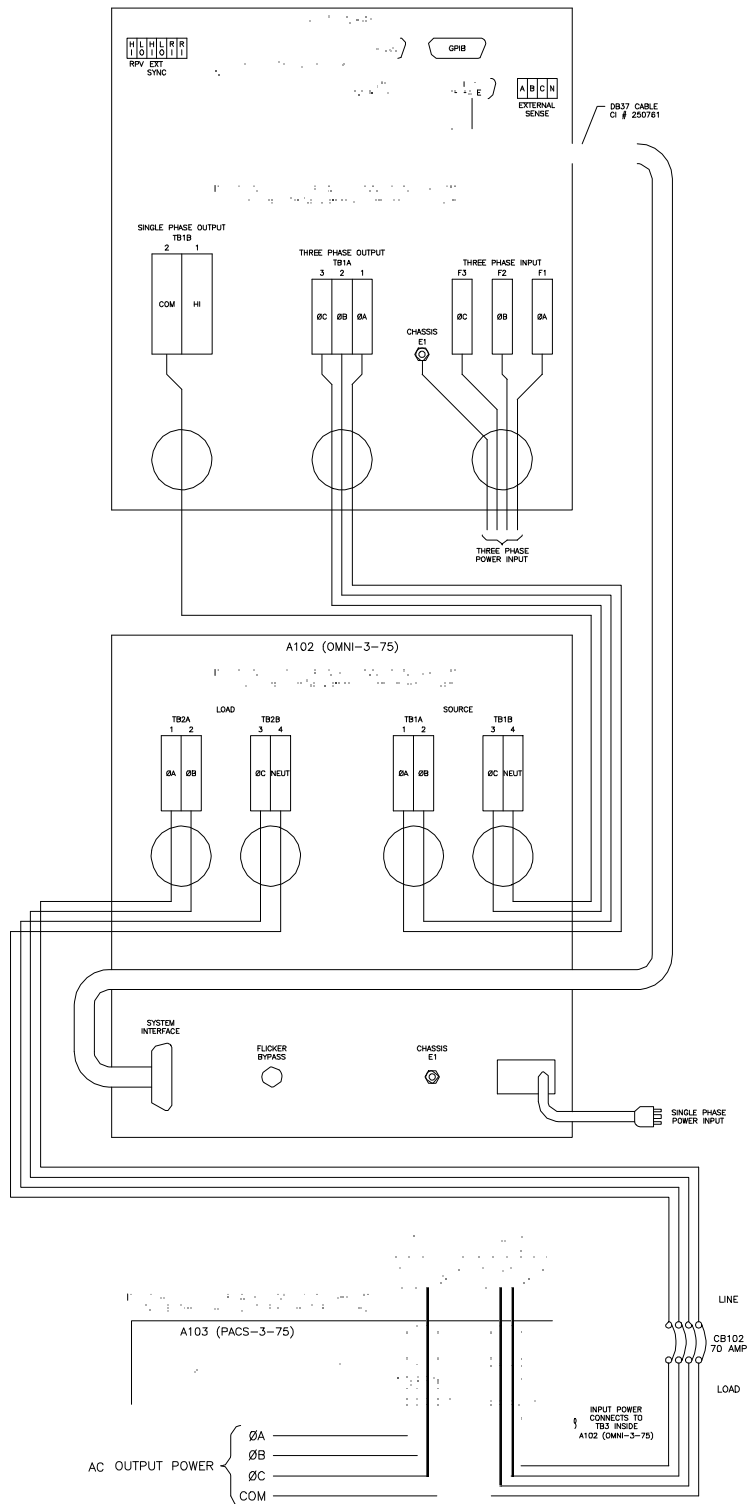

Figure 3-2: MX60-3Pi-CTSH and MX90-3Pi-CTSH with OMNI-3-75 Wiring Diagram – Version 2

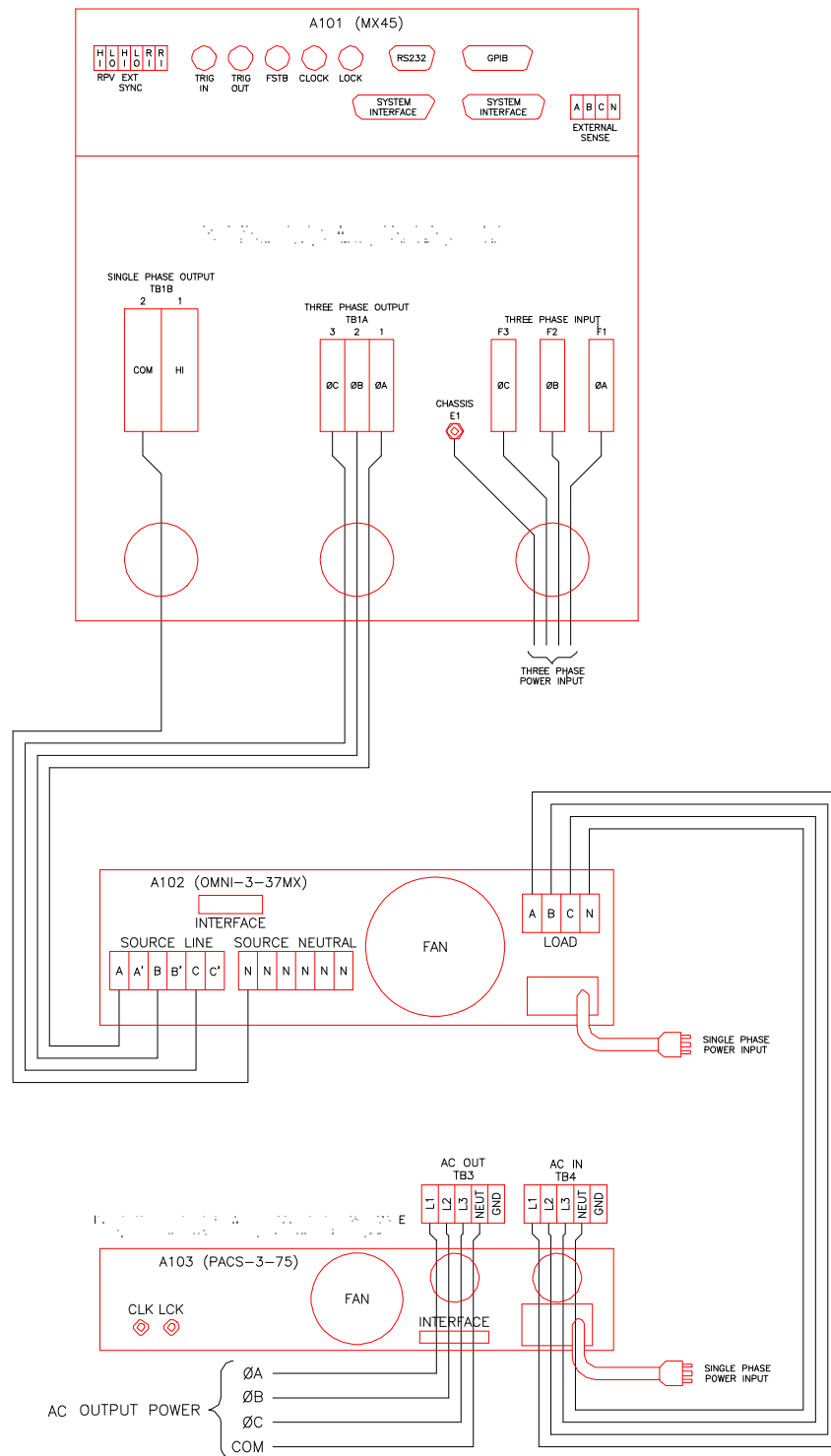

Figure 3-3: MX30-3Pi-CTSL and MX45-3Pi-CTSL with OMNI-3-37MX Wiring Diagram.

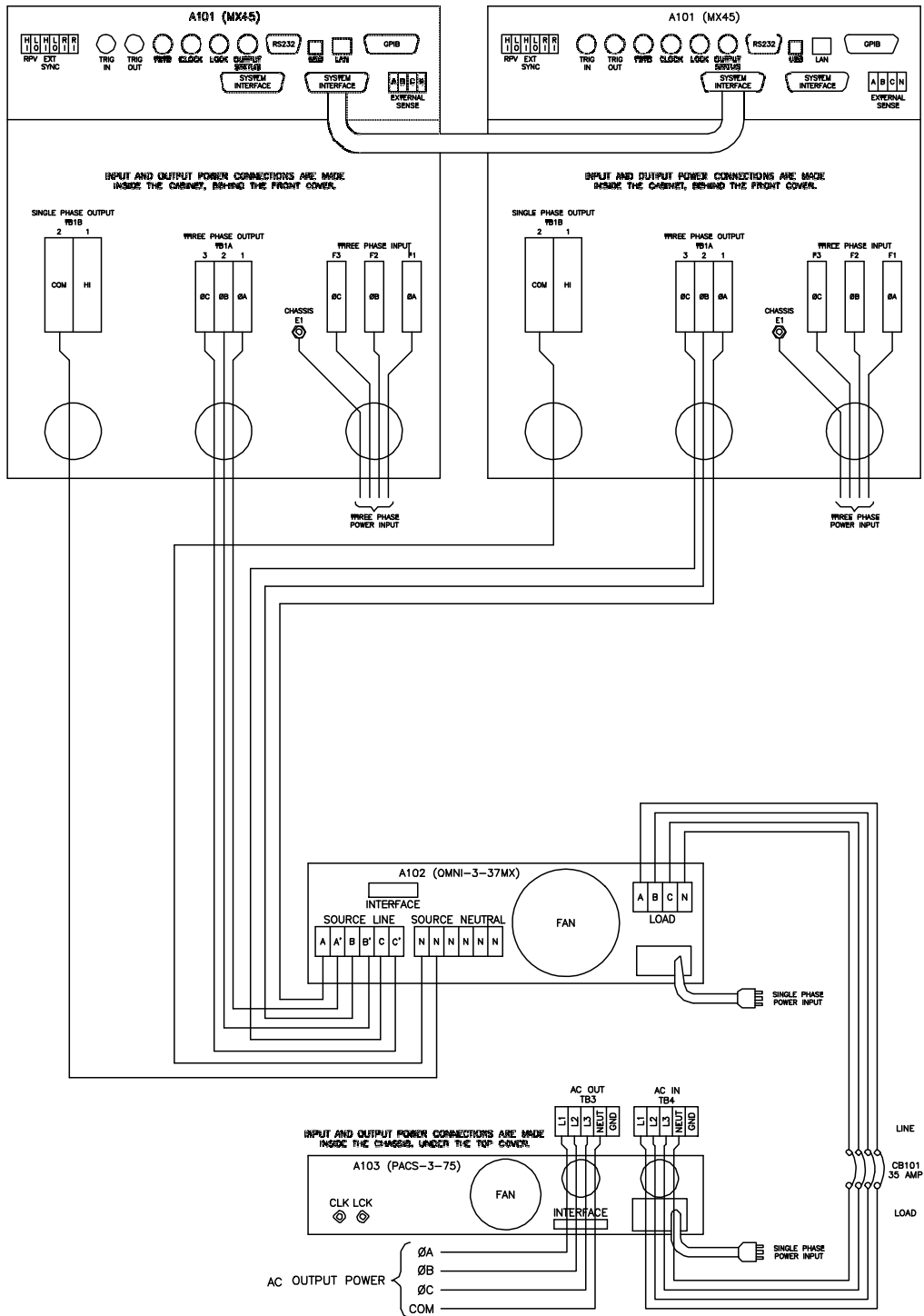

Figure 3-4: MX60-3Pi-CTSL and MX90-3Pi-CTSL with OMNI-3-37MX Wiring Diagram.

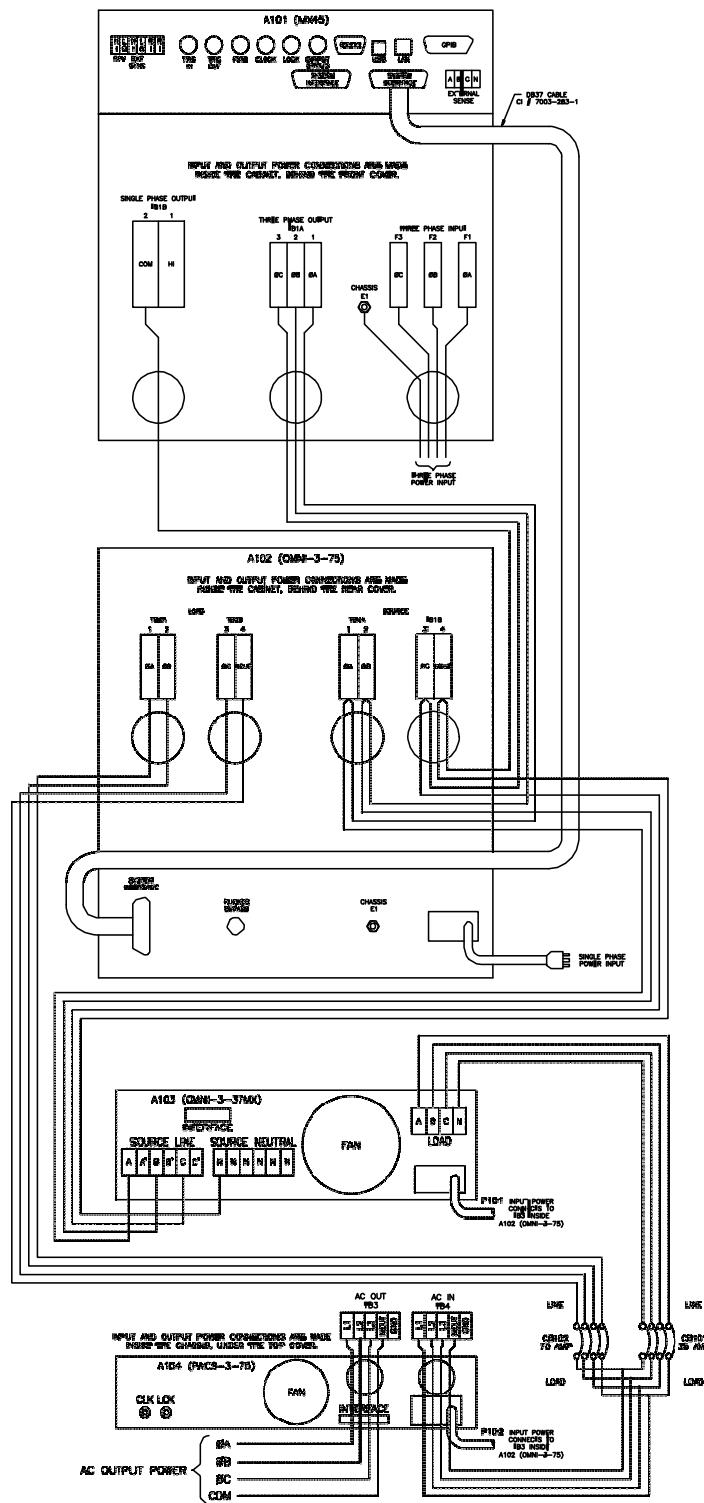

Figure 3-5: MX30-3Pi-CTSHL and MX45-3Pi-CTSHL with dual OMNI's Wiring Diagram – Version 2.

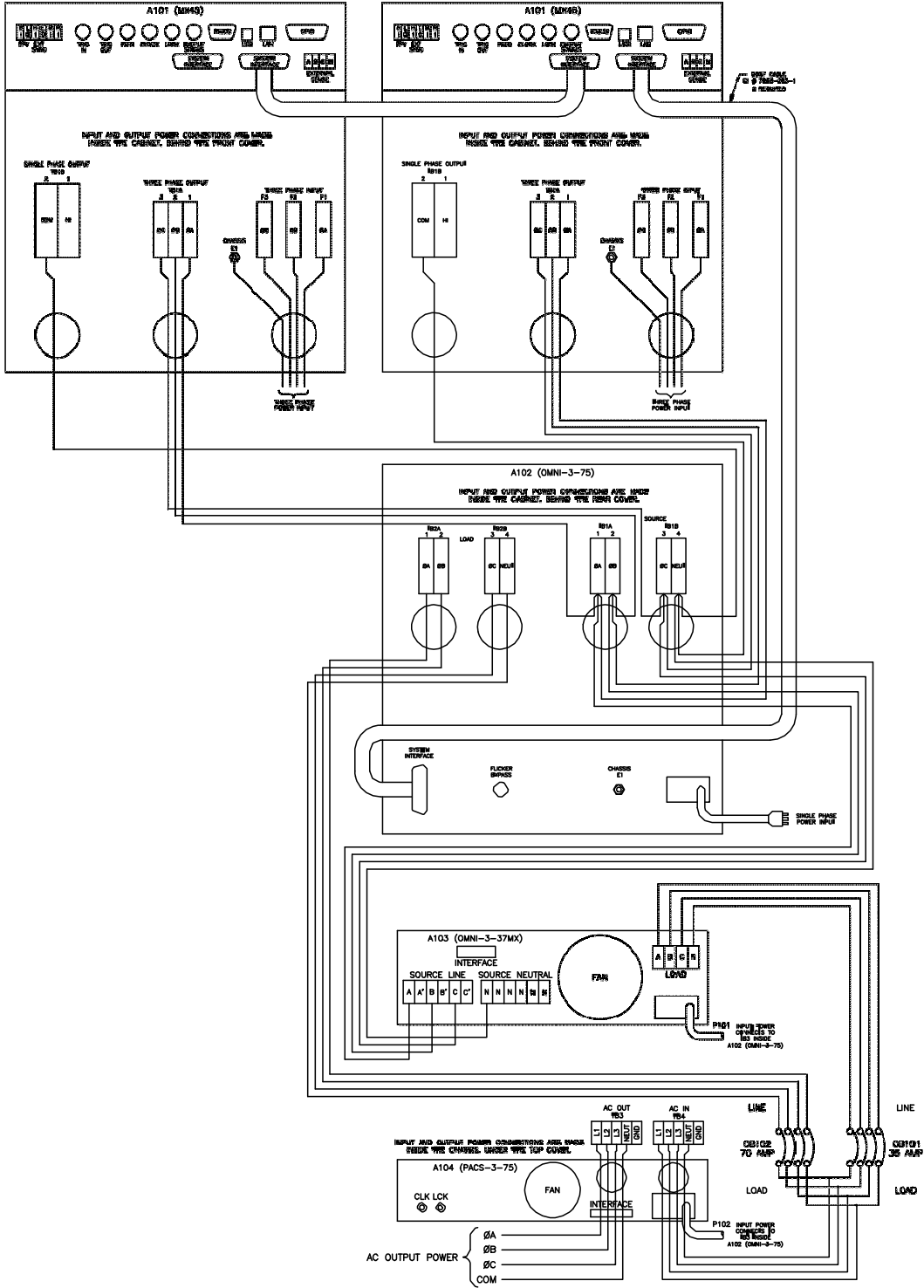

Figure 3-6: MX60-3Pi-CTSHL and MX90-3Pi-CTSHL with dual OMNI's Wiring Diagram.

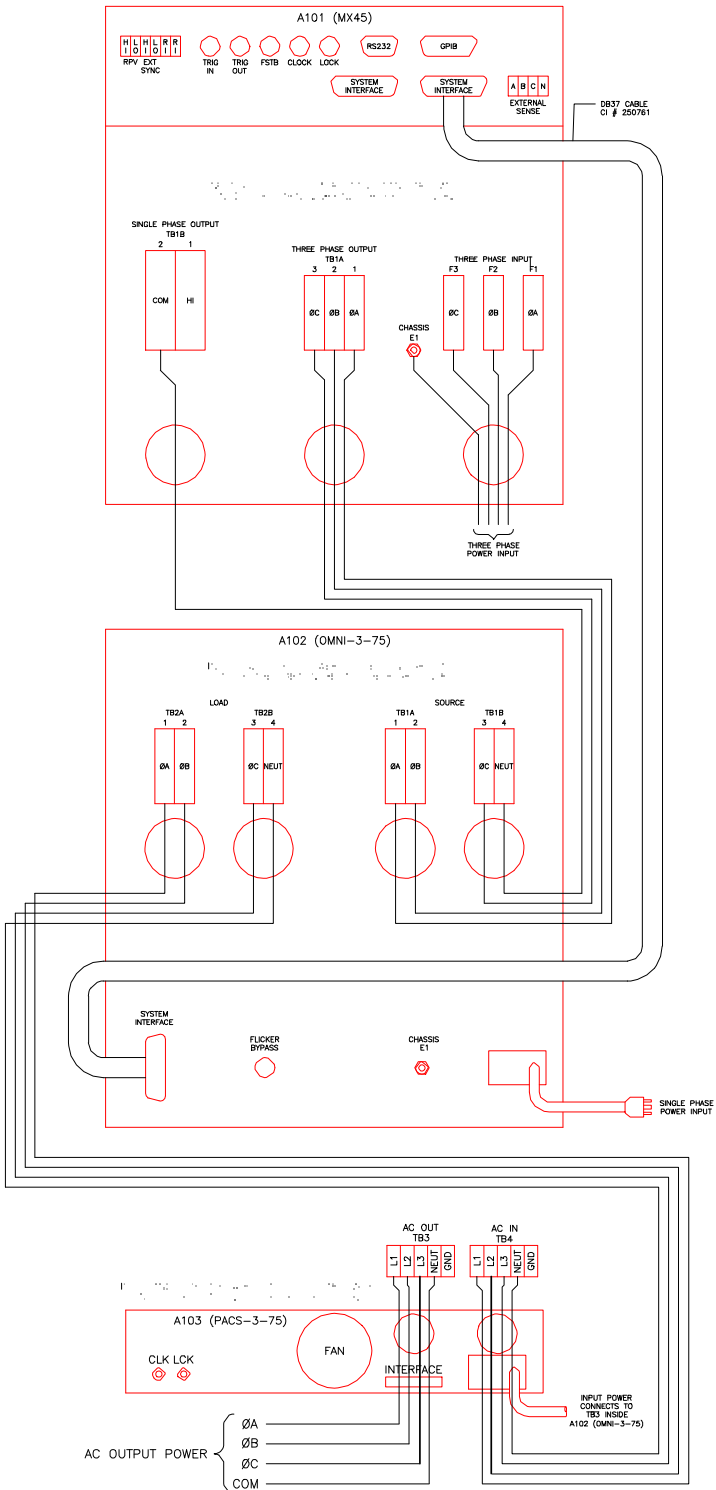

Figure 3-7: MX30-3Pi-CTSH and MX45-3Pi-CTSH with OMNI-3-75 Wiring Diagram - version 1



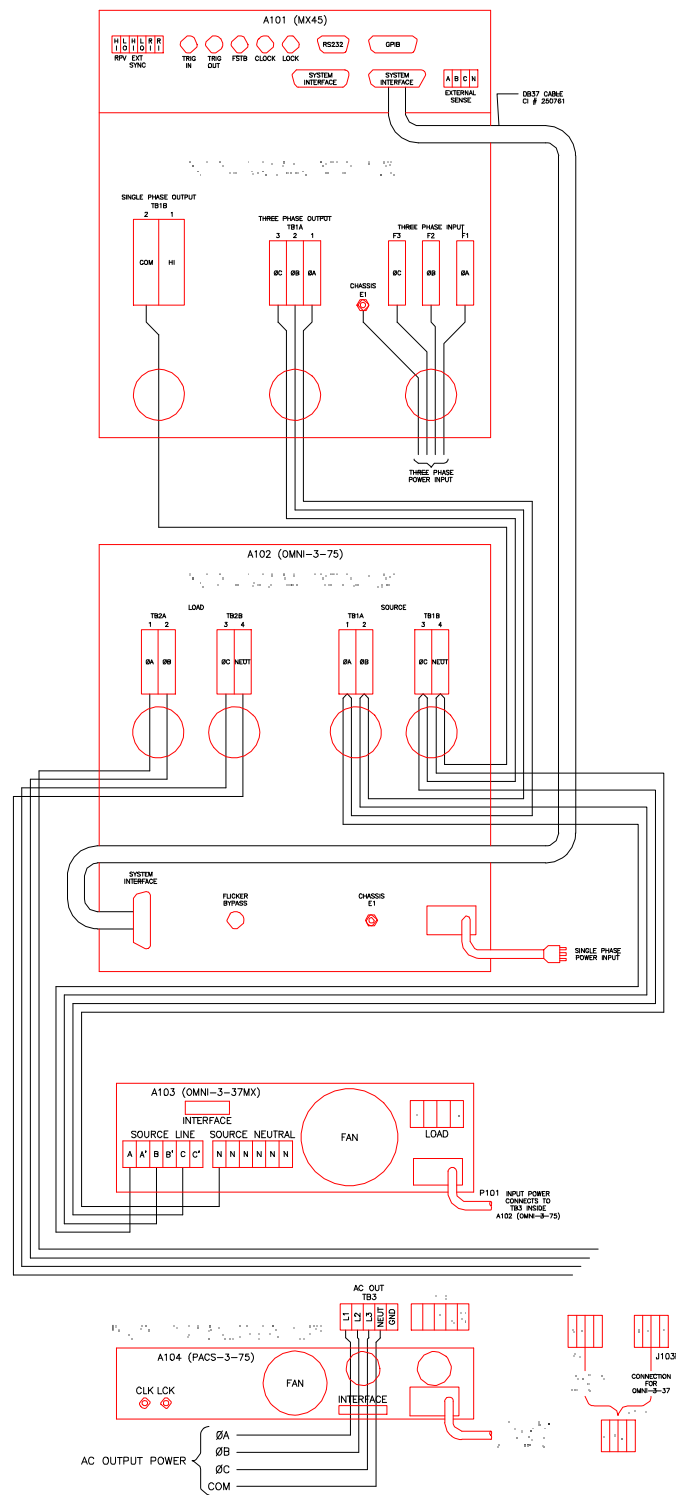

Figure 3-8: MX30-3Pi-CTSHL and MX45-3Pi-CTSHL with dual OMNI's Wiring diagram – version 1

### 3.6 PACS-3-75 Unit

The PACS-3-75 measurement module can be operated on either 115V or 230 V. It requires less than 0.5 Amps to function.

---

**Note:** Check the correct Line input voltage setting of the PACS-3-75 prior to applying line voltage. If incorrect, move the voltage selection to the correct position before applying power. See paragraph 3.6.4.

---

#### 3.6.1 Mechanical Installation

The PACS-3-75 should be placed near the MX and OMNI to minimize cable runs. Both the PACS-3-75 and OMNI-3-37MX can be mounted in a standard cabinet to be placed next to the MX power source.

The units are fan cooled, drawing air in from the sides and exhausting at the rear. The sides of the unit must be kept clear of obstruction and a 6 inch (152 mm) clearance must be maintained to the rear for proper cooling.

#### 3.6.2 EUT Connection Wiring

See Figure 3-9 for wiring configuration depending on system configurations. The wire size used is dictated by the measured currents and voltages. Any wire used must be rated for the maximum expected current and voltage. The PACS-3-75 unit is rated for 75A RMS maximum per phase when the rear power terminals are used and therefore AWG 6 is recommended. The wire gauge for the wiring between the MX and OMNI-3-37MX input should be AWG 4 and is supplied with the MXCTS system.

The PACS-3-75 is rated for 75 A max, and as such requires the use of at least AWG 6 wire gauge or larger diameter to connect to the EUT.



**Caution:** It is important to keep the distance between the PACS-3-75 output and the EUT as short as possible to avoid adding additional wiring impedance to the test setup.

---

This is particularly important for flicker test measurements, as the wire impedance will affect the level of any voltage fluctuations caused by the EUT. Try to limit any output wiring to no more than 5 feet (1.5 meters) or use larger diameter wire as the distance to the EUT increases. Refer to Figure 3-9.



**Caution:** Be sure to replace the small rear top cover on the PACS-3-75 unit after the wiring has been installed, otherwise insufficient cooling of internal components may result. Refer to Figure 3-10.

---

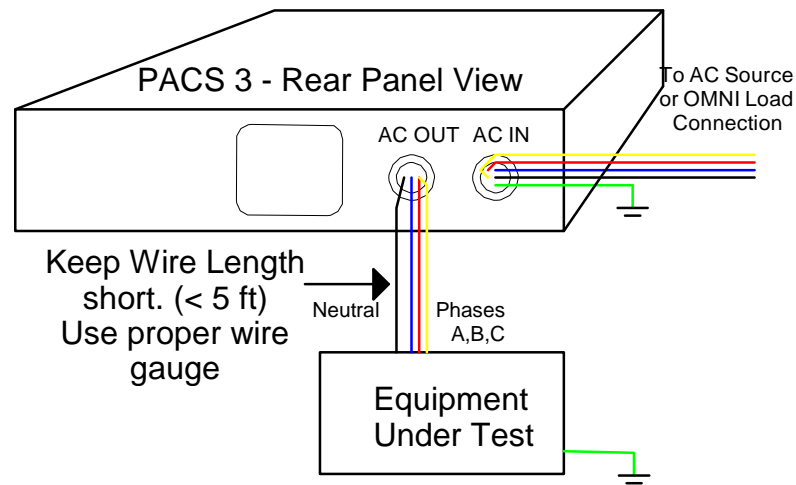

Figure 3-9: EUT Connection distance and wire gauge.

### 3.6.3 Front Panel Connections and Controls

A DB37 PC Interface Connector is located on the front panel. This connector is in parallel with the rear panel connector. Either one can be used to connect to the A/D card in the PC. Use front panel interface connector if rear panel access is difficult.

The "ON" LED indicates The PACS-3-75 module is powered up. Note: Even if the PACS-3-75 unit is powered down, the AC input terminals may still be live if the applied source has not been shut down.

The front panel power switch located on the left-hand side of the PACS-3-75 unit energizes the measurement circuits.

### 3.6.4 PACS-3-75 AC Input Supply

The AC input to the PACS-3-75 unit is on the right side of the rear panel. The molded cord plugs into the combination range change/ fuse holder assembly.

The AC power input module has a red plastic fuse holder that also serves as the input voltage range selecting device. The selected voltage range (115V or 230V) is displayed through a small rectangular window.

To change the fuse:

1. Remove power cord from input module.
2. Pry cover loose with a small screwdriver.
3. Pull out fuse holder, prying with a screwdriver will be necessary.
4. Replace ½ A fuse and reassemble in reverse order.

To change input range:

1. Remove power cord from input module.
2. Pry cover loose with a small screwdriver.
3. Pull out fuse holder, prying with a screwdriver will be necessary.

4. Orient the red fuse holder so that the desired voltage shows through the window. While holding the two fuses in the holder, reinsert the fuse module and close the cover.

The MX-CTSH system as shipped from the factory will generally have the PACS-3-75 line cord connected to the IEC320 AC input socket on the inside of the OMNI-3-75 cabinet. The other end of the line cord plugs into the AC input of the PACS-3-75 unit is on the right side of its rear panel. The molded cord plugs into the combination range change/ fuse holder assembly.

### 3.6.5 Measurement Input / Output Connections

The AC power input to be measured must pass through the cable strain relief clamp at AC INPUT and then to connector TB4, located just behind the rear panel. Similarly, the wires from TB3 are routed through the cable clamp at AC OUTPUT to the Equipment Under Test.

### 3.6.6 PC Interface, Clock and Lock Interface

The PC interface connector accepts the DB-37 interface cable that goes to the PC with the AD Card and the CTSMXL Software. This connector is available on both the front and the back of the PACS-3-75. Either one can be used to connect to the PC A/D card (CIC400PCI, CIC401PCI or CIC403PCI).

---

**Note:** When connecting the high density 68 pin connector to the back of the A/D card in the PC, make sure to align the cable plug with the A/D card connector carefully so as not to bent any pin. The connector should insert easily. If undue force is needed, the plug may not be aligned properly or one or more pins may be bent. Check the plug and connector carefully before installing the supplied cable between the PACS-3-75 and the PC.

---

The CLOCK and LOCK BNC connectors are available for future interface capabilities to CI power sources.

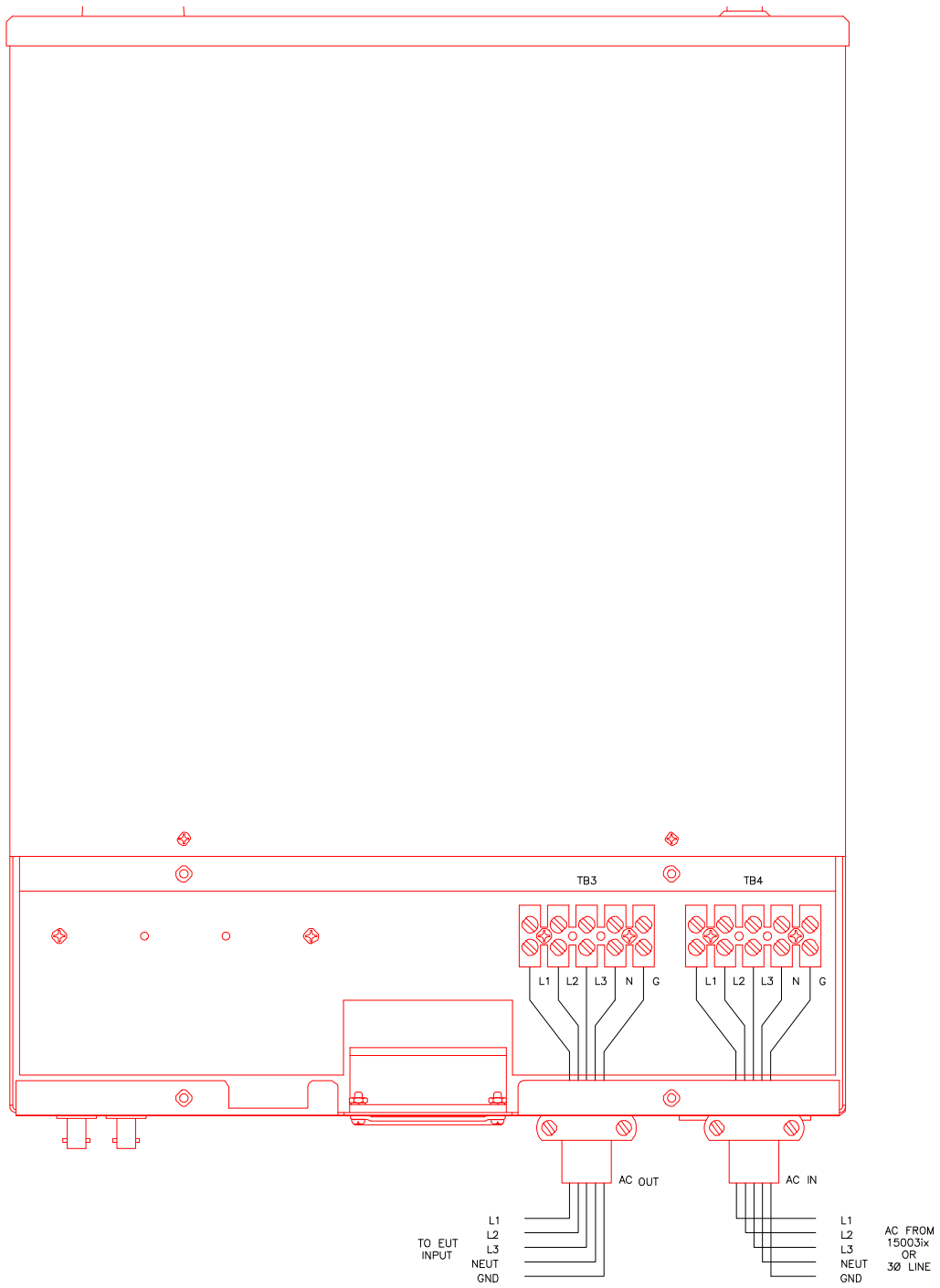

Figure 3-10: Power Connections for PACS-3-75

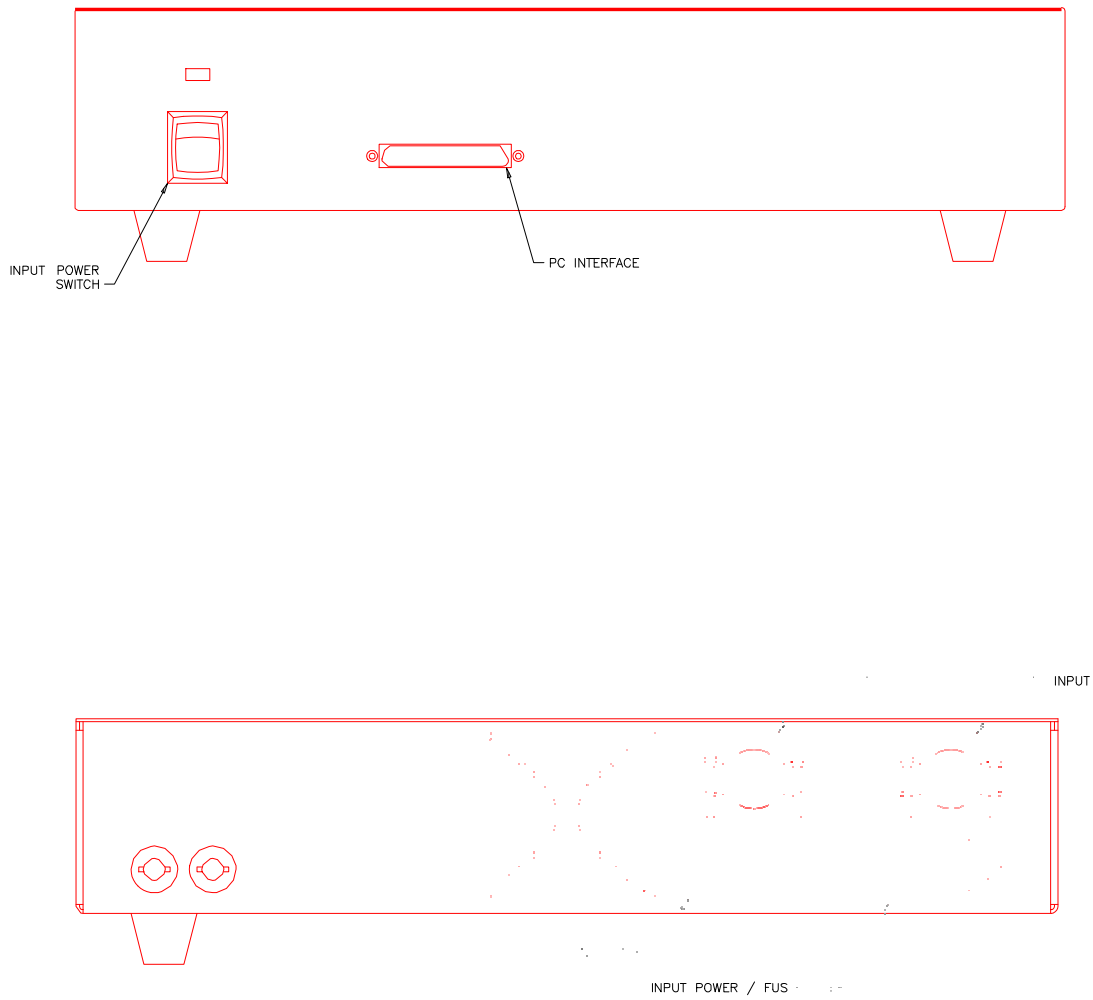

Figure 3-11: Front and Rear Panel Views of the PACS-3-75 Module.

### 3.7 Functional Test

If it is desired to perform a functional test of the system, the following procedure can be used. However, the A/D signal card and the CTSMXL Software must first be installed for proper operation. See installation instructions later in this section.



**CAUTION:** Work carefully when performing this test, hazardous voltages will be present on the AC input and output connections during this test.

---

Refer to Figure 3-1 for detailed installation diagrams.

1. Connect a current transformer to the neutral wire going into the AC input port at TB4 on the rear of the PACS-3-75 unit. Connect the CT output to a DMM to read the actual input current.
2. Connect a DMM to the line and neutral connections at TB4 inside the rear panel.
3. Connect a 10  $\Omega$  load to the rear panel AC outlet port at TB3, phase A to Neutral.
4. Enable the AC power input to the PACS-3-75 unit, whether from the line or from a power source. Apply 120Volts AC at 60Hz.
5. Start the **CTSMXL Software** in harmonics mode and measure the load current and voltage from the MXCTSL GUI. Verify the GUI readings and the external DMM readings for current and voltage are within 1% of each other.
6. Turn off AC source output and repeat steps 2 through 5 for phases B and C. If a suitable three-phase load is available, all three phases can be checked at once.

In the unlikely event the system does not pass the functional test, refer to the calibration procedure in section 17, or, refer to the service procedure in Section 19. If the problem cannot be resolved, call California Instruments' customer satisfaction department for further assistance.

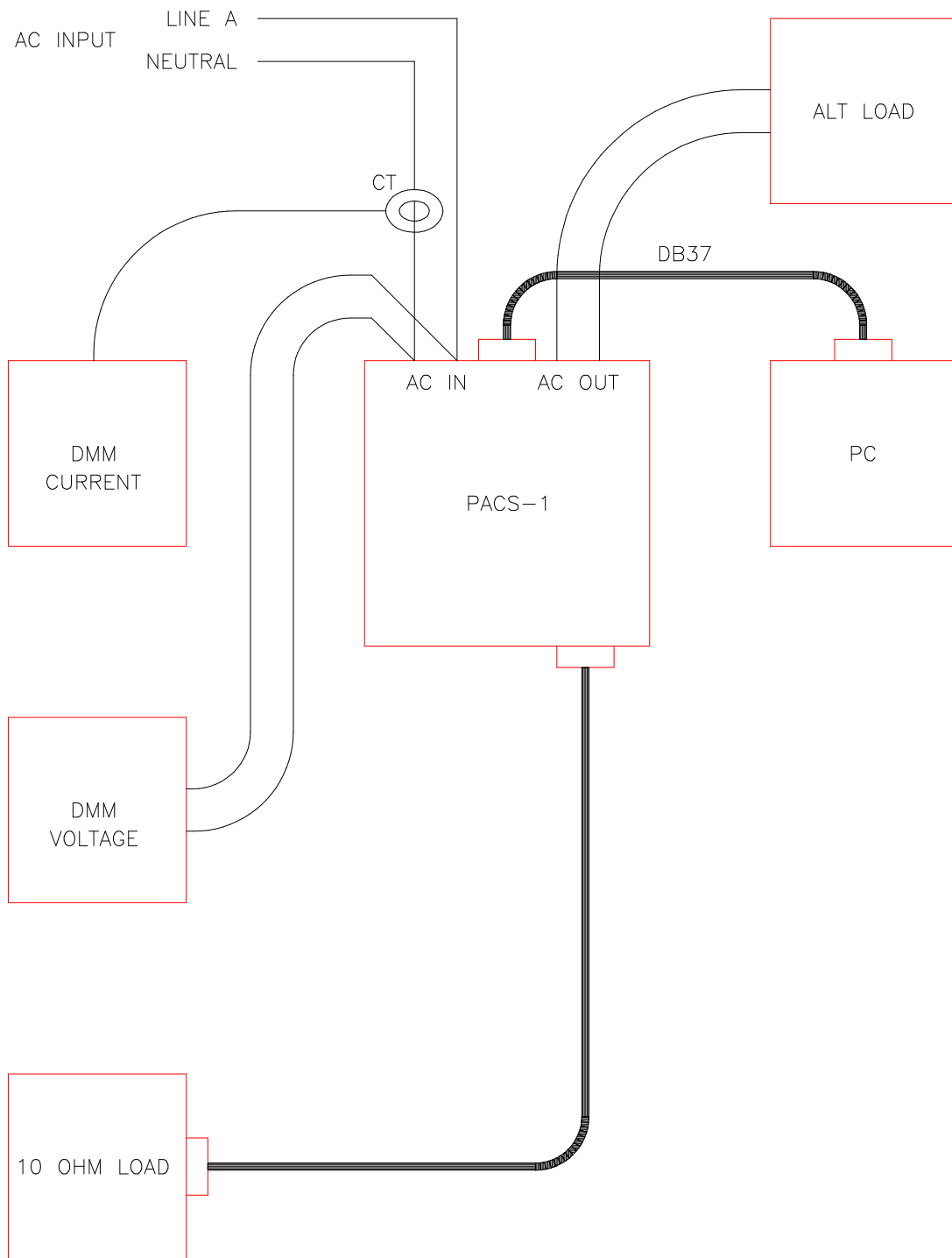

Figure 3-1: Functional Test Setup



### 3.8 Data Acquisition Card Installation - PCI Card Version

All measurements in the CTS System are performed through a dedicated data acquisition card that needs to be installed in the host PC. The PC that this card is being installed in must have at least 512 Mbyte (4GB on software version 2.0 or newer) of RAM memory for the card and software program to work correctly. This section provides the necessary installation procedure for both hardware and software of the PCI version A/D Card. The PCI card is a Windows compliant Plug-n-Play card that requires a single PCI slot in the test system PC. The card driver is installed along with the CTSMXL software.

#### 3.8.1 Unpacking and Handling

The following items are included as part of the PCI Card:

- A/D conversion board, CI401PCI or CI403PCI Exacq A/D card.

**Or**

- A/D conversion board, National Instruments PCI-6034E Series with NI-DAQ CD Rom.
- 68 to 37 pin adapter cable, HD68 (High Density) male to DB37 male connector.

Verify that all components are available. The CTS system will not operate if any of these items are missing. If any item is missing or visibly damaged, contact California Instruments customer service department immediately. Refer to page 3 for details on contacting California Instruments. Retain the original packaging material for the card and its accessories in the event you ever need to return the PCI A/D card to California Instruments.

Keep the PCI card in its protective anti-static bag until you are ready to install it in an available PCI slot of the host PC. This will minimize the chance of damage due to electrostatic discharge. When you finally do remove the card from the bag, make sure you are wearing a wrist ground strap and hold the card by its edge to avoid touching any of the components.

There are no jumpers or DIP-switch settings on the PCI A/D card as all configuration data is retained in EEPROM.

Note that the National Instruments CD ROM with the NIDAQ drivers is included with the NI PCI-6034E card. If your system was supplied with this A/D card, **YOU MUST USE THE NI CD-ROM** to install the A/D card drivers. For systems supplied with an Exacq A/C card, the card driver is on the same CD ROM as the MXCTSL software.

**The correct order of installation is:**

1. Install the PCI Card drivers first.
2. Turn off the PC and install the PCI A/D card in an available PCI slot.
3. Reboot the PC and let Windows find the A/D card and complete installation of the drivers.
4. Install the CTSMXL software from the CIC652 CD ROM.

### 3.8.2 Installing the PCI Card Driver Software

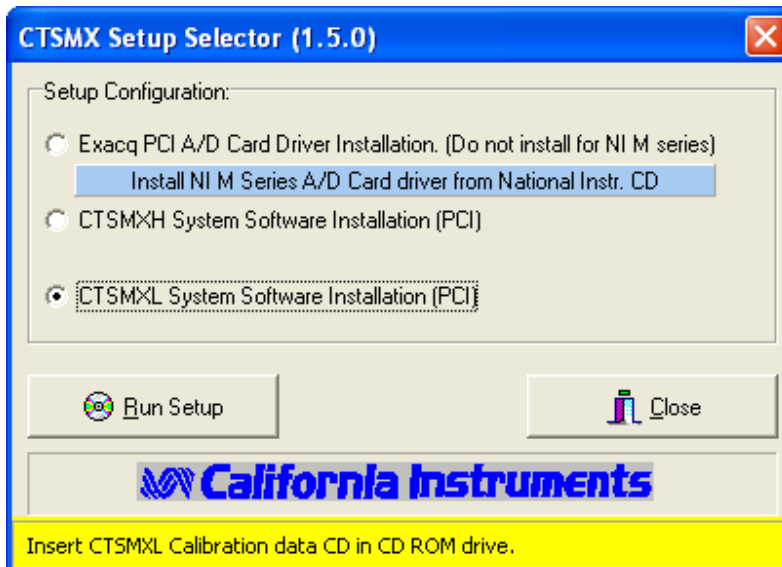

Insert the CIC652 in the CD ROM drive. The setup.exe program should start if the CD ROM drive is configured for AutoStart. If not, double click on the Setup.exe program to launch the installation wizard. Select the CI401PCI / CI403PCI Card Driver Installation and click on the Run Setup button.

Follow the installation prompts for the Driver installation to install the A/D Card drivers.

If your system was supplied with a NI PCI-6034E card instead, install the card drivers from the NI-DAQ CD Rom instead.

### 3.8.3 Installing the PCI A/D Card

Following the procedure outlined below to install the PCI card in the test system PC:

1. Disconnect your PC from any main power.
2. If possible, wear a grounded wrist strap to prevent ESD damage to the PC and the A/D Card and place the PC cabinet on a firm ESD safe working surface.
3. Remove the cover of the PC cabinet following the directions provided by the PC manufacturer.
4. Locate the PC's PCI bus expansion slots. The CI400PCI requires a single 32 bit PCI slot.
5. Using a suitable screwdriver (typically Phillips #2), remove the cover plate for the slot you opted to use in step 4. The A/D card has its own cover plate so the one you remove may be saved or discarded at your own discretion. You will need to re-use the screw however, so make sure you do not lose it.
6. Carefully remove the PCI card from its protective bag and hold it along the top edge. Take care not to touch the gold finger edge connectors at the bottom.
7. Insert the card carefully in the selected slot making sure the DB68 connector clears the slot in the back of the PC. Press down firmly along the top edge of the board to make sure the board is seated properly in the PCI slot connector. It may help to rock the board gently or start from one end of the edge connector.
8. Install the screw you removed in step 5 and secure the PCI board to the PC slot by its cover plate.
9. If you plan to use an IEEE-488 Controller to communicate with the AC Source and have not installed one in the host PC yet, now would be a good time to do so. Follow the Bus Controller manufacturer's instructions for installation.
10. Replace the PC's cover following the directions provided by the PC manufacturer.

### 3.8.4 Testing the PCI Card

The CTSMXL software must be installed first before performing a A/D card testing. After CTSMXL software is installed, the PC must be rebooted. The new hardware should be detected automatically at boot by the Windows™ operating system. Follow the on-screen prompts to finish installation of the A/D card.

---

**Note:** When connecting the high density 68 pin connector to the back of the A/D card in the PC, make sure to align the cable plug with the A/D card connector carefully so as not to bent any pin. The connector should insert easily. If undue force is needed, the plug may not be aligned properly or one or more pins may be bent. Check the plug and connector carefully before installing the supplied cable between the PACS-3-75 and the PC.

---

#### NI E-Series DAQ Board

Once the PCI A/D card is installed and the PC has been re-booted, you should see a “Measurement and Automation” icon on the desktop. Double click on it and expand the Devices and Interfaces tree, you will now see the PCI card you installed as shown in the screen below.

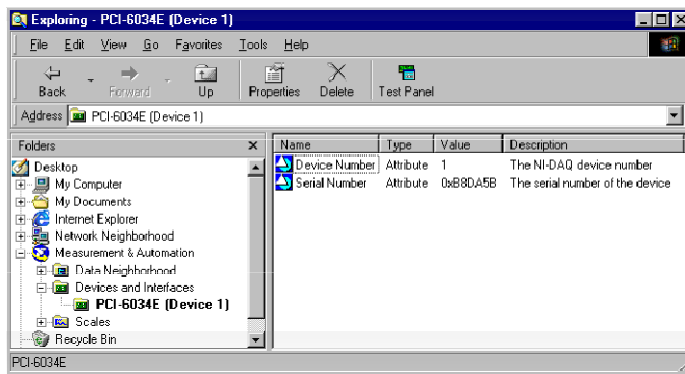

#### NI M-Series DAQ Board

Launch Measurement and Automation, select NI-DAQmx Devices, NI PCI-6250: “Dev1”.

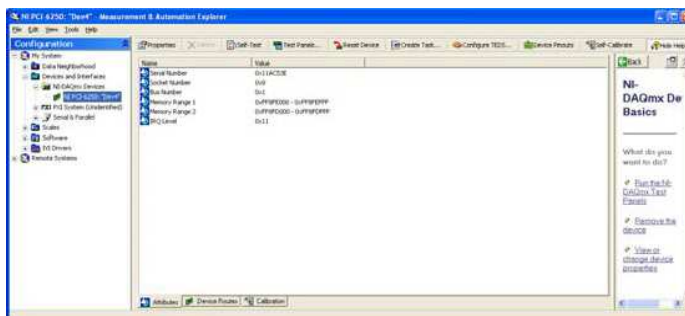

Select “Self-Test” and you should get the pop-up message below.

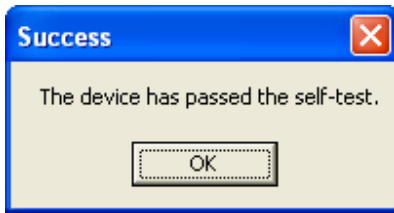

You can run "Test Panels..." to do a further functional check of the CTS hardware, and interconnect cable between the A/D card and the PACS (CTS signal conditioning unit).

Highlight NI PCI-6250: "Dev1", select "Test Panels...", set Channel Name to "Dev1/ai0", set Mode to continuous, set Input Configuration to RSE, set Rate(Hz) to 10000.

Make sure the PACS is powered up, and the A/D card cable is properly attached to both the card, and the PACS. Of course, the power source needs to be operating, and must supply an appropriate voltage to the measurement system.

Set the power source to 230 Volt – 50 Hz. This voltage is routed to logical channel 0 of the A/D card, via a differential input amplifier and a 100: 1 attenuation factor in the PACS. The display should be about 2.30 Volt rms for a 230 Volt – 50 Hz input voltage. (See below picture for detail)

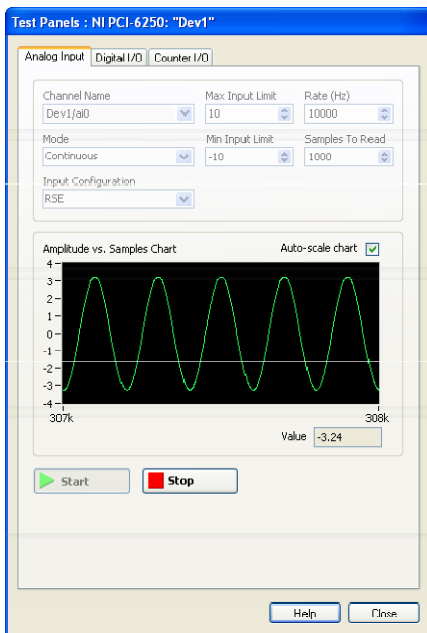

**Exacq Technologies Card**

After installing the A/D card in an available PCI slot, you must configure the card for operation in the CTS. Generally, the PCI card will be the only A/D card to be used in your PC, but in case there are more cards present, contact the factory for details concerning multi-card configuration.

Card Reference numbers:

CI Designation	Exacq P/N	System
CI401PCI	CM2110	Single phase systems
CI403PCI	CM2210	Three phase systems

After installing the PCI card, turn the computer back on. When Microsoft Windows starts up, it should discover the new Exacq A/D device.

Next, you need to test the A/D card in your computer, and configure the A/D card for use with the CTS software. After the PC starts up, you will have a new Program Group, called Exacq. Start the application called Exacq Control Center from this new Exacq program group on the Windows Start menu. See Figure 3-12 below.

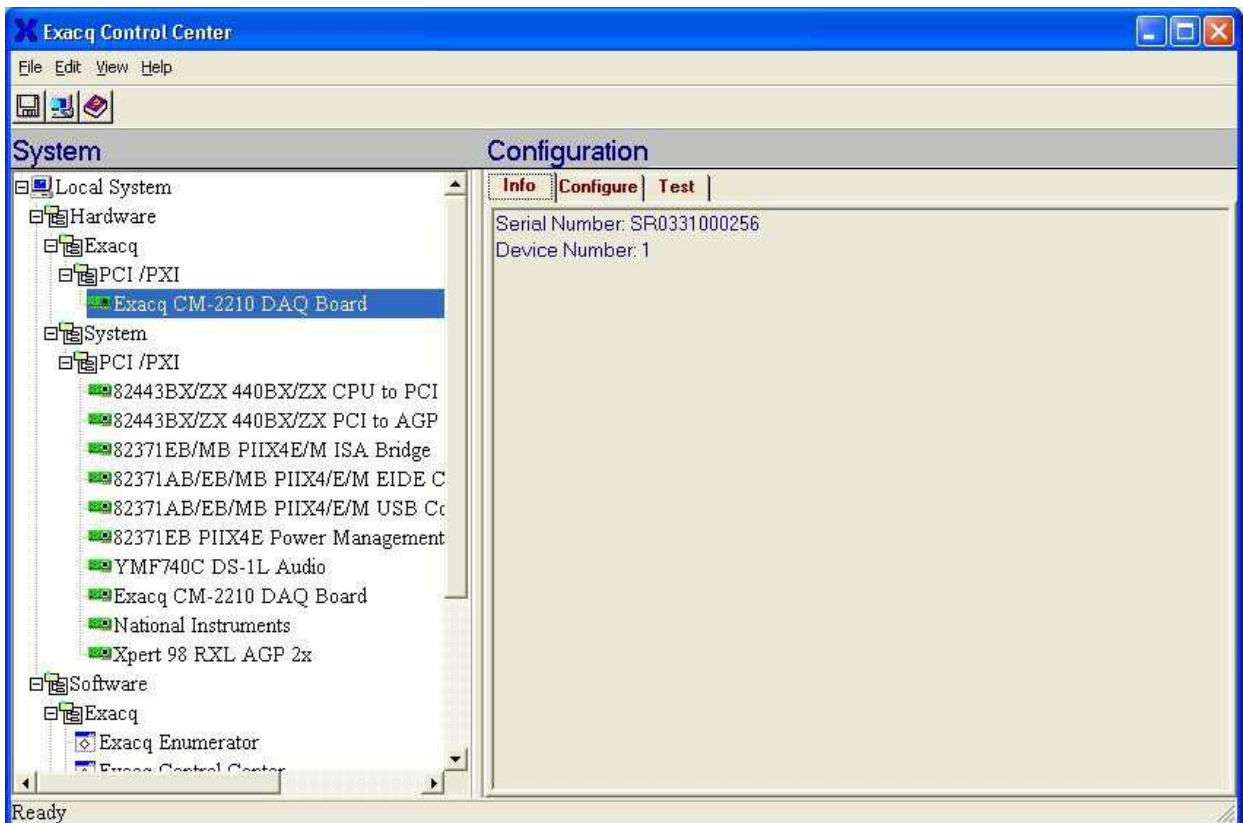

Figure 3-12: Exacq Control Center Screen.

The new data acquisition card will appear as a node in the LocalSystem | Hardware | Exacq | PCI/PXI branch of the System tree.

Click on this node. The serial number and logical device number will display in the Configuration pane. The logical device number is the identification that application software such as the CTS uses to specify which hardware device will be used. This device number should only be changed if you have multiple A/D cards in the PC. (See Figure 3-13 below).

Otherwise, leave the number as is. In the event this is necessary, you may change the assigned device number by clicking on the configuration tab and selecting a new number using the device number edit control. Only knowledgeable users should make changes to these settings.

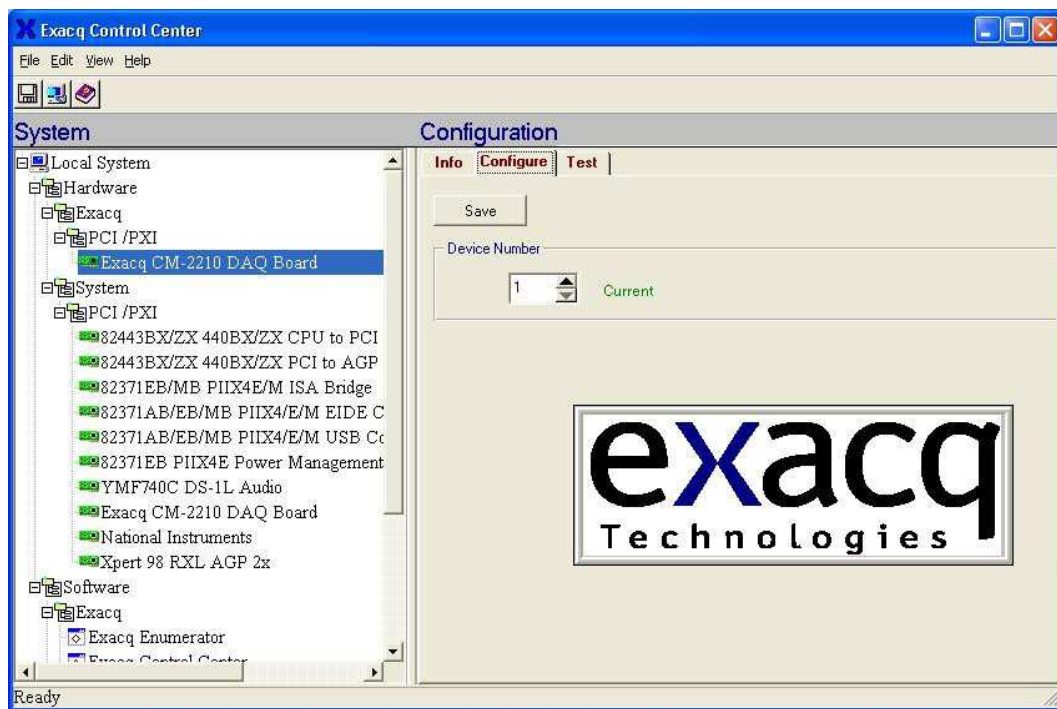

Figure 3-13: Exacq Card Device Number

You are now ready to verify that the A/D card functions properly in your PC. To do so, select the “Test” tab in the Configuration panel. This will bring up the test panel (see illustrations Figure 3-14, Figure 3-15 and Figure 3-16 on following pages). This test panel can be used to test all analog input channels and analog output channels as well as the digital IO lines. You can test Channel 0 (zero) as shown below. Assuming you have connected the interface cable to the PACS signal-conditioning unit, and the PACS receives the supply from the power source, the display will look similar to the figure below. Assuming the card functions properly, installation and configuration of the Exacq data acquisition hardware and software is now complete.

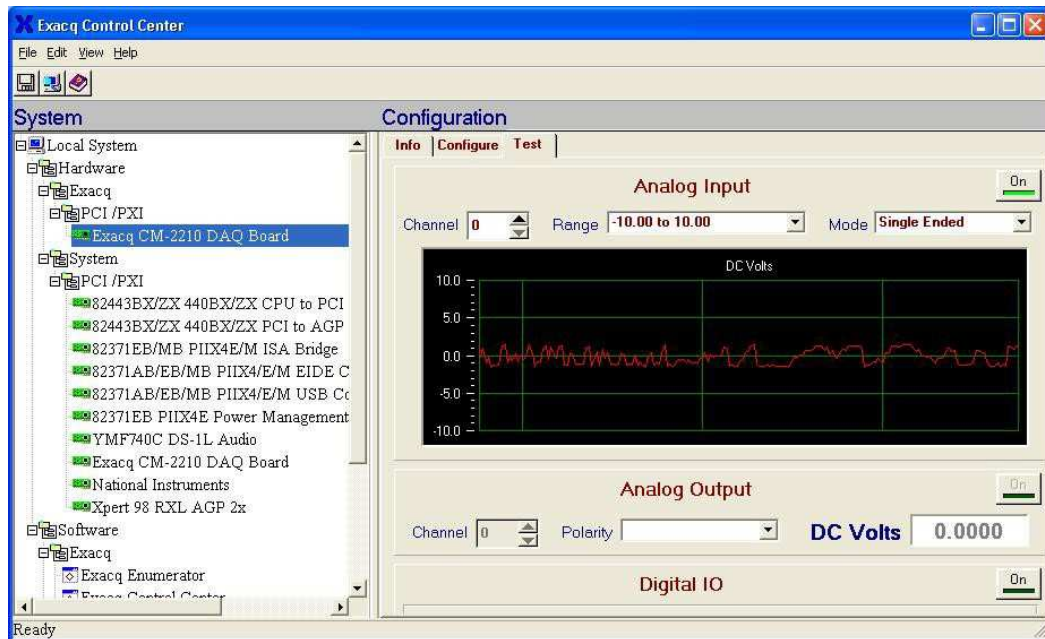

Figure 3-14: Exacq Test Panel

You can run the Exacq Bench software to do a further functional check of the CTS hardware, and interconnect cable between the A/D card and the PACS (CTS signal conditioning unit). Close the Exacq Control Center window. Start the application called Exacq Bench from this new Exacq program group on the Windows Start menu.

Make sure the PACS is powered up, and the A/D card cable is properly attached to both the card, and the PACS. Of course, the power source needs to be operating, and must supply an appropriate voltage to the measurement system.

You may now apply a load to the CTS. Typically, this will be the 230 Volt – 50 Hz supply voltage that is used to power the products to be tested. This voltage is routed to logical channel 0 of the A/D card, via a differential input amplifier and a 100: 1 attenuation factor in the PACS. On the Exacq Bench menu bar, select “Instrument”, “Volt Meter”. Thus, the Exacq Bench DVM function will display approximately 1.00 volt for a 100 Volt AC voltage setting of the power source, such as may be used in Japan (see the example of the DVM function below). The display should be about 2.30 Volt rms for a 230 Volt – 50 Hz input voltage. Note that the system calibration will eliminate small errors due to hardware tolerances. Thus, the ratio is not necessarily exactly 100:1.

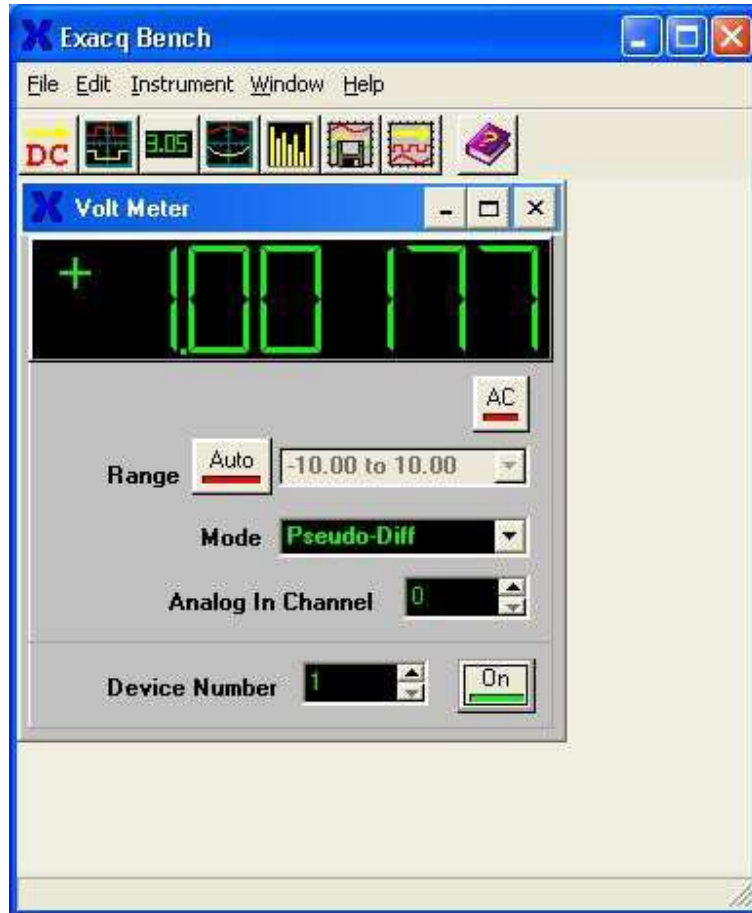

Figure 3-15: Exacq DMM Screen



Of course, you may also use the oscilloscope function of the Exacq Bench to display the time domain signals. Refer to the appropriate section of this manual to identify all the signals and channel numbers, but for this example, channel 0 is for voltage, and channels 1,2,3 are the (parallel) three current signals. In the figure below, channel 0 and 3 are displayed (channel 3 is the most sensitive current channel). The CTS power source was set to 230 Volt – 50 Hz, and a resistive load with a dimmer set to approximately 90 degrees firing angle was applied. The (yellow) current signal was 2.0 Amp rms and the (red) voltage was 230 Volt. The settings for the scope channels and time base function were adjusted to obtain the display as shown in the figure.

Upon completion of the above tests, you may proceed with installing the CTS software modules that were supplied with your system.

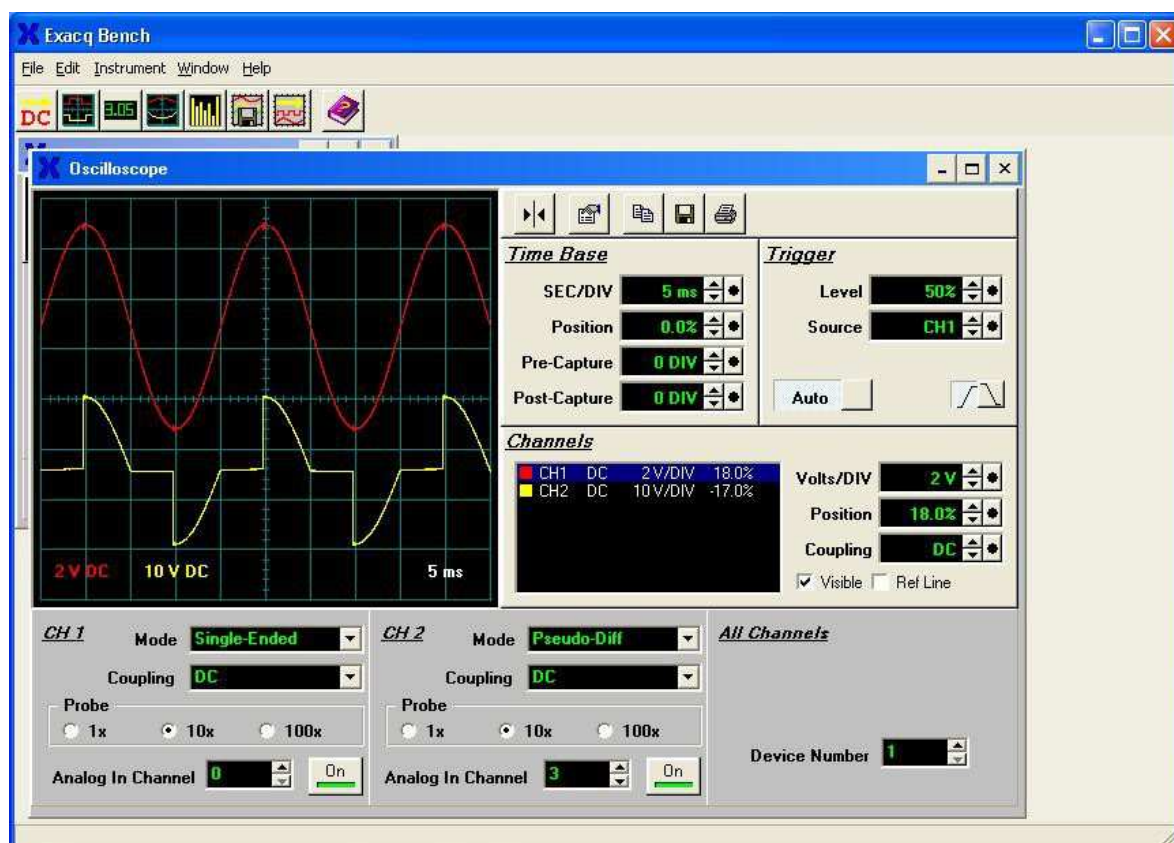

Figure 3-16: Exacq Scope Test Panel

### 3.8.5 CTS / GPIB Software Setting Conflict. (For NI PCI-6034E Card Users only)

Each time the CTS is run, a function is called to initialize the A/D card. This call, "Init\_DA\_brds", actually does more than A/D initialization. It also sends some commands to the instrument with GPIB address #1 when using a NI GPIB controller. The AC source if used over the IEEE-488 bus is factory set to address 1. This may cause a problem unless the IEEE-488 address on the power source is changed to an address other than 1.

The address can be left at 1 on the power source if needed by changing the visaconf.ini file. This file is typically residing in "c:\vxi\np\win95\nivisa" directory. (If not located in this directory, use the Windows Explorer Find function to locate this file.) This file is not distributed with the CTS software. It is installed when the National Instruments GPIB software is installed. There is a line under [GPIB-VXI-CONFIG]: DisableAutoFind=0. The 0 needs to be changed to 1.

### 3.9 CTSMXL Software Installation

Once the card drivers have been installed, the CTSMXL Software can be installed next.

The A/D card requires a device driver to be installed. If you did not install the PCI driver and A/D card, go back to section 3.8.

The MXCTSL system software is supplied on a CD-ROM. The CD-ROM contains compressed files that are needed to operate MXCTS system properly. Since these files are in compressed form, they should not be copied to your PC's hard disk since they will not function in this form. Instead, the setup program that is included on the CD-ROM should be used to install all the files.

An additional CD ROM is provided containing the system calibration data.

To install the CTSMXL Software, proceed as follows:

1. Insert the CIC652 CD-ROM into your CD-ROM drive and wait a moment for the drive to recognize the CD.
2. The program should start automatically. If not, select **Start->Run...** from the Windows Start menu and type D:\setup.exe, assuming your CD-ROM is the D drive.
3. The CI CD ROM Browser as shown to the right should now appear on screen.
4. Select MX45-CTSL Series under Compliance Test Systems in the left hand side Model Series pane.
5. Next, select the GUI Software Tab on the right hand side. Then click on the "Execute Selection" button at the bottom of the screen.
6. This will bring up the CTSMX Setup Selector, which is used to copy the required calibration data to the user's PC. Select the version of the CTSMX you want to install, in this case "CTSMXL System Software Installation (PCI)".
7. Remove the CIC652 installation CD and replace it with the Calibration Data CD that came with the CTS system.
8. Click on "Run Setup" and wait for the calibration data to be copied. This will take very little time.
9. You will now be prompted to re-insert the CIC652 installation CD ROM.
10. Remove the Calibration CD and replace it with the CIC652 installation CD. The CI browser may reappear when you close the CD drive door as your CD drive may be set to autorun. You can either ignore or close the second instance of the CI Browser program.
11. Click the OK button to confirm that the CIC652 CD is back in the CD ROM drive. This will launch the CTSMXL installation program.
12. Follow the on screen installation program prompts to complete the CTSMXL system software setup.
13. Once completed, you can remove the CD-ROM. You may have to reboot the computer after the software installation. This will be indicated at the end of the installation program.

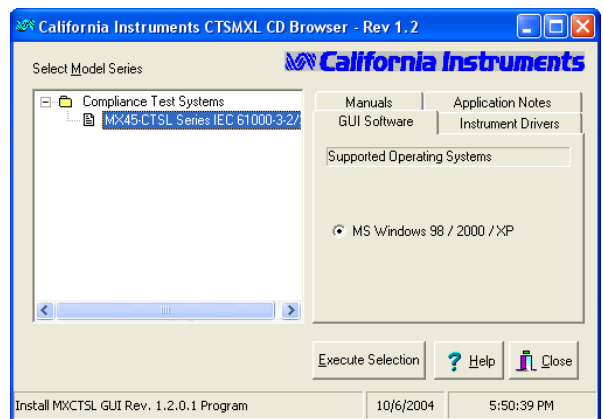

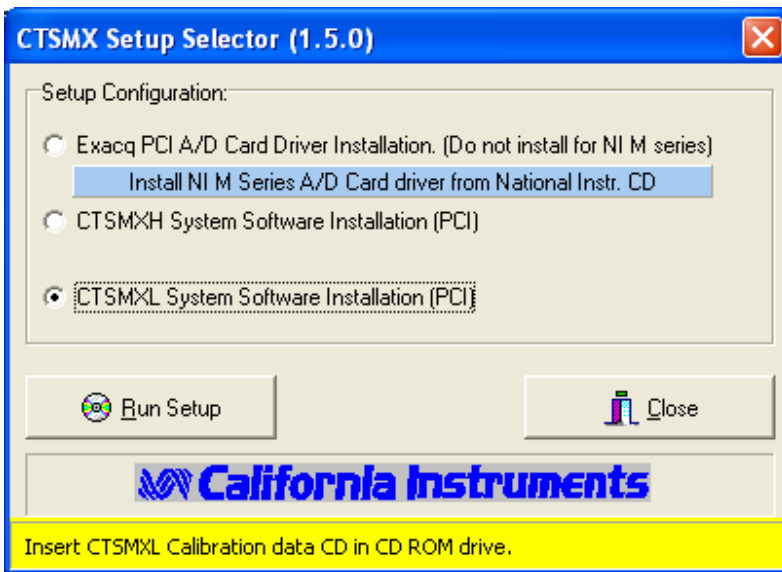

The installation program will create a new entry in the Programs Menu called “CTS MXL”. This menu has several sub-menu entries, one for the main test program and several for the calibration and configuration programs as well as a few utility programs. We recommend you keep the calibration and installation CD-ROM's in a safe place in case you ever need to re-install the CTSMXL Software.

If the calibration data is not found during the installation process, you still have to option of continuing with the software installation. A dialog box will prompt you to abort (Cancel) or continue (OK). If you continue, the calibration data will have to be provided later.

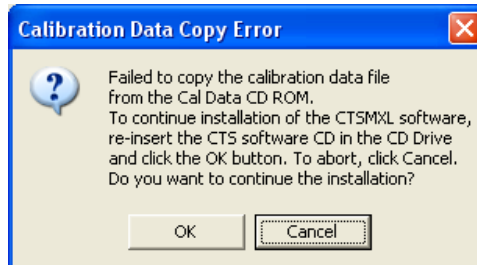

---

**Note:** To operate the AC source through the IEEE-488 interface, it may be necessary to install the IEEE-488 controller card drivers on the same PC. Refer to the setup instructions supplied with the IEEE controller card.

---

### 3.9.1 Calibration Data distributed on USB flash drive or email

If the calibration data you received was provided on USB flash drive or email file instead of CD ROM, you will have to copy the following file from the flash drive or email attachment to your hard drive root directory (Usually C:\) using Windows Explorer:

CTSMXL calibration.dat

### 3.10 AC Source Control Software Installation

If the CTS system you purchased contains a California Instruments AC power source, it will have included additional AC source control software as well.

---

**Note:** The AC source control software is not required to perform harmonics and flicker tests. It is required to perform any of the IEC 1000-4 tests however. This software is supplied with its own user manual and we recommend you familiarize yourself with this user manual also when electing to use the AC source control software.

---

The AC source control software is supplied on CD ROM CIC496. Select the MX Series using the installer program to install the MXGUI program.

To install the AC source control software, proceed as follows:

1. Insert the CIC496 CD-ROM in the PC's CD-ROM drive. If the drive is configured for autoboot, the CI CD-ROM Browser program should pop up on screen. If not, run the SETUP.EXE program.
2. In the left window of the CD browser, locate the AC Source series for the AC source supplied with the CTS system.
3. Click on the Programs Tab on the right and select Windows 32 bit.
4. Click on the Install button at the bottom center to run the setup program.
5. Follow the on-screen prompts of the installation program.
6. The setup program will now run and display a dialog box that shows the default directory for the AC source control software that is MXGUI on the current drive. At this time you can accept the default directory by clicking on the OK button or enter a different directory. If the directory you enter does not already exist, it will be created.
7. At the end of the installation process, a message will be displayed indicating the installation is complete.
8. You can now remove the CD-ROM.

## 4. Program Menus

### 4.1 About this Chapter

This chapter provides an overview of the CTSMXL program menus. You may read this chapter to familiarize yourself with the menus available in the program for harmonics and flicker testing or proceed directly to the relevant chapter for the test you want to run and use this chapter only as a reference.

### 4.2 Main Menus

Many of the CTS system capabilities are accessible through the menus located at the top of the main window. These menus are organized in the following groupings. Click on any menu to view the sub menu items.

MENU	DESCRIPTION
File	Open, close and save test setups and data files. Also allows printing of test reports
Edit	Used to cut and paste graphs to other Windows programs or edit the report header text.
View	Allows test setups or a list of all tests performed with the system to be displayed. A link to the California Instruments' web site is provided on this menu as well.
Options	Several run-time and replay settings can be controlled from this menu.
Test	Starts a new test, allows replay of a previously recorded test, or display harmonics information of the most recent test.
Help	On line help and Program information.

Note: When a test is in progress, the menus are not available until after the test is completed. This prevents the test from being suspended while the user pulls down a menu, which is an unavoidable Windows issues.

### 4.3 File Menu

The File menu offers the following sub-menu choices.

SUB MENU	DESCRIPTION
New Test	Clears all data and brings up the test setup screen to start a new <a href="#">harmonics</a> or <a href="#">flicker test</a> .
Open Data File	Opens a previously recorded data file from disk. The data file can be either created on this computer or created on another computer.
Open Setup File	Opens a setup file. This allows a new test to be run with the exact same setup parameters. The setup file can either be created through "Save Test Setup" menu action or extracted from an existing test data.

SUB MENU	DESCRIPTION
Save Test Setup	Saves only the setup information in effect. The setup file name depends on the setup. For example, a steady state Class D test would have a name of Steady_D.cts_setup.
Save Test Data	Saves all data from the most recent test run. A test must be run first with data saving enabled. When data saving is enabled, a test will produce a binary file H-xxxxxx.cts_data (harmonics) or F-xxxxxx.cts_data (Flicker) where xxxxxx is the test number. Save test data menu action actually make a copy of that binary file to the specified file name and location.  The file name used will be the same as used for the previous save operation unless this is the first save after a test run. In that case, the user will be prompted for a file name.
Save Test Data As	Saves a copy of the most recent test run binary data to a new file name. The user will be prompted for a name to use.
Report	Generate data needed for a test report and if MS Word is installed on the PC used, allows producing/viewing/printing a test report in MS Word.
Report Preview	Previewing a test report in MS Word. MS Word must be installed on the PC used.
Print Report	Printing a test report in MS Word. MS Word must be installed on the PC used.
Exit	Terminates and exits the CTSMXL program

#### 4.4 Edit Menu

The Edit menu offers the following sub-menu choices.

SUB MENU	DESCRIPTION
Copy Top Graph	Copies a bitmap image of the top graph displayed to the Windows Clipboard. From there, it can be pasted into other Windows programs.
Copy Bottom Graph	Copies a bitmap image of the bottom graph displayed to the Windows Clipboard. From there, it can be pasted into other Windows programs.
Edit Header	The Header is printed at the top of each report page. This sub menu brings up a dialog box that allows the header to be edited. For testing on behalf of a third party, this feature allows the test lab name to be printed on each report page.

### 4.5 View Menu

The View menu offers the following sub-menu choices.

SUB MENU	DESCRIPTION
Test Setup	Brings up a overview of all selected test setting for the current test. This is a display window only and no fields can be changed in this mode. To change setup option, close the active test window and select Perform a new Test from the Test menu.
Test List	Brings up a display grid showing all tests ran to date on the test system PC. For each test, a time stamp, test type and pass fail result is shown. Any test for which data was recorded can be played back by selecting it and clicking on the replay button at the bottom of the screen.
Calibration Info	Displays a summary window of the Card serial number, PACS serial number, frequency calibration and last calibration date.

### 4.6 Options Menu

The Options menu offers the following sub-menu choices.

SUB MENU	DESCRIPTION
Get a new reference for each test	For Harmonics tests with a limit set that is a function of the power level or current of the EUT, a new reference can be established for each test run. Alternatively, the last used reference can be preserved for subsequent test. This menu entry toggle between these two available modes.
Generate ASCII Files at the end of test	When selected, this option causes tab delimited ASCII files to be generated at the end of the test from the binary data files recorded during the test run. ASCII files take up more space but can be opened using other application programs. All the ASCII files will be in the sub directory "ASCII_files". Please note that even if this item is not selected, conversion from a binary test file to ASCII files can also be accomplished using the ASCII converter program (Convert data to ASCII) supplied as part of the CTSMXL program suite.
Show Banner at the end of test	When selected, this option causes a large banner (Green when PASS, Red when FAIL) to appear on the screen of the PC. This banner can be seen from across the room to notify a lab operator that the test run has been completed.
Recall Type	Valid for data replay only. This option offers four choices for playback of data. Data is stored in acquisition windows or buffers. For Harmonics, acquisition windows are either 10, 12 or 16 cycles. For Flicker, acquisition windows are 1 second. Available recall choices are:
	Every Window: Every acquisition window is shown
	Every failed/distorted Window Only acquisition windows with current failure or distorted source are shown.
	Every Failed Source Window Only acquisition windows with high AC source distortion are shown.
	Every Failed Current Only acquisition windows with current failure are

SUB MENU	DESCRIPTION
	Window shown.
Recall Size	Amount of acquisition buffers or windows to be loaded from disk to memory during playback. The more windows are loaded, the further the user can back up in the data stream during playback. Thus, when selecting 100 buffers, the replay can be stopped and reversed up to 100 buffers. The recall size ranges from 0 to 1000 buffers.
Replay Delay	Selects the time to wait between display data buffers during replay mode. On a fast PC, it may be useful to increase this time or the replay will run by too fast to see anything meaningful. Available delay times between buffers are 0.0 seconds for the fastest speed to 5.0 seconds for the slowest speed.
Display Rate	This setting determines how many buffers are skipped for display purposes. While all data buffers are read from disk, only the selected buffer interval set here is displayed in the graphs. Available rates range from Every Acquisition to All the way to the End. The last setting means the data is read from disk all at once and only the last buffer is displayed at the end of replay. The user can then back up (recall) using the VCR style keys in the lower left corner of the screen.

#### 4.7 Test Menu

The Test menu offers the following sub-menu choices.

SUB MENU	DESCRIPTION
Perform a new test	Clears the existing test data from memory and brings up the test setup screen for both <u>Harmonics</u> and <u>Flicker</u> test.
Replay an existing test	Brings up the list of tests that can be replayed.
Select a test setup from Test List	Allows test setup information from any test in the test list to be copied to a new test setup.
Edit/View Fixed references	Allows editing of power level or current for test limits that are a function of EUT power and or EUT current. See Get new reference entry under <u>Options menu</u> .
Current Harmonics	Displays a table with current harmonics data of the most recent test.
Voltage Harmonics	Displays a table with voltage harmonics data of the most recent test.
Parameters Data	Displays a table with parameters of the most recent test.



## 5. Harmonics Testing

---

### 5.1 About This Chapter

This chapter covers testing a device for compliance with the EN 61000-3-2 Harmonics standard. A review of the possible EUT classes is provided to assist the user in determining the appropriate device class to use. Once the device class has been established, the appropriate test module is used to perform the tests.

### 5.2 Test Standard Selection

Before running any Harmonics test, you must decide if you want to test to the old harmonics standard (EN 61000-3-2:1998, includes Amendments 1 and 2) or the new one. (EN 61000-3-2:2000, Amendment 14). Both may be used up to January 2004 after which time only the new standard should be used. The standard selection is made in the lower right hand corner of the setup screen. Once selected, some options may be grayed out. For example, the new test standard only considers transitory harmonics so the quasi-stationary selection is disabled. Note that the acquisition window over which the evaluation of current harmonics is made differs under both standards. Per the EN 61000-4-7 referenced in Amendment 14, which replaces the Annex B of the 1998 standard, the evaluation window for Amendment 14 is 10 cycles at 50 Hz or 12 cycles at 60 Hz. The 1998 standard is based on an evaluation window of 16 cycles for 50 Hz. (same 16 cycles is used when the frequency is set to 60 Hz). Selecting the desired test standard automatically configures the CTS for the correct acquisition window.

### 5.3 Device Classes

The EN 61000-3-2 categorizes products in one of four product classes. Using the correct class is important as the harmonic current limits for each class are different. Choosing the wrong class can mean rejecting a product that otherwise would have passed (False Negative) or passing a product that normally would have failed (False Positive). Either outcome is undesirable.

The following device classes are defined:

<b>Class A</b>	All motor driven equipment, most “domestic” appliances and virtually all 3 phase equipment (<16 A rms per phase).
<b>Class B</b>	All portable electric tools.
<b>Class C</b>	All lighting products, including dimmers, with an active input power above 25 Watts.
<b>Class D</b>	Products having a power range from 75 to 600 Watts AND a current waveform that has a special wave shape. For testing to EN 61000-3-2:2000, Amendment 14, the special waveshape does not apply and only TV's PC's and PC Monitors with power levels between 75 and 600 W are considered class D. All other products are class A.

**5.3.1 Class D Special Current Waveshape**

If you elected to test to the EN 61000-3-2:1998 standard, a unit is considered to be class D equipment if it meets the power consumption limits listed above and its current waveform matches at least 95 % of a specified wave shape template. This template is aimed at 'capturing' high crest factor loads that are known to generate high harmonic currents. The wave shape template consists of three time domain sections, one for each 1/3 period of the signal during a positive or negative half-cycle of the input voltage. The center section is normalized to, and centered around the peak current value. The other two sections have a 0.35 times peak amplitude limit. The actual template is shown in Figure 5-1.

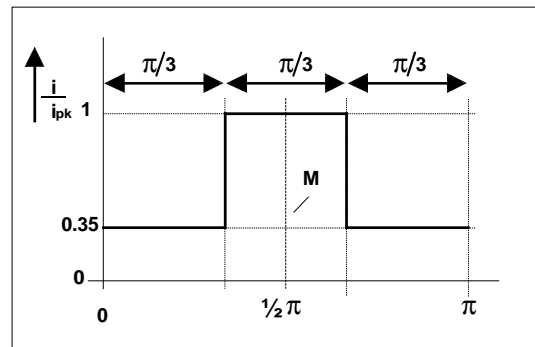

Figure 5-1: Class D Current Wave Shape Template

The exact IEC 61000-3-2:1998 standard text is as follows:

*“..equipment shall be deemed to be Class D if, under the test conditions given in Annex C, the input current waveshape of each half period - referred to its peak value  $i_{pk}$  - is within the envelope shown in the following figure for at least 95 % of the duration of each half period; this implies that waveforms having small peaks outside the envelope are considered to fall within the envelope. The center line M, coincides with the peak value of the input current.”*

A device that does not meet these class D requirements defaults to a class A device and should be tested against the class A limits.

The flowchart shown in Figure 5-1 can be used to determine the class of the device to be tested.

When selecting IEC 61000-3-2:1998 mode with a Class D device, the CTS Software will display the current waveshape and the special waveform template. The percentage that fails within the template is displayed as well. If the waveform is not class D, the user will be given an indication. The test can still be run however. In Class A testing, the special waveform check is also performed to prevent a “False Positive”.

If the CTS software indicates that the current waveform does not meet the Class D requirements, the user should switch to Class A instead.

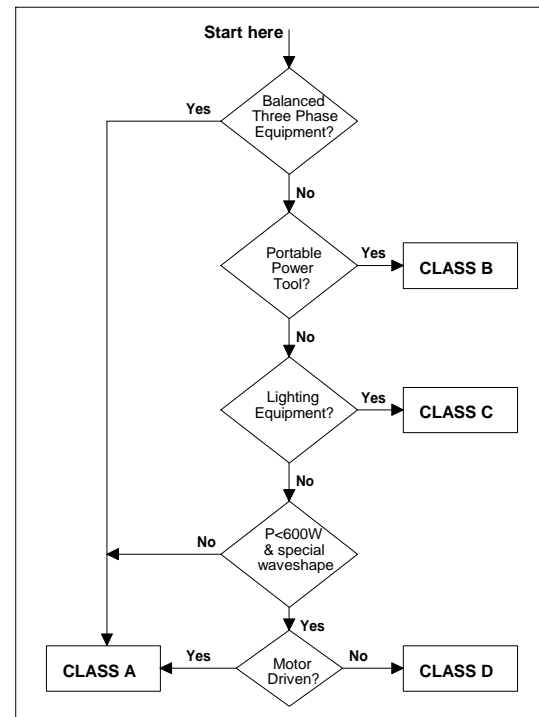

Figure 5-1: EUT Class Determination Flowchart

### 5.3.2 Dynamic Class C and D Limits

Harmonic current limits for Class D are a function of the EUT power level. This poses an interesting problem, especially if the device has a fluctuating power draw pattern. This means the test limits change with the power consumption of the EUT. While there is some discussion in the IEC community regarding the practicality of using such dynamic test limits, the CTS software is fast enough to dynamically recalculate the test limits applied to the current harmonics for each acquisition window of 16 signal periods. As such, the CTS system fully implements the IEC standard with respect to class D.

The same issue applies to the third harmonic limit for Class C products, which is a function of the fundamental current and power factor ( $\lambda$ ). The CTS software determines the fundamental current and power factor of the load for each acquisition window and dynamically determines the correct 3<sup>rd</sup> harmonic current limit for Class C devices.

If you select to test to Amendment 14, you will have to enter the manufacturer rated power for Class D (TV's, PC's and PC Monitors) or the fundamental current and power factor for Class C (lighting products) instead. The rated values will be used to calculate the Class C and D limits as long as the actual measured values do not differ from the rated values by more than 10 % during the test.

## 5.4 Stationary or Transitory Harmonics Test

The EN 61000-3-2:1998 standard distinguishes between two types of tests, stationary for equipment that exhibits constant power consumption and transitory for equipment that exhibits fluctuating power consumption patterns. While the harmonic current limits applied to each type of EUT are identical, equipment that produces transitory harmonics is allowed to exceed the limit levels by 50 % as long as such excessive levels last less than 10 % of the total time during any 2.5 minute period. This is equivalent to 15 seconds of the total period (2.5 minutes = 150 seconds, 10 % of 150 seconds = 15 seconds).

The user should determine the nature of the EUT based on his knowledge of the product. As a rule, the transitory harmonics standard is easier to pass as there is some margin (up to 50 %) compared to the stationary harmonics test. In case of doubt, it is always possible to run a stationary harmonics test on the EUT first. If the stationary test passes, you are done; a unit that passes the stationary harmonics test will always pass the transitory harmonics test. The reverse is not true however. If a unit fails the stationary harmonics test, it may still pass the transitory harmonics test as long as the current harmonics do not exceed 1.5 times the class limits and do so less than 15 seconds in any 2.5 minute period.

It should be noted that the user must ensure that the total test time applied is sufficient to cover a complete operating cycle of the EUT. Many devices are stationary in nature but notable exceptions exist. For example, a laser printer that periodically draws higher currents to heat the fuser may exhibit fluctuating harmonics and may require a test time that is sufficiently long to cover such an event. The same applies to microwave cookers and washing machines.

---

**Note:** The user is responsible for selecting the correct test method for the EUT. The CTS system does not attempt to determine if the EUT exhibits stationary or transitory harmonic currents. If in doubt, select the stationary test method as it is the most stringent of the two.

---

If you selected the EN 61000-3-2:2000 standard, evaluation of current harmonics is always done using the transitory method so no user selection is provided. See section 2.3.3 for details on selecting the correct test time.

### 5.5 Running a Harmonics Test

Starting the CTSMXL main program brings up the test setup screen. This CTSMXL main program window automatically sizes to a SVGA display resolution of 800 x 600 pixels. Larger screen resolutions are supported but the controls on the main window will not size to any resolution above 800 x 600.

---

**Note:** For correct harmonics and flicker measurement operation, make sure that the PACS-3-75 and PC are operated from the same supply outlet.

---

A harmonics test is always started by setting the desired type and EUT class. Other settings involve the desired nominal voltage and frequency and test window size. The figure below shows the typical settings for a class A test.

Please note the six fields at the bottom of the set up screen are grouped as Default user input. The values you entered in these fields are not necessarily for the particular test you are about to perform. When you click OK, you will be presented with a measurement screen where you can enter similar information that is specific for the test. The Default User Input here is intended to facilitate the situations where a group of tests are to be performed where the information in Default User Input are applicable to all the tests in the group.

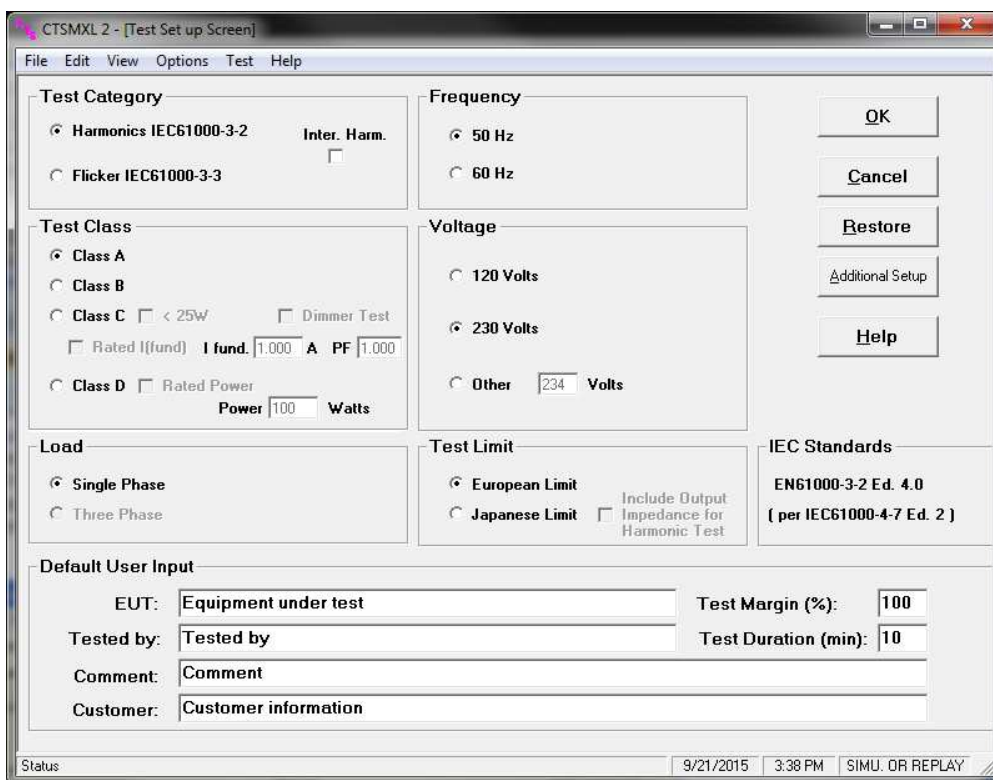

Figure 5-3: Typical Class A test setup

---

**Note:** If both the CTSMXL program and the MXGUI are configured to use the same Com port or IEEE-488 bus controller to control the AC source, it is important that both programs not be active at the same time. Having both programs open at the same time could cause an interface conflict.

---

The following checklist shows all available setup options for a Harmonics test.

Field	Description / Purpose
Test Type	Select between Steady State Harmonics or Transitory Harmonics. EUT's that have a constant load pattern can be tested using the steady state mode. If you select Amendment 14, you can also enable or disable inter harmonics evaluation. With the pending new revision of EN 61000-4-7, current interharmonics have to be evaluation in addition to the harmonics.
Frequency	Choose 50 Hz or 60 Hz. This choice will be used to program the AC source output frequency. If no AC source is available or the AC source control option has not been selected, the measured frequency is checked against the user setting and an error message is generated if a discrepancy is detected. For IEC compliance testing, 50 Hz should be selected.
Test Class	Select the appropriate test class for the equipment under test. See paragraph 2.4.1 for test class selection.
Voltage	Select the correct line voltage. Default choices are 115 and 230 V RMS Line to neutral. A user-defined value may be entered by selecting the "Other" option. This setting is used to program the AC power source output voltage. If no AC source is available or the AC source control setting in the advanced setup screen has not been selected, the operator is responsible for ensuring the correct line voltage is applied to the EUT.
Load	Selects single or three phase mode. On single-phase CTS systems, the three phase selection is not available. For three-phase CTS systems, a wye connection to the PACS-3 must be used.
Test Limit	The CTSMXL retains a database of harmonic current test limits. This setting selects the limit set to use. Available options are European and Japanese. For normal IEC testing, the European option should be selected.
Cycles per window	The present standard requires the use of a 10 period acquisition window at 50 Hz and 12 periods at 60 Hz for a 200 msec at either line frequency.
EUT	This field may be used to enter information about the equipment under test. This field is used to hold a default value.
Tested by	This field may be used to enter operator information. This field is used to hold a default value.
Comment	Comment field for general use. This field is used to hold a default value.
Customer	If the test is performed on behalf of a third party, information about the entity for which the test is performed may be entered here. This field is used to hold a default value.
Test Margin	Determines at what scale factor the harmonic test limits will be applied. For most situations, this value should be set to 100 %. If testing is done for pre-compliance, setting a lower margin will provide an extra margin of safety against system tolerances of different test systems. This field is used to hold a default value.
Test Duration	Enter the total test time. For Steady State Harmonics, the default test time is 1.0 minute. For Transitory Harmonics, the default test time is 2.5 minutes. For flicker tests, the default time is 10 minutes. Maximum test time is 1440 minutes or 24 hours. This field is used to hold a default value.

Table 5-1: IEC Harmonics Setup Parameters

### 5.6 Additional Setup Parameters for Harmonics

If this is first time using the CTSMXL system, it may be necessary to check the Additional Setup settings. These settings can be displayed by clicking on the "Additional Setup" button on the right hand side of the main setup window.

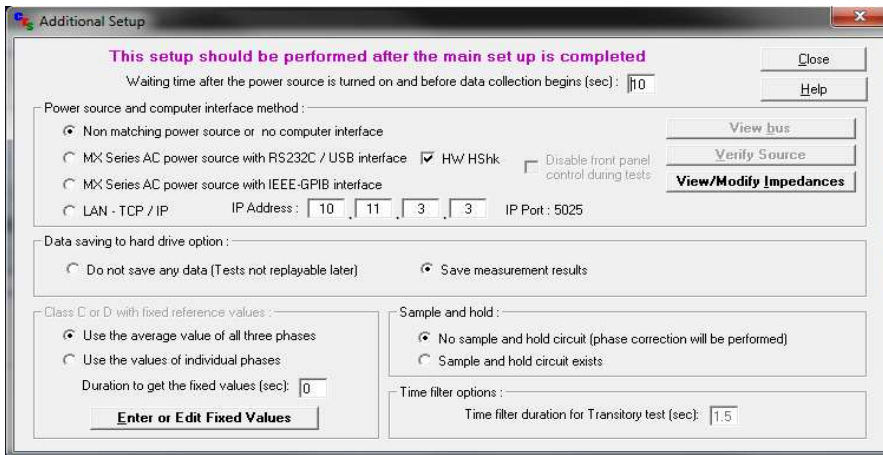

Figure 5-4: Additional Settings for Harmonics Test

The following settings are available from this dialog window:

Setting	Description
Pre test time	This is the time during which to apply power to the EUT before starting the harmonics measurements. This capability may be used to skip any startup behavior of the EUT that may affect the outcome of the test. High EUT inrush currents that exceed the AC Source's maximum peak current capability can result in high voltage distortion. This would invalidate the test. The Pre-test time setting can be used to hold off measurements until after the EUT has reached a steady state condition.
Source Control	The CTS system is normally supplied with a suitable AC power source to provide stable AC power to the EUT. The Source Control section of the additional setup dialog is used to configure the CTS system for the AC Source used. Only support for the MX Series power sources is provided in the CTSMXL Software. If the AC source used is not supported by the program, manual mode should be selected and the source should be set up by the end user. Available options are:
	Use the AC source from its front panel only This option may be needed if the AC Line is used or the AC source used does not offer remote control capabilities. This way of operating puts more responsibility on the operator to ensure the correct power is applied during the test.
	RS232C control Used with AC Sources that have RS232C control capability. The Verify Source must be used to make sure the AC Source can be found. The AC source must be connected using the serial cable provided and must be powered up. The View Bus button may be used to bring up the command trace for trouble shooting purposes if the presence of source cannot be verified. When using remote control, the user can select to have the front panel locked or not by setting the Disable checkbox.

Setting	Description		
	<table border="1"> <tr> <td data-bbox="464 331 691 629">IEEE-488 control</td> <td data-bbox="691 331 1316 629">                     This selection requires the presence of a National Instruments IEEE-488 controller card or compatible card in the PC. This interface is not supplied as part of the CTS system but may be added as an option. The Verify Source must be used to make sure the AC Source can be found. The AC source must be powered up. The View Bus button may be used to bring up the command trace for trouble shooting purposes if the presence of source cannot be verified. When using remote control, the user can select to have the front panel locked or not by setting the Disable checkbox.                 </td> </tr> </table>	IEEE-488 control	This selection requires the presence of a National Instruments IEEE-488 controller card or compatible card in the PC. This interface is not supplied as part of the CTS system but may be added as an option. The Verify Source must be used to make sure the AC Source can be found. The AC source must be powered up. The View Bus button may be used to bring up the command trace for trouble shooting purposes if the presence of source cannot be verified. When using remote control, the user can select to have the front panel locked or not by setting the Disable checkbox.
IEEE-488 control	This selection requires the presence of a National Instruments IEEE-488 controller card or compatible card in the PC. This interface is not supplied as part of the CTS system but may be added as an option. The Verify Source must be used to make sure the AC Source can be found. The AC source must be powered up. The View Bus button may be used to bring up the command trace for trouble shooting purposes if the presence of source cannot be verified. When using remote control, the user can select to have the front panel locked or not by setting the Disable checkbox.		
Test Data	Test data for each test can be saved to disk for later replay or report generation. If this option is not selected, the test cannot be replayed later or printed. For most situations, it is recommended to save the test data. For debugging sessions, it may be acceptable to turn off this option to preserve disk space.		
Class C and D Test Limits	Test limits for class C and D are not fixed but rather depend on the EUT power level and or power factor. The CTSMXL uses the generally accepted dynamic test limit calculation method to determine the correct limits for each acquisition window. Using the settings in this frame however, the operator may override this implementation and set a fixed limit for Class D and C. The time for which to acquire power and or power factor data from the EUT can be set in the Duration field in seconds. For three-phase mode, the power can be averaged over all three phases.		
Sample and Hold	This option does not apply to the CTS system.		
Time filter duration for transitory harmonics filtering.	This value should be set for 1.5 seconds to comply with the EN 61000-3-2 standard. Future standard changes may require this value to be changed.		

Table 5-2: IEC Harmonics Advanced Setup Parameters



### 5.7 Main Harmonics Test Window Operation

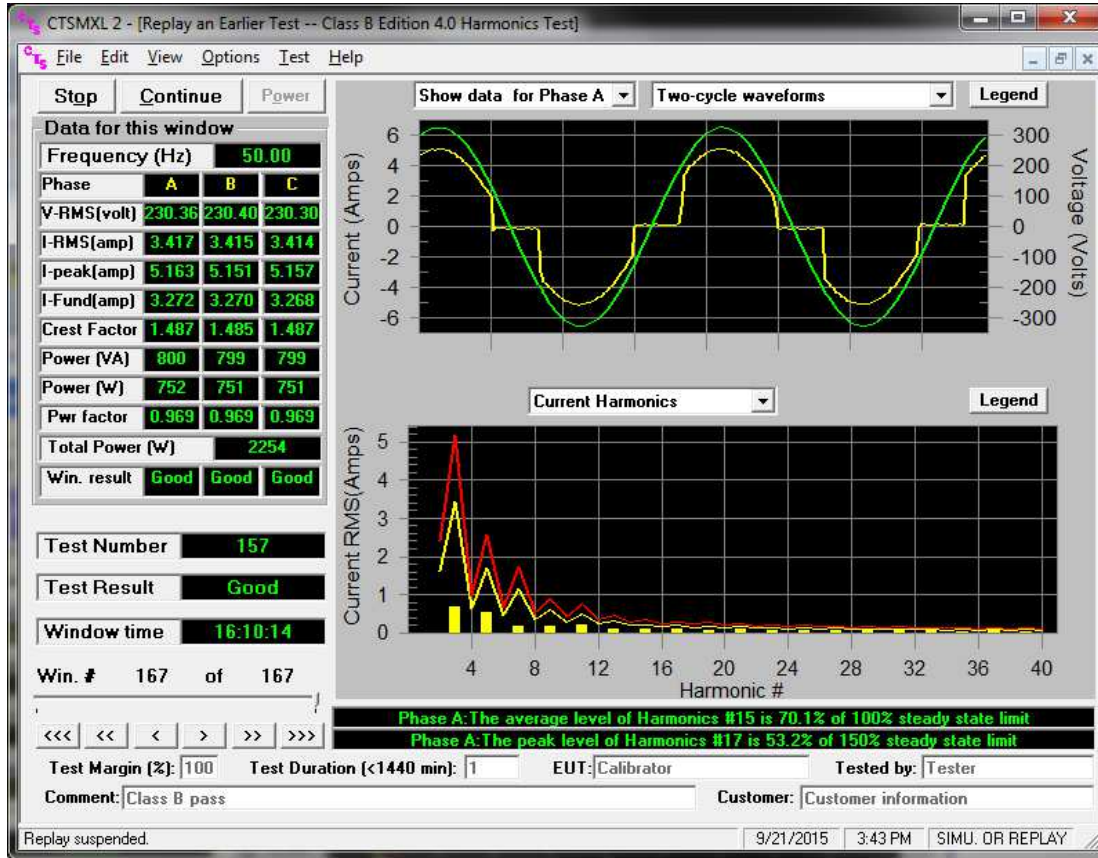

Figure 5-5: Harmonics Test Window

Upon closing the Main setup window, the harmonics test window will appear. Tests are executed from this window and test results are displayed in real-time. This main harmonics test window has a limited number of controls, the function of which are explained in the table below.

Field / Control	Location	Description
Start button	Upper left corner	Starts harmonics test using presently selected parameters. Once a test is running, parameters cannot be changed. Starting a test also causes data to be written to the test data file if data recorded is enabled. Each time a test is run, a new sequential 'Test Number' is assigned. Results for each test are automatically logged. Data for each test is only recorded if this option is selected in the Additional Setup screen. Once a test is running, the Start button changes to a Stop button. Also, any menus will be disabled while a test is in progress as pulling down a menu under Windows will cause the application to halt which would result in data loss.

Field / Control	Location	Description
Stop button	Upper left corner	Stop the acquisition process. The Stop button can be used to abort a test prematurely. The data files will be closed and will only contain data up to the point at which the test was aborted. Test log will indicate if the test completed normally or was aborted by the user.
Report button	Upper left corner	The Print Summary button generates a test report in an MS Word doc file. This report contains both the voltage and current waveform and the harmonics display graph. It also includes the current and voltage harmonics in absolute values and as a percentage of the applied IEC limits.
Power Buttons	Upper left corner	These button controls may be used to turn the AC power source output on or off. The configuration can be set to use automatic power on/off, automatic on / manual off or manual on and off control of the AC source. If no AC source control option is selected, the operator has to use the front panel of the AC source instead and this button will not be available. In manual mode, the operator must click on the Power On button to turn on power to the EUT.
<b>WINDOW</b>	<b>DATA</b>	The data in the Window Data frame on the left side of the main harmonics screen applies to successive acquisition buffers. Acquisition buffers are 320 ms for 50 Hz EUT's and 266.67 ms for 60 Hz EUT's if the 16 Cycle window size is selected. If the 10/12 cycle window size is selected, the buffer size is 200 msec.
Frequency - Hz	Left panel	Displays the AC signal frequency in Hz. If the frequency is not 50 or 60 HZ, "F???" will appear in the field of VTHD and Source Qual. The test will continue however but the results may not be valid.
Voltage - RMS	Left panel	Displays the Root Mean Square voltage of the AC source output for each acquisition buffer.
I - RMS	Left panel	Displays the Root Mean Square current to the EUT for each acquisition window.
I peak	Left panel	Displays the peak current value of the EUT current. If the EUT produces no harmonic currents, the peak current is $\sqrt{2}$ times the RMS current.
I Fund	Left panel	Displays the value of the fundamental current of the EUT for each acquisition window. The fundamental current is the current at 50 Hz or 60 Hz only, without any contributions from higher order harmonic currents. If the EUT produces no harmonic currents, the fundamental current will be the same as the rms current.
Crest Factor	Left panel	Displays the crest factor of the EUT current. Crest factor is the ratio between the peak current and the RMS current.
VA Power	Left panel	Displays the apparent power consumption of the EUT for each acquisition window.
Power - Watts	Left panel	Displays the real power consumption of the EUT for each acquisition window.
Power Factor	Left panel	Displays the ratio between real power and VA power of the EUT for each acquisition window.
Window Result	Left panel	Indicates if the present acquisition buffer current harmonics exceed the selected EUT current limits. If one or more acquisition buffers report a failure, the overall test result will fail. This field will typically toggle between good and fail during the test run.
VTHD	Left panel	Provides information on the AC voltage distortion. If the source voltage is affected by the EUT harmonics currents, distortion compensation will be used and indicated in this field.

Field / Control	Location	Description
Test Number	Bottom Left	Each test run is assigned a sequential test number. The number for the current test is displayed in this field. This allows individual test results to be tracked.
Test Result	Bottom Left	This field provides a visual indication of the test result. A Green field with Pass indicates the EUT current harmonics are below the limit, a Red field with Fail indicates the EUT current harmonics are above the limit. Note that the condition of this field is affected by the user selected test margin. To use the actual IEC test limits, the test margin should be set to 100 %. This field depends on the "Window results" of all the windows up to this test time and if any "Window result" is failed during a test, Test result will be "Fail". In other words, this field is "Fail" latching.
Source Qualification	Bottom Left	This field displays overall AC Source voltage distortion status for the test so far. At the end of the test, this field indicates if the AC Source failed the voltage distortion test at any time during the test. The VTHD indication is given to notify the user of a possible problem with the AC source voltage distortion, which may invalidate the test results. The test will not be aborted however if the voltage distortion is too high.
Start Time	Bottom Left	This field always shows the start time of the test in progress. The test duration is shown in the bottom panel. See also the "% of test completed" indication and the progress bar below the Start Time field.
% of test completed	Left panel	During test execution, this field displays the percentage of the test that has been completed. Once this number reaches 100 %, the test will terminate normally. If the user clicks on the Stop button instead, it will display the point at which the test was aborted.
Test Margin	Bottom	The test margin can be set by the user if a pre-compliance test is needed and the user wants to set more stringent limits. The test margin number defaults to 100 % to use the exact IEC limits. A lower percentage will mean the EUT has to pass lower test limits (more stringent). The value of this field ranges from 50 % to 150 %. Note that the limit lines in the Graph always display the 100 % IEC limits. The test margin is only used for Pass or Fail determination.
Test Duration	Bottom	The test duration is the total test time selected by the user. This value can be set from 0 to 1440 minutes (24 hours). This value should be set before starting the test as it cannot be changed while a test is in progress. If the duration is 0 minutes, then only one window will be acquired.
EUT	Bottom	This field can be used to enter information about the unit under test. The EUT field contents will be included in the test data file and in any reports that are printed.
Comments	Bottom	This field can be used to enter any information about the test. The Comments field contents will be included in the test data file and in any reports that are printed.
Tested by	Bottom	This field can be used to enter information about the operator. The "Tested by" field contents will be included in the test data file and in any reports that are printed.
Customer		This field can be used to enter information on a customer if you are running tests for a third party. The "Customer" field contents will be included in the test data file and in any reports that are printed.
Voltage and Current Graph	Top right panel	This graph displays the AC voltage and current waveforms. At all times, two periods of the AC signal are displayed. The voltage is shown in yellow, the current in green. For Class D tests, the special wave shape template is displayed in the same graph using red. The percentage of

Field / Control	Location	Description
		the EUT current outside the template is shown directly below the graph.
Harmonics Graph	Bottom right panel	The Harmonics graph panel can be used to display the current harmonics (green) and test limits (red) during the test. It is also possible to toggle this display to show the AC voltage harmonics. The drop down control located at the top of the Harmonics graph panel can be used to select alternate display modes.
Legend buttons	Graph panels	The Legend buttons can be used to display a pop-up window that shows the color-coding used in each graph.

### 5.7.1 Entering User and/or Customer Data

Prior to running a test, you should enter information concerning the EUT, the person or department performing the test and any other information that may be relevant to interpreting or using the test results obtained from the CTS system. Several fields are provided for this purpose along the bottom of the main test window. If the test is performed on behalf of a third party, the customer data field may be used to document the customer name.

The information entered in these fields is added to the test data file and any reports that are printed. The date and time of the test run are automatically added based on the PC's real-time clock.

### 5.7.2 Selecting the Test Period

The test period should be set appropriately for the test mode selected and the EUT at hand. For details on setting the correct harmonics test time, refer to paragraph 2.4.2 for EN 61000-3-2:1998 mode or paragraph 2.3.3 for EN 61000-3-2:2000 mode. For flicker tests, the default is 10 minutes. You can increase the test time up to 24 hours if needed.

### 5.7.3 Setting the Test Margin

The CTS system offers the user the choice of setting a test margin around the IEC limits. This means a user specified factor can be applied to the IEC test limits. The default value used is 100 % which essentially means the actual IEC limits are applied to determine a pass or fail result. This is the mode to use for actual compliance testing.

Setting this margin to a value below 100 % can be useful for pre-compliance testing. Selecting a lower margin means the test is more stringent. If the EUT can pass the more stringent test, it is more than likely to pass when submitted to an independent test lab. Setting the margin above 100 % means you are "loosening" the limits allowing EUT's to pass that would normally fail. This mode is not recommended.

## 5.8 Running the Harmonics Test

Before starting a test, make sure all user fields are set correctly. Changes to these fields are no longer possible once a test is in progress. Also make sure the EUT is connected to the AC output of the PACS-3-75 unit and the correct AC line voltage is programmed on the AC source.

A test run is started by clicking on the Start button. During test execution, the "% of test completed" field on the left of the main window displays the percentage of the test that has been completed. Once this number reaches 100 %, the test will terminate normally. If you click on the Stop button instead, it will display the point at which the test was aborted.

### Over 16 Amps Message

It is possible that a message box pops up as the test is started informing the operator that the EUT RMS current per phase exceeds the IEC61000-3-2 test standard requirement of no more than 16 Arms. In that case, the IEC61000-3-12 test should be used instead. This requires the CTSMXL software. (CI P/N CIC652). This message can be suppressed if desired by changing one of the configuration files located in the CTSMXL application directory. The file is a text file named "ctsmxl.defaults" and can be edited using

Windows Notepad or a similar text editor. Open the file and locate the entry called "over16amps = 1". To disable this message pop-up, change to called "over16amps = 0" and save the file.

During the test execution, the CTSMXL software will continuously evaluate the EUT current harmonics against the appropriate class limits. The Pass or Fail indication is updated in real-time. If the test fails early in a long test period, you may elect to abort the test prematurely rather than waiting till the end.

### 5.8.1 Voltage and Current Waveform Graphs

The top graph continuously displays two signal periods of the AC voltage (yellow) and current (green) waveforms. For Classes A and D tests, it also shows the special current wave shape template in red. Alternate display modes can be selected from the drop down combo at the top of the graph.

### 5.8.2 Voltage and Current Harmonics Graphs

The bottom graph serves a dual purpose. During the test run, it can be used to show either the current or the voltage harmonics. In either mode, the IEC test limits are displayed using a red line for the current harmonic limits and a green line for the voltage harmonic limits.

---

Note: The voltage harmonic limits apply to the AC source qualification and may indicate that the current harmonics are affected due to AC voltage distortion. In this case, distortion compensation is automatically applied, which is shown on the left hand side of the main window.

---

When displaying the current harmonics, the actual harmonic currents from the second through the fortieth for each acquisition window are shown in green. The IEC test limits are shown using a red line. Note that this red line always displays the 100 % IEC test limits during Steady State testing, regardless of the user specified test margin which is used for the Pass or Fail determination. (see "Setting the Test Margin" , found in paragraph 5.7.3).

---

Note: The fundamental current is not shown in the harmonics graphs as there is no test limit for the fundamental.

---

### 5.8.3 Aborting a Test

Tests in progress can be aborted at any time by clicking on the Stop button. Aborted test data files will be marked as incomplete.

## 5.9 Printing Results

The Report button allows you to print both on-screen graphs displays and current and voltage harmonics test result data to an MS Word document. This provides a test report that displays the test setup, the Pass or Fail result and a graph of the voltage and current waveform as well as the worst case values for each of the current harmonics. The Report button is available at the end of a test run or any time a test is aborted with the Stop button.

Information included on the harmonic test report will be a function of the selected test mode and EUT connection stage. The following fields provide this information:

### Heading:

Test category: Selected Stage and EUT type.

### Current Test Result Summary

Test Result Overall Pass or Fail result

### Highest parameters recorded during the test.

V_RMS	EUT Voltage Line to Neutral
I_Peak	Maximum peak current recorded
I_Fund	Maximum fundamental current recorded (I1)
Power	Maximum power level recorded
I_RMS	Maximum RMS current recorded
Crest Factor	
Power Factor	

### Harmonic Currents Table:

Harmonic number (#)	Only harmonics for which limits apply are shown.
Harms (Avg)	Average harmonics value (1.5 sec smoothing filter applied)
100% Limit	Absolute current value of 100 % limit for each harmonic
% of Limit	Percent of 100 % limit for each harmonic
Harms (Max)	Maximum harmonic value recorded during test.
150% Limit	Absolute current value of 150 % limit for each harmonic
% of Limit	Percent of 150 % limit for each harmonic maximum
Status	Individual harmonics pass or fail result (based on 100% and 150% limits)

### Voltage Source Verification Data

The third page of the report contains data on the source voltage. If needed, the CTSMXL software will compensate for voltage distortion that would affect the harmonic current results. This will be indicated.

**Note** that the overall EUT test results is repeated in the header of this page. This pass or fail does not apply to the AC source.

## Report Templates

Test reports are based on report templates. Each test mode (harmonics or flicker) and phase mode (single or three-phase) requires a different report template. The CTSMXML program selects the correct template automatically so this is transparent to the user.

All report templates are distributed with the program and are located in the following directory:

C:\Program Files\California Instruments\Ctsmx\report\_files\templates

If these files are accidentally moved, deleted or damaged, report printing will not function and the template files have to be restored. This may be done by re-installing the program if needed.

## 5.10 Harmonics Test Data Files

The CTSMXML Software can be configured to log test data to a file. The file format used is proprietary but can be converted at the end of the test to an ASCII text file with tab delimited fields for voltage, current, power, peak current and all the current harmonics. This data is recorded in real-time or three to four times a second.

Longer test times will result in larger test data files and reports. If you increase the test time, make sure you have sufficient hard disk space available to accommodate these long test files. The rate at which data is written to disk can be decreased to avoid excessive file sizes. The point at which the program will reduce the rate of data storage can be set in the configuration. Should a test failure occur while the CTSMXML program is in this reduced data rate recording mode, full rate data recording resumes for a specified number of acquisition buffers. This always provides detailed information around the time of the failure. These recording rate settings can be set in the miscellaneous section of the configuration program.

## 5.11 Three Phase Testing

Three phase testing is similar to single phase testing described above except that three line voltages and three line currents are being measured simultaneously and displayed in the CTSMXML software GUI.

The three phase mode screens are virtually identical in function and form to the single-phase screens. The user can view one phase at a time, or all three phases simultaneously.

## 5.12 Replay Mode

The CTSMXML Software can be used to replay previously recorded test data. This replay can be done on the same test system that was used to record the original data or on an altogether different PC.

In order to replay a test, the data acquired during the test needs to be saved to a CTS native data file. If the save data option is not enabled in the additional setup window for Harmonics, there is no way to replay a test later. The Pass or Fail result of any run on the actual test system PC is always logged however. If a different PC is used to play back data, the data files have to be transferred to this PC first. The test data files are stored in the following directory:

C:\Program Files\California Instruments\Ctsmx\Data\_files

### 5.12.1 To play back test on the actual test system PC, proceed as follows:

1. From the Test Menu, select 'Replay an existing test'. This will bring up a table showing all tests ever run on this system.
2. Select the test you want to replay by clicking on its row. If data for this test was stored and is available, the Replay Test button at the bottom will be enabled.
3. Click on the Replay Test button to start the replay process. This will bring up a standard Harmonics or Flicker test screen.
4. To start the replay process, click on the Start button. The data displayed will be taken from the stored data files. The replay mode is indicated in the lower right corner on the status bar.

5. The buffer rate and speed at which data is replayed can be controlled using the various settings in the Options menu. This may be required to adjust to the speed of the PC used.
6. The replay process can be halted at any time by clicking on the Stop button. This will stop the data at the buffer number shown in the lower left corner.
7. Once stopped, the data can be stepped forward or backward at various rates using the VCR style buttons in the lower left corner.
8. A test report can be printed from stored data in this mode. The actual date and time the data was recorded will be shown on the report in addition the report print date and time.

#### 5.12.2 To play back test on a different PC from the test system PC, proceed as follows:

1. If not already done, install a copy of the CTSMXL software on the other PC. When launched, the absence of a data acquisition system will be detected and flagged. This is normal.
2. Transfer the data files to the PC used for replay, using either a network connection or disk.
3. From the File menu, select the Open Data File entry. This brings up the standard file open dialog box.
4. Locate and select the file to be replayed. Harmonics files start with the letter H, flicker files start with the letter F.
5. Click on the Open button to open the test data file. This will bring up the test window.
6. To start the replay process, click on the Start button. The data displayed will be taken from the stored data files. The replay mode is indicated in the title of the CTS software.
7. The buffer rate and speed at which data is replayed can be controlled using the various settings in the Options menu. This may be required to adjust to the speed of the PC used.
8. The replay process can be halted at any time by clicking on the Stop button. This will stop the data at the buffer number shown in the lower left corner.
9. Once stopped, the data can be stepped forward or backward at various rates using the VCR style buttons in the lower left corner.
10. A test report can be printed from stored data in this mode. The actual date and time the data was recorded will be shown on the report in addition the report print date and time.



**5.12.3 Harmonics Replay Options**

Data replay capability is an important diagnostic feature of the CTSMXL system. The end user has a great deal of control over the replay process. These user settings are located in the Options menu. The following options are available to control the replay process:

Menu Item	Description	
Recall Type	This option offers four choices for playback of data. Data is stored in acquisition windows or buffers. For Harmonics, acquisition windows are either 10, 12 or 16 cycles. For Flicker, acquisition windows are 1 second each. Available recall choices are:	
	Every Window:	Every acquisition window is shown
	Every failed/distorted Window	Only acquisition windows with one or more failures are shown.
	Every Failed Source Window	Only acquisition windows with high AC source distortion are shown.
	Every Failed Current Window	Only
Recall Size	Amount of acquisition buffers or windows to be loaded from disk to memory during playback. The more windows are loaded, the further the user can back up in the data stream during playback. Thus, when selecting 100 buffers, the replay can be stopped and reversed up to 100 buffers. The recall size ranges from 0 to 1000 buffers.	
Replay Delay	Selects the time to wait between display data buffers during replay mode. On a fast PC, it may be useful to increase this time or the replay will run by too fast to see anything meaningful. Available delay times between buffers are 0.0 seconds for the fastest speed to 5.0 seconds for the slowest speed. During delay, you can click on the pause button to pause.	
Display Rate	This setting determines how many buffers are skipped for display purposes. While all data buffers are read from disk, only the selected buffer interval set here is displayed in the graphs. Available rates range from Every Acquisition to All the way to the End. The last setting means the data is read from disk all at once and the last buffer is displayed right away. The user can then back up using the VCR style keys in the lower left corner of the screen.	

*Table 5-3: IEC Harmonics Replay Settings*

## 6. Flicker Testing

---

### 6.1 About This Chapter

This chapter covers testing a device for compliance with the EN 61000-3-3 Flicker standard. The relevant IEC Flicker test part is described in detail.

### 6.2 Principle of Operation

The CTS Flicker software acquires, stores, processes and analyzes the EUT data in real-time and provides continuous display updates on all Flicker parameters. Voltage time domain data is collected, the rms voltage value is calculated for each half period of the signal or every 10 mseconds, and the measurement data is written to disk for 100 consecutive acquisition periods or once every second.

This allows the operator to monitor the progress of the flicker test and, should a failure occur before the end of the test run, abort the test if needed. Since flicker test can run for several hours, this will avoid needless waiting for tests to finish on a EUT that already failed the IEC requirements.

In order to run the real-time Flicker test, you need a 1.2 GHz Pentium PC or better. This is caused by the amount of data that needs to be processed to perform flicker evaluation. Slower PC's will not be able to process the data in real-time.

### 6.3 Running a Flicker Test

Running a flicker test is similar to running a harmonics test. Launch CTSMXL and select flicker test in the set up screen. Then select appropriate test parameters and click OK to continue. You will be presented with a test screen similar to that of harmonics.

---

**Note:** The OMNI-3-37MX supports EUT load currents up to 37 Arms in FLICKER mode and 54 Arms in BYPASS mode. Any time the OMNI-3-37MX is connected between the MX and the EUT, the programmable current limit of the MX MUST BE SET TO NO MORE THAN 37 Arms during flicker tests. If not, serious damage to the OMNI-3-37MX could result. This type of damage resulting from use above it's current rating is not covered under the normal product warranty.

---

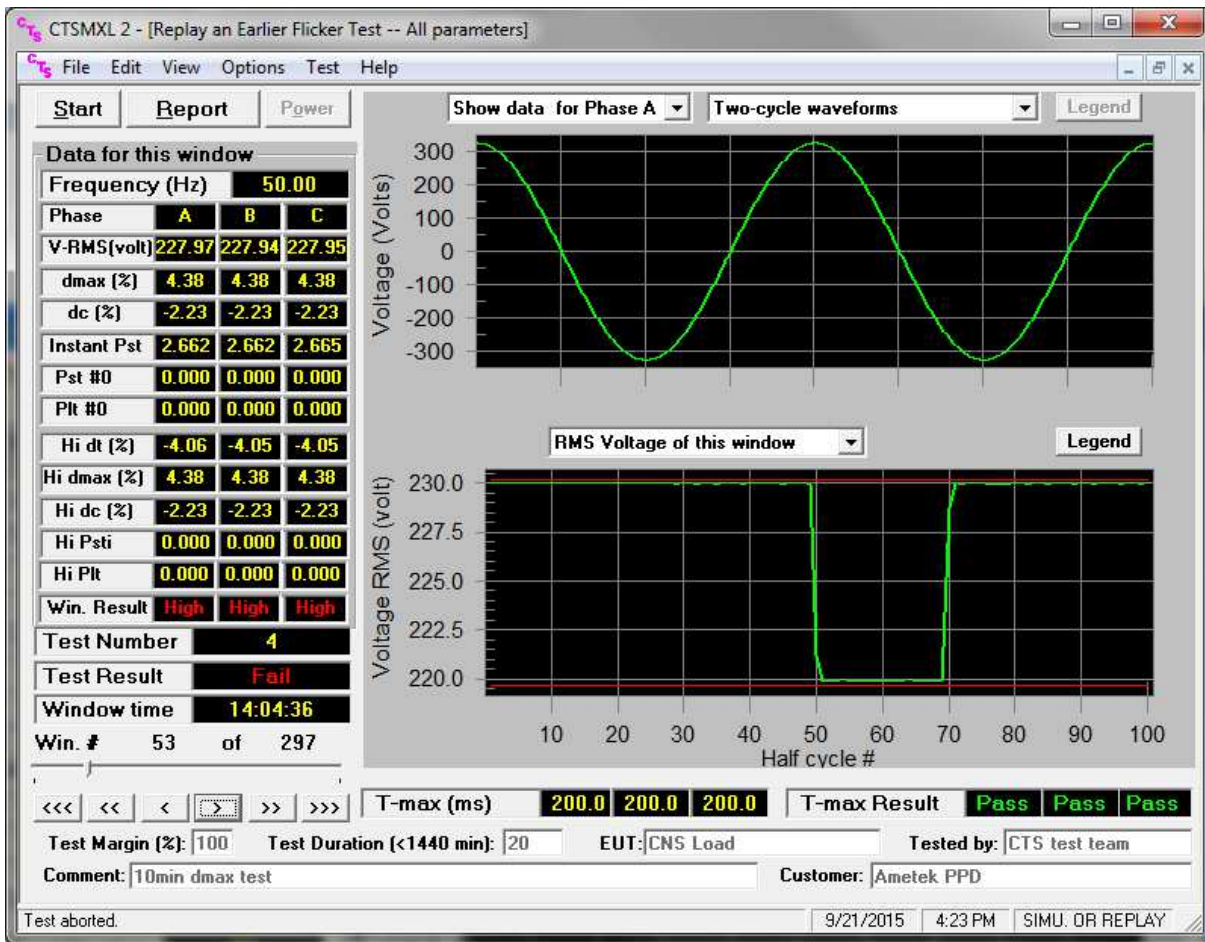

Figure 6-1: Flicker Test Window

The flicker test window has several user accessible fields and controls. The following table briefly describes the purpose of each field and control.

Field / Control	Location	Description
Power button	Upper left corner	Click on Power to toggle the power source output voltage, unless power source is already programmed to 230V. The Flicker module can be configured to turn off the power after every test, in that case therefore, the user will have to click Power On before starting the test.
Start button	Upper left corner	Starts the flicker test using presently selected parameters. Once a test is running, parameter cannot be changed. Starting a test also causes data to be written to the test data file.
Stop button	Upper left corner	Stop the acquisition process. The Stop button can be used to abort a test prematurely. The data files will be closed and will only contain data up to the point at which the test was aborted.
Report Button	Upper left corner	Used to produce a test report in WORD. A WORD must be installed to generate the report.
Power Button	Upper left corner	Can manually toggle the power on/off. A PC to power source communication is needed before it is enabled.
Frequency	Left Panel	Displays signal frequency
V-rms (volt)	Left Panel	Displays Voltage rms value
Test Start Time	Left panel	This field always shows the start time of the test in progress. The test duration is shown in the bottom panel.
Highest $d_c$ %	Left panel	Displays the highest Relative Steady State voltage change ( $d_c$ ) in % found so far during the test. This represents the difference between two adjacent steady-state voltages relative to the nominal voltage. The standard requires that $d_c$ must be less than or equal to 3 % for the EUT to PASS.
Highest $d_{max}$ %	Left panel	Displays the highest Maximum relative voltage change ( $d_{max}$ ) in %. found so far during the test. This represents the difference between the maximum and minimum rms values of the voltage change characteristic relative to the nominal voltage. The standard requires that $d_{max}$ must be less than or equal to 4 % for the EUT to PASS.
Highest $d_t$ %	Left panel	Displays the highest Relative voltage change characteristic ( $d_t$ ). This value represents the change in rms voltage, relative to the nominal voltage, as a function of time and between periods when the voltage is a steady state condition for at least 1 second. The standard requires that $d_t$ must be less than 3 % for the EUT to PASS, although it is permitted to be between 3 and 4 % for less than 200 msec.
Highest Psti	Left panel	Displays the highest Short Term Flicker value found so far during the test. Each Short Term Flicker severity is evaluated over period of 10 minutes. The threshold of irritability is $Pst = 1$ and this value is used as the PASS/FAIL limit.
Highest Plt	Left panel	Displays the highest Long Term Flicker value (Plt) found so far during the test. The Plt period is 120 minutes and is calculated using successive Psti values. The threshold of irritability for long term flicker is 0.65 and this value is used as the PASS/FAIL limit.
Test Status	Center panel	This field provides a visual indication of the test result. A Green field with Pass indicates the EUT passes the Flicker test, a Red field with Fail indicates the EUT causes too much flicker. Note that the condition of this field is affected by the user selected test margin. To use the actual IEC test limits, the test margin should be set to 100 %.
Voltage - rms (Ut)	Center panel	Displays the Root Mean Square voltage of the AC source output for each acquisition window. Acquisition windows are 10 ms for 50 Hz EUT's and 8 ms for 60 Hz EUT's.
$d_{max}$ %	Center panel	Displays the present Maximum relative voltage change ( $d_{max}$ ) in %. This represents the difference between the maximum and minimum rms values of the voltage change characteristic relative to the nominal voltage. The

Field / Control	Location	Description
		standard requires that $d_{max}$ must be less than or equal to 4 % for the EUT to PASS.
$d_c$ in %	Center panel	Displays the present Relative Steady State voltage change ( $d_c$ ) in %. This represents the difference between two adjacent steady-state voltages relative to the nominal voltage. The standard requires that $d_c$ must be less than or equal to 3 % for the EUT to PASS.
Plt # n	Center panel	Displays the present Long Term Flicker value for Pst period number n. The Plt period is 120 minutes and is calculated using successive Psti values. The threshold of irritability for long term flicker is 0.65 and this value is used as the PASS/FAIL limit.
Instant. Pst	Center panel	Displays the instantaneous Short Term Flicker value. At the end of each 10 minute period, this value will be the Pst for the period.
Psti #n	Center panel	Displays the present Short Term Flicker value for period n. The Short Term Flicker severity is evaluated over a period of 10 minutes. The threshold of irritability is $Pst = 1$ and this value is used as the PASS/FAIL limit.
Select Test	Test selection	This combo box allows one of three test modes to be selected: <ul style="list-style-type: none"> <li>• Test all Flicker parameters</li> <li>• Test dc and dt only</li> <li>• Test Pst only</li> </ul>
Test Margin	Test Margin	This field allows the user to set the test margin from 50 % to 150 %. Additional information on setting a test margin is shown later in this chapter.
Graph Display	Graph panel	The graph panel is used to display either $d_c$ and $d_t$ or $U_t$ rms as a function of time. The user can change display modes using the Graph mode drop down box located directly above the graph itself.
Graph mode	Display mode / Print panel	The Flicker module allows the user to toggle between two display modes. One mode shows the dc and dt as a function of time. The other mode shows the $U_t$ rms value as a function of time. Each mode shows a time windows of about 2 seconds and is updated once every 2 seconds.
Test File	Bottom panel	This fields shows the currently selected test data file. It also provides a File button which can be used to change the selected test data file. The test data file is the file to which new data will be written while a test is running. Once a test is started, this button in disabled as the test data file cannot be changed while it is in use by the program. Note that the actual file name may be too long to fit in the space provided on screen. If this is the case, use the File button to display the file dialog box which will allow you to see the entire path and file name.
Test Duration	Bottom panel	The test duration is the total test time selected by the user. This value can be set from 0.5 minutes (30 seconds) to 1440 minutes (24 hours). Note that a Pst and/or All parameter test requires a test time of at least 10 minutes. The default test time is set to 10 minutes.
EUT	Bottom panel	This field can be used to enter information about the unit under test. The EUT field contents will be included in the test data file and in any reports that are printed.
Comments	Bottom panel	This field can be used to enter any information about the test. The Comments field contents will be included in the test data file and in any reports that are printed.
Tested by	Bottom panel	This field can be used to enter information about the operator. The "Tested by" field contents will be included in the test data file and in any reports that are printed.

### 6.3.1 Entering User Data

Prior to running a test, you should enter information concerning the EUT, the person or department performing the test and any other information that may be relevant to interpreting or using the test results obtained from the CTS system. Several fields are provided for this purpose along the bottom of the main test window.

The information entered in these fields is added to the test data file and any reports that are printed. The date and time of the test run is automatically added based on the PC's real-time clock.

### 6.3.2 Selecting the Test Period

The default test time for Flicker tests is 120 minutes which provides 12 short term flicker values of 10 minutes each. The user can set the test time anywhere from 0.5 minutes to 1440 minutes or up to 24 hours if needed. The test period needs to be set long enough to cover the entire operating cycle of the unit under test. If a test time less than 120 minutes is entered, the Plt will be evaluated using 12 Psti values and deeming the non measured 10 minute periods to have a zero Psti.

Equipment that is unlikely to produce long term flicker based on its typical operating cycle need not be tested for Plt. This can significantly reduce the test time. If you are unsure however of the EUT's behavior, you are advised to perform a 2 hour test (120 minutes) to verify compliance with EN 61000-3-3.

### 6.3.3 Test Data Files

The CTSMXL Software can save the flicker test waveform and result during the test if the saving option is enabled. The file will be saved in the data\_files subdirectory. For test #25, the file will be F-000025.cts\_data. This file can be replayed later with the same software.

### 6.3.4 Setting the Test Margin

The CTS system offers the user the choice of setting a test margin around the IEC limits. This means a user specified factor can be applied to the IEC test limits. The default value used is 100 % which essentially means the actual IEC limits are applied to determine a pass or fail result. This is the mode to use for actual compliance testing.

Setting this margin to a value below 100 % can be useful for pre-compliance testing. Selecting a lower margin means the test is more stringent. If the EUT can pass the more stringent test, it is more than likely to pass when submitted to an independent test lab.

Setting the margin above 100 % means you are "loosening" the limits allowing EUT's to pass that would normally fail. This mode is not recommended.

### 6.3.5 Running the Flicker Test

Before starting a test, make sure all user fields are set correctly. Changes to these fields are no longer possible once a test is in progress. Also make sure the EUT is connected to the AC output of the PACS-3-75 unit and the correct AC line voltage is programmed on the AC source.

A test run is started by clicking on the Start button.

During the test execution, the CTSMXL Software will continuously evaluate EUT Flicker against the appropriate IEC limits. The Pass or Fail indication is updated in real-time. If the test fails early in a long test period, you may elect to abort the test prematurely rather than wait till the end.

## 6.4 Printing Test Reports

The CTSMXL Software can produce an MS Word based report. At the end of test, the report button will be enabled. Clicking on the Report button will generate information needed for a report and present an option to generate a report in MS Word.

The amount of information and graphs included on the report will vary by test type and will also be a function of the total test time. If the test time is too short, some data may not be available and will not be included.

The report header contains information regarding the test selection and EUT nominal parameters. The overall EUT pass or fail result is shown below the header on the first page. The first page also contains plots for Pst (1 through 12) and Plt provided the test time is sufficiently long to produce multiple Psti's and a Plt.

The parameter section following the graph(s) lists the measured flicker parameters, their equivalent test limits and a pass or fail evaluation for each.

The parameter section also contains the calculated dmax, dc, Pst and Plt.

### Report Templates

Test reports are based on report templates. Each test mode (harmonics or flicker) and phase mode (single or three-phase) requires a different report template. The CTSMXL program selects the correct template automatically so this is transparent to the user..

All report templates are distributed with the program and are located in the following directory:

C:\Program Files\California Instruments\Ctsmx\report\_files\templates

If these files are accidentally moved, deleted or damaged, report printing will not function and the template files have to be restored. This may be done by re-installing the program if needed.

## 6.5 Flicker Replay Mode

The CTSMXL Software can be used to replay previously recorded test data. This replay can be done on the same test system that was used to record the original data or on an altogether different PC.

In order to replay a test, the data acquired during the test needs to be saved to a CTS native data file. If the save data option is not enabled in the additional setup window for Flicker, there is no way to replay a test later. The Pass or Fail result of any run on the actual test system PC is always logged however. If a different PC is used to play back data, the data files have to be transferred to this PC first. The test data files are stored in the following directory:

C:\Program Files\California Instruments\Ctsmx\Data\_files

### 6.5.1 To play back test on the actual test system PC, proceed as follows:

1. From the Test Menu, select 'Replay an existing test'. This will bring up a table showing all tests ever run on this system.
2. Select the test you want to replay by clicking on its row. If data for this test was stored and is available, the Replay Test button at the bottom will be enabled.
3. Click on the Replay Test button to start the replay process. This will bring up a standard Harmonics or Flicker test screen.
4. To start the replay process, click on the Start button. The data displayed will be taken from the stored data files. The replay mode is indicated in the lower right corner on the status bar.
5. The buffer rate and speed at which data is replayed can be controlled using the various settings in the Options menu. This may be required to adjust to the speed of the PC used.
6. The replay process can be halted at any time by clicking on the Stop button. This will stop the data at the buffer number shown in the lower left corner.
7. Once stopped, the data can be stepped forward or backward at various rates using the VCR style buttons in the lower left corner.

8. A test report can be printed from stored data in this mode. The actual date and time the data was recorded will be shown on the report in addition the report print date and time.

**6.5.2 To play back test on a different PC from the test system PC, proceed as follows:**

1. If not already done, install a copy of the CTSMXL software on the other PC. When launched, the absence of a data acquisition system will be detected and flagged. This is normal.
2. Transfer the data files to the PC used for replay, either using a network connection or disk.
3. From the File menu, select the Open Data File entry, This brings up the standard file open dialog box.
4. Locate and select the file to be replayed. Harmonics files start with the letter H, flicker files start with the letter F.
5. Click on the Open button to open the test data file. This will bring up the standard setup screen showing the settings that were used to acquire this data.
6. Click on OK to proceed to the main test window.
7. To start the replay process, click on the Start button. The data displayed will be taken from the stored data files.
8. The buffer rate and speed at which data is replayed can be controlled using the various settings in the Options menu. This may be required to adjust to the speed of the PC used.
9. The replay process can be halted at any time by clicking on the Stop button. This will stop the data at the buffer number shown in the lower left corner.
10. Once stopped, the data can be stepped forward or backward at various rates using the VCR style buttons in the lower left corner.
11. A test report can be printed from stored data in this mode. The actual date and time the data was recorded will be shown on the report in addition the report print date and time.



**6.5.3 Flicker Replay Options**

Data replay capability is an important diagnostic feature of the CTSMXL system. The end user has a great deal of control over the replay process. These user settings are located in the Options menu. The following options are available to control the replay process:

Menu Item	Description	
Recall Type	This option offers four choices for playback of data. Data is stored in acquisition windows or buffers. For Harmonics, acquisition windows are either 10, 12 or 16 cycles. For Flicker, acquisition windows are 1 second. Available recall choices are:	
	Every Window:	Every acquisition window is shown
	Every failed/distorted Window	Only acquisition windows with one or more failures are shown.
	Every Failed Source Window	Only acquisition windows with high AC source distortion are shown.
	Every Failed Current Window	Only
Recall Size	Amount of acquisition buffers or windows to be loaded from disk to memory during playback. The more windows are loaded, the further the user can back up in the data stream during playback. Thus, when selecting 100 buffers, the replay can be stopped and reversed up to 100 buffers. The recall size ranges from 0 to 1000 buffers.	
Replay Delay	Selects the time to wait between display data buffers during replay mode. On a fast PC, it may be useful to increase this time or the replay will run by too fast to see anything meaningful. Available delay times between buffers are 0.0 seconds for the fastest speed to 5.0 seconds for the slowest speed.	
Display Rate	This setting determines how many buffers are skipped for display purposes. While all data buffers are read from disk, only the selected buffer interval set here is displayed in the graphs. Available rates range from Every Acquisition to All the way to the End. The last setting means the data is read from disk all at once and the last buffer is displayed right away. The user can then back up using the VCR style keys in the lower left corner of the screen.	

Table 6-1: IEC Flicker Replay Settings

## 7. EN 61000-4-11p Voltage Dips and Variations (Pre-compliance)

### 7.1 About This Chapter

This chapter covers testing a device for compliance with the EN 61000-4-11 This covers testing a device for pre-compliance with the EN 61000-4-11 Voltage Dips and Variations test standard. This test is supported through the -411 firmware option on the MX and the MXGUI AC source control program.

### 7.2 Standard Revisions and EUT Classes

The MX Series –411 option supports both the first (1994-06) and the second edition (2004-03) of the IEC 61000-4-11 test standard as of firmware revision 0.31. Older firmware revisions only support the first edition. Contact [ci.ppd@ametek.com](mailto:ci.ppd@ametek.com) for upgrade information. If Edition 2 is supported, the standard revision can be selected.

Generic tests files are distributed with the CIGui32 program for both editions of the test standard. Files applicable to Edition 2.0 have ED20 in their file name. Do not mix these files, as the data setup will not be correct if you do. To load a test file, select the Mode (Dips or Vars) and test standard revision first, then use the File, Open menu to load the test parameters. Test parameters can be a function of the EUT class. The different files provided with the program cover the various EUT classes. The relevant EUT class 1, 2, 3 or X is listed in the file names.

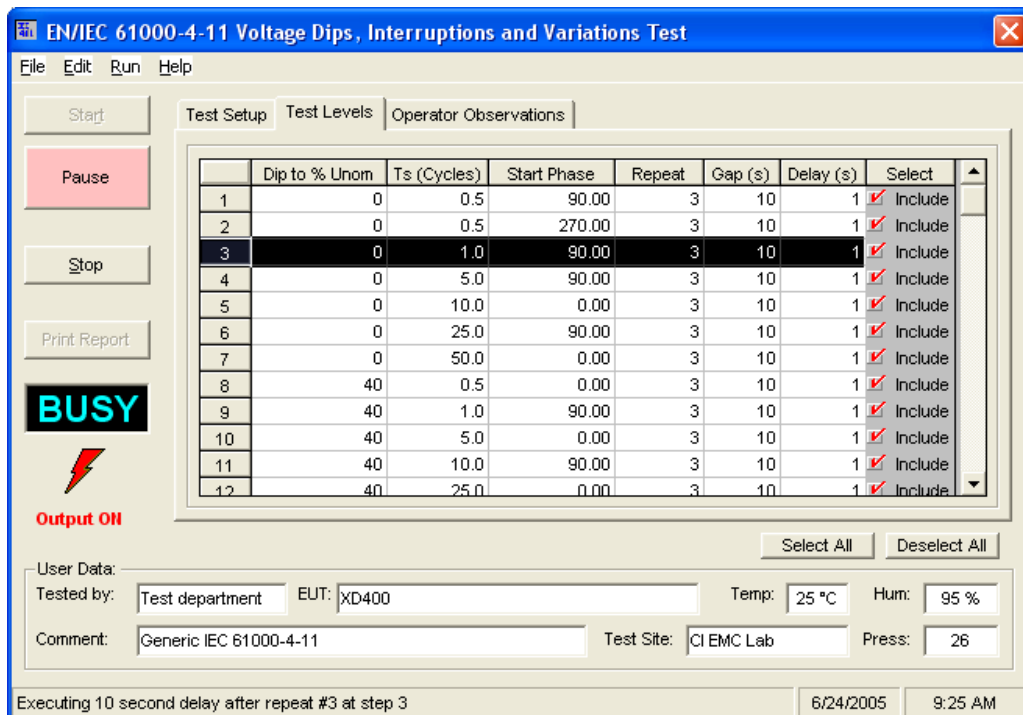

Figure 7-1: EN 61000-4-11 Test Window

### 7.3 Compliance Statement:

Based on the hardware specifications of the AC source in use, not all requirements for EN 61000-4-11 test generators may be met. In particular, the 1 to 5 microsecond rise and fall time called out in the specification is not met by most AC sources. This is unlikely to have any effect on the outcome of the test however. A unit that fails a voltage dropout with a 80 microsecond rise and fall time will not likely pass the same dropout performed at 5 microseconds rise and fall times and vice versa.

Also, the 500 Amps inrush current capability is not met. This requirement does not have to be met if the unit under test does not draw more inrush current than the AC source can deliver. The peak current pre-test option may be used to verify inrush capability of the source for the unit under test.

### 7.4 Specifying test sequences for Dips and Variations

The EN 61000-4-11 test suite consists of two types of tests:

- Dips and Interruptions      Simulates short interruptions in AC supply
- Voltage Variations          Simulates slow changes in AC supply

The user must select the desired test type before executing the test. Since both test types require a number of test parameters, the test sequence parameters must be entered in the data grid or loaded from disk using the File, menu entry.

Note that the EN 61000-4-11 specification based on common types of AC line disturbances found on the European utility network. The test voltage levels and dip

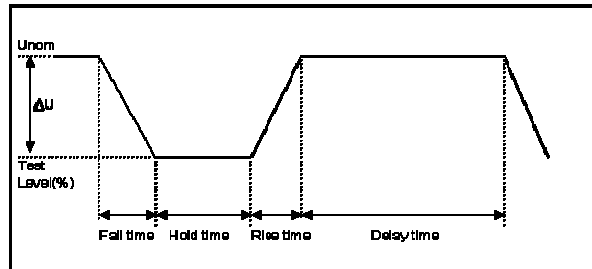

Figure 7-2: EN 61000-4-11 Voltage Variation specification

duration required to perform an EN 61000-4-11 tests is not uniquely defined. Instead, different test levels and durations are allowed for various product categories. Product committees set these test levels. For this reason, the test parameters used by the MXGUI for the EN 61000-4-11 test sequences can be specified by the user or loaded from disk. This allows unlimited customization of both voltage interruptions and voltage variations tests. Up to 100 sequences of voltage dips at various levels, phase angles and duration can be specified. Voltage variations can be defined by level, rise time, fall time and hold time. Refer to Figure 7-2 and Figure 7-3 for an illustration of how these parameters affect the V RMS output under the different standard revisions.

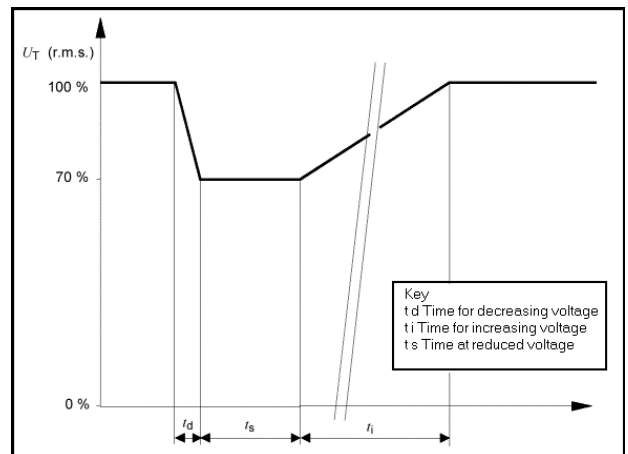

Figure 7-3: EN 61000-4-11 Voltage Variation specification – Edition 2.0

## 7.5 Test Setup

The following parameters and controls are available for executing the EN 61000-4-11 test:

Parameter	Description
Standard Revision	Select Edition 1.0 or Edition 2.0 as appropriate. The edition primarily affects the voltage variation mode data entry method and the timing of the voltage variations as indicated in Figure 7-2 and Figure 7-3 above.
Nominal Voltage	Opening the IEC 61000-4-11 test window will set this parameter to the present steady state frequency setting of the AC source. If required, a new value can be entered for use during the test. At the end of the test, the AC source will remain at this frequency.
Nominal Frequency	Opening the IEC 61000-4-11 test window will set this parameter to the present steady state voltage setting of the AC source. If required, a new value can be entered for use during the test. At the end of the test, the AC source will remain at this voltage.
Test Type	Available test types are Dips and Variations..
Phase Mode	The phase mode used is shown below the class selection. This mode cannot be changed from this window. To change phase mode, close this window and use the main front panel control window to select the desired phase mode first.
Run	Starts the EN 61000-4-11 test using the parameters set by the user. Test progress is shown at the bottom of the window. The sequence numbers shown correspond to those in the illustration.
Abort	Aborts test in progress.

## 7.6 Test Options

The operator may select one or more of the following options before starting the test:

Include Peak Current Test	The test standard requires that the AC generator used has the ability to deliver 500 Amps of inrush current to the EUT. This is neither economical nor practical. Instead, the EUT inrush current can be determined using a prescribed test method. If the EUT inrush current is 70 % or less of the AC sources' capability, the AC source may be used for full compliance testing. Setting this option determines the EUT inrush current using the standard method. The test takes about 12 minutes to complete. At the end, the program will inform the operator of the result and match this against the AC source's capability. See paragraph 7.2.
---------------------------	--

## 7.7 Test Results

There is no way for the MXGUI to determine the outcome of this test as a clear definition of a failure can not be given. The draft standard called out the following possible test results:

*“The test results shall be classified on the basis of the operating conditions and functional specifications of the equipment under test, as in the following, unless different specifications are given by product committees or product specifications.*

- a) Normal performance within the specification limits*
- b) Temporary degradation or loss of function or performance which is self-recoverable.*
- c) Temporary degradation or loss of function or performance which requires operator intervention or system reset.*
- d) Degradation or loss of function which is not recoverable due to damage of equipment (components) or software, or loss of data.*

*As a general rule, the test result is positive if the equipment shows its immunity, for the duration of the application of the test, and at the end of the tests the EUT fulfills the functional requirements established in the technical specification.”*

The user has to make this determination by observing the unit under test.

## 7.8 Report Format- 411 Test Files

The EN 61000-4-11 test module produces a test report when the Print Report button is clicked. Reports can also be printed from the File, Print menu. Test reports include all selected test parameters and options. A sample test report is shown below. The report format used can be direct output to a printer, output to a text file or generation of an MS Word report. The desired report format can be selected from the Options menu, under IEC Report Setup. MS Word reports are automatically saved in the C:\Program Files\California Instruments\MXGUI\Reports directory.

## 8. EN 61000-4-13 Harmonics and Inter harmonics Immunity Test

### 8.1 About this Chapter

The IEC 61000-4-13 Harmonics and Inter harmonics test offers range of sub-tests and user options. We recommend you familiarize yourself with the actual standard document. IEC standards are available through [www.iec.ch](http://www.iec.ch). The 2002-03 version of the IEC 61000-4-13 standard is implemented on the MX Series starting with revision 0.31 firmware. If the firmware in the MX Series AC source is less than 0.31, the Meister curve function will not be available. Contact California Instruments customer service for upgrade information. ([ci.ppd@ametek.com](mailto:ci.ppd@ametek.com)). The MXGui will automatically disable the Meister curve function if it detects older firmware.

The EN 61000-4-13 implementation in the MXGUI is based on a first edition of the EN 61000-4-13 standard. This test window is available only if the MX Series unit connected has the -413 option installed.

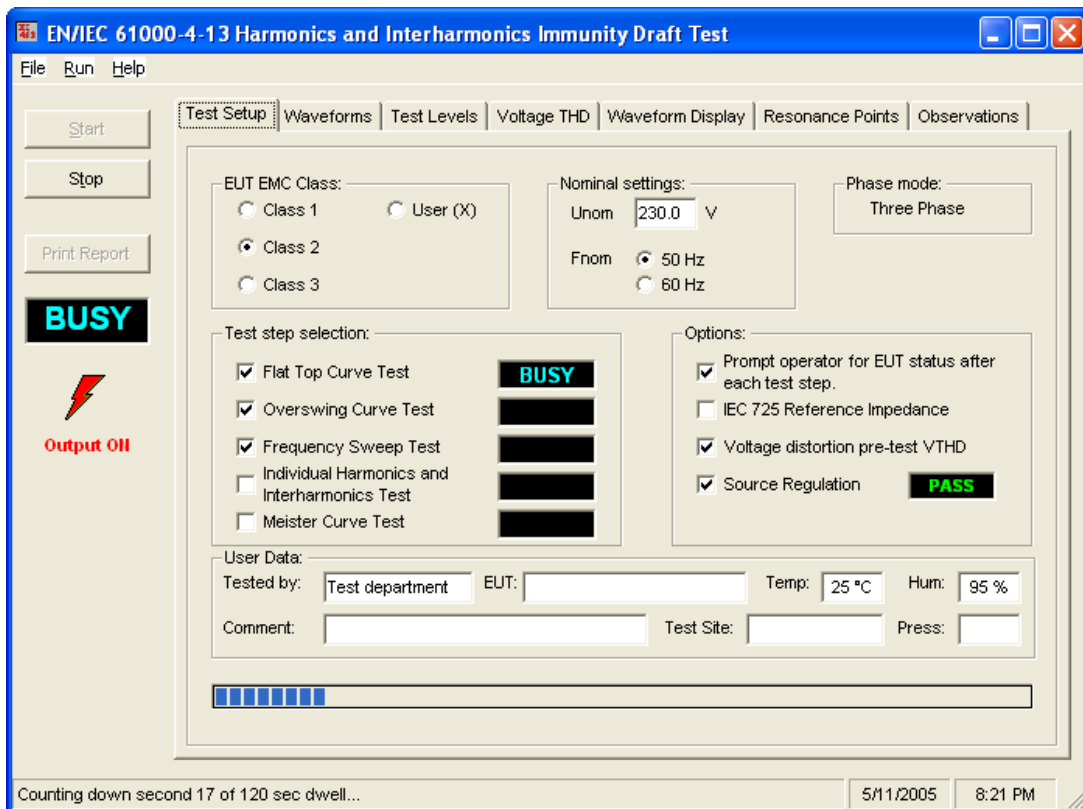

Figure 8-1: EN 61000-4-13 Test Window

## 8.2 Tab Controls

The IEC 1000-4-13 Harmonics and Interharmonics test offers range of sub-tests and user options. We recommend you familiarize yourself with the actual standard document. IEC standards are available through [www.iec.ch](http://www.iec.ch).

The following help screens contain information on setting test options using the available 413 tab controls located along the top of the IEC 1000-4-13 test window.

Tab	Description
Test Setup	User selected test options, EUT classes and test steps
Waveforms	Flat top curve and Over swing curve definitions
Test Levels	Sweep frequency ranges and test levels
Voltage Distortion	AC Source voltage distortion monitor display
Waveform Display	AC Source measured output waveform display
Resonance Points	EUT current as a function of frequency and resonance point summary.

The buttons on the left-hand side of the window may be used to start and stop a test run and print a test report.

Test parameters for Class X EUT's may be stored on and loaded from disk. This can be done using the File, Save and File, Open menus.

The results of a frequency sweep may be saved to disk for later recall as well. Data files have a .dat extension to distinguish them from a test setup file. (.413 extension) The Load and Save Data entries in the File menu are used for this purpose.



### 8.3 Test Setup

The Test Setup Tab contains several controls that allow the user to configure the EN 61000-4-13 test to be run on the EUT. The various settings are as follows:

Parameter	Description
Phase mode	The available phase mode is shown in the top right corner and cannot be changed. For single-phase systems, phase A is always used as it is the only phase. For three phase systems, all stimuli are applied to all three phases.
EUT EMC Class	The test standard distinguishes between four classes of EUT, class 1 through 3 and a user defined class X. The user must select class 1, 2, 3 or X. Class X levels can be set in the Test levels Tab but must be equal than or higher than class 3 levels.
Nominal Settings	These values are normally obtained from the AC source's steady state setting when the test window is opened. They can be changed before running a test if needed. Note however than frequencies other than 50 or 60 Hz are not covered by the test standard.
Test Step Selection	There are four main test categories that may be selected. Consult the test standard for details on each step. Any combination of these four choices can be made.
Test Options	<p>Prompt for EUT status: When checked, the program will prompt the operator for a Pass or Fail determination after each test step selected in the Test Step Selection box has been run. If this option is turned off, all test will be run and this dialog will only appear when all test are completed.</p> <p>IEC 725 Reference Impedance: If needed, the IEC 725 Flicker reference impedance may be used during the EN 61000-4-13 test.</p> <p>Voltage THD: When checked, the test program performs an AC Source voltage distortion pre-test and displays the result in the Voltage THD Tab.</p> <p>Source Regulation: When checked, the test program will checked the AC Source output voltage regulation with the EUT connected to ensure the AC source meets the test standard requirements.</p>
User Data	The fields at the bottom of the Tab may be used to enter information on the person or entity performing the test, the EUT and any other comments that may be relevant. This information will be incorporated in the test report.

User selected EUT Class, test steps; options and nominal values are all included on the EN 61000-4-13 test reports.

### 8.4 Test Sequence

The EN 61000-4-13 standard specifies the test flow diagrams shown in the next two pages per EUT test class 1, 2 or 3. The operator is responsible for following the correct flow diagram.

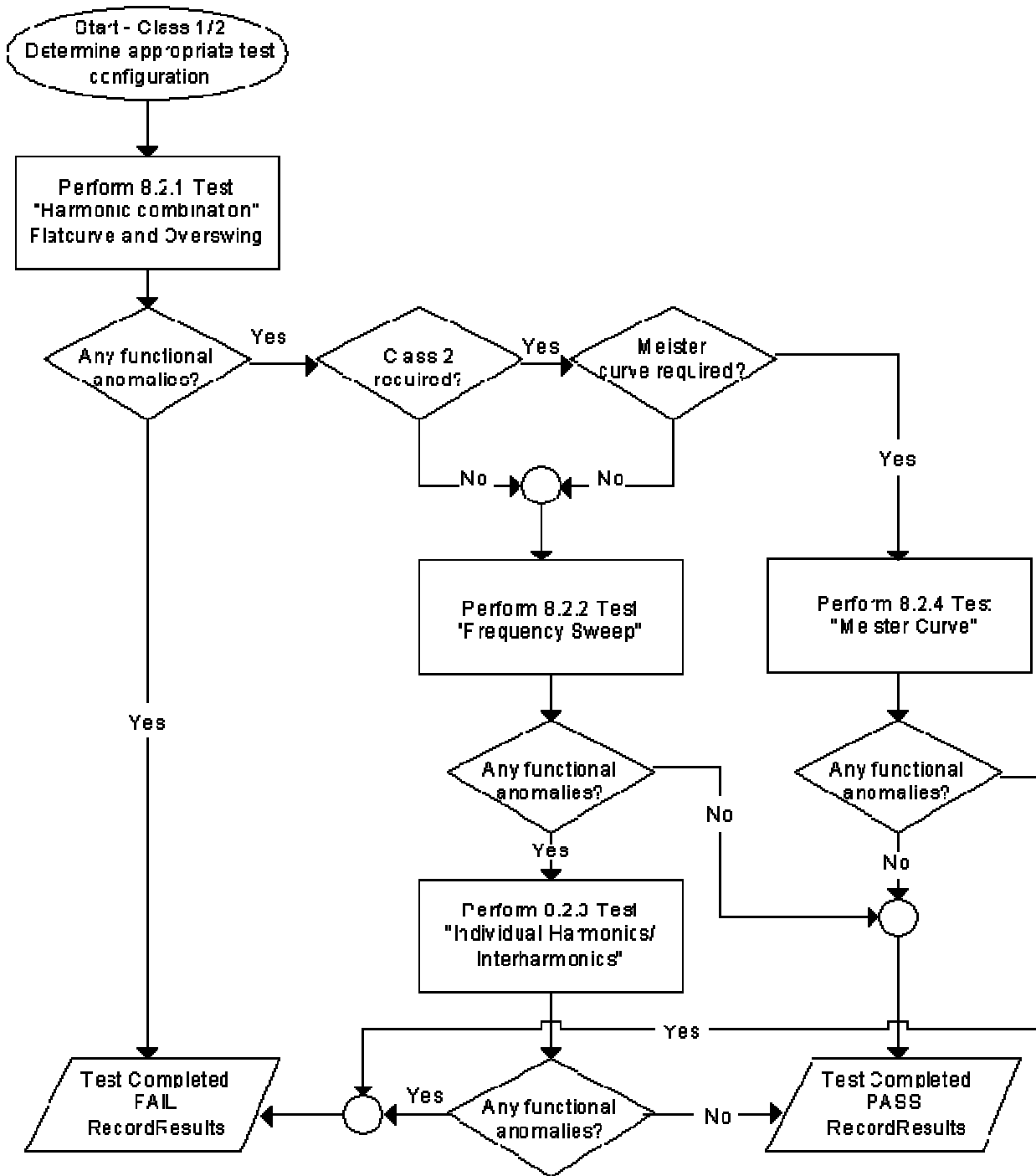

Figure 8-2: EN 61000-4-13 Flow Chart, Class 1 and 2 EUT's.

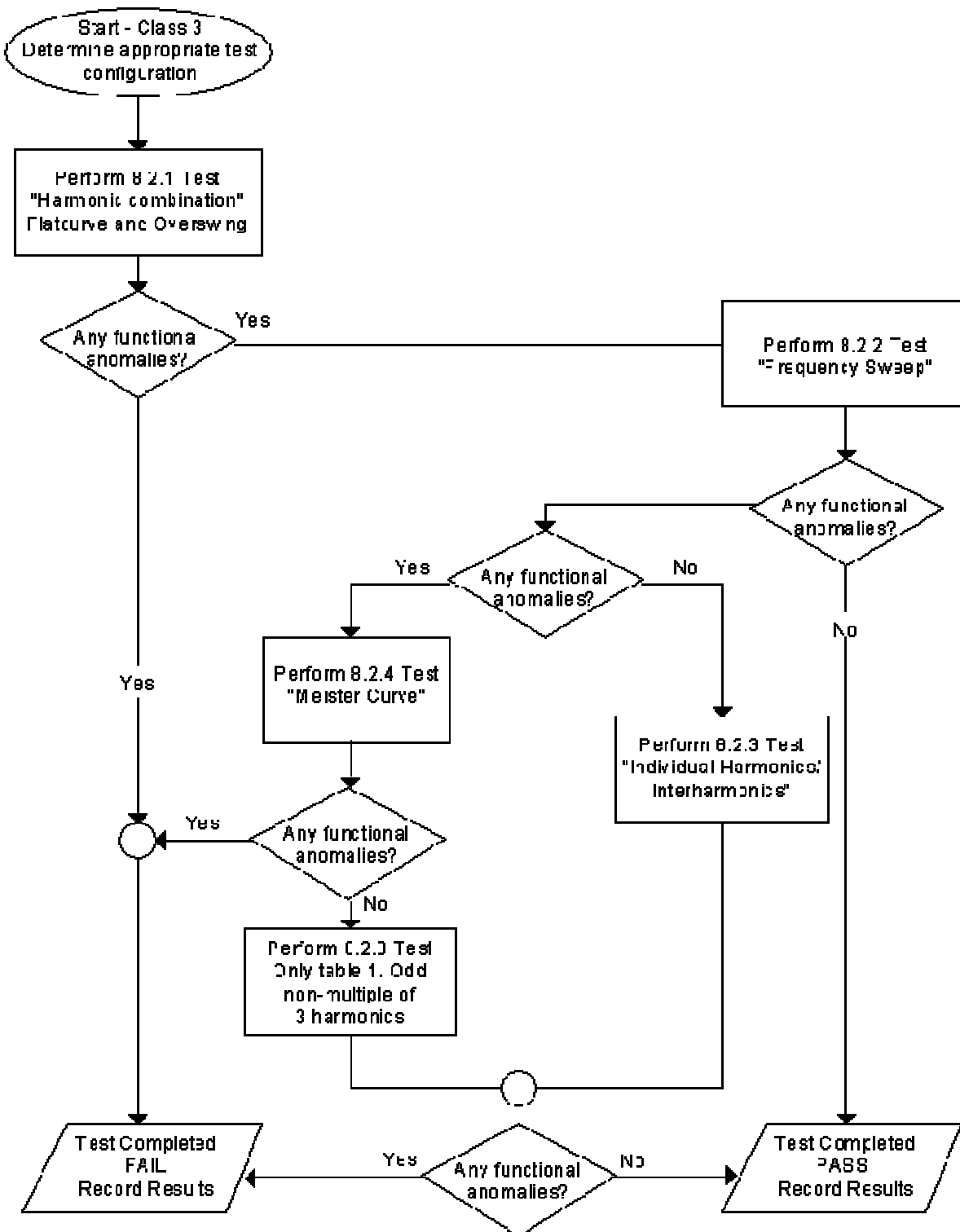

Figure 8-3: EN 61000-4-13 Flow Chart, Class 3 EUT.

The EN 61000-4-13 test suite consists of four types of tests:

Test type	Description
Flat top Curve	Simulates specific waveform at the nominal voltage and frequency
Over Swing Curve	Simulates specific waveform at the nominal voltage and frequency
Frequency Sweep	Simulates frequency swept or stepped at a rate no less than 5 minutes per decade
Individual harmonics & Inter harmonics	Simulates sinusoidal voltage superimposed on the fundamental voltage for 5 second at each frequency in a range from 2X to 40X fundamental
Meister Curve	Special frequency sweep test to be used in countries where mains signaling and /or ripple control is applied.

The user must select the desired EMC Class and test type before executing the test. If choosing class X, the user can change any parameters but the levels have to be at least as high as those for Class 2.

The total test time using the default dwell times are as follows:

Test Step	Test Time
Flat Top Curve test:	Dwell time = 120 sec Pause time = 5 sec
Over Swing Curve test:	Dwell time = 120 sec Pause time = 5 sec
Frequency Sweep test:	Dwell time = 300 sec (per decade) * 2.5 = 750 sec
Individual harmonics:	Dwell time = 5 sec (per harmonic) * 40 = 200 sec Pause time = 1 sec (per harmonic) * 40 = 40 sec
Inter harmonics:	Dwell time = 5 sec (per harmonic) * 40 = 200 sec Pause time = 1 sec (per harmonic) * 40 = 40 sec
Meister Curve:	Dwell time = 10 sec (per frequency step) * 147 = 1470 sec Pause time = 0 sec

Changes made to dwell times and test levels can be saved using the File, Save menu.

There are two .413 files distributed with the MXGUI program. The Class2.413 and Class3.413 files are read-only files and cannot be edited or changed. These files contain all parameters, which are determined by the product standard. When changing the Dwell and Pause times for Class 2 or Class 3, the user has to save the file under a different name.

### 8.4.1 Test Waveform Settings

The Waveforms Tab may be used to preview the Class 2 and Class 3 Flat top and Overswing waveforms. For class X, the waveform parameters may be entered in the controls to the left of the waveform display. Dwell times and pause times may be set for all classes.

Note that this Tab is only relevant if either the Flat Top or Over Swing test steps are selected in the Test Setup tab.

### 8.4.2 Test Level Settings

The Test Levels Tab may be used to preview the Class 2 and Class 3 frequency ranges and test levels. For class X, this information may be edited. Dwell times and pause times may be set for all classes. The following minimum and maximum values (in seconds) for dwell and pause times apply. Note that these values are queried from the AC source if present and may change if the firmware on the AC source is updated. As default, these times are set to their minimum values.

Test Type	Parameter	Minimum	Maximum
Sweep Frequency	Dwell	300	3600
Inter harmonics	Dwell	5	600
	Pause	1	60
Harmonics	Dwell	5	600
	Pause	1	60
Meister Curve	Dwell	10	600
	Pause	0	60

Note that this Tab is only relevant if either the Flat Top or Over Swing test steps are selected in the Test Setup tab.

### 8.5 Test Results

There is no way for the MXGUI to determine the outcome of this test, as a clear definition of a failure cannot be given. The draft standard calls out the following possible test results:

*“The test results shall be classified on the basis of the operating conditions and functional specifications of the equipment under test, as in the following, unless different specifications are given by product committees or product specifications.*

- a) Normal performance within limits specified by the manufacturer, requestor or purchaser
- b) Temporary loss of function or degradation of performance which ceases after the disturbance ceases, and from which the equipment under test recovers its normal performance, without operator intervention.
- c) Temporary loss of function or degradation of performance, the correction of which requires operator intervention.
- d) Loss of function or degradation of performance which is not recoverable, owing to damage to hardware or software, or loss of data.

*As a general rule, the test result is positive if the equipment shows its immunity, for the duration of the application of the test, and at the end of the tests the EUT fulfills the functional requirements established in the technical specification.”*

The user has to make this determination by observing the unit under test. At the end of the test, the GUI will pop up a dialog box asking the operator to assess the state of the EUT. This prompt can be selected to appear after each test as by setting the "Prompt operator for EUT Status each test step" option. The operator may answer Yes when prompted. If not, he should answer no. The response to this query is incorporated as a PASS or FAIL result in the test report.

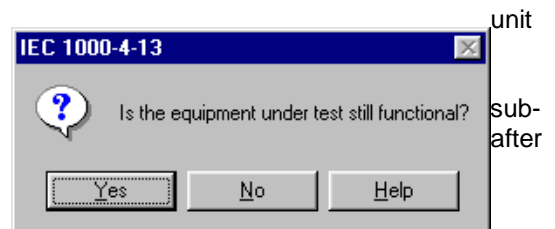

## 8.6 Measurements

The following measurements are performed during the IEC 1000-4-13 test run.

### 8.6.1 Voltage Waveform Time Domain

This Tab displays the voltage waveform as captured at the EUT by the MX Series' data acquisition system. This information is updated every couple of seconds and allows the user to monitor the stimulus applied to the EUT. This TAB is only used for display purposes and contains no user controls.

### 8.6.2 Resonance Points

During the test run, the voltage waveform is captured and displayed in the Waveform display Tab page. This allows the user to determine if the EUT continues to operate. There may be effects on the EUT such as reboots or processor lockups that cannot be seen by observing the EUT load current. Frequency is not measured as it remains at the nominal frequency specified.

The resonance points Tab displays the EUT current as a function of the harmonic and interharmonic frequencies applied to the EUT during the test. This information is displayed both numerically in the table on the left and graphically in the chart on the right. Those points that meet the criteria for a resonance point are listed in the table directly below the graph. Note that there may not be any resonance points on a given EUT. In that case, this table will be empty. The total number of resonance points found is shown between the graph and the resonance point table.

There are no user controls or settings on this Tab as it is used for data display only. Test results may be printed to the default Windows printer using the print button or the File, Print menu.

## 8.7 EN 61000-4-13 Test Reports

The EN 61000-4-13 test module produces a test report when the Print Report button is clicked. Reports can also be printed from the File, Print menu. Test reports include all selected test parameters and options. The report format used can be direct output to a printer or generation of an MS Word report. The desired report format can be selected from the Options menu, under IEC Report Setup. A sample section of an EN 61000-4-13 test report is shown below. MS Word reports are automatically saved in the C:\Program Files\California Instruments\MXGUI\Reports directory.

## 9. EN 61000-4-14 Voltage Fluctuations Immunity Testing

### 9.1 About This Chapter

This chapter covers testing a device for compliance with the EN 61000-4-14 Voltage Fluctuations test standard. This test is supported through the MXGUI AC source control program.

The EN61000-4-14 implementation in the MXGUI is based on the EN61000-4-14 standard dated 1999-02 and Amendment 1, dated 2001-07. Test levels and times can be changed if needed through the use of one or more *filename.414\_Fluc* files in the IEC\_Test directory.

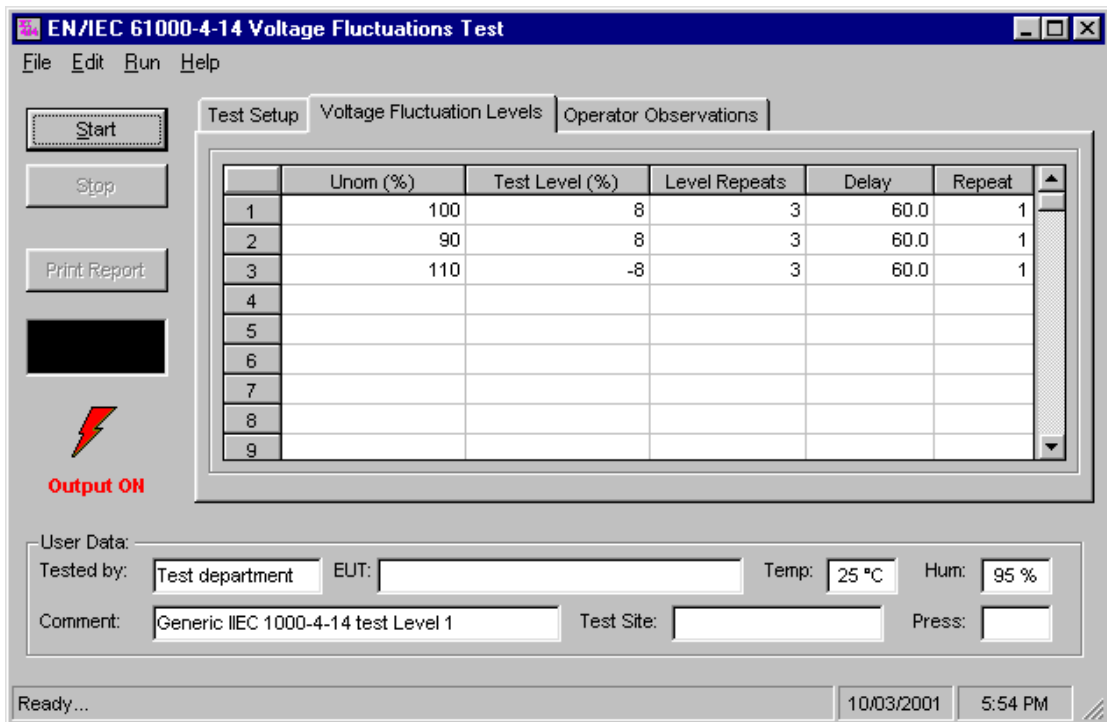

Figure 9-1: EN 61000-4-14 Test Window

## 9.2 Test Setup

The following parameters and controls are available for executing the EN 61000-4-14 test:

Control / Field	Description
Nominal voltage	Opening this window will set this parameter to the present steady state voltage setting of the AC source. If required, a new value can be entered for use during the test. At the end of the test, the AC source will remain at this voltage level. If needed, the program will switch the AC source to the high voltage range and close the output relay when the test is started.
Nominal frequency	Opening this window will set this parameter to the present steady state frequency setting of the AC source. If required, a new value can be entered for use during the test. At the end of the test, the AC source will remain at this frequency.
Test Method	See under Test Options below
Source Regulation	See under Test Options below
EUT Class	The EUT class determines the test levels used. Class selection is done by loading the correct class file from disk..
Phase Mode	The phase mode is determined by the AC source configuration. This mode cannot be changed from this window. To change phase mode, close this window and use the main front panel control window to select the desired phase mode first.
Start	Starts the EN 61000-4-14 test using the parameters set by the user. Test progress is shown at the bottom of the window. The sequence numbers shown correspond to those in the illustration.
Stop	Aborts test in progress.



### 9.3 Test Sequence

The test sequence implemented by this test consists of a series of voltage fluctuations consistent with commonly found phenomena on the public utility power grid. The objective of this test is to evaluate a product for immunity from such fluctuations.

Voltage fluctuations are applied at different levels for different product categories. The user must determine the product class and select the appropriate test level. During the test run, voltage changes are applied as specified by the selected test mode and for specified periods of time.

The test sequence can be programmed by setting the nominal voltage in %, the test level which is the change from the nominal voltage in %, the number of times each test level repeats (consecutive 5 second periods) and the delay between each set of test levels. Finally, each step in the sequence data grid can be repeated 1 or more times. (A Delay of 1 means the set it only run once.) The various columns in the test data setup are shown in the figure below. In this example, the following parameters were specified in the data entry grid:

Unom (%)	Test Level (%)	Level Repeat	Delay	Repeat
100	8	3	60	1

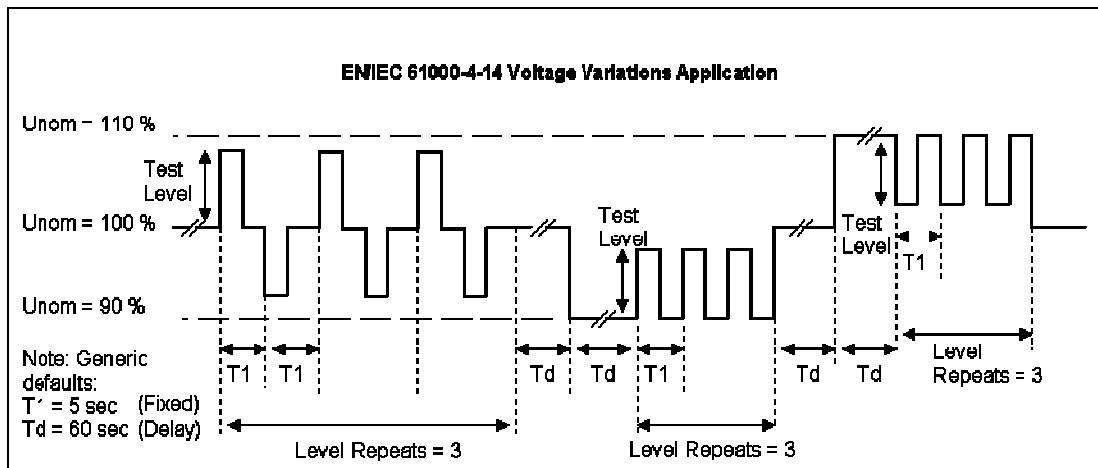

Figure 9-2: EN 61000-4-14 Test Sequence

Note that the sequence of voltage changes is different if the Unom is at 100 % than at any other value. At 100 % Unom, the voltage changes occur in both positive and negative directions (alternating). If the test level (%) is set to a negative value and Unom is 100 %, the voltage changes are reversed.

These parameters can be entered on screen by the operator or loaded from disk. To load a new test or test class, select the File, Open menu. The default location for IEC test files is:

C:\Program Files\California Instruments\Mxgui\IEC\_Test

The following four EN 61000-4-14 test files are distributed with the MXGUI program:

File Name	Test Class
Generic IEC 1000-4-14 Test Class 2.414_Fluc	Class 2
Generic IEC 1000-4-14 Test Class 3.414_Fluc	Class 3

The user may create as many test files as desired using the data entry grid. Changes made can be saved using the File, Save As... menu entry.

### 9.4 Test Levels

In Annex B of the draft standard, the EUT operating environment classifications are defined based on IEC 1000-2-4. The classifications are as follows:

Class	Environment
<b>Class 1</b>	Applies to protected supplies with compatibility levels lower than public network levels. It relates to the use of equipment, which is very sensitive to disturbances in the power supply, for instance the instrumentation of technological laboratories, some automation and protection equipment, some computers etc. This equipment is normally supplied by protected supplies such as uninterruptible power supplies, filters or surge suppressors.
<b>Class 2</b>	Applies to points of common coupling (PCCs for consumer systems) and in-plant points of common coupling (IPCs) in the industrial environment in general. The compatibility levels in this class are identical to those of public networks.
<b>Class 3</b>	Applies only to IPCs in industrial environments. It has higher compatibility levels than those of class 2 for some disturbance phenomena. This class should be considered when any of the following conditions are met: - a major part of the load is fed through converters - welding machines are present - large motors are frequently started - loads vary rapidly

Test levels are specified for class 2 and 3 only. Class X test levels may be defined by specific product standards.

Environment Class	Unom (Nominal Voltage)	Unom + 10 %	Unom - 10 %
Class 1	no test required	no test required	no test required
Class 2	± 8 % Unom	- 8 % Unom	+ 8 % Unom
Class 3	± 12 % Unom	-12 % Unom	+ 12 % Unom
Class X	Open but must be higher than Level 2	Open but must be higher than Level 2	Open but must be higher than Level 2

### 9.5 Voltage Fluctuation

The IEC 61000-4-14 test standard specifies a specific voltage fluctuation methods for changing the voltage between test levels. This fluctuation is a combination of a series of 5 single period fluctuations, each having a 0.25 period slew starting at 270° phase angle of the voltage waveform. Thus, the complete rise ( $t_r$ ) and fall ( $t_f$ ) time of the voltage fluctuation includes the following two items:

#### a) Single Period Fluctuation

Lasts for one period of the fundamental frequency. The voltage changes starts at the 270° phase angle and changes linearly for one quarter period until it reaches the next voltage level ( $\Delta U_{nom} / 5$ ) at 0°. This is illustrated in the figure below.

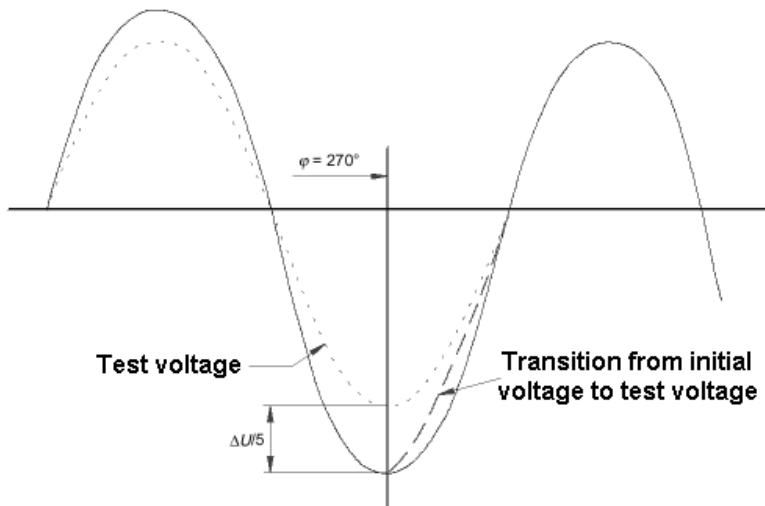

#### b) Complete Fluctuation

Five single period fluctuations as shown above combine into the complete voltage fluctuation to the test level.  $[U_{nom} \pm \Delta U]$  The test level is held for a 2 second period and then stepped back up or down to its nominal value. This is illustrated in the figure below which combines figures 1b and 1c of the IEC 61000-4-14 test standard.

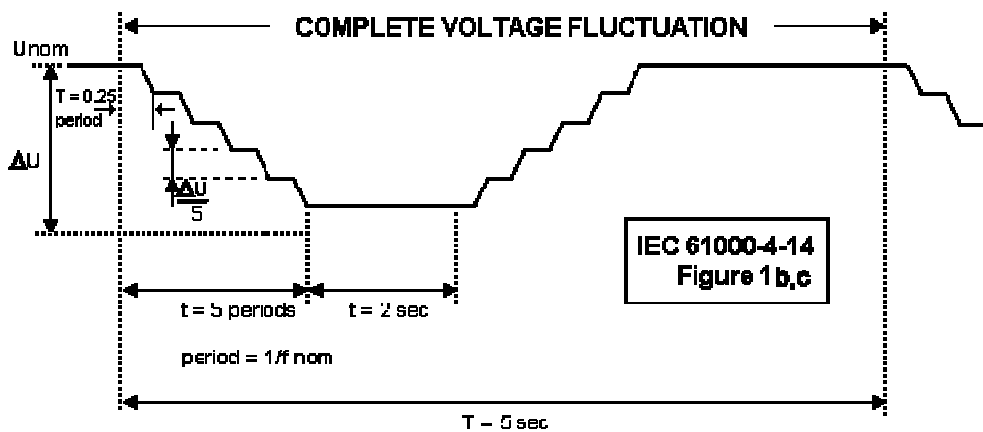

Note: Prior versions of the MXgui (< 1.20.0.1) required a user selection between a slew or a stepped voltage fluctuation. Both have been combined per above description to more closely follow the IEC 61000-4-14 test standard.

### 9.6 Test Execution

The selected test mode can be started by pulling down the Run menu and selecting “All” or by clicking on the Start button. During test execution, no changes to test parameters are allowed. The test progress can be monitored at the bottom of the window in the status bar.

### 9.7 Test Parameter File Creation and Limits

New tests can be created by editing the data entry grid. The following test parameters are available for each test step. Note that the number of test steps is limited to 100 steps which should be more than adequate to cover any possible product standard.

Field	Description	Range
Unom (%)	Specifies the percentage of Unom to use for this test step. Typical values are 100 %, 110 % and 90 % for a 0, +10 and -10 change.	50 to 150 %
Test Level (%)	Specifies the percentage change from Unom to apply for this test step. Test levels are defined for different product classes.	-20 to +20 %
Level Repeats	Number of times specified test level is applied at this step. Normally, this value is set to 3. Each test level is applied for 2 seconds and repeats in 5 second window. The rise and fall times are set to 5 cycles each.	1 to 100
Delay (s)	Time in seconds between successive repeats of this test step.	0.1 to 999.9 sec.
Repeats	Number of times this test step is repeated. Normally, this value is set to 3.	1 to 100

### 9.8 Test Results

There is no way for the MXGUI to determine the outcome of this test as a clear definition of a failure can not be given. The draft standard called out the following possible test results:

*“The test results shall be classified on the basis of the operating conditions and functional specifications of the equipment under test, as in the following, unless different specifications are given by product committees or product specifications.*

- a) Normal performance within limits specified by the manufacturer, requestor or purchaser
- b) Temporary loss of function or degradation of performance which ceases after the disturbance ceases, and from which the equipment under test recovers its normal performance, without operator intervention.
- c) Temporary loss of function or degradation of performance, the correction of which requires operator intervention.
- d) Loss of function or degradation of performance which is not recoverable, owing to damage to hardware or software, or loss of data.

*As a general rule, the test result is positive if the equipment shows its immunity, for the duration of the application of the test, and at the end of the tests the EUT fulfills the functional requirements established in the technical specification.”*

The user has to make this determination by observing the test. At the end of a test run, the following dialog box is displayed. Click on the Help button to display the pass/fail criteria above.

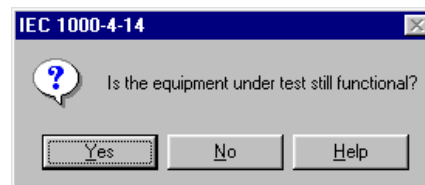

unit under test is displayed. shown

### 9.9 Report Format- 414 Test Files

The EN 61000-4-14 test module produces a test report when the Print Report button is clicked. Reports can also be printed from the File, Print menu. Test reports include all selected test parameters and options.

A sample test report is shown below. The report format used can be direct output to a printer, output to a text file or generation of an MS Word report. The desired report format can be selected from the Options menu, under IEC Report Setup. MS Word reports are automatically saved in the C:\Program Files\California Instruments\MXGUI\Reports directory.

## 10. EN 61000-4-17 DC Ripple Immunity Testing

### 10.1 About This Chapter

This chapter covers testing a device for compliance with the EN 61000-4-17 DC Voltage Ripple test standard. This test is supported through the MXGUI AC source control program.

The EN 61000-4-17 implementation in the MXGUI is based on the EN 61000-4-17 standard dated 1999-06. Test levels and ripple frequency can be changed if needed or set to one of the pre-defined test levels.

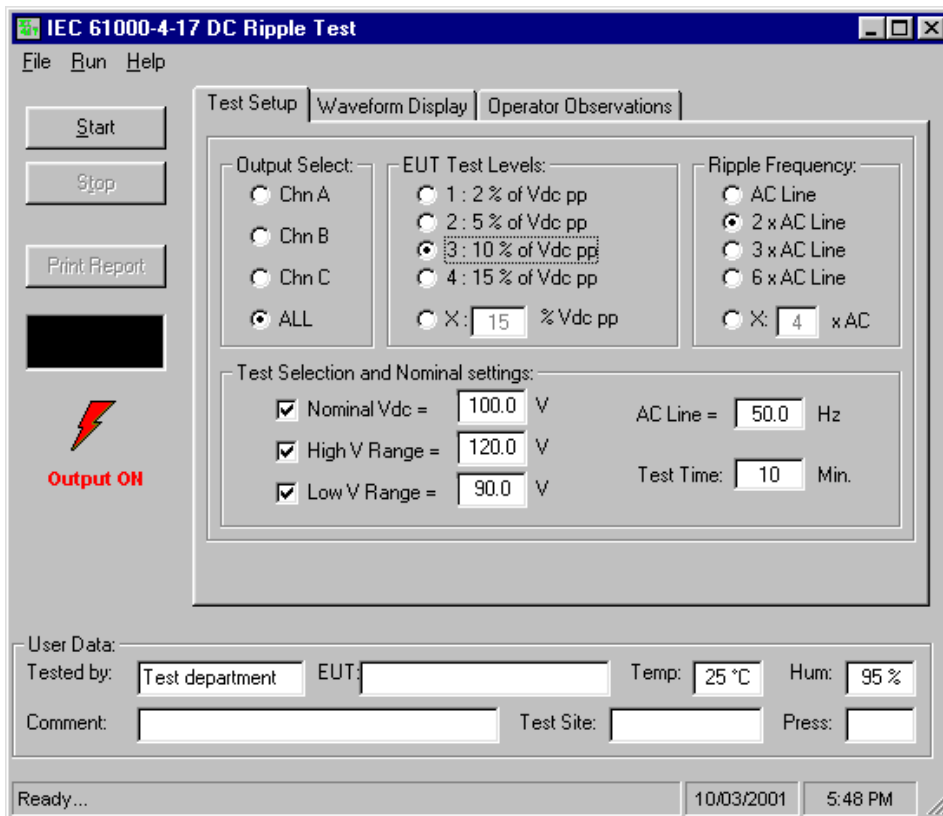

Figure 10-1: EN 61000-4-17 Test Window

## 10.2 Test Setup

The following parameters and controls are available for executing the EN 61000-4-17 test:

Control / Field	Description
Nominal DC voltage	This is the rated nominal DC supply voltage to the EUT. Both a high and low DC voltage range can be specified as well. When selected, the test will run at the selected voltage levels. This can any combination of nominal, high and low.
Line frequency	This sets the nominal AC line frequency. The ripple frequency will be a multiple of the AC Line frequency.
Output Select	For three phase systems, the output select enables one of three outputs or all three. The default is channel (phase) A.
EUT Test Levels	The test levels used are determined by the EUT class. Available levels are 2, 5, 10 or 15 %. A user defined test level from 0 to 25 % may be set as well.
Ripple Frequency	This fields sets the multiplier for the ripple frequency. Available settings are 1, 2, 3 and 6. A user defined multiplier is available as well.
Test Time	The default test time is 10 minutes. If more than one DC Voltage level is selected, the test time increases with this amount for each selected level. The test time can be set as low as 1 minute or as high as 9999 min.
Start	Starts the EN 61000-4-14 test using the parameters set by the user. Test progress is shown at the bottom of the window. The sequence numbers shown correspond to those in the illustration.
Stop	Aborts test in progress.

## 10.3 Test Sequence

The test sequence implemented by this test consists of the application of an AC ripple of specified peak to peak value in percent of the DC voltage at a frequency determined by the multiplier times the AC Line frequency for a set period of time.

The ripple waveform consists of a sinusoidal linear waveshape as shown below. The objective of this test is to evaluate a product for immunity from such ripple.

## 10.4 Waveform Display

The DC output waveform is acquired at regular intervals during the test and can be displayed by selecting

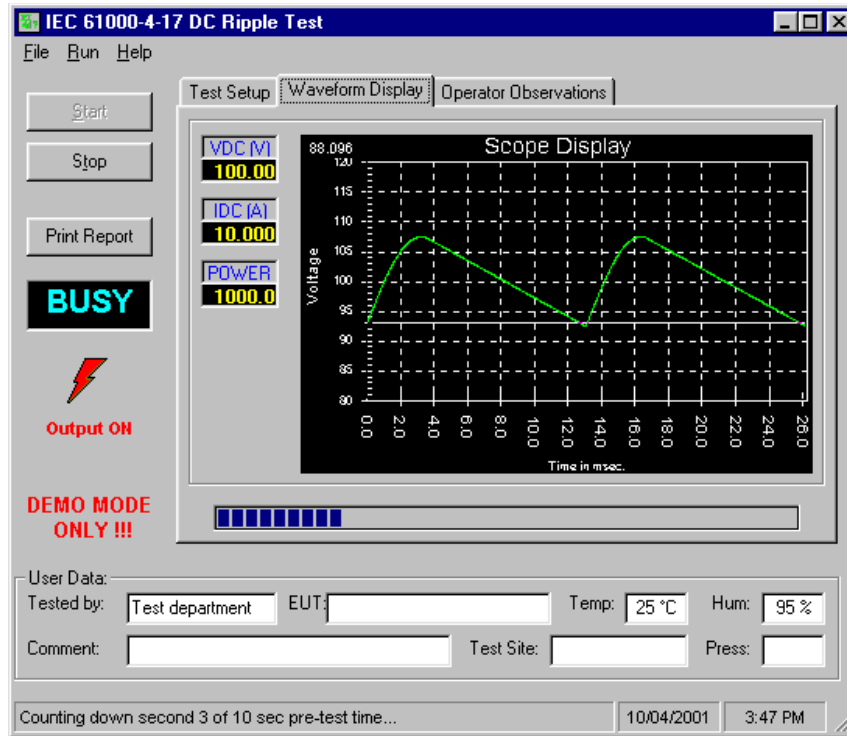

Figure 10-2: EN 61000-4-17 Waveform Acquisition Window

the Waveform Display tab.

## 10.5 Test Results

There is no way for the MXGUI to determine the outcome of this test as a clear definition of a failure can not be given. The draft standard called out the following possible test results:

*“The test results shall be classified on the basis of the operating conditions and functional specifications of the equipment under test, as in the following, unless different specifications are given by product committees or product specifications.*

- a) *Normal performance within the specification limits*
- b) *Temporary degradation or loss of function or performance which is self-recoverable.*
- c) *Temporary degradation or loss of function or performance which requires operator intervention or system reset.*
- d) *Degradation or loss of function which is not recoverable due to damage of equipment (components) or software, or loss of data.*

*As a general rule, the test result is positive if the equipment shows its immunity, for the duration of the application of the test, and at the end of the tests the EUT fulfills the functional requirements established in the technical specification.”*

The user has to make this determination by observing the unit under test. At the end of a test run, the following dialog box is displayed. Click on the Help button to display the pass/fail criteria shown above.



## 10.6 User Observations

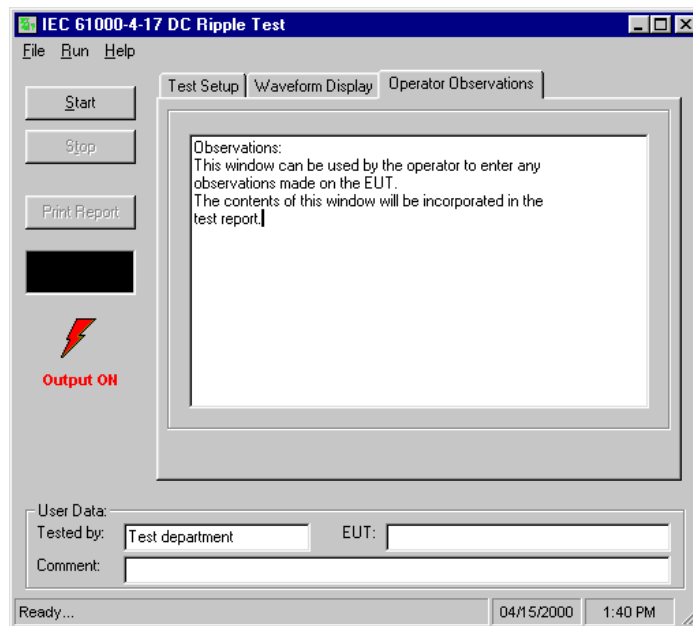

Figure 10-3: EN 61000-4-17 User Observation Data Entry Window

The MXGUI provides a data entry window for the operator. Observations made about the EUT can be entered in this window before, during and after a test run. Any information entered by the operator in this window will be incorporated in the test report when printed.

## 10.7 Report Format- 417 Test Files

The EN 61000-4-17 test module produces a test report when the Print Report button is clicked. Reports can also be printed from the File, Print menu. Test reports include all selected test parameters and options. A sample test report is shown below. The report format used can be direct output to a printer or generation of an MS Word report. The desired report format can be selected from the Options menu, under IEC Report Setup. MS Word reports are automatically saved in the C:\Program Files\California Instruments\Mxgui\Reports directory.

## 10.8 Saving and Loading Test Setups

Frequently used test setups can be save to disk by using the File, Save or File Save As menu entries. Setup files for EN 61000-4-17 tests have a ".417" file extension.

To select a previously saved test setup, use the File, Open menu entry and select the desired file from the file open dialog.

## 11. EN 61000-4-27p Voltage Unbalance Immunity Testing

### 11.1 About This Chapter

This chapter covers testing a device for compliance with the EN 61000-4-27 Voltage Unbalance in three phase AC power systems. This test is supported through the MXGUI AC source control program.

This test is only available on three-phase CTS Systems as it involves voltage and phase unbalance between three phases of a three phase supply network. The EN 61000-4-27 implementation in the MXGUI is based on the EN 61000-4-27 standard dated 2000-08. Test levels and durations can be changed if needed through use of one or more *filename.427* files in the IEC\_Test directory.

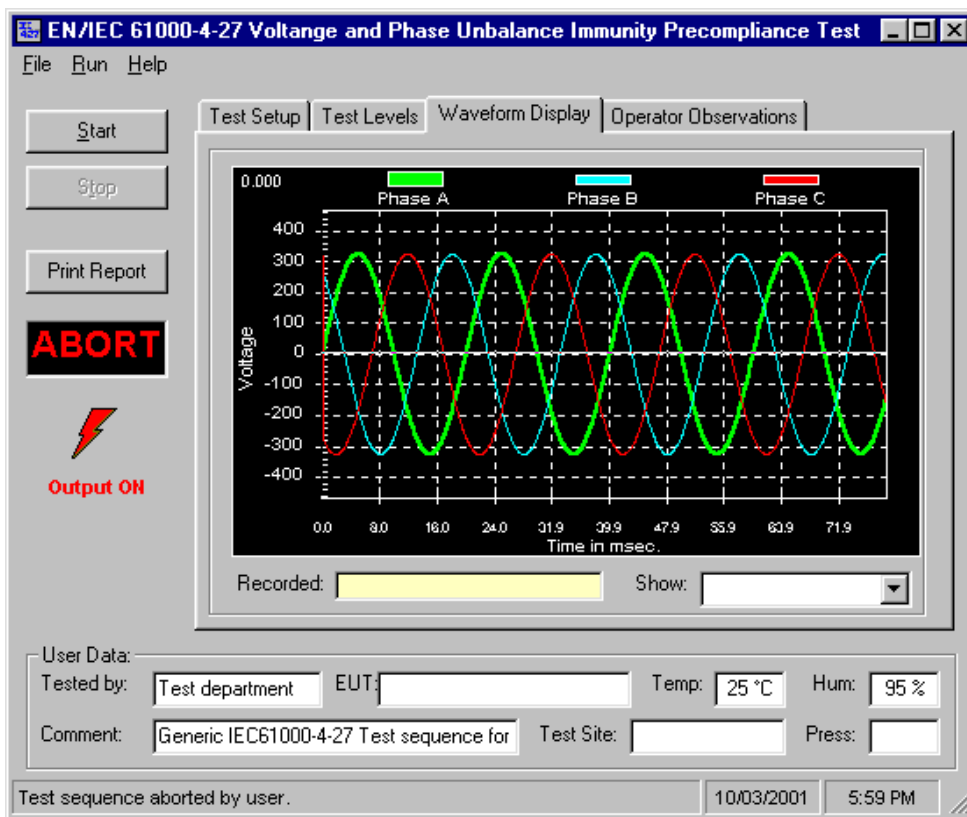

Figure 11-1: EN 61000-4-27 Test Window

## 11.2 Test Setup

The required IEC 61000-4-27 test parameters must be entered in the test data entry grid before running a test. Previously stored test files can be loaded from the File, Open menu. Test files use a .427 file extension and only files with this extension can be loaded.

The MXGUI is distributed with a pre-defined test parameter files for the generic IEC 61000-4-27 product classes 2 and 3. Additional test parameter files e.g. for test level x, can be created by the user by editing the data entry grid and saving the new data under a user specified name.

The following parameters and controls are available for executing the IEC 61000-4-27 test:

Field / Control	Description
Nominal voltage	Opening this window will set this parameter to the present steady state voltage setting of the AC source. If required, a new value can be entered for use during the test. At the end of the test, the AC source will remain at this voltage level. If needed, the program will switch the AC source to the high voltage range and close the output relay when the test is started.
Nominal frequency	Opening this window will set this parameter to the present steady state frequency setting of the AC source. Available selections are 50 Hz or 60 Hz. At the end of the test, the AC source will remain at this frequency.
EUT Class	The EUT class determines the test levels used.
Test number	Allows selection of one or more test numbers. If all test numbers are selected, they will be executed in sequential order.
Performance Criterion	This selection will be used to indicate in the test report how the outcome of the test was evaluated. The criteria are explained <a href="#">here</a> .
Execution Parameters	<p>Number of sequences to run: A number of one indicates that the test level selected will be run one time per phase rotation for a total of 3 times. A number greater than one will result in repeating the same phase rotation that many times.</p> <p>Delay between sequences in minutes: A delay of 3 minutes minimum is required between tests. This value may be extended if desired.</p> <p>Pre-test delay in seconds: Time to wait in seconds between applying power to EUT and starting the first test sequence.</p>
Phase Mode	This test is only valid when the power system is in three-phase mode so no phase mode selection is available. The phase mode is always three phase.
Start	Starts the EN 61000-4-27 test using the parameters set by the user. Test progress is shown at the bottom of the window. The sequence numbers shown correspond to those in the illustration.
Stop	Aborts test in progress.

All IEC 61000-4 tests require setting of the rated nominal voltage and frequency of the EUT. The nominal values must be entered in the Test Setup Vnom and Fnom data fields before starting a test. When the IEC 61000-4 test windows is first opened, the present AC source settings are automatically loaded as the nominal values. These values are overridden by selecting each data entry field and typing in a new value or by loading a test parameter file from the File, Open menu. Thus, test data file also contain the nominal voltage and frequency values to be used.

### 11.3 Equipment Classifications

In Annex B of the standard, the EUT operating environment classifications are defined based on IEC 61000-2-4. The classifications are as follows:

<b>Class 1</b>	Applies to protected supplies with compatibility levels lower than public network levels. It relates to the use of equipment, which is very sensitive to disturbances in the power supply, for instance the instrumentation of technological laboratories, some automation and protection equipment, some computers etc. This equipment is normally supplied by protected supplies such as uninterruptible power supplies, filters or surge suppressors.
<b>Class 2</b>	Applies to points of common coupling (PCCs for consumer systems) and in-plant points of common coupling (IPCs) in the industrial environment in general. The compatibility levels in this class are identical to those of public networks.
<b>Class 3</b>	Applies only to IPCs in industrial environments. It has higher compatibility levels than those of class 2 for some disturbance phenomena. This class should be considered when any of the following conditions are met: - a major part of the load is fed through converters - welding machines are present - large motors are frequently started - loads vary rapidly

Testing is not recommended for Class 1 equipment. Test level X specifications are to be agreed upon by the manufacturer and user. Test Levels for environmental Class 2 and 3 equipment are defined by the generic standard. A user class X (user) with test level equal or higher than those of level 2 may be set as well.

### 11.4 Test Levels

The test sequence implemented by this test consists of a series of voltage and phase unbalance variations consistent with commonly found phenomena on the public utility power grid. The objective of this test is to evaluate a product for immunity from such variations.

Voltage unbalances are applied at different levels for different product categories. The user must determine the product class and select the appropriate test level. During the test run, voltage and phase changes are applied. The voltage levels and phase shifts are determined by the values set in the data entry grid. The various columns in the test data setup are as follows:

Parameter	Description	Range
Test #	Number of the test. There are three possible tests, 1, 2 and 3.	Fixed
Output	Indicates phase voltage for which level and phase is to be applied. For each test number, the test will be repeated three time using the following phase rotations: ABC, BCA, CAB	Fixed
% of Unom	Indicates voltage level to change to in % of nominal voltage.	50 to 150
Angle	Phase angle to shift to for each test number and phase in degrees.	0 to 360
Ku2	Unbalance factor. This value is shown for reference only and is based on the test levels and phase shifts. It is not directly used to program the AC source.	
Time (s)	Time in seconds to hold the unbalance condition	0.0 to 9999

These parameters can be entered on screen by the operator or loaded from disk. To load a new test or test class, select the File, Open menu. The default location for IEC test files is:

C:\Program Files\California Instruments\MXGUI\IEC\_Test. The following four EN 61000-4-27 test files are distributed with the MXGUI program:

File Name	Test Class
Class2.427	2
Class3.427	3
ClassX.427	X

The user may create as many test files as desired using the data entry grid. Changes made can be saved using the File, Save As... menu entry.

### 11.5 Waveform Display Tab

This tab displays the three phase output voltage waveforms and their respective phase angles. Each phase is shown in a different color. This waveform capture is started 10 msec prior to each voltage and phase change and covers a period of about 100 msec. The last unbalance data display is incorporated in the test report.

### 11.6 Operator Observations Tab

This tab may be used to enter any comments concerning the EUT behavior. Any text entered on this page will become part of the test report. Note that this information is not saved anywhere other than as part of the test report.

### 11.7 Source Regulation

The voltage regulation of the AC Source is always verified. The voltage regulation check verifies AC source voltage regulation at the beginning of each test under load as called out in the test standard. The voltage regulation must be less than 2 %. The measured output voltage must be within the source regulation limits specific in the EN 61000-4-27 standard. If the source regulation check fails, check the system connections. For higher power loads, make sure the external sense lines are used to sense the voltage at the EUT terminals.

### 11.8 Test execution

The selected test mode can be started by pulling down the Run menu and selecting All or by clicking on the Start button. During test execution, no changes to test parameters are allowed. The test progress can be monitored at the bottom of the window in the status bar.

Note that the default phase rotation of the MX Series AC power systems is A = 0, B = 240 and C = 120 (counter clock wise). For the IEC 61000-4-27, the phase rotation must be set to A = 0, B = 120 and C = 240. This is best done with the power to the EUT off. If the test is started and the MX phase rotation is not A = 0, B = 120 and C = 240, a warning will appear prompting the operator to confirm the change in phase rotation. Selecting No will abort the test with no change to the source output. Selecting Yes will result in the phase rotation being changed before the test starts. If the phase rotation is already correct, no message appears.

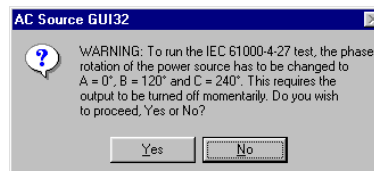

## 11.9 Test Implementation and Test Sequence

For each test step, the specified voltage and phase angles will be applied for the time specified. At the onset of each voltage/phase step, the source voltage is captured by the power source's data acquisition system. Once the specified time has elapsed, the voltage and phase angles are set back to their nominal values and the captured waveform data is transferred and displayed. This data will be visible until the next step when it is updated. Each step (number) will be applied for a different phase rotation in the sequences shown below. This means the operator does not have to reconnect the EUT three times using a different phase connected at each test number.

The phase rotations used are as follows:

Sequence			
First	Ua to L1	Ub to L2	Uc to L3
Second	Ua to L2	Ub to L3	Uc to L1
Third	Ua to L3	Ub to L1	Uc to L2

The test numbers executed are determined by the test selection in the main setup screen. Any combination of test number 1, 2 and 3 may be selected by placing a check mark in the appropriate box.

## 11.10 Test Reports

The IEC 61000-4-27 test module produces a test report when the Print Report button is clicked or the File, Print menu is selected. Test reports include all selected test parameters and options. Note that IEC reports can be generated using one of three alternative methods. See the [options](#) menu for details. The IEC 61000-4-27 report generator supports direct printer output or output to a MS Word document. The waveform display that is included in the report is the one that was captured at the last unbalance applied to the EUT.

## 12. EN 61000-4-28 Frequency Variations Immunity Testing

### 12.1 About This Chapter

This chapter covers testing a device for compliance with the EN 61000-4-28 Frequency Variations test standard. This test is supported through the MXGUI AC source control program.

The EN61000-4-28 implementation in the MXGUI is based on the EN61000-4-28 standard dated 1999-11 and Amendment 1, dated 2001-07. Test levels and durations can be changed if needed through use of one or more *filename.428\_Vars* files in the IEC\_Test directory.

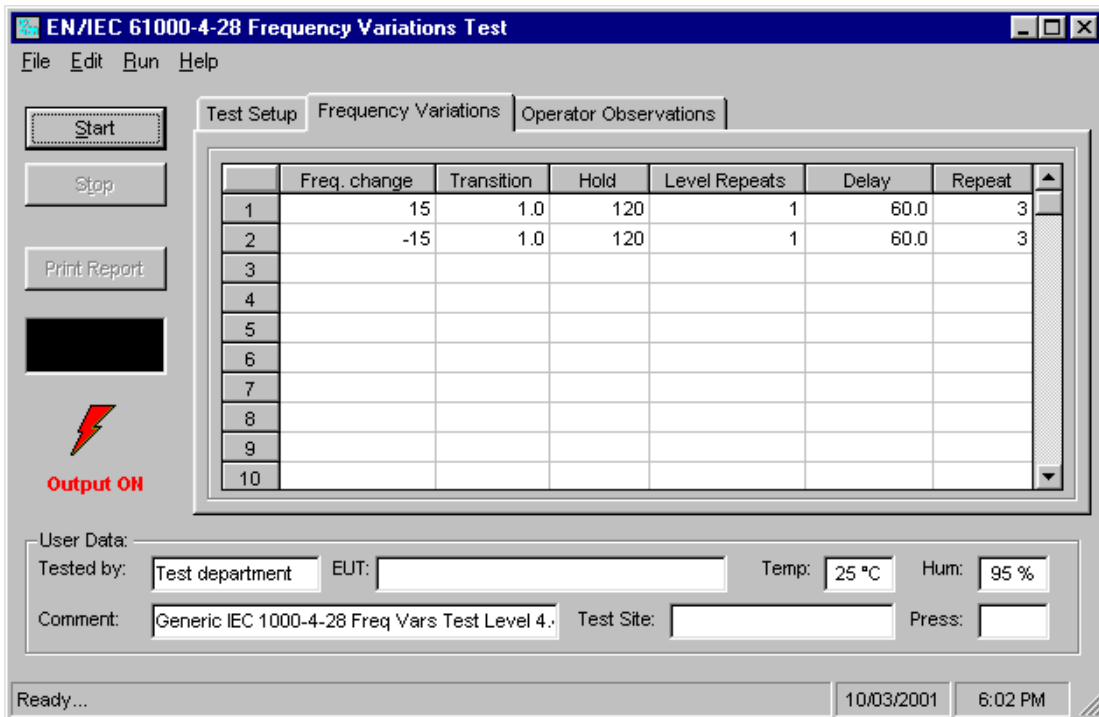

Figure 12-1: EN 61000-4-28 Test Window

## 12.2 Test Setup

The following parameters and controls are available for executing the EN 61000-4-28 test:

Control / Field	Description
Nominal voltage	Opening this window will set this parameter to the present steady state voltage setting of the AC source. If required, a new value can be entered for use during the test. At the end of the test, the AC source will remain at this voltage level. If needed, the program will switch the AC source to the high voltage range and close the output relay when the test is started.
Nominal frequency	Opening this window will set this parameter to the present steady state frequency setting of the AC source. If required, a new value can be entered for use during the test. At the end of the test, the AC source will remain at this frequency.
Source Regulation	See under Test Options below
EUT Class	The test levels used are determined by the EUT class. Class selection is done by loading the correct class file from disk.
Phase Mode	Note that there is no Phase selection in this test as the programmed frequency always applies to all available phases.
Start	Starts the EN 61000-4-28 test using the parameters set by the user. Test progress is shown at the bottom of the window. The sequence numbers shown correspond to those in the illustration.
Stop	Aborts test in progress.



### 12.3 Test Sequence

The test sequence implemented by this test consists of a series of frequency variations consistent with commonly found phenomena on the public utility power grid. The objective of this test is to evaluate a product for immunity from such variations.

Frequency variations are applied at different levels for different product categories. The user must determine the product class and select the appropriate test level. During the test run, frequency changes are applied at the zero degree phase angle of the waveform. Both up and down shifts of the frequency are performed. Test levels and test times are displayed in the test parameter data entry grid. The various columns in the test data setup are shown in the figure below. In this example, the following parameters were specified in the data entry grid:

Freq. Change	Transition	Hold	Level Repeat	Delay	Repeat
-15	1	120	2	60	3

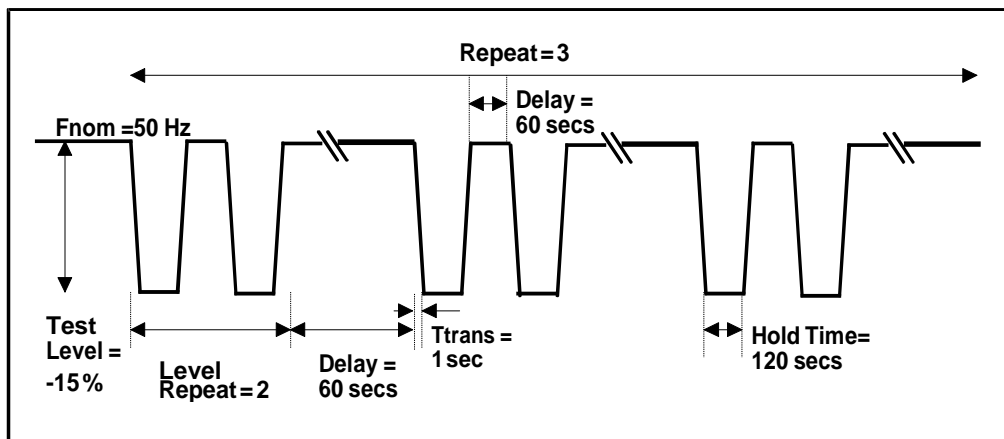

Figure 12-2: EN 61000-4-28 Test Sequence

These parameters can be entered on screen by the operator or loaded from disk. To load a new test or test class, select the File, Open menu. The default location for IEC test files is:

C:\Program Files\California Instruments\Mxgui\IEC\_Test

The following four EN 61000-4-28 test files are distributed with the MXGUI program:

File Name	Test Class
Generic IEC 1000-4-28 Freq Vars Test Level 2.428_Vars	Level 2
Generic IEC 1000-4-28 Freq Vars Test Level 3.428_Vars	Level 3
Generic IEC 1000-4-28 Freq Vars Test Level 4.428_Vars	Level 4

The user may create as many test files as desired using the data entry grid. Changes made can be saved using the File, Save As... menu entry.

### 12.4 Test Levels

In Annex B of the draft standard, the EUT operating environment classifications are defined based on IEC 1000-2-4. The classifications are as follows:

Class	Environment
<b>Class 1</b>	Applies to protected supplies with compatibility levels lower than public network levels. It relates to the use of equipment, which is very sensitive to disturbances in the power supply, for instance the instrumentation of technological laboratories, some automation and protection equipment, some computers etc. This equipment is normally supplied by protected supplies such as uninterruptible power supplies, filters or surge suppressors.
<b>Class 2</b>	Applies to points of common coupling (PCCs for consumer systems) and in-plant points of common coupling (IPCs) in the industrial environment in general. The compatibility levels in this class are identical to those of public networks.
<b>Class 3</b>	Applies only to IPCs in industrial environments. It has higher compatibility levels than those of class 2 for some disturbance phenomena. This class should be considered when any of the following conditions are met: - a major part of the load is fed through converters - welding machines are present - large motors are frequently started - loads vary rapidly

Testing is not recommended for Class 1 equipment. Test level X specifications are to be agreed upon by the manufacturer and user. Test Levels 2, 3 and 4 defined in the standard are applied to environmental Class 2 and 3 equipment. Test Level 3 is defined for interconnected networks and Level 4 for non-interconnected networks (islands for example) where the frequency variations can be much higher. The following table summarizes the EMC classes and test level relationships.

Test Level	Environment classification	Frequency Variation
Level 1	Class 1	No test required
Level 2	Class 2	± 3 % of Fnom
Level 3	Class 3 and 4 used in interconnected networks	+ 4 % and - 6 % of Fnom
Level 4	Class 3 and 4 used in non-interconnected networks	± 15 % of Fnom
Level X	Product class specific	Open but must be higher than test level 2.

### 12.5 Test Options

The voltage regulation of the AC Source can be verified by selecting the "Include Source Regulation Check" check box. This will cause the AC load to measure its output using the built in measurement system at all the frequency extremes that will be applied to the EUT during the test. The measured output voltage must be within the source regulation limits specific in the EN 61000-4-28 standard. If so, a PASS indication will be shown in green to the right of the option box. If not, a FAIL indication will be shown in red. If the source regulation check fails, check the system connections. For higher power loads, make sure the external sense lines are used to sense the voltage at the EUT terminals.

Tests are started using the Start button or the Run, All menu.

## 12.6 Test Results

There is no way for the MXGUI to determine the outcome of this test as a clear definition of a failure can not be given. The draft standard called out the following possible test results:

*“The test results shall be classified on the basis of the operating conditions and functional specifications of the equipment under test, as in the following, unless different specifications are given by product committees or product specifications.*

- a) *Normal performance within limits specified by the manufacturer, requestor or purchaser*
- b) *Temporary loss of function or degradation of performance which ceases after the disturbance ceases, and from which the equipment under test recovers its normal performance, without operator intervention*
- c) *Temporary loss of function or degradation of performance, the correction of which requires operator intervention*
- d) *Loss of function or degradation of performance which is not recoverable, owing to damage to hardware or software, or loss of data.*

*As a general rule, the test result is positive if the equipment shows its immunity, for the duration of the application of the test, and at the end of the tests the EUT fulfills the functional requirements established in the technical specification.”*

The user has to make this determination by observing the under test. At the end of a test run, the following dialog box is displayed. Click on the Help button to display the pass/fail shown above.

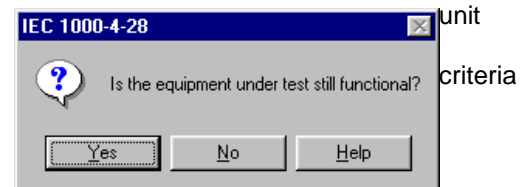

## 12.7 Test Reports

The EN 61000-4-28 test module produces a test report when the Print Report button is clicked. Reports can also be printed from the File, Print menu. Test reports include all selected test parameters and options. A sample test report is shown below. The report format used can be direct output to a printer, output to a text file or generation of an MS Word report. The desired report format can be selected from the Options menu, under IEC Report Setup. MS Word reports are automatically saved in the C:\Program Files\California Instruments\MXGUI\Reports directory.

13. EN 61000-4-29p DC Dips and Interruptions Immunity Test (Pre-compliance)

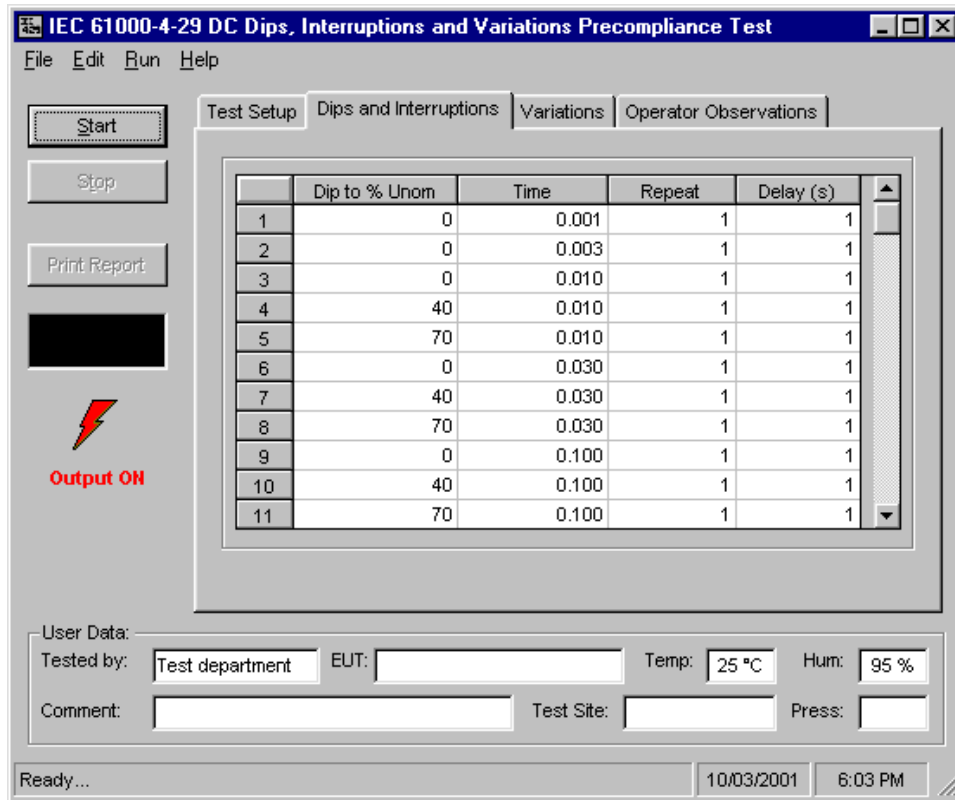

Figure 13-1: EN 61000-4-29 Test Window

The EN 61000-4-29 implementation in the MXGUI is based on the EN 61000-4-29 standard dated march 24, 2000. **This test is offered as a pre-compliance level test only.** Not all the DC supply rise and fall time and maximum current requirements can be meet under all conditions. (See paragraph 13.8 for details.) Test parameters can be changed if needed using the parameter data entry grid. Several generic test parameter files are distributed with the MXGUI program. These files can be edited as well. EN 61000-4-29 Test setup parameter files use a ".429" extension. More than one .429 file may reside in the IEC\_Test directory or any other directory. The operator may select the one to run from the File, Open dialog.

### 13.1 Test Setup

The following parameters and controls are available for executing the EN 61000-4-29 test:

Parameter / Control	Description
Nominal DC voltage	Opening this window will set the upper voltage range parameter to the present steady state voltage setting of the DC supply. If required, a new value can be entered for use during the test. At the end of the test, the DC Supply will remain at this voltage level. The upper voltage range value entered cannot exceed the selected voltage range. Note that DC voltage variations to levels above 100 % of Unom may require selection of the high voltage range. The lower voltage range must be set to the lowest EUT rated Vdc. If the EUT voltage range is less than 20 % of its low range value, a single Vdc level may be used.
Sequence	Available sequences for selection are:  Voltage Dips and Interruptions  Voltage Variations.  Either one or both sequences can be selected for execution.
Output Select	The output selection is shown to the left. If a 3 phase AC/DC power source model is used, this field allows selection of output channel A, B, C or all three channels (outputs). The same test sequence is applied to all selected outputs. For single phase power systems, this field defaults to channel A.
Start	Starts the EN 61000-4-29 test using the parameters set by the user. Test progress is shown at the bottom of the window.
Abort	Aborts test in progress.

The required EN 61000-4-29 test parameters must be entered in the test data entry grid before running a test. Previously stored test files can be loaded from the File, Open menu. Test files use a .429 file extension and only files with this extension can be loaded.

The MXGUI is distributed with pre-defined test parameter files for the generic EN 61000-4-29 test sequences. Additional test parameter files e.g. for specific product categories, can be created by the user by editing the data entry grid and saving the new data under a user-specified name. The following parameters and controls are available for executing the EN 61000-4-29 test:

Field / Control	Description
Nominal DC voltage	Opening this window will set the upper voltage range parameter to the present steady state voltage setting of the DC supply. If required, a new value can be entered for use during the test. At the end of the test, the DC Supply will remain at this voltage level. The upper voltage range value entered cannot exceed the selected voltage range. Note that DC voltage variations to levels above 100 % of Unom may require selection of the high voltage range. The lower voltage range must be set to the lowest EUT rated Vdc. If the EUT voltage range is less than 20 % of its low range value, a single Vdc level may be used. If the user selects only one of the two DC levels and the delta between them exceeds 20 % of the low DC range, a warning message will appear notifying the user of this condition. As a rule, both voltage must be selected for testing when this prompt appears.
Sequence Select	Available sequences for selection are:  Voltage Dips and Interruptions

Field / Control	Description
	Voltage Variations. Either one or both sequences can be selected for execution.
Output Select	The output selection is shown to the left. If a 3 phase AC/DC power source model is used, this field allows selection of output channel A, B, C or all three channels (outputs). The same test sequence is applied to all selected outputs. For single phase power systems, this field defaults to channel A.
Start	Starts the EN 61000-4-29 test using the parameters set by the user. Test progress is shown at the bottom of the window.
Abort	Aborts test in progress.

### 13.2 Setting nominal values

The EN 61000-4-29 test requires setting of the rated nominal DC voltage of the EUT. The nominal values must be entered in the Test Setup Nom. Vdc data field before starting a test. When the EN 61000-4 test window is first opened, the present DC voltage setting is automatically loaded as the nominal Vdc value. This value is overridden by selecting each data entry field and typing in a new value or by loading a test file from the File, Open menu. Thus, test data files also contain the nominal Vdc voltage to be used.

### 13.3 Test sequence

The test sequence implemented by this test consists of a series of DC voltage dips (to less than DC nominal) or interruptions (dip to zero volt). It is also possible to select voltage variations which cause the DC voltage to change at a programmed rate to a specified level and then return at the same or a different rate to the nominal DC level. The objective of this test is to evaluate a product for immunity from such dips, interruptions and variations.

These dips and variations can be applied at different levels and durations for different product categories. The user must determine the product class and select the appropriate test file. The selected levels and durations are visible on screen and can be edited and saved to a new setup file if needed. This allows a library of test files for specific product categories to be created. The .429 file loaded determines the test levels and DC nominal values used. It can also contain information on the EUT and operator. The maximum number of steps that can be defined is 100 for both Dips/Interruptions and Variations.

These parameters can be entered on screen by the operator or loaded from disk. To load a new test or test class, select the File, Open menu. The default location for IEC test files is:

C:\Program Files\California Instruments\MXGUI\IEC\_Test. The following duplicate sets of EN 61000-4-29 test files are distributed with the MXGUI program:

For PC's using US Windows Settings (period as decimal separator), use the following files:
Generic IEC 1000-4-29 Voltage Variations.429
Generic IEC 1000-4-29 Voltage Dips.429
Generic IEC 1000-4-29 Voltage Dips Ints and Vars.429
Generic IEC 1000-4-29 Voltage Dips and Interruptions.429
Generic IEC 1000-4-29 Short Interruptions.429

For PC's using European Windows Settings (comma as decimal separator), use the following files:
Euro Generic IEC 1000-4-29 Voltage Variations.429
Euro Generic IEC 1000-4-29 Voltage Dips.429
Euro Generic IEC 1000-4-29 Voltage Dips Ints and Vars.429
Euro Generic IEC 1000-4-29 Voltage Dips and Interruptions.429
Euro Generic IEC 1000-4-29 Short Interruptions.429

The user may create as many test files as desired using the data entry grid. Changes made can be saved using the File, Save As... menu entry.

## 13.4 Test Options

### Nominal Voltage Mode

The EN 61000-4-29 test standard allows testing at a single nominal Vdc value if the voltage range of the EUT is less than 20 % of the low range value. Thus, if an EUT has a nominal input range from 100 to 110 Vdc, the range is 10 V which is only 10 % of the low range value ( $10/100 = 10\%$ ). In this case, either the upper or lower limit value or a value in between may be used to test the EUT. If the range exceeds 20 %, the test has to be performed at both upper and lower range settings. The MXGUI will allow the operator to select single value testing but will prompt a warning if the values entered represent a greater than 20 % range.

### Pre-Test Delay

For both Dips/Interruptions and Variations runs, it is possible to specify a pre-test delay. This is a period expressed in seconds during which the Vdc nominal value will be applied to the EUT before the actual test sequence starts.

## 13.5 Test Execution

The selected test mode can be started by pulling down the Run menu and selecting All or by clicking on the Start button. During test execution, no changes to test parameters are allowed. The test progress can be monitored at the bottom of the window in the status bar. The progress through each sequence can be monitored as well as each test step currently executing is highlighted.

## 13.6 Test Results

There is no way for the MXGUI to determine the outcome of this test as a clear definition of a failure can not be given. The draft standard called out the following possible test results:

*“The test results shall be classified on the basis of the operating conditions and functional specifications of the equipment under test, as in the following, unless different specifications are given by product committees or product specifications.*

- a) Normal performance within the specification limits*
- b) Temporary degradation or loss of function or performance which is self-recoverable.*
- c) Temporary degradation or loss of function or performance which requires operator intervention or system reset.*
- d) Degradation or loss of function which is not recoverable due to damage of equipment (components) or software, or loss of data.*

*As a general rule, the test result is positive if the equipment shows its immunity, for the duration of the application of the test, and at the end of the tests the EUT fulfills the functional requirements established in the technical specification.”*

The user has to make this determination by observing the unit under test. At the end of the test, the GUI will pop up a dialog box asking the operator to assess the state of the EUT. If the EUT is still functional, the operator may answer Yes when prompted. If not, he should answer no. The response to this query is incorporated as a PASS or FAIL result in the test report.

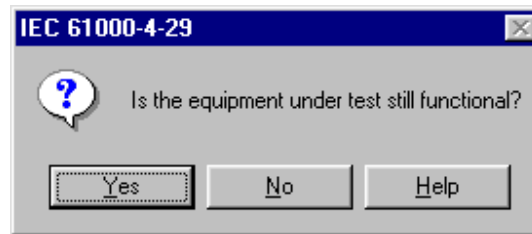

### 13.7 EN 61000-4-29 Test Reports

At the end of a test run, the operator can generate a test report by clicking on the "Print report" button. EN 61000-4-29 test reports include all test setup information and test results. User provided information at the bottom of the 4-29 screen is included as well.

The report format and test report headers can be selected from the Option, IEC Test Report menu but needs to be done before opening the IEC 429 test screen. The selected format (Printer, Text File or MS Word) applies to all IEC immunity tests. MS Word reports are automatically saved in the C:\Program Files\California Instruments\Mxgui\Reports directory.



### 13.8 Source Requirements

The EN 61000-4-29 imposes certain requirements on the DC test generator used. Not all of these requirements can be met with the MX Series AC/DC power source. The following restrictions apply:

Capability	Standard Requirement	MX Series
Output voltage range	0 - 360 Vdc	0 - 400 Vdc
Output voltage variations under load	< 5 %	< 1 %
Ripple content	< 1 % of output voltage	< 1 V rms
Rise and fall time into 100 Ohm resistive load	between 1 and 50 usec	0.3 V/usec
Over/undershoot into 100 Ohm resistive load	< 10 %	< 2 %
Output current, steady state	up to 25 A	25 A

**Note:** The use of a test generator with higher or lower voltage or current capability is allowed provided that the other specifications are preserved. The test generator steady state power/current capability shall be at least 20 % greater than the EUT power/current ratings.

This means that for many EUT's a 25 A capable generator is not needed. However, since the rise and fall time requirements may not be met under all circumstances, this is a pre-compliance test only.

For full compliance test applications, the test generator must be tested for compliance with the test generator requirements.

## 14. Customizing EN 61000-4-13 Test Parameters

### 14.1 About This Chapter

This chapter describes how to modify aspects of EN61000-4 immunity testing to accommodate different product committee requirements.

The available 61000-4 tests implemented in the MXGUI program are based on the most recent officially published test standard. Future changes in test levels can be accommodated without the need to upgrade the MXGUI program. To allow for some level of customization, the MXGUI will accept different test parameters that can be edited by the user.

#### 14.1.1 IEC413.413 File

[IEC-1000-4-13]	EN 61000-4-13 section header
Fcurv_lev = 90	<i>Parameters that apply only to Flat Top Curve</i> Flat Curve Level at 90%
Fcurv_dwe = 120	Flat Curve Dwell time in seconds
Fcurv_pau = 5	Flat Curve Pause in seconds
Oswcurv_dwe = 120	<i>Parameters that apply only to Over Swing Curve</i> Over Swing Curve Dwell time in seconds
Oswcurv_pau = 5	Over Swing Curve Pause in seconds
Oswcurv3_lev = 6	Over Swing Curve of third harmonic level at 6%
Oswcurv3_phs = 180	Over Swing Curve of third harmonic phase test of 180 degrees
Oswcurv5_lev = 4	Over Swing Curve of fifth harmonic level at 4%
Oswcurv5_phs = 0	Over Swing Curve of fifth harmonic phase test of 0 degree
Swefreq1_lev = 3	<i>Parameters that apply to Frequency Sweep</i> Sweep Frequency Level of first range at 3%
Swefreq2_lev = 10	Sweep Frequency Level of second range at 10%
Swefreq3_lev = 5	Sweep Frequency Level of third range at 5%
Swefreq4_lev = 5	Sweep Frequency Level of fourth range at 5%
Swefreq5_lev = 2	Sweep Frequency Level of fifth range at 2%
Swefreq_dwe = 300	Sweep Frequency Dwell time in seconds
Swefreq1_stp = 5	Sweep Frequency Step size of first range in Hz
Swefreq2_stp = 10	Sweep Frequency Step size of second range in Hz
Swefreq3_stp = 10	Sweep Frequency Step size of third range in Hz
Swefreq4_stp = 10	Sweep Frequency Step size of fourth range in Hz
Swefreq5_stp = 25	Sweep Frequency Step size of fifth range in Hz
Indharm2_lev = 3	<i>Parameters that apply only to Individual Harmonics</i> Individual harmonics Level for nth (second) harmonic in %
Indharm2_phs = 0	Individual harmonics Phase for nth (second) harmonic in degree
Indharm_dwe = 5	Individual harmonics Dwell time in second
Indharm_pau = 5	Individual harmonics Pause in second
Meisterfreqx_lev=4	<i>Parameters that apply only to the Meister Curve</i> Harmonic level for meister curve where x = 1 through 5
Meisterfreqx_stp=4	Frequency step size for meister curve where x = 1 through 5
Meisterfreqx_dwe=4	Meister curve harmonics Dwell time in second
Meisterfreqx_pau=4	Meister curve harmonics Pause in second
Interharm1_lev = 2.5	<i>Parameters that apply only to Interharmonics</i> Interharmonics Level for first range at 2.5%
Interharm2_lev = 5	Interharmonics Level for second range at 5%
Interharm3_lev = 3.5	Interharmonics Level for third range at 3.5%
Interharm4_lev = 2	Interharmonics Level for fourth range at 2%
Interharm5_lev = 1.5	Interharmonics Level for fifth range at 1.5%
Interharm_dwe = 5	Interharmonics Dwell time in second
Interharm_pau = 1	Interharmonics Pause in second

## 14.2 Sample File IEC413.413

Following is a listing of the default IEC411.413 file shipped with the MXGUI program. If for some reason your 413 file is lost or you would like to restore it to its original condition, use the values shown here.

```
[IEC-1000-4-13 / Class 2]
[Flat Curve test]
FCURV_LEV=90
FCURV_DWE=120
FCURV_PAU=5
[Over Swing Curve test]
OSWCURV_DWE=120
OSWCURV_PAU=5
OSWCURV3_LEV=6
OSWCURV3_PHS=180
OSWCURV5_LEV=4
OSWCURV5_PHS=0
[Sweep Frequency test]
SWEFREQ1_LEV=3
SWEFREQ2_LEV=10
SWEFREQ3_LEV=5
SWEFREQ4_LEV=5
SWEFREQ5_LEV=2
SWEFREQ_DWE=300
SWEFREQ1_STP=5
SWEFREQ2_STP=10
SWEFREQ3_STP=10
SWEFREQ4_STP=10
SWEFREQ5_STP=25
[Meister Curve test]
MEISTERFREQ1_LEV=4
MEISTERFREQ1_STP=5
MEISTERFREQ2_LEV=10
MEISTERFREQ2_STP=10
MEISTERFREQ3_LEV=4500
MEISTERFREQ3_STP=10
MEISTERFREQ4_LEV=4500
MEISTERFREQ4_STP=10
MEISTERFREQ5_LEV=4500
MEISTERFREQ5_STP=25
MEISTERFREQ_DWE=10
MEISTERFREQ_PAU=0
[Individual Harmonic test]
INDHARM2_LEV=3
INDHARM2_PHS=0
INDHARM3_LEV=8
INDHARM3_PHS=0
INDHARM4_LEV=1.5
INDHARM4_PHS=No test
INDHARM5_LEV=9
INDHARM5_PHS=0
INDHARM6_LEV=No test
INDHARM6_PHS=No test
INDHARM7_LEV=7.5
INDHARM7_PHS=0
INDHARM8_LEV=No test
INDHARM8_PHS=No test
INDHARM9_LEV=2.5
INDHARM9_PHS=No test
INDHARM10_LEV=No test
INDHARM10_PHS=No test
INDHARM11_LEV=5
INDHARM11_PHS=No test
INDHARM12_LEV=No test
INDHARM12_PHS=No test
INDHARM13_LEV=4.5
INDHARM13_PHS=No test
INDHARM14_LEV=No test
INDHARM14_PHS=No test
INDHARM15_LEV=No test
INDHARM15_PHS=No test
INDHARM16_LEV=No test
INDHARM16_PHS=No test
INDHARM17_LEV=3
INDHARM17_PHS=No test
INDHARM18_LEV=No test
INDHARM18_PHS=No test
INDHARM19_LEV=2
INDHARM19_PHS=No test
INDHARM20_LEV=No test
INDHARM20_PHS=No test
INDHARM21_LEV=No test
INDHARM21_PHS=No test
INDHARM22_LEV=No test
INDHARM22_PHS=No test
INDHARM23_LEV=2
INDHARM23_PHS=No test
INDHARM24_LEV=No test
INDHARM24_PHS=No test
INDHARM25_LEV=2
INDHARM25_PHS=No test
INDHARM26_LEV=No test
INDHARM26_PHS=No test
INDHARM27_LEV=No test
INDHARM27_PHS=No test
INDHARM28_LEV=No test
INDHARM28_PHS=No test
INDHARM29_LEV=1.5
INDHARM29_PHS=No test
INDHARM30_LEV=No test
INDHARM30_PHS=No test
INDHARM31_LEV=1.5
INDHARM31_PHS=No test
INDHARM32_LEV=No test
INDHARM32_PHS=No test
INDHARM33_LEV=No test
INDHARM33_PHS=No test
INDHARM34_LEV=No test
INDHARM34_PHS=No test
INDHARM35_LEV=1.5
INDHARM35_PHS=No test
INDHARM36_LEV=No test
INDHARM36_PHS=No test
INDHARM37_LEV=1.5
INDHARM37_PHS=No test
INDHARM38_LEV=No test
INDHARM38_PHS=No test
INDHARM39_LEV=No test
INDHARM39_PHS=No test
INDHARM40_LEV=No test
INDHARM40_PHS=No test
INDHARM_DWE=5
INDHARM_PAU=1
[Interharmonics test]
INTERHARM1_LEV=2.5
INTERHARM2_LEV=5
INTERHARM3_LEV=3.5
```

INTERHARM4\_LEV=2  
INTERHARM5\_LEV=1.5  
INTERHARM\_DWE=5

INTERHARM\_PAU=1

## 15. Specifications

### 15.1 About This Chapter

This chapter provides the technical specifications of the MXCTS measurement system and the Power Analysis and Conditioning System unit (PACS-3-75). If the CTS system you have includes an AC power source, refer to the separate AC source user manual that shipped with the AC source.

Note: All specifications listed in the manual are valid at an ambient temperature of  $23^{\circ} \pm 5^{\circ}$  and apply after a 15-minute warm-up period.

### 15.2 PACS-3-75 Measurement Specifications

The MXCTS measurement system is implemented using a high speed Analog to Digital PCI plug in board. This board needs to be installed properly in order to function according to the specification listed here.

Measurement		Specification	Unit
<b>Bandwidth</b>			
	Anti Aliasing	> 60 dB at 5 KHz	
	Band pass ripple	< 2 % up to 2.5 KHz	%
<b>Volts</b>			
	Range	0.01 - 312.00	V <sub>rms</sub>
	Max. input	1000	V <sub>peak</sub>
	Max. crest factor	5:1	
	Accuracy	$\pm 0.1 \% \pm 0.05 \% \text{ FS} \pm 3 \text{ mV}$	mV
	Resolution	10	mV
	Voltage CMRR	80	dB
<b>RMS Current</b>			
	Current ranges (Auto ranging)	16, 40, 75	A <sub>rms</sub>
	Highest range	75.00	A <sub>rms</sub>
	Max. input [permanent, no damage if < 200 A <sub>peak</sub> ] PACS-3-75	75.00	A <sub>rms</sub>
	Max. Crest Factor at max current [75 A Range]	2.5:1	
	Max. Crest Factor [Low Range]	20:1	
	Accuracy	$\pm 0.1 \% \pm 0.05 \% \text{ FS} \pm 5 \text{ mA}$	mA
	Resolution	1	mA

Measurement		Specification	Unit
<b>Power</b>			
	Range PACS-3-75	0.1 - 45,000	W/ph
	Accuracy	$\pm 0.25\% \pm 0.25\% \text{ FS} \pm 20\text{mW}$	mW
	Resolution	0.1	W
<b>Apparent Power</b>			
	Range PACS-3-75	0.01 - 45,000	VA/ph
	Accuracy	$\pm 0.15\% \pm 0.15\% \text{ FS} \pm 20$	mVA
	Resolution	0.01	VA
<b>Power Factor</b>			
	Range	0.00 - $\pm 1.00$	
	Accuracy	$\pm 0.05$	
	Resolution	0.01	
<b>Crest Factor</b>			
	Range	20:1	
	Accuracy	$\pm 0.005$	
	Resolution	0.001	
<b>Frequency</b>			
	Range	45 - 65	Hz
	Accuracy	0.1 % of reading	Hz
	Resolution	0.1	Hz
<b>Harmonic Analysis</b>			
	Range	Fundamental to 40 <sup>th</sup>	
	Accuracy Fundamental	$\pm 0.05\% \text{ FS} \pm 0.05\%/\text{kHz}$	
	Accuracy Harmonics	$\pm 0.1\% \pm 0.1\%/\text{kHz}$	
	Measurement window	10 or 12 periods	
	Smoothing filter	1.5	sec
<b>Flicker</b>			
	Pst	Range	0.1 - 10
		Accuracy	3
		Resolution	0.01
		Integration time	10
	Plt	Range	0.1 - 10
	d <sub>max</sub>	Range	0 - 100
	d <sub>c</sub>	Range	0.1 - 100
	d <sub>t</sub>	Range	0.1 - 100
	d <sub>t</sub> over3%(4%)	Range	0 - 1000
			ms

### 15.3 PACS-3-75 General Specifications

The PACS-3-75 unit creates the mechanical and electrical interface between the AC source, the EUT and the PC. It provides the necessary isolation and signal conditioning to perform the measurements needed.

PACS Model:		PACS-3-75
Number of phases		3
Channels	Voltage and Current	6
Connector Style	Front panel	none
	Rear panel	terminal block
Maximum Voltage	L- L	540 Vac
	L – N	312 Vac
Maximum Current	Front panel	75A rms/phase
Input Voltage	Rear panel IEC320	115V / 230V Nominal $\pm$ 10%
Input Frequency		50 / 60Hz
Input Current		less than 0.6A (115v) less than 0.3A (230v)
Dimensions	HxWxD (inch)	3.5 x 16.8 x 22
	HxWxD (mm).	89 x 427 x 560
Weight	Lbs / kg.	12 / 5.4



**Voltage Range:** The input voltage range is 0 to 312V rms L-N.  
The 1-phase or 3-phase voltage is applied to input terminal block TB4.



**Current Range:** The max. input current is 75 A rms.



**Frequency** may not be 50Hz depending on power source used and application.

**15.4 PACS-3-75 Environmental**

Parameter	Specification
Operating Temp:	0 degrees to +40 degrees Celsius.
Storage Temp:	0 degrees to +70 degrees Celsius.
Humidity:	
Operating:.	≤90% RH up to 40° C
Storage:	≤90% RH up to 40° C, ≤75% RH up to 70° C.
Insulation:	Rated to Installation Category (Over voltage Category) II
Vibration:	Designed to meet NSTA 1A transportation levels.
Shock:	Designed to meet NSTA 1A transportation levels.

**15.5 PACS-3-75 Regulatory**

Parameter	Specification
Electromagnetic Emissions and Immunity:	Designed to meet EN50081-1 and EN50082-1 European Emissions and Immunity standards as required for the “CE” mark.
Acoustic Noise:	60 dBA maximum. (@ 1 meter)
Safety:	Designed to meet EN61010-1 European safety standards as required for the “CE” mark.



### 15.6 Flicker Reference Impedances

Flicker measurements require the use of a reference impedance according to IEC 725. Since this reference impedance has to be matched to the output of the AC source used, a reference impedance matched to the MX must be used.

For MXCTSL systems, the OMNI-3-37MX is required. For MXCTSL systems, the OMNI-3-37MX is recommended. For MXCTSHL systems, both OMNI's may be used although only one can be controlled from the CTSMXH or CTSMXL software while the other must be operated in manual mode from it's front panel.

Note that if only an OMNI-3-75 is present in a system running the CTSMXL software, the MX30 or MX45 programmable impedance must be manually set during flicker testing to adjust the test impedance for IEC 61000-3-3 flicker testing. This can be done from the MX front panel before the START button is pressed. Only the resistive portion needs to be adjusted.

Refer to the MX-CTSH User Manual (P/N 7003-972) for OMNI-3-75 specifications.

Model	Phases	Flicker Impedance
OMNI-3-37MX	3	0.24 + 0.15j Phase 0.16 + 0.10j Neutral
OMNI-3-75	3	0.15 + 0.15j Phase 0.10 + 0.10j Neutral

### 15.7 OMNI-3-37MX Specifications

The MXCTS systems based on the MX Series and require the use of an external reference impedance. The OMNI-3-37MX is not directly controlled by the CTSMXL Software as this capability is reserved for the OMNI-3-75. To switch the OMNI-3-37MX from bypass to flicker depending on what test is being run, use the front panel control button.

Reference Impedance	
Phases	3
Flicker Mode:	
Max. Current	37 A
Useable range	2.0 – 37 A
Bypass Mode:	
Max. Current	75.0 A
Impedance @ 50 Hz in Flicker Mode:	
Phase	0.24 + j0.15 Ω
Neutral	0.16 + j0.10 Ω
Accuracy	< 5 %
Controls and Indicators	
	Flicker On/Off push button
	Power Led
	Bypass mode Led
	Flicker mode Led

Line Input		
Line Voltage	115 Vac±10% / 230 Vac±10%	
Line Current	200 mA @ 115 Vac / 60 Hz 110 mA @ 230 Vac / 50 Hz	
Line Frequency	47-63 Hz	
Fuse Rating	0.25 A slow acting @ 115 Vac 0.125 A slow acting @ 230 Vac	
Mechanical		
Dimensions		
Including base	HxWxD (inch)	5.25" x 19" x 22"
	HxWxD (mm).	133 x 480 x 560
Weight	Lbs / kg	55 lbs / 25 Kg
Chassis Slides	General Devices C300S-118-U/B308 BK	

15.8 OMNI-3-37MX Environmental

Parameter	Specification
Operating Temp:	0 degrees to +40 degrees Celsius.
Protection:	OMNI will dis-engage if internal heat sink temperature exceeds 95° C. Re-engages once temperatures declines below threshold.
Storage Temp:	0 degrees to +70 degrees Celsius.
Humidity:	
Operating:.	≤90% RH up to 40° C
Storage:	≤90% RH up to 40° C, ≤75% RH up to 70° C.
Creepage and Clearance:	Rated for Pollution Degree 2.
Insulation:	Rated to Installation Category (Over voltage Category) II
Vibration:	Designed to meet NSTA 1A transportation levels.
Shock:	Designed to meet NSTA 1A transportation levels.

15.9 OMNI-3-37MX Regulatory

Parameter	Specification
Electromagnetic Emissions and Immunity:	Designed to meet EN50081-1 and EN50082-1 European Emissions and Immunity standards as required for the "CE" mark.
Acoustic Noise:	65 dBA maximum. (@ 1 meter)
Safety:	Designed to meet EN61010-1 European safety standards as required for the "CE" mark.

## 16. Configuration Options

---

### 16.1 About this Chapter

The CTSMXL software allows many parameters and operational characteristics to be customized to meet changing test standards and standard interpretations. Rather than providing a rigid programmed method, most of the operational characteristics such as IEC test limits, test window times and filter characteristics are data base driven.

A skilled operator may access the data in this data base and customize the system to his or her specific needs. Furthermore, if changes occur in one or more of the applicable test standards, it is possible to incorporate such changes without the need to upgrade the software version.

The Calibration and Configuration module is a separate program utility which is distributed as part of the CTSMXL software suite and may be used to access the configuration data base. It is located in the CTSMXL program directory. This chapter covers the configuration parameters only. For information on calibration settings and period calibration, refer to chapter 0.

### 16.2 Accessing the Calibration and Configuration Database

The Configuration utility is provided to allow the operator to view calibration and configuration parameters contained in this database. Only authorized users can change any of these values if properly logged in. Upon launching the Configuration.exe program, you will be prompted for your name and password. A history of all users and dates at which the configuration data has been changed is retained for audit purposes.

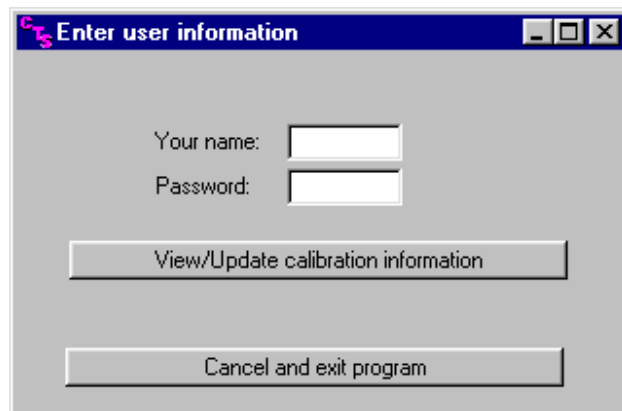

The correct password is "cal\_lock". If no password or an incorrect password is specified, the operator can only view configuration data but not change any of it. After entering the correct name and password, the data can be both viewed and changed if needed. Click on the View/Update Limit Information button to access the configuration database.

16.2.1 Calibration and Configuration Data

The following calibration and configuration data is available to the user. If the correct password has been entered, this information can be updated. If not, it can only be viewed. Any changes will be logged and time stamped so an audit trail is available.

Field	Description
Main	Displays information on the A/D card and base sampling frequency.
Calibration information	Individual voltage and current channels have calibration coefficients, which are calculated automatically when running the Calibration module. (See section 0) Normally, there is no need to edit these values.
Maximum Current Limits	The CTS system uses three current ranges for maximum resolution and accuracy of current harmonics measurements. The range coefficients are used to set the cross over points of these current ranges. These values should not be change by the user.
Impedance	These fields set the flicker reference impedance values. Values used may differ between European and Japanese standards. The Japanese standard presently requires the use of the reference impedance for both harmonics and flicker tests. During harmonics tests, this will result in high voltage distortion. This conflict has not been resolved at this time. The impedance values are different for single and three phase modes.
System Configuration	This setting determines if reference impedance is used and if so, which type. Available choices are:

Field	Description
No CI power source	Select this option if you are not using a CI AC Source or have no OMNI impedance.
External OMNI	Select this option if you have an OMNI-3-75 connected to the MX through the system interface cable. Also select this option if you have an OMNI-3-37MX controlled from the front panel.
CI Source with programmable impedance	Select this option if the programmable impedance of the MX30-3Pi or MX45-3Pi is used in addition to external reference impedance. In this mode, the external OMNI has to be engaged either manually or through the MX front panel.
Original Calibration Information	Shows original calibration date of CTS system.
Calibration Data Update Information	Shows the last date the system calibration data was changed and by whom.

## 17. Calibration

---

### 17.1 About This Chapter

This chapter covers two basic functions: System calibration and system configuration. Single phase calibration is covered first and additional steps for three phase calibration are also covered. System configuration is then covered detailing the steps to properly set up the AC power source.

If the CTS system you have includes an AC power source, refer to the separate user manual that shipped with the AC source for service and calibration information.

### 17.2 Calibration

The MXCTS system uses a precision measurement system that requires periodic calibration. The recommended calibration interval is one year. All MXCTS systems are factory calibrated before shipment, so adjustment should not be needed until after the first year of use.

---

**Note:** For calibration at the factory, the A/D card must be returned with the PACS-3-75.

---

A special calibration program is included in the CTSMXL Software suite to facilitate calibration and store the calibration constants. This module is called “**Calibration**” and is available from the **CTS MXL** program menu selection. The program screen is shown on the next page. Make appropriate selection before clicking on the Calibrate button. Upon Clicking the Calibration button, you will be given step-by-step instructions to complete the calibration. At the end of a calibration, the Accept button will be available. Clicking on it will cause the software to save the calibration data and printout a calibration log file.

#### 17.2.1 Required Calibration Equipment

To perform the CTS measurement system calibration, the following equipment is required:

Equipment	Description
Digital AC Multimeter	Agilent 34401A DMM or equivalent with traceable calibration.
Resistive Load Bank	Avtron K565 or equivalent. The load resistor range must be able to handle 2 - 30A rms (or higher for PACS-3-75) and be rated for the power levels used.
Current Shunt	50A Current shunt 0.05 % accuracy or better, e.g. Isotek.

Table 17-1: Required Calibration Equipment

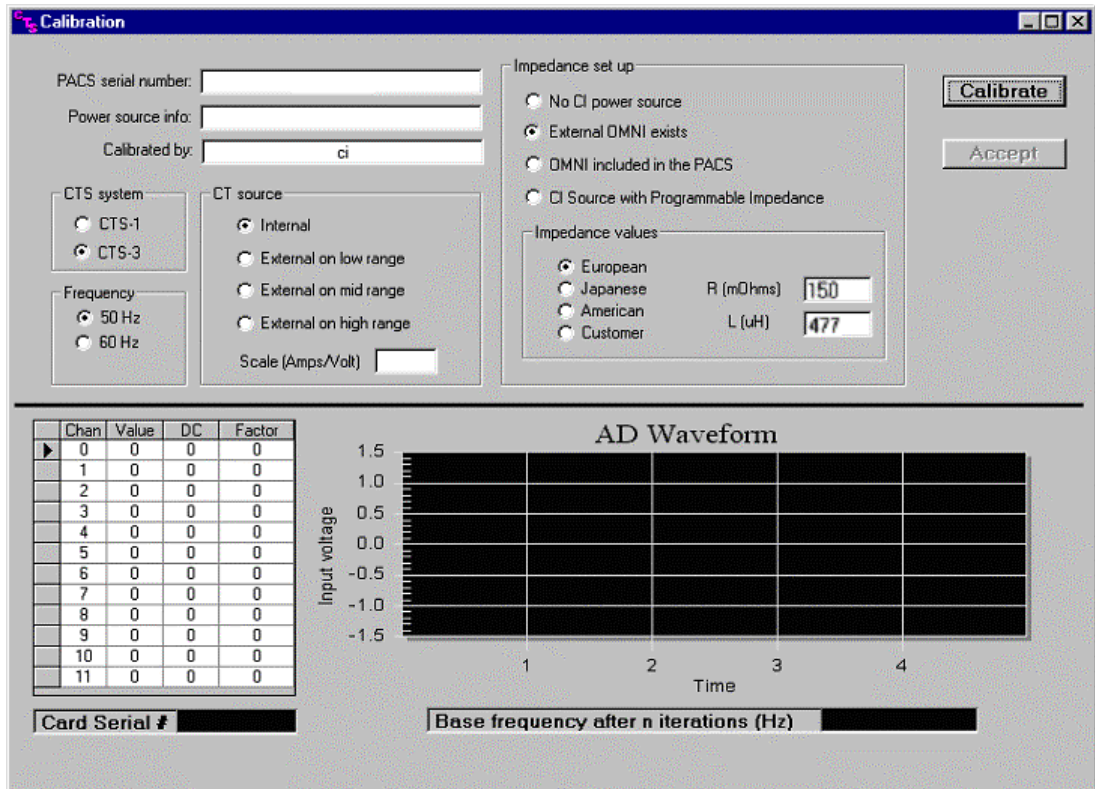

Figure 17-1 : CTSMXL Calibration Program Main Screen

### 17.3 Install A/D Card in PC

For PACS-3-75 units shipped with the PCI A/D card, the PACS-3-75 unit must be calibrated with the PCI data acquisition card and interconnect cable supplied with the system. Install the PCI card into the test computer and connect it to the rear terminal of the PACS-3-75 with the supplied cable.

### 17.4 PACS-3-75 Calibration Setup

To calibrate the CTS measurement system, proceed as follows:

1. Configure the test set-up as shown in Figure 17-2. Please note that only a single-phase A/C source is needed to calibrate a three-phase PACS unit.
2. Connect the current shunt or current transformer in series with the neutral wire between the PACS-3-75 unit and the load bank.
3. Connect the Voltage DMM at the AC IN terminals on the PACS-3-75 unit. (TB4)

### 17.5 Configuration Procedure

1. Start the Calibration module located in the **Compliance Test System** Program group called **Calibration** (See Figure 17-1).
2. Fill in the information for PACS-3-75 serial #, Power source to be used for the calibration, and your name or ID. Make all other appropriate selections before clicking on the Calibrate button.
3. Once the Calibrate button is clicked, the software will prompt you to fill in a table recording the equipment and measurement instruments to be used for this calibration. When this is completed, the program will provide you with the step by step instructions. Follow these

instructions until the Accept button is enabled. If you did not follow the instructions during the calibration or the software is aborted for some other reason, you may have to redo the entire calibration. Please note that the calibration data is not saved until the Accept button is pressed.

4. Please note that when calibrating a three-phase PACS, all three channels will be calibrated together. The software will do all three-voltage channels, all high current range channels, all mid-range channels, and then all low range channels.
5. When calibrating the voltage channels, you will be asked to provide a 230V/50Hz input. However, when calibrating the current channels, it is not necessary to keep the voltage input at the same level. In addition, the calibration on current channels is in the sequence of 60 Arms / 200 App, 24 Arms / 40 App, and 4 Arms / 10 App. The software does not do auto ranging in the process. This means that even if you apply 2 Arms when you are doing 60Arms/200App range channel(s), the software will still perform the corresponding calibration. The drawback of doing so is that the calibration accuracy may be compromised.
6. When the Accept button becomes available and is clicked at the end of calibration, the software will save the data in text file with the name of "C:\Ctsmxi calibration.dat". In addition, it will generate "calibrate.log" in the CTS directory and print out a hardcopy of this file automatically. It will also save the calibration information in a database. Further, it will ask you if you want to copy the calibration data to floppy and back up the files on the network. If you answer yes, it will perform all the copying and backup for you automatically. The back up directory is that stored in log\_dir.txt file and a sub directory of PACS-3-75's information you entered before you click on the calibrate button.
7. If you copied the calibration data to the floppy, remove disk from drive and write the PACS-3-75 serial number on the floppy disk.



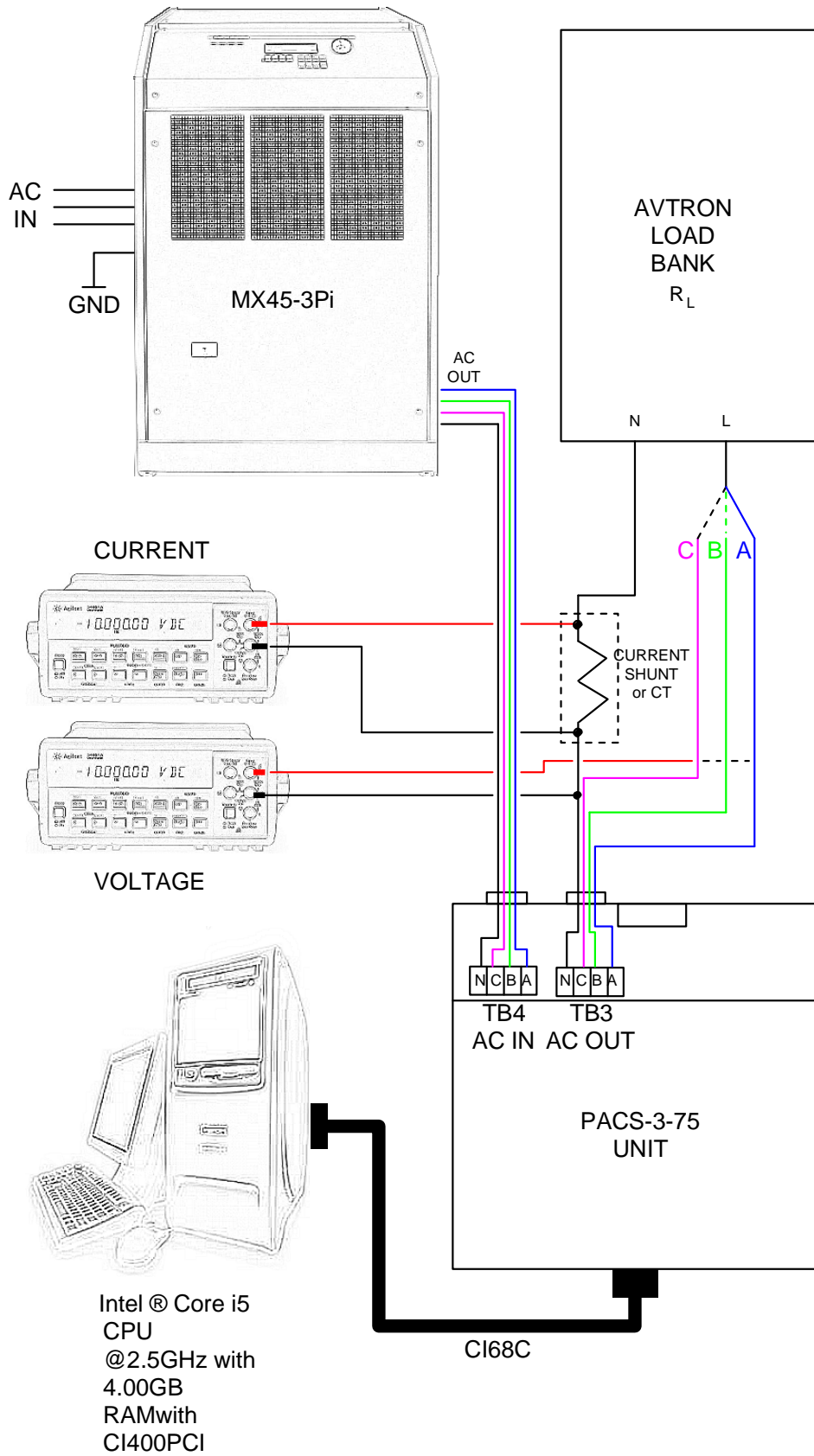

Figure 17-2: Three Phase Calibration Setup



## 17.6 Installing New CTSMXL Calibration Data

If you have send in the MXCTSL system for calibration at a remote calibration lab or at California Instruments, the PC normally used to run the CTS system will typically not have the new calibration on it when you receive the PACS-3-75 and A/D card back. The new calibration data will be received on a floppy disk or emailed to you as an alternative.

To install the new calibration data, proceed as follows:

1. Insert the calibration disk received into floppy drive A
2. Open your Windows Explorer and select drive A.
3. Copy the Ctsmxl\_calibration.cts file located in the floppy root directory
4. Paste this file to the C:\ root of the PC that operates the CTS system.
5. Run the CTSMXL program. Upon launch, the CTSMXL program will detect the calibration data file, which should have a newer date and time stamp that the calibration data currently in use. If so, the program will automatically read the new cal file and update its calibration database.
6. You can verify that the new calibration data has been loaded by selecting the "View, Calibration Info" menu.

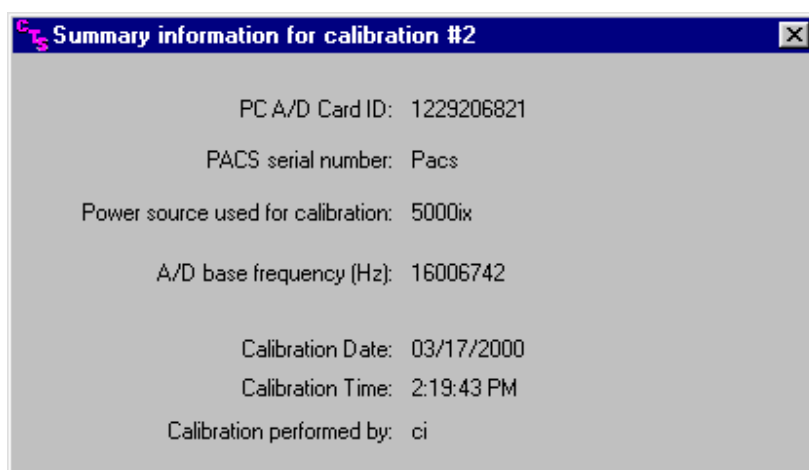

You can save the calibration disk if needed although annual re-calibration of the system is recommended.

---

## 18. Principle Of Operation

---

### 18.1 General

The Compliance Test System is a power measurement and power analyzer system. The three basic building blocks are:

- **AC power**, either line power or, typically, a CI power source to provide the proper voltage and frequency for the test at hand.
- **PACS-3-75** measurement unit. This device measures the actual current and voltages under test and conditions the signals to be compatible with the Analog to Digital data conversion card.
- **CTSMXL Software**. The software is the final link to the user. It translates the data from the AD card into viewable and readable measurements in a GUI format.

### 18.2 AC Power

The AC power source provides precise control of voltage and frequency is needed, as in IEC regulatory testing.

### 18.3 PACS-3-75 Measurement Unit

The PACS-3-75 measurements module uses Hall Effect current sensors to isolate and scale a sense voltage that is an accurate and linear function of the current being measured. The sensing amplifiers uses differential sensing to reduce common mode noise pick-up before it is sent to the interface connector for transmission to the host PC.

To sense the applied voltage, another set of differential amplifiers are used together with high precision sense resistors to provide high CMRR. The sense resistors are of high enough impedance to limit any leakage current to under 0.5mA.

### 18.4 OMNI-3-37MX Impedance

The OMNI-3-37MX provides the required lumped impedance ( $Z_{ref}$ ) for IEC 61000-3-11 Flicker testing of EUT's up to 37 A RMS per phase.

### 18.5 CTSMXL Software

The CTSMXL Software is designed to work with the data acquisition card's digital samples of voltage and current. Numerous data channels are scanned sequentially and the software then calculates many parameters using Fast Fourier Transforms and displays them in the Graphical User Interface. In addition to numerical outputs of voltage current, power etc., the software also displays real time graphics of voltage and current.

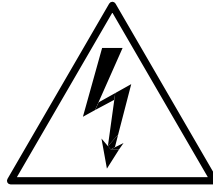

## **CAUTION**

**VOLTAGES UP TO 480 VAC AND 650 VDC MAY BE PRESENT IN CERTAIN SECTIONS OF THE COMPANION POWER SOURCES. THIS EQUIPMENT GENERATES POTENTIALLY LETHAL VOLTAGES.**



## **DEATH**

**ON CONTACT MAY RESULT IF PERSONNEL FAIL TO OBSERVE SAFETY PRECAUTIONS. DO NOT TOUCH ELECTRONIC CIRCUITS WHEN POWER IS APPLIED.**

## 19. Service

### 19.1 Cleaning

The exterior of the power source or the PACS-3-75 unit may be cleaned with a cloth dampened with a mild detergent and wrung out. Disconnect mains power before cleaning. Do not spray water or other cleaning agents directly at the equipment.

### 19.2 General

This section describes the suggested maintenance and troubleshooting procedure. The troubleshooting procedure is divided into two sections. The first section deals with basic operation and connection of the equipment. The second section requires opening the PACS-3-75 unit and using the Test Points and a simple Digital Multimeter to troubleshoot the unit down to the circuit level. Only a qualified electronic technician should attempt this level of troubleshooting.



**CAUTION: VOLTAGES UP TO 312 VAC MAY BE PRESENT IN CERTAIN SECTIONS OF THE PACS-3-75 MEASUREMENT UNIT.**



**WARNING: THIS EQUIPMENT CONTAINS POTENTIALLY LETHAL VOLTAGES. DEATH ON CONTACT MAY RESULT IF PERSONNEL FAIL TO OBSERVE SAFETY PRECAUTIONS. DO NOT TOUCH ELECTRONIC CIRCUITS WHEN POWER IS APPLIED**

### 19.3 Basic Operation

#### 19.3.1 No Power To EUT

CONDITION	POSSIBLE CAUSE, REMEDY
No power to EUT	Line voltage or power source not at expected value. Verify power line voltage is correct. Verify power source voltage is at programmed value
AC source voltage OK. No power to EUT.	Incorrect input wiring at TB4. Check for wrong terminals or poor connections.
AC source voltage OK. Input wiring is OK. Still no power to EUT	Incorrect output wiring from TB3. Check output wiring from TB3, or, verify cable and plug going to EUT is good

19.3.2 Power Source Shuts Down

CONDITION	POSSIBLE CAUSE, REMEDY
The power source shuts down when the EUT load is applied	If the companion power source shuts down when the EUT load is applied, it is very likely that the power source is being severely overloaded. Any severe overload will cause the MX to fold back the output voltage or trip off depending of the selected Current protection mode.
The power source shuts down immediately when it is programmed to the test voltage	Another possible cause of shutdown is a short circuit in the EUT wiring or EUT load. Make sure neutral and line wires don't form a short circuit.

19.3.3 Power Source Overload Light On

CONDITION	POSSIBLE CAUSE, REMEDY
Overload light on power source is on	When the overload light is on, the power source is close to faulting or folding back the output voltage. <b>Adjust</b> EUT loading if possible to keep power source within its ratings.

19.3.4 No Signal To PC Interface

CONDITION	POSSIBLE CAUSE, REMEDY
EUT is being driven properly and voltage and current is present, but the CTSMXL Software GUI shows zero current or zero voltage or otherwise incorrect measurement readings..	<p>The PACS-3-75 front panel power switch is not on. Turn on switch, check ON LED.</p> <p>The ½ Amp input fuse is open. Replace fuse.</p> <p>The interface cable between the PACS-3-75 and the PC is not properly seated in its mating connectors. Reinsert connectors. Check for any bent pins..</p> <p>The Sensor Circuit board assembly inside the PACS-3-75 module is defective. See next section.</p>

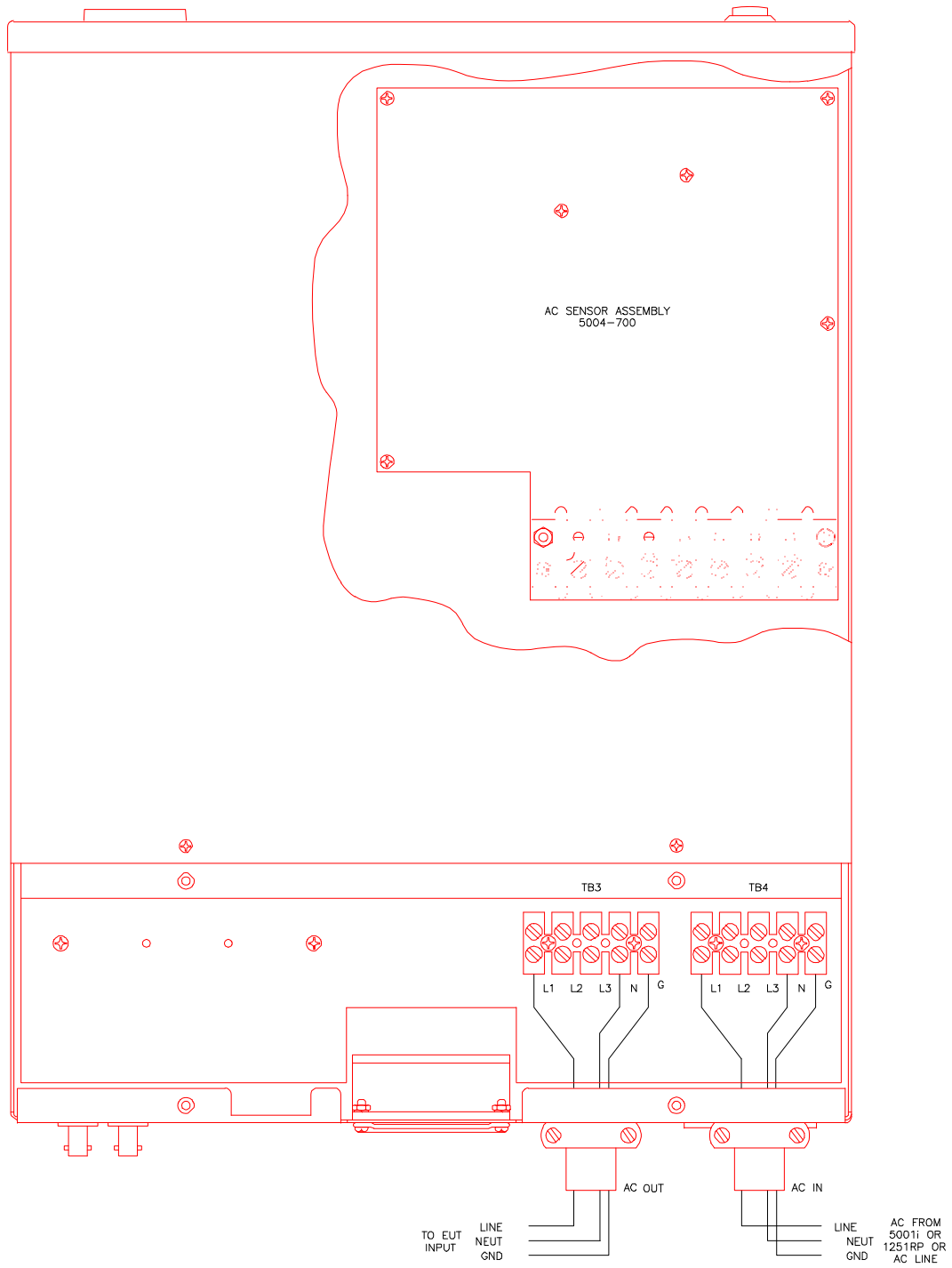

Figure 19-1: Location of AC Sensor Assy. 5004-700 in PACS-3-75



## 19.4 Advanced Troubleshooting

If it is suspected that the AC sensor circuit board inside the PACS unit is defective it will be necessary to remove the top cover of the unit and perform some basic tests to determine if the circuit is functioning properly. See Figure 33 for location.



**CAUTION: VOLTAGES UP TO 312 VAC ARE PRESENT IN CERTAIN SECTIONS OF THIS POWER EQUIPMENT.**

---



**WARNING: THIS EQUIPMENT CONTAINS POTENTIALLY LETHAL VOLTAGES. DEATH ON CONTACT MAY RESULT IF PERSONNEL FAIL TO OBSERVE SAFETY PRECAUTIONS. DO NOT TOUCH ELECTRONIC CIRCUITS WHEN POWER IS APPLIED**

---

### 19.4.1 Switch Off Unit, Disconnect High Voltage

Switch off the PACS-3-75 unit with the front panel power on/off switch. Also disconnect or remove any AC voltage applied to the rear connection terminals TB3 and TB4.

### 19.4.2 Removing Top Cover

Remove the screws securing the top cover and remove the top cover.

### 19.4.3 Initial Inspection

Perform a visual inspection of the unit and ensure all the connectors are properly mated and there are no loose or broken wires. Check the interface cable going from the AC sensor assembly 5004-700 to the front and rear panels.

### 19.4.4 Power-On Troubleshooting - DC Supplies



**WARNING: Do not touch any parts inside the unit during these tests, as they will be live and dangerous. Always wear safety glasses.**

---

1. Connect a DMM common test lead to TP1 on the 5004-700 AC sensor assembly. TP1 is the circuit common for all DC supplies and test signals. Connect the other DMM lead to the cathode of diode CR4.
2. Switch on the PACS unit with the front panel switch.
3. Verify the DC voltage at CR4-cathode is +15V.
4. Connect the other DMM lead to the anode of diode CR5.
5. Verify the DC voltage is -15V.
6. If either of these voltages are not as specified, the board will not function properly and will need to be serviced.

**19.4.5 Power-On Troubleshooting - Voltage Sense**

1. Connect the DMM common to TP1.
2. Connect the other DMM lead to TP2. This is the phase A voltage sense output.
3. Apply a test voltage to the PACS-3-75 input terminals TB4. Use Neutral and ph- A
4. The reading at TP2 should be 1/100 of the input voltage. For example, if 120 V rms is applied at TB4, then there should be 1.20V rms at TP2.
5. Connect the other DMM lead to TP3. This is the phase B voltage sense output
6. Apply a test voltage to the PACS-3-75 input terminals TB4. Use Neutral and ph- B
7. The reading at TP3 should be 1/100 of the input voltage. For example, if 120 V rms is applied at TB4, then there should be 1.20V rms at TP3.
8. Connect the other DMM lead to TP4. This is the phase C voltage sense output
9. Apply a test voltage to the PACS-3-75 input terminals TB4. Use Neutral and ph- C
10. The reading at TP4 should be 1/100 of the input voltage. For example, if 120 V rms is applied at TB4, then there should be 1.20V rms at TP4.
11. If any of these test points do not have the correct voltage on them, the board is malfunctioning and it must be serviced.

**19.4.6 Power-On Troubleshooting - Current Sense**

1. Connect the DMM common to TP1.
2. Connect the other DMM lead to TP6. This is the phase A current sense output.
3. Apply a 4A test current to the PACS-3-75 input terminals TB4. Use Neutral and ph- A.
4. The reading at TP6 should be 496mV/ Amp of input current. For example, with 4.0A rms applied at TB4, then there should be 1.984V rms at TP6.
5. Connect the other DMM lead to TP8. This is the phase B current sense output.
6. Apply a 4A test current to the PACS-3-75 input terminals TB4. Use Neutral and ph- B.
7. The reading at TP8 should be 496mV/ Amp of input current. For example, with 4.0A rms applied at TB4, then there should be 1.984V rms at TP8.
8. Connect the other DMM lead to TP10. This is the phase C current sense output.
9. Apply a 4A test current to the PACS-3-75 input terminals TB4. Use Neutral and ph- C.
10. The reading at TP10 should be 496mV/ Amp of input current. For example, with 4.0A rms applied at TB4, then there should be 1.984V rms at TP10.
11. If these sense voltages are not obtained then the board is malfunctioning and it must be serviced.

## Index

A/D card.....	140	Emissions.....	134, 136
abort.....	75	EN 61000-3-2.....	19
AC Source.....	13	EN 61000-3-3.....	22
control program.....	14	EN 61000-4-11.....	23, 88
Acoustic.....	134, 136	compliance.....	89
acquisition system.....	13	test results.....	92
acquisition window.....	63	test setup.....	91
AD card		EN 61000-4-13.....	23
specifications.....	131	EN 61000-4-14.....	24, 101
assumptions.....	11	test results.....	106
calibration.....	140	test sequence.....	103
procedure.....	141	test setup.....	102
required equipment.....	140	EN 61000-4-17.....	24, 108
CE mark.....	134, 136	test results.....	110
CI400PCI.....	13	test sequence.....	109
CI401PCI.....	13	test setup.....	109
CI403PCI.....	13	EN 61000-4-27.....	25, 112
class A devices.....	63	EN 61000-4-28.....	25, 117
class B devices.....	63	test results.....	121
class C devices.....	63	test sequence.....	119
class D devices.....	63	test setup.....	118
Class D wave shape.....	64	EN 61000-4-29.....	25, 122
Classes		ESD.....	47
IEC 1000-2-3.....	16, 20	European Union.....	16
compliance		fields	
EN 61000-4-11.....	89	flicker window.....	81
components.....	12	flicker	
Configuration		impedance.....	135
Changing.....	137	Flicker.....	22
CTSMXL.....	137	standard.....	22
contents.....	6	fluctuations voltage.....	
controls		101.....	
flicker window.....	81	frequency	
copyright.....	5	variations.....	117
CTS		front panel.....	30
components.....	12	graph	
description.....	12	current harmonics.....	75
software.....	11	voltage and current.....	75
current		voltage harmonics.....	75
fundamental.....	75	GUI.....	14
description		harmonic current limits	
CTS.....	12	dynamic.....	65
device class.....	63	harmonics	
disks		device class.....	63
distribution.....	56	fluctuating.....	20
display		quasi stationary.....	20
resolution.....	67	stationary.....	20, 66
distribution disks.....	56	testing.....	63
		transitory.....	20, 66
		Harmonics	
		IEC61000-4-7.....	21

IEC .....	15	report	
address.....	26	problems printing .....	77, 85
ANSI address .....	26	templates .....	77, 85
directive .....	15	resolution display .....	67
IEC 555-2 .....	19	Ripple	
IEC 555-3 .....	22	DC.....	108
IEC Tests		Safety.....	134, 136
INI File .....	128	sample CI-INI file.....	129
test parameters.....	128	Shock.....	134, 136
IEC61000-4-7		software	
Inter Harmonics .....	21	license .....	3
IEEE-488		revision.....	3
Bus Controller.....	48	software installation	
Immunity.....	134, 136	MXGUI .....	58
impedance		software license .....	3
flicker.....	22, 135	specifications.....	131
reference .....	22, 135	measurements .....	131
specifications .....	135	PACS .....	133
INI File		Temperature	
IEC Tests.....	128	operating,storage .....	134, 136
installation.....	27	template .....	64
CTSMXL Software.....	56	templates	
MXGUI.....	58	missing.....	77, 85
Interharmonics.....	23	test	
LED indicators .....	147	classes .....	16, 20
limits		test data file	
dynamic.....	65	harmonics.....	77
EN 61000-3-2 .....	17, 18	test margin	
harmonic current .....	17, 18	flicker.....	84
main window		harmonics.....	74
flicker.....	81	test parameters	
maintenance .....	147	IEC Test.....	128
manual		test reports	
history.....	3	EN 61000-4-13.....	100
organization .....	11	EN 61000-4-29.....	126
measurements		test results	
specifications .....	131	EN 61000-4-11.....	92
message box		EN 61000-4-14.....	106
over 16 Amps .....	74	EN 61000-4-17.....	110
MXGUI		EN 61000-4-28.....	121
software installation .....	58	test sequence	
new.....	3	EN 61000-4-14.....	103
OMNI-3-37MX .....	29	EN 61000-4-17.....	109
OMNI-3-75.....	29	EN 61000-4-28.....	119
Versions.....	32	test setup	
PACS		EN 61000-4-14.....	91
specifications .....	133	EN 61000-4-28.....	118
PACS-3-75 .....	12, 13	test time	
parameters		flicker.....	84
IEC 1000-4 tests .....	128	harmonics.....	74
printing.....	3	top cover	
reports .....	76	removal .....	150
reference impedance .....	22	troubleshooting.....	147
references.....	26	unbalance	

---

voltage .....	112	dips.....	88
user data		fluctuations .....	101
flicker .....	84	interruptions.....	88
harmonics .....	74	unbalance.....	112
variations		variations.....	88
frequency .....	117	warranty.....	5
VGA		wave shape	
resolution .....	67	class D.....	64
Vibration .....	134, 136	window	
voltage		flicker .....	81
DC Ripple .....	108		