

CATALOGUE

***OPTO-
ELECTRONIC
SENSORS***





Registration No.: 1327-01

For all transactions, the newest version of the „General Conditions of Sale and Delivery for Products and Services of the Electrical Industry ZVEI“ shall apply, along with the supplementary conditions „extended reservation of proprietary rights“, together with the supplements listed on our order confirmations and/or invoices.

All specifications are subject to change without notice. Reprint, even in part, only with our consent.

© RECHNER Germany 05/2006 GB - Printed in EU, all rights reserved.

Edition May 2006

With publication of this catalogue all former printed general catalogues about RECHNER infrared sensors (optical reflection-sensors) are invalid.

All specifications are subject to change without notice. (05/2006)

TABLE OF CONTENTS

CATALOGUE OPTOELECTRONIC SENSORS (optical reflected light barriers)

	Pages
TECHNOLOGY MOUNTING APPLICATION	4 - 6
TECHNICAL TERMS	6 - 7
TYPE CODE	7
ACCESSORIES	7
CYLINDRICAL HOUSINGS	8 - 10, 13
RECTANGULAR HOUSINGS	11 - 12
TYPE SELECTION IN ARTICLE NUMBER ORDER.....	14
TYPE SELECTION IN TYPE DESCRIPTION ORDER	14

All specifications are subject to change without notice. (05/2006)

TECHNOLOGY MOUNTING APPLICATION

The *IS-120 series* comprises *optoelectronic sensors* for use as light sensors (energetic or with background suppression) or as reflection light barriers. Light transmitter and receiver are both mounted in the same housing. The emitting diode emits radiation with a wavelength of 660 nm with red-light switches or 880 nm with infrared switches. When hitting the detected object the pulsed light is reflected diffusely and partially impinges on the receiver. With **energetic sensors** the received energy is evaluated whereby the possible sensing distance is dependent on the colour/reflection characteristics and dimension/design of the object. With **light sensors with background suppression** the angle of incidence is evaluated and thus the sensing distance is to a great extent independent of the object's characteristics. For example, these sensors are applicable to detect objects in front of bright or strongly reflecting surfaces.

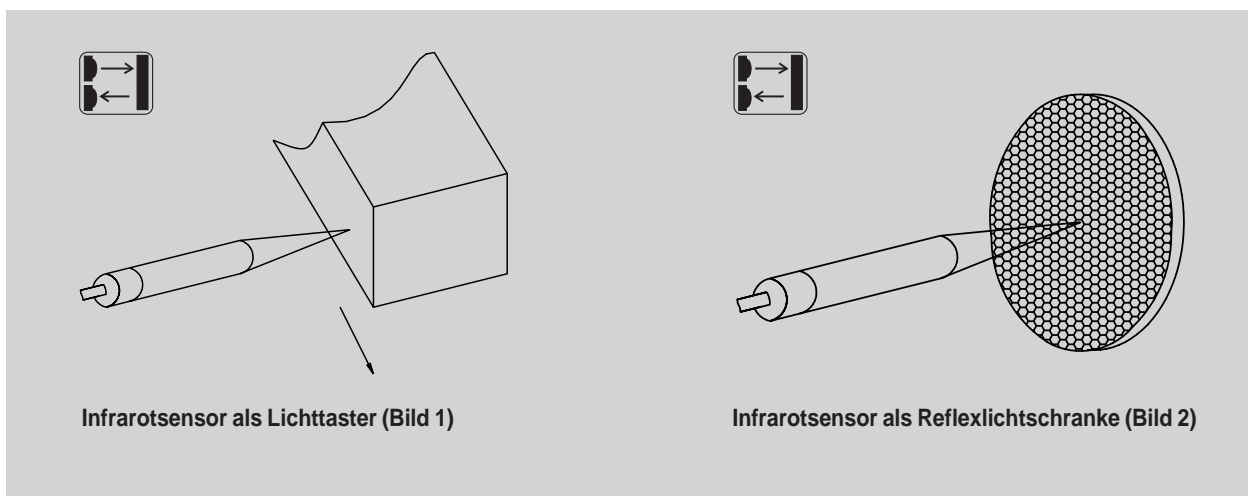

If the **optoelectronic sensor is used as an energetic light switch** (fig. 1), the object to be detected reflects the transmitted light. The quantity of light measured by the phototransistor depends on the distance, colour and character of the surface of the detected object. White Kodak paper has to be used when measuring the max. range (see technical data). Smaller ranges result when using other colours and sizes.

When using the **optoelectronic sensor** (energetic switch only) as a **reflection light barrier** (fig. 2) a triple reflector or foil reflects the transmitted light. In this way a much more extended sensing range can be achieved (as of approx. 1 m) than on white paper. In this case the interruption of light by a lower reflecting object is measured. In order to measure the max. range (see technical data) a triple reflector with a diameter of 80 mm has to be used. The use of smaller diameters/surfaces results in smaller ranges.

Optoelectronic sensors from RECHNER can operate from an **object distance of zero**. There is no dead-zone.

Reflection light sensors with background suppression have a PSD-element (position sensitive device) as receiver. The light spot is visible for easy alignment and the sensing range is adjustable. Since there are no **moving optical parts**, they are *vibration-proof*, like all *optoelectronic sensors from RECHNER*.

The pulsed light of the emitting diode is focused on the object and is reflected diffusely. Thus part of the light impinges on the PSD-element. Depending on the object distance the light strikes a certain area of the PSD-element (fig. 3). The output switches when the object distance is smaller or equal.

Adjustment:

- Place the object at the maximum prescribed distance from the light sensor.
- Focus the light beam on the object or the reverse.
- Adjust the sensing distance with the potentiometer so that the output just switches.
- Remove the object.
- Readjust it via the potentiometer, so that the output just switches on the background.
- Finally turn the potentiometer to the middle between the first and second adjustment.

When there is no background the potentiometer should be adjusted to maximum distance. Background suppression is not suitable for reflecting surfaces.

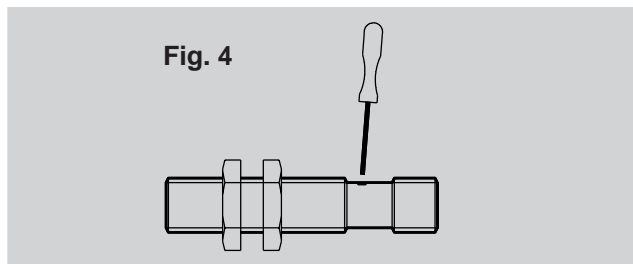
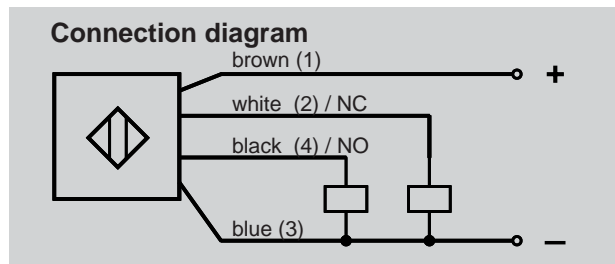
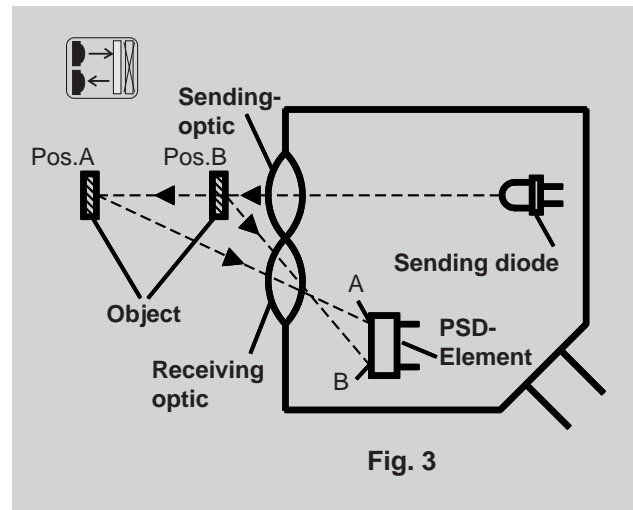

Cylindrical and rectangular sensors with pnp, **N.O. (=light on) digital output or with antivalent output (N.O. and N.C.)** are available. Other output functions are available on request.

Optoelectronic sensors from size M12 x 1 and the rectangular designs have a potentiometer on the side (Fig. 4) for adjusting the sensing range, a yellow LED display for the operating state and a green LED display for "enough excess light" (= ca. 80% of max. sensing range.)

The optoelectronic MINI-light switch M5 x 0,5 is equipped with a fixed sensing distance and a yellow LED display. The yellow LED flashes if the excess light is not sufficient.

The excess light indicator is a good aid for focusing the sensor on the object and for adjustment. Furthermore unfavourable operating conditions may be recognized on time (e.g. dirty optic).

Mounting in series:

To prevent mutual interference, a minimum distance between the sensors has to be taken into consideration according to the following table.

Please consider these values as a rough guide only. They are maximum sensitivity specific.

	Energetic switch	Switch with background suppression
Design	minimum distance at the side [mm]	
M 5 x 0,5	50	-
M 12 x 1	150	-
M 18 x 1	500	50
30 x 30 x 15	500	50

All specifications are subject to change without notice. (05/2006)

The components of the types in size M5 x 0,5 are mounted in stainless steel housings V2A. The models from M12 x 1 upwards are mounted in nickel-plated brass housings. All types are completely filled with casting resin. The rectangular versions have a Crastin housing, glass-fibre reinforced PBTP (polybuteneterephthalate) fully potted with polyurethane resin. The housing parts are welded via ultrasonics.

Wiring of the infrared sensors should be routed separately from heavy conductor lines or a.c. voltages as in extreme cases inductive peak voltages can destroy them despite the integrated protective circuit. The cable length should not exceed 300 m, because long cables cause an increasing capacitive load at the output.

Please note:

When mounting the sensors with thread in a threaded bloc the maximum screw-in length has to be considered. Also please take note of the version specific maximum fixing torque. The values are based on the use of the nuts supplied with the sensors. The possible screwing length, according to DIN 13, and maximum fixing torque are listed in the opposite table.

Thread	Screw-in length	Torque
M 5 x 0.5	max. 3 mm	max. 1.5 Nm
M 12 x 1	max. 8 mm	max. 10 Nm
M 18 x 1	max. 8 mm	max. 20 Nm

Optoelectronic sensors are essential in terotechnology and mechanical engineering for positioning, counting and differentiating different products. Because these sensors operate without any mechanical contact they are virtually wear-free. Under extreme operating conditions, e.g. with aggressive chemical media, we recommend checking the resistance of the housing material.

TECHNICAL TERMS

Series mounting

To prevent mutual interference, a minimum distance between the sensors must be observed. This minimum distance depends on their type and is maximum sensitivity specific.

Extraneous light

Is the light produced by external light sources which impinge on the receiver. Due to the use of modulated light in kHz range the sensors are insensitive to extraneous light, provided the max. extraneous light limit is not exceeded

Excess light

Is the quantity of the excess radiation power that impinges on the light receiver. The excess light can decrease in course of time, due to dirt on the optic or if the reflection characteristics of the object change. An insufficient amount of excess light is indicated by a LED display..

Brightness control element

Preferred for reflection light sensors. When the light is reflected from the object to be detected to the sensor the output transistor is switched through.

Reflecting factor

Specifies the quantity of impinging light that is reflected from the object.

Transmitting range

The maximum possible range between reflection light barrier and triple reflector.

All specifications are subject to change without notice. (05/2006)

Sensing range

The maximum possible distance between reflection light sensor and the object to be detected. White paper with a reflecting factor of 90%, size 200 x 200 [mm] serves as reference object. The standard target has to be moved in an axial direction. For light sensors with a potentiometer the sensing range is adjustable between min. and max. values.

The products of RECHNER Industrie-Elektronik GmbH are designed and checked in accordance with the latest standards and specifications, DIN - VDE - IEC, for electric and electronic instruments. The latest standards are always used for new and revised products.

CE **TYPE CODE**

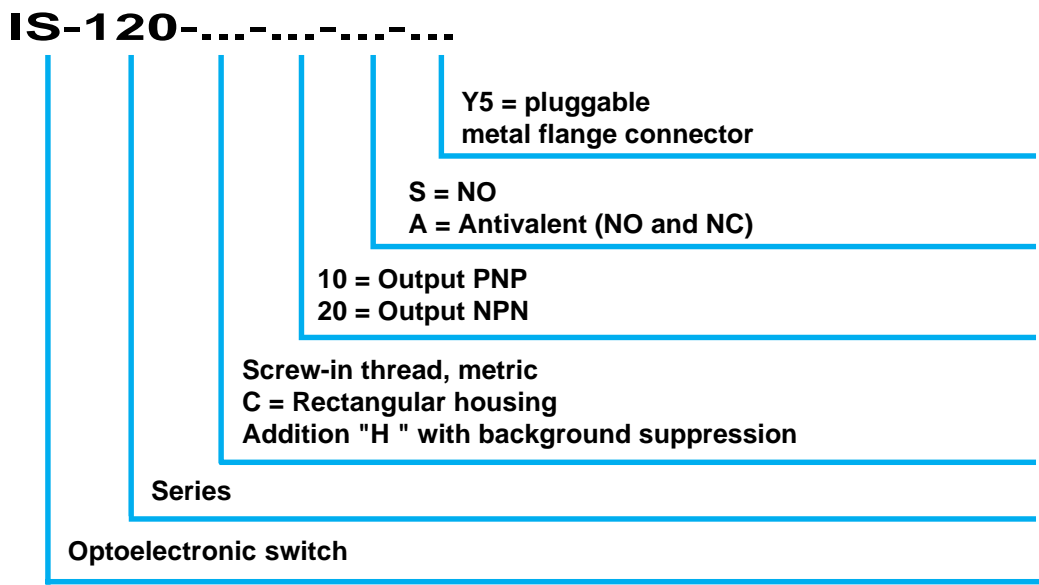

ACCESSORIES

Art.-No.	Type	Accessories
196 100	TS-8	Triple reflector for use of series 120 as reflex light barrier
196 200	BS-I	Mounting device for rectangular sensors 30 x 30 x 15 [mm]
196 210	BS-II	Profile rail mounting device 35 mm for rectangular sensors 30 x 30 x 15 [mm]

All specifications are subject to change without notice. (05/2006)



Optoelectronic sensor

Series 10 - PNP

Housing M5 x 0,5

- Housing material: stainless steel VA
- Sensing range 50 mm
- With plug-in connector M8 x 1
- Energetic sensor



Certificate:

Technical data

Sensing range [mm], min. / max.	50 / 50
Transmitting range [m] with triple reflector	1
Electrical version	3-wire DC
Output function	NO
Typ PNP	IS-120-M5-10-S-Y7
Art.-No.	555 001
Connection diagram No.	4
Operating voltage (U_B)	10...30 V DC
Output current max. (I_o)	100 mA
Sender / Wavelength	IR-LED 880 nm
Extraneous light limit Halogen- / sunlight	5.000 / 10.000 Lux
Voltage drop max. (U_d)	2 V
Permitted residual ripple max.	< 20 %
No-load current (I_o)	typ. 10 mA
Frequency of operating cycles max.	250 Hz
Permitted ambient temperature	0...+55°C
LED-display	switching state: yellow no sufficient function reserves: yellow flashing
Protective circuit	built-in
Degree of protection IEC 529	IP 67
Connection	plug-in connector M8 x 1
Housing material	VA Nr. 1.4305
Active surface	glass
Lid	-

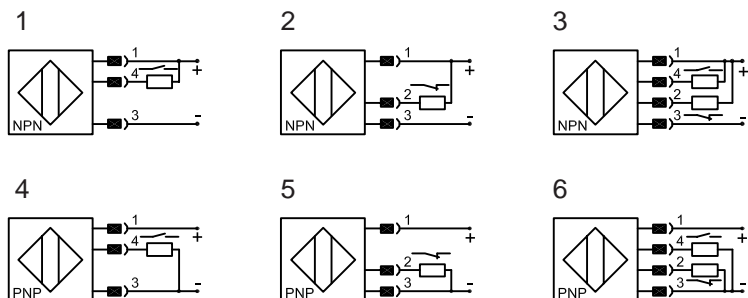
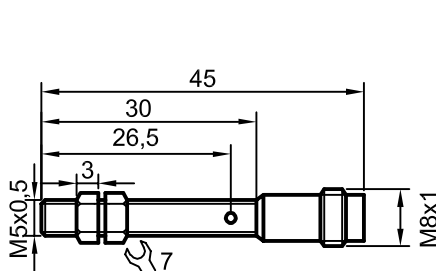

All specifications are subject to change without notice. (05/2006)



Optoelectronic sensor

Series 10 - PNP

Housing M12 x 1

- Housing material: brass
- Sensing range 0...300 mm adjustable
- With plug-in connector M12x1
- Energetic sensor



Certificate::

Technical data

Sensing range [mm], min. / max.	0 / 300
Transmitting range [m] with triple reflector	1
Electrical version	3-wire DC
Output function	NO
Typ PNP	IS-120-M12-10-S-Y5
Art.-No.	556 101
Connection diagram No.	4
Operating voltage (U_B)	10...35 V DC
Output current max. (I_o)	200 mA
Sender / Wavelength	LED red 660 nm
Extraneous light limit Halogen- / sunlight	5.000 / 10.000 Lux
Voltage drop max. (U_v)	2 V
Permitted residual ripple max.	10 %
No-load current (I_o)	typ. 15 mA
Frequency of operating cycles max.	1000 Hz
Permitted ambient temperature	-25...+55°C
LED-display	function reserves sufficient: green switching state: yellow
Protective circuit	built-in
Degree of protection IEC 529	IP 67
Connection	plug-in connector M12 x 1
Housing material	brass
Active surface	glass
Lid	-

All specifications are subject to change without notice. (05/2006)

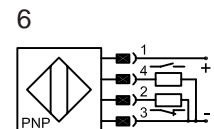
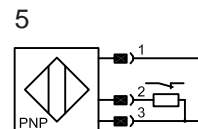
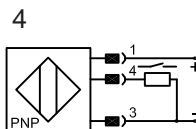
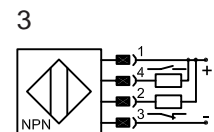
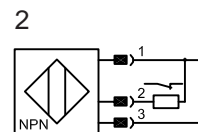
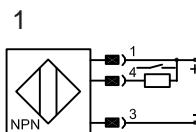
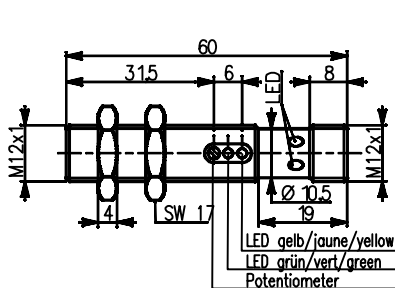



Optoelectronic sensor

Series 10 - PNP

Housing M18 x 1

- Housing material: brass
- Sensing range 0...600 mm adjustable
- With plug-in connector M12 x 1
- Energetic sensor



Certificate:

Technical data

Sensing range [mm], min. / max.	0 / 600
Transmitting range [m] with triple reflector	4
Electrical version	3-wire DC
Output function	NO
Typ PNP	IS-120-M18-10-S-Y5
Art.-No.	557 101
Connection diagram No.	4
Operating voltage (U_B)	10...35 V DC
Output current max. (I_o)	200 mA
Sender / Wavelength	LED red 660 nm
Extraneous light limit Halogen- / sunlight	5.000 / 10.000 Lux
Voltage drop max. (U_d)	2 V
Permitted residual ripple max.	< 20 %
No-load current (I_o)	typ. 15 mA
Frequency of operating cycles max.	1000 Hz
Permitted ambient temperature	-25...+55°C
LED-display	function reserves sufficient: green switching state: yellow
Protective circuit	built-in
Degree of protection IEC 529	IP 67
Connection	plug-in connector M12 x 1
Housing material	brass
Active surface	glass
Lid	-

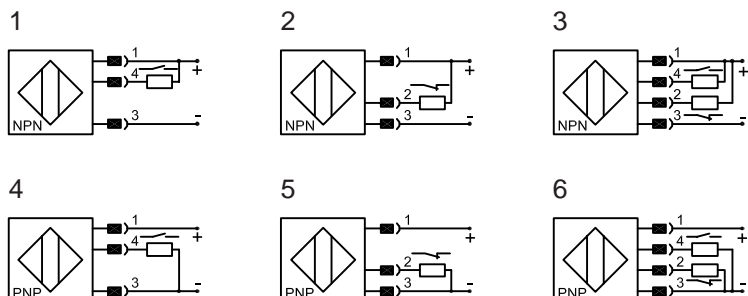
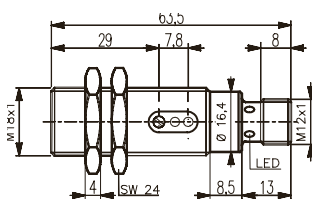

All specifications are subject to change without notice. (05/2006)



Optoelectronic sensor

Series 10 - PNP

Rectangular housing 30 x 30 x 15 mm

- **Housing material: PBTP**
- **Sensing range 1...1200 mm adjustable**
- **With plug-in connector M8 x 1**
- **Energetic sensor**

Certificate::

Technical data

Sensing range [mm], min. / max.	1 / 1200
Transmitting range [m] with triple reflector	4
Electrical version	4-wire DC
Output function	antivalent
Typ NPN	IS-120-C30-20-A-Y7
Art.-No.	559 443
Connection diagram No.	3

Typ PNP	IS-120-C30-10-A-Y7
Art.-No.	559 423
Connection diagram No.	6

Operating voltage (U_B)	10...35 V DC
Output current max. (I_e)	2 x 100 mA
Sender / Wavelength	IR-LED 880 nm
Extraneous light limit Halogen- / sunlight	5.000 / 10.000 Lux
Voltage drop max. (U_d)	2 V
Permitted residual ripple max.	20 %
No-load current (I_0)	typ. 15 mA
Frequency of operating cycles max.	1000 Hz
Permitted ambient temperature	-25...+55°C
LED-display	function reserves sufficient: green switching state: yellow
Protective circuit	built-in
Degree of protection IEC 529	IP 67
Connection	plug-in connector M12 x 1
Housing material	PBTP
Active surface	glass
Lid	-

All specifications are subject to change without notice. (05/2006)

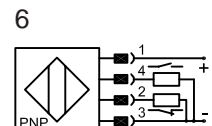
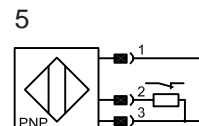
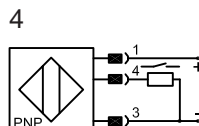
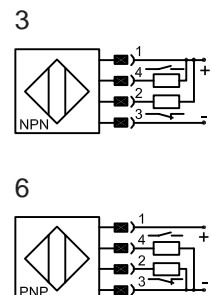
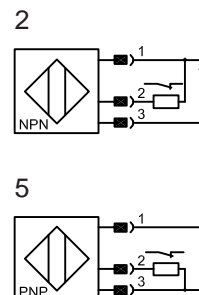
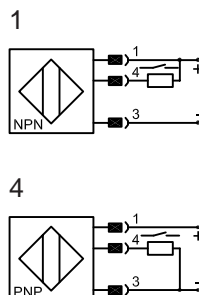
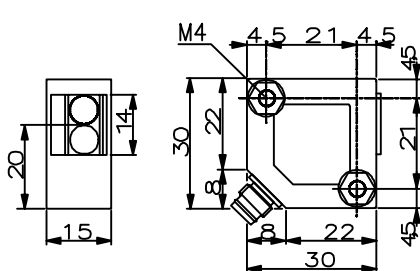



Optoelectronic sensor

Series 10 - PNP

Rectangular housing 30 x 30 x 15 mm

- Housing material: PBTP
- Sensing range 15...150 mm adjustable
- With plug-in connector M8 x 1
- Light sensor with background suppression



Certificate:

Technical data

Sensing range [mm], min. / max.	15 / 150
Transmitting range [m] with triple reflector	-
Electrical version	3-wire DC
Output function	NO
Typ PNP	IS-120-C30H-10-S-Y7
Art.-No.	559 422
Connection diagram No.	4
Operating voltage (U_B)	10...35 V DC
Output current max. (I_o)	200 mA
Sender / Wavelength	LED red 660 nm
Extraneous light limit Halogen- / sunlight	5.000 / 10.000 Lux
Voltage drop max. (U_d)	2 V
Permitted residual ripple max.	20 %
No-load current (I_o)	typ. 25 mA
Frequency of operating cycles max.	500 Hz
Permitted ambient temperature	-25...+55°C
LED-display	function reserves sufficient: green switching state: yellow
Protective circuit	built-in
Degree of protection IEC 529	IP 65
Connection	plug-in connector M8 x 1
Housing material	PBTP
Active surface	glass
Lid	-

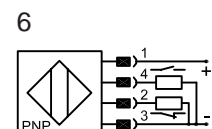
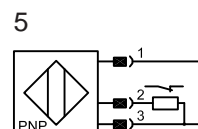
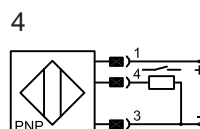
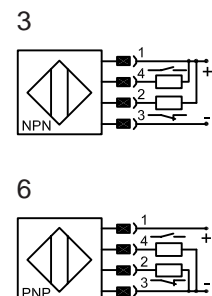
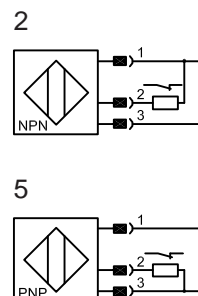
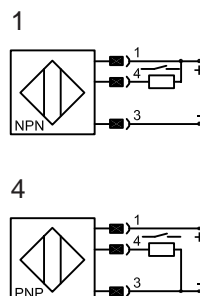
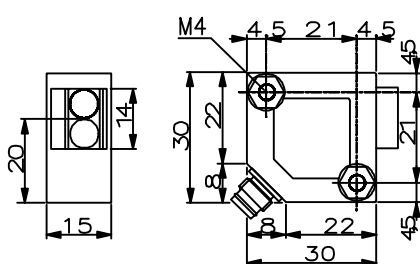

All specifications are subject to change without notice. (05/2006)



Optoelectronic sensor

Series 10 - PNP

Housing M18 x 1

- Housing material: brass
- Sensing range 10...120 mm adjustable
- With plug-in connector M12 x 1
- Light sensor with background suppression



Certificate::

Technical data

Sensing range [mm], min. / max.	10 / 120
Transmitting range [m] with triple reflector	-
Electrical version	3-wire DC
Output function	NO
Typ PNP	IS-120-M18H-10-S-Y5
Art.-No.	557 102
Connection diagram No.	4
Operating voltage (U_B)	10...35 V DC
Output current max. (I_o)	200 mA
Sender / Wavelength	LED red 660 nm
Extraneous light limit Halogen- / sunlight	5.000 / 10.000 Lux
Voltage drop max. (U_d)	2 V
Permitted residual ripple max.	< 20 %
No-load current (I_o)	typ. 25 mA
Frequency of operating cycles max.	500 Hz
Permitted ambient temperature	-25...+55°C
LED-display	function reserves sufficient: green switching state: yellow
Protective circuit	built-in
Degree of protection IEC 529	IP 67
Connection	plug-in connector M12 x 1
Housing material	PBTP
Active surface	glass
Lid	-

All specifications are subject to change without notice. (05/2006)

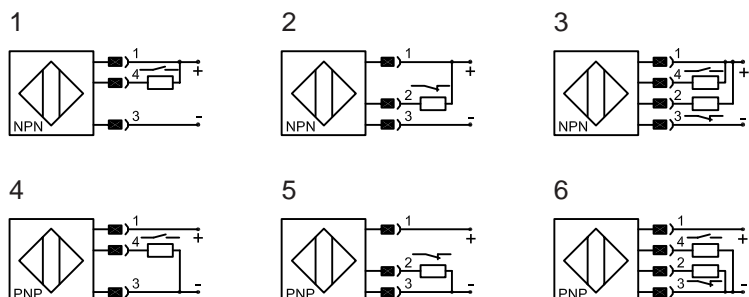
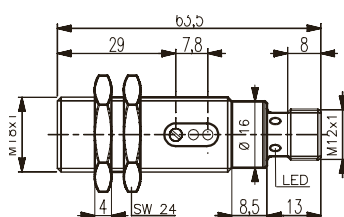

TYPE SELECTION IN ARTICLE ORDER

Art.-No.:	Description	Page
555001	IS-120-M5-10-S-Y7	8
556101	IS-120-M12-10-S-Y5	9
557101	IS-120-M18-10-S-Y5	10
557102	IS-120-M18H-10-S-Y5	13
559422	IS-120-C30H-10-S-Y7	12
559423	IS-120-C30-10-A-Y7	11

TYPE SELECTION IN TYPE DESCRIPTION ORDER

Art.-No.:	Description	Page
559423	IS-120-C30-10-A-Y7	11
559422	IS-120-C30H-10-S-Y7	12
555001	IS-120-M5-10-S-Y7	8
556101	IS-120-M12-10-S-Y5	9
557101	IS-120-M18-10-S-Y5	10
557102	IS-120-M18H-10-S-Y5	13

NOTES

All specifications are subject to change without notice. (05/2006)

SENSORS FOR INDUSTRIAL AUTOMATION

CAPACITIVE • INDUCTIVE MAGNETORESISTIVE CALORIMETRIC

Ask for further catalogues

CAPACITIVE SENSORS KAS

CAPACITIVE SENSORS KXS

INDUCTIVE SENSORS

MAGNETORESISTIVE SENSORS

POWER SUPPLIES AND CONTROLLERS

CAPACITIVE LEVEL MEASURING SYSTEMS

FLOW SENSORS

ATEX CERTIFIED PRODUCTS

Your Representative:



RECHNER

INDUSTRIE-ELEKTRONIK GmbH

Gaußstraße 8-10 68623 Lampertheim Germany

Tel. (0 62 06) 50 07-0 Fax (0 62 06) 50 07-36 Fax Intl. +49 (0) 62 06 50 07-20

www.rechner-sensors.de

e-mail: info@rechner-sensors.de