

FUJITSU

Halcyon XLTH



XLTH Series: Extra Low Temperature Heating Down to -15°F



Wall Mount Systems

9RLS3H, 12RLS3H, 15RLS3H
18RLXFWH, 24RLXFWH, 30RLXEH



Floor Mount Systems

9RLFFH, 12RLFFH, 15RLFFH



Multi-Zone Systems

AOU18RLXFZH, AOU24RLXFZH,
AOU36RLXFZH



*Not all heating systems are created equal.
Without the right technology, a system
won't work when its needed most.*

Protection from the Winter's Coldest Temperatures

When the temperature drops you don't want to be left in the cold. It's important to choose a heat pump system rated for the climate you live in. If your system doesn't operate in severe conditions you and your family could be left without any heat at all.

Fujitsu's line of mini-split heat pumps come in different sizes, styles, and rated outdoor temperatures. The Extra Low Temperature Heating (**xlTH**) Series features outdoor condensing units engineered to operate in temperatures down to -15°F, lower than any other mini-split available today.



Shown is an outdoor condensing unit used in a climate colder than it was rated for. Without the right technology, condensate freezes to the bottom of the unit and reduces its efficiency and heating output.

Ambient Heating Temperature of -15°F

Other models may go as low as -5°F, however they do not include a base heater and other advancements found in XLTH models.

Metal Fan Guard

While other models have a plastic fan guard, XLTH models use metal, which is most capable of withstanding the colder elements.

Base Heater

When temperatures reach 36°F, a built-in heater warms the base of the outdoor unit so that condensation doesn't freeze. Without a heater, freezing condensate can cause noise, damage to the fan blade, condenser, and system performance.

Base Drainage Holes

The cultivated base design discharges melted water through many holes located at the bottom of the unit.

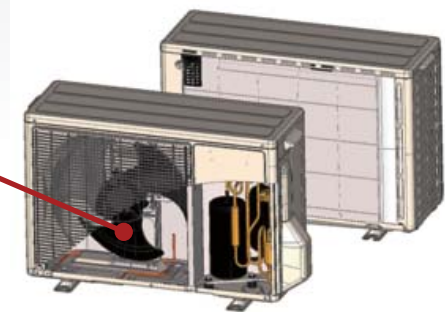

The base of Fujitsu's XLTH outdoor condensing units.

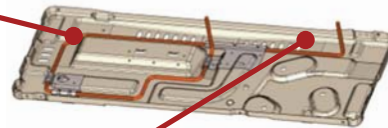

Improved Heating Capacity

Heating capacity at low outdoor temperatures was improved by adopting a large heat exchanger and a high capacity compressor.

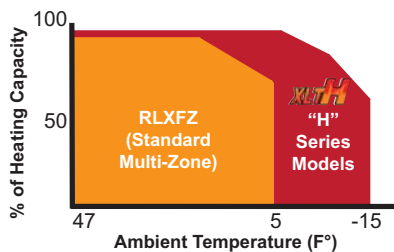

Have Peace of Mind with Fujitsu's XLTH Heat Pumps

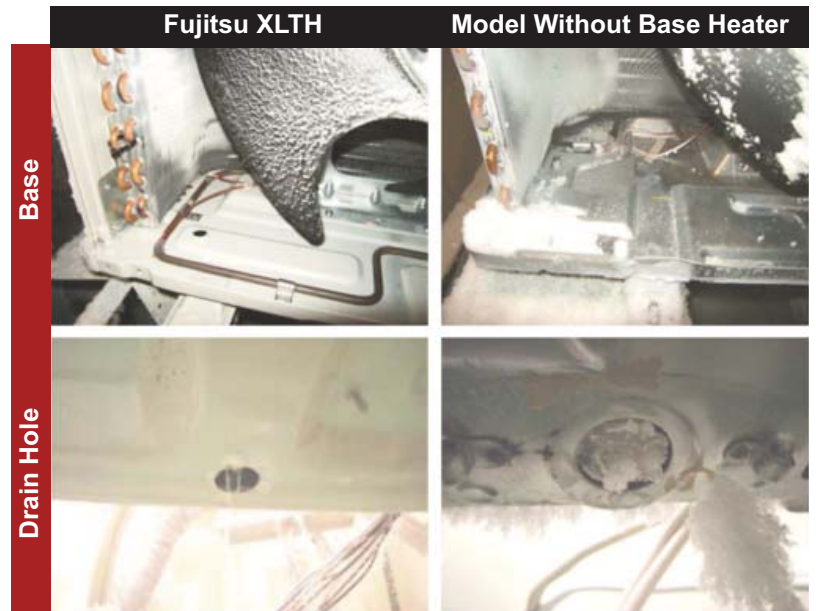

Drain hole is not filled, no freezing of base

Freezing where there is no heater

Condition: Indoor temp. of 68°FDB / outdoor temp. of 5°FDB, Heating mode, High airflow volume. Operation for 24 hours.

Wall Mounted High-SEER 9, 12 and 15,000 BTU Systems

Systems 9RLS3H, 12RLS3H, 15RLS3H



Indoor Models
ASU9RLS3
ASU12RLS3
ASU15RLS3



Outdoor Models
AOU9RLS3H
AOU12RLS3H
AOU15RLS3H

Energy Efficient

	9RLS3H	12RLS3H	15RLS3H
SEER	33.0	29.3	25.3
EER	18.0	15.2	13.9
HSPF	14.0	13.8	13.3

Among the World's Most Efficient Heat Pumps



Systems feature high efficiencies and are **ENERGY STAR® Qualified**, meaning lower utility bills for home and business owners.

Power Diffuser

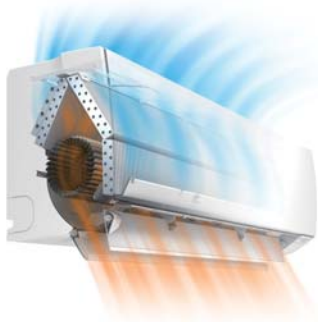

A power diffuser operates automatically in either heating or cooling mode to optimally control the airflow. A comfortable space is quickly achieved.



Cooling

During cooling mode, far reaching horizontal airflow quickly creates a comfortable space throughout the entire room.



Heating

During heating mode, vertical airflow provides comfortable floor level heating.

ESP Energy Saving Program

ESP knows how to save you money even when you forget. If you leave the room without turning the unit off, ESP knows that you left and 20 minutes later, set temperature is increased by 4°F when cooling and reduced by 8°F when heating. When you come back to the room, it returns to previous operating mode. This prevents wasteful operation to save energy without you having to think about it.

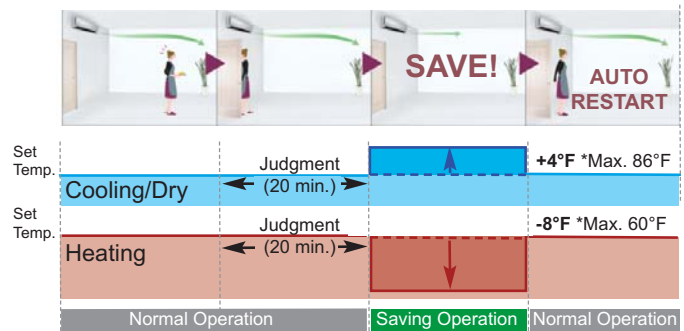

Standard Features

- Wireless Remote Control
- Economy Mode
- Apple Catechin Filter
- Energy Saving Program
- Ion Deodorizing Filter
- Quiet Mode (Indoor)
- Sleep Timer
- Low Noise Mode
- 24 Hour Timer
- 3rd Party Device Control+
- Weekly Timer
- Dry Mode
- Auto Louver: 4-Way
- Auto Mode
- Powerful Operation Mode
- Minimum Heat (50°F/10°C)
- Auto Restart/Reset
- Auto Changeover
- Low Ambient Cooling
- Cold Prevention
- Remote Temp. Sensor*



Designer wireless remote control

* Available only with optional wired remote controller and optional interface kit.
 + Available only with optional interface kit. Operation monitoring and On/Off control only.

Optional Accessories

- Wired Remote Controller: UTY-RVNUM
Backlit and includes room temperature
- Wired Remote Controller: UTY-RNNUM
- Simple Remote Controller: UTY-RSNUM
- Communication Kit: UTY-TWBXF1
- Dry Contact Wire Kit: UTY-XWZXZ5

Dimensions Inches (mm)

ASU9RLS3, ASU12RLS3, ASU15RLS3



AOU9RLS3H, AOU12RLS3H, AOU15RLS3H

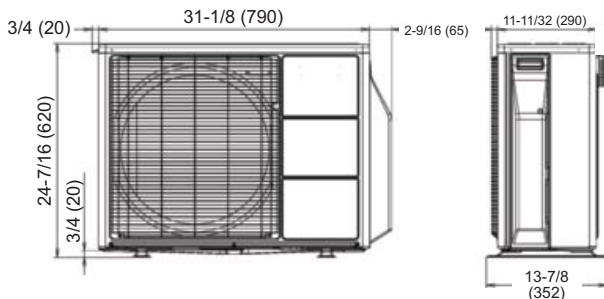

	9RLS3H Heat Pump	12RLS3H Heat Pump	15RLS3H Heat Pump
Nominal Cooling BTU/h	9,000	12,000	14,500
Min.~Max. Cooling BTU/h	3,100~12,000	3,100~13,600	3,100~18,400
Nominal Heating BTU/h	12,000	16,000	18,000
Min.~Max. Heating BTU/h	3,100~22,000	3,100~22,100	3,100~23,900
HSPF BTU/hW	14.0	13.8	13.3
SEER BTU/hW	33.0	29.3	25.3
EER Clg/Htg	18.0	15.2	13.9
Clg. Operating Range °F(°C)	14~115 (-10~46)	14~115 (-10~46)	14~115 (-10~46)
Htg. Operating Range °F(°C)	-15~75 (-26~24)	-15~75 (-26~24)	-15~75 (-26~24)
Moisture Removal Pt./h(l/h)	2.6 (1.2)	2.7 (1.3)	4.0 (1.9)
Voltage/Frequency/Phase	208-230/60/1	208-230/60/1	208-230/60/1
MAX.CRT.BKR (A)	15	15	20
Air Circ. C.F.M. (m³/h): Hi	489 (830)	489 (830)	489 (830)
Medium	400 (680)	400 (680)	459 (780)
Low	341 (580)	341 (580)	371 (630)
Quiet	224 (380)	224 (380)	Clg 259 (440) Htg 294 (500)
Noise Level dB(A) Clg/Htg: Hi	42/41	42/41	45/45
Medium	37/35	37/35	40/39
Low	32/31	32/31	34/33
Quiet	23/23	23/23	26/27
Outdoor Noise Level dB(A) Clg/Htg	42/47	43/47	49/50
Current Rated/Max (A): Cooling	2.5/9.4	3.8/9.4	4.8/9.9
Heating	3.3/10.0	4.7/11.9	5.2/13.9
Power Use Rated/Max (kw): Cooling	0.50/0.85	0.79/0.99	1.04/1.56
Heating	0.66/1.93	1.01/1.94	1.15/2.19
Fan Speeds Stage	4+Auto	4+Auto	4+Auto
Air Direction: Horizontal	Automatic	Automatic	Automatic
Vertical	Automatic	Automatic	Automatic
Air Filter	Washable	Washable	Washable
Connection Method	Flare	Flare	Flare
Combined Min. Lgth Ft (m)	10 (3)	10 (3)	10 (3)
Combined Max. Lgth Ft (m)	66 (20) (pre-charge: 49')	66 (20) (pre-charge: 49')	66 (20) (pre-charge: 49')
Max. Vertical Diff. Ft (m)	49 (15)	49 (15)	49 (15)
Conn. Pipe Diameter Inch	Suc.3/8 Dis.1/4	Suc.3/8 Dis.1/4	Suc.1/2 Dis.1/4
Net Weight lbs. (kg)	31 (14) 86 (39)	31 (14) 86 (39)	31 (14) 88 (40)
Dimensions: Height Inch	11-5/8 24-7/16	11-5/8 24-7/16	11-5/8 24-7/16
mm	295 620	295 620	295 620
Width Inch	37 31-1/8	37 31-1/8	37 31-1/8
mm	940 790	940 790	940 790
Depth Inch	10-5/8 11-7/16	10-5/8 11-7/16	10-5/8 11-7/16
mm	270 290	270 290	270 290
Refrigerant	R410A	R410A	R410A
	Indoor ASU9RLS3 Outdoor AOU9RLS3H	Indoor ASU12RLS3 Outdoor AOU12RLS3H	Indoor ASU15RLS3 Outdoor AOU15RLS3H

Note: Figures are based on 230 Volts.



Wall Mounted 18, 24 and 30,000 BTU Systems

Systems 18RLXFWH, 24RLXFWH, 30RLXEH



Indoor Models
ASU18RLF
ASU24RLF

Outdoor Models
AOU18RLXFWH
AOU24RLXFWH



Indoor Models
ASU30RLE

Outdoor Models
AOU30RLXEH

Stylish, slim and elegant, these wall mounted ductless heat pumps are designed for single rooms. These systems feature long piping lengths and low ambient heating and cooling, making them great for solving various application-specific problems. With more efficient zone control, ductless mini-splits are perfect for renovations, restorations, conversions, and add-ons.

Extended Line Set

Long piping lengths between indoor and outdoor units provides flexibility and increased applications.

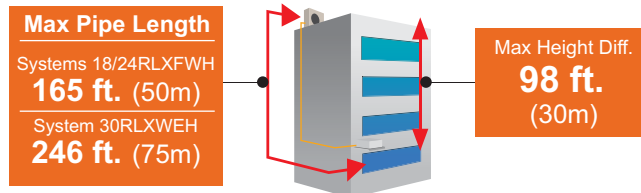

Energy Efficient

All systems feature high efficiencies and are **ENERGY STAR® Qualified**, meaning lower utility bills for home and business owners.



	18RLXFWH	24RLXFWH	30RLXEH
SEER	20.0	19.5	18.7
EER	10.4	10.5	12.5
HSPF	12.3	13.0	11.7

Optional Accessories

Controllers



Wired Remote[^]
UTY-RVNUM
Backlit and includes room temperature



Wired Remote (Touch Panel)[^] UTY-RNRUZ1[^]
Backlit and includes room temperature



Wired Remote[^]
UTY-RNNUM



Simple Remote[^]
UTY-RSNUM

Interface Kits

- **Dry Contact Wire Kit** UTY-XWZX
- **Interface Kit** UTY-XGSXZ1*
- **Interface Kit Box** UTY-GXXB*
- **Outdoor Unit Input/Output Connector** UTY-XWZXZ3*

*Compatible with System 30RLXEH only.

Lock Out Function

This feature is set by the contractor on behalf of the Commercial Property Owner to prevent either Cooling or Heating operation from occurring. This is not a function that can be set by a tenant, user, or home owner.

Lead Lag Control[^] for System 30RLXEH

- Alternate operation of systems
- Back up operation of redundant system
- Dual stage operation

[^] Wired remotes cannot be used when using this feature. This includes UTY-RNRUZ1, UTY-RVNUM, UTY-RNNUM, UTY-RSNUM.

Standard Features

- Wireless Remote Control
- Apple Catechin Filter
- Ion Deodorizing Filter
- Sleep Timer
- Weekly Timer
- Dry Mode
- Auto Louver: 4-Way
- Auto Mode
- Powerful Operation Mode*
- Minimum Heat (50°F/10°C)
- Economy Mode
- Energy Saving Program*
- Quiet Mode (*Indoor*)
- Low Noise Mode*
- Power Diffuser
- Auto Restart/Reset
- Auto Changeover
- Low Ambient Cooling
- Blue Fin Heat Exchanger
- Long Piping Length
- Base Pan Heater
- Third Party Device Control
- Cold Prevention
- Pump Down Operation*

*Applies to System 30RLXEH only.

Dimensions

ASU18RLF, ASU24RLF

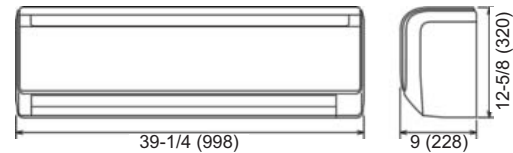

ASU30RLE

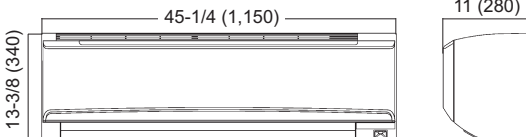

AOU18RLXFWH, AOU24RLXFWH

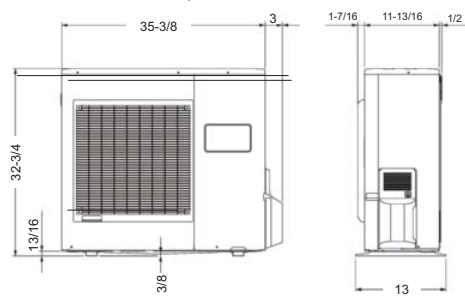

AOU30RLXEH

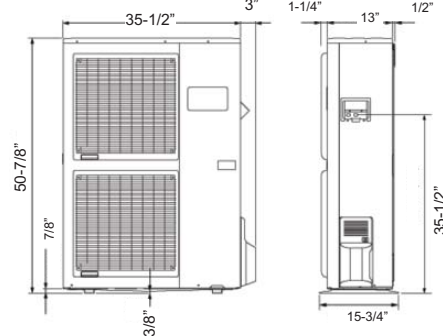

	18RLXFWH Heat Pump	24RLXFWH Heat Pump	30RLXEH Heat Pump
Nominal Cooling BTU/h	18,000	22,000	30,000
Min.~Max. Cooling BTU/h	7,000~23,000	9,900~27,300	9,900~32,400
Nominal Heating BTU/h	21,600	25,200	32,000
Min.~Max. Heating BTU/h	7,000~29,000	7,500~36,200	8,000~37,500
HSPF BTU/hW	10.4	10.5	11.7
SEER BTU/hW	20.0	19.5	18.7
EER Clg	13.3	12.5	12.5
Clg. Operating Range °F(°C)	-5~-115 (-20~46)	-5~-115 (-20~46)	-5~-115 (-20~46)
Htg. Operating Range °F(°C)	-15~-75 (-26~24)	-15~-75 (-26~24)	-15~-75 (-26~24)
Moisture Removal Pt./h(l/h)	5.9 (2.8)	6.3 (3.0)	9.7 (4.6)
Voltage/Frequency/Phase	208-230/60/1	208-230/60/1	208-230/60/1
MAX.CRT.BKR (A)	20	20	30
Air Circ. C.F.M. Clg/Htg (m³/h): Hi	541 (920)	659 (1,120) / 677 (1,150)	812 (1,380)
Medium	435 (740)	530 (900)	665 (1,130)
Low	365 (620)	435 (740)	536 (910)
Quiet	306 (520) / 318 (540)	365 (620)	418 (710)
Noise Level dB(A) Clg/Htg: Hi	43/44	49/49	50/49
Medium	37/37	42/42	45/44
Low	33/33	37/37	38/38
Quiet	28/28	33/33	32/32
Outdoor Noise Level dB(A) Clg/Htg	47/50	54/55	53/54
Current Rated (A): Cooling	6.2	7.9	10.6
Heating	7.8	8.6	12.0
Power Use Rated/Max (kw): Cooling	1.35/3.01	1.76/3.42	2.40/3.83
Heating	1.75/3.23	1.94/3.53	2.74/4.28
Fan Speeds Stage	4+Auto	4+Auto	4+Auto
Air Direction: Horizontal	Automatic	Automatic	Automatic
Vertical	Automatic	Automatic	Automatic
Air Filter	Washable	Washable	Washable
Connection Method	Flare	Flare	Flare
Combined Min. Lgth Ft (m)	16 (5)	16 (5)	16 (5)
Combined Max. Lgth Ft (m)	164 (50) (pre-charge: 65')	164 (50) (pre-charge: 65')	246 (75) (pre-charge: 65')
Max. Vertical Diff. Ft (m)	98 (30)	98 (30)	98 (30)
Conn. Pipe Diameter Inch	Suc.3/8 Dis.5/8	Suc.3/8 Dis.5/8	Suc.3/8 Dis.5/8
Net Weight lbs. (kg)	31 (14) 135 (61)	31 (14) 135 (61)	40 (18) 205 (93)
Dimensions: Height Inch	12-5/8 32-3/4	12-5/8 32-3/4	13-3/8 50-13/16
mm	320 830	320 830	340 1,290
Width Inch	39-1/4 35-3/8	39-1/4 35-3/8	45-1/4 35-3/8
mm	998 900	998 900	1,150 900
Depth Inch	9 13	9 13	11 13
mm	228 330	228 330	280 330
Refrigerant	R410A	R410A	R410A

Indoor	ASU18RLF	Indoor	ASU24RLF	Indoor	ASU30RLE
Outdoor	AOU18RLXFWH	Outdoor	AOU24RLXFWH	Outdoor	AOU30RLXEH

Note: Figures are based on 230 Volts.



Floor Mounted 9, 12, 15,000 BTU Systems

Systems 9RLFFH, 12RLFFH, 15RLFFH



Indoor Models
AGU9RLF
AGU12RLF
AGU15RLF



Outdoor Models
AOU9RLFFH
AOU12RLFFH
AOU15RLFFH

Floor mount systems are ideal for residential radiator replacements or any room with limited upper wall space, like a kitchen or sunroom.

- Compact size
- Available in 9, 12, or 15,000 BTU single zone models
- Heat pumps provide both cooling and heating
- Feature twin airflow for improved heat delivery
- Designer remote control



At less than 24" high and 30" wide, floor mount models fit easily under a standard window and can replace a radiator twice its size while producing more capacity.

Features

2-Fan and Wide Airflow

Having both upper and lower airflow quickly warms or cools the entire room. Floor mount can be set in "Upward Airflow Only" when occupants wish not to have feet warmed or cooled.

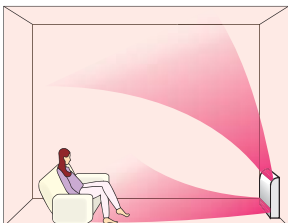

Flexible and Easy Installation

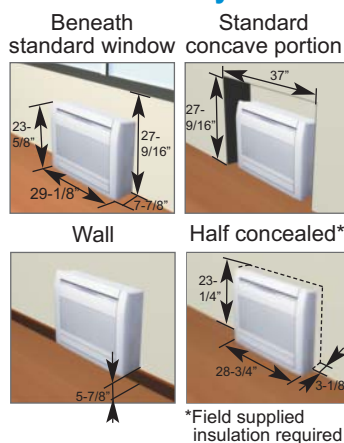

Energy Efficient

All systems feature high efficiencies and are **ENERGY STAR® Qualified**, meaning lower utility bills for home and business owners.



Up to 26.0 SEER

	9RLFFH	12RLFFH	15RLFFH
SEER	26.0	22.7	20.3
EER	16.0	13.1	12.5
HSPF	12.4	11.3	11.0

Standard Features

- Wireless Remote Control
- Apple Catechin Filter
- Ion Deodorizing Filter
- Sleep Timer
- 24-Hour Timer
- Auto Louver: Up/Down
- Auto Mode
- Minimum Heat Mode
- Economy Mode
- Auto Restart/Reset
- Auto Changeover
- Powerful Mode
- Quiet Mode (Indoor)
- Dry Mode
- Cold Prevention
- Remote Temp. Sensor



Optional Accessories

- Wired Remote Controller: UTY-RVNUM
Backlit and includes room temperature
- Wired Remote Controller: UTY-RNNUM
- Simple Remote Controller: UTY-RSNUM
- Dry Contact Wire Kit: UTY-XWZXZ5

Dimensions

AGU9RLF, AGU12RLF, AGU15RLF

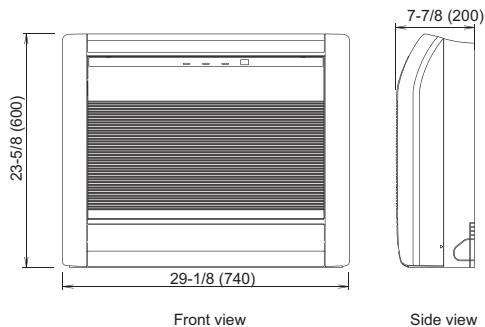

AOU9RLFFH, AOU12RLFFH, AOU15RLFFH

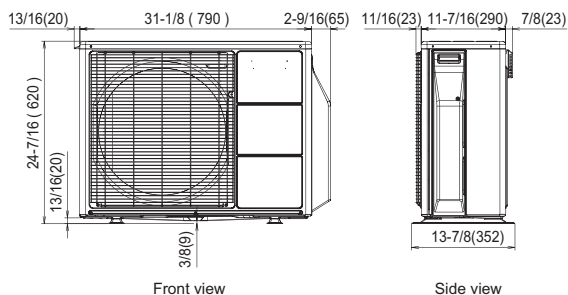

	9RLFFH Heat Pump	12RLFFH Heat Pump	15RLFFH Heat Pump
Nominal Cooling BTU/h	9,000	12,000	14,200
Min.~Max. Cooling BTU/h	3,100~13,000	3,100~14,300	3,100~17,700
Nominal Heating BTU/h	12,000	16,000	18,000
Min.~Max. Heating BTU/h	3,100~18,800	3,100~19,500	3,100~20,800
HSPF BTU/hW	12.4	11.3	11.0
SEER BTU/hW	26.0	22.7	20.3
EER Clg/Htg	16.0/13.6	13.1/11.1	12.5/11.3
Clg. Operating Range °F(°C)	14~115 (-10~46)	14~115 (-10~46)	14~115 (-10~46)
Htg. Operating Range °F(°C)	-15~75 (-26~24)	-15~75 (-26~24)	-15~75 (-26~24)
Moisture Removal Pt./h(l/h)	2.75 (1.3)	3.8 (1.8)	4.44 (2.1)
Voltage/Frequency/Phase	208-230/60/1	208-230/60/1	208-230/60/1
Recommended Fuse Size (A)	15	15	20
Air Circ. C.F.M. (m ³ /h): Hi	335 (570)	335 (570)	383 (650)
Medium	271 (460)	271 (460)	306 (520)
Low	212 (360)	212 (360)	235 (400)
Quiet	159 (270)	159 (270)	159 (270)
Noise Level dB(A)Clg/Htg: Hi	40/40	40/40	44/43
Medium	35/35	35/35	38/37
Low	29/29	29/29	31/29
Quiet	23/23	23/23	23/23
Outdoor Noise Level dB(A) Clg/Htg	50/50	52/52	54/54
Current Rated (A): Cooling	2.9	4.2	5.1
Heating	4.1	6.7	7.0
Power Use Rated (kw): Cooling	.56	.97	1.13
Heating	.88	1.44	1.58
Fan Speeds Stage	4+Auto	4+Auto	4+Auto
Air Direction: Horizontal	Manual	Manual	Manual
Vertical	Auto	Auto	Auto
Air Filter	Washable	Washable	Washable
Apple Catechin Filter	Yes	Yes	Yes
Ion Deodorizing Filter	Yes	Yes	Yes
Connection Method	Flare	Flare	Flare
Combined Min. Lgth Ft (m)	10 (3)	10 (3)	10 (3)
Combined Max. Lgth Ft (m)	66 (20)	66 (20)	66 (20)
(pre-charge: 49') (pre-charge: 49') (pre-charge: 49')			
Max. Vertical Diff. Ft (m)	49 (15)	49 (15)	49 (15)
Conn. Pipe Diameter Inch	Suc. 3/8 Dis. 1/4	Suc. 3/8 Dis. 1/4	Suc. 1/2 Dis. 1/4
Net Weight lbs. (kg)	31 (14)	86 (39)	31 (14)
Dimensions: Height Inch	23-5/8	24-7/16	23-5/8
mm	600	620	600
Width Inch	29-1/8	31-1/8	29-1/8
mm	740	790	740
Depth Inch	7-7/8	11-7/16	7-7/8
mm	200	290	200
Refrigerant	R410A	R410A	R410A

Indoor AGU9RLF Outdoor AOU9RLFFH Indoor AGU12RLF Outdoor AOU12RLFFH Indoor AGU15RLF Outdoor AOU15RLFFH

Note: Figures are based on 230 Volts.



Multi-Zone 18, 24, 36,000 BTU Systems

Models AOU18RLXFZH, AOU24RLXFZH, AOU36RLXFZH

Connect 2 to 4 indoor units, depending on model



Outdoor Models

AOU18RLXFZH
AOU24RLXFZH
AOU36RLXFZH

Indoor Models



Wall Mounts
ASU7RLF1
ASU9RLF1
ASU12RLF1
ASU18RLF



Floor Mounts
AGU9RLF
AGU12RLF
AGU15RLF



Slim Ducts
ARU7RLF
ARU9RLF
ARU12RLF
ARU18RLF



Compact Cassettes
AAU7RLF
AAU9RLF
AAU12RLF
AAU18RLF

Individual Zoning Control

Why pay to heat or cool areas that no one is occupying? Halcyon systems can have as many as eight indoor air handlers (covering eight zones or areas) connected to one outdoor unit. Since each of the zones will have its own thermostat, you only heat or cool the areas you want, and not the areas that are unoccupied.

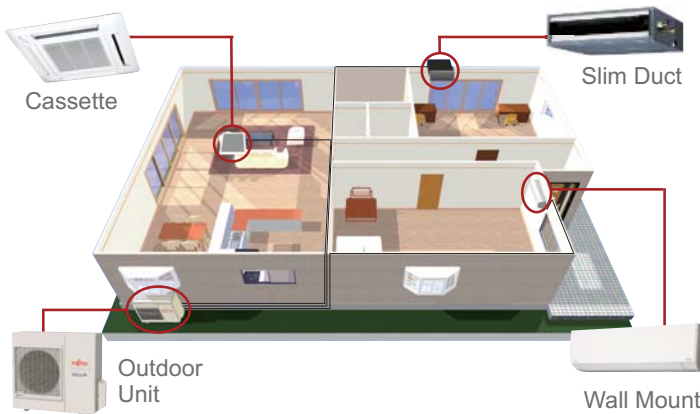

Indoor Model Compatibility

● AOU18RLXFZH ● AOU24RLXFZH ● AOU36RLXFZH

kBTU/h	Wall Mount (ASU)	Floor Mount (AGU)	Slim Duct (ARU)	Compact Cassette (AAU)
7	● ● ●		● ● ●	● ● ●
9	● ● ●	● ● ●	● ● ●	● ● ●
12	● ● ●	● ● ●	● ● ●	● ● ●
15		● ●		
18	● ●		● ●	● ●

Nominal Capacities, SEER and HSPF Ratings

Data below is based on AHRI 210/240 non-ducted wall mounted models.

Model	Indoor Unit		Cooling Capacity Btu/h	EER	SEER	Heating Rated Capacity Btu/h		Heating Maximum Capacity Btu/h		COP	HSPF
	Type	Combination				47 F	17 F	17 F	5 F		
AOU18RLXFZH	Non-Ducted	9+9	18,000	13.5	21.5	22,000	14,200	23,600	22,000	3.79	10.3
	Ducted	9+9	18,000	12.4	19.0	22,000	14,200	23,600	22,000	3.60	9.0
	Mixed	9+9	18,000	13.0	20.3	22,000	14,200	23,600	22,000	3.70	9.7
AOU24RLXFZH	Non-Ducted	9+7+7	22,000	13.3	20.0	25,000	15,400	26,400	25,000	4.04	10.3
	Ducted	9+7+7	22,000	12.1	18.0	25,000	15,400	26,400	25,000	3.87	9.0
	Mixed	9+7+7	22,000	12.7	19.0	25,000	15,400	26,400	25,000	3.96	9.7
AOU36RLXFZH	Non-Ducted	9+9+9+9	35,200	13.0	20.0	36,400	21,400	39,300	36,400	4.00	10.3
	Ducted	9+9+9+9	35,200	12.0	18.0	36,400	21,400	39,300	36,400	3.88	9.3
	Mixed	9+9+9+9	35,200	12.5	19.0	36,400	21,400	39,300	36,400	3.93	9.8

Yellow rows represent models that are ENERGY STAR® qualified.

Dimensions

AOU18RLXFZH, AOU24RLXFZH

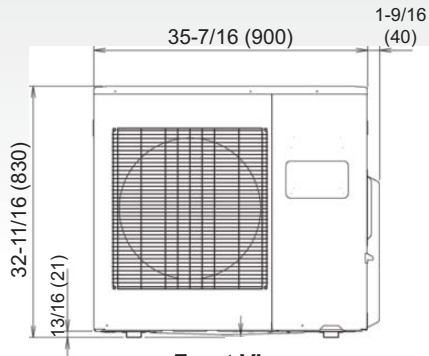

Front View

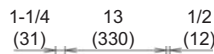

Side View

AOU36RLXFZH

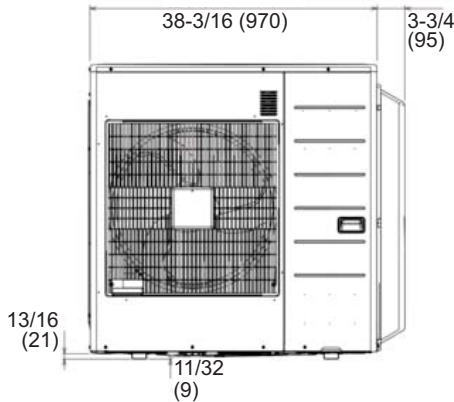

Front View

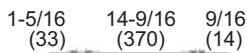

Side View



Side View

	AOU 18RLXFZH Heat Pump	AOU 24RLXFZH Heat Pump	AOU 36RLXFZH Heat Pump
Connectable Indoor Unit Number	2	2 to 3	2 to 4
Connectable Unit Capacity Class BTU/h	14,000 to 21,000	14,000 to 27,000	27,000 to 39,000
Rated Capacity Cooling/Heating BTU/h	18,000/22,000	22,000/25,000	35,200/36,400
Clg. Operating Range °F(°C)	14 to 115 (-10 to 46)	14 to 115 (-10 to 46)	14 to 115 (-10 to 46)
Htg. Operating Range °F(°C)	-15 to 75 (-26 to 24)	-15 to 75 (-26 to 24)	-15 to 75 (-26 to 24)
Input Power: Clg/Htg Rated kW*	1.33/1.70	1.65/1.81	2.70/2.67
Voltage/Frequency/Phase	208-230/60/1	208-230/60/1	208-230/60/1
Current: Total Max. (A)	16.4	20.8	26.0
Minimum Circuit Ampacity (A)	19.7	25.1	31.5
MAX.CRT.BKR (A)	20	30	40
Fan: Type x Quantity	Propeller x 1	Propeller x 1	Propeller x 1
Sound Pressure Level Cooling dB(A)	48	50	53
Sound Pressure Level Heating dB(A)	50	52	55
Pre-Charge Length Total Ft (m)	98 (30)	98 (30)	164 (50)
Max. Length Total Ft (m)	164 (50)	230 (70)	230 (70)
Max. Length Each Ft (m)	82 (25)	82 (25)	82 (25)
Min. Length Total Ft (m)	49 (15)	49 (15)	49 (15)
Min. Length Each Ft (m)	16 (5)	16 (5)	16 (5)
Max. Pipe Height Difference Between Outdoor Unit & Farthest Indoor Ft (m)	49 (15)	49 (15)	49 (15)
Max. Pipe Height Difference Between Indoor Units Ft (m)	33 (10)	33 (10)	33 (10)
Connection Method	Flare	Flare	Flare
Conn. Pipe Diameter Inch	Liq. 1/4 x 2 Suc. 3/8 x 2	Liq. 1/4 x 3 Suc. 1/2 x 1, 3/8 x 2	Liq. 1/4 x 4 Suc. 1/2 x 1, 3/8 x 3
Net Weight lbs. (kg)	134 (61)	146 (66)	205 (93)
Dimensions: Height Inch	32-11/16	32-11/16	39-5/16
mm	830	830	998
Width Inch	35-7/16	35-7/16	38-3/16
mm	900	900	970
Depth Inch	13	13	14-9/16
mm	330	330	370
Refrigerant	R410A	R410A	R410A



Allowable Combinations

for AOU18RLXFZH, AOU24RLXFZH, AOU36RLXFZH

XLTH
18, 24, 36,000 BTUs



ASU7RLF1, ASU9RLF1,
ASU12RLF1, ASU18RLF,
ASU24RLF



ARU7RLF
ARU9RLF
ARU12RLF
ARU18RLF
ARU24RLF



AUU7RLF
AUU9RLF
AUU12RLF
AUU18RLF



AGU9RLF
AGU12RLF
AGU15RLF



AOU18RLXFZH
AOU24RLXFZH
AOU36RLXFZH

BTU Capacity 7,000 9,000 12,000 15,000 18,000 24,000

AOU18RLXFZH		
2 INDOOR UNITS	7 7	14
	7 9	16
	7 12	19
	9 9	18
	9 12	21

AOU24RLXFZH		
3 INDOOR UNITS	7 7 -	14
	7 9 -	16
	7 12 -	19
	7 15	22
	7 18	25
	9 9 -	18
	9 12	21
	9 15	24
	9 18	27
	12 12	24
	12 15	27
	7 7 7	21
	7 7 9	23
7 7 12	26	
7 9 9	25	
9 9 9	27	

AOU36RLXFZH		
4 INDOOR UNITS	18*18*	36
	7 7 15 -	29
	7 7 18 -	32
	7 7 24	38
	7 9 12 -	28
	7 9 15 -	31
	7 9 18	34
	7 12 12 -	31
	7 12 15	34
	7 12 18	37
	9 9 9 -	27
	9 9 12 -	30
	9 9 15	33
	9 9 18	37
	9 12 12	33
	9 12 15	36
9 12 18	39	
12 12 12	36	

AOU36RLXFZH		
4 INDOOR UNITS	12 12 15	39
	7 7 7 7	28
	7 7 7 9	30
	7 7 7 12	33
	7 7 7 15	36
	7 7 7 18**	39
	7 7 9 9	32
	7 7 9 12	35
	7 7 9 15	38
	7 7 12 12	38
	7 9 9 9	34
9 9 9 9	36	

* The optional kit "K9FZ1818 (UTP-MU36A2)" is necessary for dual zone system "18+18".
 **Wall mounted type ASU18RLF cannot be connected in this combination.
 "-" represents available circuit for future expansion when connecting this combination.



Applications



Where can mini-splits be used?

- Convenience stores
- Fast food chains
- Fire houses
- Police stations
- Oil rigs
- Bars
- Sunrooms and additions
- Warehouses
- Nursing homes
- Small offices
- Older homes
- New construction homes
- Schools
- Places of worship
- Hospitals and medical facilities
- Restaurants
- Computer rooms
- Hotels and motels
- Car washes
- ATM vestibules



Just about any place that requires comfort!



4 Indoor Model Styles to Choose From

Halcyon systems are some of today's most advanced forms of heating and air conditioning, being super quiet, as well as highly energy efficient. With 4 indoor unit styles to choose from, there's a Halcyon system to fit every décor .

Wall Mounted

They mount high on a wall, out of sight and do not require ductwork, increasing energy efficiency.

- Quiet operation
- Easy maintenance
- High delivered efficiency means lower utility bills

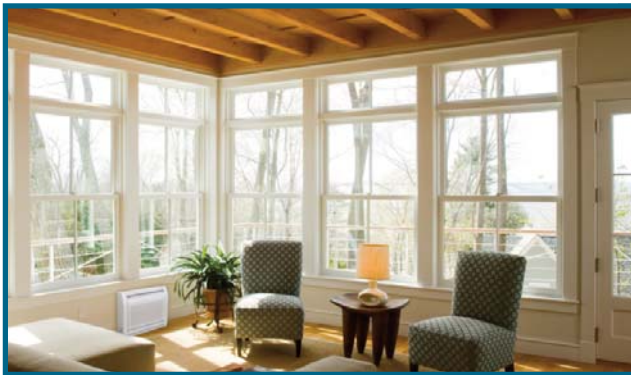

Floor Mounted

Floor mount systems are ideal for residential radiator replacements or any room with limited upper wall space, like a kitchen or sunroom.

- Compact size fits easily under a standard window
- Features twin airflow for improved heat delivery
- Designer wireless remote control

Compact Cassette

Cassettes are extremely discreet, with only the grille showing in the ceiling. They use the latest fan technology to distribute the conditioned air evenly.

- Wired remote control (wireless is optional)
- Powerful turbo fan operation
- Fits into a standard 2' x 2' ceiling grid

Available in XLTH series as Multi-zone only.

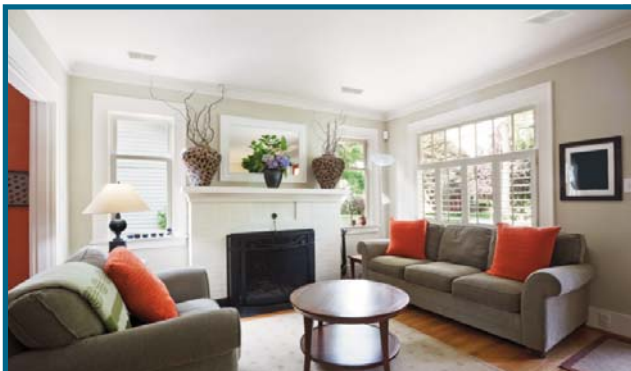

Slim Duct

Mounted in a ceiling or in a framed enclosure below a ceiling. They use minimal ductwork and remain very energy efficient.

- Concealed and out of sight
- Look of central air with the efficiency of a mini-split
- Less ducts = higher efficiency

Available in XLTH series as Multi-zone only.

Optional Accessories

Remote Controls (Compatible with RLS3H, RLXFWH, RLXEH and RLFFH Series)

Wired Remote Controller UTY-RNNUM



The wired remote controller with its unique lock function and sleek design provides full feature access to property managers, building owners, and facility maintenance, as well as providing basic comfort features to tenants, employees, and teachers.

Wired Remote Controller UTY-RVNUM



Features a large backlit LCD display and displays the room temperature. Provides full feature access to property managers, building owners, and facility maintenance, as well as providing basic comfort features to tenants, employees, and teachers.

Simple Remote Controller UTY-RSNUM



Suitable when only basic operations are required for hotels, offices and other places where there is frequent arrival and departure of occupants. Remote does not allow any timer settings.

Touch Panel Remote Control (Compatible with System 30RLXEH)

Wired Remote (Touch Panel) UTY-RNRUZ1



Features a large backlit LCD display and displays the room temperature. Provides full feature access to property managers, building owners, and facility maintenance, as well as providing basic comfort features to tenants, employees, and teachers.

Dry Contact Kit (Compatible with RLS3H and RLFFH Series)

Dry Contact Wire Kit UTY-XWZXZ5



Turns system on or off using a normally open circuit. For example in home automation, BMS integration of only On/Off operation, occupancy sensor, key card switch, or lead-lag control of other heating/cooling devices.

Interface Kit (Compatible with RLS3H Series)

Interface Kit UTY-TWBXF1



Required to connect the ASU9RLS3, ASU12RLS3 and ASU15RLS3 to Wired Remotes UTY-RNNUM and UTY-RVNUM, Dry Contact Wire Kit UTY-XWZXZ5, and Simple Remote Control UTY-RSNUM.

Interface Kit (Compatible with RLXFWH and RLXEH Series)

Dry Contact Wire Kit* UTY-XWZX



Turns system on or off using a normally open circuit. For example in home automation, BMS integration of only On/Off operation, occupancy sensor, key card switch, or lead-lag control of other heating/cooling devices.

Interface Kits (Compatible with System 30RLXEH)

Interface Kit UTY-XCSXZ1



Required to connect ASU30RLE to Wired Touch Panel Remote UTY-RNRUZ1, Wired Remote UTY-RVNUM, Wired Remote UTY-RNNUM, Simple Remote UTY-RSNUM, Dry Contact Wire Kit UTY-XWZX, and Lead Lag Control function[^].

Interface Kit Box UTY-GXXB

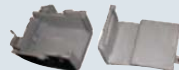

Used to conceal Interface Kit UTY-XCSXZ1.

Outdoor Unit Input/Output Connector UTY-XWZXZ3



Gives the ability to limit the noise of the unit*, stop the outdoor unit, limit power consumption*, control the operating mode (Htg/Clg), or use output status to see if the compressor is running. You will need to order a kit for each option.

*Will reduce capacity.

Multi-Zone Indoor Model Accessories (Compatible with AOU18/24/36RLXFZH)

Small Wall (RLF1 - 7, 9, 12k BTU)
Large Wall (18k BTU)
Cassette
Slim Duct
Floor Mount

Remote Controls		Small Wall (RLF1 - 7, 9, 12k BTU)	Large Wall (18k BTU)	Cassette	Slim Duct	Floor Mount
UTY-RNNUM	Wired Remote Control	•	•			•
UTY-RVNUM	Wired Remote Control	• ¹	• ¹	• ¹	• ¹	• ¹
UTY-RSNUM	Simple Remote Control	•	•	•	•	•
UTY-LNHUM	Wireless Remote Control			•		
UTY-XSZX	Remote Sensor				•	
UTY-LRHUM	Receiver Unit				•	
Interface Kits						
UTY-XWZX	Dry Contact Wire Kit		•	•		
UTY-XWZXZ5	Dry Contact Wire Kit	•				•
UTY-XCBXZ2	Interface Kit	•				
UTD-ECS5A	Slim Duct Connector Kit				•	
Fresh Air Intake Kits						
UTZ-KXGC	High Humidity Insulation Kit			•		
UTR-YDZB	Air Outlet Shutter Plate			•		
UTZ-VXAA	Fresh Air Intake Kit			•		
Miscellaneous						
K3PST	3-Pole Single Throw Safety Switch	•	•	•	•	•
UTD-GXSA-W	Auto Louver Grille Kit (for ARU9, 12)					•
UTD-GXSB-W	Auto Louver Grille Kit (for ARU18)					•

* Wall mounted ASU7, 9, and 12RLF1 require accessory interface kit #UTY-XCBXZ2 in order to connect these devices to them.

¹ Only multi-zone models greater than specific serial numbers are compatible with UTY-RVNUM. See Service Bulletin 0031 for serial number compatibility.

[^] Wired remotes cannot be used when using this feature. This includes UTY-RNRUZ1, UTY-RVNUM, UTY-RNNUM, UTY-RSNUM.

Halcyon It's Green and It's In There!



Year Round Comfort	Heat pumps provide both heating and cooling for year round comfort in most climates.
Cruise Control	Compressors only run as fast as they need to handle the cooling or heating demand.
Clean Air	High performance filters remove dust, odor and improve indoor air quality.
Timer	24-hour programmable timer allows for on/off cycle control of system.
Earth Friendly	Low ozone depleting potential (ODP) refrigerant R410a used in all models.
Oscillating Fan	Auto Louver redirects airflow with up and down.
Savings	High energy efficiencies slash utility bills by up to 25%.
Rebates	Many utility companies offer rebates for installing energy efficient equipment.

The Fujitsu logo is a registered trademark of Fujitsu Limited. The Halcyon logo and name is a trademark of Fujitsu General America, Inc. Copyright 2016 Fujitsu General America, Inc. Fujitsu's products are subject to continuous improvements. Fujitsu reserves the right to modify product design, specifications and information without notice and without incurring any obligations.

FUJITSU

Fujitsu General America, Inc.
 353 Route 46 West
 Fairfield, NJ 07004
 Tel: (973) 575-0380
 Email: hvac@fujitsugeneral.com
 www.fujitsugeneral.com

Distributed by:

Distributed by:



Renewed by the Son, Inc.
 42 High Street
 Erving, MA 01344
 (413) 423-4008
www.RenewedbytheSon.com



Printed in the USA Rev. 6/2016
 Part #6-26-FG2056