



94 Jackson Road Suite 110 Devens , MA 01434-4012 USA

Power Dividers / Combiners

Model RMPD2.225-450Sf

2-Way Power Divider SMA Female

Electrical Specifications:

Frequency (MHz)	Insertion Loss (dB) typ/max	Isolation (dB) typ/min	VSWR (typ/max)	Phase Balance (°)	Amplitude Balance (dB)
225 - 450	0.15/0.35	25/20	1.5:1/1.3:1	2	0.2

Mechanical Specifications:

Length Body	Width Body	Height Body
25.1mm (1.0")	38mm (1.5")	11mm (0.45")

Notes:

- Input and output impedance: 50 Ohms
- Connectors: SMA Female
- Power Handling: ≤ 100 Watt max Input ≤ 1.0 Watt Output
- Housing Material: Aluminum Alloy w/iridite or paint
- Marking: Laser engraved or label
- Operation temperature: -35°C to $+80^{\circ}\text{C}$ deg
- RoHS Compliant to Council Directive 2002/95/EC*

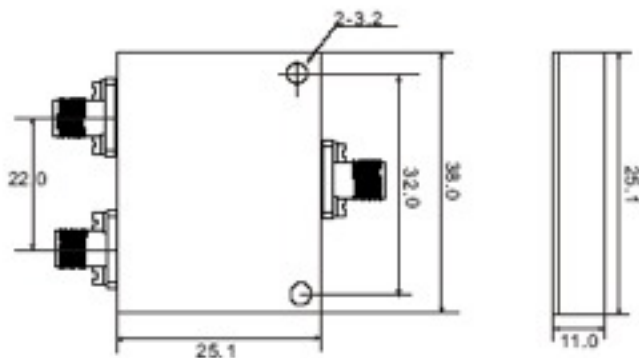

All specifications are subject to change without notice.

Telephone: 978-772-3767

Fax: 978-772-3768

www.responsemicrowave.com