



94 JACKSON ROAD, SUITE 110, DEVENS, MA 01434

Coaxial Attenuator

Model RMAT10.40000.292mf

Fixed Attenuator

FREQUENCY (MHz)	ATTENUATION (dB max)	POWER (Watt) (avg/pk)	IMPEDANCE (Ω)	VSWR (max)
DC – 40000	10 +/- 1.0	1 / 10	50	1.40 : 1

Notes:

- a. Weight: 5grams
- b. Connector: 2.92mm male/female
- c. Operation temperature: -55C to +125C deg
- d. Case material: Stainless Steel/ passivate
- e. Insert desired attenuation value at "xx" in P/N

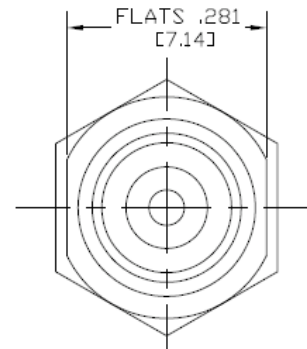
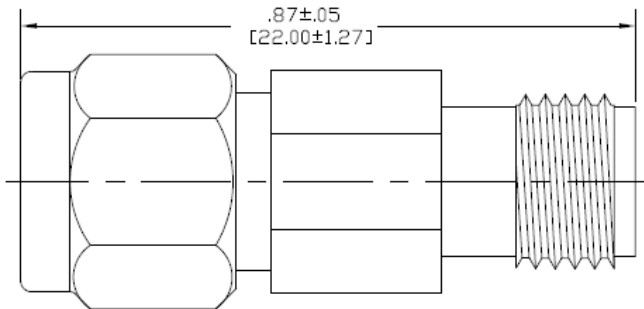

All specifications are subject to change without notice.

Dimensions: inches

Telephone: 978-772-3767

Fax: 978-772-3768

www.responsemicrowave.com