

TABLE OF CONTENTS

INTRODUCTION.....	B1
Formed SEMIRIGID Assemblies.....	B2
Custom Right-Angle Assemblies.....	B2
Clocking.....	B3
How to Order Cable Assemblies.....	B3
Cable Markers.....	B3
Designators for Cable Assemblies.....	B4-B5
Color Coding and Strain Reliefs.....	B6
Special Orders.....	B6
Testing and Certification.....	B6
COAXIAL CABLE CHARACTERISTICS.....	B7
STANDARD SEMIRIGID ASSEMBLIES.....	B8-B10
PRACTICAL LOW LOSS FLEXIBLE CABLES.....	B11
40 GHz PRACTICAL LOW-LOSS TEST CABLES.....	B12
ULTRA LOW-LOSS PREMIUM FLEXIBLE CABLES	
2.9 mm Male Plug x 2.9 mm Male Plug.....	B13
SMA Male Plug x SMA Male Plug.....	B13
SMA Male Plug x SMA Right Angle Plug.....	B13
EXTENDED DISTANCE QUIET CABLE PIN CONNECTIONS.....	B14
RS-232 STYLE SHIELDED CABLE ASSEMBLIES.....	B15
COAXIAL CABLE PERFORMANCE CHARACTERISTICS.....	B16-B17
POWER CONVERSION TABLE.....	B18
ALLIGATOR CLIPS X BNC MALE PLUG.....	B19
BANANA PLUG x BANANA PLUG.....	B19
BANANA PLUG x UHF MALE PLUG.....	B20
BANANA PLUG x BNC MALE PLUG.....	B20
BNC FEMALE BULKHEAD JACK	
x BNC Male Plug.....	B21
x SMA Male Plug (Flexible).....	B22
x SMA Male Plug SEMIRIGID.....	B23
x SMA Right Angle Male Plug (Flexible).....	B24
x SMA Right Angle Male Plug.....	B25
x SMA Right Angle Male Plug (Commercial).....	B26
BNC FEMALE JACK	
x BNC Female Jack.....	B27
x BNC Male Plug.....	B28
BNC MALE PLUG	
x BNC Male Plug (Flexible).....	B29
x BNC Male Plug SEMIRIGID.....	B30
x BNC Right Angle Male Plug.....	B31
x GR 874.....	B32
x HN Male Plug.....	B32
x N Female Jack.....	B33
x N Male Plug (Flexible).....	B34
x N Male Plug (Low Loss Flexible).....	B35
x SMA Male Plug.....	B36
x SMA Reverse Polarity Female Bulkhead Jack.....	B37
x SMA Reverse Polarity Male Plug.....	B37
x SMA Right Angle Plug.....	B38
x SMB Female Plug.....	B39
x SMB Right Angle Female Plug.....	B39
x SMC Female Plug.....	B40
x SMC Right Angle Female Plug.....	B40
x SSMB Female Plug.....	B41



TABLE OF CONTENTS

x SSMC Female Plug.....	B42
x TNC Male Plug.....	B43
x UHF Male Plug.....	B44
BNC RIGHT ANGLE MALE PLUG x BNC RIGHT ANGLE MALE PLUG.....	B45
C MALE PLUG x C MALE PLUG.....	B46
F MALE PLUG	
x F MALE PLUG.....	B47
x 75 Ω BNC MALE PLUG.....	B47
GR 874 MALE PLUG	
x GR 874 Male Plug.....	B48
x N Male Plug.....	B48
HN MALE PLUG x HN MALE PLUG.....	B49
LC MALE PLUG x LC MALE PLUG.....	B50
LFU x LFU.....	B50
LFU CABLE ASSEMBLIES	
x SMA Bulkhead Jack.....	B51
x SMA Male Plug.....	B51
x MCX Male Plug.....	B51
x MMCX Male Plug.....	B51
MCX FEMALE BULKHEAD JACK X MCX MALE PLUG.....	B52
MCX MALE PLUG	
x MCX Male Plug.....	B53
x MCX Right Angle Male Plug.....	B54
x SMA Male Plug.....	B55
x TNC 4 Hole Panel Jack.....	B56
MCX RIGHT ANGLE MALE PLUG X MCX RIGHT ANGLE MALE PLUG.....	B57
MHV MALE PLUG	
x MHV Male Plug.....	B58
x SHV Male Plug.....	B59
MINI-UHF FEMALE JACK X MINI UHF MALE PLUG.....	B60
MINI-UHF MALE PLUG	
x Mini-UHF Male Plug.....	B61
x N Male Plug.....	B61
x SMA Male Plug.....	B62
x TNC Male Plug.....	B62
MMCX FEMALE BULKHEAD JACK	
x MMCX Male Plug.....	B63
x SMA Male Plug.....	B63
MMCX FEMALE JACK	
x MMCX Female Jack.....	B64
x MMCX Male Plug.....	B64
x SMA Male Plug.....	B65
x SMA Female Bulkhead Jack.....	B65
MMCX MALE PLUG	
x MMCX Male Plug.....	B66
x MMCX Right Angle Male Plug.....	B67
x SMA Female Bulkhead Jack.....	B67
x SMA Male Plug.....	B68
x SMA Right Angle Male Plug.....	B69
MMCX Right Angle Male Plug	
x MMCX Right Angle Male Plug.....	B69
x SMA Female Bulkhead Jack.....	B70
x SMA Female Jack.....	B70



TABLE OF CONTENTS

x SMA Male Plug.....	B71
x SMA Right Angle Male Plug.....	B71
N FEMALE BULKHEAD JACK	
x N Male Plug.....	B72
x N Male Plug SEMIRIGID.....	B73
x N Male Plug SEMIRIGID (Commercial).....	B74
x N Right Angle Male Plug.....	B75
x SMA Male Plug.....	B76
x SMA Male Plug SEMIRIGID.....	B77
x SMA Male Plug SEMIRIGID (Commercial).....	B78
x SMA Right Angle Male Plug.....	B79
x SMA Right Angle Male Plug SEMIRIGID.....	B80
x SMA Right Angle Male Plug SEMIRIGID (Commercial).....	B81
N 4 HOLE PANEL JACK	
x SMA Male Plug.....	B82
x SMA Right Angle Male Plug.....	B82
N FEMALE JACK	
x N Male Plug.....	B83
x N Male Plug SEMIRIGID.....	B84
x N Male Plug SEMIRIGID (Commercial).....	B85
x QN Male Plug.....	B86
x QN Right Angle Male Plug.....	B87
x SMA Male Plug.....	B87
N MALE PLUG	
x N Male Plug.....	B88
x N Male Plug (Low Loss Flexible).....	B89
x N Male Plug SEMIRIGID.....	B90
x N Male Plug SEMIRIGID (Commercial).....	B91
x N Right Angle Male Plug.....	B92
x N Right Angle Male Plug (Low Loss Flexible).....	B93
x QN Female Bulkhead Jack.....	B94
x QN Female Jack.....	B95
x QN Male Plug.....	B96
x QN Right Angle Male Plug.....	B97
x SMA Female Bulkhead Jack.....	B97
x SMA Female Jack.....	B98
x SMA Female Jack (Low Loss Flexible).....	B99
x SMA Male Plug.....	B100
x SMA Male Plug SEMIRIGID.....	B101
x SMA Male Plug SEMIRIGID (Commercial).....	B102
x SMA Reverse Polarity Plug.....	B103
x SMA Reverse Polarity Right Angle Male Plug.....	B103
x SMA Right Angle Male Plug.....	B104
x TNC Male Plug.....	B105
x 7-16 Male Plug.....	B106
N RIGHT ANGLE MALE PLUG x N RIGHT ANGLE MALE PLUG.....	B107
QMA FEMALE BULKHEAD JACK X QMA MALE PLUG.....	B108
QMA MALE PLUG	
x QMA Male Plug.....	B109
x QMA Right Angle Male Plug.....	B110
x SMA Male Plug.....	B111
QMA RIGHT ANGLE MALE PLUG	
x QMA Right Angle Male Plug.....	B112
x SMA Male Plug.....	B113



TABLE OF CONTENTS

QN FEMALE JACK X QN MALE PLUG.....	B114
QN MALE PLUG	
x QN Male Plug.....	B115
x QN Right Angle Male Plug.....	B116
QN RIGHT ANGLE MALE PLUG X QN RIGHT ANGLE MALE PLUG.....	B117
SC MALE PLUG x SC MALE PLUG.....	B118
SHV MALE PLUG x SHV MALE PLUG.....	B119
SMA FEMALE BULKHEAD JACK	
x SMA Female Bulkhead Jack SEMIRIGID.....	B120
x SMA Female Bulkhead Jack SEMIRIGID (Commercial).....	B121
x SMA Female Jack SEMIRIGID.....	B122
x SMA Female Jack SEMIRIGID (Commercial).....	B123
x SMA Male Plug.....	B124
x SMA Male Plug SEMIRIGID.....	B125
x SMA Male Plug SEMIRIGID (Commercial).....	B126
x SMA Right Angle Male Plug.....	B127
x SMA Right Angle Male Plug SEMIRIGID.....	B128
x SMA Right Angle Male Plug SEMIRIGID (Commercial).....	B129
x SMB Female Plug.....	B130
x SMB Right Angle Female Plug.....	B131
SMA 2 HOLE PANEL JACK X SMA 2 HOLE PANEL JACK.....	B132
SMA 4 HOLE PANEL JACK	
x SMA 4 Hole Panel Jack.....	B132
x SMA Male Plug.....	B133
x TNC Male Plug.....	B133
SMA FEMALE JACK	
x SMA Female Jack.....	B134
x SMA Female Jack SEMIRIGID (Commercial).....	B135
x SMA Male Plug.....	B136
x SMA Male Plug SEMIRIGID.....	B137
x SMA Female Plug SEMIRIGID (Commercial).....	B138
SMA MALE PLUG	
x SMA Male Plug.....	B139
x SMA Male Plug (Low Loss Flexible).....	B140
x SMA Male Plug (Low Loss Flexible, Commercial).....	B141
x SMA Male Plug SEMIRIGID.....	B142
x SMA Male Plug (JACKETED MAXI-FLEX & MAXIFLEX).....	B143
x SMA Male Plug SEMIRIGID (Commercial).....	B144
x SMA Reverse Polarity Bulkhead Jack.....	B145
x SMA Reverse Polarity Plug.....	B146
x SMA Reverse Thread Plug.....	B147
x SMA Right Angle Male Plug.....	B148
x SMA Right Angle Male Plug SEMIRIGID.....	B149
x SMA Right Angle Male Plug SEMIRIGID (Commercial).....	B150
x SMB Female Plug.....	B151
x SMB Male Bulkhead Jack.....	B152
x SMB Right Angle Female Plug.....	B153
x SMC Female Plug.....	B154
x SMP Socket.....	B155
x SSMB Female Plug.....	B156
x SSMC Female Plug.....	B157
x TNC Female Bulkhead Jack.....	B158
x TNC Female Bulkhead Jack SEMIRIGID.....	B159
x TNC Female Bulkhead Jack SEMIRIGID (Commercial).....	B160

TABLE OF CONTENTS

x TNC 4 Hole Panel Jack.....	B161
x TNC Male Plug.....	B162
x TNC Male Plug (Low Loss Flexible).....	B163
x TNC Male Plug SEMIRIGID.....	B164
x TNC Male Plug SEMIRIGID (Commercial).....	B165
x 1.85 Male Plug.....	B166
x 2.4 MM Male Plug.....	B166
x 2.9 MM Male Plug.....	B167
x 7-16 Male Plug.....	B168
x 7-16 Male Plug (Commercial).....	B169-B170
SMA REVERSE POLARITY FEMALE BULKHEAD JACK	
X SMA Reverse Polarity Male Plug.....	B171
x TNC Male Plug.....	B171
SMA REVERSE POLARITY FEMALE JACK	
X SMA Reverse Polarity Plug.....	B172
SMA REVERSE POLARITY MALE PLUG	
x SMA Reverse Polarity Male Plug.....	B172
x TNC Male Plug.....	B173
SMA REVERSE THREAD PLUG x SMA REVERSE THREAD PLUG.....	B174
SMA RIGHT ANGLE MALE PLUG	
x SMA Right Angle Male Plug.....	B175
x SMA Right Angle Male Plug SEMIRIGID.....	B176
x SMA Right Angle Male Plug SEMIRIGID (Commercial).....	B177
x TNC Female Bulkhead Jack.....	B178
x TNC Female Bulkhead Jack SEMIRIGID.....	B179
x TNC Female Bulkhead Jack SEMIRIGID (Commercial).....	B180
x TNC Male Plug.....	B181
x TNC Male Plug SEMIRIGID.....	B182
x TNC Male Plug SEMIRIGID (Commercial).....	B183
SMB FEMALE PLUG	
x SMB Female Plug.....	B184
x SMB Right Angle Female Plug.....	B185
x SMC Male Bulkhead Jack.....	B186
x TNC Male Plug.....	B187
SMB MALE BULKHEAD JACK	
x SMB Female Plug.....	B188
x SMB Right Angle Female Plug.....	B189
x SMC Female Plug.....	B190
SMB MALE JACK X SMB FEMALE PLUG.....	B191
SMB RIGHT ANGLE FEMALE PLUG	
x SMB Right Angle Female Plug.....	B192
x SSMC Right Angle Female Plug.....	B193
x TNC Male Plug.....	B194
SMC FEMALE PLUG	
x SMC Female Plug.....	B195
x SMC Male Bulkhead Jack.....	B196
x SMC Male Jack.....	B197
x SMC Right Angle Female Plug.....	B198
SMC MALE BULKHEAD JACK	
x SMC Male Bulkhead Jack.....	B199
x SMC Right Angle Female Plug.....	B200
SMC RIGHT ANGLE FEMALE PLUG	
x SMC Right Angle Female Plug.....	B201
x SSMB Right Angle Female Plug.....	B202



TABLE OF CONTENTS

x TNC Female Bulkhead Jack.....	B203
x TNC Male Plug.....	B204
SMP SOCKET	
x SMP Socket.....	B205
x SMP Right Angle Socket.....	B206
SSMB FEMALE PLUG	
x SSMB Female Plug.....	B207
x SSMB Right Angle Female Plug.....	B208
x SSMC Male Bulkhead Jack.....	B209
x TNC Male Plug.....	B210
SSMB MALE BULKHEAD JACK	
x SSMB Right Angle Female Plug.....	B211
x SSMC Female Plug.....	B212
SSMB RIGHT ANGLE FEMALE PLUG	
x SSMB Right Angle Female Plug.....	B213
SSMC FEMALE PLUG	
x SSMC Female Plug.....	B214
x SSMC Male Bulkhead Jack.....	B215
x SSMC Right Angle Female Plug.....	B216
SSMC MALE BULKHEAD JACK	
x SSMC Right Angle Female Plug.....	B217
SSMC RIGHT ANGLE FEMALE PLUG X SSMC RIGHT ANGLE FEMALE PLUG.....	B218
TNC MALE PLUG	
x TNC Male Plug.....	B219
x TNC Male Plug (Low Loss Flexible).....	B220
x TNC Male Plug SEMIRIGID.....	B221
x TNC Male Plug SEMIRIGID (Commercial).....	B222
x TNC Reverse Polarity Female Jack.....	B223
x TNC Reverse Polarity Male Plug.....	B224
x TNC Reverse Polarity Right Angle Male Plug.....	B225
x TNC Right Angle Male Plug.....	B226
x 7-16 Male Plug.....	B227
UHF MALE PLUG x UHF MALE PLUG.....	B228
UMP H2	
x MCX Male Plug.....	B229
x SMA Female Bulkhead Jack.....	B229
x SMA Male Plug.....	B229
x MMCX Male Plug.....	B229
x UMP H2.....	B229
x SSMC Female Plug.....	B229
1.6/5.6 MALE PLUG	
x 1.6/5.6 Male Plug.....	B230
x 1.6/5.6 Right Angle Male Plug.....	B230
x 75 Ω BNC Male Plug.....	B231
1.6/5.6 RIGHT ANGLE MALE PLUG	
x 1.6/5.6 Right Angle Male Plug.....	B231
1.85 MALE PLUG	
x 1.85 Male Plug.....	B232
x 2.4MM Male Plug.....	B232
x 2.9MM Male Plug.....	B233
x 3.5MM Male Plug.....	B233
2.4MM MALE PLUG	
x 2.4MM Female Jack.....	B234
x 2.4MM Male Plug.....	B235



TABLE OF CONTENTS

x 2.9MM Male Plug.....	B236
2.9MM FEMALE BULKHEAD JACK X 2.9MM MALE PLUG.....	B237
2.9MM FEMALE JACK X 2.9MM MALE PLUG.....	B238
2.9MM MALE PLUG X 2.9MM MALE PLUG.....	B239
3.5MM FEMALE BULKHEAD JACK X 3.5MM MALE PLUG.....	B240
3.5MM FEMALE JACK X 3.5MM MALE PLUG.....	B241
3.5MM MALE PLUG X 3.5MM MALE PLUG.....	B242
7-16 FEMALE BULKHEAD JACK X 7-16 MALE PLUG.....	B243
7-16 FEMALE JACK X 7-16 MALE PLUG.....	B244
7-16 MALE PLUG	
x 7-16 Male Plug.....	B245
x 7-16 Male Plug (Low Loss Flexible).....	B246
x 7-16 Right Angle Male Plug (Low Loss Flexible).....	B247
75 Ω BNC FEMALE BULKHEAD JACK	
X 75 Ω MCX Male Plug.....	B248
X 75 Ω N Male Plug.....	B248
75 Ω BNC FEMALE JACK	
X 75 Ω BNC Female Jack.....	B249
X 75 Ω BNC Male Plug.....	B249
75 Ω BNC MALE PLUG	
X 75 Ω BNC Male Plug.....	B250
X 75 Ω BNC Right Angle Male Plug.....	B250
X 75 Ω Maxi-SMB Female Plug.....	B251
X 75 Ω MCX Male Plug.....	B251
X 75 Ω Mini-SMB Female Plug.....	B252
X 75 Ω N Male Plug.....	B252
X 75 Ω SMC Female Plug.....	B253
X 75 Ω TNC Male Plug.....	B253
75 Ω BNC RIGHT ANGLE MALE PLUG	
X 75 Ω BNC Right Angle Male Plug.....	B254
75 Ω MAXI-SMB FEMALE PLUG X 75 Ω MAXI-SMB FEMALE PLUG.....	B254
75 Ω MCX MALE PLUG X 75 Ω MCX MALE PLUG.....	B255
75 Ω MINI-SMB FEMALE PLUG	
X 75 Ω Mini-SMB Female Plug.....	B255
X 75 Ω Mini-SMB Right Angle Female Plug.....	B256
X 75 Ω TNC Male Plug.....	B256
75 Ω MINI-SMB RIGHT ANGLE FEMALE PLUG	
X 75 Ω MINI-SMB RIGHT ANGLE FEMALE PLUG.....	B257
75 Ω N Male Plug	
X 75 Ω N Male Plug.....	B257
75 Ω SMC FEMALE PLUG	
X 75 Ω SMC Female Plug.....	B258
X 75 Ω SMC Male Bulkhead Jack.....	B258
X 75 Ω SMC Right Angle Female Plug.....	B259
75 Ω TNC Male Plug	
X 75 Ω TNC Male Plug.....	B259
ASI MAXIFLEX CABLES.....	B260
ASI T-FLEX CABLES.....	B261
CONNECTOR POWER RATINGS.....	B262
ENGINEERING NOTE.....	B263
TEST EQUIPMENT.....	B264
MANUFACTURING EQUIPMENT.....	B264

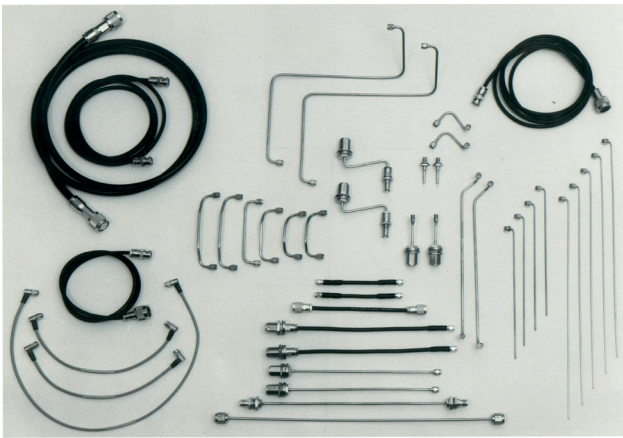

Figure B- 1

RF DEPOT offers many MIL-C-17 qualified coaxial and SEMIRIGID cables from stock. The MIL-C-17 insures consistent comprehensive standards for each applicable cable type. These cables are commonly referred to as QPL cable. RF Depot recommends and uses only QPL qualified products, where one exists, in all cable assemblies. This quality measure has little or no impact on cable assembly pricing due to our purchasing power. RF DEPOT also stocks many high performance, application specific, specialized coaxial cable types yet to be listed in MIL-C-17.

All RF DEPOT cable assemblies are carefully assembled and DC tested in a laboratory environment. RF testing to 40.0 GHz on a Pass/Fail basis is available as an option with little or no impact on delivery. Certification testing is available to 40 GHz, which includes the original evaluation data report. RF DEPOT will retain a complete copy of the evaluation data.

Standard assemblies are offered in custom lengths with quick delivery at favorable prices. Typical small quantities of flexible cables and most SEMIRIGID cables are shipped within one week of receipt of order. Prototypes of SEMIRIGID cables formed to meet custom requirements are shipped within 10 days of receipt of order.

RF DEPOT coaxial cable assemblies are made to exacting tolerances, with a typical flexible cable assembly tolerance of $\pm 0.375''$ or 1.5%, whichever is greater. SEMIRIGID tolerances are $\pm 0.025''$ or 1%, whichever is greater. Within any one manufacturing lot, all SEMIRIGID cable assemblies maintain a tolerance of ± 0.015 inch. If electrical length is critical, electrical length should be specified. RF DEPOT recommends that a phase reference standard cable be maintained if duplicate items are likely to be needed.

Custom marking of cable assemblies can



be provided in accordance with any specific customer supplied documentation. Refer to "How to Order Cable Assemblies" for help in choosing assembly options.

FLEXIBLE CABLE ASSEMBLIES

RF DEPOT flexible cable assemblies are cut and precision trimmed using computer controlled rotating cutters specifically designed for that purpose, insuring the highest degree of accuracy.

Strain relief boots as well as heat shrinkable tubing are offered on most cable assemblies. Optional heavy wall shrink tubing with adhesive inner wall can be supplied to provide superior strain relief, and are applied in a manner for the inner adhesive wall to adhere to both the connector backshell and the cable jacket. The use of such reliefs is recommended whenever a cable may be subjected to rough handling such as field use. These reliefs however are effective only where the cable jacket OD and the connector backshell OD have a ratio of approximately 1.8:1 or less.

Coaxial cables can be supplied with other than coaxial connectors such as alligator clips or "banana jacks". When two banana jacks are specified, the center conductor and dielectric are withdrawn through a small opening in the shield. The shield is left intact and is insulated with shrinkable sleeving. The "V" joint is treated with heavy wall shrink tubing and a cosmetic "V" joint is formed similar in appearance to a molded junction.

SEMIRIGID CABLE ASSEMBLIES

SEMIRIGID cable assemblies are prepared using both MIL-C-17 and application specific SEMIRIGID stock. Each SEMIRIGID blank is precision cut using an RF DEPOT model 94 cable saw ensuring the

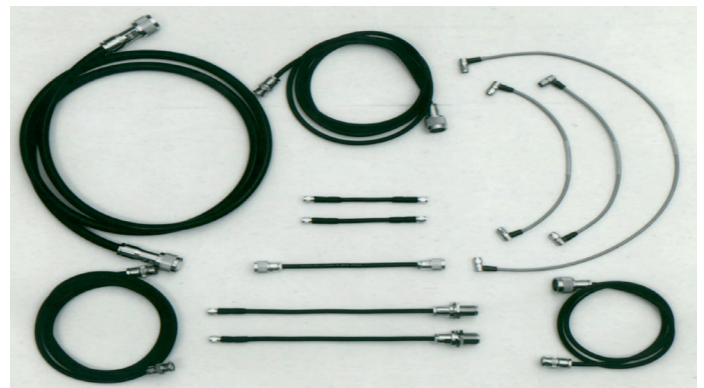
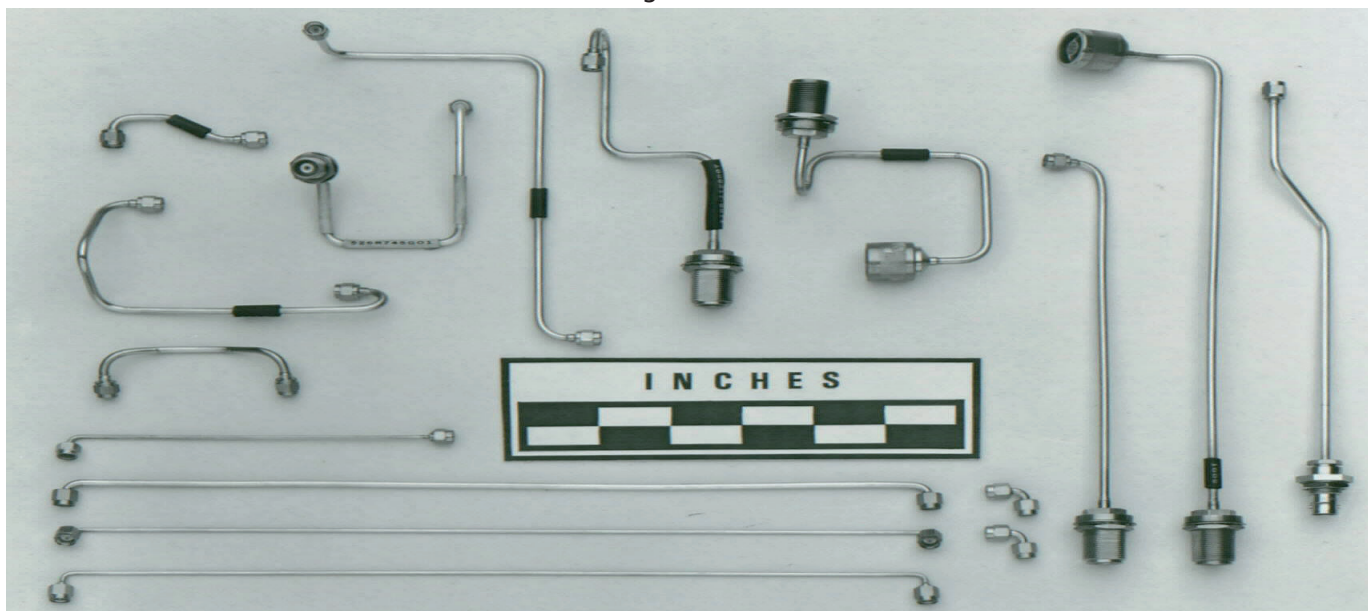

Figure B- 2

tightest of tolerances and complete repeatability.

Depending upon the physical characteristics of the blank, trimming is accomplished either by incremental milling or scribing tech-

Figure B- 3



nique. Assemblies using the center conductor as the connector interface pin are pointed at this time.

When a separate connector contact is not used, RF DEPOT recommends a steel (copper flash with silver plate) center conductor. Unless otherwise specified, RF DEPOT SEMIRIGID cable assemblies will be supplied with steel center conductors.

To minimize delivery time and provide maximum cost effectiveness, RF DEPOT will lay out cables within a customer furnished assembly, provide forming data suitable for subsequent manufacturing. A copy of MIL-D-1000 forming drawing suitable for preparation of traditional assembly and inspection drawings is provided in initial order.

FORMED SEMIRIGID ASSEMBLIES

RF DEPOT offers formed SEMIRIGID assemblies to customer specification. When ordering formed SEMIRIGID Cable assemblies, the following guidelines should be observed to maximum cost effectiveness:

- a) Use a constant bend radius wherever possible.
- b) Specify radii from centerline of cable. Standard RF DEPOT tooling for both 0.085" and 0.141" diameter cable provides for bend radii of: 0.625", 0.50", 0.375", 0.312", 0.250" and 0.220". For 0.085" cable only, Standard RF DEPOT tooling also provides for centerline radii of 0.150", 0.125" and 0.10". Slightly smaller radii can be provided for 0.141" cable where absolutely necessary.

c) Use a straight section at the connector interface of at least 1.0" on 0.141" diameter cable and 0.50" for 0.085" cable wherever possible.

d) For angle bends, specify both rectangular coordinates in true size projection.

e) If scale drawings are made, use full scale and not half or twice size. Provide measurable dimensions such as outside of cable to connector end with theoretical dimensions as reference only.

f) Provide all usable tolerances on dimensions, even if such results are +0.5" minus 0.0" or similar. Cost effective tolerances for bend locations are \pm two cable diameters with \pm one-half cable diameter typically provided.

g) If providing customer drawings, locate and dimension all tangent points, connector reference planes and trimmed cable ends.

CUSTOM RIGHT ANGLE ASSEMBLIES

RF DEPOT Custom Right Angle SMA assemblies were designed to fulfill the requirements satisfied by SMA right angle connector assemblies, without degradation to SWR and insertion loss characteristics. This is achieved using custom made tooling and a low profile SMA connector. The RF DEPOT custom Right Angle Assembly is shown in figure B-4.



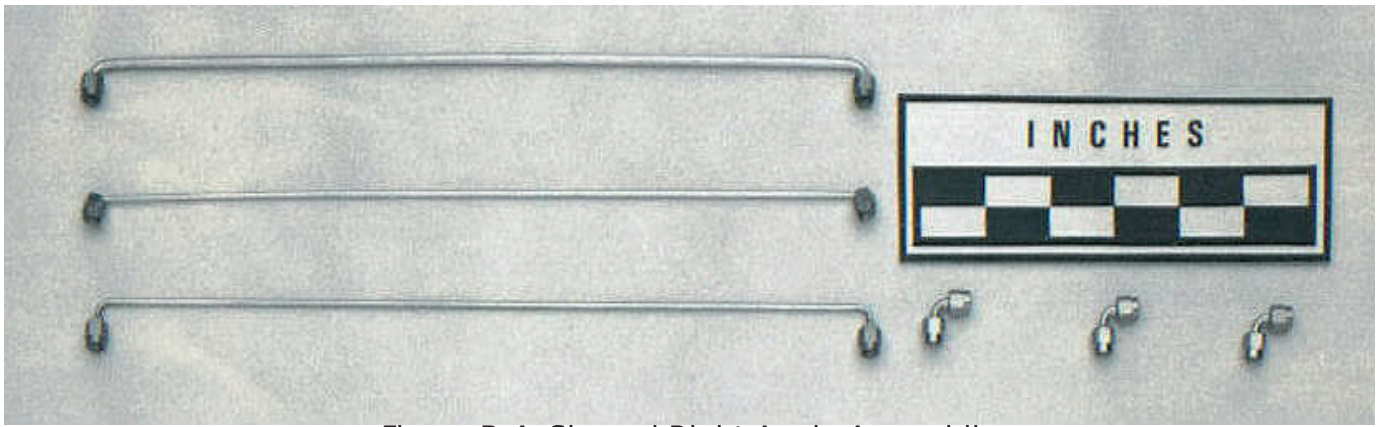

Figure B-4: Shaped Right Angle Assemblies

CLOCKING

All orders for assemblies having two right angle connectors, or one right angle connector and one keyed connector should be accompanied by clocking instructions. A written comment in the purchase order description is sufficient. Clocking, specified in degrees, refers to the angular difference between the two center pin reference planes for assemblies having two right angle connectors, and the angular difference between the right angle connector center pin and the key for keyed connector.

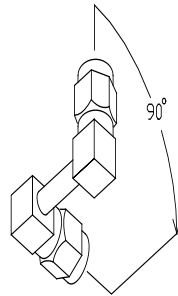
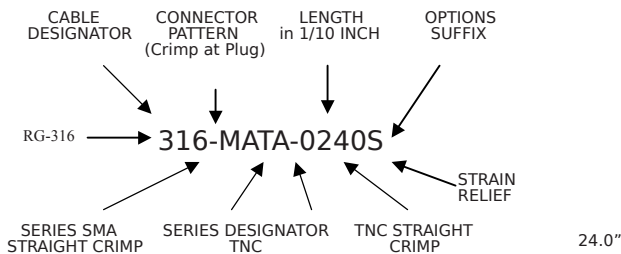

Figure B-5: Clocking Diagram

HOW TO ORDER CABLE ASSEMBLIES

The individual components of each RF DEPOT part number define the composition of the cable assembly. Designators for the components are contained in Table B-2 on page B-4. The RF DEPOT part number defines the below example as follows:



Designators identifying product options such as custom markers, strain relief, testing and serial numbering are also contained in Table B-2, and should be utilized where possible as a suffix to the part number. RF DEPOT assigns a unique accession number in place of the specified length for all pre-formed SEMIRIGID assemblies.

CABLE MARKERS

When ordering cables with markers, specify characters in legible format and designate which end or center position for each marker. For logistical support applications, contact RF DEPOT for a specific accession number that will designate all cable markers. For all other orders specify markers on face of purchase order. Use Table B-1 as an example when specifying marker information. When possible, provide drawings indicating marker positioning, and specific placement on the cable assembly. Where marker positioning is not critical, general statements included with marker information such as "markers will be within 3.0" from connector body are sufficient.

ASSEMBLY	MARKER A	MARKER B	MARKER C
316-MA-MA-0120FF	R1A12J1RF OUT	ASSY R1A2	R1A12J2RF IN
316-MA-MA-0240FF	R1A2P1IF IN	ASSY R1A2	R1A12P1IF OUT

Table B-1: Cable Marker Documentation

RF DEPOT standard method of marking is permanent ink or heat-stamped black characters on shrinkable white tubing.

TABLE B-2: Designators for Cable Assemblies

CONNECTOR SERIES	CONNECTOR DESIGNATOR	CONNECTOR SERIES	CONNECTOR DESIGNATOR	CONNECTOR SERIES	CONNECTOR DESIGNATOR
1.85	85	MC Card	CC	RCA Phono-Video	RV
2Lug 3/8"	TRB	DIN 1.0/2.3	D1	SC	SC
2.4mm	24	DIN 1.6/5.6	D2	SHV	SH
Tinplate	25T	DIN 4.1/9.5	D4	SLB	LB
2.9mm	29	F	F	SMA Slide-on	SL
20KV	2K	GR874	GR	SMA Push-on	QM
200 PC	PC	Hirose	H4	SMA Rev Thread	MR
3.5mm	35	HN	HN	SMA	M
7-16"	716	JAPAN Push-on	JP	SMB	MB
75Ω BNC	S	King Radio Push-on	BK	SMC	MC
75Ω TNC	R	LC	LC	SMD	MD
75Ω Mini-SMB	7B	MCX	CX	SMP	MP
75Ω Maxi-SMB	7M	MHV	MH	SMZ	MZ
75Ω MCX	7X	MMS	MS	SSLB	SLB
75Ω N	N7	Mini UHF	MU	SSMA	SM
75 Ω SMA	M7	MMBX	MBX	SSMB	SB
75Ω SMC	7C	MMCX	MCX	SSMC	CS
APC-7	A7	N	N	SSMP	SP
75 Ω SMA	M7	N Hex	NH	TMS	M8
75Ω SMC	7C	PKZ	PK	TNC	T
APC-7	A7	PTNC, 18Ghz (HeX)	PT	TPS	TP
Black Alligator	BA	QLA	QL	3/4" Twinax	TW
Black Banana	BB	QMA	Q	U.FL	1.U
BMA	A	QN	QN	UHF	U
BMZ	Z	Red Alligator	RA	Universal Adapter	BK
BNC	B	Red Banana	RB	XLR Microphone	LR
C	C	RCA Phono-Audio	RC		

SUFFIXES

Anti-Torque Nut	&	2-level Melted Strain Relief 1" & 2"	SS
Armored Cable	A	MIL/QPL Cable	P
Captivated	T	MIL/QPL Connectors	PP
Combo Nut	@	Nickel Plate	I
Commercial	C	Removal of Hazardous Substances	ROHS
Crimp-Clamp one-end	E	Serial	#
Crimp-Clamp 3X Heavy Relief	M	Serial and Tested	*
Gold Plated	K	Soldered Connectors	D
High Performance Cntrs	H	Custom Cable Marking	FF
Melted Strain Relief	S		

CONNECTOR PATTERN DESIGNATOR

DESCRIPTION	CLAMP	CRIMP	REVERSE POLARITY	CLAMP	CRIMP
Straight Plug	0	A	Rev. Pol. Straight Plug	-	M
Straight Jack	1	B	Rev. Pol. Straight Jack	10	N
Right Angle Plug	2	C	Rev. Pol. Right Angle Plug	11	P
Right Angle Jack	3	D	Rev. Pol. Right Angle Jack	12	Q
Isolated Rear Mnt. B/H Jack	4	E	Rev. Pol. Isolated B/H Jack	13	R
Bulkhead Front Mnt. Jack	8	Y	Rev. Pol. Front Mnt. Jack	14	Z
Bulkhead Rear Mnt. Jack	5	F	Rev. Pol. Rear Mnt. Jack	15	W
Bulkhead Plug	-	S	Rev. Pol. Straight Hex Plug	16	T
Straight Hex Plug	6	G	Rev. Pol. 2 Hole Panel Jack	17	U
Right Angle Hex Plug	%	I	Rev. Pol. 2 Hole Panel Jack	18	V
2 Hole Panel Jack	7	H			
4 Hole Panel Jack	9	J			
Square Cut	XX	XX			
Trim Cut	XY	XY			
4 Hole Board	-	LL			
2 Hole Board	-	KK			
4 Hole Panel Plug	4H	10K			
2 Hole Panel Plug	2H	11L			



TABLE B-3: Designators for Cable Assemblies

Standard		
Cable Type Coaxial & M17	CC-SHEILD	Desig.
BELDEN735A	①	735A
BELDEN 8218	①	821
BELDEN 9311	①, ②	311
EF142	①, ⑦	42E
EF178D	②, ⑦	78E
EF179	②, ⑩	79E
EF316D	②, ⑦	16E
EF393	①, ⑦	93E
EF400	①, ⑦	40E
FUJI 1.5 QEW		1QE
LA 290		290
HP 160		160
HP 190		190
LL142		4LL
RG 6 - LSZeroH	②, ⑤	18M
RG 6/U	⑤	006
RG 8/U	③, ③, ⑧	008
RG 11-LsZeroH	②, ⑥, ⑥	181
RG 11/U	⑥, ⑥	011
RG 55/U	①, ⑦	055
RG 58-LSZeroH	②, ⑥, ⑦	183
RG 58/U	③, ⑥, ⑦	058
RG 59-LSZeroH	②	184
RG 59/U	③, ⑤, ⑧	059
RG 62-LSZeroH	②, ⑤, ⑧	185
RG 62/U	③, ⑤, ⑧	062
RG 71/U	⑤, ⑥	071
RG 141/U	②, ⑩	141
RG 142/U	④, ②, ⑦	142
RG 174/U	③, ⑤, ⑦	174
RG 174A-ZeroH	②, ⑤, ⑦	96M
RG 178/U	②, ⑩	178
RD 178/U	②, ⑦	78D
RG 179/U	④, ②, ⑩	179
RD 179/U	②, ⑦	179
RG 180/U	②, ⑩	180
RG 187/U	②, ⑩	187
RD 188/U	④, ②, ⑩	188
RD 188/U	④, ②, ⑦	88D
RG 196/U	②, ⑩	196
RG 213/U	③, ③, ⑧	213
RG 214-ZeroH	②, ①, ⑦	90M
RG 214/U	③, ①, ⑦	214
RG 216/U	③, ⑥	216
RG 217/U	③, ⑧	217
RG 218/U	③, ⑧	218
RG 223-ZeroH	②, ①, ⑦	94M
RG 223/U	③, ①, ⑦	223
RG 225/U	①, ⑦	225
RG 226/U	①, ⑧	226
RG 303/U	②, ⑩	303
RG 316/U	④, ②, ⑩	316
RD 316/U	④, ②, ⑦	31D
RG 393/U	④, ①, ⑦	393
RG 400/U	④, ①, ⑦	400
SFT-142B	①, ⑨	42T
SFT-304	①, ⑨	04T
SFT-316	①, ⑨	16T
SFT-393	①, ⑨	93T
SF-142	②, ⑨	S42
SF-214	①, ⑨	S21
SF-304	②, ⑨	S05
SF-316	②, ⑨	S16
SF-393	①, ⑨	S35
Suhner S02112		211
TCom400		4TC
TCom500		5TC
TCom600		6TC
1.13mm		001
9311	①, ②	311

LMR/Signa		
Cable Type Coaxial & M17	CC-SHEILD	Desig.
LMR100A	①, ⑤, ⑨	1LM
LMR195	①, ③, ⑨	19M
LMR195-DB	①, ③, ⑨	19D
LMR195-FR	①, ③, ⑨	19R
LMR195-UF	①, ③, ⑨	
LMR195-LLPL	①, ③, ⑨	19P
LMR200	①, ③, ⑨	2LM
LMR200-DB	①, ③, ⑨	2LD
LMR200-FR	①, ③, ⑨	2LF
LMR200G		220
LMR200-UF	①, ③, ⑨	2LU
LMR200-LLPL	①, ③, ⑨	2LP
LMR200-75	①, ③, ⑨	2LM75
LMR240	①, ③, ⑨	24L
LMR240		221
LMR240-UF	①, ③, ⑨	24LU
LMR240-DB	①, ③, ⑨	24D
LMR240-FR	①, ③, ⑨	24R
LMR240-LLPL	①, ③, ⑨	24P
LMR240-75	①, ③, ⑨	24L75
LMR300	①, ③, ⑨	3LM
LMR300		222
LMR300-UF	①, ③, ⑨	3LU
LMR300-LLPL	①, ③, ⑨	3LP
LMR300-75	①, ③, ⑨	3LM75
LMR400	①, ④, ⑨	4LM
LMR400	①, ④, ⑨	23M
LMR400-DB	①, ④, ⑨	4LD
LMR400-UF	①, ④, ⑨	4LU
LMR400-FR	①, ④, ⑨	4RC
LMR400-LLPL	①, ④, ⑨	4LP
LMR500	①, ③, ⑨	5LM
LMR500-UF	①, ④, ⑨	5LU
LMR600	①, ④, ⑨	6LM
LMR600	①, ④, ⑨	25M
LMR600-UF	①, ④, ⑨	6LU
LMR900	①, ③, ⑨	9LM
LMR900	①, ③, ⑨	226
LMR1200	①, ③, ⑨	12L
LMR1200	①, ③, ⑨	227
LMR1700	①, ③, ⑨	17L
SIGNA100	①, ⑤, ⑨	1LC
SIGNA100	①, ⑤, ⑨	1FR
SIGNA195	①, ③, ⑨	19C
SIGNA195-DB	①, ③, ⑨	19B
SIGNA195-FR	①, ③, ⑨	19F
SIGNA200	①, ③, ⑨	2LC
SIGNA200-DB	①, ③, ⑨	20B
SIGNA200-FR	①, ③, ⑨	20F
SIGNA240	①, ③, ⑨	24C
SIGNA240-UF	①, ③, ⑨	24U
SIGNA240-DB	①, ③, ⑨	24B
SIGNA240-FR	①, ③, ⑨	24F
SIGNA300	①, ③, ⑨	3LC
SIGNA300-UF	①, ③, ⑨	3UC
SIGNA400	①, ④, ⑨	4LC
SIGNA400-DB	①, ④, ⑨	4DC
SIGNA400-UF	①, ④, ⑨	4UC
SIGNA400-FR	①, ④, ⑨	4RC

Cable Type SEMIRIGID And MAXIFLEX	CC	Desig.
.250" Bare Cu	①	401
.250" Tin Plate-Al	①	25A
.250" Silver Plate-Cu		25S
.250" MaxiFlex-Tin Plate	②	25F
.250" MaxiFlex-Tin Plate Cu	②	25T
.250" MaxiFlex-Jacketed	②	25X
.250" TFlex-401 Tape/ Braid	①	2TF
.141" Bare Cu	②	402
.141" Bare Cu - Hard	②	40H
.141" Tin Plate-Cu	②	1TS
.141" Bare Al		14A
.141" Tin Plate-Cu	①	1CT
.141" Tin Plate-Al	①	1AT
.141" Silver Plate-Cu	②	1SS
.141" MaxiFlex-Tin Braid	②	14F
.141" MaxiFlex-Tin Braid	①	1CF
.141" TFlex-402 Tape/Braid	①	14T
.141" MaxiFlex-Jacketed	②	14J
.141" Micropr Bare Cu	②	1M0
.141" Micropr Tin-Cu	②	1MT
.141" Sucoform CU	①	1SU
.141" Storm 421-671	②	1ST
.085" Bare Cu	②	405
.085" Tin Plate-Cu	②	8TS
.085" Bare Alum		85A
.085" Tin Plate-Cu	①	8CT
.085" Tin Plate-Al	②	8AT
.085" Silver Plate-Cu	②	8SS
.085" MaxiFlex-Tin Braid	①	08C
.085" MaxiFlex-Tin Braid	②	08F
.085" MaxiFlex-Jacketed	②	08J
.085" TFlex-405 Tape/Braid	②	08T
.085" Storm 421-193	②	8ST
.085" UT 85-LLTP	①, ①	8LT
.047" Bare Cu	②	4CU
.047" Tin-Cu	①	4CT
.047" Tin-Cu	②	4TS
.047" Tin-Al		4AT
.047" MaxiFlex-Tin Braid	②	04F
.047" MaxiFlex-Tin Braid	①	04C
.034" Tin-Cu	②	3TS
.250" FSJ1-50A SuprFlx	④	25J
.250" FSJ1P-50A LoSWR	④	25P
.250" HFC 50 Ω Radiax Blue		25E
.250" FSJ1-75 75 Ω SuprFlx	⑤	2CJ
.375" LDF2-50 50 Ω CorrtD	④	37L
.500" LDF4.5-50 50 Ω CorrtD	④	45L
.500" FSJ4-50B 50 Ω SuprFlx	④	50J
.500" LDF4-50A 50 Ω CorrtD	④	50L
.875" LDF5-50A 50 Ω CorrtD	③	87L

- ① Silver Plated Copper Center Conductor
- ② Silver Plated Cu Clad Steel Center Conductor
- ③ Bare Copper Center Conductor
- ④ Copper Clad Aluminum Center Conductor
- ⑤ Copper Clad Steel Center Conductor
- ⑥ Tinned Copper Center Conductor
- ⑦ Silver Plate Copper Double Braid Shield
- ⑧ Bare Copper Braid Shield
- ⑨ Aluminum Tape/Tinned Copper Braid Shield
- ⑩ Silver Plated Copper Shield
- ⑪ Polyethylene Foam
- ⑫ Low Loss, Phase Stable (Low Density PTFE)
- ⑬ Low Smoke/Zero Halogen Composition
- ⑭ Polyethylene Dielectric
- ⑮ Solid Polytetrafluorethylene
- ⑯ High Density Polytetrafluorethylene
- ⑰ Tinned Copper Double Braid Shield
- ⑱ Tinned Copper Shield
- ✱ More Flexible Version of RG142

RF DEPOT offers color coding in ten EIA colors at no additional cost. Just add the appropriate suffix from the color table. Color coding is by pre-molded strain relief boots or by shrinkable tubing depending on the diameter of the coaxial connector. Black shrinkable tubing with an adhesive inner wall provides excellent strain relief. The use of a strain relief is recommended whenever an assembly is subjected to rough handling such as field use. These reliefs are effective only where the cable jacket O.D. and the connector body O.D. have a ratio of approximately 1.8:1 or less. Strain relief for small diameter cable assemblies having ratios of greater than 1.5:1, can be accomplished by first installing heavy wall shrink tubing on the cable, flush with the connector body, and an overall strain relief covering the first layer of tubing and the connector body.

SPECIAL ORDERS

RF DEPOT can produce cable assemblies using customer supplied materials in accordance with most drawings and documentation. When placing special orders, provide all documentation with

purchase orders, including but not limited to drawings, connector assembly instructions and marking requirements. RF DEPOT assumes no responsibility for assemblies produced based on incorrect customer supplied information. Make every effort to provide accurate and complete documentation.

ASSEMBLY TYPE	SETUP	DELIVERY IMPACT	RL & IL & PHASE	RL & IL Per Unit	2 x RL & IL
Most Coax to 6 GHz	\$0.00	None	\$3.00	\$3.00	\$4.00
Type SMA to 20 GHz	\$0.00	None	\$6.00	\$6.00	\$7.50
Type Nto 18 GHz	\$0.00	None	\$6.00	\$6.00	\$7.50
Type 2.9/K/ SMA to 26 GHz	\$50.00	None	\$20.00	\$15.00	\$20.00
Type 2.9/K to 33 GHz	\$50.00	1 Day	\$24.00	\$15.00	\$24.00
Type 2.4 to 40 GHz	\$62.50	1 Day	\$34.00	\$24.00	\$34.00

Table B-4: Cable Assembly Testing

TESTING AND CERTIFICATION

RF DEPOT offers SWR, return loss, insertion loss and phase testing to 40 GHz. Temperature and humidity testing is also available to 40 GHz. Assemblies are identified with temporary paper tags, unless directed otherwise. Permanent item marking is separately priced. The schedule of testing availability and delivery impact is provided in Table B-4.

Testing is for return loss (SWR) at one end and insertion loss, all plotted on one graph. Two-way return loss (SWR) is applicable only for same series connector on each end and plotted on the same paper. For non-insertable assemblies (Jack to Jack or Plug to Plug), a high quality gender changer is included in the calibration and subsequent testing. Other testing, including phase and SWR is available at individual piece prices. SEMIRIGID is phase stabilized, when requested or specified, after bending with two temperature cycles from -50°C to +150°C. The RF DEPOT test chamber limits the size of the particular assemblies under test. Contact RF DEPOT when considering phase stabilizing or temperature testing.

RF DEPOT maintains a large inventory of coaxial connectors and invites inquiries for assemblies using other than the “standard” designated connectors. The standard connectors however have been selected for best utility and reliability together with most reasonable cost effectiveness and should be deviated from only under special circumstances.

There are many reasons for choosing a particular coaxial connector for a specific application. RF DEPOT invites discussions and inquiries on specific applications and considerations. For instance, a properly terminated SMA connector without center contact on 0.141-diameter SEMIRIGID cable offers lower insertion loss than does a connector with a separate contact even though the separate contact is usually gold plated.



COAXIAL CABLE CHARACTERISTICS

FREQUENCY (GHz)																																																																																																																																																																																																																																					
9, 9A, 9B, 214			11, 12, 13, 216			14, 72, 217, 224, 293, 388			55, 55A, 55B, 223			58, 58B			59, 59A, 59B			62, 62A, 71, 71A			62B			140, 141, 141A, 142, 303, 400			142B, 159, 302			174, 174A			188, 188A, 316			SF214			223			SF 142B			234, 242			.085" SEMIRIGID			.085" MAXI-FLEX			T-FLEX 405 HF			.141" SEMIRIGID			.141" MAXI-FLEX			T-FLEX 402 HF																																																																																																																																																																						
NOMINAL LOSS CHARACTERISTICS (dB/100 ft)																																																																																																																																																																																																																																					
0.1	2.2	2.0	1.4	4.3	3.9	3.4	2.8	3.0	3.9	4.0	8.9	11.5	2.0	4.3	3.8	13	5.9	6.5	7.0	3.25	3.3	3.4	0.2	3.2	2.9	2.1	6.0	5.6	4.9	3.7	4.3	5.5	5.5	12.0	15.0	2.75	6.0	5.3	18	8.2	9.2	-	4.6	4.7	5.0	0.4	4.6	4.2	3.1	8.8	8.2	7.0	5.2	6.1	8.0	11.7	17.5	20.0	4.15	8.8	7.5	28	10.2	13.0	14.0	8.0	6.9	7.1	1.0	9.0	7.2	5.8	16.5	13.5	12.0	8.5	10.5	13.0	19.0	31.0	30.0	8.5	16.5	12.0	51	22.0	22.0	23.0	12.0	11.4	13.0	3.0	19.0	19.0	13.0	36.0	38.0	-	18.5	23.5	26.0	35.0	64.3	58.0	13.0	36.0	25.0	-	-	-	39.0	21.0	-	23.0	5.0	28.0	28.0	19.0	51.0	-	-	29.5	36.0	38.0	48.0	97.0	79.0	17.5	51.0	29.5	-	-	-	-	29.0	-	30.0	10.0	47.0	-	31.0	85.0	-	-	-	-	62.5	66.0	185	133	27.0	85.0	42.0	-	80.0	76.0	76.0	45.0	44.0	45.0	18.0	-	-	-	-	-	-	-	-	-	-	-	-	-	-	65.0	-	123	105	-	64.0	63.9	-	20.0	-	-	-	-	-	-	-	-	-	-	-	-	-	-	70.0	-	130	115	112	70.0	68.5	-	26.0	-	-	-	-	-	-	-	-	-	-	-	-	-	-	-	-	160	-	-	85.0	-	-
AVERAGE POWER HANDLING CAPABILITY (WATTS C.W.)																																																																																																																																																																																																																																					
0.1	850	650	1.2K	205	180	310	310	280	2.4K	2.4K	50	450	850	180	-	37K	350	-	-	1.1K	1K	-	0.2	540	400	800	137	125	200	200	180	1.6K	1.6K	36	330	550	125	-	24K	240	270	-	760	830	-	0.4	350	260	480	90	85	135	135	120	1.1K	1.1K	25	240	360	85	950	17K	165	200	720	520	650	310	1.1	190	150	260	53	50	77	77	69	650	650	16	160	210	50	550	9.2K	130	1330	440	450	459	190	3.3	95	70	120	28	25	40	40	35	350	350	-	80	115	25	300	-	50	-	-	250	-	-	5.5	65	50	85	20	-	27	27	25	245	245	-	57	85	17	220	-	54	58	170	180	190	80	11.0	37	-	50	10	-	-	-	-	140	140	-	30	60	-	150	-	35	35	110	126	120	50	18.0	-	-	-	-	-	-	-	-	-	-	-	-	-	-	112	-	22	22	80	75	72	40	20.0	-	-	-	-	-	-	-	-	-	-	-	-	-	-	105	-	20	20	-	70	70	-	26.0	-	-	-	-	-	-	-	-	-	-	-	-	-	-	90	-	5	-	-	40	-	-

STANDARD SEMIRIGID ASSEMBLIES

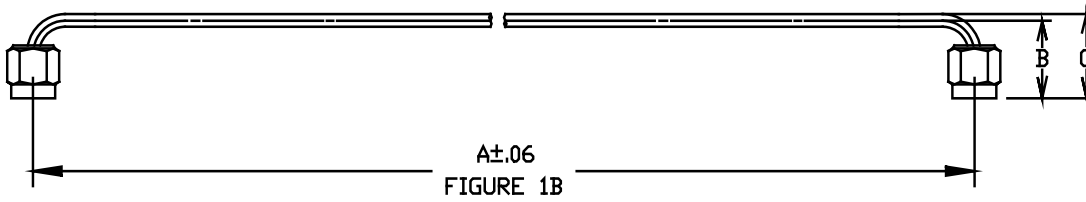
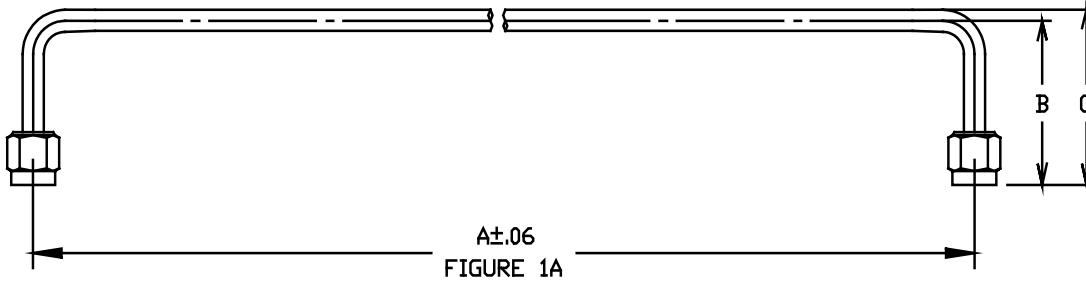

CABLE TYPE	FIG	A	B	C	PART NUMBER	PRICE
RG 402 (.141)	1A	12"	.535	.605	1TS-M0M0-Z236	\$29.00
RG 402 (.141)	1A	18"	.535	.605	1TS-M0M0-Z576	\$28.50 ①
RG 402 (.141)	2	.675	.94	-	1TS-M0M0-Z495	\$24.50
RG 402 (.141)	2	1.00	1.00	-	1TS-M0M0-Z557	\$21.60
RG 402 (.141)	7	1.1 / 1.8 *	1.21	-	1TS-M0M0-Z579	\$27.00
RG 402 (.141)	8	-	-	-	1TS-M0M1-Z507	\$35.00
RG 402 (.141)	3	.550	.550	.330	1TS-M0M0-Z496	\$27.84 ①
RG 402 (.141)	4	.550	.625	.250	1TS-M0M0-Z573	Call
RG 402 (.141)	5	.550	.750	-	1TS-M0M1-Z575	\$36.10 ①
RG 402 (.141)	6	.446	.760	-	1TS-M0M0-Z574	Call
RG 402 (.141)	6	.446	.760	-	1TS-M0M0-Z574	Call
RG 405 (.085)	1B	18"	.410	.453	8TS-M0M0-Y397	\$47.47 ①
RG 405 (.085)	1B	24"	.410	.453	8TS-M0M0-Y834	\$48.24
RG 405 (.085)	1B	12"	.535	.578	8TS-M0M0-Y002	\$42.00 ①
SPECIAL ORDER ITEMS (4 WEEK TYPICAL DELIVERY / 10 PC. MINIMUM)						
RG 402 (.141)	1A	36"	.535	.578	1TS-M0M0-Z577	\$42.00
RG 402 (.141)	1A	24"	.535	.578	1TS-M0M0-Z578	\$40.00
RG 405 (.085)	1B	24"	.410	.453	8TS-M0M0-Y834	\$48.24

* Field adjustable 1.1" - 1.8" nominal 1.40"

① Normal stock items

STANDARD SEMIRIGID ASSEMBLIES

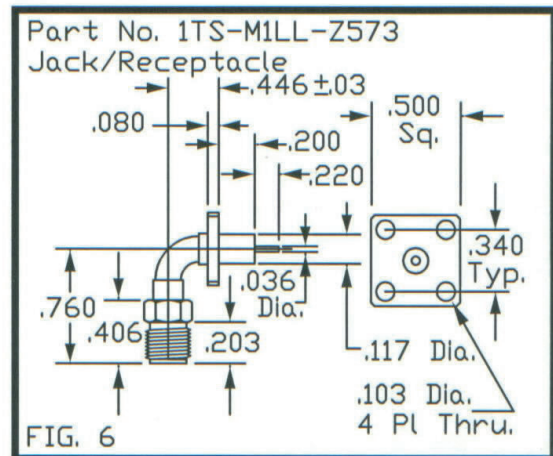
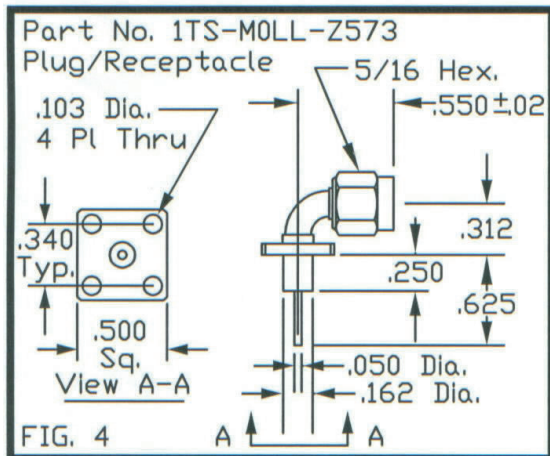
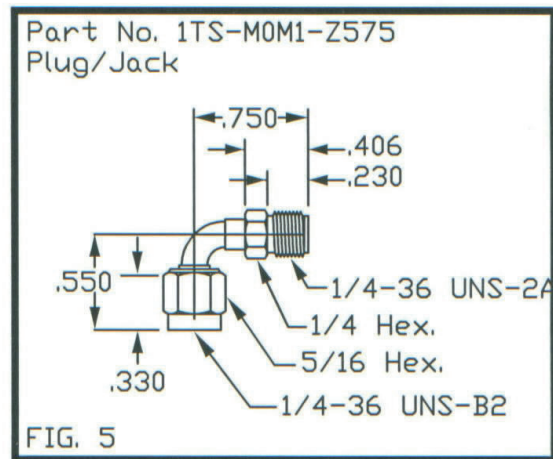
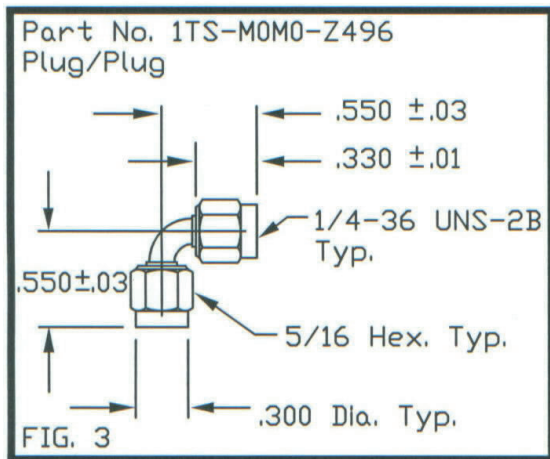
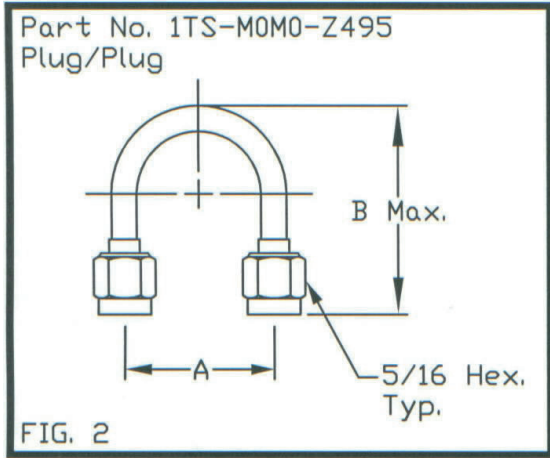

STANDARD SEMIRIGID ASSEMBLIES

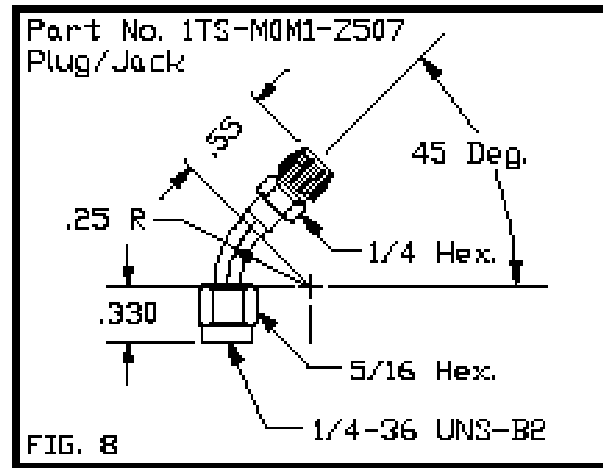
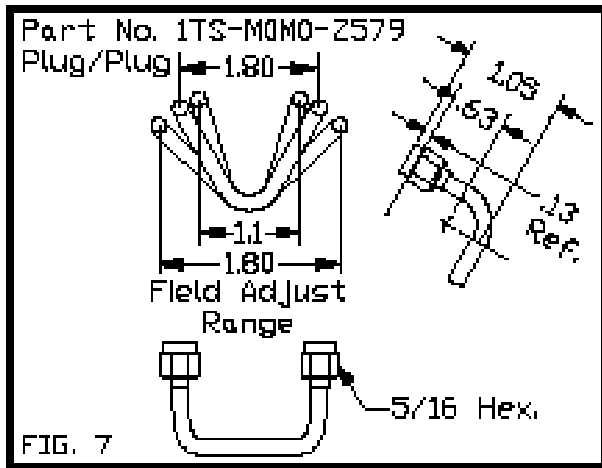

RF Depot offers right angle SEMI-RIGID cable assemblies from stock to eliminate the need for special right angle connectors. These cable assemblies use special bending techniques to achieve the same excellent performance of swept right angle or straight connectors at a reasonable cost.

These RF Depot assemblies have a short right angle at each end of a cable of nominal 12 to 18" length. The intended application is for the customer to cut this assembly in two parts and to finish the assembly as required. The factory bent right angle offers Significantly better performance than a mitered right angle connector and a lower cost than the equivalent swept or high performance connector.

This unique RF Depot construction offers opportunity for the cable to be tested before the secondary operation of customizing. Right angle "pigtaills" supplied by others are difficult to examine electrically at incoming inspection and the vendor usually disclaims all responsibility for electrical performance of the resulting assembly. RF Depot now offers a longer more versatile assembly at a lower cost than the previous assembly.

Custom Assemblies and other lengths are available with reasonable prices and delivery.

Other custom services include design, documentation, marking and testing of all types of coaxial cable assemblies.

PRACTICAL LOW-LOSS FLEXIBLE CABLES

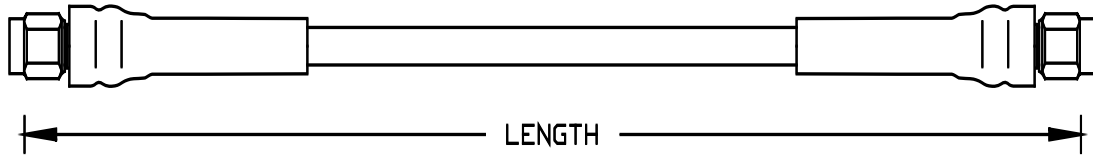

LENGTH IN INCHES	TYPICAL 18GHZ LOSS (DB)	MAX LOSS (DB) FREQUENCY (GHZ)				DASH NUMBER	PRICE 1/2/03
		3	5	10	18		
SMA STRAIGHT PLUG CONNECTORS BOTH ENDS F5.2-M0M0-							
12	0.75	0.30	0.40	0.55	0.85	-0120	\$190.00
18	0.80	0.37	0.50	0.70	1.10	-0180	\$200.00
24	1.00	0.53	0.60	0.90	1.43	-0240	\$215.00
30	1.20	0.69	0.70	1.10	1.72	-0300	\$230.00
36	1.50	0.75	0.90	1.30	2.10	-0360	\$267.00
48	1.80	1.00	1.10	1.60	2.60	-0480	\$290.00
72	2.50	1.20	1.50	2.30	3.80	-0720	\$312.00
N STRAIGHT PLUG CONNECTORS BOTH ENDS F5.2-N0N0-							
30	1.40	0.77	0.80	1.20	1.90	-0300	\$285.00
36	1.70	0.84	1.00	1.40	2.30	-0360	\$302.00
48	2.00	1.10	1.20	1.70	2.80	-0480	\$350.00
APC 3.5 STRAIGHT J x STRAIGHT PLUG A250-3536-							
12	0.80	0.36	0.40	0.77	1.26	-0120	\$262.00
24	1.20	0.47	0.55	0.85	1.49	-0240	\$290.00
30	1.37	0.54	0.63	0.98	1.62	-0300	\$304.00
36	1.54	0.60	0.70	1.11	1.74	-0300	\$317.00
APC 3.5 STRAIGHT P x STRAIGHT PLUG A250-3535-							
12	0.80	0.46	0.51	0.57	0.66	-0120	\$269.00
18	1.00	0.52	0.58	0.66	0.78	-0180	\$283.00
24	1.20	0.57	0.65	0.75	0.89	-0240	\$297.00
30	1.35	0.64	1.05	0.83	1.00	-0300	\$311.00
36	1.50	0.70	0.80	0.91	1.10	-0360	\$324.00
Color Designators (add letter to the end of the part number and add \$1.00 to price)							
Black - B	Blue - L	Brown - N	Gray - A	Green - G			
Orange - O	Red - R	Violet - V	Yellow - Y	White - W			

See Page B5 for Cable Characteristics

* Contact Factory for delivery, Consider new RD316 for (RD188)

10% Discount @ 25 pcs. up

4% Discount @ 10 pcs. up

40 GHZ PRACTICAL LOW-LOSS TEST CABLES

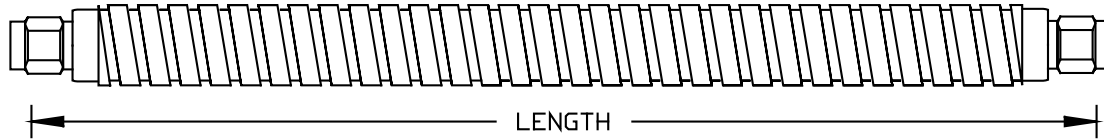

LENGTH IN INCHES	TYPICAL- LOSS & FREQ	MAX LOSS (DB) FREQUENCY (GHZ)						DASH NUMBER	PRICE ARMORED	PRICE*NO ARMOR
		1	3	5	10	18	20			
K CONNECTOR STRAIGHT J x STRAIGHT P ** H405-K0K1-										
12	1.55 @ 20	0.50	0.60	0.92	1.30	1.70	1.80	-0120A	\$130.00	Not Available
24	2.56 @ 20	0.60	0.80	1.40	2.00	2.70	2.80	-0240A	\$142.00	Not Available
36	3.57 @ 20	0.70	1.00	1.90	2.70	3.70	3.80	-0360A	\$153.00	Not Available
K CONNECTOR STRAIGHT P x STRAIGHT P ** H405-K0K0-										
12	1.55 @ 20	0.60	0.70	1.00	1.40	1.80	1.90	-0120A	\$130.00	Not Available
24	2.56 @ 20	0.70	0.90	1.50	2.10	2.80	2.90	-0240A	\$142.00	Not Available
36	3.57 @ 20	0.80	1.10	2.00	2.80	3.80	3.90	-0360A	\$153.00	Not Available
APC-7 CONNECTOR x APC-3.5 STRAIGHT P A250-3570-										
12	0.6 @ 18	0.28	0.35	0.39	0.44	0.80	---	-0120A	\$316.00	\$296.50
24	0.9 @ 18	0.30	0.46	0.50	0.60	1.00	---	-0240A	\$343.70	\$324.20
36	1.2 @ 18	0.40	0.60	0.70	0.80	1.26	---	-0360A	\$371.40	\$351.90
LENGTH IN INCHES	TYPICAL- LOSS & FREQ	MAX LOSS (DB) FREQUENCY (GHZ)						DASH NUMBER	PRICE ARMORED	PRICE*NO ARMOR
		3	10	20	30	40	50			
K CONNECTOR STRAIGHT P x STRAIGHT J A145-K0K1-										
12	2.02 @ 46	0.50	1.10	1.50	1.70	1.90	---	-0120A	\$253.00	\$227.00
24	3.23 @ 46	0.75	1.60	2.20	2.60	3.00	---	-0240A	\$273.00	\$239.60
36	4.44 @ 46	1.00	2.10	2.90	3.50	4.20	---	-0360A	\$293.00	\$252.20
K CONNECTOR STRAIGHT P x STRAIGHT P A145-K0K0-										
12	2.02 @ 46	0.60	1.20	1.60	1.80	2.00	---	-0120A	\$260.00	\$234.00
24	3.23 @ 46	0.85	1.70	2.30	2.70	3.10	---	-0240A	\$280.00	\$221.50
36	4.44 @ 46	1.10	2.20	3.00	3.60	4.30	---	-0360A	\$300.00	\$241.50
APC-3.5 STRAIGHT P x STRAIGHT J A145-3536-										
12	1.10 @ 34	0.50	0.80	1.00	1.30	---	---	-0120A	\$253.00	\$227.00
24	2.00 @ 34	0.70	1.40	1.70	2.20	---	---	-0240A	\$273.00	\$239.60
36	3.00 @ 34	1.00	1.50	2.40	3.10	---	---	-0360A	\$293.00	\$252.20
APC-3.5 STRAIGHT P x STRAIGHT P A145-3535-										
12	2.70 @ 34	0.60	0.90	1.10	1.40	---	---	-0120A	\$260.00	\$234.00
24	3.60 @ 34	0.80	1.50	1.80	2.30	---	---	-0240A	\$273.00	\$221.50
36	4.60 @ 34	1.10	1.60	2.50	3.20	---	---	-0360A	\$293.00	\$241.50

See Page B5 for Cable Characteristics

* Armored cables are warranted for two years against failure in normal use (except H405)

** Armored H405 series cables are warranted for six months against mechanical failure in normal use.

Ultra Low Loss Premium Flexible Cable 2.9 mm Male Plug x 2.9 mm Male Plug

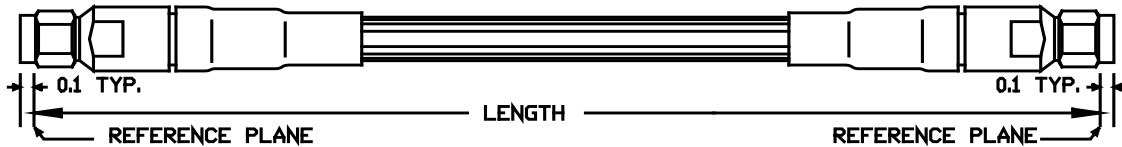

LENGTH IN INCHES	DASH NUMBER	160 50 Ω 0.89dB/ft @ 40 Ghz 3 shields <i>f</i> 160-290290-	190 50 Ω 0.49dB/ft @ 28 Ghz 3 shields <i>f</i> 190-290290-	1501 50 Ω 0.77 dB/ft @ 40 Ghz 2 shields <i>f</i> 1501-290290-
Solder Center, Soldered Clamp Outer with Strain Relief				
18	-0180	\$201.50	\$226.40	\$217.10
24	-0240	\$209.30	\$231.40	\$228.80
30	-0300	\$217.10	\$236.40	\$240.50
36	-0360	\$224.90	\$241.40	\$252.20

SMA Male Plug x SMA Male Plug

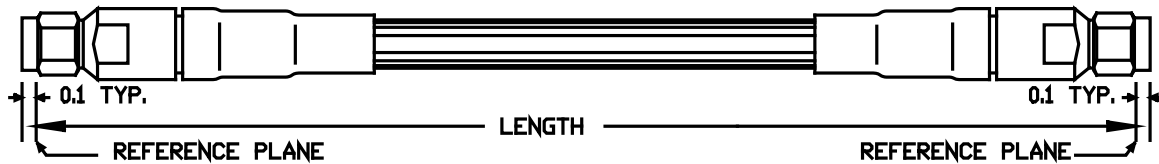

LENGTH IN INCHES	DASH NUMBER	190 50 Ω 0.49dB/ft @ 28 Ghz 3 shields <i>f</i> 190-M0M0-	290 50 Ω 0.20 dB/ft @ 18 Ghz 3 shields <i>f</i> 290-M0M0-
Solder Center, Soldered Clamp Outer with Strain Relief			
12	-0120	\$100.00	\$218.05
24	-0240	\$112.50	\$248.70
36	-0360	\$122.50	\$278.10
60	-0600	\$142.50	\$338.40

SMA Male Plug x SMA Right Angle Plug

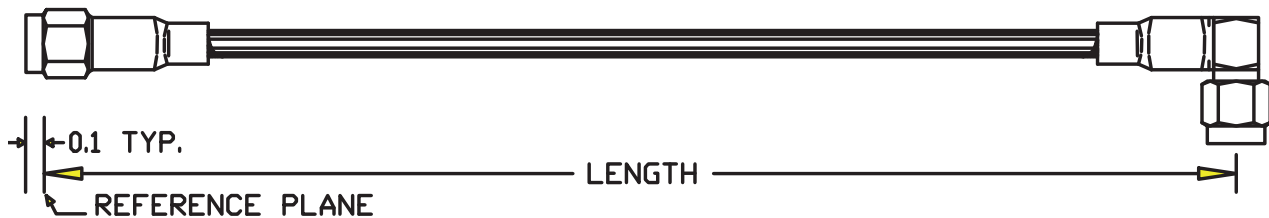

LENGTH IN INCHES	DASH NUMBER	190 50 Ω 0.49dB/ft @ 28 Ghz 3 shields <i>f</i> 190-M0M2-	290 50 Ω 0.20 dB/ft @ 18 Ghz 3 shields <i>f</i> 290-M0M2-
Solder Center, Soldered Clamp Outer with Strain relief			
24	-0240	\$148.75	\$184.75
36	-0360	\$158.75	\$194.70
48	-0480	\$168.75	\$204.75
96	-0960	\$208.75	\$244.80

10% Discount @ 25 pcs. up 4% Discount @ 10 pcs. up

EXTENDED DISTANCE QUIET CABLE PIN CONNECTIONS (EDQ)

Specifications:

Cable Construction: Twisted pairs covered with shorted foil shield to attenuate high frequency emissions and copper braid shield to attenuate low frequency emissions.

Number of Conductors: 4, 7, 12, 16, or 25

Conductor Gauge: 24 AWG, stranded copper

Connectors: DB25 (Gender is Customer Supplied)

Hoods: Molded on factory assembled cables; die cast metallic on field installed cables.

Capacitance: 12pf +/- 2 pf/ft

Impedance: 125 ohms per foot

<p>4 CONDUCTOR CABLE EM04C and EB04C</p> <ul style="list-style-type: none"> 2---Black 7---White 3---Red 20---Green <p>12 CONDUCTOR CABLE EM12C and EB12C</p> <ul style="list-style-type: none"> 1---Black 17---White 3---Red 6---Green 2---Brown 7---Blue 4---Orange 5---Yellow 8---Violet 15---Grey 22---Tan 20---Pink 	<p>7 CONDUCTOR CABLE EM07C and EB07C</p> <ul style="list-style-type: none"> 2---Black 8---White 4---Red 6---Green 3---Brown 7---Blue 20---Green/Yellow <p>16 CONDUCTOR CABLE EM07C and EB07C</p> <ul style="list-style-type: none"> 1---Black 17---White 3---Red 6---Green 2---Brown 7---Blue 4---Orange 5---Yellow 8---Violet 15---Grey 21---Tan 20---Pink 22---White/Blue 25---Brown/White 	<p>25 CONDUCTOR CABLE EM25C and EB25C</p> <ul style="list-style-type: none"> 19---Black 17---White 18---Red 16---Green 12---Brown 11---Blue 21---Orange 20---Yellow 13---Violet 14---Grey 25---Tan 24---Pink 9---White/Blue 10---Blue/White 5---White/Brown 6---Brown/White 2---White/Orange 4---Orange/White 1---White/Green 23---Green/White 2---White/Red 4---Red/White 1---White/Black 23---Black/White 22---Green/Yellow
---	---	---



RS-232 Style Shielded Cable Assemblies

Cable Designator (# of Cond.)	Cable	Capacitance Per Ft	Standard Connections *	Description Diameter	Cable Per Ft
4	J-EM04A	10 - 14	Pins 2, 3, 7, 8 & 20	Braided Shield w/Foil	1.30
6	I-1715	15.5	Pins 1, 2, 3, 7, 8 & 20	Braided Shield w/Foil	1.30
7	J-EM07A	10 - 14	Pins 2 -4, 6 - 8 & 20	Braided Shield w/Foil	1.70
10	I-1716	15.5	Pins 1 - 8 & 20	Braided Shield w/Foil	1.70
12	J-EM12A	10 - 14	Pins 1 - 8, 15, 17, 20 & 22	Braided shield w/Foil	1.75
15	1717	15.5	Pins 1 - 8, 13 - 15, 17, 20 & 24	Braided Shield w/Foil	1.80
16	J-EM16A	10 - 14	Pins 1 - 8, 15, 17, & 20 - 25	Braided Shield w/Foil	1.80
25	J-EM25A	10 - 14	Lines 1 - 25	Braided Shield w/Foil	1.90
36	BLDN9837	15.5	Pins 1, 2 & 4 - 37	Braided Shield w/Foil	3.36
37	J-EQ37A	10 - 14	Lines 1 - 37	Aluminum Polyester Foil	1.90

All cable is 24 AWG Twisted pair construction. No Drain Wire. Standard RF Depot assemblies use crimp pins with only connected pins inserted. All cables are supplied with deep metal backshell and a straight clamp.

Shell Size	Receptacle (Female)			Plug (Male)		
	Designator+	Shell Part No.	Assembled Price	Designator+	Shell Part No.	Assembled Price
9	9S	C/E 11.3316	9.45	9P	C/E 11.3306	9.25
15	15S	C/E 11.3336	12.50	15P	C/E 11.3326	12.30
25	25S	C/E 11.3356	15.00	25P	C/E 11.3346	14.50
37	37S	C/E 11.3376	20.00	37P	C/E 11.3366	19.25

* Pins 8 & 20 are jumpered together at each connector unless otherwise specified. Add \$0.75 to each connector for jumpering

Receptacle Contact (Socket) is C/E 11.3145 - 05, (\$9.75/100pk) and Plug Contact Pin is C/E 11.341 - 05, (\$7.18/100pk). Plating is 0.000010 in gold over .000030 in nickel.

+ For right angle metal backshell suffix designator S becomes RS for Receptacle and designator P becomes RP for Plug.

Typical part number is assembled with: Cable Designator - Connector 1 Connector 2 - length in tenth's of inches.

An example of a part number for a 5 ft (60 inch), 6 conductor cable with a D9S right angle connector on one end and a D9P straight connector on the other is: 6 - D9RSD9P - 600.

For special cables or other cables with non standard pinning, markers, labeling or special packaging requirements, or combinations of different connectors the factory will create a drawing for customer approval and assign a special part number. Example: 7988-XXX.

Coaxial Cable Performance Characteristics

MEETS OR EXCEEDS MIL- C17 SPECIFICATIONS WHERE APPLICABLE												
RG No. or M17/RG ** Designation	DIA Inches	No. of Shields	Operating Temp Range Deg C	Max Oper V RMS	Nominal db/100 feet				Price Per Foot 06-01-01			
					1 GHz	3 GHz	5 GHz	10 GHz	50	100	300	500
50 OHM FLEXIBLE COAXIAL CABLES												
RG55	.200	2	-55 to +80	1900	16.5	36	51	85	-	.65	.61	.56
RG58C	.195	1	-40 to + 80	1900	20	41	60	-	.23	.20	.20	.17
RG62	.146	1	-40 to + 80	750	8.5	18.4	29.5	-	-	-	.29	.28
RG122	.160	1	-40 to +80	1900	29.2	57.2	89	-	-	.30	.30	.28
RG141	.190	1	-55 to +250	1900	13	26	36	62	2.61	2.47	2.47	2.30
RG142B	.195	1	-55 to +200	1900	13	26	36	62	1.49	1.39	1.39	1.28
RG142LL	.195	2	-55 to +200	1900	12.5		30		3.50	3.26	3.26	3.01
RG174A	.100	1	-40 to + 80	1500	31	64.3	97	185	.17	.15	.12	.11
RD178	.080	2	-55 to +200	1000	45	78	115	172	-	-	-	3.36
RG178B	.075	1	-55 to +200	1000	45	78	115	172	.45	.32	.32	.29
RG188A	.110	1	-55 to +250	1200	30	58	79	133	.58	.54	.54	.50
RD188	.122	2	-55 to +250	1200	30	58	79	133	1.20	1.12	1.12	1.03
RG196A①	.080	1	-55 to +250	1000	45	78	115	172	.85	.41	.41	.38
RG213 ③	.405	1②	-40 to + 80	5000	9	19	28	47	.92	.76	.55	.34
RG214	.425	2	-40 to + 80	5000	9	19	28	47	1.86	1.73	1.73	1.60
RG217 ③	.545	2②	-40 to + 80	7000	5.8	13	19	31	1.25	1.16	1.16	1.08
RG218 ③	.870	1②	-40 to + 80	11000	3.8	9.0	13.5	-	4.50	4.19	4.19	3.87
RG219 ③	.945	1②	-40 to + 80	11000	3.8	9.0	13.5	-	10.00	9.30	8.60	8.00
RG223	.216	2	-40 to + 80	1900	16.5	36.0	51	85	.78	.73	.73	.67
RG225	.430	1	-55 to +250	5000	7.5	14.0	21	35	13.00	12.48	12.48	11.18
RG303	.170	1	-55 to +200	1900	13	26	36	62	1.20	1.12	1.12	1.03
RG316	.102	1	-55 to +200	1200	30	58	79	133	.53	.49	.49	.46
RD316	.114	2	-55 to +200	1200	30	58	79	133	1.10	1.02	1.02	.95
RG393	.390	2	-55 to +200	5000	7.5	14	21	35	5.50	5.12	5.12	4.73
RG400	.195	2	-55 to +200	1900	13	26	36	62	1.58	1.47	1.47	1.36
EF142	.195	2	-40 to +105	2500	16.8	33.5	-	-	2.04	1.84	1.66	1.34
EF178	.080	2	-40 to +105	1000	54	121	-	-	1.12	.96	.88	.80
EF316D	.120	2	-40 to +105	1500	26	54	-	-	.56	.48	.42	.39
EF393	.390	2	-40 to +105	5000	10	18.2	-	-	3.10	2.82	2.71	2.40
EF400	.195	2	-40 to +105	2500	18.2	33.5	-	-	2.08	1.97	1.97	1.81
SF214	.425	3	-40 to + 80	5000	8.0	12	17	30	4.40	3.77	3.21	2.89
SF142B	.195	3	-55 to +200	1900	12.5	25	33	50	4.20	3.85	3.70	3.55
SF316	.110	3	-55 to +200	1200	28	45	65	90	3.29	2.96	2.67	2.67
SF393	.390	3	-55 to +200	5000	8	12	17	30	12.00	11.20	10.50	10.00
SFT142	.180	3	-55 to +200	1000	10	18	25	32	-	8.80	8.80	8.80
SFT316	.120	3	-55 to +200	500	16	30	43	55	-	7.94	7.94	7.15
SFT393	.390	3	-55 to +200	2500	4.5	8	10	16	-	12.00	11.00	10.00
LMR-195	.195	2	-40 to + 85	-	11.1	19	25	-	.50	.44	.40	.38
LMR-200	.195	2③	-40 to + 85	-	8.3	16	28	-	0.68	0.68	0.56	0.47
LMR-240	.240	2③	-40 to + 85	-	7.9	12.5	21	-	.73	.74	.63	.55
LMR-300	.300	2	-40 to + 85	-	6.1	10.4	17	-	1.28	1.15	1.15	1.10
LMR-400	.405	2③	-40 to + 85	-	4.6	6.8	10.8	-	1.18	1.00	1.00	.85
LMR-400DB	.405	2	-40 to + 85	-	4.6	6.8	10.8	-	1.48	1.28	1.28	1.10
LMR-400UF	.405	2	-40 to + 85	-	4.6	6.8	10.8	-	1.58	1.38	1.38	1.20
LMR-500	.500	2	-40 to + 85	-	4.13	5.1	8.9	-	1.48	1.28	1.28	1.10
LMR-600	.590	2	-40 to + 85	-	3.31	4.5	7.3	-	1.48	1.28	1.26	1.14
SAX 1315	.405	1	-40 to + 80	600	4.5		12	-	.60	.60	.56	.47
50 OHM SEMI FLEXIBLE CORRUGATED COPPER OUTER COAXIAL CABLES												
LDF5-50A	1.09	1	-40 to + 85	6000	1.31	2.53	3.5	-	7.47	5.98	4.96	3.95
LDF4-50A	.630	1	-40 to + 85	4000	3.7	4.6	6.4	-	2.23	1.93	1.73	1.53
LDF2-50	.380	1	-40 to + 85	2500	3.5	6.5	8.7	13.5	1.34	1.18	1.13	1.09
FSJ1-50A	.290	1	-40 to + 85	1600	7.4	10.5	14	21.8	1.33	1.13	1.08	1.04
FSJ1P-50A	.290	1	-40 to + 85	1600	7.4	10.5	14	21.8	2.51	2.26	2.03	1.83

SR = SEMIRIGID
 CO = Conformable ④
 ** QPL Full swept frequency in most cases

① Replaced by RG 178
 ② Bare Copper Braid
 ③ Bare Copper Center Conductor



RF Depot.com Inc.

Phone 856-488-2000 Fax 856-488-2020

Coaxial Cable Performance Characteristics

MEETS OR EXCEEDS MIL- C17 SPECIFICATIONS WHERE APPLICABLE												
RG No. or M17/RG ** Designation	DIA Inches	No. of Shields	Operating Temp Range Deg C	Max Oper V RMS	Nominal db/100 feet				Price Per Foot 06-01-01			
					1 GHz	3 GHz	5 GHz	10 GHz	50	100	300	500
75 OHM FLEXIBLE COAXIAL CABLES												
RG6	.332	2	-40 to +80	2700	17.8	-	-	-	.75	.68	.65	.62
RG11	.405	1	-40 to +80	4000	7.7	-	-	-	.60	.56	.56	.49
RG59	.242	1	-40 to +80	2300	11.4	-	-	-	.30	.27	.21	.19
RG179	.100	1	-40 to +150	1200	16.5	26.5	-	-	.55	.44	.36	.33
RG187	.105	1	-55 to +250	1200	26.5				1.01	.94	.94	.88
RG216	.425	2	-40 to +80	5000	7.7	14.9	-	-	.90	.55	.50	.47
EF179	.100	1	-40 to +105	1500	25.9	-	-	-	1.00	.93	.93	.86
FSJ1-75	.290	1	-40 to + 85	1600	7.4	10.5	-	-	1.67	1.51	1.45	1.39
FSJ4-75A	.520	1	-40 to + 85	2500	4.5	7.5	-	-	3.70	-	-	3.44
50 OHM SEMIRIGID CABLES												
M17/129-RG401	.250	①	-40 to +90	3000	7.5	11	33	48	6.72	6.05	5.80	5.45
M17/129-00001	.250	②③	-40 to +90	3000	7.5	11	33	48	8.85	7.97	7.60	7.17
M17/130-00004	.141	④⑤⑥	-40 to +125	1900	12	21	29	45	2.01	1.65	1.49	1.33
M17/130-00005	.141	⑦⑧⑨	-40 to +125	1900	12	21	29	45	2.31	1.95	1.79	1.63
M17/130-00009	.141	⑩⑪	-40 to +125	1900	12	21	29	45	3.18	3.10	2.62	2.13
M17/130-00012	.141	⑫⑬	-40 to +125	1900	12	21	29	45	3.83	3.17	3.17	3.17
M17/133-00006	.085	⑭⑮	-40 to +125	1500	22	50	80	130	1.40	1.22	1.07	.97
M17/133-00007	.085	⑯⑰	-40 to +125	1500	22	50	80	130	1.70	1.52	1.37	1.27
M17/133-00013	.085	⑱⑲	-40 to +125	1500	22	50	80	130	3.45	3.01	3.00	2.97
M17/133-00016	.085	⑳㉑	-40 to +125	1500	22	50	80	130	3.83	3.17	3.17	3.17
M17/151-00001	.047	㉒㉓	-40 to +100	1000	40	70	90	130	2.86	2.03	1.95	1.87
M17/151-00002	.047	㉔㉕	-40 to +100	1000	40	70	90	130	2.86	2.03	1.95	1.87
M17/154-00001	.034	㉖㉗	-40 to +100	750	40	65	90	130	3.80	2.65	2.65	2.20
M17/154-00002	.034	㉘㉙	-40 to +100	750	60	100	140	190	3.91	2.80	2.80	2.40
.020SR	.020	㉚㉛	-40 to +125	350	85	145	195	278	6.00	5.58	5.58	5.16
50 OHM CONFORMABLE CABLES												
T-Flex 401	.270	CO	-65 to +125	3000	12	15	20	30	8.09	7.28	6.55	5.90
T-Flex-402	.160	CO	-65 to +125	1900	17	22	30	45	5.76	5.56	5.40	5.18
T-Flex-405	.104	CO	-65 to +125	1500	30	38	51	75	7.00	6.72	6.45	6.19
.047 MaxiFlex	.047	CO	-70 to +200	1000	39	65	95	120	3.00	2.79	2.79	2.58
.085 MaxiFlex	.085	CO	-70 to +200	1500	22	30	60	83	2.35	2.04	1.86	1.78
.141 MaxiFlex	.141	CO	-70 to +200	1900	12	22	35	45	2.60	2.08	2.08	1.00
.250 MaxiFlex	.250	CO	-70 to +200	5000	7	12	18	30	6.00	5.58	5.58	5.16
75 OHM CONFORMABLE CABLES												

RG No. or M17/RG ** Designation	DIA Inches	No. of Shields	Operating Temp Range Deg C	Max Oper V RMS	Nominal db/100 feet				Price Per Foot 06-01-01			
					1 GHz	1.5 GHz	2 GHz	10 GHz	50	100	500	2000
.085 Maxiflex 75Ω	.085	CO	- 70 to +200	-	24.7	31.0	36.3	-	3.35	3.04	2.86	2.78

SR = SEMIRIGID. A \$12.00 packing charge applies to 300' or less in 5 ft straight lengths. CO = Conformable ④
 ** QPL Full swept frequency in most cases
 Note: SEMIRIGID over 8 ft. long must ship via truck or be coiled. Some items 20' straight.

- ① Replaced by RG 178
- ② Bare Copper Braid
- ③ Bare Copper Center Conductor
- ④ Conformable is a Registered trademark of Belden Electronics Division

- ① Plain copper tube outer conductor
- ② Silver plated copper outer conductor
- ③ Tin plated copper outer conductor
- ④ Plain aluminum outer conductor
- ⑤ Tin plated aluminum outer conductor
- ⑥ Bare copper center conductor

- ⑦ Silver plated copper clad steel center conductor
- ⑧ Silver plated copper clad steel center conductor
- ⑨ Silver plated copper center conductor
- ⑩ Traditional hard temper copper outer
- ⑪ Modern soft temper copper outer



POWER CONVERSION TABLE

DECIBELS-VOLTS-WATTS CONVERSION TABLE FOR A 50 OHM SYSTEM											
dBm	V	P _o	dBm	V	P _o	dBm	V	P _o	dBm	V	P _o
+53	100.0	200 W	0	.225	1.0 mW	49	0.80		99	2.51	
+50	70.7	100 W	1	.200	.80 mW	50	0.71	.01 uW	100	2.25	.1 pW
+49	64.0	80 W	2	.180	.64 mW	51	0.64		101	2.0	
+48	58.0	64 W	3	.160	.50 mW	52	0.57		102	1.8	
+47	50.0	50 W	4	.141	.40 mW	53	0.50		103	1.6	
+46	44.5	40 W	5	.125	.32 mW	54	0.45		104	1.41	
+45	40.0	32 W	6	.115	.25 mW	55	0.40		105	1.27	
+44	32.5	25 W	7	.100	.20 mW	56	0.351		106	1.18	
+43	32	20 W	8	.090	.16 mW	57	0.32		dBm	NV	
+42	28	16 W	9	.080	.125 mW	58	0.286		107	1000	
+41	26.2	12.5 W	10	.071	.10 mW	59	0.251		108	900	
+40	22.5	10 W	11	.064		60	0.225	.001 uW	109	800	
+39	20.0	8 W	12	.058		61	0.200		110	710	.01 pW
+38	18.0	6.4 W	13	.050		62	0.180		111	640	
+37	16.0	5 W	14	.045		63	0.160		112	580	
+36	14.1	4 W	15	.040		64	0.141		113	500	
+35	12.5	3.2 W	16	.035		dBm	uV		114	450	
+34	11.5	2.5 W	dBm	mV		65	128		115	400	
+33	10.0	2 W	17	31.5		66	115		116	355	
+32	9.00	1.6 W	18	28.5		67	100		117	325	
+31	8.00	1.25 W	19	25.1		68	90		118	285	
+30	7.10	1 W	20	22.5	.01 mW	69	80		119	251	
+29	6.40	800 mW	21	20.0		70	71	.1 nW	120	225	.001 pW
+28	5.80	640 mW	22	17.9		71	65		121	200	
+27	5.00	500 mW	23	15.9		72	58		122	180	
+26	4.45	400 mW	24	14.1		73	50		123	160	
+25	4.00	320 mW	25	12.8		74	45		124	141	
+24	3.55	250 mW	26	11.5		75	40		125	128	
+23	3.20	200 mW	27	10.0		76	35		126	117	
+22	2.80	160 mW	28	8.9		77	32		127	100	
+21	2.52	125 mW	29	8.0		78	29		128	90	
+20	2.25	100 mW	30	7.1	.001 mW	79	25		129	80	.1 fW
+19	2.00	80 mW	31	6.25		80	22.5	.01 nW	130	71	
+18	1.80	64 mW	32	5.8		81	20.0		131	61	
+17	1.60	50 mW	33	5.0		82	18.0		132	58	
+16	1.41	40 mW	34	4.5		83	16.0		133	50	
+15	1.25	32 mW	35	4.0		84	14.1		134	45	
+14	1.15	25 mW	36	3.5		85	12.9		135	40	
+13	1.00	20 mW	37	3.2		86	11.5		136	35	
+12	.900	16 mW	38	2.85		87	10.0		137	33	
+11	.800	12.5 mW	39	2.5		88	9.0		138	29	
+10	.710	10 mW	40	2.25	.1 uW	89	8.0		139	25	
+9	.640	8 mW	41	2.0		90	7.1	.001 nW	140	23	.01 fW
+8	.580	6.4 mW	42	1.8		91	6.1				
+7	.500	5 mW	43	1.6		92	5.75				
+6	.445	4 mW	44	1.4		93	5.0				
+5	.400	3.2 mW	45	1.25		94	4.5				
+4	.355	2.5 mW	46	1.18		95	4.0				
+3	.320	2 mW	47	1.00		96	3.51				
+2	.280	1.6 mW	48	0.90		97	3.2				
+1	.252	1.25 mW	49	.080		98	2.9				



ALLIGATOR CLIPS X BNC MALE PLUG

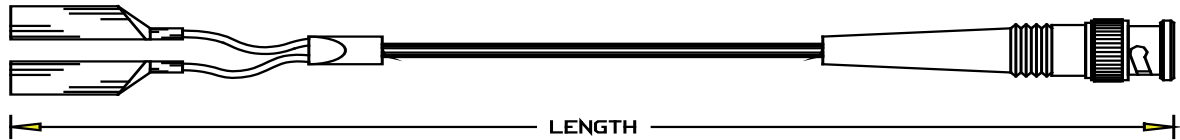

LENGTH IN INCHES	DASH NUMBER	50 Ω RG 58C ③⑥⑦ 1 shield 058-BABA0-	93 Ω RG 62 ③⑤⑧ 1 shield 062-BABA0-	75 Ω RG 59B ③⑤⑧ 1 shield 059-BABA0-	50 Ω RG 223 ③①⑦ 2 shields 223-BABA0-	50 Ω RG 400*④① 2 shields⑦ 400-BABA0-
Crimp, with Boot						
12	-0120	\$30.15	\$30.15	\$31.50	\$33.15	\$34.15
24	-0240	\$30.35	\$30.50	\$31.72	\$33.88	\$35.65
30	-0300	\$30.55	\$30.85	\$31.94	\$34.61	\$37.15
36	-0360	\$30.55	\$30.85	\$31.94	\$34.61	\$37.15
48	-0480	\$30.75	\$31.20	\$32.16	\$35.34	\$38.65
60	-0600	\$31.15	\$31.90	\$32.60	\$36.80	\$41.65
72	-0720	\$31.35	\$32.25	\$32.82	\$37.53	\$43.15

BANANA PLUG X BANANA PLUG

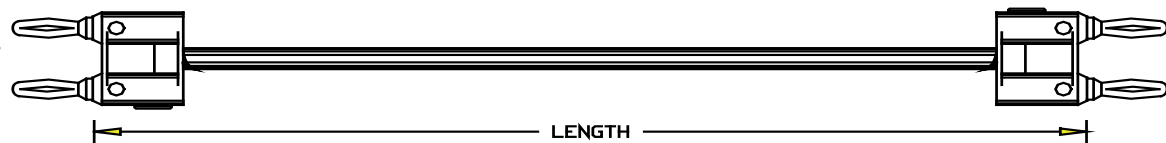

LENGTH IN INCHES	DASH NUMBER	50 Ω RG 223 ③①⑦ 2 shields 223-BB0BB0-	50 Ω RG 58C ③⑥⑦ 1 shield 058-BB0BB0-	50 Ω RG 174 ③⑤ 1 shield⑦ 174-BB0BB0-	50 Ω RG 316 ④② 1 shield⑩ 316-BB0BB0-	50 Ω RD 316 ④② 2 shields⑦ 31D-BB0BB0-	50 Ω RG 142B ④② 2 shields⑦ 142-BB0BB0-
Solder Center, Solder Shield							
12	-0120	\$29.80	\$27.20	\$29.80	\$31.05	\$32.40	\$29.80
24	-0240	\$30.53	\$27.40	\$29.92	\$31.37	\$33.33	\$30.75
30	-0300	\$31.26	\$27.60	\$30.04	\$31.69	\$34.26	\$31.70
36	-0360	\$31.26	\$27.60	\$30.04	\$31.69	\$34.26	\$31.70
48	-0480	\$31.99	\$27.80	\$30.16	\$32.01	\$35.19	\$32.65
60	-0600	\$33.45	\$28.20	\$30.40	\$32.65	\$37.05	\$34.55
72	-0720	\$34.18	\$28.40	\$30.52	\$32.97	\$37.98	\$35.50
Color Designators (add letter to the end of the part number and add \$1.00 to price)							
Black - B		Blue - L		Brown - N		Gray - A	
Orange - O		Red - R		Violet - V		Green - G	
						White - W	

See Page B5 for Cable Characteristics

* Contact Factory for delivery, Consider new RD316 for (RD188)

10% Discount @ 25 pcs. up

4% Discount @ 10 pcs. up

BANANA PLUG X UHF MALE PLUG

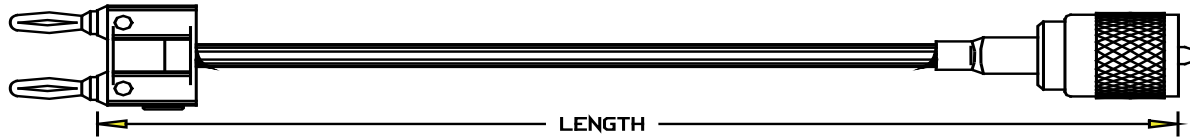

LENGTH IN INCHES	DASH NUMBER	50 Ω RG 58C ^{③⑦} 1 shield 058-UABB0-	93 Ω RG 62 ^{③⑤⑥} 1 shield 062-UABB0-	50 Ω RG 223 ^{③①⑦} 2 shields 223-UABB0-	50 Ω SIG 100 ^{③⑤⑨} 2 shields 1LC-UABB0-	50 Ω LMR 100 ^{③⑤} 2 shields ^⑨ 1LM-UABB0-
Solder Center, Crimp Outer with Strain Relief						
12	-0120	\$18.50	\$17.50	\$16.76	\$17.00	\$18.11
24	-0240	\$18.90	\$17.90	\$18.76	\$17.54	\$21.46
36	-0360	\$19.30	\$18.30	\$20.76	\$18.08	\$25.33
48	-0480	\$19.70	\$18.70	\$22.76	\$18.62	\$28.16
60	-0600	\$20.50	\$19.50	\$24.76	\$19.70	\$31.48
72	-0720	\$20.90	\$19.90	\$26.76	\$20.24	\$34.86

BANANA PLUG X BNC MALE PLUG

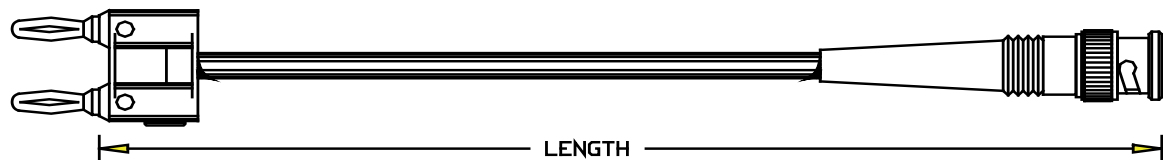

LTH IN INS	DASH NUM	50 Ω RG 223 ^{③①} 2 shields ^⑦ 223-BABB0-	50 Ω ^{③⑥} RG 58C ^⑦ 1 shield 058-BABB0-	50 Ω RG 174 ^{③⑤} 1 shield ^⑦ 174-BABB0-	50 Ω ^④ RG 316 ^② 1 shield ^⑩ 316-BABB0-	50 Ω ^④ RD316 ^{②⑦} 2 shields 31D-BABB0-	50 Ω RG 142B ^{④②} 2 shields ^⑦ 142-BABB0-	50 Ω RG 400 ^{✱④①} 2 shields ^⑦ 400-BABB0-
Solder Center, Crimp Outer with Strain Relief								
12	-0120	\$16.30	\$15.70	\$19.80	\$22.05	\$23.40	\$20.80	\$20.80
24	-0240	\$17.80	\$16.10	\$20.05	\$24.00	\$29.10	\$24.40	\$23.40
36	-0360	\$19.30	\$16.50	\$20.30	\$25.95	\$34.80	\$28.00	\$26.00
48	-0480	\$20.80	\$16.90	\$20.55	\$27.90	\$40.50	\$31.60	\$28.60
60	-0600	\$23.80	\$17.70	\$21.05	\$31.80	\$51.90	\$38.80	\$33.80
72	-0720	\$25.30	\$18.10	\$21.30	\$33.75	\$57.60	\$42.40	\$36.40
Color Designators (add letter to the end of the part number and add \$1.00 to price)								
Black - B		Blue - L		Brown - N		Gray - A		Green - G
Orange - O		Red - R		Violet - V		Yellow - Y		White - W

See Page B5 for Cable Characteristics

* Contact Factory for delivery, Consider new RD316 for (RD188) 10% Discount @ 25 pcs. up 4% Discount @ 10 pcs. up

BNC Female Bulkhead Jack X BNC Male Plug

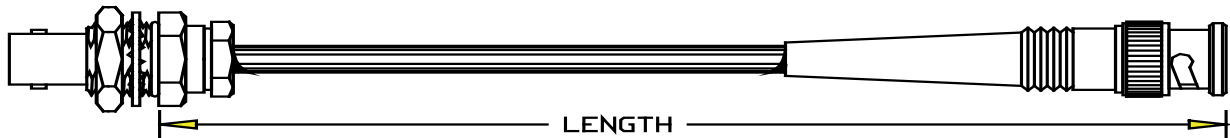

LENGTH IN INCHES	DASH NUMBER	50 Ω RG 58C ^{③⑥⑦} 1 shield 058-BABF-	50 Ω RG 223 ^{③①⑦} 2 shields 223-BABF-	50 Ω RG 142B ^{④②} 2 shields ^⑦ 142-BABF-	50 Ω RG 400 ^{④①⑦*} 2 shields 400-BABF-		
Solder Center, Crimp Outer							
12	-0120	\$19.28	\$21.50	\$22.33	\$23.03		
24	-0240	\$19.68	\$22.97	\$24.63	\$26.03		
36	-0360	\$20.08	\$24.44	\$26.93	\$29.03		
48	-0480	\$20.48	\$25.91	\$29.23	\$32.03		
60	-0600	\$20.88	\$27.38	\$31.53	\$35.03		
72	-0720	\$21.28	\$28.85	\$33.83	\$38.03		
Solder Center, Crimp Outer							
LENGTH IN INCHES	DASH NUMBER	50 Ω RG 174 ^{③⑤} 1 shield ^⑦ 174-BABF-	50 Ω RG 316 ^{④②} 1 shield ^⑩ 316-BABF-	50 Ω ^④ RD316 ^{②⑦} 2 shields 31D-BABF-	50 Ω RG188* ^{④②} 1 shield ^⑩ 188-BABF-	50 Ω ^④ RD188* ^② 2 shields ^⑦ 88D-BABF-	75 Ω RG179A ^{④②} 1 shield ^⑩ 179-BABF-
12	-0120	\$19.29	\$21.66	\$22.93	\$22.01	\$24.60	\$19.97
24	-0240	\$19.53	\$22.31	\$24.78	\$23.01	\$28.12	\$20.70
36	-0360	\$19.77	\$22.96	\$26.63	\$24.01	\$31.64	\$21.43
48	-0480	\$20.01	\$23.61	\$28.48	\$25.01	\$35.16	\$22.16
60	-0600	\$20.25	\$24.26	\$30.33	\$26.01	\$38.68	\$22.89
72	-0720	\$20.49	\$24.91	\$32.18	\$27.01	\$42.20	\$23.62
Solder Center, Crimp Outer							
LENGTH IN INCHES	DASH NUMBER	50 Ω RG 8* ^{③③⑧} 1 shield 008-BABF-	50 Ω RG 213 ^{③③⑧} 1 shield 213-BABF-	50 Ω RG 214 ^{③①} 2 shields ^⑦ 214-BABF-	75 Ω RG 59B ^{③⑤⑧} 1 shield 059-BABF-	93 Ω RG 62 ^{③⑤⑧} 1 shield 062-BABF-	
12	-0120	\$26.43	\$26.61	\$28.93	\$31.86	\$32.12	
24	-0240	\$27.83	\$28.19	\$32.43	\$32.30	\$32.82	
36	-0360	\$29.23	\$29.77	\$35.93	\$32.74	\$33.52	
48	-0480	\$30.63	\$31.35	\$39.43	\$33.18	\$34.22	
60	-0600	\$32.03	\$32.93	\$42.93	\$33.62	\$34.92	
72	-0720	\$33.43	\$34.51	\$46.43	\$34.06	\$35.62	
Color Designators (add letter to the end of the part number and add \$1.00 to price)							
Black - B		Blue - L		Brown - N		Gray - A	
Orange - O		Red - R		Violet - V		Green - G	
						White - W	

See Page B5 for Cable Characteristics

* Contact Factory for delivery, Consider new RD316 for (RD188) 10% Discount @ 25 pcs. up 4% Discount @ 10 pcs. up

BNC Female Bulkhead Jack x SMA Male Plug

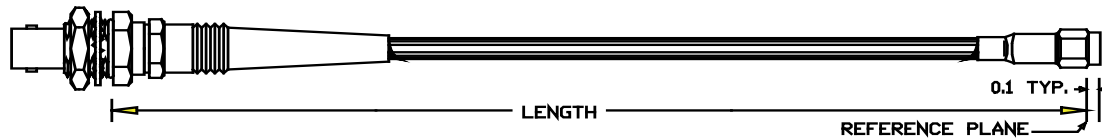

LENGTH IN INCHES	DASH NUMBER	50 Ω RG 58C ^{③⑥⑦} 1 shield 058-BFMA-	50 Ω RG 223 ^{③①⑦} 2 shields 223-BFMA-	50 Ω RG 142B ^{④⑦} 2 shields ^⑦ 142-BFMA-	50 Ω RG 400 ^{✕④①} 2 shields ^⑦ 400-BFMA-				
Solder Center, Crimp Outer									
12	-0120	\$23.90	\$27.65	\$28.48	\$29.18				
18	-0180	\$24.10	\$28.39	\$29.63	\$30.68				
24	-0240	\$24.30	\$29.12	\$30.78	\$32.18				
30	-0300	\$24.50	\$29.86	\$31.93	\$33.68				
36	-0360	\$24.70	\$30.59	\$33.08	\$35.18				
42	-0420	\$24.90	\$31.33	\$34.23	\$36.68				
48	-0480	\$25.10	\$32.06	\$35.38	\$38.18				
54	-0540	\$25.30	\$32.80	\$36.53	\$39.68				
60	-0600	\$25.50	\$33.53	\$37.68	\$41.18				
66	-0660	\$25.70	\$34.27	\$38.83	\$42.68				
72	-0720	\$25.90	\$35.00	\$39.98	\$44.18				
Solder Center, Crimp Outer									
LENGTH IN INCHES	DASH NUMBER	50 Ω RG 174 ^{③⑤} 1 shield ^⑦ 174-BFMA-	50 Ω RG 316 ^{④②} 1 shield ^⑩ 316-BFMA-	50 Ω ^④ RD316 ^{②⑦} 2 shields 31D-BFMA-	50 Ω RG188* ^{④②} 1 shield ^⑩ 188-BFMA-	50 Ω RG 178B/U ^② 1 shield ^⑩ 178-BFMA-			
12	-0120	\$22.46	\$22.87	\$26.10	\$23.22	\$33.28			
18	-0180	\$22.58	\$23.20	\$27.03	\$23.72	\$33.65			
24	-0240	\$22.70	\$23.52	\$27.95	\$24.22	\$34.02			
30	-0300	\$22.82	\$23.85	\$28.88	\$24.72	\$34.39			
36	-0360	\$22.94	\$24.17	\$29.80	\$25.22	\$34.76			
42	-0420	\$23.06	\$24.50	\$30.73	\$25.72	\$35.13			
48	-0480	\$23.18	\$24.82	\$31.65	\$26.22	\$35.50			
54	-0540	\$23.30	\$25.15	\$32.58	\$26.72	\$35.87			
60	-0600	\$23.42	\$25.47	\$33.50	\$27.22	\$36.24			
66	-0660	\$23.54	\$25.80	\$34.43	\$27.72	\$36.61			
72	-0720	\$23.66	\$26.12	\$35.35	\$28.22	\$36.98			
Color Designators (add letter to the end of the part number and add \$1.00 to price)									
Black - B		Blue - L		Brown - N		Gray - A		Green - G	
Orange - O		Red - R		Violet - V		Yellow - Y		White - W	

See Page B5 for Cable Characteristics

* Contact Factory for delivery, Consider new RD316 for (RD188) 10% Discount @ 25 pcs. up 4% Discount @ 10 pcs. up

BNC Female Bulkhead Jack x SMA Male Plug

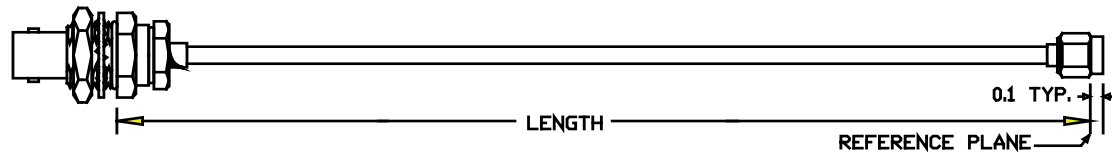

LENGTH IN INCHES	DASH NUMBER	50Ω RG 401① M17/129-RG401 .250 Cu Jacket 401-B5M0-	50Ω RG 401① (No QPL List) .250 Tin Plate Al 25A-B5M0-	50Ω RG 401② M17/129-00001 .250 Tin Plate Cu 2TS-B5M0-	50Ω MaxiFlex② (No QPL List) .250 Tin Plate Braid 25F-B5M0-	
.250" Diameter SEMIRIGID and Maxi Flex. Direct Solder Connectors						
12	-0120C	\$88.94	\$89.88	\$94.13	\$88.94	
24	-0240C	\$91.96	\$93.84	\$102.34	\$91.96	
36	-0360C	\$94.98	\$97.80	\$110.55	\$94.98	
48	-0480C	\$98.00	\$101.76	\$118.76	\$98.00	
60	-0600C	\$101.02	\$105.72	\$126.97	\$101.02	
72	-0720C	\$104.04	\$109.68	\$135.18	\$104.04	
Stainless Steel SMA Available, Contact Factory						
.141" Diameter SEMIRIGID and Maxi Flex. Direct Solder Connectors						
LENGTH IN INCHES	DASH NUMBER	50Ω RG 402② M17/130-00004 .141 Cu Jacket 402-B5M0-	50Ω RG 402② M17/130-00005 .141 Tin Plate Cu 1TS-B5M0-	50Ω RG 402① M17/130-00009 .141 Tin Plate Al 1AT-B5M0-	50Ω MaxiFlex② (No QPL List) .141 Tin Plate Braid 14F-B5M0-	50Ω RG 402② M17/130-00012 .141 Silver Pl 1SS-B5M0-
12	-0120	\$24.93	\$24.57	\$24.93	\$24.57	\$34.14
24	-0240	\$28.53	\$27.81	\$28.53	\$27.81	\$46.95
36	-0360	\$32.13	\$31.05	\$32.13	\$31.05	\$59.76
48	-0480	\$35.73	\$34.29	\$35.73	\$34.29	\$72.57
60	-0600	\$39.33	\$37.53	\$39.33	\$37.53	\$85.38
72	-0720	\$42.93	\$40.77	\$42.93	\$40.77	\$98.19
.085" Diameter SEMIRIGID and Maxi Flex. Direct Solder Connectors						
LENGTH IN INCHES	DASH NUMBER	50Ω RG 405② M17/133-00007 .085 Tin Plate Cu 405-B5M0-	50Ω RG 405② M17/133-00007 .085 Tin Plate Cu 8TS-B5M0-	50Ω RG 405② M17/133-00013 .085 Tin Plate Al 8AT-B5M0-	50Ω MaxiFlex② (No QPL List) .085 Tin Pl 08F-B5M0-	50Ω RG 405② M17/133-00016 .085 Silver Pl 8SS-B5M0-
12	-0120	\$24.35	\$24.35	\$25.29	\$25.58	\$29.54
24	-0240	\$27.37	\$27.37	\$29.25	\$29.83	\$37.75
36	-0360	\$30.39	\$30.39	\$33.21	\$34.08	\$45.96
48	-0480	\$33.41	\$33.41	\$37.17	\$38.33	\$54.17
60	-0600	\$36.43	\$36.43	\$41.13	\$42.58	\$62.38
72	-0720	\$39.45	\$39.45	CALL	\$46.83	CALL

①Silver Plated Copper Center Conductor ②Silver Plated Copper Clad Steel Center Conductor

10% Discount @ 25 pcs. up 4% Discount @ 10 pcs. up



BNC Female Bulkhead Jack x SMA Right Angle Male Plug

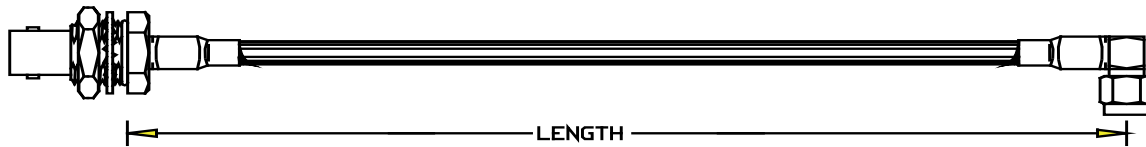

LENGTH IN INCHES	DASH NUMBER	50 Ω RG 58C ^{③⑥⑦} 1 shield 058-BFMC-	50 Ω RG 223 ^{③①⑦} 2 shields 223-BFMC-	50 Ω RG 142B ^{④②} 2 shields ^⑦ 142-BFMC-	50 Ω RG 400 ^{✕④①} 2 shields ^⑦ 400-BFMC-		
Solder Center, CrimpClamp Outer							
12	-0120E	\$63.73	\$62.56	\$63.39	\$64.09		
18	-0180E	\$63.93	\$63.30	\$64.54	\$65.59		
24	-0240E	\$64.13	\$64.03	\$65.69	\$67.09		
30	-0300E	\$64.33	\$64.77	\$66.84	\$68.59		
36	-0360E	\$64.53	\$65.50	\$67.99	\$70.09		
42	-0420E	\$64.73	\$66.24	\$69.14	\$71.59		
48	-0480E	\$64.93	\$66.97	\$70.29	\$73.09		
54	-0540E	\$65.13	\$67.71	\$71.44	\$74.59		
60	-0600E	\$65.33	\$68.44	\$72.59	\$76.09		
66	-0660E	\$65.53	\$69.18	\$73.74	\$77.59		
72	-0720E	\$65.73	\$69.91	\$74.89	\$79.09		
Solder Center, CrimpClamp Outer							
LENGTH IN INCHES	DASH NUMBER	50 Ω RG 174 ^{③⑤} 1 shield ^⑦ 174-BFMC-	50 Ω RG 316 ^{④②} 1 shield ^⑧ 316-BFMC-	50 Ω ^④ RD316 ^{②⑦} 2 shields 31D-BFMC-	50 Ω RG188* ^{④②} 1 shield ^⑧ 188-BFMC-	50 Ω RG 178B/U ^② 1 shield ^⑧ 178-BFMC-	
12	-0120E	\$45.08	\$45.49	\$39.60	\$45.84	\$52.75	
18	-0180E	\$45.20	\$45.82	\$40.53	\$46.34	\$53.12	
24	-0240E	\$45.32	\$46.14	\$41.45	\$46.84	\$53.49	
30	-0300E	\$45.44	\$46.47	\$42.38	\$47.34	\$53.86	
36	-0360E	\$45.56	\$46.79	\$43.30	\$47.84	\$54.23	
42	-0420E	\$45.68	\$47.12	\$44.23	\$48.34	\$54.60	
48	-0480E	\$45.80	\$47.44	\$45.15	\$48.84	\$54.97	
54	-0540E	\$45.92	\$47.77	\$46.08	\$49.34	\$55.34	
60	-0600E	\$46.04	\$48.09	\$47.00	\$49.84	\$55.71	
66	-0660E	\$46.16	\$48.42	\$47.93	\$50.34	\$56.08	
72	-0720E	\$46.28	\$48.74	\$48.85	\$50.84	\$56.45	
Color Designators (add letter to the end of the part number and add \$1.00 to price)							
Black - B		Blue - L		Brown - N		Gray - A	
Orange - O		Red - R		Violet - V		Green - G	
						White - W	

See Page B5 for Cable Characteristics

* Contact Factory for delivery, Consider new RD316 for (RD188) 10% Discount @ 25 pcs. up 4% Discount @ 10 pcs. up



RF Depot.com Inc.

Phone 856-488-2000 Fax 856-488-2020

BNC Female Bulkhead Jack x SMA Right Angle Male Plug

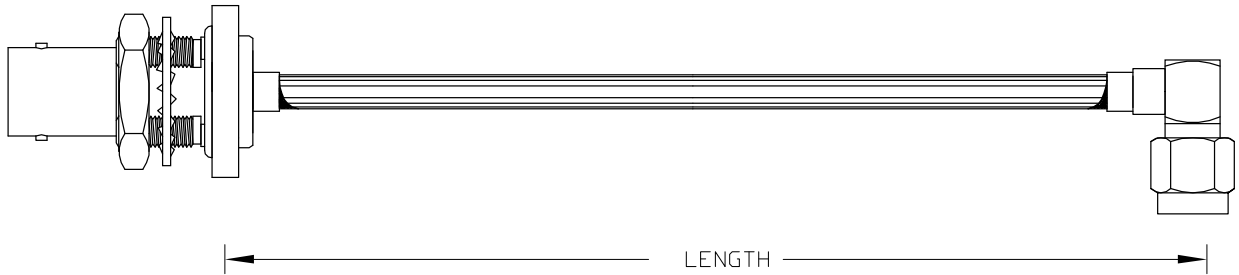

LTH IN INS	DASH NUM	50Ω RG 405 [Ⓢ] M17/133-00007 .085 Tin Pl Cu 405-B5M2-	50Ω RG 405 [Ⓢ] M17/133-00007 .085 Tin Pl Cu 8TS-B5M2-	50Ω RG 405 [Ⓢ] M17/133-00013 .085 Tin Pl Al 8AT-B5M2-	50ΩMaxiFlex (No QPL List) .085 Tin Pl [Ⓢ] 08F-B5M2-	50Ω RG 405 [Ⓢ] M17/133-00016 .085 Silver Pl 8SS-B5M2-	50 Ω MaxiFlex (No QPL List) .085 Tin Pl [Ⓢ] 08J-B5M2-
.085" Diameter SEMIRIGID and Maxi Flex. Direct Solder Connectors							
12	-0120	\$42.99	\$42.99	\$43.93	\$44.22	\$48.18	\$43.78
24	-0240	\$46.01	\$46.01	\$47.89	\$48.47	\$56.39	\$47.59
36	-0360	\$49.03	\$49.03	\$51.85	\$52.72	\$64.60	\$51.40
48	-0480	\$52.05	\$52.05	\$55.81	\$56.97	\$72.81	\$55.21
60	-0600	\$55.07	\$55.07	\$59.77	\$61.22	\$81.02	\$59.02
72	-0720	\$58.09	\$58.09	CALL	\$65.47	CALL	\$62.83
.141" Diameter SEMIRIGID and Maxi Flex. Direct Solder Connectors							
LTH IN INS	DASH NUM	50Ω RG 402 [Ⓢ] M17/130-00004 .141 Cu Jacket 402-B5M2-	50Ω RG 402 [Ⓢ] M17/130-00005 .141 Tin Pl Cu 1TS-B5M2-	50Ω RG 402 [Ⓢ] M17/130-00009 .141 Tin Pl Al 1AT-B5M2-	50ΩMaxiFlex (No QPL List) .141 Tin Pl [Ⓢ] 14F-B5M2-	50Ω RG 402 [Ⓢ] M17/130-00012 .141 Silver Pl 1SS-B5M2-	50 Ω MaxiFlex (No QPL List) .141 Tin Pl [Ⓢ] 14J- B5M2-
12	-0120E	\$46.23	\$45.87	\$46.23	\$45.87	\$55.44	\$46.53
24	-0240E	\$49.83	\$49.11	\$49.83	\$49.11	\$68.25	\$50.43
36	-0360E	\$53.43	\$52.35	\$53.43	\$52.35	\$81.06	\$54.33
48	-0480E	\$57.03	\$55.59	\$57.03	\$55.59	\$93.87	\$58.23
60	-0600E	\$60.63	\$58.83	\$60.63	\$58.83	\$106.68	\$62.13
72	-0720E	\$64.23	\$62.07	\$64.23	\$62.07	\$119.49	\$66.03
.085" Diameter SEMIRIGID and Maxi Flex. Direct Solder Connectors							
LTH IN INS	DASH NUM	50Ω RG 405 [Ⓢ] M17/133-00007 .085 Tin Pl Cu 405-B5M2-	50Ω RG 405 [Ⓢ] M17/133-00007 .085 Tin Pl Cu 8TS-B5M2-	50Ω RG 405 [Ⓢ] M17/133-00013 .085 Tin Pl Al 8AT-B5M2-	50ΩMaxiFlex (No QPL List) .085 Tin Pl [Ⓢ] 08F-B5M2-	50Ω RG 405 [Ⓢ] M17/133-00016 .085 Silver Pl 8SS-B5M2-	50 Ω MaxiFlex (No QPL List) .085 Tin Pl [Ⓢ] 08J-B5M2-
12	-0120E	\$45.65	\$45.65	\$46.59	\$46.88	\$50.84	\$46.44
24	-0240E	\$48.67	\$48.67	\$50.55	\$51.13	\$59.05	\$50.25
36	-0360E	\$51.69	\$51.69	\$54.51	\$55.38	\$67.26	\$54.06
48	-0480E	\$54.71	\$54.71	\$58.47	\$59.63	\$75.47	\$57.87
60	-0600E	\$57.73	\$57.73	\$62.43	\$63.88	\$83.68	\$61.68
72	-0720E	\$60.75	\$60.75	CALL	\$68.13	CALL	\$65.49

ⓈSilver Plated Copper Center Conductor ⓈSilver Plated Copper Clad Steel Center Conductor

10% Discount @ 25 pcs. up 4% Discount @ 10 pcs. up

BNC Female Bulkhead Jack x SMA Right Angle Male Plug

Commercial

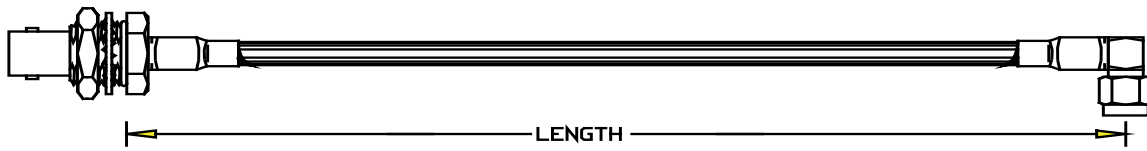

LENGTH IN INCHES	DASH NUMBER	50Ω RG 401① M17/129-RG401 .250 Cu Jacket 401-B5M2-	50Ω RG 401① (No QPL List) .250 Tin Plate Al 25A-B5M2-	50Ω RG 401② M17/129-00001 .250 Tin Plate Cu 2TS-B5M2-	50Ω MaxiFlex② (No QPL List) .250 Tin Plate Braid 25F-B5M2-	
.250" Diameter SEMIRIGID and Maxi Flex. Direct Solder Connectors						
12	-0120C	\$32.27	\$33.21	\$37.46	\$32.27	
24	-0240C	\$35.29	\$37.17	\$45.67	\$35.29	
36	-0360C	\$38.31	\$41.13	\$53.88	\$38.31	
48	-0480C	\$41.33	\$45.09	\$62.09	\$41.33	
60	-0600C	\$44.35	\$49.05	\$70.30	\$44.35	
72	-0720C	\$47.37	\$53.01	\$78.51	\$47.37	
.141" Diameter SEMIRIGID and Maxi Flex. Direct Solder Connectors						
LTH IN INS	DASH NUMBER	50Ω RG 402② M17/130-00004 .141 Cu Jacket 402-B5M2-	50Ω RG 402② M17/130-00005 .141 Tin Plate Cu 1TS-B5M2-	50Ω RG 402① M17/130-00009 .141 Tin Plate Al 1AT-B5M2-	50Ω MaxiFlex② (No QPL List) .141 Tin Pl 14F-B5M2-	50Ω RG 402② M17/130-00012 .141 Silver Pl 1SS-B5M2-
12	-0120EC	\$26.38	\$26.02	\$26.38	\$26.02	\$35.59
24	-0240EC	\$29.98	\$29.26	\$29.98	\$29.26	\$48.40
36	-0360EC	\$33.58	\$32.50	\$33.58	\$32.50	\$61.21
48	-0480EC	\$37.18	\$35.74	\$37.18	\$35.74	\$74.02
60	-0600EC	\$40.78	\$38.98	\$40.78	\$38.98	\$86.83
72	-0720EC	\$44.38	\$42.22	\$44.38	\$42.22	\$99.64
.085" Diameter SEMIRIGID and Maxi Flex. Direct Solder Connectors						
LTH IN INS	DASH NUMBER	50Ω RG 405② M17/133-00007 .085 Tin Plate Cu 405-B5M2-	50Ω RG 405② M17/133-00007 .085 Tin Plate Cu 8TS-B5M2-	50Ω RG 405② M17/133-00013 .085 Tin Plate Al 8AT-B5M2-	50Ω MaxiFlex② (No QPL List) .085 Tin Pl 08F-B5M2-	50Ω RG 405② M17/133-00016 .085 Silver Pl 8SS-B5M2-
12	-0120EC	\$26.38	\$26.02	\$26.38	\$26.02	\$35.59
24	-0240EC	\$29.98	\$29.26	\$29.98	\$29.26	\$48.40
36	-0360EC	\$33.58	\$32.50	\$33.58	\$32.50	\$61.21
48	-0480EC	\$37.18	\$35.74	\$37.18	\$35.74	\$74.02
60	-0600EC	\$40.78	\$38.98	\$40.78	\$38.98	\$86.83
72	-0720EC	\$44.38	\$42.22	CALL	\$42.22	CALL

① Silver Plated Copper Center Conductor ② Silver Plated Copper Clad Steel Center Conductor

10% Discount @ 25 pcs. up 4% Discount @ 10 pcs. up



BNC Female Jack x BNC Female Jack



LENGTH IN INCHES	DASH NUMBER	50 Ω RG 58C ③⑥⑦ 1 shield 058-BBBB-	50 Ω RG 223⑨⑩⑪ 2 shields 223-BBBB-	50 Ω RG142B⑫⑬ 2 shields 142-BBBB-	50 Ω RG 400⑭⑮⑯* 2 shields 400-BBBB-		
Solder Center, Crimp Outer							
12	-0120	\$23.06	\$25.19	\$26.02	\$26.72		
24	-0240	\$23.46	\$26.66	\$28.32	\$29.72		
36	-0360	\$23.86	\$28.13	\$30.62	\$32.72		
48	-0480	\$24.26	\$29.60	\$32.92	\$35.72		
60	-0600	\$24.66	\$31.07	\$35.22	\$38.72		
72	-0720	\$25.06	\$32.54	\$37.52	\$41.72		
Solder Center, Crimp Outer							
LENGTH IN INCHES	DASH NUMBER	50 Ω RG 174⑰⑱ 1 shield ⑲ 174-BBBB-	50 Ω RG 316⑲⑳ 1 shield⑳ 316-BBBB-	50 Ω ④ RD316㉑㉒ 2 shields 31D-BBBB-	50 Ω RG188*⑳㉓ 1 shield⑳ 188-BBBB-	50 Ω ④ RD188*㉔㉕ 2 shields 88D-BBBB-	75 Ω ② RG179A④ 1 shield⑳ 179-BBBB-
12	-0120	\$23.42	\$23.83	\$18.67	\$24.18	\$20.34	\$23.91
24	-0240	\$23.66	\$24.48	\$20.52	\$25.18	\$23.86	\$24.64
36	-0360	\$23.90	\$25.13	\$22.37	\$26.18	\$27.38	\$25.37
48	-0480	\$24.14	\$25.78	\$24.22	\$27.18	\$30.90	\$26.10
60	-0600	\$24.38	\$26.43	\$26.07	\$28.18	\$34.42	\$26.83
72	-0720	\$24.62	\$27.08	\$27.92	\$29.18	\$37.94	\$27.56
Solder Center, Crimp Outer							
LENGTH IN INCHES	DASH NUMBER	50 Ω RG 8* ⑳㉖㉗ 1 shield 008-BBBB-	50 Ω RG 213⑳㉘㉙ 1 shield 213-BBBB-	50 Ω RG 214⑳㉚ 2 shields㉚ 214-BBBB-	75 Ω RG 59B⑳㉛㉜ 1 shield 059-BBBB-	93 Ω RG 62⑳㉝㉞ 1 shield 062-BBBB-	
12	-0120	\$36.96	\$37.14	\$39.46	\$17.26	\$17.52	
24	-0240	\$38.36	\$38.72	\$42.96	\$17.70	\$18.22	
36	-0360	\$39.76	\$40.30	\$46.46	\$18.14	\$18.92	
48	-0480	\$41.16	\$41.88	\$49.96	\$18.58	\$19.62	
60	-0600	\$42.56	\$43.46	\$53.46	\$19.02	\$20.32	
72	-0720	\$43.96	\$45.04	\$56.96	\$19.46	\$21.02	
Color Designators (add letter to the end of the part number and add \$1.00 to price)							
Black - B		Blue - L		Brown - N		Gray - A	
Orange - O		Red - R		Violet - V		Green - G	
						White - W	

See Page B5 for Cable Characteristics

* Contact Factory for delivery, Consider new RD316 for (RD188) 10% Discount @ 25 pcs. up 4% Discount @ 10 pcs. up

BNC Female Jack x BNC Male Plug



LENGTH IN INCHES	DASH NUMBER	50 Ω RG 58C ^{⑤⑥⑦} 1 shield 058-BABB-	50 Ω RG 223 ^{⑤①⑦} 2 shields 223-BABB-	50 Ω RG142B ^{④⑦} 2 shields 142-BABB-	50 Ω RG 400 ^{✕④①} 2 shields ^⑦ 400-BABB-		
Solder Center, Crimp Outer							
12	-0120	\$20.64	\$22.00	\$22.83	\$23.53		
24	-0240	\$21.04	\$23.47	\$25.13	\$26.53		
36	-0360	\$21.44	\$24.94	\$27.43	\$29.53		
48	-0480	\$21.84	\$26.41	\$29.73	\$32.53		
60	-0600	\$22.24	\$27.88	\$32.03	\$35.53		
72	-0720	\$22.64	\$29.35	\$34.33	\$38.53		
Solder Center, Crimp Outer							
LENGTH IN INCHES	DASH NUMBER	50 Ω RG 174 ^{⑤⑥} 1 shield ^⑦ 174-BABB-	50 Ω RG 316 ^{④②} 1 shield ^⑩ 316-BABB-	50 Ω ^④ RD316 ^{②⑦} 2 shields 31D-BABB-	50 Ω RG188 ^{*④②} 1 shield ^⑩ 188-BABB-	50 Ω ^④ RD188 ^{*②⑦} 2 shields 88D-BABB-	75 Ω RG179A ^{④②} 1 shield ^⑩ 179-BABB-
12	-0120	\$22.20	\$22.61	\$18.77	\$22.96	\$20.44	\$20.64
24	-0240	\$22.44	\$23.26	\$20.62	\$23.96	\$23.96	\$21.37
36	-0360	\$22.68	\$23.91	\$22.47	\$24.96	\$27.48	\$22.10
48	-0480	\$22.92	\$24.56	\$24.32	\$25.96	\$31.00	\$22.83
60	-0600	\$23.16	\$25.21	\$26.17	\$26.96	\$34.52	\$23.56
72	-0720	\$23.40	\$25.86	\$28.02	\$27.96	\$38.04	\$24.29
Solder Center, Crimp Outer							
LENGTH IN INCHES	DASH NUMBER	50 Ω RG 8 ^{*⑤③⑧} 1 shield 008-BABB-	50 Ω RG 213 ^{⑤③⑧} 1 shield 213-BABB-	50 Ω RG 214 ^{⑤①⑦} 2 shields 214-BABB-	75 Ω RG 59B ^{⑤⑧} 1 shield 059-BABB-	93 Ω RG 62 ^{⑤⑧} 1 shield 062-BABB-	
12	-0120	\$31.36	\$31.54	\$33.86	\$22.66	\$22.92	
24	-0240	\$32.76	\$33.12	\$37.36	\$23.10	\$23.62	
36	-0360	\$34.16	\$34.70	\$40.86	\$23.54	\$24.32	
48	-0480	\$35.56	\$36.28	\$44.36	\$23.98	\$25.02	
60	-0600	\$36.96	\$37.86	\$47.86	\$24.42	\$25.72	
72	-0720	\$38.36	\$39.44	\$51.36	\$24.86	\$26.42	
Color Designators (add letter to the end of the part number and add \$1.00 to price)							
Black - B		Blue - L		Brown - N		Gray - A	
Orange - O		Red - R		Violet - V		Green - G	
						White - W	

See Page B5 for Cable Characteristics

* Contact Factory for delivery, Consider new RD316 for (RD188) 10% Discount @ 25 pcs. up 4% Discount @ 10 pcs. up



RF Depot.com Inc.

Phone 856-488-2000 Fax 856-488-2020

BNC Male Plug x BNC Male Plug

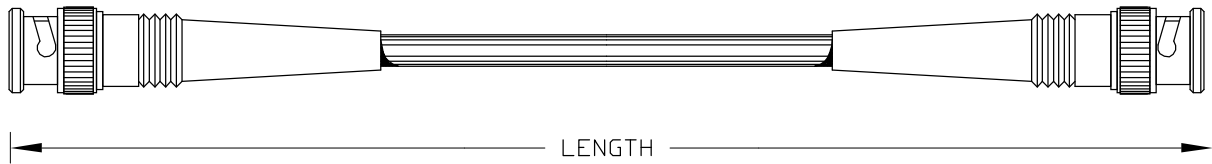

LENGTH IN INCHES	DASH NUMBER	50 Ω RG 58C ^{③⑥⑦} 1 shield 058-BABA-	50 Ω RG 223 ^{②①⑦} 2 shields 223-BABA-	50 Ω RG142B ^{④⑦} 2 shields 142-BABA-	50 Ω RG 400 ^{✕④①} 2 shields ^⑦ 400-BABA-		
Solder Center, Crimp Outer							
12	-0120	\$18.22	\$18.81	\$19.64	\$20.34		
24	-0240	\$18.62	\$20.28	\$21.94	\$23.34		
36	-0360	\$19.02	\$21.75	\$24.24	\$26.34		
48	-0480	\$19.42	\$23.22	\$26.54	\$29.34		
60	-0600	\$19.82	\$24.69	\$28.84	\$32.34		
72	-0720	\$20.22	\$26.16	\$31.14	\$35.34		
Solder Center, Crimp Outer							
LENGTH IN INCHES	DASH NUMBER	50 Ω RG 174 ^{⑤⑤} 1 shield ^⑦ 174-BABA-	50 Ω RG 316 ^{④②} 1 shield ^⑥ 316-BABA-	50 Ω ^④ RD316 ^{②⑦} 2 shields 31D-BABA-	50 Ω RG188 ^{*④②} 1 shield ^⑥ 188-BABA-	50 Ω ^④ RD188 ^{*②⑦} 2 shields 88D-BABA-	75 Ω RG179A ^{④②} 1 shield ^⑥ 179-BABA-
12	-0120	\$20.98	\$21.39	\$18.67	\$21.74	\$20.34	\$17.37
24	-0240	\$21.22	\$22.04	\$20.52	\$22.74	\$23.86	\$18.10
36	-0360	\$21.46	\$22.69	\$22.37	\$23.74	\$27.38	\$18.83
48	-0480	\$21.70	\$23.34	\$24.22	\$24.74	\$30.90	\$19.56
60	-0600	\$21.94	\$23.99	\$26.07	\$25.74	\$34.42	\$20.29
72	-0720	\$22.18	\$24.64	\$27.92	\$26.74	\$37.94	\$21.02
Solder Center, Crimp Outer							
LENGTH IN INCHES	DASH NUMBER	50 Ω RG 8 ^{*③③⑧} 1 shield 008-BABA-	50 Ω RG 213 ^{③③⑧} 1 shield 213-BABA-	50 Ω RG 214 ^{③①} 2 shields ^⑦ 214-BABA-	75 Ω RG 59B ^{⑤⑤⑧} 1 shield 059-BABA-	93 Ω RG 62 ^{③⑤⑧} 1 shield 062-BABA-	
12	-0120	\$25.76	\$25.94	\$28.26	\$28.06	\$28.32	
24	-0240	\$27.16	\$27.52	\$31.76	\$28.50	\$29.02	
36	-0360	\$28.56	\$29.10	\$35.26	\$28.94	\$29.72	
48	-0480	\$29.96	\$30.68	\$38.76	\$29.38	\$30.42	
60	-0600	\$31.36	\$32.26	\$42.26	\$29.82	\$31.12	
72	-0720	\$32.76	\$33.84	\$45.76	\$30.26	\$31.82	
Color Designators (add letter to the end of the part number and add \$1.00 to price)							
Black - B		Blue - L		Brown - N		Gray - A	
Orange - O		Red - R		Violet - V		Green - G	
						White - W	

See Page B5 for Cable Characteristics

* Contact Factory for delivery, Consider new RD316 for (RD188) 10% Discount @ 25 pcs. up 4% Discount @ 10 pcs. up

BNC Male Plug x BNC Male Plug Commercial

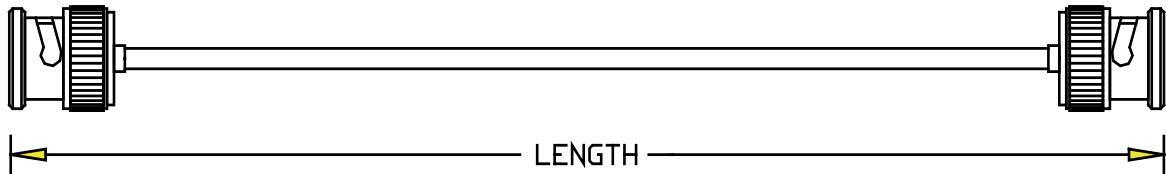

LENGTH IN INCHES	DASH NUMBER	50Ω RG 401 [Ⓢ] M17/129-RG401 .250 Cu Jacket 401-B0B0-	50Ω RG 401 [Ⓢ] (No QPL List) .250 Tin Plate Al 25A-B0B0-	50Ω RG 401 [Ⓢ] M17/129-00001 .250 Tin Plate Cu 2TS-B0B0-	50Ω MaxiFlex [Ⓢ] (No QPL List) .250 Tin Plate Braid 25F-B0B0-	
.250" Diameter SEMIRIGID and Maxi Flex. Direct Solder Connectors						
24	-0240	\$23.24	\$25.12	\$33.62	\$23.24	
36	-0360	\$26.26	\$29.08	\$41.83	\$26.26	
48	-0480	\$29.28	\$33.04	\$50.04	\$29.28	
60	-0600	\$32.30	\$37.00	\$58.25	\$32.30	
72	-0720	\$35.32	\$40.96	\$66.46	\$35.32	
.141" Diameter SEMIRIGID and Maxi Flex. Direct Solder Connectors						
LENGTH IN INCHES	DASH NUMBER	50Ω RG 402 [Ⓢ] M17/130-00004 .141 Cu Jacket 402-B0B0-	50Ω RG 402 [Ⓢ] M17/130-00005 .141 Tin Plate Cu 1TS-B0B0-	50Ω RG 402 [Ⓢ] M17/130-00009 .141 Tin Plate Al 1AT-B0B0-	50Ω MaxiFlex [Ⓢ] (No QPL List) .141 Tin Pl 14F-B0B0-	50Ω RG 402 [Ⓢ] M17/130-00012 .141 Silver Pl 1SS-B0B0-
12	-0120	\$21.38	\$21.02	\$21.38	\$21.02	\$30.59
24	-0240	\$24.98	\$24.26	\$24.98	\$24.26	\$43.40
36	-0360	\$28.58	\$27.50	\$28.58	\$27.50	\$56.21
48	-0480	\$32.18	\$30.74	\$32.18	\$30.74	\$69.02
60	-0600	\$35.78	\$33.98	\$35.78	\$33.98	\$81.83
72	-0720	\$39.38	\$37.22	\$39.38	\$37.22	\$94.64
.085" Diameter SEMIRIGID and Maxi Flex. Direct Solder Connectors						
LENGTH IN INCHES	DASH NUM	50Ω RG 405 [Ⓢ] M17/133-00007 .085 Tin Plate Cu 405-B0B0-	50Ω RG 405 [Ⓢ] M17/133-00007 .085 Tin Plate Cu 8TS-B0B0-	50Ω RG 405 [Ⓢ] M17/133-00013 .085 Tin Plate Al 8AT-B0B0-	50Ω MaxiFlex [Ⓢ] (No QPL List) .085 Tin Pl 08F-B0B0-	50Ω RG 405 [Ⓢ] M17/133-00016 .085 Silver Pl 8SS-B0B0-
12	-0120	\$20.80	\$20.80	\$21.74	\$22.03	\$25.99
24	-0240	\$23.82	\$23.82	\$25.70	\$26.28	\$34.20
36	-0360	\$26.84	\$26.84	\$29.66	\$30.53	\$42.41
48	-0480	\$29.86	\$29.86	\$33.62	\$34.78	\$50.62
60	-0600	\$32.88	\$32.88	\$37.58	\$39.03	\$58.83
72	-0720	\$35.90	\$35.90	CALL	\$43.28	CALL
.047" Diameter SEMIRIGID and Maxi Flex. Direct Solder Connectors						
LENGTH IN INCHES	DASH NUMBER	50Ω [Ⓢ] M17/151-00001 .047 Cu Jacket 4CU-B0B0-	50Ω (No QPL List) .047 Tin Plate Al 4AT-B0B0-	50Ω [Ⓢ] M17/151-00002 .047 Tin Plate Cu 4TS-B0B0-	50Ω MaxiFlex [Ⓢ] (No QPL List) .047 Tin Plate Braid 04F-B0B0-	
12	-0120	\$62.10	\$48.35	\$46.90	\$47.60	
24	-0240	\$25.38	\$53.60	\$50.70	\$52.10	
60	-0600	\$62.10	\$69.35	\$62.10	\$65.60	

Ⓢ Silver Plated Copper Center Conductor Ⓢ Silver Plated Copper Clad Steel Center Conductor

10% Discount @ 25 pcs. up 4% Discount @ 10 pcs. up

BNC Male Plug x BNC Right Angle Male Plug



LENGTH IN INCHES	DASH NUMBER	50 Ω RG 58C ^{③⑥⑦} 1 shield 058-BABC-	50 Ω RG 223 ^{③①⑦} 2 shields 223-BABC-	50 Ω RG142B ^{④⑦} 2 shields 142-BABC-	50 Ω RG 400 ^{④①⑦} 2 shields* 400-BABC-		
Solder Center, Crimp Outer							
12	-0120	\$22.89	\$24.09	\$24.92	\$25.62		
24	-0240	\$23.29	\$25.56	\$27.22	\$28.62		
36	-0360	\$23.69	\$27.03	\$29.52	\$31.62		
48	-0480	\$24.09	\$28.50	\$31.82	\$34.62		
60	-0600	\$24.49	\$29.97	\$34.12	\$37.62		
72	-0720	\$24.89	\$31.44	\$36.42	\$40.62		
Solder Center, Crimp Outer							
LENGTH IN INCHES	DASH NUMBER	50 Ω RG 174 ^{③⑤} 1 shield ^⑦ 174-BABC-	50 Ω RG 316 ^{④②} 1 shield ^⑥ 316-BABC-	50 Ω ^④ RD316 ^{②⑦} 2 shields 31D-BABC-	50 Ω ^④ RG188* ^② 1 shield ^⑥ 188-BABC-	50 Ω ^④ RD188* ^{②⑦} 2 shields 88D-BABC-	75 Ω RG179A ^{④②} 1 shield ^⑥ 179-BABC-
12	-0120	\$23.80	\$24.21	\$22.25	\$24.56	\$25.12	\$22.24
24	-0240	\$24.04	\$24.86	\$22.90	\$25.56	\$28.64	\$22.97
36	-0360	\$24.28	\$25.51	\$23.55	\$26.56	\$32.16	\$23.70
48	-0480	\$24.52	\$26.16	\$24.20	\$27.56	\$35.68	\$24.43
60	-0600	\$24.76	\$26.81	\$24.85	\$28.56	\$39.20	\$25.16
Solder Center, Crimp Outer							
LENGTH IN INCHES	DASH NUMBER	50 Ω RG 8* ^{③③⑧} 1 shield 008-BABC-	50 Ω ^⑥ RG 213 ^{③⑧} 1 shield 213-BABC-	50 Ω RG 214 ^{③①} 2 shields ^⑦ 214-BABC-	75 Ω RG59B ^{③⑤⑧} 1 shield 059-BABC-	93 Ω ^③ RG 62 ^{③⑧} 1 shield 062-BABC-	50 Ω ^④ RG 393 ^{①⑦} 2 shields 393-BABC-
12	-0120	\$26.01	\$26.19	\$28.51	\$36.48	\$36.74	\$33.24
24	-0240	\$27.41	\$27.77	\$32.01	\$36.92	\$37.44	\$41.87
36	-0360	\$28.81	\$29.35	\$35.51	\$37.36	\$38.14	\$50.50
48	-0480	\$30.21	\$30.93	\$39.01	\$37.80	\$38.84	\$59.13
60	-0600	\$31.61	\$32.51	\$42.51	\$38.24	\$39.54	\$67.76
Color Designators (add letter to the end of the part number and add \$1.00 to price)							
Black - B		Blue - L		Brown - N		Gray - A	
Orange - O		Red - R		Violet - V		Green - G	
						White - W	

See Page B5 for Cable Characteristics

* Contact Factory for delivery, Consider new RD316 for (RD188)

10% Discount @ 25 pcs. up

4% Discount @ 10 pcs. up

BNC Male Plug x GR 874

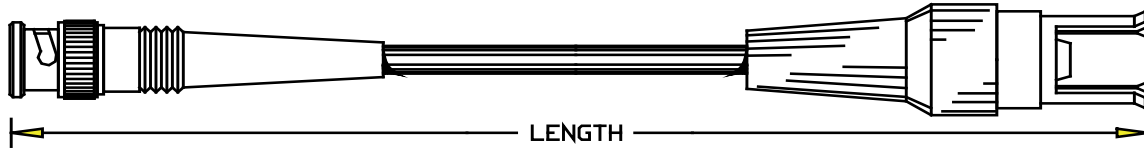

LENGTH IN INCHES	DASH NUMBER	50 Ω RG 58C [Ⓢ] [Ⓢ] [Ⓢ] 1 shield 058-BAGRA-	50 Ω RG 223 [Ⓢ] [Ⓢ] [Ⓢ] 2 shields 223-BAGRA-	50 Ω RG142B [Ⓢ] [Ⓢ] 2 shields 142-BAGRA-	50 Ω RG 400 [✕] [Ⓢ] [Ⓢ] 2 shields [Ⓢ] 400-BAGRA-	50 Ω RG 214 [Ⓢ] [Ⓢ] 2 shields [Ⓢ] 214-BAGRA-
Solder Center, Clamp Outer						
12	-0120	\$113.19	\$113.19	\$113.19	\$113.19	\$114.09
24	-0240	\$113.39	\$114.49	\$114.25	\$115.44	\$118.99
36	-0360	\$113.59	\$115.79	\$115.31	\$117.69	\$123.89
48	-0480	\$113.79	\$117.09	\$116.37	\$119.94	\$128.79
60	-0600	\$114.19	\$119.69	\$118.49	\$124.44	\$138.59
72	0720	\$114.39	\$120.99	\$119.55	\$126.69	\$143.49

BNC Male Plug x HN Male Plug

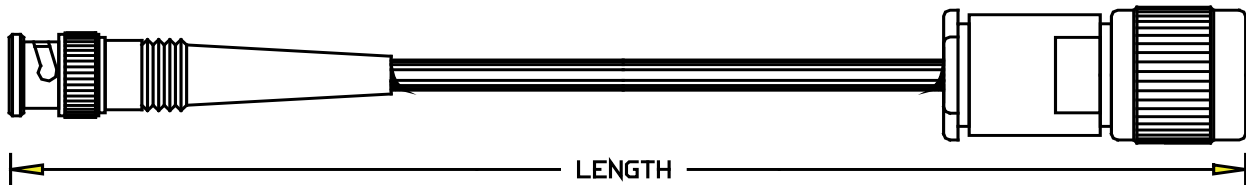

LENGTH IN INCHES	DASH NUM	50 Ω [Ⓢ] [Ⓢ] RG 58C [Ⓢ] 1 shield 058-BAHNO-	50 Ω RG 223 [Ⓢ] [Ⓢ] 2 shields [Ⓢ] 223-BAHNO-	50 Ω RG142B [Ⓢ] [Ⓢ] 2 shields 142-BAHNO-	50 Ω [Ⓢ] RG 400 [✕] [Ⓢ] 2 shields [Ⓢ] 400-BAHNO-	50 Ω RG 214 [Ⓢ] [Ⓢ] 2 shields [Ⓢ] 214-BAHNO-	50 Ω RG 393 [Ⓢ] [Ⓢ] [Ⓢ] 2 shields 393-BAHNO-
Solder Center, Crimp and Clamp Outer							
12	-0120	\$48.76	\$49.59	\$50.42	\$51.12	\$59.93	\$65.06
24	-0240	\$49.16	\$51.06	\$52.72	\$54.12	\$63.43	\$73.69
36	-0360	\$49.56	\$52.53	\$55.02	\$57.12	\$66.93	\$82.32
48	-0480	\$49.96	\$54.00	\$57.32	\$60.12	\$70.43	\$99.95
60	-0600	\$50.36	\$55.47	\$59.62	\$63.12	\$73.93	\$99.58
72	-0720	\$50.76	\$56.94	\$61.92	\$66.12	\$77.43	\$108.23
Color Designators (add letter to the end of the part number and add \$1.00 to price)							
Black - B		Blue - L		Brown - N		Gray - A	
Orange - O		Red - R		Violet - V		Green - G	
						White - W	

See Page B5 for Cable Characteristics

* Contact Factory for delivery, Consider new RD316 for (RD188)

10% Discount @ 25 pcs. up

4% Discount @ 10 pcs. up

BNC Male Plug x N Female Jack



LENGTH IN INCHES	DASH NUMBER	50 Ω RG 58C ^{①②⑦} 1 shield 058-BANB-	50 Ω RG 223 ^{①②⑦} 2 shields 223-BANB-	50 Ω RG142B ^{④⑦} 2 shields 142-BANB-	50 Ω RG 400 ^{*④⑦①} 2 shields ^⑦ 400-BANB-	50 Ω SF 142B ^{②④} 3 shields ^③ S42-BANB-	
Solder Center, Crimp Outer							
12	-0120	\$27.58	\$28.41	\$29.24	\$29.94	\$33.26	
24	-0240	\$27.98	\$29.88	\$31.54	\$32.94	\$39.58	
36	-0360	\$28.38	\$31.35	\$33.84	\$35.94	\$45.90	
48	-0480	\$28.78	\$32.82	\$36.14	\$38.94	\$52.22	
60	-0600	\$29.18	\$34.29	\$38.44	\$41.94	\$58.54	
72	-0720	\$29.58	\$35.76	\$40.74	\$44.94	\$64.86	
Solder Center, Crimp Outer							
LENGTH IN INCHES	DASH NUMBER	50 Ω RG 174 ^{③⑤} 1 shield ^⑦ 174-BANB-	50 Ω RG 316 ^{④②} 1 shield ^⑩ 316-BANB-	50 Ω ^④ RD316 ^{②⑦} 2 shields 31D-BANB-	50 Ω RG188* ^{④②} 1 shield ^⑩ 188-BANB-	50 Ω ^④ RD188* ^{②⑦} 2 shields 88D-BANB-	75 Ω RG179A ^{④②} 1 shield ^⑩ 179-BANB-
12	-0120	\$23.64	\$24.05	\$23.29	\$24.40	\$24.96	\$22.08
24	-0240	\$23.88	\$24.70	\$25.14	\$25.40	\$28.48	\$22.81
36	-0360	\$24.12	\$25.35	\$26.99	\$26.40	\$32.00	\$23.54
48	-0480	\$24.36	\$26.00	\$28.84	\$27.40	\$35.52	\$24.27
60	-0600	\$24.60	\$26.65	\$30.69	\$28.40	\$39.04	\$25.00
72	-0720	\$24.84	\$27.30	\$32.54	\$29.40	\$42.56	\$25.73
Solder Center, Crimp Outer							
LENGTH IN INCHES	DASH NUMBER	50 Ω RG 8* ^{③③⑧} 1 shield 008-BANB-	50 Ω ^③ RG 213 ^{③⑧} 1 shield 213-BANB-	50 Ω RG 214 ^{③①} 2 shields ^⑦ 214-BANB-	75 Ω RG59B ^{③⑤⑧} 1 shield 059-BANB-	93 Ω ^③ RG 62 ^{⑤⑧} 1 shield 062-BANB-	50 Ω ^④ RG 393 ^{①⑦} 2 shields 393-BANB-
12	-0120	\$24.45	\$24.63	\$37.23	\$25.13	\$25.39	\$42.36
24	-0240	\$25.85	\$26.21	\$40.73	\$25.57	\$26.09	\$50.99
36	-0360	\$27.25	\$27.79	\$44.23	\$26.01	\$26.79	\$59.62
48	-0480	\$28.65	\$29.37	\$47.73	\$26.45	\$27.49	\$68.25
60	-0600	\$30.05	\$30.95	\$51.23	\$26.89	\$28.19	\$76.88
72	-0720	\$31.45	\$32.53	\$54.73	\$27.33	\$28.89	\$75.51
Color Designators (add letter to the end of the part number and add \$1.00 to price)							
Black - B		Blue - L		Brown - N		Gray - A	
Orange - O		Red - R		Violet - V		Green - G	
						White - W	

See Page B5 for Cable Characteristics

* Contact Factory for delivery, Consider new RD316 for (RD188) 10% Discount @ 25 pcs. up 4% Discount @ 10 pcs. up

⁴ Brass Type N Jack. Contact Factory for Stainless Steel



BNC Male Plug x N Male Plug

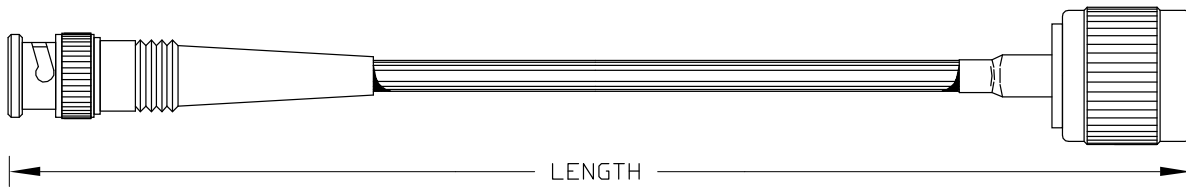

LENGTH IN INCHES	DASH NUMBER	50 Ω RG 58C ^{③⑥⑦} 1 shield 058-BANA-	50 Ω RG 223 ^{③①⑦} 2 shields 223-BANA-	50 Ω RG142B ^{④⑦} 2 shields 142-BANA-	50 Ω RG 400 ^{✕④①} 2 shields ^⑦ 400-BANA-	50 Ω SF 142B ^{②④} 3 shields ^⑨ S42-BANA-	
Solder Center, Crimp Outer							
12	-0120	\$21.96	\$22.79	\$23.62	\$24.32	\$27.64	
24	-0240	\$22.36	\$24.26	\$25.92	\$27.32	\$33.96	
36	-0360	\$22.76	\$25.73	\$28.22	\$30.32	\$40.28	
48	-0480	\$23.16	\$27.20	\$30.52	\$33.32	\$46.60	
60	-0600	\$23.56	\$28.67	\$32.82	\$36.32	\$52.92	
72	-0720	\$23.96	\$30.14	\$35.12	\$39.32	\$59.24	
Solder Center, Crimp Outer							
LENGTH IN INCHES	DASH NUMBER	50 Ω RG 174 ^{⑤⑥} 1 shield ^⑦ 174-BANA-	50 Ω RG 316 ^{④②} 1 shield ^⑩ 316-BANA-	50 Ω ^④ RD316 ^{②⑦} 2 shields 31D-BANA-	50 Ω ^④ RG188* ^② 1 shield ^⑩ 188-BANA-	50 Ω ^④ RD188* ^{②⑦} 2 shields 88D-BANA-	75 Ω RG179A ^{④②} 1 shield ^⑩ 179-BANA-
12	-0120	\$28.52	\$28.93	\$28.17	\$29.28	\$29.84	\$26.96
24	-0240	\$28.76	\$29.58	\$30.02	\$30.28	\$33.36	\$27.69
36	-0360	\$29.00	\$30.23	\$31.87	\$31.28	\$36.88	\$28.42
48	-0480	\$29.24	\$30.88	\$33.72	\$32.28	\$40.40	\$29.15
60	-0600	\$29.48	\$31.53	\$35.57	\$33.28	\$43.92	\$29.88
72	-0720	\$29.72	\$32.18	\$37.42	\$34.28	\$47.44	\$30.61
Solder Center, Crimp Outer							
LENGTH IN INCHES	DASH NUMBER	50 Ω RG 8* ^{③③③} 1 shield 008-BANA-	50 Ω ^③ RG 213 ^{③③} 1 shield 213-BANA-	50 Ω RG 214 ^{⑤①} 2 shields ^⑦ 214-BANA-	75 Ω RG59B ^{③⑤⑧} 1 shield 059-BANA-	93 Ω ^③ RG 62 ^{⑤⑧} 1 shield 062-BANA-	50 Ω ^④ RG 393 ^{①⑦} 2 shields 393-BANA-
12	-0120	\$25.10	\$25.28	\$28.73	\$25.56	\$25.82	\$33.66
24	-0240	\$26.50	\$26.86	\$32.23	\$26.00	\$26.52	\$42.29
36	-0360	\$27.90	\$28.44	\$35.73	\$26.44	\$27.22	\$50.92
48	-0480	\$29.30	\$30.02	\$39.23	\$26.88	\$27.92	\$59.55
60	-0600	\$30.70	\$31.60	\$42.73	\$27.32	\$28.62	\$68.18
72	-0720	\$32.10	\$33.18	\$46.23	\$27.76	\$29.32	\$76.81
Color Designators (add letter to the end of the part number and add \$1.00 to price)							
Black - B		Blue - L		Brown - N		Gray - A	
Orange - O		Red - R		Violet - V		Green - G	
						White - W	

See Page B5 for Cable Characteristics

* Contact Factory for delivery, Consider new RD316 for (RD188) 10% Discount @ 25 pcs. up 4% Discount @ 10 pcs. up

⁴ Brass Type N Jack. Contact Factory for Stainless Steel



RF Depot.com Inc.

Phone 856-488-2000 Fax 856-488-2020

BNC Male Plug x N Male Plug

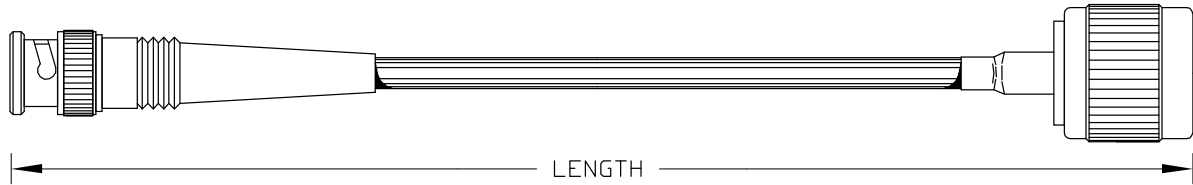

LENGTH IN INCHES	DASH NUM	50 Ω SIG 100 ^{③③} 2 shields 1LC-BANA-	50 Ω LMR 100 ^{③③} 2 shields 1LM-BANA-	50 Ω SIG 195 ^③ 2 shields ^③ 19C-BANA-	50 Ω LMR 195 ^③ 2 shields ^③ 19M-BANA-	50 Ω SIG 200 ^{③③} 2 shields 2LC-BANA-	50 Ω LMR 200 ^{③③} 2 shields 2LM-BANA-		
Solder Center, Crimp Outer									
24	-0240	\$22.32	\$22.56	\$20.15	\$20.43	\$20.56	\$20.66		
60	-0600	\$23.94	\$24.54	\$21.86	\$22.56	\$22.60	\$22.85		
120	-1200	\$26.64	\$27.84	\$24.71	\$26.11	\$26.00	\$26.50		
180	-1800	\$29.34	\$31.14	\$27.56	\$29.66	\$29.40	\$30.15		
240	-2400	\$32.04	\$34.44	\$30.41	\$33.21	\$32.80	\$33.80		
300	-3000	\$34.74	\$37.74	\$33.26	\$36.76	\$36.20	\$37.45		
Solder Center, Crimp Outer									
LTH IN INS	DASH NUM	50 Ω SIG 240 ^{③③} 2 shields 24C-BANA-	50 Ω LMR 240 ^{③③} 2 shields 24L-BANA-	50 Ω SIG 300 ^{③③} 2 shields 3LC-BANA-	50 Ω LMR 300 ^{③③} 2 shields 3LM-BANA-	50 Ω SIG 400 ^{④③} 2 shields 4LC-BANA-	50 Ω LMR 400 ^{④③} 2 shields 4LM-BANA-		
24	-0240	\$20.26	\$21.10	\$34.43	\$35.23	\$29.36	\$30.40		
60	-0600	\$22.06	\$24.16	\$36.59	\$38.59	\$31.94	\$34.54		
120	-1200	\$25.06	\$29.26	\$40.19	\$44.19	\$36.24	\$41.44		
180	-1800	\$28.06	\$34.36	\$43.79	\$49.79	\$40.54	\$48.34		
240	-2400	\$31.06	\$39.46	\$47.39	\$55.39	\$44.84	\$55.24		
300	-3000	\$34.06	\$44.56	\$50.99	\$60.99	\$49.14	\$62.14		
Solder Center, Crimp Outer									
LTH IN INS	DASH NUM	50 Ω ^{④③③} SIG 400DB 2 shields 4DC-BANA-	50 Ω ^{④③③} LMR 400DB 2 shields 4LD-BANA-	50 Ω ^{④③③} SIG 400FR 2 shields 4RC-BANA-	50 Ω ^{④③③} LMR 400FR 2 shields 4LR-BANA-	50 Ω ^{④③} SIG 400UF 2 shields ^③ 4UC-BANA-	50 Ω ^{④③③} LMR 400UF 2 shields 4UF-BANA-	50 Ω LMR 600 ^{④③} 2 shields 6LM-BANA-	
24	-0240	\$29.60	\$30.84	\$29.60	\$31.44	\$29.60	\$31.44	\$54.16	
60	-0600	\$32.54	\$35.64	\$32.54	\$37.14	\$32.54	\$37.14	\$60.16	
120	-1200	\$37.44	\$43.64	\$37.44	\$46.64	\$37.44	\$46.64	\$70.16	
180	-1800	\$42.34	\$51.64	\$42.34	\$56.14	\$42.34	\$56.14	\$80.16	
240	-2400	\$47.24	\$59.64	\$47.24	\$65.64	\$47.24	\$65.64	\$90.16	
300	-3000	\$52.14	\$67.64	\$52.14	\$75.14	\$52.14	\$75.14	\$100.16	
Color Designators (add letter to the end of the part number and add \$1.00 to price)									
Black - B		Blue - L		Brown - N		Gray - A		Green - G	
Orange - O		Red - R		Violet - V		Yellow - Y		White - W	

See Page B5 for Cable Characteristics

* Contact Factory for delivery, Consider new RD316 for (RD188)

10% Discount @ 25 pcs. up

4% Discount @ 10 pcs. up

BNC Male Plug x SMA Male Plug

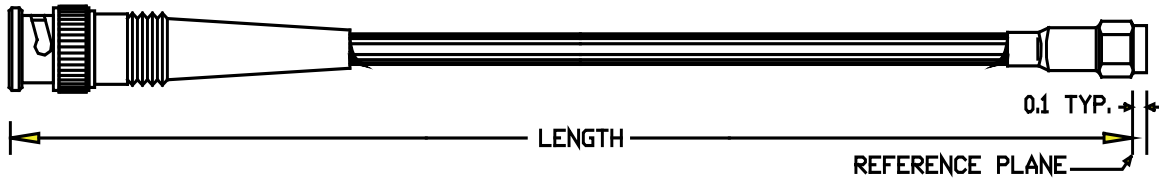

LENGTH IN INCHES	DASH NUMBER	50 Ω ③⑥⑦ RG 58C 1 shield 058-BAMA-	50 Ω ③⑦ RG 223① 2 shields 223-BAMA-	50 Ω ④⑦ RG142B 2 shields 142-BAMA-	50 Ω ④① RG 400* 2 shields⑦ 400-BAMA-	75 Ω ⑤‡ RG 59B⑤ 1 shield⑥ 059-BAMA-	93 Ω ⑤‡ RG 62⑤ 1 shield⑥ 062-BAMA-	50 Ω ② RG 178B/U 1 shield⑥ 178-BAMA-
------------------	-------------	---	--	---	---	--	---	---

Solder Center, Crimp Outer

12	-0120	\$22.84	\$24.96	\$25.79	\$26.49	\$22.53	\$22.79	\$33.38
24	-0240	\$23.24	\$26.43	\$28.09	\$29.49	422.97	\$23.49	\$34.12
36	-0360	\$23.64	\$27.90	\$30.39	\$32.49	\$23.41	\$24.19	\$34.86
48	-0480	\$24.04	\$29.37	\$32.69	\$35.49	\$23.85	\$24.89	\$35.60
60	-0600	\$24.44	\$30.84	\$34.99	\$38.49	\$24.29	\$25.59	\$36.34
72	-0720	\$24.84	\$32.31	\$37.29	\$41.49	\$24.73	\$26.29	\$37.08

Solder Center, Crimp Outer

LENGTH IN INCHES	DASH NUMBER	50 Ω RG 174③⑤ 1 shield⑦ 174-BAMA-	50 Ω RG 316④② 1 shield⑥ 316-BAMA-	50 Ω④ RD316②⑦ 2 shields 31D-BAMA-	50 Ω RG188*④② 1 shield⑥ 188-BAMA-	75 Ω RG179A④② 1 shield⑥ 179-BAMA-	50 Ω RG 196② 1 shield⑥ 196-BAMA-
12	-0120	\$22.19	\$22.60	\$21.84	\$22.95	\$20.63	\$33.38
24	-0240	\$22.43	\$23.25	\$23.69	\$23.95	\$21.36	\$34.12
36	-0360	\$22.67	\$23.90	\$25.54	\$24.95	\$22.09	\$34.86
48	-0480	\$22.91	\$24.55	\$27.39	\$25.95	\$22.82	\$35.60
60	-0600	\$23.15	\$25.20	\$29.24	\$26.95	\$23.55	\$36.34
72	-0720	\$23.39	\$25.85	\$31.09	\$27.95	\$24.28	\$37.08

Solder Center, Crimp Outer

LENGTH IN INCHES	DASH NUMBER	50 Ω RG 8*③③③ 1 shield 008-BAMA-	50 Ω⑤ RG 213③③ 1 shield 213-BAMA-	50 Ω RG 214③① 2 shields⑦ 214-BAMA-	50 Ω④ RG 393①⑦ 2 shields 393-BAMA-	50 Ω⑥ SIG 400④⑤ 2 shields 4LC-BAMA-	50 Ω⑥ LMR 400④⑤ 2 shields 4LM-BAMA-
12	-0120C	\$31.60	\$31.78	\$34.06	\$33.36	\$25.82	\$26.34
24	-0240C	\$33.00	\$33.36	\$37.56	\$36.36	\$26.68	\$27.72
36	-0360C	\$34.40	\$34.94	\$41.06	\$39.36	\$27.54	\$29.10
48	-0480C	\$35.80	\$36.52	\$44.56	\$42.36	\$28.40	\$30.48
60	-0600C	\$37.20	\$38.10	\$48.06	\$45.36	\$29.26	\$31.86
72	-0720C	\$38.60	\$39.68	\$51.56	\$48.36	\$30.12	\$33.24

Color Designators (add letter to the end of the part number and add \$1.00 to price)

Black - B	Blue - L	Brown - N	Gray - A	Green - G
Orange - O	Red - R	Violet - V	Yellow - Y	White - W

See Page B5 for Cable Characteristics

* Contact Factory for delivery, Consider new RD316 for (RD188)

10% Discount @ 25 pcs. up

4% Discount @ 10 pcs. up

‡ Brass Body Stainless Steel Nut



RF Depot.com Inc.

Phone 856-488-2000 Fax 856-488-2020

BNC Male Plug x SMA Reverse Polarity Bulkhead Jack



LENGTH IN INCHES	DASH NUM	50 Ω RG 58C ③⑥ 1 shield⑦ 058-BAMW-	50 Ω RG 174 ③⑤ 1 shield⑦ 174-BAMW-	50 Ω RG188* ④② 1 shield⑩ 188-BAMW-	50 Ω RG 223 ③① 2 shields⑦ 223-BAMW-	50 Ω RG 316 ④② 1 shield⑩ 316-BAMW-	50 Ω RD 316④② 2 shields⑦ 31D-BAMW-
Solder Center, Crimp Outer with Strain Relief							
12	-0120	\$20.96	\$21.98	\$22.74	\$22.17	\$22.39	\$25.04
24	-0240	\$21.36	\$22.22	\$23.74	\$23.64	\$23.04	\$26.89
36	-0360	\$21.76	\$22.46	\$24.74	\$25.11	\$23.69	\$28.74
48	-0480	\$22.16	\$22.70	\$25.74	\$26.58	\$24.34	\$30.59
60	-0600	\$22.56	\$22.94	\$26.74	\$28.05	\$24.99	\$32.44
72	-0720	\$22.96	\$23.18	\$27.74	\$29.52	\$25.64	\$34.29

BNC Male Plug x SMA Reverse Polarity Plug



LTH IN INS	DASH NUM	50 Ω RG 58C ③③ 1 shield ⑦ 058-BAMM-	50 Ω④ RG 142②⑦ 2 shields⑦ 142-BAMM-	50 Ω RG 174 ③⑤ 1 shield⑦ 174-BAMM-	50 Ω④ RG188* ② 1 shield⑩ 188-BAMM-	50 Ω③ RG 223 ① 2 shields⑦ 223-BAMM-	50 Ω RG 316 ④② 1 shield⑩ 316-BAMM-	50 Ω RD 316 ④② 2 shields⑦ 31D-BAMM-
Solder Center, Crimp Outer with Strain Relief								
12	-0120	\$23.46	\$31.96	\$25.19	\$25.95	\$31.13	\$25.60	\$24.84
24	-0240	\$23.86	\$34.26	\$25.43	\$26.95	\$32.60	\$26.25	\$26.69
36	-0360	\$24.26	\$36.56	\$25.67	\$27.95	\$34.07	\$26.90	\$28.54
48	-0480	\$24.66	\$38.86	\$25.91	\$28.95	\$35.54	\$27.55	\$30.39
60	-0600	\$25.06	\$41.16	\$26.15	\$29.95	\$37.01	\$28.20	\$32.24
72	-0720	\$25.46	\$43.46	\$26.39	\$30.95	\$38.48	\$28.85	\$34.09
Color Designators (add letter to the end of the part number and add \$1.00 to price)								
Black - B		Blue - L		Brown - N		Gray - A		Green - G
Orange - O		Red - R		Violet - V		Yellow - Y		White - W

See Page B5 for Cable Characteristics

* Contact Factory for delivery, Consider new RD316 for (RD188)

10% Discount @ 25 pcs. up

4% Discount @ 10 pcs. up

BNC Male Plug x SMA Right Angle Plug

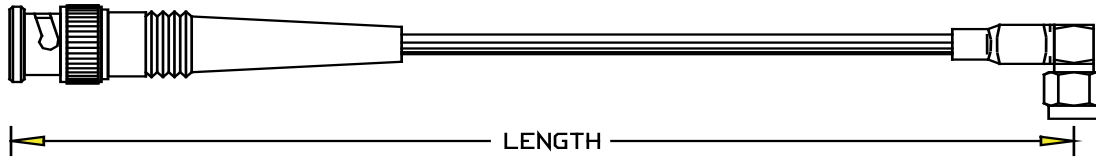

LENGTH IN INCHES	DASH NUMBER	50 Ω ^{③⑥⑦} RG 58C 1 shield 058-BAMC-	50 Ω RG 223 ^{③①} 2 shields ^⑦ 223-BAMC-	50 Ω RG142B ^{④⑦} 2 shields 142-BAMC-	50 Ω ^④ RG 400* ^① 2 shields ^⑦ 400-BAMC-	50 Ω ^① SIG 195 ^③ 2 shields ^⑨ 19C-BAMC-	50 Ω ^① LMR 195 ^③ 2 shields ^⑨ 19M-BAMC-
Solder Center, Crimp Outer							
12	-0120	\$28.94	\$27.73	\$28.56	\$29.26	\$29.11	\$29.25
24	-0240	\$29.34	\$29.20	\$30.86	\$32.26	\$29.68	\$29.96
36	-0360	\$29.74	\$30.67	\$33.16	\$35.26	\$30.25	\$30.67
48	-0480	\$30.14	\$32.14	\$35.46	\$38.26	\$30.82	\$31.38
60	-0600	\$30.54	\$33.61	\$37.76	\$41.26	\$31.39	\$32.09
72	-0720	\$39.94	\$35.08	\$40.06	\$44.26	\$31.96	\$32.80
Solder Center, Crimp Outer							
LENGTH IN INCHES	DASH NUMBER	50 Ω RG 174 ^{③⑤} 1 shield ^⑦ 174-BAMC-	50 Ω RG 316 ^{④②} 1 shield ^⑩ 316-BAMC-	50 Ω ^④ RD316 ^{②⑦} 2 shields 31D-BAMC-	50 Ω RG 188* ^{④②} 1 shield ^⑩ 188-BAMC-	50 Ω RG 178B/U ^② 1 shield ^⑩ 178-BAMC-	
12	-0120	\$29.65	\$30.06	\$25.62	\$30.41	\$41.60	
24	-0240	\$29.89	\$30.71	\$27.47	\$31.41	\$42.34	
36	-0360	\$30.13	\$31.76	\$29.32	\$32.41	\$43.08	
48	-0480	\$30.37	\$32.01	\$31.17	\$33.41	\$43.82	
60	-0600	\$30.61	\$32.66	\$33.02	\$34.41	\$44.56	
72	-0720	\$30.85	\$33.31	\$34.87	\$35.41	\$45.30	
Low Loss Flexible - Solder Center, Crimp Outer							
LENGTH IN INCHES	DASH NUMBER	50 Ω ^{③⑨} SIG 200 ^⑩ 2 shields 2LC-BAMC-	50 Ω ^{③⑨} LMR 200 ^⑩ 2 shields 2LM-BAMC-	50 Ω ^{③⑨} SIG 240 ^⑩ 2 shields 24C-BAMC-	50 Ω ^{③⑨} LMR 240 ^⑩ 2 shields 24L-BAMC-	50 Ω ^{④⑨} SIG 400 ^⑩ 2 shields 4LC-BAMC-	50 Ω ^{④⑨} LMR 400 ^⑩ 2 shields 4LM-BAMC-
12	-0120C	\$19.26	\$19.31	\$20.92	\$21.34	\$25.82	\$26.34
24	-0240C	\$19.94	\$20.04	\$21.52	\$22.36	\$26.68	\$27.72
36	-0360C	\$20.62	\$20.77	\$22.12	\$23.38	\$27.54	\$29.10
48	-0480C	\$21.30	\$21.50	\$22.72	\$24.40	\$28.40	\$30.48
60	-0600C	\$21.98	\$22.23	\$23.32	\$25.42	\$29.26	\$31.86
72	-0720C	\$22.66	\$22.96	\$23.92	\$26.44	\$30.12	\$33.24
Color Designators (add letter to the end of the part number and add \$1.00 to price)							
Black - B		Blue - L		Brown - N		Gray - A	
Orange - O		Red - R		Violet - V		Green - G	
						White - W	

See Page B5 for Cable Characteristics

* Contact Factory for delivery, Consider new RD316 for (RD188) 10% Discount @ 25 pcs. up 4% Discount @ 10 pcs. up

BNC Male Plug x SMB Female Plug



LTH IN INS	DASH NUM	50 Ω ①②⑦ RG 58C 1 shield 058-BAMBA-	50 Ω ①① RG 223 2 shields⑦ 223-BAMBA-	50 Ω ④⑦ RG142B 2 shields 142-BAMBA-	50 Ω RG 174①⑤ 1 shield⑦ 174-BAMBA-	50 Ω RG 316④② 1 shield① 316-BAMBA-	50 Ω ④ RD316②⑦ 2 shields 31D-BAMBA-	50 Ω RG188*④② 1 shield① 188-BAMBA-
Solder Center, Crimp Outer								
12	-0120	\$20.99	\$22.48	\$23.31	\$22.68	\$23.09	\$22.33	\$23.44
24	-0240	\$21.39	\$23.95	\$25.61	\$22.92	\$23.74	\$24.18	\$24.44
36	-0360	\$21.79	\$25.42	\$27.91	\$23.16	\$24.39	\$26.03	\$25.44
48	-0480	\$22.19	\$26.89	\$30.21	\$23.40	\$25.04	\$27.88	\$26.44
60	-0600	\$22.59	\$28.36	\$32.51	\$23.64	\$25.69	\$29.73	\$27.44
72	0720	\$22.99	\$29.83	\$34.81	\$23.88	\$26.34	\$31.58	\$28.44

BNC Male Plug x SMB Right Angle Female Plug



LTH IN INS	DASH NUM	50 Ω ①②⑦ RG 58C 1 shield 058-BAMBC-	50 Ω ①⑦ RG 223⑦ 2 shields 223-BAMBC-	50 Ω ④⑦ RG142B 2 shields 142-BAMBC-	50 Ω RG 174①⑤ 1 shield⑦ 174-BAMBC-	50 Ω RG 316④② 1 shield ① 316-BAMBC-	50 Ω ④ RD316②⑦ 2 shields 31D-BAMBC-	50 Ω RG188*④② 1 shield① 188-BAMBC-
Solder Center, Crimp Outer								
12	-0120	\$21.32	\$34.41	\$35.24	\$22.03	\$22.44	\$27.74	\$22.79
24	-0240	\$21.72	\$35.88	\$37.54	\$22.27	\$23.09	\$29.59	\$23.79
36	-0360	\$22.12	\$37.35	\$39.84	\$22.51	\$23.74	\$31.44	\$24.79
48	-0480	\$22.52	\$38.82	\$42.14	\$22.75	\$24.39	\$33.29	\$25.79
60	-0600	\$22.92	\$40.29	\$44.44	\$22.99	\$25.04	\$35.14	\$26.79
72	-0720	\$23.32	\$41.76	\$46.74	\$23.23	\$25.69	\$36.99	\$27.79
Color Designators (add letter to the end of the part number and add \$1.00 to price)								
Black - B		Blue - L		Brown - N		Gray - A		Green - G
Orange - O		Red - R		Violet - V		Yellow - Y		White - W

See Page B5 for Cable Characteristics

* Contact Factory for delivery, Consider new RD316 for (RD188)

10% Discount @ 25 pcs. up

4% Discount @ 10 pcs. up

BNC Male Plug x SMC Female Plug

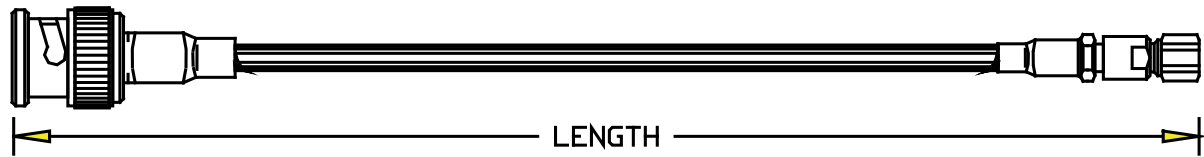

LENGTH IN INCHES	DASH NUMBER	50 Ω ⑤⑥⑦ RG 58C 1 shield 058-BAMCA-	50 Ω ⑤⑦ RG 223① 2 shields 223-BAMCA-	50 Ω ④⑦ RG142B 2 shields 142-BAMCA-	50 Ω RG 174③⑤ 1 shield⑦ 174-BAMCA-	50 Ω RG 316④② 1 shield⑩ 316-BAMCA-	50 Ω④ RD316②⑦ 2 shields 31D-BAMCA-	50 Ω RG188*④② 1 shield⑩ 188-BAMCA-
Solder Center, Crimp Outer								
12	-0120	\$21.85	\$22.68	\$23.51	\$23.09	\$23.50	\$23.29	\$23.85
24	-0240	\$22.25	\$24.15	\$25.81	\$23.33	\$24.15	\$25.14	\$24.85
36	-0360	\$22.65	\$25.62	\$28.11	\$23.57	\$24.80	\$26.99	\$25.85
48	-0480	\$23.05	\$27.09	\$30.41	\$23.81	\$25.45	\$28.84	\$26.85
60	-0600	\$23.45	\$28.56	\$32.71	\$24.05	\$26.10	\$30.69	\$27.85
72	0720	\$23.85	\$30.03	\$35.01	\$24.29	\$26.75	\$32.54	\$28.85

BNC Male Plug x SMC Right Angle Female Plug



LENGTH IN INCHES	DASH NUMBER	50 Ω ⑤⑥⑦ RG 58C 1 shield 058-BAMCC-	50 Ω ⑤⑦ RG 223① 2 shields 223-BAMCC-	50 Ω ④⑦ RG142B 2 shields 142-BAMCC-	50 Ω RG 174③⑤ 1 shield⑦ 174-BAMCC-	50 Ω RG 316④② 1 shield⑩ 316-BAMCC-	50 Ω④ RD316②⑦ 2 shields 31D-BAMCC-	50 Ω RG188*④② 1 shield⑩ 188-BAMCC-
Solder Center, Crimp Outer								
12	-0120	\$29.31	\$30.14	\$30.97	\$28.91	\$29.32	\$23.51	\$29.67
24	-0240	\$29.71	\$31.61	\$33.27	\$29.15	\$29.97	\$25.36	\$30.67
36	-0360	\$30.11	\$33.08	\$35.57	\$29.39	\$30.62	\$27.21	\$31.67
48	-0480	\$30.51	\$34.55	\$37.87	\$29.63	\$31.27	\$29.06	\$32.67
60	-0600	\$30.91	\$36.02	\$40.17	\$29.87	\$31.92	\$30.91	\$33.67
72	-0720	\$31.31	\$37.49	\$42.47	\$30.11	\$32.57	\$32.76	\$34.67
Color Designators (add letter to the end of the part number and add \$1.00 to price)								
Black - B		Blue - L		Brown - N		Gray - A		Green - G
Orange - O		Red - R		Violet - V		Yellow - Y		White - W

See Page B5 for Cable Characteristics

* Contact Factory for delivery, Consider new RD316 for (RD188)

10% Discount @ 25 pcs. up

4% Discount @ 10 pcs. up



RF Depot.com Inc.

Phone 856-488-2000 Fax 856-488-2020

BNC Male Plug x SSMB Female Plug



LENGTH IN INCHES	DASH NUM	50 Ω RG 174 ^{③⑤} 1 shield ^⑦ 174-B0SB0-	50 Ω RG 316 ^{④②} 1 shield ^⑩ 316-B0SB0-	50 Ω ^④ RD316 ^{②⑦} 2 shields 31D-B0SB0-	50 Ω RG188* ^{④②} 1 shield ^⑩ 188-B0SB0-	50 Ω ^② RG 178B/U 1 shield ^⑩ 178-B0SB0-	50 Ω RG 196 ^② 1 shield ^⑩ 196-B0SB0-	50 Ω ^{②⑦} RD188* ^④ 2 shields 88D-B0SB0-
Solder Center, Crimp Outer								
12	-0120	\$29.71	\$30.12	\$29.36	\$30.47	\$32.88	\$32.88	\$31.03
24	-0240	\$29.95	\$30.77	\$31.21	\$31.47	\$33.62	\$33.62	\$34.55
36	-0360	\$30.19	\$31.42	\$33.06	\$32.47	\$34.36	\$34.36	\$38.07
48	-0480	\$30.43	\$32.07	\$34.91	\$33.47	\$35.10	\$35.10	\$41.59
60	-0600	\$30.67	\$32.72	\$36.76	\$34.47	\$35.84	\$35.84	\$45.11
72	-0720	\$30.91	\$33.37	\$38.61	\$35.47	\$36.58	\$36.58	\$48.63
.047" Diameter SEMIRIGID and Maxi Flex. Direct Solder Connectors								
LENGTH IN INCHES	DASH NUM	50Ω ^② M17/151-00001 .047 Cu Jacket 4CU-B0SB0-	50Ω (No QPL List) .047 Tin Plate Al 4AT-B0SB0-	50Ω ^② M17/151-00002 .047 Tin Plate Cu 4TS-B0SB0-	50ΩMaxiFlex ^② (No QPL List) .047 Tin Pl 04F-B0SB0-	50Ω ^① Non-Magnetic .047 Tin Plate Cu 4CT-B0SB0-		
12	-0120	\$45.08	\$46.53	\$45.08	\$45.78	\$47.96		
24	-0240	\$48.88	\$51.78	\$48.88	\$50.28	\$54.64		
36	-0360	\$52.68	\$57.03	\$52.68	\$54.78	\$61.32		
48	-0480	\$56.48	\$62.28	\$56.48	\$59.28	\$68.00		
60	-0600	\$60.28	\$67.53	\$60.28	\$63.78	\$74.68		
72	-0720	\$64.08	\$72.78	\$64.08	\$68.28	\$81.36		
.085" Diameter SEMIRIGID and Maxi Flex. Direct Solder Connectors								
LTH IN INS	DASH NUM	50Ω RG 405 ^② M17/133-00007 .085 Tin Plate Cu 405-B0SB0-	50Ω RG 405 ^② M17/133-00007 .085 Tin Plate Cu 8TS-B0SB0-	50Ω RG 405 ^② M17/133-00013 .085 Tin Plate Al 8AT-B0SB0-	50Ω MaxiFlex ^② (No QPL List) .085 Tin Pl 08F-B0SB0-	50Ω RG 405 ^② M17/133-00016 .085 Silver Pl 8SS-B0SB0-	50Ω RG 405 ^① Non-Magnetic .085 Tin Plate Cu 8CT-B0SB0-	
12	-0120	\$31.64	\$31.64	\$32.58	\$32.87	\$36.83	\$30.80	
24	-0240	\$34.66	\$34.66	\$36.54	\$37.12	\$45.04	\$32.98	
36	-0360	\$37.68	\$37.68	\$40.50	\$41.37	\$53.25	\$35.16	
48	-0480	\$40.70	\$40.70	\$44.46	\$45.62	\$61.46	\$37.34	
60	-0600	\$43.72	\$43.72	\$48.42	\$49.87	\$69.67	\$39.52	
72	-0720	\$46.74	\$46.74	CALL	\$54.12	CALL	\$41.70	
Color Designators (add letter to the end of the part number and add \$1.00 to price)								
Black - B		Blue - L		Brown - N		Gray - A		Green - G
Orange - O		Red - R		Violet - V		Yellow - Y		White - W

See Page B5 for Cable Characteristics

* Contact Factory for delivery, Consider new RD316 for (RD188) 10% Discount @ 25 pcs. up 4% Discount @ 10 pcs. up

①Silver Plated Copper Center Conductor ②Silver Plated Copper Clad Steel Center Conductor



RF Depot.com Inc.

Phone 856-488-2000 Fax 856-488-2020

7850 Browning Rd. Pennsauken, NJ 08109

Online @ www.rfdepot.com

Toll Free 877-RF Depot

BNC Male Plug x SSMC Female Plug

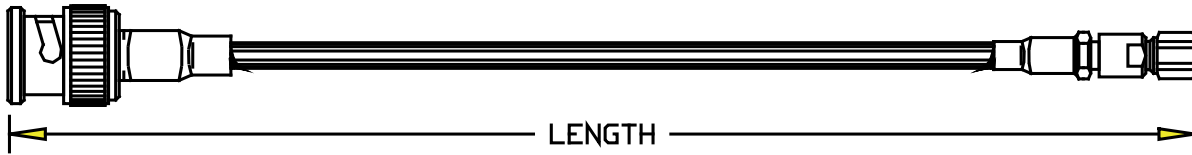

LTH IN INS	DASH NUM	50 Ω RG 174 ^⑤ 1 shield ^⑦ 174-BACSA-	50 Ω RG 316 ^{④②} 1 shield ^⑩ 316-BACSA-	50 Ω ^④ RD316 ^{②⑦} 2 shields 31D-BACSA-	50 Ω RG188* ^{④②} 1 shield ^⑩ 188-BACSA-	50 Ω ^② RG 178B/U 1 shield ^⑩ 178-BACSA-	50 Ω RG 196 ^② 1 shield ^⑩ 196-BACSA-	50 Ω ^{②⑦④} RD188* 2 shields 88D-BACSA-
------------------	-------------	--	---	---	---	---	--	--

Solder Center, Crimp Outer

12	-0120	\$32.64	\$33.05	\$32.29	\$33.40	\$40.45	\$40.45	\$33.96
24	-0240	\$32.88	\$33.70	\$34.14	\$34.40	\$41.19	\$41.19	\$37.48
36	-0360	\$33.12	\$34.35	\$35.99	\$35.40	\$41.93	\$41.93	\$41.00
48	-0480	\$33.36	\$35.00	\$37.84	\$36.40	\$42.67	\$42.67	\$44.52
60	-0600	\$33.60	\$35.65	\$39.69	\$37.40	\$43.41	\$43.41	\$48.04
72	-0720	\$33.84	\$36.30	\$41.54	\$38.40	\$44.15	\$44.15	\$51.56

.047" Diameter SEMIRIGID and Maxi Flex. Direct Solder Connectors

LTH IN INS	DASH NUM	50Ω ^② M17/151-00001 .047 Cu Jacket 4CU-BACSA-	50Ω (No QPL List) .047 Tin Plate Al 4AT-BACSA-	50Ω ^② M17/151-00002 .047 Tin Plate Cu 4TS-BACSA-	50ΩMaxiFlex ^② (No QPL List) .047 Tin Plate Braid 04F-BACSA-	50Ω ^① Non-Magnetic .047 Tin Plate Cu 4CT-BACSA-
12	-0120	\$45.47	\$46.92	\$45.47	\$46.17	\$48.35
24	-0240	\$49.27	\$52.17	\$49.27	\$50.67	\$55.03
36	-0360	\$53.07	\$57.42	\$53.07	\$55.17	\$61.71
48	-0480	\$56.87	\$62.67	\$56.87	\$59.67	\$68.39
60	-0600	\$60.67	\$67.92	\$60.67	\$64.17	\$75.03
72	-0720	\$64.47	\$73.17	\$64.47	\$68.67	\$81.75

.085" Diameter SEMIRIGID and Maxi Flex. Direct Solder Connectors

LTH IN INS	DASH NUM	50Ω RG 405 ^② M17/133-00007 .085 Tin Pl Cu 405-BACSA-	50Ω RG 405 ^② M17/133-00007 .085 Tin Pl Cu 8TS-BACSA-	50Ω RG 405 ^② M17/133-00013 .085 Tin Pl Al 8AT-BACSA-	50ΩMaxiFlex ^② (No QPL List) .085 Tin Pl 08F-BACSA-	50Ω RG 405 ^② M17/133-00016 .085 Silver Pl 8SS-BACSA-	50Ω RG 405 ^① Non-Magnetic .085 Tin Pl Cu 8CT-BACSA-
12	-0120	\$33.43	\$33.43	\$34.37	\$34.66	\$38.62	\$32.59
24	-0240	\$36.45	\$36.45	\$38.33	\$38.91	\$46.83	\$34.77
36	-0360	\$39.47	\$39.47	\$42.29	\$43.16	\$55.04	\$36.95
48	-0480	\$42.49	\$42.49	\$46.25	\$47.41	\$63.25	\$39.13
60	-0600	\$45.51	\$45.51	\$50.21	\$51.66	\$71.46	\$41.31
72	-0720	\$48.53	\$48.53	CALL	\$55.91	CALL	\$43.49

Color Designators (add letter to the end of the part number and add \$1.00 to price)

Black - B	Blue - L	Brown - N	Gray - A	Green - G
Orange - O	Red - R	Violet - V	Yellow - Y	White - W

See Page B5 for Cable Characteristics

* Contact Factory for delivery, Consider new RD316 for (RD188) 10% Discount @ 25 pcs. up 4% Discount @ 10 pcs. up

①Silver Plated Copper Center Conductor ②Silver Plated Copper Clad Steel Center Conductor



RF Depot.com Inc.

Phone 856-488-2000 Fax 856-488-2020

BNC Male Plug x TNC Male Plug



LENGTH IN INCHES	DASH NUMBER	50 Ω ^{③⑥⑦} RG 58C 1 shield 058-BATA-	50 Ω ^{③⑦} RG 223 ^① 2 shields 223-BATA-	50 Ω ^{④⑦} RG142B 2 shields 142-BATA-	50 Ω ^{④①} RG 400* 2 shields ^⑦ 400-BATA-	75 Ω ^{⑤⑧} RG 59B ^⑨ 1 shield 059-BATA-	93 Ω ^{⑤⑧} RG 62 ^⑨ 1 shield 062-BATA-		
Solder Center, Crimp Outer									
12	-0120	\$19.70	\$23.85	\$24.68	\$25.38	\$26.92	\$27.18		
24	-0240	\$20.10	\$25.32	\$26.98	\$28.38	\$27.36	\$27.88		
36	-0360	\$20.50	\$26.79	\$29.28	\$31.38	\$27.80	\$28.58		
48	-0480	\$20.90	\$28.26	\$31.58	\$34.38	\$28.24	\$29.28		
60	-0600	\$21.30	\$29.73	\$33.88	\$37.38	\$28.68	\$29.98		
72	-0720	\$21.70	\$31.20	\$36.18	\$40.38	\$29.12	\$30.62		
Solder Center, Crimp Outer									
LENGTH IN INCHES	DASH NUMBER	50 Ω RG 174 ^{③⑤} 1 shield ^⑦ 174-BATA-	50 Ω RG 316 ^{④②} 1 shield ^⑩ 316-BATA-	50 Ω ^④ RD316 ^{②⑦} 2 shields 31D-BATA-	50 Ω RG188* ^{④②} 1 shield ^⑩ 188-BATA-	50 Ω ^④ RD188* ^{②⑦} 2 shields 88D-BATA-	75 Ω RG179A ^{④②} 1 shield ^⑩ 179-BATA-		
12	-0120	\$22.70	\$23.11	\$22.35	\$23.46	\$24.02	\$22.10		
24	-0240	\$22.94	\$23.76	\$24.20	\$24.46	\$27.54	\$22.89		
36	-0360	\$23.18	\$24.41	\$26.05	\$25.46	\$31.06	\$23.68		
48	-0480	\$23.42	\$25.06	\$27.90	\$26.46	\$34.58	\$24.47		
60	-0600	\$23.66	\$25.71	\$29.75	\$27.46	\$38.10	\$25.26		
72	-0720	\$23.90	\$26.36	\$31.60	\$28.46	\$41.62	\$26.05		
Solder Center, Crimp Outer									
LENGTH IN INCHES	DASH NUMBER	50 Ω RG 8* ^{③③⑧} 1 shield 008-BATA-	50 Ω ^{③⑧} RG 213 ^⑨ 1 shield 213-BATA-	50 Ω ^⑨ RG 214 ^① 2 shields ^⑦ 214-BATA-	50 Ω ^{③⑨} SIG 300 ^⑩ 2 shields 3LC-BATA-	50 Ω ^{③⑨} LMR 300 ^⑩ 2 shields 3LM-BATA-	50 Ω ^{④⑨} SIG 400 ^⑩ 2 shields 4LC-BATA-	50 Ω ^{④⑨} LMR 400 ^⑩ 2 shields 4LM-BATA-	
12	-0120	\$25.76	\$25.94	\$28.55	\$42.95	\$43.35	\$25.95	\$26.47	
24	-0240	\$27.16	\$27.52	\$32.05	\$43.67	\$44.47	\$26.81	\$27.85	
36	-0360	\$28.56	\$29.10	\$35.55	\$44.39	\$45.59	\$27.67	\$29.23	
48	-0480	\$29.96	\$30.68	\$39.05	\$45.11	\$46.71	\$28.53	\$30.61	
60	-0600	\$31.36	\$32.26	\$42.55	\$45.83	\$47.83	\$29.39	\$31.99	
72	-0720	\$32.76	\$33.84	\$46.05	\$46.55	\$48.95	\$30.25	\$33.37	
Color Designators (add letter to the end of the part number and add \$1.00 to price)									
Black - B		Blue - L		Brown - N		Gray - A		Green - G	
Orange - O		Red - R		Violet - V		Yellow - Y		White - W	

See Page B5 for Cable Characteristics

* Contact Factory for delivery, Consider new RD316 for (RD188)

10% Discount @ 25 pcs. up

4% Discount @ 10 pcs. up

BNC Male Plug x UHF Male Plug

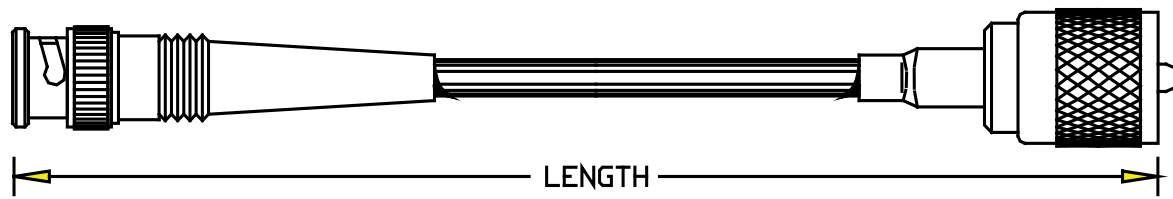

LENGTH IN INCHES	DASH NUMBER	50 Ω [Ⓢ] Ⓣ [Ⓢ] RG 58C 1 shield 058-BAUA-	50 Ω [Ⓢ] Ⓣ [Ⓢ] RG 223 [Ⓢ] 2 shields 223-BAUA-	50 Ω [Ⓢ] Ⓣ [Ⓢ] RG142B 2 shields 142-BAUA-	50 Ω [Ⓢ] Ⓣ [Ⓢ] RG 400* 2 shields [Ⓢ] 400-BAUA-	75 Ω RG179A [Ⓢ] Ⓣ [Ⓢ] 1 shield [Ⓢ] 179-BAUA-	
Solder Center, Crimp Outer							
12	-0120	\$18.30	\$18.73	\$19.56	\$20.26	\$17.85	
18	-0180	\$18.50	\$19.47	\$20.71	\$21.76	\$18.22	
24	-0240	\$18.70	\$20.20	\$21.86	\$23.26	\$18.58	
30	-0300	\$18.90	\$20.94	\$23.01	\$24.76	\$18.95	
36	-0360	\$19.10	\$21.67	\$24.16	\$26.26	\$19.31	
42	-0420	\$19.30	\$22.41	\$25.31	\$27.76	\$19.68	
48	-0480	\$19.50	\$23.14	\$26.46	\$29.26	\$20.04	
54	-0540	\$19.70	\$23.88	\$27.61	\$30.76	\$20.41	
60	-0600	\$19.90	\$24.61	\$28.76	\$32.26	\$20.77	
66	-0660	\$20.10	\$25.35	\$29.91	\$33.76	\$21.14	
Solder Center, Crimp Outer							
LENGTH IN INCHES	DASH NUMBER	50 Ω [Ⓢ] RG 8* [Ⓢ] Ⓣ [Ⓢ] 1 shield 008-BAUA-	50 Ω [Ⓢ] RG 213 [Ⓢ] 1 shield 213-BAUA-	50 Ω [Ⓢ] RG 214 [Ⓢ] 2 shields [Ⓢ] 214-BAUA-	75 Ω [Ⓢ] RG 59B [Ⓢ] 1 shield 059-BAUA-	93 Ω [Ⓢ] RG 62 [Ⓢ] 1 shield 062-BAUA-	50 Ω [Ⓢ] RG 393 [Ⓢ] 2 shields 393-BAUA-
12	-0120	\$22.81	\$22.99	\$25.36	\$25.90	\$26.16	\$30.16
18	-0180	\$23.51	\$23.78	\$27.11	\$26.12	\$26.51	\$34.48
24	-0240	\$24.21	\$24.57	\$28.86	\$26.34	\$26.86	\$38.79
30	-0300	\$24.91	\$25.36	\$30.61	\$26.56	\$27.21	\$43.11
36	-0360	\$25.61	\$26.15	\$32.36	\$26.78	\$27.56	\$47.42
42	-0420	\$26.31	\$26.94	\$34.11	\$27.00	\$27.91	\$51.74
48	-0480	\$27.01	\$27.73	\$35.86	\$27.22	\$28.26	\$56.05
54	-0540	\$27.71	\$28.52	\$37.61	\$27.44	\$28.61	\$60.37
60	-0600	\$28.41	\$29.31	\$39.36	\$27.66	\$28.96	\$64.68
66	-0660	\$29.11	\$30.10	\$41.11	\$27.88	\$29.31	\$69.00
72	-0720	\$29.81	\$30.89	\$42.86	\$28.10	\$29.66	\$73.31
Color Designators (add letter to the end of the part number and add \$1.00 to price)							
Black - B		Blue - L		Brown - N		Gray - A	
Orange - O		Red - R		Violet - V		Green - G	
						White - W	

See Page B5 for Cable Characteristics

* Contact Factory for delivery, Consider new RD316 for (RD188)

10% Discount @ 25 pcs. up

4% Discount @ 10 pcs. up



RF Depot.com Inc.

Phone 856-488-2000 Fax 856-488-2020

BNC Right Angle Male Plug x BNC Right Angle Male Plug

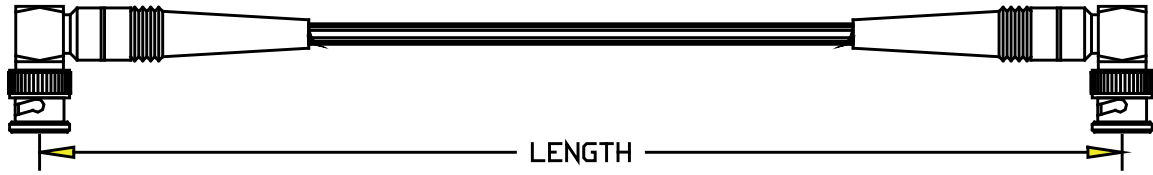

LENGTH IN INCHES	DASH NUMBER	50 Ω ⑤⑥⑦ RG 58C 1 shield 058-BCBC-	50 Ω ⑥⑦ RG 223① 2 shields 223-BCBC-	50 Ω ④⑦ RG142B 2 shields 142-BCBC-	50 Ω ④① RG 400* 2 shields⑦ 400-BCBC-				
Solder Center, Crimp Outer (Factory Clocking)									
12	-0120	\$27.56	\$29.37	\$30.20	\$30.90				
24	-0240	\$27.96	\$30.84	\$32.50	\$33.90				
36	-0360	\$28.36	\$32.31	\$34.80	\$36.90				
48	-0480	\$28.76	\$33.78	\$37.10	\$39.90				
60	-0600	\$29.16	\$35.25	\$39.40	\$42.90				
72	-0720	\$29.56	\$36.72	\$41.70	\$45.90				
Solder Center, Crimp Clamp Outer (Field Clockable)									
LENGTH IN INCHES	DASH NUMBER	50 Ω RG 174⑤⑥ 1 shield⑦ 174-BCBC-	50 Ω RG 316④② 1 shield⑥ 316-BCBC-	50 Ω④ RD316②⑦ 2 shields 31D-BCBC-	50 Ω RG188*④② 1 shield⑥ 188-BCBC-	50 Ω②⑦④ RD188* 2 shields 88D-BCBC-	75 Ω RG179A④② 1 shield⑥ 179-BCBC-		
12	-0120E	\$44.24	\$44.65	\$45.85	\$45.00	\$47.52	\$44.73		
24	-0240E	\$44.48	\$45.30	\$47.70	\$46.00	\$51.04	\$45.46		
36	-0360E	\$44.72	\$45.95	\$49.55	\$47.00	\$54.56	\$46.19		
48	-0480E	\$44.96	\$46.60	\$51.40	\$48.00	\$58.08	\$46.92		
60	-0600E	\$45.20	\$47.25	\$53.25	\$49.00	\$61.60	\$47.65		
72	-0720E	\$45.44	\$47.90	\$55.10	\$50.00	\$65.12	\$48.38		
Solder Center, Crimp Outer (Factory Clocking)									
LENGTH IN INCHES	DASH NUMBER	50 Ω RG 8*⑤③⑥ 1 shield 008-BCBC-	50 Ω RG 213⑤③⑥ 1 shield 213-BCBC-	50 Ω RG 214⑤① 2 shields⑦ 214-BCBC-	75 Ω RG 59B⑤③⑥ 1 shield 059-BCBC-	93 Ω⑤ RG 62⑤⑥ 1 shield 062-BCBC-			
12	-0120	\$25.91	\$26.44	\$28.86	\$44.90	\$45.16			
24	-0240	\$26.96	\$28.02	\$32.36	\$45.34	\$45.86			
36	-0360	\$28.01	\$29.60	\$35.86	\$45.78	\$46.56			
48	-0480	\$29.06	\$31.18	\$39.36	\$46.22	\$47.26			
60	-0600	\$30.11	\$32.76	\$42.86	\$46.66	\$47.96			
72	-0720	\$31.16	\$34.34	\$46.36	\$47.10	\$48.66			
Color Designators (add letter to the end of the part number and add \$1.00 to price)									
Black - B		Blue - L		Brown - N		Gray - A		Green - G	
Orange - O		Red - R		Violet - V		Yellow - Y		White - W	

See Page B5 for Cable Characteristics

* Contact Factory for delivery, Consider new RD316 for (RD188)

10% Discount @ 25 pcs. up

4% Discount @ 10 pcs. up

C Male Plug x C Male Plug

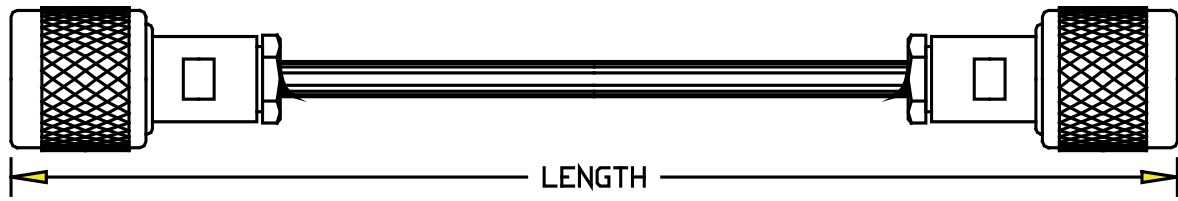

LENGTH IN INCHES	DASH NUMBER	50 Ω ^{③⑥⑦} RG 58C 1 shield 058-C0C0-	50 Ω ^{③⑦} RG 223 ^① 2 shields 223-C0C0-	50 Ω ^{④⑦} RG142B 2 shields 142-C0C0-	50 Ω ^{④①} RG 400* 2 shields ^⑦ 400-C0C0-	50 Ω ^② RG 141A 2 shields ^⑥ 141-C0C0-	50 Ω ^{①⑦} RG 225 2 shield 225-C0C0-
Solder Center, Clamp Outer							
12	-0120	\$48.40	\$49.47	\$50.30	\$51.00	\$49.48	\$79.80
18	-0180	\$48.60	\$50.21	\$51.45	\$52.50	\$50.22	\$89.07
24	-0240	\$48.80	\$50.94	\$52.60	\$54.00	\$50.96	\$98.34
30	-0300	\$49.00	\$51.68	\$53.75	\$55.50	\$51.70	\$107.61
36	-0360	\$49.20	\$52.41	\$54.90	\$57.00	\$52.44	\$116.88
42	-0420	\$49.40	\$53.15	\$56.05	\$58.50	\$53.18	\$126.15
48	-0480	\$49.60	\$53.88	\$57.20	\$60.00	\$53.92	\$135.42
54	-0540	\$49.80	\$54.62	\$58.35	\$61.50	\$54.66	\$144.69
60	-0600	\$50.00	\$55.35	\$59.50	\$63.00	\$55.40	\$153.96
66	-0660	\$50.20	\$56.09	\$60.65	\$64.50	\$56.14	\$163.23
72	-0720	\$50.40	\$56.82	\$61.80	\$66.00	\$56.88	\$172.50
Solder Center, Clamp Outer							
LENGTH IN INCHES	DASH NUMBER	50 Ω ^{③③③} RG 8* ^{③③③} 1 shield 008-C0C0-	50 Ω ^③ RG 213 ^{③③} 1 shield 213-C0C0-	50 Ω ^{③①} RG 214 ^{③①} 2 shields ^⑦ 214-C0C0-	75 Ω ^③ RG 59B ^{③③} 1 shield 059-C0C0-	93 Ω ^③ RG 62 ^{③③} 1 shield 062-C0C0-	50 Ω ^④ RG 393 ^{①⑦} 2 shields 393-C0C0-
12	-0120	\$62.66	\$62.84	\$64.76	\$76.44	\$76.70	\$69.89
18	-0180	\$63.36	\$63.63	\$66.51	\$76.66	\$77.05	\$74.21
24	-0240	\$64.06	\$64.42	\$68.26	\$76.88	\$77.40	\$78.52
30	-0300	\$64.76	\$65.21	\$70.01	\$77.10	\$77.75	\$82.84
36	-0360	\$65.46	\$66.00	\$71.76	\$77.32	\$78.10	\$87.15
42	-0420	\$66.16	\$66.79	\$73.51	\$77.54	\$78.45	\$91.47
48	-0480	\$66.86	\$67.58	\$75.26	\$77.76	\$78.80	\$95.78
54	-0540	\$67.56	\$68.37	\$77.01	\$77.98	\$79.15	\$100.10
60	-0600	\$68.26	\$69.16	\$78.76	\$78.20	\$79.50	\$104.41
66	-0660	\$68.96	\$69.95	\$80.51	\$78.42	\$79.85	\$108.73
72	-0720	\$69.66	\$70.74	\$82.26	\$78.64	\$80.20	\$113.04
Color Designators (add letter to the end of the part number and add \$1.00 to price)							
Black - B		Blue - L		Brown - N		Gray - A	
Orange - O		Red - R		Violet - V		Green - G	
						White - W	

See Page B5 for Cable Characteristics

* Contact Factory for delivery, Consider new RD316 for (RD188)

10% Discount @ 25 pcs. up

4% Discount @ 10 pcs. up



RF Depot.com Inc.

Phone 856-488-2000 Fax 856-488-2020

F Male Plug x F Male Plug



LENGTH IN INCHES	DASH NUMBER	75 Ω ^⑤ RG 6 2 shields 006-FAFA-	75 Ω RG 11 ^⑥ 1 shield ^⑥ 011-FAFA-	75 Ω RG 187 ^⑦ 1 shield ^⑦ 187-FAFA-	75 Ω RG 216 ^{⑧⑥} 2 shields 216-FAFA-	75 Ω ^{⑤⑧} RG 59B ^⑤ 1 shield 059-FAFA-	93 Ω ^{⑤⑧} RG 62 ^⑤ 1 shield 062-FAFA-
Solder Center, Crimp Outer							
12	-0120	\$11.80	\$19.21	\$14.12	\$19.46	\$12.00	\$12.26
24	-0240	\$12.50	\$20.26	\$15.72	\$20.76	\$12.44	\$12.96
36	-0360	\$13.20	\$21.31	\$17.32	\$22.06	\$12.88	\$13.66
48	-0480	\$13.90	\$22.36	\$18.92	\$23.36	\$13.32	\$14.36
60	-0600	\$14.60	\$23.41	\$20.52	\$24.66	\$13.76	\$15.06
Solder Center, Crimp Outer							
LENGTH IN INCHES	DASH NUMBER	50 Ω RG 174 ^{④⑤} 1 shield ^⑦ 174-FAFA-	50 Ω RG 316 ^{④②} 1 shield ^⑦ 316-FAFA-	50 Ω ^④ RD316 ^{②⑦} 2 shields 31D-FAFA-	50 Ω RG188* ^{④②} 1 shield ^⑦ 188-FAFA-	50 Ω ^{②⑦④} RD188* 2 shields 88D-FAFA-	75 Ω RG179A ^{④②} 1 shield ^⑦ 179-FAFA-
12	-0120	\$22.42	\$22.83	\$24.03	\$23.18	\$25.70	\$13.25
24	-0240	\$22.66	\$23.48	\$25.88	\$24.18	\$29.22	\$13.98
36	-0360	\$22.90	\$24.13	\$27.73	\$25.18	\$32.74	\$14.71
48	-0480	\$23.14	\$24.78	\$29.58	\$26.18	\$36.26	\$15.44
60	-0600	\$23.38	\$25.43	\$31.43	\$27.18	\$39.78	\$16.17

F Male Plug x 75 Ω BNC Male Plug



LENGTH IN INCHES	DASH NUMBER	75 Ω ^⑤ RG 6 2 shields 006-FASA-	75 Ω RG 11 ^⑥ 1 shield ^⑥ 011-FASA-	75 Ω ^{⑤⑧} RG 59B ^⑤ 1 shield 059-FASA-	93 Ω ^{⑤⑧} RG 62 ^⑤ 1 shield 062-FASA-	75 Ω ^② RG179A ^④ 1 shield ^⑦ 179-FASA-	75 Ω ^② RG 187 1 shield ^⑦ 187-FASA-	75 Ω RG 216 ^{④⑥} 2 shields 216-FASA-
Solder Center, Crimp Outer								
12	-0120	\$15.25	\$22.04	\$15.98	\$16.24	\$18.17	\$19.04	\$22.29
24	-0240	\$15.95	\$23.09	\$16.42	\$16.94	\$18.90	\$20.64	\$23.59
36	-0360	\$16.65	\$24.14	\$16.86	\$17.64	\$19.63	\$22.24	\$24.89
48	-0480	\$17.35	\$25.19	\$17.30	\$18.34	\$20.36	\$23.04	\$26.16
60	-0600	\$18.05	\$26.24	\$17.74	\$19.04	\$21.09	\$25.44	\$27.49
72	-0720	\$18.75	\$27.29	\$18.18	\$19.74	\$21.82	\$26.64	\$28.78
Color Designators (add letter to the end of the part number and add \$1.00 to price)								
Black - B		Blue - L		Brown - N		Gray - A		Green - G
Orange - O		Red - R		Violet - V		Yellow - Y		White - W

See Page B5 for Cable Characteristics

* Contact Factory for delivery, Consider new RD316 for (RD188)

10% Discount @ 25 pcs. up

4% Discount @ 10 pcs. up

GR 874 x GR 874

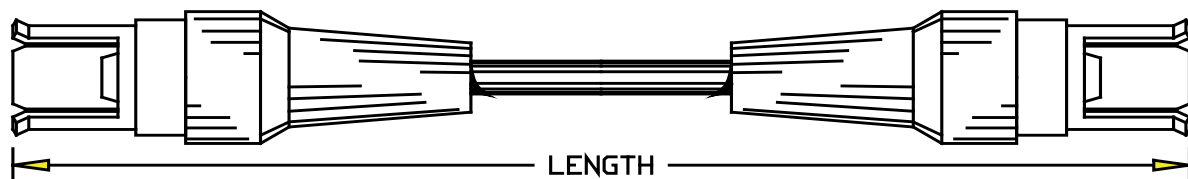

LENGTH IN INCHES	DASH NUMBER	50 Ω ^{③⑥⑦} RG 58C 1 shield 058-GRAGRA-	50 Ω ^{③⑦} RG 223 ^① 2 shields 223-GRAGRA-	50 Ω ^{④⑦} RG142B 2 shields 142-GRAGRA-	50 Ω ^{④①} RG 400* 2 shields ^⑦ 400-GRAGRA-	50 Ω RG 214 ^{③①} 2 shields ^⑦ 214-GRAGRA-
Solder Center, Crimp Outer						
12	-0120	\$178.46	\$178.46	\$178.46	\$178.46	\$100.35
24	-0240	\$178.66	\$179.52	\$179.76	\$180.71	\$138.95
36	-0360	\$178.86	\$180.58	\$181.06	\$182.92	\$142.90
48	-0480	\$179.06	\$181.64	\$182.36	\$185.21	\$146.85
60	-0600	\$179.46	\$183.76	\$184.96	\$189.71	\$173.55
72	-0720	\$179.66	\$184.82	\$186.26	\$191.96	\$176.55

GR 874 x N Male Plug

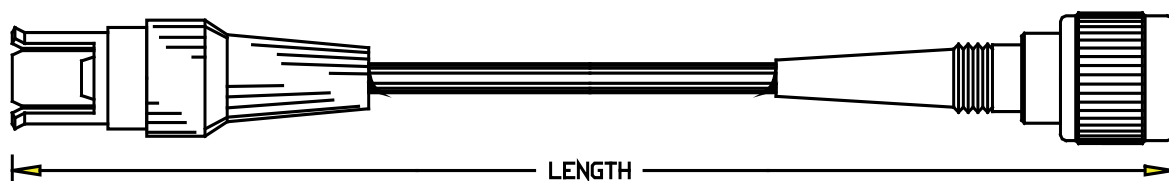

LENGTH IN INCHES	DASH NUMBER	50 Ω ^{③⑥⑦} RG 58C 1 shield 058-GRANA-	50 Ω ^{③⑦} RG 223 ^① 2 shields 223-GRANA-	50 Ω ^{④⑦} RG142B 2 shields 142-GRANA-	50 Ω ^① RG 400* ^④ 2 shields ^⑦ 400-GRANA-	50 Ω RG 214 ^{③①} 2 shields ^⑦ 214-GRANA-
Solder Center, Crimp Outer						
12	-0120	\$122.65	\$123.37	\$123.37	\$123.37	\$126.93
24	-0240	\$122.85	\$124.43	\$124.67	\$125.62	\$131.83
36	-0360	\$123.05	\$125.49	\$125.97	\$127.87	\$136.73
48	-0480	\$123.25	\$126.55	\$127.27	\$130.12	\$141.61
60	-0600	\$123.65	\$128.67	\$129.87	\$134.62	\$151.43
72	-0720	\$123.85	\$129.73	\$131.17	\$136.87	\$156.33
Color Designators (add letter to the end of the part number and add \$1.00 to price)						
Black - B		Blue - L		Brown - N		Gray - A
Orange - O		Red - R		Violet - V		Green - G
						White - W

See Page B5 for Cable Characteristics

* Contact Factory for delivery, Consider new RD316 for (RD188) 10% Discount @ 25 pcs. up 4% Discount @ 10 pcs. up



RF Depot.com Inc.

Phone 856-488-2000 Fax 856-488-2020

HN Male Plug x HN Male Plug

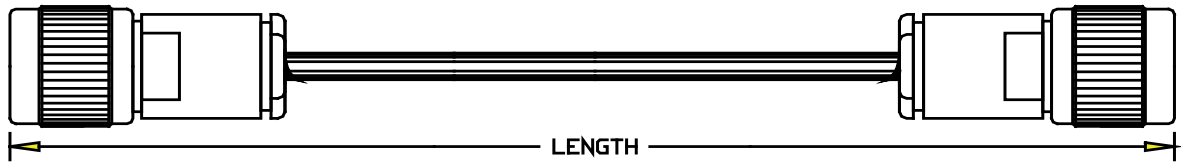

LENGTH IN INCHES	DASH NUMBER	50 Ω ③⑥⑦ RG 58C 1 shield 058-HN0HN0-	50 Ω ③⑦ RG 223① 2 shields 223-HN0HN0-	50 Ω ④⑦ RG142B 2 shields 142-HN0HN0-	50 Ω ① RG 400*④ 2 shields⑦ 400-HN0HN0-	50 Ω ②⑩ RG 141A 2 shields 141-HN0HN0-
Solder Center, Clamp Outer						
12	-0120	\$79.30	\$80.37	\$81.20	\$81.90	\$8038
24	-0240	\$79.70	\$81.84	\$83.50	\$84.90	\$81.86
36	-0360	\$80.10	\$83.31	\$85.80	\$87.90	\$83.34
48	-0480	\$80.50	\$84.78	\$88.10	\$90.90	\$80.42
60	-0600	\$80.90	\$86.25	\$90.40	\$93.90	\$86.30
72	-0720	\$81.30	\$87.72	\$92.70	\$96.90	\$87.78
Solder Center, Clamp Outer						
LENGTH IN INCHES	DASH NUMBER	50 Ω RG 8*③③③ 1 shield 008-HN0HN0-	50 Ω RG 213③③③ 1 shield 213-HN0HN0-	50 Ω RG 214③① 2 shields⑦ 214-HN0HN0-	75 Ω ⑤⑧ RG 59B③ 1 shield 059-HN0HN0-	93 Ω ⑤⑧ RG 62③ 1 shield 062-HN0HN0-
12	-0120	\$89.50	\$89.68	\$91.60	\$85.50	\$85.76
24	-0240	\$90.90	\$91.26	\$95.10	\$85.94	\$86.26
36	-0360	\$92.30	\$92.84	\$98.60	\$86.38	\$87.16
48	-0480	\$93.70	\$94.42	\$102.10	\$86.82	\$87.86
60	-0600	\$95.10	\$96.00	\$105.60	\$87.26	\$88.56
72	-0720	\$96.50	\$97.58	\$109.10	\$87.70	\$89.26
Solder Center, Clamp Outer						
LENGTH IN INCHES	DASH NUMBER	50 Ω ③⑧ RG 217/U 2 shields 217-HN0HN0-	50 Ω ③⑧ RG 218 1 shield 218-HN0HN0-	50 Ω ①⑦ RG 225 2 shields 225-HN0HN0-	50 Ω RG 393④①⑦ 2 shields 393-HN0HN0-	50 Ω FSJ4-50B④ 1 shield .500" SUPERFLEX 50J-HN0HN0-
12	-0120	\$105.94	\$244.58	\$106.64	\$96.73	\$583.60
24	-0240	\$107.44	\$258.66	\$125.18	\$105.36	\$589.20
36	-0360	\$108.94	\$272.74	\$143.72	\$113.99	\$594.80
48	-0480	\$110.44	\$286.82	\$162.26	\$122.62	\$600.40
60	-0600	\$111.94	\$300.90	\$180.80	\$131.25	\$600.06
72	-0720	\$113.44	\$314.98	\$199.34	\$139.88	\$603.68
Color Designators (add letter to the end of the part number and add \$1.00 to price)						
Black - B		Blue - L		Brown - N		Gray - A
Orange - O		Red - R		Violet - V		Yellow - Y
						Green - G
						White - W

See Page B5 for Cable Characteristics

* Contact Factory for delivery, Consider new RD316 for (RD188)

10% Discount @ 25 pcs. up

4% Discount @ 10 pcs. up

LC Male Plug x LC Male Plug

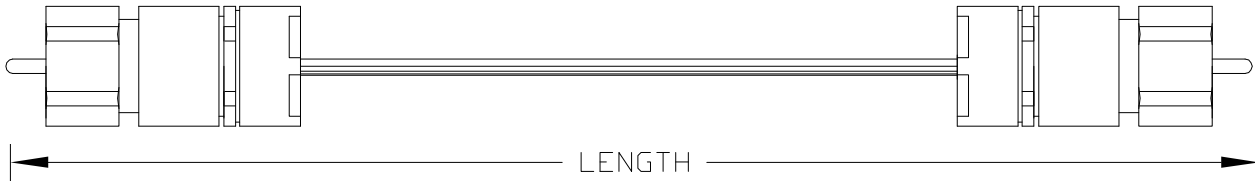

LENGTH IN INCHES	DASH NUMBER	50 Ω RG 213 ^{③③} 1 shield 213-LC0LC0-	50 Ω RG 214 ^{③①} 2 shields ^⑦ 214-LC0LC0-	50 Ω ^{③③} RG 217/U 2 shields 217-LC0LC0-	50 Ω ^{③③} RG 218 1 shield 218-LC0LC0-	50 Ω ^{①③} RG 226 2 shields 226-LC0LC0-
Solder Center, Clamp Outer						
12	-0120	\$298.87	\$300.79	\$263.50	\$304.08	①
18	-0180	\$299.66	\$302.54	\$264.25	\$311.12	①
24	-0240	\$300.45	\$304.29	\$265.00	\$318.16	①
30	-0300	\$301.24	\$306.04	\$265.75	\$325.20	①
36	-0360	\$302.03	\$307.79	\$266.50	\$332.24	①
42	-0420	\$302.82	\$309.54	\$267.25	\$339.28	①
48	-0480	\$303.61	\$311.29	\$268.00	\$346.32	①
54	-0540	\$304.40	\$313.04	\$268.75	\$353.36	①
60	-0600	\$305.19	\$314.79	\$269.50	\$360.40	①
66	-0660	\$305.98	\$316.54	\$270.25	\$367.44	①
72	-0720	\$306.77	\$318.29	\$271.00	\$374.48	①

LFU x LFU (mates with U.FL™)



LENGTH IN INCHES	DASH NUMBER	1.13MM 001-U4CU4C-	1.32MM 001-U4CU4C-
Solder Center,			
3	-0030	\$38.76	\$47.85
6	-0060	\$59.52	\$77.70
9	-0090	\$80.28	\$197.10
12	-0120	\$101.04	\$256.80
18	-0180	\$142.56	N/A
24	-0240	\$350.16	N/A
36	-0360	\$516.24	N/A
Color Designators (add letter to the end of the part number and add \$1.00 to price)			
Black - B	Blue - L	Brown - N	Gray - A
Orange - O	Red - R	Violet - V	Yellow - Y
			Green - G
			White - W

See Page B5 for Cable Characteristics

* Contact Factory for delivery, Consider new RD316 for (RD188) 10% Discount @ 25 pcs. up 4% Discount @ 10 pcs. up

LFU Cable Assemblies

The LFU connector is a right-angle plug with a female center contact, mates with U.FL™ connectors. U.FL™ is a registered trademark of Hirose Electrical Group. Connectors supplied may or may not be manufactured by Hirose.

LFU x SMA Bulkhead Jack

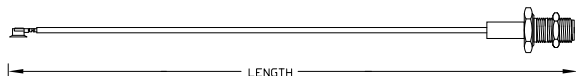

LFU x SMA Male Plug

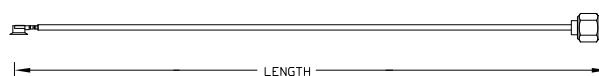

LTH IN INS	DASH NUM	1.13MM 001-U4CMF-	1.17MM 001-U4CMF-	1.32MM 001-U4CMF-	1.13MM 001-U4CMA-	1.17MM 001-U4CMA-	1.32MM 001-U4CMA-
Solder Center, Crimp Outer				Solder Center, Crimp Outer			
3	-0030	\$42.73	\$42.73	\$47.28	\$42.73	\$42.73	\$47.28
6	-0060	\$53.11	\$53.11	\$62.20	\$53.11	\$53.11	\$62.20
9	-0090	\$63.49	\$63.49	\$121.90	\$63.49	\$63.49	\$121.90
12	-0120	\$73.87	\$73.87	\$151.75	\$73.87	\$73.87	\$151.75
18	-0180	\$94.63	\$94.63	N/A	\$94.63	\$94.63	N/A
24	-0240	\$198.43	\$198.43	N/A	\$198.43	\$198.43	N/A
36	-0360	\$281.47	\$281.47	N/A	\$281.47	\$281.47	N/A

LFU x MCX Male Plug

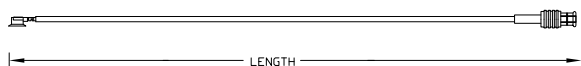

LFU x MMCX Male Plug

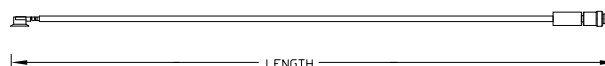

LTH IN INS	DASH NUM	1.13MM 001-U4CCXA-	1.17MM 001-U4CCXA-	1.32MM 001-U4CCXA-	1.13MM 001-U4CMCXA-	1.17MM 001-U4CMCXA-	1.32MM 001-U4CMCXA-
Solder Center, Crimp Outer				Solder Center, Crimp Outer			
3	-0030	\$33.00	\$33.00	\$37.55	\$33.56	CALL	\$38.11
6	-0060	\$43.38	\$43.38	\$52.47	\$43.94	CALL	\$53.03
9	-0090	\$53.76	\$53.76	\$112.17	\$54.32	CALL	\$112.73
12	-0120	\$64.14	\$64.14	\$142.02	\$64.70	CALL	\$142.58
18	-0180	\$84.90	\$84.90	N/A	\$85.46	CALL	N/A
24	-0240	\$188.70	\$188.70	N/A	\$189.26	CALL	N/A
36	-0360	\$271.74	\$271.74	N/A	\$272.30	CALL	N/A
Color Designators (add letter to the end of the part number and add \$1.00 to price)							
Black - B		Blue - L		Brown - N		Gray - A	
Orange - O		Red - R		Violet - V		Green - G	
						White - W	

See Page B5 for Cable Characteristics

* Contact Factory for delivery, Consider new RD316 for (RD188)

10% Discount @ 25 pcs. up

4% Discount @ 10 pcs. up

MCX Female Bulkhead Jack x MCX Male Plug

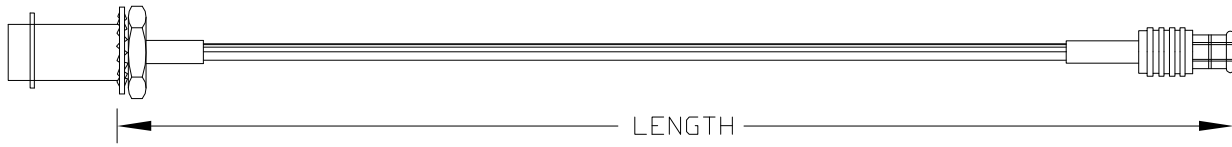

LTH IN INS	DASH NUMBER	50 Ω RG 174 ^⑤ 1 shield ^⑦ 174-CXFCXA-	50 Ω RG 316 ^{④②} 1 shield ^⑩ 316-CXFCXA-	50 Ω RD316 ^{④②⑦} 2 shields 31D-CXFCXA-	50 Ω RG188* ^{④②} 1 shield ^⑩ 188-CXFCXA-	50 Ω RG 178B/U ^② 1 shield ^⑩ 178-CXFCXA-	50 Ω RG 196 ^② 1 shield ^⑩ 196-CXFCXA-
Solder Center, Crimp Outer							
12	-0120	\$21.97	\$22.38	\$21.13	\$22.73	\$22.14	\$22.14
18	-0180	\$22.09	\$22.71	\$22.06	\$23.23	\$22.51	\$22.51
24	-0240	\$22.21	\$23.03	\$22.98	\$23.73	\$22.88	\$22.88
30	-0300	\$22.33	\$23.36	\$23.91	\$24.23	\$23.25	\$23.25
36	-0360	\$22.45	\$23.68	\$24.83	\$24.73	\$23.62	\$23.62
42	-0420	\$22.57	\$24.01	\$25.76	\$25.23	\$23.99	\$23.99
48	-0480	\$22.69	\$24.33	\$26.68	\$25.73	\$24.36	\$24.36
54	-0540	\$22.81	\$24.66	\$27.61	\$26.23	\$24.73	\$24.73
60	-0600	\$22.93	\$24.98	\$28.53	\$26.73	\$25.10	\$25.10
66	-0660	\$23.05	\$25.31	\$29.46	\$27.23	\$25.47	\$25.47
72	-0720	\$23.17	\$25.63	\$30.38	\$27.73	\$25.84	\$25.84
.141/.085" Diameter SEMIRIGID and Maxi Flex. Direct Solder Connectors							
LTH IN INS	DASH NUM	50Ω RG 402 M17/130-00005 ^② .141 Tin Pl Cu 1TS-CXFCXA-	50ΩMaxiFlex (No QPL List) ^② .141 Tin Pl 14F-CXFCXA-	50Ω RG 405 ^② M17/133-00007 .085 Tin Pl Cu 405-CXFCXA-	50Ω RG 405 ^② M17/133-00007 .085 Tin Pl Cu 8TS-CXFCXA-	50ΩMaxiFlex (No QPL List) ^② .085 Tin Pl 08F-CXFCXA-	50Ω RG 405 ^② M17/133-00016 .085 Silver Pl 8SS-CXFCXA-
12	-0120	\$39.76	\$39.40	\$23.90	\$23.90	\$25.13	\$29.09
18	-0180	\$41.56	\$41.02	\$25.41	\$25.41	\$27.26	\$33.20
24	-0240	\$43.36	\$42.64	\$26.92	\$26.92	\$29.38	\$37.30
30	-0300	\$45.16	\$44.26	\$28.43	\$28.43	\$31.51	\$41.41
36	-0360	\$46.96	\$45.88	\$29.94	\$29.94	\$33.63	\$45.51
42	-0420	\$48.76	\$47.50	\$31.45	\$31.45	\$35.76	\$49.62
48	-0480	\$50.56	\$49.12	\$32.96	\$32.96	\$37.88	\$53.72
54	-0540	\$52.36	\$50.74	\$34.47	\$34.47	\$40.01	\$57.83
60	-0600	\$54.16	\$52.36	\$35.98	\$35.98	\$42.13	\$61.93
66	-0660	\$55.96	\$53.98	\$37.49	\$37.49	\$44.26	CALL
72	-0720	\$57.76	\$55.60	\$39.00	\$39.00	\$46.38	CALL
Color Designators (add letter to the end of the part number and add \$1.00 to price)							
Black - B		Blue - L		Brown - N		Gray - A	
Orange - O		Red - R		Violet - V		Green - G	
						White - W	

See Page B5 for Cable Characteristics

* Contact Factory for delivery, Consider new RD316 for (RD188) 10% Discount @ 25 pcs. up 4% Discount @ 10 pcs. up

①Silver Plated Copper Center Conductor ②Silver Plated Copper Clad Steel Center Conductor



RF Depot.com Inc.

Phone 856-488-2000 Fax 856-488-2020

MCX Male Plug x MCX Male Plug

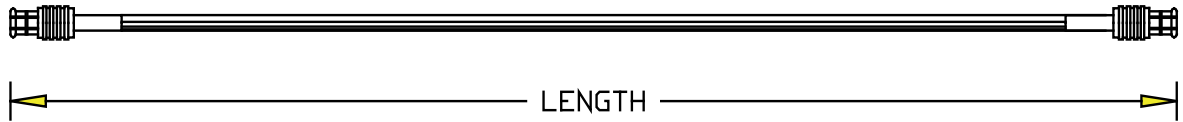

LTH IN INS	DASH NUM	50 Ω RG 174 ^{③⑤} 1 shield ^⑦ 174-CXACXA-	50 Ω RG 316 ^{④②} 1 shield ^⑧ 316-CXACXA-	50 Ω ^④ RD316 ^{②⑦} 2 shields 31D-CXACXA-	50 Ω RG188* ^{①②} 1 shield ^⑧ 188-CXACXA-	50 Ω ^② RG 178B/U 1 shield ^⑧ 178-CXACXA-	50 Ω RG 196 ^② 1 shield ^⑧ 196-CXACXA-	50 Ω ^{⑤⑨} SIG 100 ^⑩ 2 shields 1LC-CXACXA-
Solder Center, Crimp Outer								
12	-0120	\$22.12	\$22.53	\$18.83	\$22.88	\$18.46	\$18.46	\$22.42
24	-0240	\$22.36	\$23.18	\$20.68	\$23.88	\$19.20	\$19.20	\$22.96
36	-0360	\$22.60	\$23.83	\$22.53	\$24.88	\$19.94	\$19.94	\$23.50
48	-0480	\$22.84	\$24.48	\$24.38	\$25.88	\$20.68	\$20.68	\$24.04
60	-0600	\$23.08	\$25.13	\$26.23	\$26.88	\$21.42	\$21.42	\$24.58
72	-0720	\$23.32	\$25.78	\$28.08	\$27.88	\$22.16	\$22.16	\$25.12
Solder Center, Crimp Outer								
LTH IN INS	DASH NUM	50 Ω ^{⑤⑨} LMR 100 ^⑩ 2 shields 1LM-CXACXA-	50 Ω ^③ SIG 195 ^⑩ 2 shields ^⑨ 19C-CXACXA-	50 Ω ^③ LMR 195 ^⑩ 2 shields ^⑨ 19M-CXACXA-	50 Ω ^{③⑥⑦} RG 58C 1 shield 058-CXACXA-	50 Ω ^{③⑦} RG 223 ^⑩ 2 shields 223-CXACXA-	50 Ω ^{④⑦} RG142B 2 shields 142-CXACXA-	50 Ω ^① RG 400* ^④ 2 shields ^⑦ 400-CXACXA-
12	-0120	\$22.54	\$21.95	\$22.04	\$21.78	\$22.85	\$23.68	\$24.38
24	-0240	\$23.20	\$22.52	\$22.70	\$22.18	\$24.32	\$25.98	\$27.38
36	-0360	\$23.86	\$23.09	\$23.36	\$22.58	\$25.79	\$28.28	\$30.38
48	-0480	\$24.52	\$23.66	\$24.02	\$22.98	\$27.26	\$30.58	\$33.38
60	-0600	\$25.18	\$24.23	\$24.68	\$23.38	\$28.73	\$32.88	\$36.38
72	-0720	\$25.84	\$24.80	\$25.34	\$23.78	\$30.20	\$35.18	\$39.38
.085"/.047" Diameter SEMIRIGID and Maxi Flex. Direct Solder Connectors								
LTH IN INS	DASH NUM	50Ω ^② MaxiFlex (No QPL List) .085 Tin Pl 08F-CXACXA-	50Ω RG 405 ^② M17/133-00007 .085 Tin Plate Cu 8TS-CXACXA-	50Ω ^② M17/151-00001 .047 Cu Jacket 4CU-CXACXA-	50Ω ^② M17/151-00002 .047 Tin Plate Cu 4TS-CXACXA-	50ΩMaxiFlex ^② (No QPL List) .047 Tin Pl 04F-CXACXA-	50Ω ^② M17/154-00002 .034 Tin Plate Cu 3TS-CXACXA-	
12	-0120	\$21.67	\$20.44	\$27.12	\$27.12	\$27.82	\$61.93	
24	-0240	\$25.92	\$23.46	\$30.92	\$30.82	\$32.32	\$70.04	
36	-0360	\$30.17	\$26.48	\$34.72	\$34.72	\$36.82	\$78.15	
48	-0480	\$34.42	\$29.50	\$38.52	\$38.52	\$41.32	\$86.26	
60	-0600	\$38.67	\$32.52	\$42.32	\$42.32	\$45.82	\$94.37	
72	-0720	\$42.92	\$35.54	\$46.12	\$46.12	\$50.32	\$102.48	
Color Designators (add letter to the end of the part number and add \$1.00 to price)								
Black - B		Blue - L		Brown - N		Gray - A		Green - G
Orange - O		Red - R		Violet - V		Yellow - Y		White - W

See Page B5 for Cable Characteristics

10% Discount @ 25 pcs. up 4% Discount @ 10 pcs. up

①Silver Plated Copper Center Conductor ②Silver Plated Copper Clad Steel Center Conductor

MCX Male Plug x MCX Right Angle Male Plug

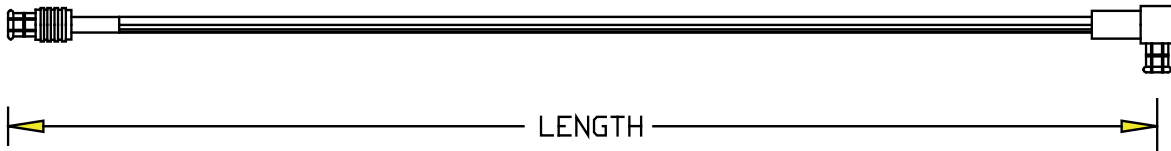

LTH IN INCHES	DASH NUM	50 Ω RG 174 [Ⓢ] 1 shield [Ⓢ] 174-CXACXC-	50 Ω RG 316 [Ⓢ] 1 shield [Ⓢ] 316-CXACXC-	50 Ω RD316 [Ⓢ] 2 shields 31D-CXACXC-	50 Ω RG188* [Ⓢ] 1 shield [Ⓢ] 188-CXACXC-	50 Ω RG 178B/U [Ⓢ] 1 shield [Ⓢ] 178-CXACXC-	50 Ω RG 196 [Ⓢ] 1 shield [Ⓢ] 196-CXACXC-
Solder Center, Crimp Outer							
12	-0120	\$22.48	\$22.89	\$18.96	\$23.24	\$21.41	\$21.63
18	-0180	\$22.60	\$23.22	\$19.89	\$23.74	\$21.78	\$22.11
24	-0240	\$22.72	\$23.54	\$20.81	\$24.24	\$22.15	\$22.59
30	-0300	\$22.84	\$23.87	\$21.74	\$24.74	\$22.52	\$23.07
36	-0360	\$22.96	\$24.19	\$22.66	\$25.24	\$22.89	\$23.55
42	-0420	\$23.08	\$24.52	\$23.59	\$25.74	\$23.26	\$24.03
48	-0480	\$23.20	\$24.84	\$24.51	\$26.24	\$23.63	\$24.51
54	-0540	\$23.32	\$25.17	\$25.44	\$26.74	\$24.00	\$24.99
60	-0600	\$23.44	\$25.49	\$26.36	\$27.24	\$24.37	\$25.47
66	-0660	\$23.56	\$25.82	\$27.29	\$27.74	\$24.74	\$25.95
72	-0720	\$23.68	\$26.14	\$28.21	\$28.24	\$25.11	\$26.43

.141"/.085" Diameter SEMIRIGID and Maxi Flex. Direct Solder Connectors

LTH IN INS	DASH NUM	50Ω RG 402 [Ⓢ] M17/130-00004 .141 Cu Jacket 402-CXACXC-	50Ω RG 402 [Ⓢ] M17/130-00005 .141 Tin Plate Cu 1TS-CXACXC-	50Ω MaxiFlex (No QPL List) [Ⓢ] .141 Tin Pl 14F-CXACXC-	50Ω RG 405 [Ⓢ] M17/133-00007 .085 Tin Plate Cu 405-CXACXC-	50Ω RG 405 [Ⓢ] M17/133-00007 .085 Tin Plate Cu 8TS-CXACXC-	50Ω [Ⓢ] M17/151-00002 .047 Tin Plate Cu 4TS-CXACXC-	50Ω MaxiFlex [Ⓢ] (No QPL List) .047 Tin Pl 04F-CXACXC-
12	-0120	\$28.38	\$28.02	\$28.02	\$20.58	\$20.58	\$27.15	\$27.85
18	-0180	\$30.18	\$29.64	\$29.64	\$22.09	\$22.09	\$29.05	\$30.10
24	-0240	\$31.98	\$31.26	\$31.26	\$23.60	\$23.60	\$30.95	\$32.35
30	-0300	\$33.78	\$32.88	\$32.88	\$25.11	\$25.11	\$32.85	\$34.60
36	-0360	\$35.58	\$34.50	\$34.50	\$26.62	\$26.62	\$34.75	\$36.85
42	-0420	\$37.38	\$36.12	\$36.12	\$28.13	\$28.13	\$36.65	\$39.10
48	-0480	\$39.18	\$37.74	\$37.74	\$29.64	\$29.64	\$38.55	\$41.35
54	-0540	\$40.98	\$39.36	\$39.36	\$31.15	\$31.15	\$40.45	\$43.60
60	-0600	\$42.78	\$40.98	\$40.98	\$32.66	\$32.66	\$42.35	\$45.85
66	-0660	\$44.58	\$42.60	\$42.60	\$34.17	\$34.17	\$44.25	\$48.10
72	-0720	\$46.38	\$44.22	\$44.22	\$35.68	\$35.68	\$46.15	\$50.35

Color Designators (add letter to the end of the part number and add \$1.00 to price)

Black - B	Blue - L	Brown - N	Gray - A	Green - G
Orange - O	Red - R	Violet - V	Yellow - Y	White - W

See Page B5 for Cable Characteristics

* Contact Factory for delivery, Consider new RD316 for (RD188) 10% Discount @ 25 pcs. up 4% Discount @ 10 pcs. up

① Silver Plated Copper Center Conductor ② Silver Plated Copper Clad Steel Center Conductor



RF Depot.com Inc.

Phone 856-488-2000 Fax 856-488-2020

MCX Male Plug x SMA Male Plug

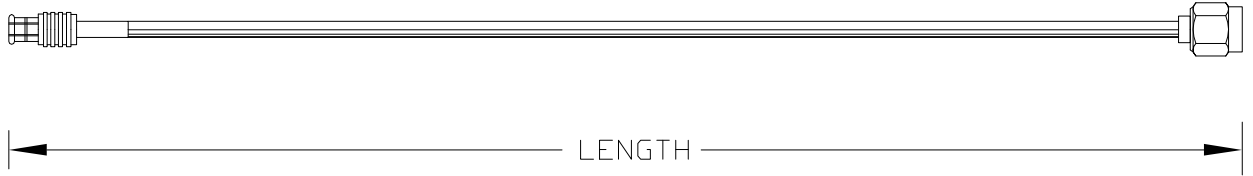

LENGTH IN INCHES	DASH NUMBER	50 Ω RG 174 ^{③⑤} 1 shield ^⑦ 174-CXAMA-	50 Ω RG 316 ^{④②} 1 shield ^⑧ 316-CXAMA-	50 Ω ^④ RD316 ^{②⑦} 2 shields 31D-CXAMA-	50 Ω RG188* ^{④②} 1 shield ^⑧ 188-CXAMA-	50 Ω RG 178B/U ^② 1 shield ^⑧ 178-CXAMA-	50 Ω RG 196 ^② 1 shield ^⑧ 196-CXAMA-	50 Ω ^{⑤⑧} SIG 100 ^⑧ 2 shields 1LC-CXAMA-
Solder Center, Crimp Outer								
12	-0120	\$22.76	\$23.17	\$21.92	\$23.52	\$27.59	\$27.59	\$23.06
24	-0240	\$23.00	\$23.82	\$23.77	\$24.52	\$28.33	\$28.33	\$23.60
36	-0360	\$23.24	\$24.47	\$25.62	\$25.52	\$29.07	\$29.07	\$24.14
48	-0480	\$23.48	\$25.12	\$27.47	\$26.52	\$29.81	\$29.81	\$24.68
60	-0600	\$23.72	\$25.77	\$29.32	\$27.52	\$30.55	\$30.55	\$25.22
72	-0720	\$23.96	\$26.42	\$31.17	\$28.52	\$31.29	\$31.29	\$25.76
Solder Center, Crimp Outer								
LENGTH IN INCHES	DASH NUMBER	50 Ω ^{③⑥⑦} RG 58C 1 shield 058-CXAMA-	50 Ω ^{③⑦} RG 223 ^① 2 shields 223-CXAMA-	50 Ω ^{④⑦} RG142B 2 shields 142-CXAMA-	50 Ω ^{①⑦} RG 400* ^④ 2 shields 400-CXAMA-	50 Ω ^{⑤⑧} LMR 100 ^⑧ 2 shields 1LM-CXAMA-	50 Ω ^③ SIG 195 ^⑧ 2 shields ^⑧ 19C-CXAMA-	50 Ω ^③ LMR 195 ^⑧ 2 shields ^⑧ 19M-CXAMA-
12	-0120	\$24.62	\$26.98	\$27.81	\$28.51	\$23.18	\$24.79	\$24.93
24	-0240	\$25.02	\$28.45	\$30.11	\$31.51	\$23.84	\$25.36	\$25.64
36	-0360	\$25.42	\$29.92	\$32.41	\$34.51	\$24.50	\$25.93	\$26.35
48	-0480	\$25.82	\$31.39	\$34.71	\$37.51	\$25.16	\$26.50	\$27.06
60	-0600	\$26.22	\$32.86	\$37.01	\$40.51	\$25.82	\$27.07	\$27.77
72	-0720	\$26.62	\$34.33	\$39.31	\$43.51	\$26.48	\$27.64	\$28.48
.047/.141/.085/.034" Diameter SEMIRIGID and Maxi Flex. Direct Solder Connectors								
LTH IN INS	DASH NUM	50Ω ^② M17/151-00002 .047 Tin Pl Cu 4TS-CXAMA-	50Ω ^② MaxiFlex (No QPL List) .047 Tin Pl 04F-CXAMA-	50Ω RG 402 ^② M17/130-00005 .141 Tin Pl Cu 1TS-CXAMA-	50Ω MaxiFlex (No QPL List) ^② .141 Tin Pl 14F-CXAMA-	50Ω RG 405 ^② M17/133-00007 .085 Tin Pl Cu 8TS-CXAMA-	50Ω ^② MaxiFlex (No QPL List) .085 Tin Pl 08F-CXAMA-	50Ω ^② M17/154-00002 .034 Tin Pl Cu 3TS-CXAMA-
12	-0120	\$25.86	\$26.56	\$22.83	\$22.83	\$22.10	\$23.33	\$80.01
24	-0240	\$29.66	\$29.66	\$26.07	\$26.07	\$25.12	\$27.58	\$88.00
36	-0360	\$33.46	\$33.46	\$29.31	\$29.31	\$28.14	\$31.83	\$96.20
48	-0480	\$37.26	\$37.26	\$32.55	\$32.55	\$31.16	\$36.08	\$104.00
60	-0600	\$41.06	\$41.06	\$35.79	\$35.79	\$34.18	\$40.33	\$112.00
72	-0720	\$44.86	\$44.86	\$39.03	\$39.03	\$37.20	\$44.58	\$120.00
Color Designators (add letter to the end of the part number and add \$1.00 to price)								
Black - B		Blue - L		Brown - N		Gray - A		Green - G
Orange - O		Red - R		Violet - V		Yellow - Y		White - W

See Page B5 for Cable Characteristics

* Contact Factory for delivery, Consider new RD316 for (RD188) 10% Discount @ 25 pcs. up 4% Discount @ 10 pcs. up

①Silver Plated Copper Center Conductor ②Silver Plated Copper Clad Steel Center Conductor



RF Depot.com Inc.

Phone 856-488-2000 Fax 856-488-2020

7850 Browning Rd. Pennsauken, NJ 08109

Online @ www.rfdepot.com

Toll Free 877-RF Depot

B55

MCX Male Plug x TNC 4 Hole Panel Jack

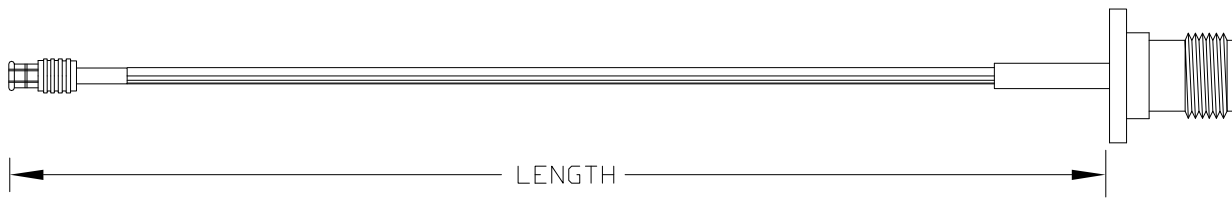

LENGTH IN INCHES	DASH NUMBER	50 Ω ^{①②③} RG 58C 1 shield 058-CXATJ-	50 Ω ^{①②} RG 223 ^① 2 shields 223-CXATJ-	50 Ω RG 174 ^{③⑤} 1 shield ^⑦ 174-CXATJ-	50 Ω RG 316 ^{④②} 1 shield ^⑥ 316-CXATJ-	50 Ω RD316 ^{④②⑦} 2 shields 31D-CXATJ-	50 Ω RG188* ^{④②} 1 shield ^⑥ 188-CXATJ-
------------------	-------------	--	---	---	---	---	---

Solder Center, Crimp Outer

12	-0120C	\$22.70	\$23.97	\$22.74	\$23.15	\$24.35	\$23.50
24	-0240C	\$23.10	\$25.44	\$22.98	\$23.80	\$26.20	\$24.50
36	-0360C	\$23.50	\$26.91	\$23.22	\$24.45	\$28.05	\$25.50
48	-0480C	\$23.90	\$29.38	\$23.46	\$25.10	\$29.90	\$26.50
60	-0600C	\$24.30	\$29.85	\$23.70	\$25.75	\$31.75	\$27.50
72	-0720C	\$24.70	\$31.32	\$23.94	\$26.40	\$33.60	\$28.50

.141/.085" Diameter SEMIRIGID and Maxi Flex. Direct Solder Brass TNC Connectors

LENGTH IN INCHES	DASH NUMBER	50Ω RG 402 ^② M17/130-00004 .141 Cu Jacket 402-CXATJ-	50Ω RG 402 ^② M17/130-00005 .141 Tin Plate Cu 1TS-CXATJ-	50Ω MaxiFlex (No QPL List) ^② .141 Tin Pl 14F-CXATJ-	50Ω RG 402 ^① M17/130-00009 .141 Tin Plate Al 1AT-CXATJ-	50Ω RG 402 ^② M17/130-00012 .141 Silver Pl 1SS-CXATJ-
12	-0120C	\$26.26	\$25.90	\$25.90	\$26.26	\$35.47
24	-0240C	\$29.86	\$29.14	\$29.14	\$29.86	\$48.28
36	-0360C	\$33.46	\$32.38	\$32.38	\$33.46	\$61.09
48	-0480C	\$37.06	\$35.62	\$35.62	\$37.06	\$73.90
60	-0600C	\$40.66	\$38.86	\$38.86	\$40.66	\$86.71
72	-0720C	\$44.26	\$42.10	\$42.10	\$44.26	\$99.52

.141/.085" Diameter SEMIRIGID and Maxi Flex. Direct Solder Connectors

LTH IN INS	DASH NUM	50Ω RG 405 ^② M17/133-00007 .085 Tin Pl Cu 405-CXATJ-	50Ω RG 405 ^② M17/133-00007 .085 Tin Pl Cu 8TS-CXATJ-	50Ω RG 405 ^② M17/133-00013 .085 Tin Pl Al 8AT-CXATJ-	50Ω MaxiFlex (No QPL List) .085 Tin Pl 08F-CXATJ-	50Ω RG 405 ^② M17/133-00007 .085 Tin Pl Cu 8TS-CXATJ-	50Ω ^② MaxiFlex (No QPL List) .085 Tin Pl 08F-CXATJ-
12	-0120	\$22.84	\$22.84	\$23.78	\$24.07	\$25.68	\$26.91
24	-0240	\$25.86	\$25.86	\$27.74	\$28.32	\$28.70	\$31.16
36	-0360	\$28.88	\$28.88	\$31.70	\$32.57	\$31.72	\$35.41
48	-0480	\$31.90	\$31.90	\$35.66	\$36.82	\$34.74	\$39.66
60	-0600	\$34.92	\$34.92	\$39.62	\$41.07	\$37.76	\$43.91
72	-0720	\$37.94	\$37.94	CALL	\$45.32	\$40.78	\$48.16

Color Designators (add letter to the end of the part number and add \$1.00 to price)

Black - B	Blue - L	Brown - N	Gray - A	Green - G
Orange - O	Red - R	Violet - V	Yellow - Y	White - W

See Page B5 for Cable Characteristics

* Contact Factory for delivery, Consider new RD316 for (RD188) 10% Discount @ 25 pcs. up 4% Discount @ 10 pcs. up

① Silver Plated Copper Center Conductor ② Silver Plated Copper Clad Steel Center Conductor



RF Depot.com Inc.

Phone 856-488-2000 Fax 856-488-2020

MCX Right Angle Male Plug x MCX Right Angle Male Plug



LTH IN INS	DASH NUM	50 Ω RG 174 [Ⓢ] 1 shield [Ⓢ] 174-CXCCXC-	50 Ω RG 316 [Ⓢ] 1 shield [Ⓢ] 316-CXCCXC-	50 Ω RD316 [Ⓢ] 2 shields 31D-CXCCXC-	50 Ω RG188* [Ⓢ] 1 shield [Ⓢ] 188-CXCCXC-	50 Ω RG 178B/U [Ⓢ] 1 shield [Ⓢ] 178-CXCCXC-	50 Ω RG 196 [Ⓢ] 1 shield [Ⓢ] 196-CXCCXC-		
Solder Center, Crimp Outer									
12	-0120	\$34.14	\$34.64	\$27.32	\$34.90	\$36.17	\$36.17		
18	-0180	\$34.26	\$35.01	\$28.25	\$35.40	\$36.54	\$36.54		
24	-0240	\$34.38	\$35.38	\$29.17	\$35.90	\$36.91	\$36.91		
30	-0300	\$34.50	\$35.75	\$30.10	\$36.40	\$37.28	\$37.28		
36	-0360	\$34.62	\$36.12	\$31.02	\$36.90	\$37.65	\$37.65		
42	-0420	\$34.74	\$36.49	\$31.95	\$37.40	\$38.02	\$38.02		
48	-0480	\$34.86	\$36.86	\$32.87	\$37.90	\$38.39	\$38.39		
54	-0540	\$34.98	\$37.23	\$33.80	\$38.40	\$38.76	\$38.76		
60	-0600	\$35.10	\$37.60	\$34.72	\$38.90	\$39.13	\$39.13		
66	-0660	\$35.22	\$37.97	\$35.65	\$39.40	\$39.50	\$39.50		
72	-0720	\$35.34	\$38.34	\$36.57	\$39.90	\$39.87	\$39.87		
.141"/.085"/.047" Diameter SEMIRIGID and Maxi Flex. Direct Solder Connectors									
LTH IN INS	DASH NUM	50Ω RG 402 [Ⓢ] M17/130-00005 .141 Tin Plate Cu 1TS-CXCCXC-	50Ω MaxiFlex [Ⓢ] (No QPL List) .141 Tin Pl 14F-CXCCXC-	50Ω [Ⓢ] MaxiFlex (No QPL List) .085 Tin Pl 08F-CXCCXC-	50Ω RG 405 [Ⓢ] M17/133-00013 .085 Tin Plate Al 8AT-CXCCXC-	50Ω RG 405 [Ⓢ] M17/133-00016 .085 Silver Pl 8SS-CXCCXC-	50Ω [Ⓢ] MaxiFlex (No QPL List) .047 Tin Pl 04F-CXCCXC-	50Ω (No QPL List) .047 Tin Plate Al 4AT-CXCCXC-	
12	-0120	\$42.60	\$42.60	\$30.80	\$30.51	\$34.76	\$39.57	\$40.32	
18	-0180	\$44.22	\$44.22	\$32.93	\$32.49	\$38.87	\$41.82	\$42.95	
24	-0240	\$45.84	\$45.84	\$35.05	\$34.47	\$42.97	\$44.07	\$45.57	
30	-0300	\$47.46	\$47.46	\$37.18	\$36.45	\$47.08	\$46.32	\$48.20	
36	-0360	\$49.08	\$49.08	\$39.30	\$38.43	\$51.18	\$48.57	\$50.82	
42	-0420	\$50.70	\$50.70	\$41.43	\$40.41	\$55.29	\$50.82	\$53.45	
48	-0480	\$52.32	\$52.32	\$43.55	\$42.39	\$59.39	\$53.07	\$56.07	
54	-0540	\$53.94	\$53.94	\$45.68	\$44.37	\$63.50	\$55.32	\$58.70	
60	-0600	\$55.56	\$55.56	\$47.80	\$46.35	\$67.60	\$57.57	\$61.32	
66	-0660	\$57.18	\$57.18	\$49.93	CALL	CALL	\$59.82	\$63.95	
72	-0720	\$58.80	\$58.80	\$52.05	CALL	CALL	\$62.07	\$66.57	
Color Designators (add letter to the end of the part number and add \$1.00 to price)									
Black - B		Blue - L		Brown - N		Gray - A		Green - G	
Orange - O		Red - R		Violet - V		Yellow - Y		White - W	

See Page B5 for Cable Characteristics

* Contact Factory for delivery, Consider new RD316 for (RD188) 10% Discount @ 25 pcs. up 4% Discount @ 10 pcs. up

Ⓢ Silver Plated Copper Center Conductor Ⓢ Silver Plated Copper Clad Steel Center Conductor



RF Depot.com Inc.

Phone 856-488-2000 Fax 856-488-2020

7850 Browning Rd. Pennsauken, NJ 08109

Online @ www.rfdepot.com

Toll Free 877-RF Depot

MHV Male Plug x MHV Male Plug



LTH IN INS	DASH NUM	50 Ω ^{⑥⑦} RG 58C 1 shield 058-MHAMHA-	50 Ω ^{⑥⑦} RG 223 ^① 2 shields 223-MHAMHA-	50 Ω ^{④⑦} RG142B 2 shields 142-MHAMHA-	50 Ω ^{④①⑦} RG 400* 2 shields 400-MHAMHA-	50 Ω RG 8* ^{③⑧} 1 shield 008-MHAMHA-	50 Ω ^② RG 141A 2 shields ^② 141-MHAMHA-
Solder Center, Crimp Outer							
12	-0120	\$62.40	\$63.87	\$64.70	\$65.40	\$57.40	\$63.48
18	-0180	\$62.60	\$64.61	\$65.85	\$66.90	\$58.10	\$64.22
24	-0240	\$62.80	\$65.34	\$67.00	\$68.40	\$58.80	\$64.96
30	-0300	\$63.00	\$66.08	\$68.15	\$69.90	\$59.50	\$65.70
36	-0360	\$63.20	\$66.81	\$69.30	\$71.40	\$60.20	\$66.44
42	-0420	\$63.40	\$67.55	\$70.45	\$72.90	\$60.90	\$67.18
48	-0480	\$63.60	\$68.28	\$71.60	\$74.40	\$61.60	\$67.92
54	-0540	\$63.80	\$69.02	\$72.75	\$75.90	\$62.30	\$68.66
60	-0600	\$64.00	\$69.75	\$73.90	\$77.40	\$63.00	\$69.40
66	-0660	\$64.20	\$70.49	\$75.05	\$78.90	\$63.70	\$70.14
72	-0720	\$64.40	\$71.22	\$76.20	\$80.40	\$64.40	\$70.88
Solder Center, Crimp Outer							
LTH IN INS	DASH NUM	50 Ω RG 213 ^{③⑧} 1 shield 213-MHAMHA-	50 Ω RG 214 ^{④①} 2 shields ^⑦ 214-MHAMHA-	50 Ω ^{①⑦} RG 225 2 shield 225-MHAMHA-	75 Ω ^{⑤⑧} RG 59B ^③ 1 shield 059-MHAMHA-	93 Ω ^{⑤⑧} RG 62 ^③ 1 shield 062-MHAMHA-	50 Ω RG 393 ^{④①⑦} 2 shields 393-MHAMHA-
12	-0120	\$57.58	\$59.50	\$74.54	\$65.60	\$65.86	\$74.54
18	-0180	\$58.37	\$61.25	\$83.81	\$65.82	\$66.21	\$83.81
24	-0240	\$59.16	\$63.00	\$93.08	\$66.04	\$66.56	\$93.08
30	-0300	\$59.95	\$64.75	\$102.35	\$66.26	\$66.91	\$102.35
36	-0360	\$60.74	\$66.50	\$111.62	\$66.48	\$67.26	\$111.62
42	-0420	\$61.53	\$68.25	\$120.89	\$66.70	\$67.61	\$120.89
48	-0480	\$62.32	\$70.00	\$130.16	\$66.92	\$67.96	\$130.16
54	-0540	\$63.11	\$71.75	\$139.43	\$67.14	\$68.31	\$139.43
60	-0600	\$63.90	\$73.50	\$148.70	\$67.36	\$68.66	\$148.70
66	-0660	\$64.69	\$75.25	\$157.97	\$67.58	\$69.01	\$157.97
72	-0720	\$65.48	\$77.00	\$167.24	\$67.80	\$69.36	\$167.24
Color Designators (add letter to the end of the part number and add \$1.00 to price)							
Black - B		Blue - L		Brown - N		Gray - A	
Orange - O		Red - R		Violet - V		Green - G	
						White - W	

See Page B5 for Cable Characteristics

* Contact Factory for delivery, Consider new RD316 for (RD188) 10% Discount @ 25 pcs. up 4% Discount @ 10 pcs. up



RF Depot.com Inc.

Phone 856-488-2000 Fax 856-488-2020

MHV Male Plug x SHV Male Plug



LTH IN INS	DASH NUM	50 Ω ①②③④ RG 58C 1 shield 058-MHASHA-	50 Ω ①②③④ RG 223① 2 shields 223-MHASHA-	50 Ω ①②③④ RG142B 2 shields 142-MHASHA-	50 Ω ①②③④ RG 400* 2 shields 400-MHASHA-	50 Ω ② RG 141A 1 shield① 141-MHASHA-	75 Ω ⑤⑥ RG 59B② 1 shield 059-MHASHA-	93 Ω ⑤⑥ RG 62③ 1 shield 062-MHASHA-
Solder Center, Crimp Outer								
12	-0120	\$60.90	\$60.67	\$61.50	\$62.20	\$61.98	\$61.79	\$62.05
24	-0240	\$61.30	\$62.14	\$63.80	\$65.20	\$63.46	\$62.23	\$62.75
36	-0360	\$61.70	\$63.61	\$66.10	\$68.20	\$64.94	\$62.67	\$63.45
48	-0480	\$62.10	\$65.08	\$68.40	\$71.20	\$66.42	\$63.11	\$64.15
60	-0600	\$62.50	\$66.55	\$70.70	\$74.20	\$67.90	\$63.55	\$64.85
72	-0720	\$62.90	\$68.02	\$73.00	\$77.20	\$69.38	\$63.99	\$65.55
Solder Center, Clamp Outer								
LTH IN INS	DASH NUM	50 Ω ①②③④ RG 58C 1 shield 058-MH0SHO-	50 Ω ①②③④ RG 223① 2 shields 223-MH0SHO-	50 Ω ①②③④ RG142B 2 shields 142-MH0SHO-	50 Ω ①②③④ RG 400* 2 shields 400-MH0SHO-	50 Ω ② RG 141A 1 shield① 141-MH0SHO-	75 Ω ⑤⑥ RG 59B② 1 shield 059-MH0SHO-	93 Ω ⑤⑥ RG 62③ 1 shield 062-MH0SHO-
12	-0120	\$60.90	\$62.37	\$63.20	\$63.90	\$61.98	\$61.79	\$62.05
24	-0240	\$61.30	\$63.84	\$65.50	\$66.90	\$63.46	\$62.23	\$62.75
36	-0360	\$61.70	\$65.31	\$67.80	\$69.90	\$64.94	\$62.67	\$63.45
48	-0480	\$62.10	\$66.78	\$70.10	\$72.90	\$66.42	\$63.11	\$64.15
60	-0600	\$62.50	\$68.25	\$72.40	\$75.90	\$67.90	\$63.55	\$64.85
72	-0720	\$62.90	\$69.72	\$74.70	\$78.90	\$69.38	\$63.99	\$65.55
Solder Center, Crimp Outer								
LENGTH IN INCHES	DASH NUMBER	50 Ω RG 8* ③③③ 1 shield 008-MHASHA-	50 Ω RG 213③③③ 1 shield 213-MHASHA-	50 Ω RG 214③① 2 shields⑦ 214-MHASHA-	50 Ω ①②③ RG 225 2 shield 225-MHASHA-	50 Ω RG 393④①⑦ 2 shields 393-MHASHA-		
12	-0120	\$73.00	\$73.18	\$75.10	\$90.14	\$103.94		
24	-0240	\$74.40	\$74.76	\$78.60	\$108.68	\$112.57		
36	-0360	\$75.80	\$76.34	\$82.10	\$127.22	\$121.20		
48	-0480	\$77.20	\$77.92	\$85.60	\$145.76	\$129.83		
60	-0600	\$78.60	\$79.50	\$89.10	\$164.30	\$138.46		
72	-0720	\$80.00	\$81.08	\$92.60	\$182.84	\$147.09		
Color Designators (add letter to the end of the part number and add \$1.00 to price)								
Black - B		Blue - L		Brown - N		Gray - A		Green - G
Orange - O		Red - R		Violet - V		Yellow - Y		White - W

See Page B5 for Cable Characteristics

* Contact Factory for delivery, Consider new RD316 for (RD188)

10% Discount @ 25 pcs. up

4% Discount @ 10 pcs. up

Mini-UHF Female Jack x Mini-UHF Male Plug



LENGTH IN INCHES	DASH NUMBER	50 Ω ^{⑤⑥⑦} RG 58C 1 shield 058-MUAMUB-	50 Ω ^{⑥⑦} RG 223 ^① 2 shields 223-MUAMUB-	50 Ω ^{④⑦} RG142B 2 shields 142-MUAMUB-	50 Ω ^{④①⑦} RG 400* 2 shields 400-MUAMUB-	75 Ω ^{⑤⑧} RG 59B ^② 1 shield 059-MUAMUB-	93 Ω ^{⑤⑧} RG 62 ^② 1 shield 062-MUAMUB-		
Solder Center, Crimp Outer									
12	-0120	\$23.13	\$24.40	\$25.23	\$25.93	\$23.09	\$23.35		
24	-0240	\$23.53	\$25.87	\$27.53	\$28.93	\$23.53	\$24.05		
36	-0360	\$23.93	\$27.34	\$29.83	\$31.93	\$23.97	\$24.75		
48	-0480	\$24.33	\$28.81	\$32.13	\$34.93	\$24.41	\$25.45		
60	-0600	\$24.73	\$30.28	\$34.43	\$37.93	\$24.85	\$26.15		
72	-0720	\$25.13	\$31.75	\$36.73	\$40.93	\$25.29	\$26.85		
Solder Center, Crimp Outer, Low Loss Flexible									
LTH IN INS	DASH NUM	50 Ω ^{⑤⑧} SIG 100 ^③ 2 shields 1LC-MUAMUB-	50 Ω ^{⑤⑧} LMR 100 ^③ 2 shields 1LM-MUAMUB-	50 Ω ^③ SIG 195 ^③ 2 shields ^④ 19C-MUAMUB-	50 Ω ^③ LMR 195 ^③ 2 shields ^④ 19M-MUAMUB-	50 Ω ^{③⑨} SIG 240 ^③ 2 shields 24C-MUAMUB-	50 Ω ^{③⑨} LMR 240 ^③ 2 shields 24L-MUAMUB-	50 Ω ^{④⑩} SIG 400 ^③ 2 shields 4LC-MUAMUB-	
24	-0240	\$23.15	\$23.27	\$23.33	\$23.72	\$26.50	\$26.92	\$27.52	
60	-0600	\$23.69	\$23.93	\$23.93	\$24.71	\$27.10	\$27.94	\$30.10	
120	-1200	\$24.23	\$24.59	\$24.53	\$25.70	\$27.70	\$28.96	\$34.40	
180	-1800	\$24.77	\$25.25	\$25.13	\$26.69	\$28.30	\$29.98	\$38.70	
240	-2400	\$25.31	\$25.91	\$25.73	\$27.68	\$28.90	\$31.00	\$43.00	
300	-3000	\$25.85	\$26.57	\$26.33	\$28.67	\$29.50	\$32.02	\$47.30	
Solder Center, Crimp Outer, Low Loss Flexible									
LTH IN INS	DASH NUM	50 Ω ^{④⑩} LMR 400 ^③ 2 shields 4LM-MUAMUB-	50 Ω ^{④⑩①} SIG 400DB 2 shields 4DC-MUAMUB-	50 Ω ^{④⑩①} LMR 400DB 2 shields 4LD-MUAMUB-	50 Ω ^{④⑩} SIG 400FR ^③ 2 shields 4RC-MUAMUB-	50 Ω ^{④⑩①} LMR 400FR 2 shields 4LR-MUAMUB-	50 Ω ^{④⑩} SIG 400UF 2 shields ^④ 4UC-MUAMUB-	50 Ω ^{④⑩①} LMR 400UF 2 shields 4UF-MUAMUB-	
24	-0240	\$27.18	\$26.78	\$27.40	\$26.78	\$27.70	\$26.78	\$29.60	
60	-0600	\$28.56	\$27.76	\$29.00	\$27.76	\$29.60	\$27.76	\$35.30	
120	-1200	\$29.94	\$28.74	\$30.60	\$28.74	\$31.50	\$28.74	\$44.80	
180	-1800	\$31.32	\$29.72	\$32.20	\$29.72	\$33.40	\$29.72	\$54.30	
240	-2400	\$32.70	\$30.70	\$33.80	\$30.70	\$35.30	\$30.70	\$63.80	
300	-3000	\$34.08	\$31.68	\$35.40	\$31.68	\$37.20	\$31.68	\$73.30	
Color Designators (add letter to the end of the part number and add \$1.00 to price)									
Black - B		Blue - L		Brown - N		Gray - A		Green - G	
Orange - O		Red - R		Violet - V		Yellow - Y		White - W	

See Page B5 for Cable Characteristics

* Contact Factory for delivery, Consider new RD316 for (RD188) 10% Discount @ 25 pcs. up 4% Discount @ 10 pcs. up



RF Depot.com Inc.

Phone 856-488-2000 Fax 856-488-2020

B60

7850 Browning Rd. Pennsauken, NJ 08109

Online @ www.rfdepot.com

Toll Free 877-RF Depot

Mini-UHF Male Plug x Mini-UHF Male Plug

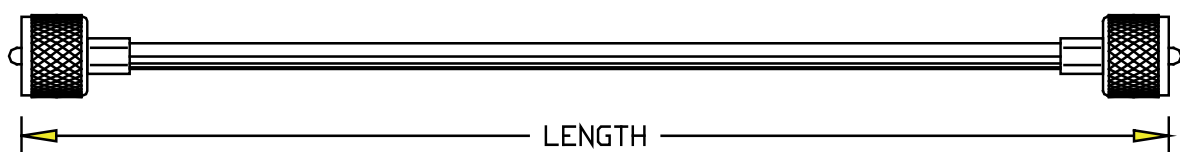

LTH IN INS	DASH NUM	50 Ω ^{③⑥⑦} RG 58C 1 shield 058-MUAMUA-	50 Ω ^{③⑦} RG 223 ^① 2 shields 223-MUAMUA-	50 Ω ^{④⑦} RG142B 2 shields 142-MUAMUA-	50 Ω ^{④①⑦} RG 400* 2 shields 400-MUAMUA-	50 Ω RG 316 ^{④②} 1 shield ^⑩ 316-MUAMUA-	50 Ω RG188* ^{④②} 1 shield ^⑩ 188-MUAMUA-
Solder Center, Crimp Outer							
12	-0120	\$16.14	\$17.81	\$18.64	\$19.34	\$17.27	\$17.62
24	-0240	\$16.54	\$19.28	\$20.94	\$22.34	\$17.92	\$18.62
36	-0360	\$16.94	\$20.75	\$23.24	\$25.34	\$18.57	\$19.62
48	-0480	\$17.34	\$22.22	\$25.54	\$28.34	\$19.22	\$20.62
60	-0600	\$17.74	\$23.69	\$27.84	\$31.34	\$19.87	\$21.62
72	-0720	\$18.14	\$25.16	\$30.14	\$34.34	\$20.52	\$22.62

Mini-UHF Male Plug x N Male Plug

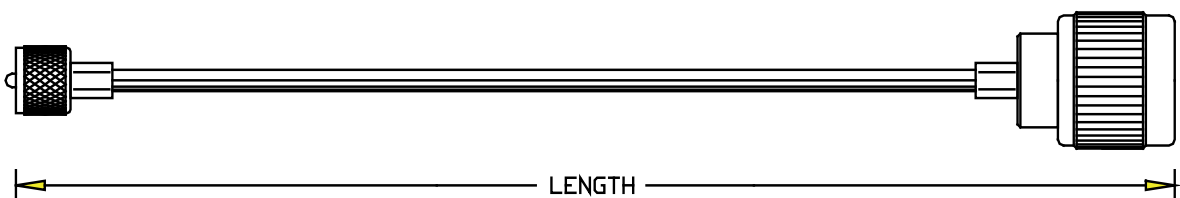

LENGTH IN INCHES	DASH NUM	50 Ω ^{③⑥⑦} RG 58C 1 shield 058-MUANA-	50 Ω ^{③⑦} RG 223 ^① 2 shields 223-MUANA-	50 Ω ^{④⑦} RG142B 2 shields 142-MUANA-	50 Ω ^{④①⑦} RG 400* 2 shields 400-MUANA-	50 Ω RG 316 ^{④②} 1 shield ^⑩ 316-MUANA-	50 Ω RG188* ^{④②} 1 shield ^⑩ 188-MUANA-
Solder Center, Crimp Outer							
12	-0120	\$22.53	\$23.90	\$24.73	\$25.43	\$21.79	\$22.14
24	-0240	\$22.93	\$25.37	\$27.03	\$28.43	\$22.44	\$23.14
36	-0360	\$23.33	\$26.84	\$29.33	\$31.43	\$23.09	\$24.14
48	-0480	\$23.73	\$28.31	\$31.63	\$34.43	\$23.74	\$25.14
60	-0600	\$24.13	\$29.78	\$33.93	\$37.43	\$24.39	\$26.14
72	-0720	\$24.53	\$31.25	\$36.23	\$40.43	\$25.04	\$27.14
Color Designators (add letter to the end of the part number and add \$1.00 to price)							
Black - B		Blue - L		Brown - N		Gray - A	
Orange - O		Red - R		Violet - V		Green - G	
						White - W	

See Page B5 for Cable Characteristics

* Contact Factory for delivery, Consider new RD316 for (RD188)

10% Discount @ 25 pcs. up

4% Discount @ 10 pcs. up

Mini-UHF Male Plug x SMA Male Plug

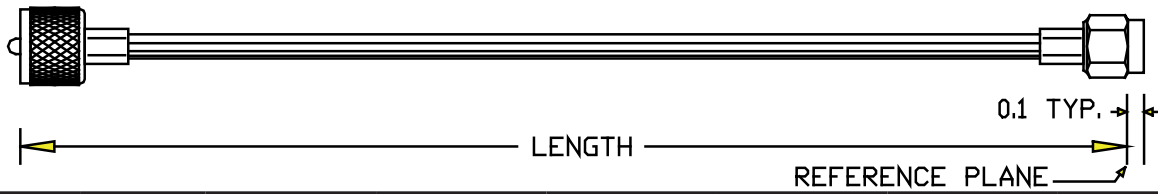

LENGTH IN INCHES	DASH NUMBER	50 Ω ⑤⑥⑦ RG 58C 1 shield 058-MUAMA-	50 Ω ③⑦ RG 223① 2 shields 223-MUAMA-	50 Ω ④⑦ RG142B 2 shields 142-MUAMA-	50 Ω ④①⑦ RG 400* 2 shields 400-MUAMA-	50 Ω RG 316④② 1 shield⑩ 316-MUAMA-	50 Ω RG188*④② 1 shield⑩ 188-MUAMA-
Solder Center, Crimp Outer							
12	-0120	\$21.80	\$24.46	\$25.29	\$25.99	\$20.54	\$20.89
24	-0240	\$22.20	\$25.93	\$27.59	\$28.99	\$21.19	\$21.89
36	-0360	\$22.60	\$27.40	\$29.89	\$31.99	\$21.84	\$22.89
48	-0480	\$23.00	\$28.87	\$32.19	\$34.99	\$22.49	\$23.89
60	-0600	\$23.40	\$30.34	\$34.49	\$37.99	\$23.14	\$24.89
72	-0720	\$23.80	\$31.81	\$36.79	\$40.99	\$23.79	\$25.89

Mini-UHF Male Plug x TNC Male Plug

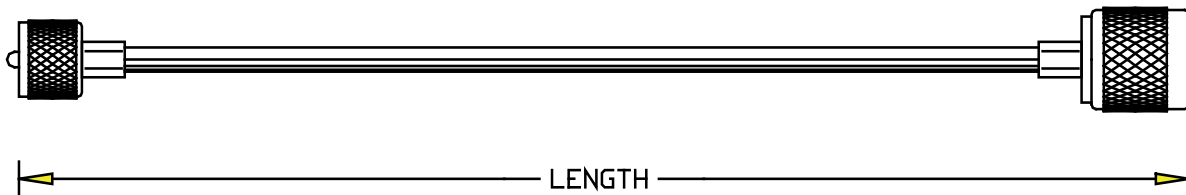

LENGTH IN INCHES	DASH NUMBER	50 Ω ⑤⑥⑦ RG 58C 1 shield 058-MUATA-	50 Ω ③⑦ RG 223① 2 shields 223-MUATA-	50 Ω ④⑦ RG142B 2 shields 142-MUATA-	50 Ω ④①⑦ RG 400* 2 shields 400-MUATA-	50 Ω RG 316④② 1 shield⑩ 316-MUATA-	50 Ω RG188*④② 1 shield⑩ 188-MUATA-
Solder Center, Crimp Outer							
12	-0120	\$18.66	\$23.35	\$24.18	\$24.88	\$21.05	\$21.40
24	-0240	\$19.06	\$24.82	\$26.48	\$27.88	\$21.70	\$22.40
36	-0360	\$19.46	\$26.29	\$28.78	\$30.88	\$22.35	\$23.40
48	-0480	\$19.86	\$27.76	\$31.08	\$33.88	\$23.00	\$24.40
60	-0600	\$20.26	\$29.23	\$33.38	\$36.88	\$23.65	\$25.40
72	-0720	\$20.66	\$30.70	\$35.68	\$39.88	\$24.30	\$26.40
Color Designators (add letter to the end of the part number and add \$1.00 to price)							
Black - B		Blue - L		Brown - N		Gray - A	
Orange - O		Red - R		Violet - V		Green - G	
						White - W	

See Page B5 for Cable Characteristics

* Contact Factory for delivery, Consider new RD316 for (RD188)

10% Discount @ 25 pcs. up

4% Discount @ 10 pcs. up



RF Depot.com Inc.

Phone 856-488-2000 Fax 856-488-2020

MMCX Female Bulkhead Jack x MMCX Male Plug

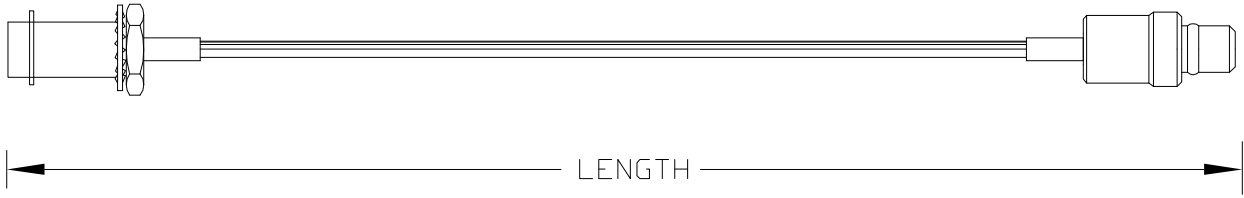

LTH IN INS	DASH NUM	50 Ω RG 174④⑤ 1 shield⑦ 174-MCXFMCXA-	50 Ω RG 316④② 1 shield⑩ 316-MCXFMCXA-	50 Ω RD316④②⑦ 2 shields 31D-MCXFMCXA-	50 Ω RG188*④② 1 shield⑩ 188-MCXFMCXA-	50 Ω RG 178B/U② 1 shield⑩ 178-MCXFMCXA-	50 Ω RG 196② 1 shield⑩ 196-MCXFMCXA-
Solder Center, Crimp Outer							
12	-0120	\$24.37	\$24.78	\$25.98	\$25.13	\$21.72	\$21.72
24	-0240	\$24.61	\$25.43	\$27.83	\$26.13	\$22.46	\$22.46
36	-0360	\$24.85	\$26.08	\$29.68	\$27.13	\$23.20	\$23.20
48	-0480	\$25.09	\$26.73	\$31.53	\$28.13	\$23.94	\$23.94
60	-0600	\$25.33	\$27.38	\$33.38	\$29.13	\$24.68	\$24.68
72	-0720	\$25.57	\$28.03	\$35.23	\$30.13	\$25.42	\$25.42

MMCX Female Bulkhead Jack x SMA Male Plug



LENGTH IN INCHES	DASH NUMBER	50 Ω RG 174④⑤ 1 shield⑦ 174-MCXFMA-	50 Ω RG 316④② 1 shield⑩ 316-MCXFMA-	50 Ω RD316④②⑦ 2 shields 31D-MCXFMA-	50 Ω RG188*④② 1 shield⑩ 188-MCXFMA-	50 Ω RG 178B/U② 1 shield⑩ 178-MCXFMA-	50 Ω RG 196② 1 shield⑩ 196-MCXFMA-
Solder Center, Crimp Outer							
12	-0120	\$23.77	\$24.18	\$23.83	\$24.53	\$30.86	\$30.86
24	-0240	\$24.01	\$24.83	\$25.68	\$25.53	\$31.60	\$31.60
36	-0360	\$24.25	\$25.48	\$27.53	\$26.53	\$32.34	\$32.34
48	-0480	\$24.49	\$26.13	\$29.38	\$27.53	\$33.08	\$33.08
60	-0600	\$24.73	\$26.78	\$31.23	\$28.53	\$33.82	\$33.82
72	-0720	\$24.97	\$27.43	\$33.08	\$29.53	\$34.56	\$34.56
Color Designators (add letter to the end of the part number and add \$1.00 to price)							
Black - B		Blue - L		Brown - N		Gray - A	
Orange - O		Red - R		Violet - V		Green - G	
						White - W	

See Page B5 for Cable Characteristics

* Contact Factory for delivery, Consider new RD316 for (RD188) 10% Discount @ 25 pcs. up 4% Discount @ 10 pcs. up

MMCX Female Jack x MMCX Female Jack



LTH IN INS	DASH NUM	50 Ω RG 174 ^⑤ 1 shield ^⑦ 174-MCXBMCXB-	50 Ω RG 316 ^{④②} 1 shield ^⑩ 316-MCXBMCXB-	50 Ω RD316 ^{④②⑦} 2 shields 31D-MCXBMCXB-	50 Ω RG188* ^{④②} 1 shield ^⑩ 188-MCXBMCXB-	50 Ω RG 178B/U ^② 1 shield ^⑩ 178-MCXBMCXB-	50 Ω RG 196 ^② 1 shield ^⑩ 196-MCXBMCXB-
Solder Center, Crimp Outer							
12	-0120	\$22.04	\$22.45	\$23.65	\$22.80	\$22.54	\$22.54
24	-0240	\$22.28	\$23.10	\$25.50	\$23.80	\$23.28	\$23.28
36	-0360	\$22.52	\$23.75	\$27.35	\$24.80	\$24.02	\$24.02
48	-0480	\$22.76	\$24.40	\$29.20	\$25.80	\$24.76	\$24.76
60	-0600	\$23.00	\$25.05	\$31.05	\$26.80	\$25.50	\$25.50
72	-0720	\$23.24	\$25.70	\$32.90	\$27.80	\$26.24	\$26.24

MMCX Female Jack x MMCX Male Plug



LTH IN INS	DASH NUM	50 Ω RG 174 ^⑤ 1 shield ^⑦ 174-MCXAMCXB-	50 Ω RG 316 ^{④②} 1 shield ^⑩ 316-MCXAMCXB-	50 Ω RD316 ^{④②⑦} 2 shields 31D-MCXAMCXB-	50 Ω RG188* ^{④②} 1 shield ^⑩ 188-MCXAMCXB-	50 Ω RG 178B/U ^② 1 shield ^⑩ 178-MCXAMCXB-	50 Ω RG 196 ^② 1 shield ^⑩ 196-MCXAMCXB-
Solder Center, Crimp Outer							
12	-0120	\$23.82	\$23.73	\$24.93	\$24.08	\$20.49	\$20.49
24	-0240	\$24.56	\$24.38	\$26.78	\$25.08	\$21.23	\$21.23
36	-0360	\$25.30	\$25.03	\$28.63	\$26.08	\$21.97	\$21.97
48	-0480	\$26.04	\$25.68	\$30.48	\$27.08	\$22.71	\$22.71
60	-0600	\$26.78	\$26.33	\$32.33	\$28.08	\$23.45	\$23.45
72	-0720	\$27.52	\$26.98	\$34.18	\$29.08	\$24.19	\$24.19
Color Designators (add letter to the end of the part number and add \$1.00 to price)							
Black - B		Blue - L		Brown - N		Gray - A	
Orange - O		Red - R		Violet - V		Green - G	
						White - W	

See Page B5 for Cable Characteristics

* Contact Factory for delivery, Consider new RD316 for (RD188) 10% Discount @ 25 pcs. up 4% Discount @ 10 pcs. up

MMCX Female Jack x SMA Male Plug



LTH IN INS	DASH NUM	50 Ω RG 174 ^{③⑤} 1 shield ^⑦ 174-MAMCXB-	50 Ω RG 316 ^{④②} 1 shield ^⑩ 316-MAMCXB-	50 Ω RD316 ^{④②⑦} 2 shields 31D-MAMCXB-	50 Ω RG188* ^{④②} 1 shield ^⑩ 188-MAMCXB-	50 Ω RG 178B/U ^② 1 shield ^⑩ 178-MAMCXB-	50 Ω RG 196 ^② 1 shield ^⑩ 196-MAMCXB-
Solder Center, Crimp Outer							
12	-0120	\$22.72	\$23.13	\$22.78	\$23.48	\$29.63	\$29.63
24	-0240	\$22.96	\$23.78	\$24.63	\$24.48	\$30.37	\$30.37
36	-0360	\$23.20	\$24.43	\$26.48	\$25.48	\$31.11	\$31.11
48	-0480	\$23.44	\$25.08	\$28.33	\$26.48	\$31.85	\$31.85
60	-0600	\$23.68	\$25.73	\$30.18	\$27.48	\$32.59	\$32.59
72	-0720	\$23.92	\$26.38	\$32.03	\$28.48	\$33.33	\$33.33

MMCX Female Jack x SMA Female Bulkhead Jack



LTH IN INS	DASH NUM	50 Ω RG 174 ^{③⑤} 1 shield ^⑦ 174-MFMCXB-	50 Ω RG 316 ^{④②} 1 shield ^⑩ 316-MFMCXB-	50 Ω RD316 ^{④②⑦} 2 shields 31D-MFMCXB-	50 Ω RG188* ^{④②} 1 shield ^⑩ 188-MFMCXB-	50 Ω RG 178B/U ^② 1 shield ^⑩ 178-MFMCXB-	50 Ω RG 196 ^② 1 shield ^⑩ 196-MFMCXB-
Solder Center, Crimp Outer							
12	-0120	\$29.77	\$30.18	\$31.38	\$30.53	\$34.83	\$34.83
24	-0240	\$30.01	\$30.83	\$33.23	\$31.53	\$35.57	\$35.57
36	-0360	\$30.25	\$31.48	\$35.08	\$32.53	\$36.31	\$36.31
48	-0480	\$30.49	\$32.13	\$36.93	\$33.53	\$37.05	\$37.05
60	-0600	\$30.73	\$32.78	\$38.78	\$34.53	\$37.79	\$37.79
72	-0720	\$30.97	\$33.43	\$40.63	\$35.53	\$38.53	\$38.53
Color Designators (add letter to the end of the part number and add \$1.00 to price)							
Black - B		Blue - L		Brown - N		Gray - A	
Orange - O		Red - R		Violet - V		Green - G	
						White - W	

See Page B5 for Cable Characteristics

* Contact Factory for delivery, Consider new RD316 for (RD188)

10% Discount @ 25 pcs. up

4% Discount @ 10 pcs. up

MMCX Male Plug x MMCX Male Plug



LENGTH IN INCHES	DASH NUMBER	50 Ω RG 174 ^{①⑤} 1 shield ^⑦ 174-MCXAMCXA-	50 Ω RG 316 ^{④②} 1 shield ^⑧ 316-MCXAMCXA-	50 Ω RD316 ^{④②⑦} 2 shields 31D-MCXAMCXA-	50 Ω RG188* ^{④②} 1 shield ^⑧ 188-MCXAMCXA-
Solder Center, Crimp Outer					
12	-0120	\$24.60	\$25.01	\$26.21	\$25.36
24	-0240	\$24.84	\$25.66	\$28.06	\$26.36
36	-0360	\$25.08	\$26.31	\$29.91	\$27.36
48	-0480	\$25.32	\$26.96	\$31.76	\$28.36
60	-0600	\$25.56	\$27.61	\$33.61	\$29.36
72	-0720	\$25.80	\$28.26	\$35.46	\$30.36
Solder Center, Crimp Outer / .047" Diameter SEMIRIGID and Maxi Flex. Direct Solder Connectors					
LENGTH IN INCHES	DASH NUMBER	50 Ω RG 178B/U ^② 1 shield ^⑧ 178-MCXAMCXA-	50 Ω RG 196 ^② 1 shield ^⑧ 196-MCXAMCXA-	50 Ω (No QPL List) .047 Tin Plate Al 4AT-MCXAMCXA-	50 Ω ^② M17/151-00002 .047 Tin Plate Cu 4TS-MCXAMCXA-
12	-0120	\$18.44	\$18.44	\$25.38	\$25.38
24	-0240	\$19.18	\$19.18	\$29.18	\$29.18
36	-0360	\$19.92	\$19.92	\$32.98	\$32.98
48	-0480	\$20.66	\$20.66	\$36.78	\$36.78
60	-0600	\$21.40	\$21.40	\$40.58	\$40.58
72	-0720	\$22.14	\$22.14	\$44.38	\$44.38
.047" Diameter SEMIRIGID and Maxi Flex. Direct Solder Connectors					
LENGTH IN INCHES	DASH NUMBER	50 Ω MaxiFlex ^② (No QPL List) .047 Tin Pl 04F-MCXAMCXA-	50 Ω RG 405 ^② M17/133-00007 .085 Tin Plate Cu 8TS-MCXAMCXA-	50 Ω MaxiFlex ^② (No QPL List) .085 Tin Pl 08F-MCXAMCXA-	50 Ω ^② M17/154-00002 .034 Tin Plate Cu 3TS-MCXAMCXA-
12	-0120	\$26.08	\$23.14	\$24.37	\$62.85
24	-0240	\$30.58	\$26.16	\$28.62	\$70.96
36	-0360	\$35.08	\$29.18	\$32.87	\$79.07
48	-0480	\$39.58	\$32.20	\$37.12	\$87.18
60	-0600	\$44.08	\$35.22	\$41.37	\$95.29
72	-0720	\$48.58	\$38.24	\$45.62	\$103.40
Color Designators (add letter to the end of the part number and add \$1.00 to price)					
Black - B		Blue - L	Brown - N	Gray - A	Green - G
Orange - O		Red - R	Violet - V	Yellow - Y	White - W

See Page B5 for Cable Characteristics

* Contact Factory for delivery, Consider new RD316 for (RD188) 10% Discount @ 25 pcs. up 4% Discount @ 10 pcs. up

① Silver Plated Copper Center Conductor ② Silver Plated Copper Clad Steel Center Conductor



RF Depot.com Inc.

Phone 856-488-2000 Fax 856-488-2020

MMCX Male Plug x MMCX Right Angle Male Plug



LTH IN INS	DASH NUM	50 Ω RG 174 ^{①⑤} 1 shield ^⑦ 174-MCXAMCXC-	50 Ω RG 316 ^{④②} 1 shield ^⑩ 316-MCXAMCXC-	50 Ω RD316 ^{④②⑦} 2 shields 31D-MCXAMCXC-	50 Ω RG188* ^{④②} 1 shield ^⑩ 188-MCXAMCXC-	50 Ω RG 178B/U ^② 1 shield ^⑩ 178-MCXAMCXC-	50 Ω RG 196 ^② 1 shield ^⑩ 196-MCXAMCXC-
Solder Center, Crimp Outer							
12	-0120	\$23.21	\$23.62	\$24.82	\$23.97	\$18.79	\$18.79
24	-0240	\$23.45	\$24.27	\$26.67	\$24.97	\$19.53	\$19.53
36	-0360	\$23.69	\$24.92	\$28.52	\$25.97	\$20.27	\$20.27
48	-0480	\$23.93	\$25.57	\$30.37	\$26.97	\$21.01	\$21.01
60	-0600	\$24.17	\$26.22	\$32.22	\$27.97	\$21.75	\$21.75
72	-0720	\$24.41	\$26.87	\$34.07	\$28.97	\$22.49	\$22.49

MMCX Male Plug x SMA Female Bulkhead Jack

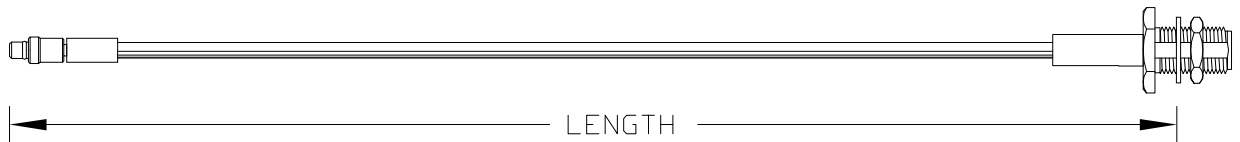

LTH IN INS	DASH NUM	50 Ω RG 174 ^{①⑤} 1 shield ^⑦ 174-MCXAMF-	50 Ω RG 316 ^{④②} 1 shield ^⑩ 316-MCXAMF-	50 Ω RD316 ^{④②⑦} 2 shields 31D-MCXAMF-	50 Ω RG188* ^{④②} 1 shield ^⑩ 188-MCXAMF-	50 Ω RG 178B/U ^② 1 shield ^⑩ 178-MCXAMF-	50 Ω RG 196 ^② 1 shield ^⑩ 196-MCXAMF-
Solder Center, Crimp Outer							
12	-0120	\$31.05	\$31.46	\$32.66	\$31.81	\$32.78	\$32.78
24	-0240	\$31.29	\$32.11	\$34.51	\$32.81	\$33.52	\$33.52
36	-0360	\$31.53	\$32.76	\$36.36	\$33.81	\$34.26	\$34.26
48	-0480	\$31.77	\$33.41	\$38.21	\$34.81	\$35.00	\$35.00
60	-0600	\$32.01	\$34.06	\$40.06	\$35.81	\$35.74	\$35.74
72	-0720	\$32.25	\$34.71	\$41.91	\$36.81	\$36.48	\$36.48
Color Designators (add letter to the end of the part number and add \$1.00 to price)							
Black - B		Blue - L		Brown - N		Gray - A	
Orange - O		Red - R		Violet - V		Green - G	
						White - W	

See Page B5 for Cable Characteristics

* Contact Factory for delivery, Consider new RD316 for (RD188)

10% Discount @ 25 pcs. up

4% Discount @ 10 pcs. up

MMCX Male Plug x SMA Male Plug

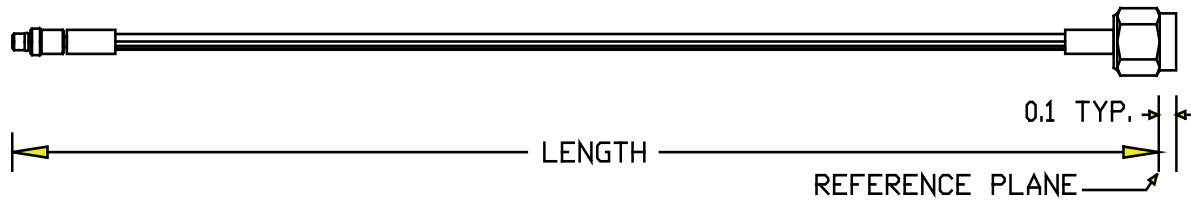

LENGTH IN INCHES	DASH NUMBER	50 Ω RG 174 ^{③⑤} 1 shield ^⑦ 174-MCXAMA-	50 Ω RG 316 ^{④②} 1 shield ^⑧ 316-MCXAMA-	50 Ω RD316 ^{④②⑦} 2 shields 31D-MCXAMA-	50 Ω RG188* ^{④②} 1 shield ^⑧ 188-MCXAMA-
Solder Center, Crimp Outer					
12	-0120	\$24.00	\$24.41	\$24.06	\$24.76
24	-0240	\$24.24	\$25.06	\$25.91	\$25.76
36	-0360	\$24.48	\$25.71	\$27.76	\$26.76
48	-0480	\$24.72	\$26.36	\$29.61	\$27.76
60	-0600	\$24.96	\$27.01	\$31.46	\$28.76
72	-0720	\$25.20	\$27.66	\$33.31	\$29.76
Solder Center, Crimp Outer / .047" Diameter SEMIRIGID and Maxi Flex. Direct Solder Connectors					
LENGTH IN INCHES	DASH NUMBER	50 Ω RG 178B/U ^② 1 shield ^⑧ 178-MCXAMA-	50 Ω RG 196 ^② 1 shield ^⑧ 196-MCXAMA-	50Ω (No QPL List) .047 Tin Plate Al 4AT-MCXAMA-	50Ω ^② M17/151-00002 .047 Tin Plate Cu 4TS-MCXAMA-
12	-0120	\$27.58	\$27.58	\$26.37	\$26.37
24	-0240	\$28.32	\$28.32	\$30.17	\$30.17
36	-0360	\$29.06	\$29.06	\$33.97	\$33.97
48	-0480	\$29.80	\$29.80	\$37.77	\$37.77
60	-0600	\$30.54	\$30.54	\$41.57	\$41.57
72	-0720	\$31.28	\$31.28	\$45.37	\$45.37
.047" Diameter SEMIRIGID and Maxi Flex. Direct Solder Connectors					
LENGTH IN INCHES	DASH NUMBER	50Ω ^② MaxiFlex (No QPL List) .047 Tin Pl 04F-MCXAMA-	50Ω RG 405 ^② M17/133-00007 .085 Tin Plate Cu 8TS-MCXAMA-	50ΩMaxiFlex ^② (No QPL List) .085 Tin Pl 08F-MCXAMA-	50Ω ^{②⑧} M17/154-00002 .034 Tin Plate Cu 3TS-MCXAMA-
12	-0120	\$27.07	\$23.45	\$24.68	\$63.15
24	-0240	\$31.57	\$26.47	\$28.93	\$71.26
36	-0360	\$36.07	\$29.49	\$33.18	\$79.37
48	-0480	\$40.57	\$32.51	\$37.43	\$87.48
60	-0600	\$45.07	\$35.53	\$41.68	\$95.59
72	-0720	\$49.57	\$38.55	\$45.93	\$103.70
Color Designators (add letter to the end of the part number and add \$1.00 to price)					
Black - B		Blue - L	Brown - N	Gray - A	Green - G
Orange - O		Red - R	Violet - V	Yellow - Y	White - W

See Page B5 for Cable Characteristics

* Contact Factory for delivery, Consider new RD316 for (RD188) 10% Discount @ 25 pcs. up 4% Discount @ 10 pcs. up

①Silver Plated Copper Center Conductor ②Silver Plated Copper Clad Steel Center Conductor



RF Depot.com Inc.

Phone 856-488-2000 Fax 856-488-2020

MMCX Male Plug x SMA Right Angle Male Plug

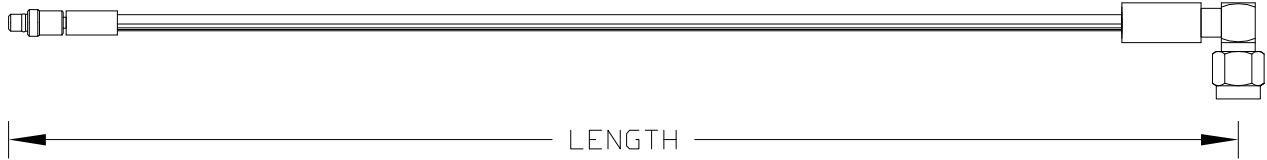

LENGTH IN INCHES	DASH NUM	50 Ω RG 174 ③⑤ 1 shield⑦ 174-MCMCXA-	50 Ω RG188* ④② 1 shield⑩ 188-MCMCXA-	50 Ω RG 178 ② 1 shield⑩ 178-MCMCXA-	50 Ω RG 196② 1 shield⑩ 196-MCMCXA-	50 Ω RG 316④② 1 shield⑩ 316-MCMCXA-	50 Ω RD 316④② 2 shields⑦ 31D-MCMCXA-
Solder Center, Crimp Outer							
12	-0120	\$31.46	\$32.22	\$35.80	\$35.80	\$31.87	\$33.07
24	-0240	\$31.70	\$33.22	\$36.54	\$36.54	\$32.52	\$34.92
36	-0360	\$31.94	\$34.22	\$37.28	\$37.28	\$33.17	\$36.77
48	-0480	\$32.18	\$35.22	\$38.02	\$38.02	\$33.82	\$38.62
60	-0600	\$32.42	\$36.22	\$38.76	\$38.76	\$34.47	\$40.47
72	-0720	\$32.66	\$37.22	\$39.50	\$39.50	\$35.12	\$42.32

MMCX 90° Male Plug x MMCX 90° Male Plug



LTH IN INS	DASH NUM	50 Ω RG 174③⑤ 1 shield⑦ 174-MCXCMCXC-	50 Ω RG 316④② 1 shield⑩ 316-MCXCMCXC-	50 Ω RD316④②⑦ 2 shields 31D-MCXCMCXC-	50 Ω RG188*④② 1 shield⑩ 188-MCXCMCXC-	50 Ω RG 178B/U② 1 shield⑩ 178-MCXCMCXC-	50 Ω RG 196② 1 shield⑩ 196-MCXCMCXC-
Solder Center, Crimp Outer							
12	-0120	\$32.61	\$33.02	\$34.22	\$33.37	\$28.34	\$28.34
24	-0240	\$32.85	\$33.67	\$36.07	\$34.37	\$29.08	\$29.08
36	-0360	\$33.09	\$34.32	\$37.92	\$35.37	\$29.82	\$29.82
48	-0480	\$33.33	\$34.97	\$39.77	\$36.37	\$30.56	\$30.56
60	-0600	\$33.57	\$35.62	\$41.62	\$37.37	\$31.30	\$31.30
72	-0720	\$33.81	\$36.27	\$43.47	\$38.37	\$32.04	\$32.04
Color Designators (add letter to the end of the part number and add \$1.00 to price)							
Black - B		Blue - L		Brown - N		Gray - A	
Orange - O		Red - R		Violet - V		Green - G	
						White - W	

See Page B5 for Cable Characteristics

* Contact Factory for delivery, Consider new RD316 for (RD188)

10% Discount @ 25 pcs. up

4% Discount @ 10 pcs. up

MMCX Right Angle Male Plug x SMA Female Bulkhead Jack



LENGTH IN INCHES	DASH NUM	50 Ω RG 174 ^⑤ 1 shield ^⑦ 174-MCXCMF-	50 Ω RG 316 ^④ ^② 1 shield ^⑩ 316-MCXCMF-	50 Ω RD316 ^④ ^② ^⑦ 2 shields 31D-MCXCMF-	50 Ω RG188* ^④ ^② 1 shield ^⑩ 188-MCXCMF-	50 Ω RG 178B/U ^② 1 shield ^⑩ 178-MCXCMF-	50 Ω RG 196 ^② 1 shield ^⑩ 196-MCXCMF-
Solder Center, Crimp Outer							
12	-0120	\$29.66	\$30.07	\$31.27	\$30.42	\$33.13	\$33.13
24	-0240	\$29.90	\$30.72	\$33.12	\$31.42	\$33.87	\$33.87
36	-0360	\$30.14	\$31.37	\$34.97	\$32.42	\$34.61	\$34.61
48	-0480	\$30.38	\$32.02	\$36.82	\$33.42	\$35.35	\$35.35
60	-0600	\$30.62	\$32.67	\$38.67	\$34.42	\$36.09	\$36.09
72	-0720	\$30.86	\$33.32	\$40.52	\$35.42	\$36.83	\$36.83

MMCX Right Angle Male Plug x SMA Female Jack



LTH IN INS	DASH NUM	50 Ω RG 174 ^⑤ 1 shield ^⑦ 174-MBMCXC-	50 Ω RG 316 ^④ ^② 1 shield ^⑩ 316-MBMCXC-	50 Ω RD316 ^④ ^② ^⑦ 2 shields 31D-MBMCXC-	50 Ω RG188* ^④ ^② 1 shield ^⑩ 188-MBMCXC-	50 Ω RG 178B/U ^② 1 shield ^⑩ 178-MBMCXC-	50 Ω RG 196 ^② 1 shield ^⑩ 196-MBMCXC-
Solder Center, Crimp Outer							
12	-0120	\$28.52	\$28.93	\$30.13	\$29.28	\$25.11	\$25.11
24	-0240	\$28.76	\$29.58	\$31.98	\$30.28	\$25.35	\$25.35
36	-0360	\$29.00	\$30.23	\$33.83	\$31.28	\$25.59	\$25.59
48	-0480	\$29.24	\$30.88	\$35.68	\$32.28	\$25.83	\$25.83
60	-0600	\$29.48	\$31.53	\$37.53	\$33.28	\$26.07	\$26.07
72	-0720	\$29.72	\$32.18	\$39.38	\$34.28	\$26.31	\$26.31
Color Designators (add letter to the end of the part number and add \$1.00 to price)							
Black - B		Blue - L		Brown - N		Gray - A	
Orange - O		Red - R		Violet - V		Green - G	
						White - W	

See Page B5 for Cable Characteristics

* Contact Factory for delivery, Consider new RD316 for (RD188) 10% Discount @ 25 pcs. up 4% Discount @ 10 pcs. up

MMCX Right Angle Male Plug x SMA Male Plug

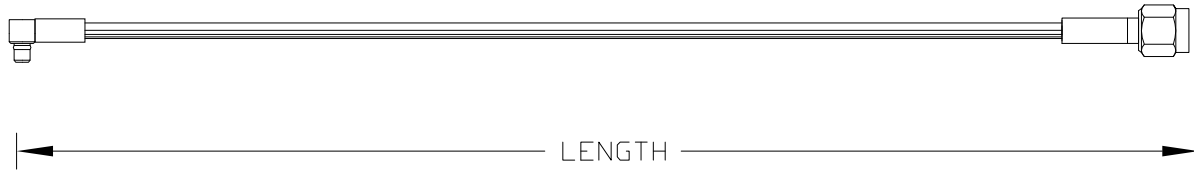

LTH IN INS	DASH NUM	50 Ω RG 174 ③⑤ 1 shield ⑦ 174-MAMCXC-	50 Ω RG 316 ④② 1 shield ⑩ 316-MAMCXC-	50 Ω RD316 ④②⑦ 2 shields 31D-MAMCXC-	50 Ω RG188* ④② 1 shield ⑩ 188-MAMCXC-	50 Ω RG 178B/U ② 1 shield ⑩ 178-MAMCXC-	50 Ω RG 196 ② 1 shield ⑩ 196-MAMCXC-
Solder Center, Crimp Outer							
12	-0120	\$22.61	\$23.02	\$22.67	\$23.37	\$27.93	\$27.93
24	-0240	\$22.85	\$23.67	\$24.52	\$24.37	\$28.67	\$28.67
36	-0360	\$23.09	\$24.32	\$26.37	\$25.37	\$29.41	\$29.41
48	-0480	\$23.33	\$24.97	\$28.22	\$26.37	\$30.15	\$30.15
60	-0600	\$23.57	\$25.62	\$30.07	\$27.37	\$30.89	\$30.89
72	-0720	\$23.81	\$26.27	\$31.92	\$28.37	\$31.63	\$31.63

MMCX 90° Plug x SMA Right Angle Male Plug

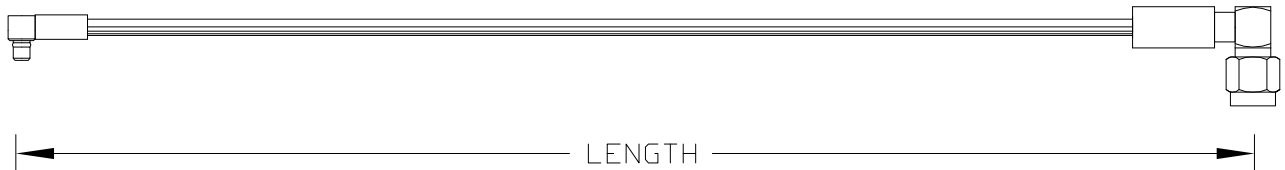

LTH IN INS	DASH NUM	50 Ω RG 174 ③⑤ 1 shield ⑦ 174-MCMCXC-	50 Ω RG188* ④② 1 shield ⑩ 188-MCMCXC-	50 Ω RG 178 ② 1 shield ⑩ 178-MCMCXC-	50 Ω RG 196 ② 1 shield ⑩ 196-MCMCXC-	50 Ω RG 316 ④② 1 shield ⑩ 316-MCMCXC-	50 Ω RD 316 ④② 2 shields ⑦ 31D-MCMCXC-
Solder Center, Crimp Outer							
12	-0120	\$30.07	\$30.83	\$36.15	\$36.15	\$30.48	\$31.68
24	-0240	\$30.31	\$31.83	\$36.89	\$36.89	\$31.13	\$33.53
36	-0360	\$30.55	\$32.83	\$37.63	\$37.63	\$31.78	\$35.38
48	-0480	\$30.79	\$33.83	\$38.37	\$38.37	\$32.43	\$37.23
60	-0600	\$31.03	\$34.83	\$39.11	\$39.11	\$33.08	\$39.08
72	-0720	\$31.27	\$35.83	\$39.85	\$39.85	\$33.73	\$40.93
Color Designators (add letter to the end of the part number and add \$1.00 to price)							
Black - B		Blue - L		Brown - N		Gray - A	
Orange - O		Red - R		Violet - V		Green - G	
						White - W	

See Page B5 for Cable Characteristics

* Contact Factory for delivery, Consider new RD316 for (RD188) 10% Discount @ 25 pcs. up 4% Discount @ 10 pcs. up

N Female Bulkhead Jack x N Male Plug

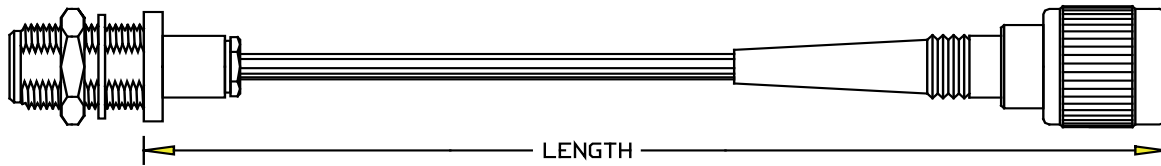

LENGTH IN INCHES	DASH NUMBER	50 Ω ^{③⑥⑦} RG 58C 1 shield 058-NANF-	50 Ω ^{③⑦} RG 223 ^① 2 shields 223-NANF-	50 Ω ^{④⑦} RG142B 2 shields 142-NANF-	50 Ω ^{④①⑦} RG 400* 2 shields 400-NANF-	75 Ω RG179A ^{④②} 1 shield ^⑥ 179-NANF-	50 Ω FSJ4-50B ^④ 1 shield .500" SUPERFLEX 50J-N0N5-
Solder Center, Crimp and Clamp Outer							
12	-0120	\$34.16	\$35.23	\$36.06	\$36.76	\$38.13	\$90.79
24	-0240	\$34.56	\$36.70	\$38.36	\$39.76	\$38.86	\$96.39
36	-0360	\$34.96	\$38.17	\$40.66	\$42.76	\$39.59	\$101.99
48	-0480	\$35.36	\$39.64	\$42.96	\$45.76	\$40.32	\$107.59
60	-0600	\$35.76	\$41.11	\$45.26	\$48.76	\$41.05	\$113.19
72	-0720	\$36.16	\$42.58	\$47.56	\$51.76	\$41.78	\$118.79
Solder Center, Crimp Outer							
LENGTH IN INCHES	DASH NUMBER	50 Ω RG 174 ^{③⑤} 1 shield ^⑦ 174-NANF-	50 Ω RG 316 ^{④②} 1 shield ^⑥ 316-NANF-	50 Ω RD316 ^{④②⑦} 2 shields 31D-NANF-	50 Ω RG188* ^{④②} 1 shield ^⑥ 188-NANF-	50 Ω RG 178B/U ^② 1 shield ^⑥ 178-NANF-	50 Ω RG 196 ^② 1 shield ^⑥ 196-NANF-
12	-0120	\$37.64	\$38.05	\$39.25	\$38.40	\$28.06	\$28.06
24	-0240	\$37.88	\$38.70	\$41.10	\$39.40	\$28.80	\$28.80
36	-0360	\$38.12	\$39.35	\$42.95	\$40.40	\$29.54	\$29.54
48	-0480	\$38.36	\$40.00	\$44.80	\$41.40	\$30.28	\$30.28
60	-0600	\$38.60	\$40.65	\$46.65	\$42.40	\$31.02	\$31.02
72	-0720	\$38.84	\$41.30	\$48.50	\$43.40	\$31.76	\$31.76
Solder Center, Crimp Outer							
LENGTH IN INCHES	DASH NUMBER	50 Ω RG 8* ^{③③③} 1 shield 008-NANF-	50 Ω ^③ RG 213 ^{③③} 1 shield 213-NANF-	50 Ω RG 214 ^{④①} 2 shields ^⑦ 214-NANF-	75 Ω ^{⑤③③} RG 59B ^③ 1 shield 059-NANF-	93 Ω ^{⑤③③} RG 62 ^③ 1 shield 062-NANF-	50 Ω RG 393 ^{④①⑦} 2 shields 393-NANF-
12	-0120	\$46.06	\$46.24	\$39.23	\$25.44	\$25.70	\$44.36
24	-0240	\$47.46	\$47.82	\$42.73	\$25.88	\$26.40	\$52.99
36	-0360	\$48.86	\$49.40	\$46.23	\$26.32	\$27.10	\$61.62
48	-0480	\$50.26	\$50.98	\$49.73	\$26.76	\$27.80	\$70.25
60	-0600	\$51.66	\$52.56	\$53.23	\$27.20	\$28.50	\$78.88
72	-0720	\$53.06	\$54.14	\$56.73	\$27.64	\$29.20	\$87.51
Color Designators (add letter to the end of the part number and add \$1.00 to price)							
Black - B		Blue - L		Brown - N		Gray - A	
Orange - O		Red - R		Violet - V		Green - G	
						White - W	

See Page B5 for Cable Characteristics

* Contact Factory for delivery, Consider new RD316 for (RD188) 10% Discount @ 25 pcs. up 4% Discount @ 10 pcs. up

‡ Brass Body Stainless Steel Nut



RF Depot.com Inc.

Phone 856-488-2000 Fax 856-488-2020

N Female Bulkhead Jack x N Male Plug

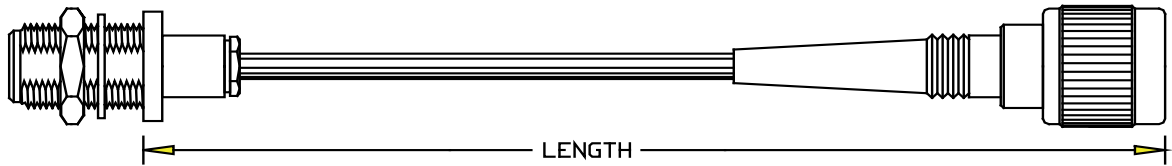

LENGTH IN INCHES	DASH NUMBER	50Ω RG 401① M17/129-RG401 .250 Cu Jacket 401-N0N5-	50Ω RG 401① (No QPL List) .250 Tin Plate Al 25A-N0N5-	50Ω RG 401② M17/129-00001 .250 Tin Plate Cu 2TS-N0N5-	50Ω MaxiFlex② (No QPL List) .250 Tin Plate Braid 25F-N0N5-	
.250" Diameter SEMIRIGID and Maxi Flex. Direct Solder Connectors						
12	-0120	\$63.38	\$64.32	\$68.57	\$63.38	
24	-0240	\$66.40	\$68.28	\$76.78	\$66.40	
36	-0360	\$69.42	\$72.24	\$84.99	\$69.42	
48	-0480	\$72.44	\$76.20	\$93.20	\$72.44	
60	-0600	\$75.46	\$80.16	\$101.41	\$75.46	
72	-0720	\$78.48	\$84.12	\$109.62	\$78.48	
.141" Diameter SEMIRIGID and Maxi Flex. Direct Solder Connectors						
LENGTH IN INCHES	DASH NUMBER	50Ω RG 402② M17/130-00004 .141 Cu Jacket 402-N0N5-	50Ω RG 402② M17/130-00005 .141 Tin Plate Cu 1TS-N0N5-	50Ω RG 402① M17/130-00009 .141 Tin Plate Al 1AT-N0N5-	50Ω MaxiFlex② (No QPL List) .141 Tin Pl 14F-N0N5-	50Ω RG 402② M17/130-00012 .141 Silver Pl 1SS-N0N5-
12	-0120	\$55.10	\$54.71	\$55.10	\$54.74	\$64.31
24	-0240	\$58.70	\$57.92	\$58.70	\$57.98	\$77.12
36	-0360	\$62.30	\$61.13	\$62.30	\$61.22	\$89.93
48	-0480	\$65.90	\$64.34	\$65.90	\$64.46	\$102.74
60	-0600	\$69.50	\$67.55	\$69.50	\$67.70	\$115.55
72	-0720	\$73.10	\$70.76	\$73.10	\$70.94	\$128.36
.085" Diameter SEMIRIGID and Maxi Flex. Direct Solder Connectors						
LENGTH IN INCHES	DASH NUMBER	50Ω RG 405② M17/133-00007 .085 Tin Plate Cu 405-N0N5-	50Ω RG 405② M17/133-00007 .085 Tin Plate Cu 8TS-N0N5-	50Ω RG 405② M17/133-00013 .085 Tin Plate Al 8AT-N0N5-	50Ω MaxiFlex② (No QPL List) .085 Tin Pl 08F-N0N5-	50Ω RG 405② M17/133-00016 .085 Silver Pl 8SS-N0N5-
12	-0120	\$54.47	\$54.47	\$55.41	\$55.70	\$59.66
24	-0240	\$57.49	\$57.49	\$59.37	\$59.95	\$67.87
36	-0360	\$60.51	\$60.51	\$63.33	\$64.20	\$76.08
48	-0480	\$63.53	\$63.53	\$67.29	\$68.45	\$84.29
60	-0600	\$66.55	\$66.55	\$71.25	\$72.70	\$92.50
72	-0720	\$69.57	\$69.57	CALL	\$76.95	CALL

①Silver Plated Copper Center Conductor ②Silver Plated Copper Clad Steel Center Conductor

10% Discount @ 25 pcs. up 4% Discount @ 10 pcs. up

N Female Bulkhead Jack x N Male Plug Commercial

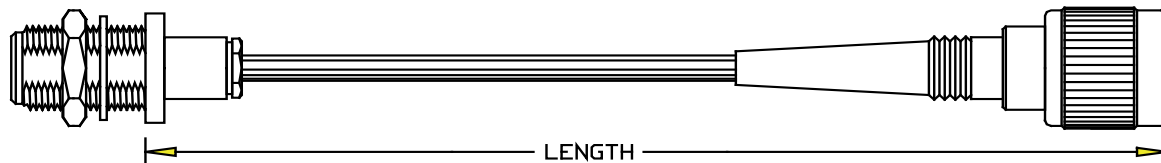

LTH IN INS	DASH NUM	50Ω RG 401① M17/129-RG401 .250 Cu Jacket 401-N0N5-	50Ω RG 401① (No QPL List) .250 Tin Plate Al 25A-N0N5-	50Ω RG 401② M17/129-00001 .250 Tin Plate Cu 2TS-N0N5-	50Ω MaxiFlex② (No QPL List) .250 Tin Plate Braid 25F-N0N5-	
.250" Diameter SEMIRIGID and Maxi Flex. Direct Solder Connectors						
24	-0240C	\$40.17	\$42.05	\$50.55	\$40.17	
48	-0480C	\$46.21	\$49.97	\$66.97	\$46.21	
60	-0600C	\$49.23	\$53.93	\$75.18	\$49.23	
72	-0720C	\$52.25	\$57.89	\$83.39	\$52.25	
.141" Diameter SEMIRIGID and Maxi Flex. Direct Solder Connectors						
LTH IN INS	DASH NUM	50Ω RG 402② M17/130-00004 .141 Cu Jacket 402-N0N5-	50Ω RG 402② M17/130-00005 .141 Tin Plate Cu 1TS-N0N5-	50Ω RG 402① M17/130-00009 .141 Tin Plate Al 1AT-N0N5-	50Ω MaxiFlex② (No QPL List) .141 Tin Pl 14F-N0N5-	50Ω RG 402② M17/130-00012 .141 Silver Pl 1SS-N0N5-
12	-0120C	\$29.18	\$28.82	\$29.18	\$28.82	\$38.39
24	-0240C	\$32.78	\$32.06	\$32.78	\$32.06	\$51.20
36	-0360C	\$36.38	\$35.30	\$36.38	\$35.30	\$64.01
48	-0480C	\$39.98	\$38.54	\$39.98	\$38.54	\$76.82
60	-0600C	\$43.58	\$41.78	\$43.58	\$41.78	\$89.63
72	-0720C	\$47.18	\$45.02	\$47.18	\$45.02	\$102.44
.085" Diameter SEMIRIGID and Maxi Flex. Direct Solder Connectors						
LTH IN INS	DASH NUM	50Ω RG 405② M17/133-00007 .085 Tin Plate Cu 405-N0N5-	50Ω RG 405② M17/133-00007 .085 Tin Plate Cu 8TS-N0N5-	50Ω RG 405② M17/133-00013 .085 Tin Plate Al 8AT-N0N5-	50Ω MaxiFlex② (No QPL List) .085 Tin Pl 08F-N0N5-	50Ω RG 405② M17/133-00016 .085 Silver Pl 8SS-N0N5-
12	-0120C	\$30.25	\$30.25	\$31.19	\$31.48	\$35.44
24	-0240C	\$33.27	\$33.27	\$35.15	\$35.73	\$43.65
36	-0360C	\$36.29	\$36.29	\$39.11	\$39.98	\$51.86
48	-0480C	\$39.31	\$39.31	\$43.07	\$44.23	\$60.07
60	-0600C	\$42.33	\$42.33	\$47.03	\$48.48	\$68.28
72	-0720C	\$45.35	\$45.35	CALL	\$52.73	CALL
Non-Magnetic Cable Assemblies. Direct Solder Connectors						
LTH IN INS	DASH NUM	50Ω① M17/130-00015 .141 Tin Plate Cu 1CT-N0N5-	50Ω MaxiFlex① (No QPL List) .141 Tin Plate Cu 1CF-N0N5-	50Ω ① (No QPL List) .141 Sucoform 1SU-N0N5-	50Ω ① Non-Magnetic .085 Tin Plate Cu 8CT-N0N5-	50Ω MaxiFlex① (No QPL List) .085 Tin Plate Cu 08C-N0N5-
12	-0120C	\$69.49	\$30.75	\$33.13	\$30.65	\$32.72
24	-0240C	\$112.03	\$34.55	\$39.31	\$32.83	\$36.97
60	-0600C	\$154.57	\$38.35	\$45.49	\$35.01	\$41.22

① Silver Plated Copper Center Conductor ② Silver Plated Copper Clad Steel Center Conductor

10% Discount @ 25 pcs. up 4% Discount @ 10 pcs. up



RF Depot.com Inc.

Phone 856-488-2000 Fax 856-488-2020

N Female Bulkhead Jack x N Right Angle Male Plug

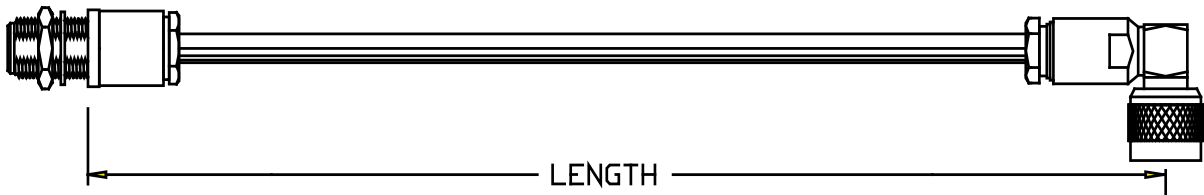

LENGTH IN INCHES	DASH NUMBER	50 Ω ^{③⑥⑦} RG 58C 1 shield 058-NCNF-	50 Ω ^{③⑦} RG 223 ^① 2 shields 223-NCNF-	50 Ω ^{②⑦} RG142B 2 shields 142-NCNF-	50 Ω ^{④①⑦} RG 400* 2 shields 400-NCNF-	50 Ω FSJ4-50B ^④ 1 shield .500" SUPERFLEX 50J-N2N5-	
Solder Center, Crimp and Clamp Outer							
12	-0120	\$36.66	\$41.65	\$42.48	\$43.18	\$94.55	
24	-0240	\$37.06	\$43.12	\$44.78	\$46.18	\$100.15	
36	-0360	\$37.46	\$44.59	\$47.08	\$49.18	\$105.75	
48	-0480	\$37.86	\$46.06	\$49.38	\$52.18	\$111.35	
60	-0600	\$38.26	\$47.53	\$51.68	\$55.18	\$116.95	
72	-0720	\$38.66	\$49.00	\$53.98	\$58.18	\$122.55	
Solder Center, Crimp Outer							
LENGTH IN INCHES	DASH NUMBER	50 Ω RG 174 ^{③⑤} 1 shield ^⑦ 174-NCNF-	50 Ω RG 316 ^{④②} 1 shield ^⑧ 316-NCNF-	50 Ω RD316 ^{④②⑦} 2 shields 31D-NCNF-	50 Ω RG188* ^{④②} 1 shield ^⑧ 188-NCNF-	50 Ω ^{②⑦④} RD188* 2 shields 88D-NCNF-	75 Ω RG179A ^{④②} 1 shield ^⑧ 179-NCNF-
12	-0120	\$47.37	\$47.78	\$48.98	\$48.13	\$50.65	\$47.86
24	-0240	\$47.61	\$48.43	\$50.83	\$49.13	\$54.17	\$48.59
36	-0360	\$47.85	\$49.08	\$52.68	\$50.13	\$57.69	\$49.32
48	-0480	\$48.09	\$49.73	\$54.53	\$51.13	\$61.21	\$50.05
60	-0600	\$48.33	\$50.38	\$56.38	\$52.13	\$64.73	\$50.78
72	-0720	\$48.57	\$51.03	\$58.23	\$53.13	\$68.25	\$51.51
Solder Center, Crimp Outer							
LENGTH IN INCHES	DASH NUMBER	50 Ω RG 8* ^{③③③} 1 shield 008-NCNF-	50 Ω ^③ RG 213 ^{③⑧} 1 shield 213-NCNF-	50 Ω RG 214 ^{③①} 2 shields ^⑦ 214-NCNF-	75 Ω ^{⑤⑧③} RG 59B ^③ 1 shield 059-NCNF-	93 Ω ^{⑤⑧③} RG 62 ^③ 1 shield 062-NCNF-	50 Ω ^④ RG 393 ^{①⑦} 2 shields 393-NCNF-
12	-0120	\$56.90	\$57.08	\$59.00	\$33.08	\$33.34	\$51.20
24	-0240	\$58.30	\$58.66	\$62.50	\$33.52	\$34.04	\$59.83
36	-0360	\$59.70	\$60.24	\$66.00	\$33.96	\$34.74	\$68.46
48	-0480	\$61.10	\$61.82	\$69.50	\$34.40	\$35.44	\$77.09
60	-0600	\$62.50	\$63.40	\$73.00	\$34.84	\$36.14	\$85.72
72	-0720	\$63.90	\$64.98	\$76.50	\$35.28	\$36.84	\$94.35
Color Designators (add letter to the end of the part number and add \$1.00 to price)							
Black - B		Blue - L		Brown - N		Gray - A	
Orange - O		Red - R		Violet - V		Green - G	
						White - W	

See Page B5 for Cable Characteristics

* Contact Factory for delivery, Consider new RD316 for (RD188)

10% Discount @ 25 pcs. up

4% Discount @ 10 pcs. up

‡ Brass Body Stainless Steel Nut



N Female Bulkhead Jack x SMA Male Plug

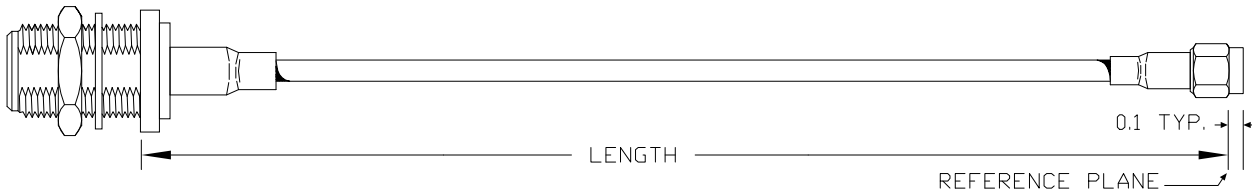

LENGTH IN INCHES	DASH NUMBER	50 Ω [Ⓞ] RG 58C [Ⓢ] 1 shield [Ⓣ] 058-MANF-	50 Ω ^{Ⓢ①} RG 223 2 shields [Ⓣ] 223-MANF-	50 Ω ^{Ⓢ②} RG142B 2 shields [Ⓣ] 142-MANF-	50 Ω ^{Ⓢ④} RG 400* ^{Ⓢ④} 2 shields [Ⓣ] 400-MANF-	
Solder Center, Crimp Outer						
12	-0120	\$33.43	\$39.45	\$40.28	\$40.98	
24	-0240	\$33.83	\$40.92	\$42.58	\$43.98	
36	-0360	\$34.23	\$42.39	\$44.88	\$46.98	
48	-0480	\$34.63	\$43.86	\$47.18	\$49.98	
60	-0600	\$35.03	\$45.33	\$49.48	\$52.98	
72	-0720	\$35.43	\$46.80	\$51.78	\$55.98	
Solder Center, Crimp Outer						
LENGTH IN INCHES	DASH NUMBER	50 Ω RG 174 ^{Ⓢ⑤} 1 shield [Ⓣ] 174-MANF-	50 Ω RG 316 ^{Ⓢ②} 1 shield [Ⓢ] 316-MANF-	50 Ω RD316 ^{Ⓢ②} 2 shields [Ⓣ] 31D-MANF-	50 Ω RG188* ^{Ⓢ②} 1 shield [Ⓢ] 188-MANF-	50 Ω RG 178B/U [Ⓢ] 1 shield [Ⓢ] 178-MANF-
12	-0120	\$36.39	\$36.80	\$36.45	\$37.15	\$31.94
24	-0240	\$36.63	\$37.45	\$38.30	\$38.15	\$32.68
36	-0360	\$36.87	\$38.10	\$40.15	\$39.15	\$33.42
48	-0480	\$37.11	\$38.75	\$42.00	\$40.15	\$34.16
60	-0600	\$37.35	\$39.40	\$43.85	\$41.15	\$34.90
72	-0720	\$37.59	\$40.05	\$45.70	\$42.15	\$35.64
Solder Center, Crimp Outer						
LENGTH IN INCHES	DASH NUMBER	50 Ω RG 8* ^{Ⓢ③⑥} 1 shield [Ⓢ] 008-MANF-	50 Ω RG 213 ^{Ⓢ③⑥} 1 shield [Ⓢ] 213-MANF-	50 Ω RG 214 ^{Ⓢ①} 2 shields [Ⓣ] 214-MANF-	50 Ω RG 393 ^{Ⓢ①⑦} 2 shields [Ⓣ] 393-MANF-	
12	-0120C	\$52.56	\$52.74	\$73.94	\$49.69	
24	-0240C	\$53.96	\$54.32	\$77.44	\$58.32	
36	-0360C	\$55.36	\$55.90	\$80.94	\$66.95	
48	-0480C	\$56.76	\$57.48	\$84.44	\$75.58	
60	-0600C	\$58.16	\$59.06	\$87.94	\$84.21	
72	-0720C	\$59.56	\$60.64	\$91.44	\$92.84	
Color Designators (add letter to the end of the part number and add \$1.00 to price)						
Black - B	Blue - L	Brown - N	Gray - A	Green - G	White - W	
Orange - O	Red - R	Violet - V	Yellow - Y			

See Page B5 for Cable Characteristics

* Contact Factory for delivery, Consider new RD316 for (RD188) 10% Discount @ 25 pcs. up 4% Discount @ 10 pcs. up



RF Depot.com Inc.

Phone 856-488-2000 Fax 856-488-2020

N Female Bulkhead Jack x SMA Male Plug

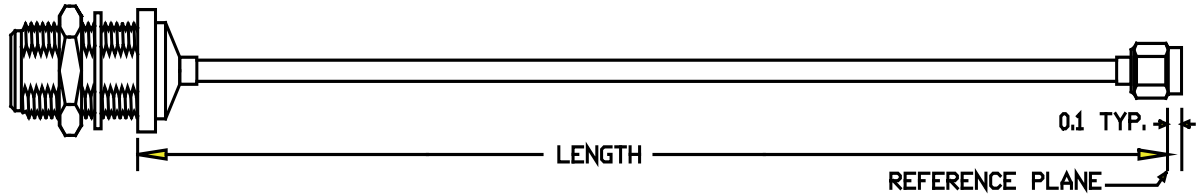

LENGTH IN INCHES	DASH NUMBER	50Ω RG 401① M17/129-RG401 .250 Cu Jacket 401-M0N5-	50Ω RG 401① No QPL List .250 Tin Plate Al 25A-M0N5-	50Ω RG 401② M17/129-00001 .250 Tin Plate Cu 2TS-M0N5-	50Ω MaxiFlex② No QPL List .250 Tin Plate Braid 25F-M0N5-	
.250" Diameter SEMIRIGID and Maxi Flex. Direct Solder Connectors						
12	-0120	\$97.62	\$98.56	\$102.81	\$97.62	
24	-0240	\$100.64	\$102.52	\$111.02	\$100.64	
36	-0360	\$103.66	\$106.48	\$119.23	\$103.66	
48	-0480	\$106.68	\$110.44	\$127.44	\$106.68	
60	-0600	\$109.70	\$114.40	\$135.65	\$109.70	
72	-0720	\$112.72	\$118.36	\$143.86	\$112.72	
.141" Diameter SEMIRIGID and Maxi Flex. Direct Solder Connectors						
LENGTH IN INCHES	DASH NUMBER	50Ω RG 402② M17/130-00004 .141 Cu Jacket 402-M0N5-	50Ω RG 402② M17/130-00005 .141 Tin Plate Cu 1TS-M0N5-	50Ω RG 402① M17/130-00009 .141 Tin Plate Al 1AT-M0N5-	50Ω MaxiFlex② No QPL List .141 Tin Pl 14F-M0N5-	50Ω RG 402② M17/130-00012 .141 Silver Pl 1SS-M0N5-
12	-0120	\$40.64	\$40.28	\$40.64	\$40.28	\$49.85
24	-0240	\$44.24	\$43.52	\$44.24	\$43.52	\$62.66
36	-0360	\$47.84	\$46.76	\$47.84	\$46.76	\$75.47
48	-0480	\$51.44	\$50.00	\$51.44	\$50.00	\$88.28
60	-0600	\$55.04	\$53.24	\$55.04	\$53.24	\$101.09
72	-0720	\$58.64	\$56.48	\$58.64	\$56.48	\$113.90
.085" Diameter SEMIRIGID and Maxi Flex. Direct Solder Connectors						
LENGTH IN INCHES	DASH NUMBER	50Ω RG 405② M17/133-00007 .085 Tin Plate Cu 405-M0N5-	50Ω RG 405② M17/133-00007 .085 Tin Plate Cu 8TS-M0N5-	50Ω RG 405② M17/133-00013 .085 Tin Plate Al 8AT-M0N5-	50Ω MaxiFlex② No QPL List .085 Tin Pl 08F-M0N5-	50Ω RG 405② M17/133-00016 .085 Silver Pl 8SS-M0N5-
12	-0120	\$40.01	\$40.01	\$40.95	\$41.24	\$45.20
24	-0240	\$43.03	\$43.03	\$44.91	\$45.49	\$53.41
36	-0360	\$46.05	\$46.05	\$48.87	\$49.74	\$61.62
48	-0480	\$49.07	\$49.07	\$52.83	\$53.99	\$69.83
60	-0600	\$52.09	\$52.09	\$56.79	\$58.24	\$78.04
72	-0720	\$55.11	\$55.11	CALL	\$62.49	CALL

①Silver Plated Copper Center Conductor ②Silver Plated Copper Clad Steel Center Conductor

10% Discount @ 25 pcs. up 4% Discount @ 10 pcs. up



N Female Bulkhead Jack x SMA Male Plug

Commercial

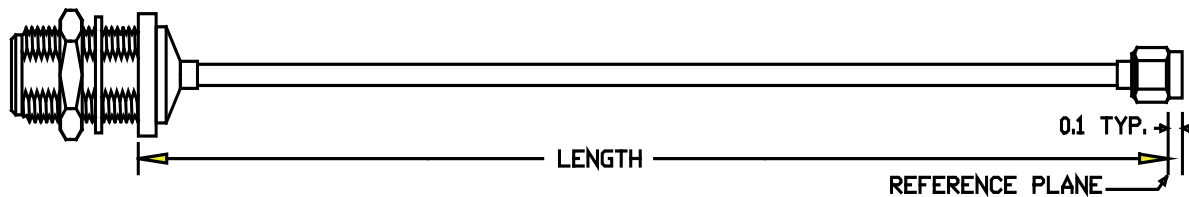

LENGTH IN INCHES	DASH NUMBER	50Ω RG 401① M17/129-RG401 .250 Cu Jacket 401-M0N5-	50Ω RG 401① No QPL List .250 Tin Plate Al 25A-M0N5-	50Ω RG 401② M17/129-00001 .250 Tin Plate Cu 2TS-M0N5-	50Ω MaxiFlex② No QPL List .250 Tin Plate Braid 25F-M0N5-	
.250" Diameter SEMIRIGID and Maxi Flex. Direct Solder Connectors						
24	-0240C	\$29.99	\$31.87	\$40.37	\$29.99	
36	-0360C	\$33.01	\$35.83	\$48.58	\$33.01	
48	-0480C	\$36.03	\$39.79	\$56.79	\$36.03	
60	-0600C	\$39.05	\$43.75	\$65.00	\$39.05	
72	-0720C	\$42.07	\$47.71	\$73.21	\$42.07	
.141" Diameter SEMIRIGID and Maxi Flex. Direct Solder Connectors						
LENGTH IN INCHES	DASH NUMBER	50Ω RG 402② M17/130-00004 .141 Cu Jacket 402-M0N5-	50Ω RG 402② M17/130-00005 .141 Tin Plate Cu 1TS-M0N5-	50Ω RG 402① M17/130-00009 .141 Tin Plate Al 1AT-M0N5-	50Ω MaxiFlex② No QPL List .141 Tin Pl 14F-M0N5-	50Ω RG 402② M17/130-00012 .141 Silver Pl 1SS-M0N5-
12	-0120C	\$22.18	\$21.82	\$22.18	\$21.82	\$31.39
24	-0240C	\$25.78	\$25.06	\$25.78	\$25.06	\$44.20
36	-0360C	\$29.38	\$28.30	\$29.38	\$28.30	\$57.01
48	-0480C	\$32.98	\$31.54	\$32.98	\$31.54	\$69.82
60	-0600C	\$36.58	\$34.78	\$36.58	\$34.78	\$82.63
72	-0720C	\$40.18	\$38.02	\$40.18	\$38.02	\$95.44
.085" Diameter SEMIRIGID and Maxi Flex. Direct Solder Connectors						
LENGTH IN INCHES	DASH NUMBER	50Ω RG 405② M17/133-00007 .085 Tin Plate Cu 405-M0N5-	50Ω RG 405② M17/133-00007 .085 Tin Plate Cu 8TS-M0N5-	50Ω RG 405② M17/133-00013 .085 Tin Plate Al 8AT-M0N5-	50Ω MaxiFlex② No QPL List .085 Tin Pl 08F-M0N5-	50Ω RG 405② M17/133-00016 .085 Silver Pl 8SS-M0N5-
12	-0120C	\$25.76	\$25.76	\$26.70	\$26.99	\$30.95
24	-0240C	\$28.78	\$28.78	\$30.66	\$31.24	\$39.16
36	-0360C	\$31.80	\$31.80	\$34.62	\$35.49	\$47.37
48	-0480C	\$34.82	\$34.82	\$38.58	\$39.74	\$55.58
60	-0600C	\$37.84	\$37.84	\$42.54	\$43.99	\$63.79
72	-0720C	\$40.86	\$40.86	CALL	\$48.24	CALL
Non-Magnetic Cable Assemblies. Direct Solder Connectors						
LTH IN INS	DASH NUM	50Ω① M17/130-00015 .141 Tin Plate Cu 1CT-M0N5-	50Ω MaxiFlex① Non-Magnetic .141 Tin Plate Cu 1CF-M0N5-	50Ω① Non-Magnetic .141 Sucoform 1SU-M0N5-	50Ω① Non-Magnetic .085 Tin Plate Cu 8CT-M0N5-	50Ω MaxiFlex① Non-Magnetic .085 Tin Plate Cu 08C-M0N5-
12	-0120C	\$61.12	\$22.38	\$24.76	\$24.92	\$26.99
24	-0240C	\$103.66	\$26.18	\$30.94	\$27.10	\$31.24
60	-0600C	\$273.82	\$41.38	\$55.66	\$35.82	\$48.24

①Silver Plated Copper Center Conductor ②Silver Plated Copper Clad Steel Center Conductor

10% Discount @ 25 pcs. up 4% Discount @ 10 pcs. up

N Female Bulkhead Jack x SMA Right Angle Male Plug

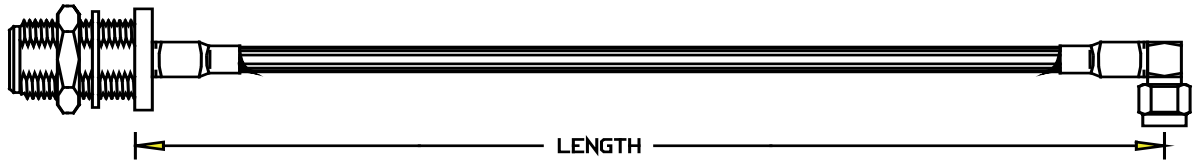

LENGTH IN INCHES	DASH NUMBER	50 Ω ^⑥ RG 58C ^③ 1 shield ^⑦ 058-MCNF-	50 Ω ^{③①} RG 223 2 shields ^⑦ 223-MCNF-	50 Ω ^{④②} RG142B ^⑦ 2 shields 142-MCNF-	50 Ω ^① RG 400 ^{✱④} 2 shields ^⑦ 400-MCNF-	50 Ω ^③ SIG 195 ^① 2 shields ^⑧ 19C-MCNF-	50 Ω ^③ LMR 195 ^① 2 shields ^⑧ 19M-MCNF-
Solder Center, Crimp Outer							
12	-0120	\$39.53	\$ 42.22	\$43.05	\$43.75	\$39.70	\$39.84
24	-0240	\$39.93	\$ 43.69	\$45.35	\$46.75	\$40.27	\$40.55
36	-0360	\$40.33	\$ 45.16	\$47.65	\$49.75	\$40.84	\$41.26
48	-0480	\$40.73	\$ 46.63	\$49.95	\$52.75	\$41.41	\$41.97
60	-0600	\$41.13	\$ 48.10	\$52.25	\$55.75	\$41.98	\$42.68
72	-0720	\$41.53	\$ 49.57	\$54.55	\$58.75	\$42.55	\$43.39
Solder Center, Crimp/Clamp Outer							
LENGTH IN INCHES	DASH NUMBER	50 Ω RG 174 ^{③⑤} 1 shield ^⑦ 174-MCNF-	50 Ω RG 316 ^{④②} 1 shield ^⑧ 316-MCNF-	50 Ω RD316 ^{④②} 2 shields ^⑦ 31D-MCNF-	50 Ω RG188 ^{✱④②} 1 shield ^⑧ 188-MCNF-	50 Ω RG 178B/U ^② 1 shield ^⑧ 178-MCNF-	
12	-0120E	\$43.85	\$44.26	\$45.05	\$44.61	\$37.14	
24	-0240E	\$44.09	\$44.91	\$46.90	\$45.61	\$37.88	
36	-0360E	\$44.33	\$45.56	\$48.75	\$46.61	\$38.62	
48	-0480E	\$44.57	\$46.21	\$50.60	\$47.61	\$39.36	
60	-0600E	\$44.81	\$46.86	\$52.45	\$48.61	\$40.10	
72	-0720E	\$45.05	\$47.51	\$54.30	\$49.61	\$40.84	
Solder Center, Crimp Outer, Low Loss Flexible							
LENGTH IN INCHES	DASH NUMBER	50 Ω ^{④⑨} SIG 400 ^① 2 shields 4LC-MCNF-	50 Ω ^① LMR 400 ^④ 2 shields ^⑧ 4LM-MCNF-	50 Ω ^{④⑨①} SIG 400DB 2 shields 4DC-MCNF-	50 Ω ^{④⑨①} LMR 400DB 2 shields 4LD-MCNF-	50 Ω ^{④⑨①} SIG 400FR 2 shields 4RC-MCNF-	50 Ω ^{④⑨①} LMR 400FR 2 shields 4LR-MCNF-
12	-0120C	\$30.86	\$31.38	\$30.98	\$31.60	\$30.98	\$31.90
24	-0240C	\$31.72	\$32.76	\$31.96	\$33.20	\$31.96	\$33.80
36	-0360C	\$32.58	\$34.14	\$32.94	\$34.80	\$32.94	\$35.70
48	-0480C	\$33.44	\$35.52	\$33.92	\$36.40	\$33.92	\$37.60
60	-0600C	\$34.30	\$36.90	\$34.90	\$38.00	\$34.90	\$39.50
72	-0720C	\$35.16	\$38.28	\$35.88	\$39.60	\$35.88	\$41.40
Color Designators (add letter to the end of the part number and add \$1.00 to price)							
Black - B		Blue - L		Brown - N		Gray - A	
Orange - O		Red - R		Violet - V		Green - G	
						White - W	

See Page B5 for Cable Characteristics

* Contact Factory for delivery, Consider new RD316 for (RD188)

10% Discount @ 25 pcs. up

4% Discount @ 10 pcs. up

N Female Bulkhead Jack x SMA Right Angle Male Plug

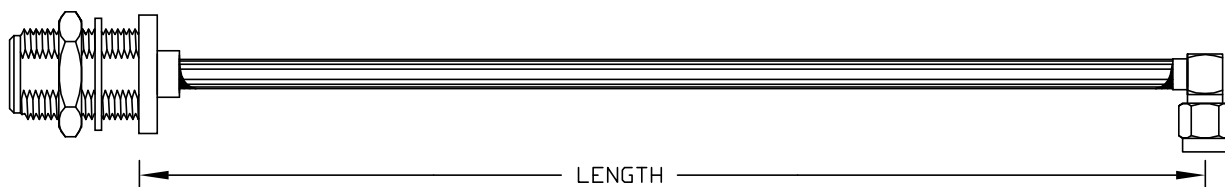

LTH IN INS	DASH NUM	50Ω RG 402 [Ⓢ] M17/130-00004 .141 Cu Jacket 402-M2N5-	50Ω RG 402 [Ⓢ] M17/130-00005 .141 Tin Pl Cu 1TS-M2N5-	50Ω RG 402 [Ⓢ] M17/130-00009 .141 Tin Pl Al 1AT-M2N5-	50Ω MaxiFlex [Ⓢ] No QPL List .141 Tin Pl 14F-M2N5-	50Ω RG 402 [Ⓢ] M17/130-00012 .141 Silver Pl 1SS-M2N5-	50 Ω MaxiFlex [Ⓢ] No QPL List .141 Tin Pl 14J-M2N5-
.141" Diameter SEMIRIGID and Maxi Flex. Direct Solder Connectors							
12	-0120	\$45.93	\$45.57	\$45.93	\$45.57	\$55.14	\$46.23
18	-0180	\$47.73	\$47.19	\$47.73	\$47.19	\$61.55	\$48.18
24	-0240	\$49.53	\$48.81	\$49.53	\$48.81	\$67.95	\$50.13
30	-0300	\$51.33	\$50.43	\$51.33	\$50.43	\$74.36	\$52.08
36	-0360	\$53.13	\$52.05	\$53.13	\$52.05	\$80.76	\$54.03
42	-0420	\$54.93	\$53.67	\$54.93	\$53.67	\$87.17	\$55.98
48	-0480	\$56.73	\$55.29	\$56.73	\$55.29	\$93.57	\$57.93
54	-0540	\$58.53	\$56.91	\$58.53	\$56.91	\$99.98	\$59.88
60	-0600	\$60.33	\$58.53	\$60.33	\$58.53	\$106.38	\$61.83
66	-0660	\$62.13	\$60.15	CALL	\$60.15	CALL	\$63.78
72	-0720	\$63.93	\$61.77	CALL	\$61.77	CALL	\$65.73
.085" Diameter SEMIRIGID and Maxi Flex. Direct Solder Connectors							
LTH IN INS	DASH NUM	50Ω RG 405 [Ⓢ] M17/133-00007 .085 Tin Pl Cu 405-M2N5-	50Ω RG 405 [Ⓢ] M17/133-00007 .085 Tin Pl Cu 8TS-M2N5-	50Ω RG 405 [Ⓢ] M17/133-00013 .085 Tin Pl Al 8AT-M2N5-	50Ω MaxiFlex [Ⓢ] No QPL List .085 Tin Pl 08F-M2N5-	50Ω RG 405 [Ⓢ] M17/133-00016 .085 Silver Pl 8SS-M2N5-	50 Ω MaxiFlex [Ⓢ] No QPL List .085 Tin Pl 08J-M2N5-
12	-0120	\$45.35	\$45.35	\$46.29	\$46.58	\$50.54	\$46.14
18	-0180	\$46.86	\$46.86	\$48.27	\$48.71	\$54.65	\$48.05
24	-0240	\$48.37	\$48.37	\$50.25	\$50.83	\$58.75	\$49.95
30	-0300	\$49.88	\$49.88	\$52.23	\$52.96	\$62.86	\$51.86
36	-0360	\$51.39	\$51.39	\$54.21	\$55.08	\$66.96	\$53.76
42	-0420	\$52.90	\$52.90	\$56.19	\$57.21	\$71.07	\$55.67
48	-0480	\$54.41	\$54.41	\$58.17	\$59.33	\$75.17	\$57.57
54	-0540	\$55.92	\$55.92	\$60.15	\$61.46	\$79.28	\$59.48
60	-0600	\$57.43	\$57.43	\$62.13	\$63.58	\$83.38	\$61.38
66	-0660	\$58.94	\$58.94	CALL	\$65.71	CALL	\$63.29
72	-0720	\$60.45	\$60.45	CALL	\$67.83	CALL	\$65.19

Ⓢ Silver Plated Copper Center Conductor Ⓢ Silver Plated Copper Clad Steel Center Conductor

10% Discount @ 25 pcs. up 4% Discount @ 10 pcs. up



RF Depot.com Inc.

Phone 856-488-2000 Fax 856-488-2020

N Female Bulkhead Jack x SMA Right Angle Male Plug

Commercial with Brass Connectors

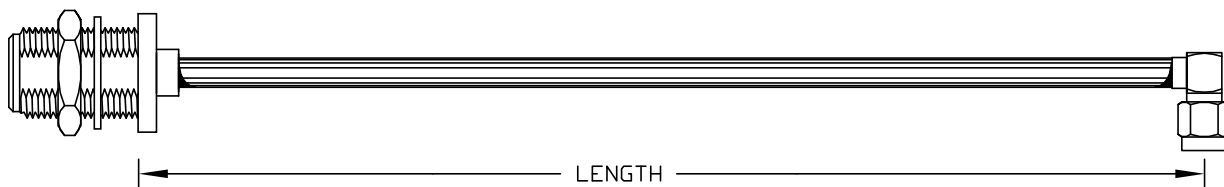

LENGTH IN INCHES	DASH NUMBER	50Ω RG 402 [Ⓢ] M17/130-00004 .141 Cu Jacket 402-M2N5-	50Ω RG 402 [Ⓢ] M17/130-00005 .141 Tin Pl Cu 1TS-M2N5-	50Ω RG 402 [Ⓢ] M17/130-00009 .141 Tin Pl Al 1AT-M2N5-	50ΩMaxiFlex [Ⓢ] No QPL List .141 Tin Pl 14F-M2N5-	50Ω RG 402 [Ⓢ] M17/130-00012 .141 Silver Pl 1SS-M2N5-
.141" Diameter SEMIRIGID and Maxi Flex. Direct Solder Connectors						
12	-0120C	\$34.02	\$33.66	\$34.02	\$33.66	\$42.23
24	-0240C	\$37.62	\$36.90	\$37.62	\$36.90	\$56.04
36	-0360C	\$41.22	\$40.14	\$41.22	\$40.14	\$68.85
48	-0480C	\$44.82	\$43.38	\$44.82	\$43.38	\$81.66
60	-0600C	\$48.42	\$46.62	\$48.42	\$46.62	\$94.47
72	-0720C	\$52.02	\$49.86	CALL	\$49.86	CALL
.085" Diameter SEMIRIGID and Maxi Flex. Direct Solder Connectors						
LENGTH IN INCHES	DASH NUMBER	50Ω RG 405 [Ⓢ] M17/133-00007 .085 Tin Pl Cu 405-M2N5-	50Ω RG 405 [Ⓢ] M17/133-00007 .085 Tin Pl Cu 8TS-M2N5-	50Ω RG 405 [Ⓢ] M17/133-00013 .085 Tin Pl Al 8AT-M2N5-	50ΩMaxiFlex [Ⓢ] No QPL List .085 Tin Pl 08F-M2N5-	50Ω RG 405 [Ⓢ] M17/133-00016 .085 Silver Pl 8SS-M2N5-
12	-0120C	\$32.18	\$32.18	\$33.12	\$33.41	\$37.37
24	-0240C	\$35.20	\$35.20	\$37.08	\$37.66	\$45.58
36	-0360C	\$38.22	\$38.22	\$41.04	\$41.91	\$53.79
48	-0480C	\$41.24	\$41.24	\$45.00	\$46.16	\$62.00
60	-0600C	\$44.26	\$44.26	\$48.96	\$50.41	\$70.21
72	-0720C	\$47.28	\$47.28	CALL	\$54.66	CALL
.141/.085" Diameter SEMIRIGID and Maxi Flex. Direct Solder Connectors (Non-Magnetic)						
LENGTH IN INCHES	DASH NUMBER	50Ω [Ⓢ] M17/130-00015 .141 Tin Pl Cu 1CT-M2N5-	50Ω MaxiFlex [Ⓢ] Non-Magnetic .141 Tin Pl Cu 1CF-M2N5-	50Ω [Ⓢ] Non-Magnetic .141 Sucoform 1SU-M2N5-	50Ω [Ⓢ] Non-Magnetic .085 Tin Pl Cu 8CT-M2N5-	50Ω MaxiFlex [Ⓢ] Non-Magnetic .085 Tin Pl Cu 08C-M2N5-
12	-0120C	\$72.96	\$34.22	\$36.60	\$32.60	\$34.67
24	-0240C	\$115.50	\$38.02	\$42.78	\$34.78	\$38.92
36	-0360C	\$158.04	\$41.82	\$48.96	\$36.96	\$43.17
48	-0480C	\$200.58	\$45.62	\$55.14	\$39.14	\$47.42
60	-0600C	\$243.12	\$49.42	\$61.32	\$41.32	\$51.67
72	-0720C	\$285.66	\$53.22	\$67.50	\$43.50	\$55.62

ⓈSilver Plated Copper Center Conductor ⓈSilver Plated Copper Clad Steel Center Conductor

10% Discount @ 25 pcs. up 4% Discount @ 10 pcs. up



N 4 Hole Panel Jack x SMA Male Plug

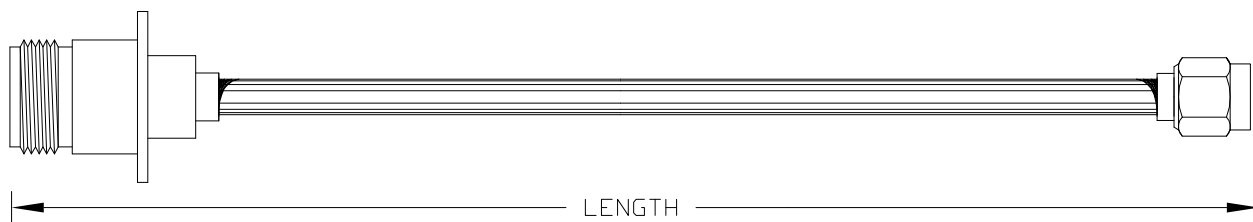

LTH IN INS	DASH NUM	50Ω RG 402 [Ⓞ] M17/130-00004 .141 Cu Jacket 402-M0N9-	50ΩMaxiFlex [Ⓞ] No QPL List .141 Tin Pl 14F-M0N9-	50Ω RG 405 [Ⓞ] M17/133-00007 .085 Tin Plate Cu 405-M0N9-	50Ω RG 405 [Ⓞ] M17/133-00007 .085 Tin Plate Cu 8TS-M0N9-	50Ω RG 405 [Ⓞ] M17/133-00013 .085 Tin Plate Al 8AT-M0N9-	50ΩMaxiFlex [Ⓞ] No QPL List .085 Tin Pl 08F-M0N9-
.141/.085" Diameter SEMIRIGID and Maxi Flex. Direct Solder Connectors							
12	-0120	\$33.64	\$33.28	\$35.50	\$35.50	\$36.44	\$36.73
24	-0240	\$37.24	\$36.52	\$38.52	\$38.52	\$40.40	\$40.98
36	-0360	\$40.84	\$39.76	\$41.54	\$41.54	\$44.36	\$45.23
48	-0480	\$44.44	\$43.00	\$44.56	\$44.56	\$48.32	\$49.48
60	-0600	\$48.04	\$46.24	\$47.58	\$47.58	\$52.28	\$53.73
72	-0720	\$51.64	\$49.48	\$50.60	\$50.60	CALL	\$57.98

N 4 Hole Panel Jack x SMA Right Angle Male Plug

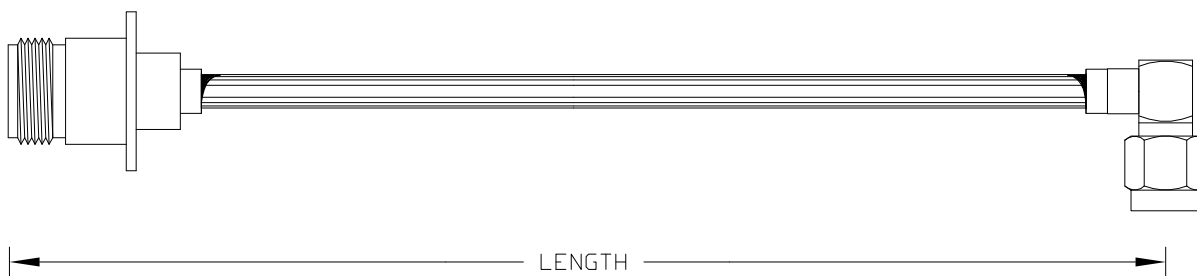

LTH IN INS	DASH NUM	50Ω RG 402 [Ⓞ] M17/130-00004 .141 Cu Jacket 402-M2N9-	50ΩMaxiFlex [Ⓞ] No QPL List .141 Tin Pl 14F-M2N9-	50Ω RG 405 [Ⓞ] M17/133-00007 .085 Tin Plate Cu 405-M2N9-	50Ω RG 405 [Ⓞ] M17/133-00007 .085 Tin Plate Cu 8TS-M2N9-	50Ω RG 405 [Ⓞ] M17/133-00013 .085 Tin Plate Al 8AT-M2N9-	50ΩMaxiFlex [Ⓞ] No QPL List .085 Tin Pl 08F-M2N9-
.141/.085" Diameter SEMIRIGID and Maxi Flex. Direct Solder Connectors							
12	-0120	\$38.20	\$37.84	\$36.43	\$36.43	\$37.37	\$37.66
24	-0240	\$41.80	\$41.08	\$39.45	\$39.45	\$41.33	\$41.91
36	-0360	\$45.40	\$44.32	\$42.47	\$42.47	\$45.29	\$46.16
48	-0480	\$49.00	\$47.56	\$45.49	\$45.49	\$49.25	\$50.41
60	-0600	\$52.60	\$50.80	\$48.51	\$48.51	\$53.21	\$54.66
72	-0720	\$56.20	\$54.04	\$51.53	\$51.53	CALL	\$58.91

[Ⓞ]Silver Plated Copper Center Conductor [Ⓞ]Silver Plated Copper Clad Steel Center Conductor

10% Discount @ 25 pcs. up 4% Discount @ 10 pcs. up



RF Depot.com Inc.

Phone 856-488-2000 Fax 856-488-2020

N Female Jack x N Male Plug

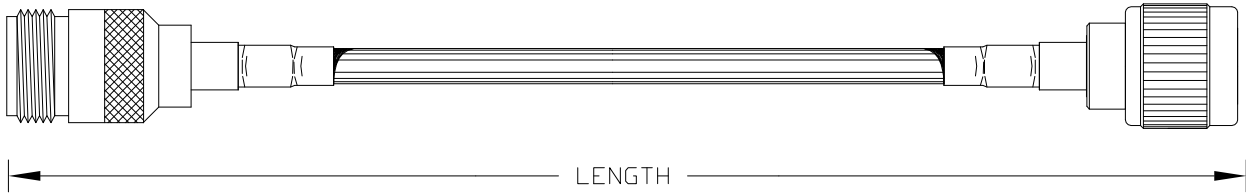

LENGTH IN INCHES	DASH NUMBER	50 Ω ^⑥ RG 58C ^⑤ 1 shield ^⑦ 058-N0N1-	50 Ω ^{⑤①} RG 223 2 shields ^⑦ 223-N0N1-	50 Ω ^④ RG142B ^② 2 shields ^⑦ 142-N0N1-	50 Ω ^① RG 400 ^{✕④} 2 shields ^⑦ 400-N0N1-	50 Ω FSJ4-50B ^④ 1 shield .500" SUPERFLEX 50J-N0N1-	
Solder Center, Clamp Outer							
12	-0120	\$37.32	\$38.39	\$39.22	\$39.92	\$77.95	
24	-0240	\$37.32	\$39.86	\$41.52	\$42.92	\$83.55	
36	-0360	\$38.12	\$41.33	\$43.82	\$45.92	\$89.15	
48	-0480	\$38.52	\$42.80	\$46.12	\$48.92	\$94.75	
60	-0600	\$38.92	\$44.27	\$48.42	\$51.92	\$100.35	
72	-0720	\$39.32	\$45.74	\$50.72	\$54.92	\$105.95	
Solder Center, Crimp Outer							
LENGTH IN INCHES	DASH NUMBER	50 Ω RG 174 ^{⑤⑥} 1 shield ^⑦ 174-NANB-	50 Ω RG 316 ^{④②} 1 shield ^⑧ 316-NANB-	50 Ω RD316 ^{④②} 2 shields ^⑦ 31D-NANB-	50 Ω RG188* ^{④②} 1 shield ^⑧ 188-NANB-	75 Ω RG179A ^{④②} 1 shield ^⑧ 179-NANB-	
12	-0120	\$31.18	\$31.59	\$32.79	\$31.94	\$31.67	
24	-0240	\$31.42	\$32.24	\$34.64	\$32.94	\$32.40	
36	-0360	\$31.66	\$32.89	\$36.49	\$33.94	\$33.13	
48	-0480	\$31.90	\$33.54	\$38.34	\$34.94	\$33.86	
60	-0600	\$32.14	\$34.19	\$40.19	\$35.94	\$34.59	
72	-0720	\$32.38	\$34.84	\$42.04	\$36.94	\$35.32	
Solder Center, Crimp and Clamp Outer							
LENGTH IN INCHES	DASH NUMBER	50 Ω ^⑤ RG 8* ^{③⑧} 1 shield ^⑧ 008-NANB-	50 Ω RG 213 ^{⑤③⑧} 1 shield ^⑧ 213-NANB-	50 Ω RG 214 ^{⑤①} 2 shields ^⑦ 214-NANB-	75 Ω ^{⑤‡} RG 59B ^⑤ 1 shield ^⑧ 059-N0NB-	93 Ω ^{⑤‡} RG 62 ^⑤ 1 shield ^⑧ 062-N0NB-	50 Ω ^④ RG 393 ^{①⑦} 2 shields ^⑦ 393-NANB-
12	-0120	\$31.40	\$31.58	\$37.70	\$26.71	\$26.97	\$42.83
24	-0240	\$32.80	\$33.16	\$41.20	\$27.15	\$27.67	\$51.46
36	-0360	\$34.20	\$34.74	\$44.70	\$27.59	\$28.37	\$60.09
48	-0480	\$35.60	\$36.32	\$48.20	\$28.03	\$29.07	\$68.72
60	-0600	\$37.00	\$37.90	\$51.70	\$28.47	\$29.77	\$77.35
72	-0720	\$38.40	\$39.48	\$55.20	\$28.91	\$30.47	\$85.98
Color Designators (add letter to the end of the part number and add \$1.00 to price)							
Black - B		Blue - L		Brown - N		Gray - A	
Orange - O		Red - R		Violet - V		Green - G	
						White - W	

See Page B5 for Cable Characteristics

* Contact Factory for delivery, Consider new RD316 for (RD188) 10% Discount @ 25 pcs. up 4% Discount @ 10 pcs. up

‡ Brass Body Stainless Steel Nut



N Female Jack x N Male Plug

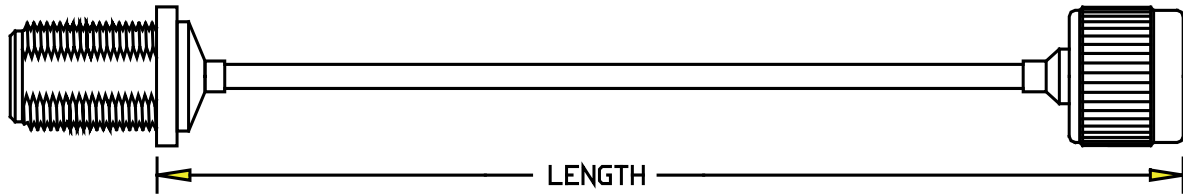

LENGTH IN INCHES	DASH NUMBER	50Ω RG 401① M17/129-RG401 .250 Cu Jacket 401-N0N1-	50Ω RG 401① No QPL List .250 Tin Plate Al 25A-N0N1-	50Ω RG 401② M17/129-00001 .250 Tin Plate Cu 2TS-N0N1-	50Ω MaxiFlex② No QPL List .250 Tin Plate Braid 25F-N0N1-	
.250" Diameter SEMIRIGID and Maxi Flex. Direct Solder Connectors						
12	-0120	\$100.01	\$100.95	\$105.20	\$100.01	
24	-0240	\$103.03	\$104.91	\$113.41	\$103.03	
36	-0360	\$106.05	\$108.87	\$121.62	\$106.05	
48	-0480	\$109.07	\$112.83	\$129.83	\$109.07	
60	-0600	\$112.09	\$116.79	\$138.04	\$112.09	
72	-0720	\$115.11	\$120.75	\$146.25	\$115.11	
.141" Diameter SEMIRIGID and Maxi Flex. Direct Solder Connectors						
LENGTH IN INCHES	DASH NUMBER	50Ω RG 402② M17/130-00004 .141 Cu Jacket 402-N0N1-	50Ω RG 402② M17/130-00005 .141 Tin Plate Cu 1TS-N0N1-	50Ω RG 402① M17/130-00009 .141 Tin Plate Al 1AT-N0N1-	50Ω MaxiFlex② No QPL List .141 Tin Pl 14F-N0N1-	50Ω RG 402② M17/130-00012 .141 Silver Pl 1SS-N0N1-
12	-0120	\$53.10	\$52.74	\$53.10	\$52.74	\$62.31
24	-0240	\$56.70	\$55.98	\$56.70	\$55.98	\$75.12
36	-0360	\$60.30	\$59.22	\$60.30	\$59.22	\$87.93
48	-0480	\$63.90	\$62.46	\$63.90	\$62.46	\$100.74
60	-0600	\$67.50	\$65.70	\$67.50	\$65.70	\$113.55
72	-0720	\$71.10	\$68.94	\$71.10	\$68.94	\$126.36
.085" Diameter SEMIRIGID and Maxi Flex. Direct Solder Connectors						
LENGTH IN INCHES	DASH NUMBER	50Ω RG 405② M17/133-00007 .085 Tin Plate Cu 405-N0N1-	50Ω RG 405② M17/133-00007 .085 Tin Plate Cu 8TS-N0N1-	50Ω RG 405② M17/133-00013 .085 Tin Plate Al 8AT-N0N1-	50Ω MaxiFlex② No QPL List .085 Tin Pl 08F-N0N1-	50Ω RG 405② M17/133-00016 .085 Silver Pl 8SS-N0N1-
12	-0120	\$52.47	\$52.47	\$53.41	\$53.70	\$57.66
24	-0240	\$55.49	\$55.49	\$57.37	\$57.95	\$65.87
36	-0360	\$58.51	\$58.51	\$61.33	\$62.20	\$74.08
48	-0480	\$61.53	\$61.53	\$65.29	\$66.45	\$82.29
60	-0600	\$64.55	\$64.55	\$69.25	\$70.70	\$90.50
72	-0720	\$67.57	\$67.57	CALL	\$74.95	CALL

①Silver Plated Copper Center Conductor ②Silver Plated Copper Clad Steel Center Conductor

10% Discount @ 25 pcs. up 4% Discount @ 10 pcs. up

N Female Jack x N Male Plug

Commercial

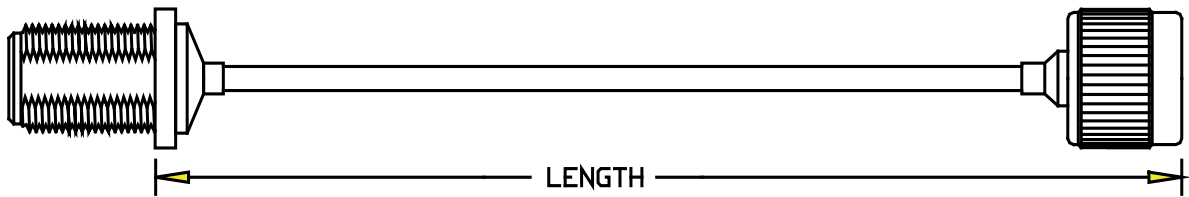

LENGTH IN INCHES	DASH NUMBER	50Ω RG 401① M17/129-RG401 .250 Cu Jacket 401-N0N1-	50Ω RG 401① No QPL List .250 Tin Plate Al 25A-N0N1-	50Ω RG 401② M17/129-00001 .250 Tin Plate Cu 2TS-N0N1-	50Ω MaxiFlex② No QPL List .250 Tin Plate Braid 25F-N0N1-	
.250" Diameter SEMIRIGID and Maxi Flex. Direct Solder Connectors						
12	-0120C	\$28.32	\$29.26	\$33.51	\$28.32	
24	-0240C	\$31.34	\$33.22	\$41.72	\$31.34	
36	-0360C	\$34.36	\$37.18	\$49.93	\$34.36	
48	-0480C	\$37.38	\$41.14	\$58.14	\$37.38	
60	-0600C	\$40.40	\$45.10	\$66.35	\$40.40	
72	-0720C	\$43.42	\$49.06	\$74.56	\$43.42	
.141" Diameter SEMIRIGID and Maxi-Flex. Direct Solder Connectors						
LENGTH IN INCHES	DASH NUMBER	50Ω RG 402② M17/130-00004 .141 Cu Jacket 402-N0N1-	50Ω RG 402② M17/130-00005 .141 Tin Plate Cu 1TS-N0N1-	50Ω RG 402② M17/130-00009 .141 Tin Plate Al 1AT-N0N1-	50ΩMaxiFlex② No QPL List .141 Tin Pl 14F-N0N1-	50Ω RG 402② M17/130-00012 .141 Silver Pl 1SS-N0N1-
12	-0120C	\$29.97	\$30.19	\$30.55	\$30.19	\$39.76
24	-0240C	\$32.99	\$33.43	\$45.15	\$33.43	\$52.57
36	-0360C	\$36.01	\$36.67	\$37.75	\$36.67	\$65.38
48	-0480C	\$39.03	\$39.91	\$41.35	\$39.91	\$78.19
60	-0600C	\$42.05	\$43.15	\$44.95	\$43.15	\$91.00
72	-0720C	\$45.07	\$46.39	\$48.55	\$46.39	\$103.81
.085" Diameter SEMIRIGID and Maxi Flex. Direct Solder Connectors						
LENGTH IN INCHES	DASH NUMBER	50Ω RG 405② M17/133-00007 .085 Tin Plate Cu 405-N0N1-	50Ω RG 405② M17/133-00007 .085 Tin Plate Cu 8TS-N0N1-	50Ω RG 405② M17/133-00013 .085 Tin Plate Al 8AT-N0N1-	50ΩMaxiFlex② No QPL List .085 Tin Pl 08F-N0N1-	50Ω RG 405② M17/133-00016 .085 Silver Pl 8SS-N0N1-
12	-0120C	\$31.49	\$31.49	\$32.43	\$32.72	\$36.68
24	-0240C	\$34.51	\$34.51	\$36.39	\$36.97	\$44.89
36	-0360C	\$37.53	\$37.53	\$40.35	\$41.22	\$53.10
48	-0480C	\$40.55	\$40.55	\$44.31	\$45.47	\$61.31
60	-0600C	\$43.57	\$43.57	\$48.27	\$49.72	\$69.52
72	-0720C	\$46.59	\$46.59	CALL	\$53.97	CALL

①Silver Plated Copper Center Conductor ②Silver Plated Copper Clad Steel Center Conductor

10% Discount @ 25 pcs. up 4% Discount @ 10 pcs. up



N Female Jack x QN Male Plug

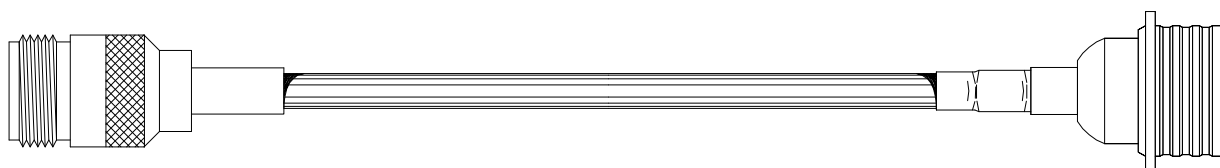

LENGTH IN INCHES	DASH NUMBER	50 Ω ^⑥ RG 58C ^③ 1 shield ^⑦ 058-NBQNA-	50 Ω ^{③①} RG 223 2 shields ^⑦ 223-NBQNA-	50 Ω ^{④②} RG142B 2 shields ^⑦ 142-NBQNA-	50 Ω ^① RG 400 ^{✕④} 2 shields ^⑦ 400-NBQNA-	50 Ω ^③ SIG 195 ^① 2 shields ^⑦ 19C-NBQNA-	50 Ω ^③ LMR 195 ^① 2 shields ^⑦ 19M-NBQNA-
Solder Center, Crimp Outer							
12	-0120	\$33.21	\$34.28	\$35.11	\$35.81	\$33.39	\$33.58
24	-0240	\$33.61	\$35.75	\$37.41	\$38.81	\$33.97	\$34.35
36	-0360	\$34.01	\$37.22	\$39.71	\$41.81	\$34.55	\$35.12
48	-0480	\$34.41	\$38.69	\$42.01	\$44.81	\$35.13	\$35.89
60	-0600	\$34.81	\$40.16	\$44.31	\$47.81	\$35.71	\$36.66
72	-0720	\$35.21	\$41.63	\$46.61	\$50.81	\$36.29	\$37.43
Solder Center, Crimp Outer							
LENGTH IN INCHES	DASH NUMBER	50 Ω ^⑤ RG 8* ^{③⑧} 1 shield 008-NBQNA-	50 Ω ^{③①③⑧} RG 213 ^{③①③⑧} 1 shield 213-NBQNA-	50 Ω ^{④②} RG 214 ^{④②} 2 shields ^⑦ 214-NBQNA-	50 Ω ^④ RG 393 ^{①⑦} 2 shields 393-NBQNA-	50 Ω ^{③①} SIG 195FR 2 shields ^⑦ 19F-NBQNA-	50 Ω ^{③①} LMR 195FR 2 shields ^⑦ 19R-NBQNA-
12	-0120	\$26.41	\$26.59	\$38.99	\$47.58	\$39.55	\$39.94
24	-0240	\$27.81	\$28.17	\$42.49	\$56.21	\$40.15	\$40.93
36	-0360	\$29.21	\$29.75	\$45.99	\$64.84	\$40.75	\$41.92
48	-0480	\$30.61	\$31.33	\$49.49	\$73.47	\$41.35	\$42.91
60	-0600	\$32.01	\$32.91	\$52.99	\$82.10	\$41.95	\$43.90
72	-0720	\$33.41	\$34.49	\$56.49	\$90.73	\$42.55	\$44.89
Solder Center, Crimp Outer							
LENGTH IN INCHES	DASH NUMBER	50 Ω ^{④④} SIG 400 ^① 2 shields 4LC-NBQNA-	50 Ω ^{④④} LMR 400 ^① 2 shields 4LM-NBQNA-	50 Ω ^{④④①} SIG 400DB 2 shields 4DC-NBQNA-	50 Ω ^{④④①} LMR 400DB 2 shields 4LD-NBQNA-	50 Ω ^{④④①} SIG 400UF 2 shields 4UC-NBQNA-	50 Ω ^{④④} LMR 400UF 2 shields ^⑦ 4UF-NBQNA-
12	-0120	\$39.81	\$40.33	\$39.93	\$40.55	\$39.93	\$40.85
24	-0240	\$40.67	\$41.71	\$40.91	\$42.15	\$40.91	\$42.75
36	-0360	\$41.53	\$43.09	\$41.89	\$43.75	\$41.89	\$44.65
48	-0480	\$42.39	\$44.47	\$42.87	\$45.35	\$42.87	\$46.55
60	-0600	\$43.25	\$45.85	\$43.85	\$46.95	\$43.85	\$48.45
72	-0720	\$44.11	\$47.23	\$44.83	\$48.55	\$44.83	\$50.35
Color Designators (add letter to the end of the part number and add \$1.00 to price)							
Black - B		Blue - L		Brown - N		Gray - A	
Orange - O		Red - R		Violet - V		Green - G	
						White - W	

See Page B5 for Cable Characteristics

* Contact Factory for delivery, Consider new RD316 for (RD188)

10% Discount @ 25 pcs. up

4% Discount @ 10 pcs. up



RF Depot.com Inc.

Phone 856-488-2000 Fax 856-488-2020

N Female Jack x QN Right Angle Male Plug

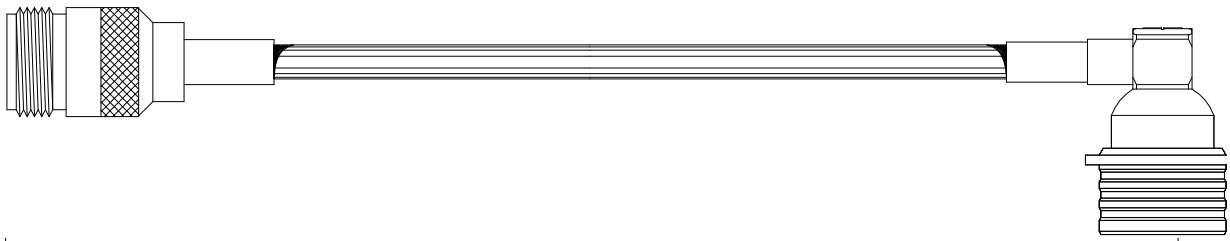

LENGTH IN INCHES	DASH NUM	50 Ω [Ⓞ] RG 58C [Ⓢ] 1 shield [Ⓣ] 058-NBQNC-	50 Ω ^{Ⓢ①} RG 223 2 shields [Ⓣ] 223-NBQNC-	50 Ω ^{Ⓢ②} RG142B 2 shields [Ⓣ] 142-NBQNC-	50 Ω ^{Ⓢ③} RG 400 ^{✕④} 2 shields 400-NBQNC-	50 Ω [Ⓢ] RG 213 ^{Ⓢ⑥} 1 shield 213-NBQNC-	50 Ω RG 214 ^{Ⓢ①} 2 shields [Ⓣ] 214-NBQNC-	50 Ω ^{Ⓢ④} RG 393 ^{Ⓢ⑦} 2 shields 393-NBQNC-
Solder Center, Crimp Outer								
12	-0120	\$36.09	\$38.36	\$39.19	\$39.89	\$29.33	\$42.66	\$54.55
24	-0240	\$36.49	\$39.83	\$41.49	\$42.89	\$30.91	\$46.16	\$63.18
36	-0360	\$36.89	\$41.30	\$43.79	\$45.89	\$32.49	\$49.66	\$71.81
48	-0480	\$37.29	\$42.77	\$46.09	\$48.89	\$34.07	\$53.16	\$80.44
60	-0600	\$37.69	\$44.24	\$48.39	\$51.89	\$35.65	\$56.66	\$89.07

N Female Jack x SMA Male Plug

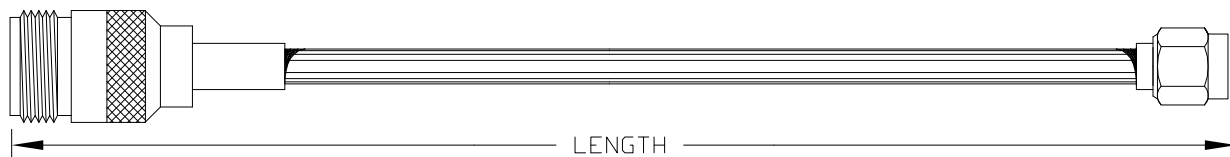

LENGTH IN INCHES	DASH NUM	50 Ω [Ⓞ] RG 58C [Ⓢ] 1 shield [Ⓣ] 058-MANB-	50 Ω ^{Ⓢ①} RG 223 2 shields [Ⓣ] 223-MANB-	50 Ω ^{Ⓢ②} RG142B 2 shields [Ⓣ] 142-MANB-	50 Ω ^{Ⓢ③} RG 400 ^{✕④} 2 shields 400-MANB-	75 Ω [Ⓢ] RG 59B ^{Ⓢ‡} 1 shield [Ⓢ] 059-MANB-	93 Ω [Ⓢ] RG 62 ^{Ⓢ‡} 1 shield [Ⓢ] 062-MANB-
Solder Center, Crimp Outer							
12	-0120	\$32.20	\$34.56	\$35.39	\$36.09	\$36.72	\$36.98
24	-0240	\$32.60	\$36.03	\$37.69	\$39.09	\$37.16	\$37.68
36	-0360	\$33.00	\$37.50	\$39.99	\$42.09	\$37.60	\$38.38
48	-0480	\$33.40	\$38.97	\$42.29	\$45.09	\$38.04	\$39.08
60	-0600	\$33.80	\$40.44	\$44.59	\$48.09	\$38.48	\$39.78
Solder Center, Crimp Outer							
LENGTH IN INCHES	DASH NUM	50 Ω RG 174 ^{Ⓢ⑤} 1 shield [Ⓣ] 174-MANB-	50 Ω RG 316 ^{Ⓢ②} 1 shield [Ⓢ] 316-MANB-	50 Ω RD316 ^{Ⓢ②} 2 shields [Ⓣ] 31D-MANB-	50 Ω RG188* ^{Ⓢ②} 1 shield [Ⓢ] 188-MANB-	50 Ω RG 213 ^{Ⓢ③⑥} 1 shield [Ⓢ] 213-MANB-	50 Ω RG 393 ^{Ⓢ④⑦} 2 shields 393-MANB-
12	-0120	\$24.85	\$25.26	\$24.91	\$25.61	\$30.47	\$87.49
24	-0240	\$25.09	\$25.91	\$26.76	\$26.61	\$32.05	\$96.12
36	-0360	\$25.33	\$26.56	\$28.61	\$27.61	\$33.63	\$104.75
48	-0480	\$25.57	\$27.21	\$30.46	\$28.61	\$35.21	\$113.38
60	-0600	\$25.81	\$27.86	\$32.31	\$29.61	\$36.79	\$122.02
Color Designators (add letter to the end of the part number and add \$1.00 to price)							
Black - B		Blue - L		Brown - N		Gray - A	
Orange - O		Red - R		Violet - V		Green - G	
						White - W	

See Page B5 for Cable Characteristics

‡ Brass Body Stainless Steel Nut

* Contact Factory for delivery, Consider new RD316 for (RD188)

10% Discount @ 25 pcs. up

4% Discount @ 10 pcs. up

 RF Depot.com Inc.

Phone 856-488-2000 Fax 856-488-2020

7850 Browning Rd. Pennsauken, NJ 08109

Online @ www.rfdepot.com

Toll Free 877-RF Depot

N Male Plug x N Male Plug

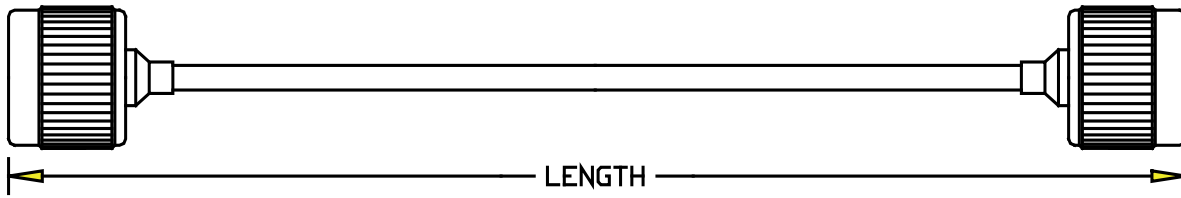

LTH IN INS	DASH NUM	50 Ω ^⑥ RG 58C ^③ 1 shield ^⑦ 058-NANA-	50 Ω ^{⑧①} RG 223 2 shields ^⑦ 223-NANA-	50 Ω ^{④②} RG142B 2 shields ^⑦ 142-NANA-	50 Ω ^{①⑦} RG 400* ^④ 2 shields ^⑦ 400-NANA-	50 Ω RG 178B/U ^② 1 shield ^⑧ 178-NANA-	50 Ω SF 142B ^② 3 shields ^⑧ S42-NANA-	50 Ω FSJ4-50B ^④ 1 shield .50" SUPERFLEX 50J-N0N0-
Solder Center, Crimp and Clamp Outer								
12	-0120	\$31.92	\$32.99	\$33.82	\$34.52	\$31.96	\$84.68	\$74.62
24	-0240	\$32.32	\$34.46	\$36.12	\$37.52	\$32.70	\$91.00	\$77.42
36	-0360	\$32.72	\$35.93	\$38.42	\$40.52	\$33.44	\$97.32	\$80.22
48	-0480	\$33.12	\$37.40	\$40.72	\$43.52	\$34.18	\$103.64	\$83.02
60	-0600	\$33.52	\$38.87	\$43.02	\$46.52	\$34.92	\$109.96	\$85.82
72	-0720	\$33.92	\$40.34	\$45.32	\$49.52	\$35.66	\$116.28	\$88.62
Solder Center, Crimp Outer								
LENGTH IN INCHES	DASH NUM	50 Ω RG 174 ^{⑤⑤} 1 shield ^⑦ 174-NANA-	50 Ω RG 316 ^{④②} 1 shield ^⑧ 316-NANA-	50 Ω RD316 ^{④②} 2 shields ^⑦ 31D-NANA-	50 Ω RG188* ^{④②} 1 shield ^⑧ 188-NANA-	50 Ω RG 196 ^② 1 shield ^⑧ 196-NANA-	75 Ω RG179A ^{④②} 1 shield ^⑧ 179-NANA-	
12	-0120	\$25.90	\$26.31	\$27.51	\$26.66	\$28.96	\$26.39	
24	-0240	\$26.14	\$26.96	\$29.36	\$27.66	\$29.70	\$27.12	
36	-0360	\$26.38	\$27.61	\$31.21	\$28.66	\$30.44	\$27.85	
48	-0480	\$26.62	\$28.26	\$33.06	\$29.66	\$31.18	\$28.58	
60	-0600	\$26.86	\$28.91	\$34.91	\$30.66	\$31.92	\$29.31	
72	-0720	\$27.10	\$29.56	\$36.76	\$31.66	\$32.66	\$30.04	
Solder Center, Crimp and Clamp Outer								
LENGTH IN INCHES	DASH NUM	50 Ω ^⑤ RG 8* ^{③③} 1 shield 008-N0N0-	50 Ω RG 213 ^{③③③} 1 shield 213-N0N0-	50 Ω RG 214 ^{④①} 2 shields ^⑦ 214-N0N0-	75 Ω ^⑤ RG 59B ^{④†} 1 shield ^⑧ 059-NANA-	93 Ω ^⑤ RG 62 ^{④†} 1 shield ^⑧ 062-NANA-	50 Ω RG 393 ^{④①⑦} 2 shields 393-NANA-	
12	-0120	\$27.44	\$37.62	\$32.20	\$26.06	\$26.32	\$37.33	
24	-0240	\$28.84	\$29.20	\$35.70	\$26.50	\$27.02	\$45.96	
36	-0360	\$30.24	\$30.78	\$39.20	\$26.94	\$27.72	\$54.59	
48	-0480	\$31.64	\$32.36	\$42.70	\$27.38	\$28.42	\$63.22	
60	-0600	\$33.04	\$33.94	\$46.20	\$27.82	\$29.12	\$71.85	
72	-0720	\$34.44	\$35.52	\$49.70	\$28.26	\$29.82	\$80.48	
Color Designators (add letter to the end of the part number and add \$1.00 to price)								
Black - B		Blue - L		Brown - N		Gray - A		Green - G
Orange - O		Red - R		Violet - V		Yellow - Y		White - W

See Page B5 for Cable Characteristics

* Contact Factory for delivery, Consider new RD316 for (RD188) 10% Discount @ 25 pcs. up 4% Discount @ 10 pcs. up

† Brass Body Stainless Steel Nut, ² Stainless Steel Connector, Cheaper Version Avail.-Contact Factory



RF Depot.com Inc.

Phone 856-488-2000 Fax 856-488-2020

N Male Plug x N Male Plug

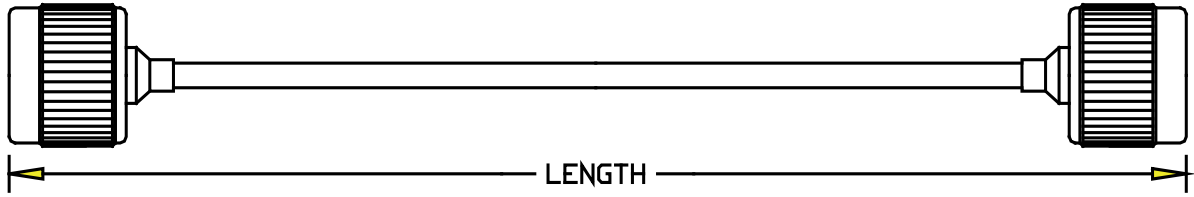

LTH IN INS	DASH NUM	50 Ω SIG 100 [Ⓞ] [Ⓜ] 2 shields [Ⓜ] 1LC-NANA-	50 Ω [Ⓜ] LMR 100 [Ⓞ] 2 shields [Ⓜ] 1LM-NANA-	50 Ω SIG 195 [Ⓞ] [Ⓜ] 2 shields [Ⓜ] 19C-NANA-	50 Ω LMR195 [Ⓞ] [Ⓜ] 2 shields [Ⓜ] 19M-NANA-	50 Ω SIG 200 [Ⓞ] [Ⓜ] 2 shields [Ⓜ] 2LC-NANA-	50 Ω LMR 200 [Ⓞ] [Ⓜ] 2 shields [Ⓜ] 2LM-NANA-	50 Ω [Ⓜ] SIG 240 [Ⓞ] 2 shields [Ⓜ] 24S-NANA-	50 Ω [Ⓜ] LMR 240 [Ⓞ] 2 shields [Ⓜ] 24L-NANA-
Solder Center, Crimp outer with Strain Relief									
48	-0480x	\$24.82	\$25.30	\$24.50	\$25.06	\$24.94	\$25.14	\$25.44	\$27.12
72	-0720x	\$25.90	\$26.62	\$25.64	\$26.48	\$26.30	\$26.60	\$26.64	\$29.16
96	-0960x	\$26.98	\$27.94	\$26.78	\$27.90	\$27.66	\$28.06	\$27.84	\$31.20
120	-1200x	\$28.06	\$29.26	\$27.92	\$29.32	\$29.02	\$29.52	\$29.04	\$33.24
144	-1440x	\$29.14	\$30.58	\$29.06	\$30.74	\$30.38	\$30.98	\$30.24	\$35.28
180	-1800x	\$30.76	\$32.56	\$30.77	\$32.87	\$32.42	\$33.17	\$32.04	\$38.34
240	-2400x	\$33.46	\$35.86	\$33.62	\$36.42	\$35.82	\$36.82	\$35.04	\$43.44
300	-3000X	\$36.16	\$39.16	\$36.47	\$39.97	\$39.22	\$40.47	\$38.04	\$48.54
Solder Center, Crimp and Clamp Outer									
LTH IN INS	DASH NUM	50 Ω [Ⓜ] SIG 300 [Ⓞ] 2 shields [Ⓜ] 3LC-NANA-	50 Ω [Ⓜ] LMR 300 [Ⓞ] 2 shields [Ⓜ] 3LM-NANA-	50 Ω [Ⓞ] SIG 400 [Ⓞ] 2 shields [Ⓜ] 4LC-NANA-	50 Ω [Ⓞ] LMR 400 [Ⓞ] 2 shields [Ⓜ] 4LM-NANA-	50 Ω [Ⓞ] SIG 400DB [Ⓞ] 2 shields [Ⓜ] 4DS-NANA-	50 Ω [Ⓞ] LMR400DB [Ⓞ] 2 shields [Ⓜ] 4LD-NANA-	50 Ω [Ⓞ] SIG 400FR [Ⓞ] 2 shields [Ⓜ] 4RS-NANA-	50 Ω [Ⓞ] LMR 400FR [Ⓞ] 2 shields [Ⓜ] 4LR-NANA-
48	-0480x	\$25.92	\$27.52	\$34.36	\$36.44	\$34.84	\$36.44	\$34.84	\$38.52
72	-0720x	\$27.36	\$29.76	\$36.08	\$39.20	\$36.80	\$39.20	\$36.80	\$42.32
96	-0960x	\$28.80	\$32.00	\$37.80	\$41.96	\$38.76	\$41.96	\$38.76	\$46.12
120	-1200x	\$30.24	\$34.24	\$39.52	\$44.72	\$40.72	\$44.72	\$40.72	\$49.92
144	-1440x	\$31.68	\$36.48	\$41.24	\$47.48	\$42.68	\$47.48	\$42.68	\$53.72
180	-1800x	\$33.84	\$39.84	\$43.82	\$51.62	\$45.62	\$51.62	\$45.62	\$59.42
240	-2400x	\$37.44	\$45.44	\$48.12	\$58.52	\$50.52	\$58.52	\$50.52	\$68.92
Solder Center, Crimp and Clamp Outer									
LTH IN INS	DASH NUM	50 Ω [Ⓞ] SIG 400UF [Ⓞ] 2 shields [Ⓜ] 4UC-NANA-	50 Ω [Ⓞ] LMR 400UF [Ⓞ] 2 shields [Ⓜ] 4UF-NANA-	50 Ω LMR 500 [Ⓞ] [Ⓞ] 2 shields [Ⓜ] 5LM-NANA-	50 Ω LMR 600 [Ⓞ] [Ⓞ] 2 shields [Ⓜ] 6LM-NANA-	50 Ω EF 142 ^① 2 shields [Ⓜ] 42E-NANA-	50 Ω SF 214 ^① 2 shields [Ⓜ] S21-NANA-	50 Ω SF 393 ^① 2 shields [Ⓜ] 93S-NANA-	
12	-0120	\$34.90	\$35.82	\$37.44	\$41.80	\$31.04	\$33.92	\$47.31	
24	-0240	\$35.88	\$37.72	\$39.24	\$43.80	\$33.56	\$42.45	\$68.92	
36	-0360	\$36.86	\$39.62	\$41.04	\$45.80	\$36.08	\$50.98	\$90.53	
48	-0480	\$37.84	\$41.52	\$42.84	\$47.80	\$38.60	\$59.51	\$112.14	
72	-0720	\$39.80	\$45.32	\$46.44	\$51.80	\$41.12	\$68.04	\$133.75	
Color Designators (add letter to the end of the part number and add \$1.00 to price)									
Black - B		Blue - L		Brown - N		Gray - A		Green - G	
Orange - O		Red - R		Violet - V		Yellow - Y		White - W	

See Page B5 for Cable Characteristics

* Contact Factory for delivery, Consider new RD316 for (RD188)

10% Discount @ 25 pcs. up

4% Discount @ 10 pcs. up



RF Depot.com Inc.

Phone 856-488-2000 Fax 856-488-2020

7850 Browning Rd. Pennsauken, NJ 08109

Online @ www.rfdepot.com

Toll Free 877-RF Depot

N Male Plug x N Male Plug

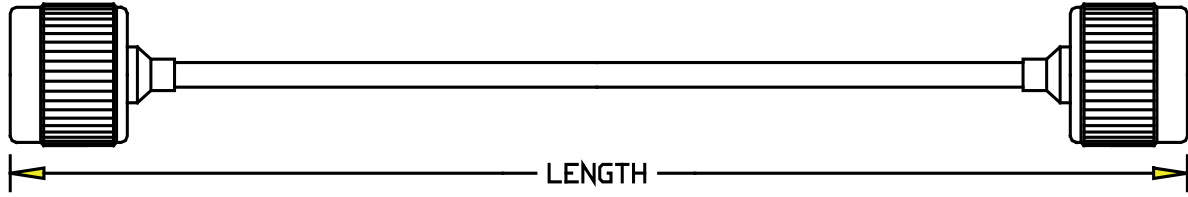

LENGTH IN INCHES	DASH NUMBER	50Ω RG 401Ⓞ M17/129-RG401 .250 Cu Jacket 401-N0N0-	50Ω RG 401Ⓞ No QPL List .250 Tin Plate Al 25A-N0N0-	50Ω RG 401Ⓞ M17/129-00001 .250 Tin Plate Cu 2TS-N0N0-	50Ω MaxiFlexⓄ No QPL List .250 Tin Plate Braid 25F-N0N0-	
.250" Diameter SEMIRIGID and Maxi Flex. Direct Solder Connectors						
12	-0120	\$72.74	\$73.68	\$77.93	\$72.74	
24	-0240	\$75.76	\$77.64	\$86.14	\$75.76	
36	-0360	\$78.78	\$81.60	\$94.35	\$78.78	
48	-0480	\$81.80	\$85.56	\$102.56	\$81.80	
60	-0600	\$84.82	\$89.52	\$110.77	\$84.82	
72	-0720	\$87.84	\$93.48	\$118.98	\$87.84	
.141" Diameter SEMIRIGID and Maxi Flex. Direct Solder Connectors						
LENGTH IN INCHES	DASH NUMBER	50Ω RG 402Ⓞ M17/130-00004 .141 Cu Jacket 402-N0N0-	50Ω RG 402Ⓞ M17/130-00005 .141 Tin Plate Cu 1TS-N0N0-	50Ω RG 402Ⓞ M17/130-00009 .141 Tin Plate Al 1AT-N0N0-	50Ω MaxiFlexⓄ No QPL List .141 Tin Pl 14F-N0N0-	50Ω RG 402Ⓞ M17/130-00012 .141 Silver Pl 1SS-N0N0-
12	-0120	\$55.60	\$55.24	\$55.60	\$55.24	\$64.81
24	-0240	\$59.20	\$58.48	\$59.20	\$58.48	\$77.62
36	-0360	\$62.80	\$61.72	\$62.80	\$61.72	\$90.43
48	-0480	\$66.40	\$64.96	\$66.40	\$64.96	\$103.24
60	-0600	\$70.00	\$68.20	\$70.00	\$68.20	\$116.05
72	-0720	\$73.60	\$71.44	\$73.60	\$71.44	\$128.86
.085" Diameter SEMIRIGID and Maxi Flex. Direct Solder Connectors						
LENGTH IN INCHES	DASH NUM	50Ω RG 405Ⓞ M17/133-00007 .085 Tin Plate Cu 405-N0N0-	50Ω RG 405Ⓞ M17/133-00007 .085 Tin Plate Cu 8TS-N0N0-	50Ω RG 405Ⓞ M17/133-00013 .085 Tin Plate Al 8AT-N0N0-	50Ω MaxiFlexⓄ No QPL List .085 Tin Pl 08F-N0N0-	50Ω RG 405Ⓞ M17/133-00016 .085 Silver Pl 8SS-N0N0-
12	-0120	\$54.92	\$54.92	\$55.86	\$56.15	\$60.11
24	-0240	\$57.94	\$57.94	\$59.82	\$60.40	\$68.32
36	-0360	\$60.96	\$60.96	\$63.78	\$64.65	\$76.53
48	-0480	\$63.98	\$63.98	\$67.74	\$68.90	\$84.74
60	-0600	\$61.00	\$61.00	\$71.70	\$73.15	\$92.95
72	-0720	\$70.02	\$70.02	CALL	\$77.40	CALL

ⓄSilver Plated Copper Center Conductor ⓄSilver Plated Copper Clad Steel Center Conductor

10% Discount @ 25 pcs. up 4% Discount @ 10 pcs. up

N Male Plug x N Male Plug Commercial

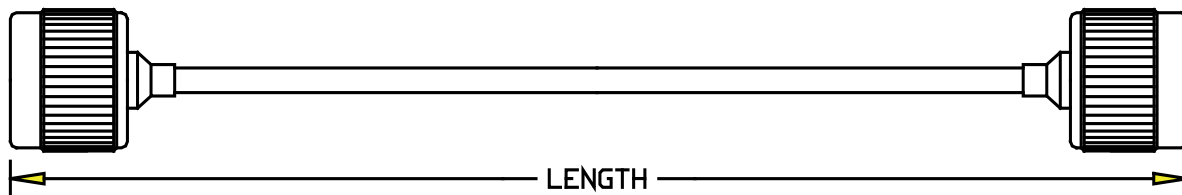

LENGTH IN INCHES	DASH NUMBER	50Ω RG 401 [Ⓛ] M17/129-RG401 .250 Cu Jacket 401-N0N0-	50Ω RG 401 [Ⓛ] No QPL List .250 Tin Plate Al 25A-N0N0-	50Ω RG 401 [Ⓢ] M17/129-00001 .250 Tin Plate Cu 2TS-N0N0-	50Ω MaxiFlex [Ⓢ] No QPL List .250 Tin Plate Braid 25F-N0N0-	
.250" Diameter SEMIRIGID and Maxi Flex. Direct Solder Connectors						
24	-0240C	\$30.58	\$32.46	\$40.96	\$30.58	
36	-0360C	\$33.60	\$36.42	\$49.17	\$33.60	
48	-0480C	\$36.62	\$40.38	\$57.38	\$36.62	
60	-0600C	\$39.64	\$44.34	\$65.59	\$39.64	
72	-0720C	\$42.66	\$48.30	\$73.80	\$42.66	
.141" Diameter SEMIRIGID and Maxi Flex. Direct Solder Connectors						
LENGTH IN INCHES	DASH NUMBER	50Ω RG 402 [Ⓢ] M17/130-00004 .141 Cu Jacket 402-N0N0-	50Ω RG 402 [Ⓢ] M17/130-00005 .141 Tin Plate Cu 1TS-N0N0-	50Ω RG 402 [Ⓛ] M17/130-00009 .141 Tin Plate Al 1AT-N0N0-	50Ω MaxiFlex [Ⓢ] No QPL List .141 Tin Pl 14F-N0N0-	50Ω RG 402 [Ⓢ] M17/130-00012 .141 Silver Pl 1SS-N0N0-
12	-0120C	\$24.90	\$24.54	\$24.90	\$24.54	\$34.11
24	-0240C	\$28.50	\$27.78	\$28.50	\$27.78	\$46.92
36	-0360C	\$32.10	\$31.02	\$32.10	\$31.02	\$59.73
48	-0480C	\$35.70	\$34.26	\$35.70	\$34.26	\$72.54
60	-0600C	\$39.30	\$37.50	\$39.30	\$37.50	\$85.35
72	-0720C	\$42.90	\$40.74	\$42.90	\$40.74	\$98.16
.085" Diameter SEMIRIGID and Maxi Flex. Direct Solder Connectors						
LENGTH IN INCHES	DASH NUM	50Ω RG 405 [Ⓢ] M17/133-00007 .085 Tin Plate Cu 405-N0N0-	50Ω RG 405 [Ⓢ] M17/133-00007 .085 Tin Plate Cu 8TS-N0N0-	50Ω RG 405 [Ⓢ] M17/133-00013 .085 Tin Plate Al 8AT-N0N0-	50Ω MaxiFlex [Ⓢ] No QPL List .085 Tin Pl 08F-N0N0-	50Ω RG 405 [Ⓢ] M17/133-00016 .085 Silver Pl 8SS-N0N0-
12	-0120C	\$27.76	\$27.76	\$28.70	\$28.99	\$32.95
24	-0240C	\$30.78	\$30.78	\$32.66	\$33.24	\$41.16
36	-0360C	\$33.80	\$33.80	\$36.62	\$37.49	\$39.37
48	-0480C	\$36.82	\$36.82	\$40.58	\$41.74	\$57.58
60	-0600C	\$39.84	\$39.84	\$44.54	\$45.99	\$65.79
72	-0720C	\$42.86	\$42.86	CALL	\$50.24	CALL
.047" Diameter SEMIRIGID and Maxi Flex. Direct Solder Connectors						
LENGTH IN INCHES	DASH NUM	50Ω [Ⓢ] M17/151-00001 .047 Cu Jacket 4CU-N0N0-	50Ω No QPL List .047 Tin Plate Al 4AT-N0N0-	50Ω [Ⓢ] M17/151-00002 .047 Tin Plate Cu 4TS-N0N0-	50Ω [Ⓢ] MaxiFlex No QPL List .047 Tin Pl 04F-N0N0-	50Ω [Ⓛ] Non-Magnetic .085 Tin Plate Cu 8CT-N0N0-
12	-0120C	\$28.58	\$30.03	\$28.58	\$29.28	\$29.96
24	-0240C	\$32.38	\$35.28	\$32.38	\$33.78	\$29.14
60	-0600C	\$43.78	\$51.03	\$43.78	\$47.28	\$35.68

Ⓛ Silver Plated Copper Center Conductor Ⓢ Silver Plated Copper Clad Steel Center Conductor

10% Discount @ 25 pcs. up 4% Discount @ 10 pcs. up

N Male Plug x N Right Angle Male Plug

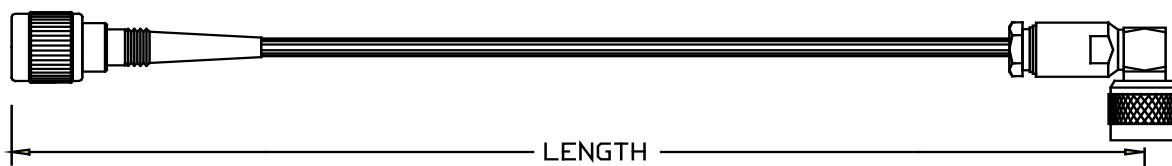

LENGTH IN INCHES	DASH NUMBER	50 Ω ^{⑥⑦} RG 58C ^⑤ 1 shield 058-NANC-	50 Ω ^{③①} RG 223 2 shields ^⑦ 223-NANC-	50 Ω ^{④②} RG142B 2 shields ^⑦ 142-NANC-	50 Ω ^{①⑦} RG 400 ^{✕④} 2 shields 400-NANC-	50 Ω FSJ4-50B 1 shield ^④ .500" SUPERFLEX 50J-N0N2-	
Solder Center, Crimp and Clamp Outer							
12	-0120	\$31.42	\$32.75	\$33.58	\$34.28	\$84.48	
24	-0240	\$31.82	\$34.22	\$35.88	\$37.28	\$89.78	
36	-0360	\$32.22	\$35.69	\$38.18	\$40.28	\$95.38	
48	-0480	\$32.62	\$37.16	\$40.48	\$43.28	\$100.98	
60	-0600	\$33.02	\$38.63	\$42.78	\$46.28	\$106.58	
72	-0720	\$33.42	\$40.10	\$45.08	\$49.28	\$112.18	
Solder Center, Crimp Outer							
LENGTH IN INCHES	DASH NUMBER	50 Ω RG 174 ^{⑤⑥} 1 shield ^⑦ 174-NANC-	50 Ω RG 316 ^{④②} 1 shield ^⑥ 316-NANC-	50 Ω RD316 ^{④②} 2 shields ^⑦ 31D-NANC-	50 Ω RG188 ^{✕④②} 1 shield ^⑥ 188-NANC-	75 Ω RG179A ^{④②} 1 shield ^⑥ 179-NANC-	
12	-0120	\$35.63	\$36.04	\$37.24	\$36.39	\$36.12	
24	-0240	\$35.87	\$36.69	\$39.09	\$37.39	\$36.85	
36	-0360	\$36.11	\$37.34	\$40.94	\$38.39	\$37.58	
48	-0480	\$36.35	\$37.99	\$42.79	\$39.39	\$38.31	
60	-0600	\$36.59	\$38.64	\$44.64	\$40.39	\$39.04	
72	-0720	\$36.83	\$39.29	\$46.49	\$41.39	\$39.77	
Solder Center, Crimp Outer							
LENGTH IN INCHES	DASH NUMBER	50 Ω ^③ RG 8 ^{*③⑧} 1 shield 008-NANC-	50 Ω RG 213 ^{③③⑧} 1 shield 213-NANC-	50 Ω RG 214 ^{③①} 2 shields ^⑦ 214-NANC-	75 Ω ^⑤ RG 59B ^{③‡} 1 shield ^⑧ 059-NANC-	93 Ω ^⑤ RG 62 ^{③‡} 1 shield ^⑧ 062-NANC-	50 Ω RG 393 ^{④①⑦} 2 shields 393-NANC-
12	-0120	\$32.28	\$32.46	\$33.04	\$27.70	\$27.96	\$38.17
24	-0240	\$33.68	\$34.04	\$36.54	\$28.14	\$28.66	\$46.80
36	-0360	\$35.08	\$35.62	\$40.04	\$28.58	\$29.36	\$55.43
48	-0480	\$36.48	\$37.20	\$43.54	\$29.02	\$30.06	\$64.06
60	-0600	\$37.88	\$38.78	\$47.04	\$29.46	\$30.76	\$72.69
72	-0720	\$39.28	\$40.36	\$50.54	\$29.90	\$31.46	\$81.32
Color Designators (add letter to the end of the part number and add \$1.00 to price)							
Black - B		Blue - L		Brown - N		Gray - A	
Orange - O		Red - R		Violet - V		Green - G	
						White - W	

See Page B5 for Cable Characteristics

* Contact Factory for delivery, Consider new RD316 for (RD188) 10% Discount @ 25 pcs. up 4% Discount @ 10 pcs. up

‡ Brass Body Stainless Steel Nut



RF Depot.com Inc.

Phone 856-488-2000 Fax 856-488-2020

N Male Plug x N Right Angle Male Plug



LENGTH IN INCHES	DASH NUM	50 Ω ^{③③} SIG 100 ^③ 2 shields 1LC-NANC-	50 Ω ^{③③} LMR 100 ^③ 2 shields 1LM-NANC-	50 Ω ^③ SIG 195 ^③ 2 shields ^③ 19C-NANC-	50 Ω ^③ LMR 195 ^③ 2 shields ^③ 19M-NANC-	50 Ω ^{③③} SIG 200 ^③ 2 shields 2LC-NANC-	50 Ω ^{③③} LMR 200 ^③ 2 shields 2LM-NANC-	50 Ω ^{③③} SIG 240 ^③ 2 shields 24C-NANC-	50 Ω ^{③③} LMR 240 ^③ 2 shields 24L-NANC-
Solder Center, Crimp Outer, Low Loss Flexible									
24	-0240	\$30.60	\$30.84	\$26.83	\$27.11	\$34.93	\$35.03	\$28.76	\$29.60
60	-0600	\$32.22	\$32.82	\$28.54	\$29.24	\$36.97	\$37.22	\$30.56	\$32.66
120	-1200	\$34.92	\$36.12	\$31.39	\$32.79	\$40.37	\$40.87	\$33.56	\$37.76
180	-1800	\$37.62	\$39.42	\$34.24	\$36.34	\$43.77	\$44.52	\$36.56	\$42.86
240	-2400	\$40.32	\$42.72	\$37.09	\$39.89	\$47.17	\$48.17	\$39.56	\$47.96
300	-3000	\$43.02	\$46.02	\$39.94	\$43.44	\$50.57	\$51.82	\$42.56	\$53.06
Solder Center, Crimp Outer, Low Loss Flexible									
LENGTH IN INCHES	DASH NUM	50 Ω ^{③③} SIG 300 ^③ 2 shields 3LC-NANC-	50 Ω ^{③③} LMR 300 ^③ 2 shields 3LM-NANC-	50 Ω ^{④④} SIG 400 ^③ 2 shields 4LC-NANC-	50 Ω ^{④④} LMR 400 ^③ 2 shields 4LM-NANC-	50 Ω ^{④④} ^③ SIG 400DB 2 shields 4DC-NANC-	50 Ω ^{④④} ^③ LMR 400DB 2 shields 4LD-NANC-	50 Ω ^{④④} ^③ SIG 400FR 2 shields 4RC-NANC-	50 Ω ^{④④} ^③ LMR 400FR 2 shields 4LR-NANC-
24	-0240	\$40.24	\$41.04	\$35.19	\$36.67	\$35.43	\$36.67	\$35.43	\$37.27
60	-0600	\$42.40	\$44.40	\$37.77	\$41.47	\$38.37	\$41.47	\$38.37	\$42.97
120	-1200	\$46.00	\$50.00	\$42.07	\$49.47	\$43.27	\$49.47	\$43.27	\$52.47
180	-1800	\$49.60	\$55.60	\$46.37	\$57.47	\$48.17	\$57.47	\$48.17	\$61.97
240	-2400	\$53.20	\$61.20	\$50.67	\$65.47	\$53.07	\$65.47	\$53.07	\$71.47
300	-3000	\$56.80	\$66.80	\$54.97	\$73.47	\$57.97	\$73.47	\$57.97	\$80.97
Solder Center, Crimp Outer, Low Loss Flexible									
LENGTH IN INCHES	DASH NUM	50 Ω ^{④④} ^③ SIG 400UF 2 shields 4UC-NANC-	50 Ω ^{④④} ^③ LMR 400UF 2 shields ^③ 4UF-NANC-	50 Ω ^{③③} LMR 500 ^③ 2 shields 5LM-NANC-	50 Ω ^{④④} ^③ LMR 600 2 shields 6LM-NANC-	50 Ω EF 142 ^① 2 shields ^⑦ 42E-NANC-	50 Ω SF 142B ^{②③} 3 shields S42-NANC-	50 Ω SF 214 ^{①③} 2 shields S21-NANC-	50 Ω SF 393 ^{①③} 2 shields 93S-NANC-
24	-0240	\$35.43	\$37.27	\$83.92	\$39.33	\$49.80	\$134.25	\$36.54	\$46.80
60	-0600	\$38.37	\$42.97	\$89.32	\$45.33	\$82.08	\$153.21	\$47.04	\$72.69
120	-1200	\$43.27	\$52.47	\$98.32	\$55.33	\$135.88	\$184.81	\$64.54	\$115.84
180	-1800	\$48.17	\$61.97	\$107.32	\$65.33	\$189.68	\$216.41	\$82.04	\$158.99
240	-2400	\$53.07	\$71.47	\$116.32	\$75.33	\$243.48	\$248.01	\$99.54	\$202.14
300	-3000	\$57.97	\$80.97	\$125.32	\$85.33	\$297.28	\$279.61	\$117.04	\$245.29
Color Designators (add letter to the end of the part number and add \$1.00 to price)									
Black - B		Blue - L		Brown - N		Gray - A		Green - G	
Orange - O		Red - R		Violet - V		Yellow - Y		White - W	

See Page B5 for Cable Characteristics

* Contact Factory for delivery, Consider new RD316 for (RD188)

10% Discount @ 25 pcs. up

4% Discount @ 10 pcs. up

N Male Plug x QN Female Bulkhead Jack

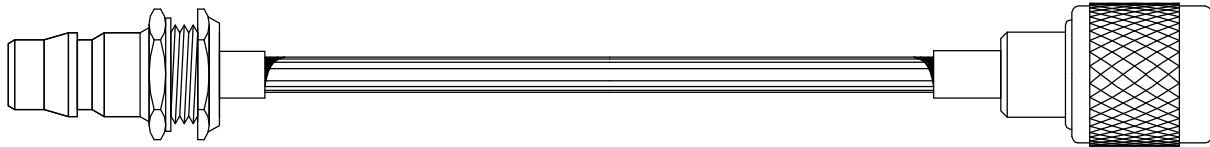

← LENGTH →

LENGTH IN INCHES	DASH NUMBER	50 Ω ^⑦ RG 58C ^⑥ 1 shield 058-NAQNF-	50 Ω ^{②①} RG 223 2 shields ^⑦ 223-NAQNF-	50 Ω ^{④②} RG142B 2 shields ^⑦ 142-NAQNF-	50 Ω ^{①⑦} RG 400 ^{✕④} 2 shields 400-NAQNF-		
Solder Center, Crimp Outer							
12	-0120	\$34.02	\$35.09	\$35.92	\$36.62		
18	-0180	\$34.22	\$35.83	\$37.07	\$38.12		
24	-0240	\$34.42	\$36.56	\$38.22	\$39.62		
30	-0300	\$34.62	\$37.30	\$39.37	\$41.12		
36	-0360	\$34.82	\$38.03	\$40.52	\$42.62		
42	-0420	\$35.02	\$38.77	\$41.67	\$44.12		
48	-0480	\$35.22	\$39.50	\$42.82	\$45.62		
54	-0540	\$35.42	\$40.24	\$43.97	\$47.12		
60	-0600	\$35.62	\$40.97	\$45.12	\$48.62		
66	-0660	\$35.82	\$41.71	\$46.27	\$50.12		
72	-0720	\$36.02	\$42.44	\$47.42	\$51.62		
Solder Center, Crimp Outer							
LENGTH IN INCHES	DASH NUMBER	50 Ω RG 8* ^{⑥③⑧} 1 shield 008-NAQNF-	50 Ω RG 213 ^{⑥③⑧} 1 shield 213-NAQNF-	50 Ω RG 214 ^{⑥①} 2 shields ^⑦ 214-NAQNF-	50 Ω ^{①⑦} RG 225 2 shield 225-NAQNF-	50 Ω ^③ SIG 195 ^⑥ 2 shields ^⑦ 19C-NAQNF-	50 Ω ^③ LMR 195 ^⑥ 2 shields ^⑦ 19M-NAQNF-
12	-0120	\$31.63	\$31.81	\$38.29	\$53.33	\$34.19	\$34.33
18	-0180	\$32.33	\$32.60	\$40.04	\$62.60	\$34.48	\$34.69
24	-0240	\$33.03	\$33.39	\$41.79	\$71.87	\$34.76	\$35.04
30	-0300	\$33.73	\$34.18	\$43.54	\$81.14	\$35.05	\$35.40
36	-0360	\$34.43	\$34.97	\$45.29	\$90.41	\$35.33	\$35.75
42	-0420	\$35.13	\$35.76	\$47.04	\$99.68	\$35.62	\$36.11
48	-0480	\$35.83	\$36.55	\$48.79	\$108.95	\$35.90	\$36.46
54	-0540	\$36.53	\$37.34	\$50.54	\$118.22	\$36.19	\$36.82
60	-0600	\$37.23	\$38.13	\$52.29	\$127.49	\$36.47	\$37.17
66	-0660	\$37.93	\$38.92	\$54.04	\$136.76	\$36.76	\$37.53
72	-0720	\$38.63	\$39.71	\$55.79	\$146.03	\$37.04	\$37.88
Color Designators (add letter to the end of the part number and add \$1.00 to price)							
Black - B		Blue - L		Brown - N		Gray - A	
Orange - O		Red - R		Violet - V		Green - G	
						White - W	

See Page B5 for Cable Characteristics

* Contact Factory for delivery, Consider new RD316 for (RD188) 10% Discount @ 25 pcs. up 4% Discount @ 10 pcs. up



RF Depot.com Inc.

Phone 856-488-2000 Fax 856-488-2020

N Male Plug x QN Female Jack

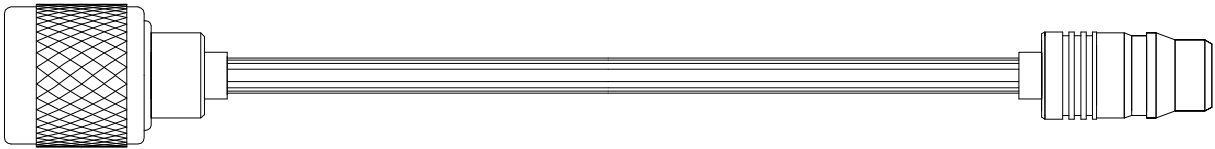

←————— LENGTH —————→

LENGTH IN INCHES	DASH NUMBER	50Ω RG 401① M17/129-RG401 .250 Cu Jacket 401-NAQNA-	50Ω MaxiFlex② No QPL List .250 Tin Plate Braid 25F-NAQNA-	50Ω RG 401② M17/129-00001 .250 Tin Plate Cu 2TS-NAQNA-	50Ω MaxiFlex② No QPL List .250 Tin Plate Braid 25F-NAQNA-
.250" Diameter SEMIRIGID and Maxi Flex. Direct Solder Connectors					
12	-0120	\$59.80	\$59.80	\$64.99	\$59.80
24	-0240	\$62.82	\$62.82	\$73.20	\$62.82
36	-0360	\$65.84	\$65.84	\$81.41	\$65.84
48	-0480	\$68.86	\$68.86	\$89.62	\$68.86
60	-0600	\$71.88	\$71.88	\$97.83	\$71.88
72	-0720	\$74.90	\$74.90	\$106.04	\$74.90
.141" Diameter SEMIRIGID and Maxi Flex. Direct Solder Connectors					
LENGTH IN INCHES	DASH NUMBER	50Ω RG 402② M17/130-00004 .141 Cu Jacket 402-NAQNA-	50Ω RG 402② M17/130-00005 .141 Tin Plate Cu 1TS-NAQNA-	50Ω RG 402① M17/130-00009 .141 Tin Plate Al 1AT-NAQNA-	
12	-0120	\$47.85	\$47.49	\$47.85	
24	-0240	\$51.45	\$50.73	\$51.45	
36	-0360	\$55.05	\$53.97	\$55.05	
48	-0480	\$58.65	\$57.21	\$58.65	
60	-0600	\$62.25	\$60.45	\$62.25	
72	-0720	\$65.85	\$63.69	\$65.85	
.141" Diameter SEMIRIGID and Maxi Flex. Direct Solder Connectors					
LENGTH IN INCHES	DASH NUMBER	50Ω RG 402② M17/130-00012 .141 Silver Plate Cu 1SS-NAQNA-	50Ω MaxiFlex② No QPL List .141 Tin Plate Braid 14F-NAQNA-	50 Ω MaxiFlex② No QPL List .141 Tin Plate Braid 14J-NAQNA-	
12	-0120	\$57.06	\$47.49	\$48.15	
24	-0240	\$69.87	\$50.73	\$52.05	
36	-0360	\$82.68	\$53.97	\$55.95	
48	-0480	\$95.49	\$57.21	\$59.85	
60	-0600	\$108.30	\$60.45	\$63.75	
72	-0720	\$121.11	\$63.69	\$67.65	

①Silver Plated Copper Center Conductor ②Silver Plated Copper Clad Steel Center Conductor

10% Discount @ 25 pcs. up 4% Discount @ 10 pcs. up

N Male Plug x QN Male Plug

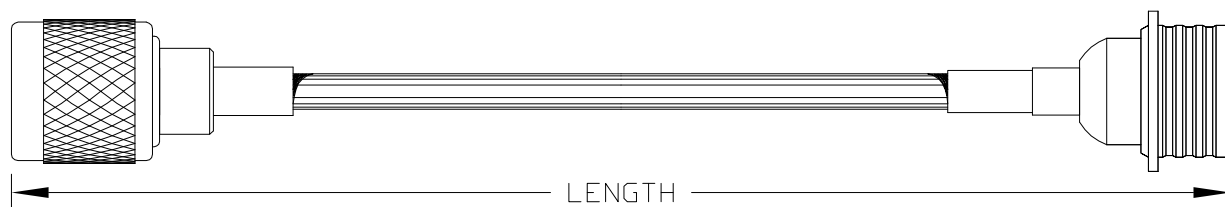

LTH IN INS	DASH NUM	50 Ω ^⑦ RG 58C ^③ 1 shield 058-NAQNA-	50 Ω ^{③①} RG 223 2 shields ^⑦ 223-NAQNA-	50 Ω ^{④②} RG142B 2 shields ^⑦ 142-NAQNA-	50 Ω ^{①⑦} RG 400* ^④ 2 shields 400-NAQNA-	50 Ω SF 142B ^{②⑨} 3 shields S42-NAQNA-	50 Ω ^③ SIG 195 ^① 2 shields ^⑨ 19C-NAQNA-	50 Ω ^③ LMR 195 ^① 2 shields ^⑨ 19M-NAQNA-
Solder Center, Crimp Outer								
12	-0120	\$29.20	\$31.80	\$31.10	\$31.80	\$35.12	\$29.37	\$29.51
24	-0240	\$29.60	\$34.80	\$33.40	\$34.80	\$41.44	\$29.94	\$30.22
36	-0360	\$30.00	\$37.80	\$35.70	\$37.80	\$47.76	\$30.51	\$30.93
48	-0480	\$30.40	\$40.80	\$38.00	\$40.80	\$54.08	\$31.08	\$31.64
60	-0600	\$30.80	\$43.80	\$40.30	\$43.80	\$60.40	\$31.65	\$32.35
72	-0720	\$31.20	\$46.80	\$42.60	\$46.80	\$66.72	\$32.22	\$33.06
Solder Center, Crimp Outer								
LENGTH IN INCHES	DASH NUM	50 Ω ^⑤ RG 8* ^{③⑧} 1 shield 008-NAQNA-	50 Ω RG 213 ^{③③⑧} 1 shield 213-NAQNA-	50 Ω RG 214 ^{⑤①} 2 shields ^⑦ 214-NAQNA-	50 Ω ^④ RG 393 ^{①⑦} 2 shields 393-NAQNA-	50 Ω ^③ SIG 195FR ^① 2 shields ^⑨ 19F-NAQNA-	50 Ω ^③ LMR 195FR ^① 2 shields ^⑨ 19R-NAQNA-	
12	-0120	\$27.06	\$27.24	\$30.49	\$39.08	\$29.37	\$29.51	
24	-0240	\$28.46	\$28.82	\$33.99	\$47.71	\$29.94	\$30.22	
36	-0360	\$29.86	\$30.40	\$37.49	\$56.34	\$30.51	\$30.93	
48	-0480	\$31.26	\$31.98	\$40.99	\$64.97	\$31.08	\$31.64	
60	-0600	\$32.66	\$33.56	\$44.99	\$73.60	\$31.65	\$32.35	
72	-0720	\$34.06	\$35.14	\$47.99	\$82.23	\$32.22	\$33.06	
Solder Center, Crimp Outer, Low Loss Flexible								
LENGTH IN INCHES	DASH NUM	50 Ω ^{④⑨} SIG 400 ^① 2 shields 4LC-NAQNA-	50 Ω ^{④⑨} LMR 400 ^① 2 shields 4LM-NAQNA-	50 Ω ^{④⑨} SIG 400FR ^① 2 shields 4RC-NAQNA-	50 Ω ^{④⑨} LMR 400FR ^① 2 shields 4LR-NAQNA-	50 Ω ^{④⑨} SIG 400UF ^① 2 shields 4UC-NAQNA-	50 Ω ^④ LMR 400UF ^① 2 shields ^⑨ 4UF-NAQNA-	
12	-0120	\$77.82	\$78.34	\$77.94	\$78.86	\$77.94	\$78.86	
24	-0240	\$78.68	\$79.72	\$78.92	\$80.76	\$78.92	\$80.76	
36	-0360	\$79.54	\$81.10	\$79.90	\$82.66	\$79.90	\$82.66	
48	-0480	\$80.40	\$82.48	\$80.88	\$84.56	\$80.88	\$84.56	
60	-0600	\$81.26	\$83.86	\$81.86	\$86.46	\$81.86	\$86.46	
72	-0720	\$82.12	\$85.24	\$82.84	\$88.36	\$82.84	\$88.36	
Color Designators (add letter to the end of the part number and add \$1.00 to price)								
Black - B		Blue - L		Brown - N		Gray - A		Green - G
Orange - O		Red - R		Violet - V		Yellow - Y		White - W

See Page B5 for Cable Characteristics

* Contact Factory for delivery, Consider new RD316 for (RD188) 10% Discount @ 25 pcs. up 4% Discount @ 10 pcs. up



RF Depot.com Inc.

Phone 856-488-2000 Fax 856-488-2020

N Male Plug x QN Right Angle Male Plug

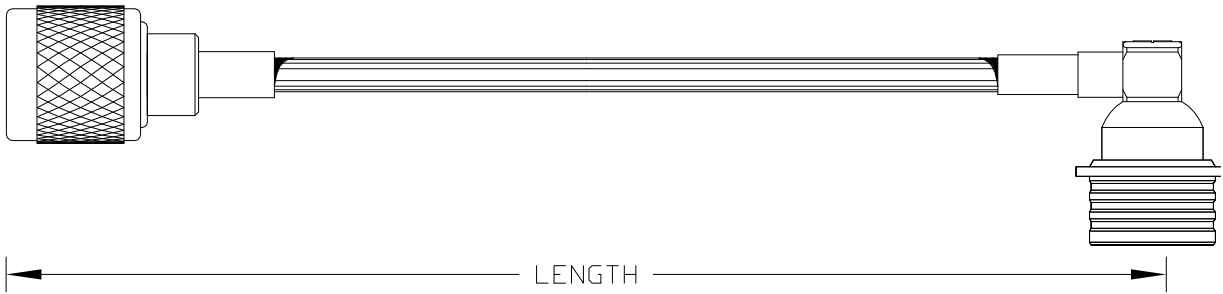

LENGTH IN INCHES	DASH NUMBER	50 Ω ^{⑥⑦} RG 58C ^⑤ 1 shield 058-NAQNC-	50 Ω ^{⑧①} RG 223 2 shields ^⑦ 223-NAQNC-	50 Ω ^{④②} RG142B 2 shields ^⑦ 142-NAQNC-	50 Ω ^{①⑦} RG 400 ^{✕④} 2 shields 400-NAQNC-	50 Ω ^③ RG 213 ^{③⑧} 1 shield 213-NAQNC-	50 Ω ^② RG 214 ^{③①} 2 shields ^⑦ 214-NAQNC-	50 Ω ^④ RG 393 ^{①⑦} 2 shields 393-NAQNC-
Solder Center, Crimp Outer								
12	-0120	\$32.08	\$30.27	\$31.10	\$31.80	\$29.98	\$34.16	\$46.05
24	-0240	\$32.48	\$31.74	\$33.40	\$34.80	\$31.56	\$37.66	\$54.68
36	-0360	\$32.88	\$33.21	\$35.70	\$37.80	\$33.14	\$41.16	\$63.31
48	-0480	\$33.28	\$34.68	\$38.00	\$40.80	\$34.72	\$44.66	\$71.94
60	-0600	\$33.68	\$36.15	\$40.30	\$43.80	\$36.30	\$48.16	\$80.57
72	-0720	\$34.08	\$37.62	\$42.60	\$46.80	\$37.88	\$51.66	\$89.20

N Male Plug x SMA Female Bulkhead Jack

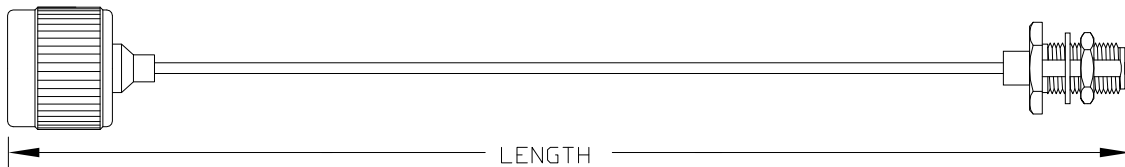

LENGTH IN INCHES	DASH NUMBER	50 Ω ^{⑥⑦} RG 58C ^⑤ 1 shield 058-MFNA-	50 Ω ^{⑧①} RG 223 2 shields ^⑦ 223-MFNA-	50 Ω ^{④②} RG142B 2 shields ^⑦ 142-MFNA-	50 Ω ^{①⑦} RG 400 ^{✕④} 2 shields 400-MFNA-	50 Ω ^② RG 178B/U ^② 1 shield ^⑧ 178-MFNA-	50 Ω ^④ RG 196 ^② 1 shield ^⑧ 196-MFNA-
Solder Center, Crimp Outer							
12	-0120	\$31.51	\$32.38	\$33.21	\$33.91	\$41.06	\$41.06
24	-0240	\$31.91	\$33.85	\$35.51	\$36.91	\$41.80	\$41.80
36	-0360	\$32.31	\$35.32	\$37.81	\$39.91	\$42.54	\$42.54
48	-0480	\$32.71	\$36.79	\$40.11	\$42.91	\$43.28	\$43.28
60	-0600	\$33.11	\$38.26	\$42.41	\$45.91	\$44.02	\$44.02
Solder Center, Crimp Outer							
LENGTH IN INCHES	DASH NUMBER	50 Ω ^② RG 174 ^{④⑤} 1 shield ^⑦ 174-MFNA-	50 Ω ^{④②} RG 316 ^{④②} 1 shield ^⑧ 316-MFNA-	50 Ω ^{④②} RD316 ^{④②} 2 shields ^⑦ 31D-MFNA-	50 Ω ^{④②} RG188* ^{④②} 1 shield ^⑧ 188-MFNA-	75 Ω ^{④②} RG179A ^{④②} 1 shield ^⑧ 179-MFNA-	50 Ω ^④ RG 393 ^{①⑦} 2 shields 393-MFNA-
12	-0120	\$32.11	\$32.52	\$26.63	\$32.87	\$25.51	\$35.21
24	-0240	\$32.35	\$33.17	\$28.48	\$33.87	\$26.24	\$43.84
36	-0360	\$32.59	\$33.82	\$30.33	\$34.87	\$26.97	\$52.47
48	-0480	\$32.83	\$34.47	\$32.18	\$35.87	\$27.70	\$61.10
60	-0600	\$33.07	\$35.12	\$34.03	\$36.87	\$28.43	\$69.73
Color Designators (add letter to the end of the part number and add \$1.00 to price)							
Black - B		Blue - L		Brown - N		Gray - A	
Orange - O		Red - R		Violet - V		Green - G	
						White - W	

See Page B5 for Cable Characteristics

* Contact Factory for delivery, Consider new RD316 for (RD188)

10% Discount @ 25 pcs. up

4% Discount @ 10 pcs. up

 **RF Depot.com Inc.**

Phone 856-488-2000 Fax 856-488-2020

7850 Browning Rd. Pennsauken, NJ 08109

Online @ www.rfdepot.com

Toll Free 877-RF Depot

N Male Plug x SMA Female Jack



←————— LENGTH —————→

LENGTH IN INCHES	DASH NUMBER	50 Ω ^⑥ ⑦ RG 58C ^⑥ 1 shield ^⑦ 058-MBNA-	50 Ω ^⑧ ① RG 223 2 shields ^⑦ 223-MBNA-	50 Ω ^④ ② RG142B 2 shields ^⑦ 142-MBNA-	50 Ω ^① ⑦ RG 400 [✕] ④ 2 shields ^⑦ 400-MBNA-	50 Ω RG 178B/U ^② 1 shield ^⑧ 178-MBNA-
------------------	-------------	--	--	--	---	--

Solder Center, Crimp Outer

12	-0120	\$35.27	\$36.14	\$36.97	\$37.67	\$30.52
24	-0240	\$35.67	\$37.61	\$39.27	\$40.67	\$31.26
36	-0360	\$36.07	\$39.08	\$41.57	\$43.67	\$32.00
48	-0480	\$36.47	\$40.55	\$43.87	\$46.67	\$32.74
60	-0600	\$36.87	\$42.02	\$46.17	\$49.67	\$33.48
72	-0720	\$37.27	\$43.49	\$48.47	\$52.67	\$34.22

Solder Center, Crimp Outer

LENGTH IN INCHES	DASH NUMBER	50 Ω RG 174 ^④ ⑤ 1 shield ^⑦ 174-MBNA-	50 Ω RG 316 ^④ ② 1 shield ^⑧ 316-MBNA-	50 Ω RD316 ^④ ② 2 shields ^⑦ 31D-MBNA-	50 Ω RG188* ^④ ② 1 shield ^⑧ 188-MBNA-	50 Ω RG 196 ^② 1 shield ^⑧ 196-MBNA-
12	-0120	\$30.56	\$30.97	\$32.17	\$31.32	\$32.84
24	-0240	\$30.80	\$31.62	\$34.02	\$32.32	\$33.58
36	-0360	\$31.04	\$32.27	\$35.87	\$33.32	\$34.32
48	-0480	\$31.28	\$32.92	\$37.72	\$34.32	\$35.06
60	-0600	\$31.52	\$33.57	\$39.57	\$35.32	\$35.80
72	-0720	\$31.76	\$34.22	\$41.42	\$36.32	\$36.54

Solder Center, Crimp Outer

LENGTH IN INCHES	DASH NUMBER	50 Ω RG 8* ^⑧ ③⑧ 1 shield ^⑧ 008-MBNA-	50 Ω RG 213 ^⑧ ③⑧ 1 shield ^⑧ 213-MBNA-	50 Ω RG 214 ^⑧ ① 2 shields ^⑦ 214-MBNA-	50 Ω RG 393 ^④ ①⑦ 2 shields ^⑦ 393-MBNA-	75 Ω RG179A ^④ ② 1 shield ^⑧ 179-MBNA-
12	-0120	\$32.39	\$32.47	\$35.72	\$40.85	\$31.05
24	-0240	\$33.69	\$34.05	\$39.22	\$49.48	\$31.78
36	-0360	\$35.09	\$35.63	\$42.72	\$58.11	\$32.51
48	-0480	\$36.49	\$37.21	\$46.22	\$66.74	\$33.24
60	-0600	\$37.89	\$38.79	\$49.72	\$75.37	\$33.97
72	-0720	\$39.29	\$40.37	\$53.22	\$84.00	\$34.70

Color Designators (add letter to the end of the part number and add \$1.00 to price)

Black - B	Blue - L	Brown - N	Gray - A	Green - G
Orange - O	Red - R	Violet - V	Yellow - Y	White - W

See Page B5 for Cable Characteristics

* Contact Factory for delivery, Consider new RD316 for (RD188) 10% Discount @ 25 pcs. up 4% Discount @ 10 pcs. up

N Male Plug x SMA Female Jack



←————— LENGTH —————→

LENGTH IN INCHES	DASH NUMBER	50 Ω ^③ SIG 100 [Ⓞ] 2 shields 1LC-MBNA-	50 Ω ^③ LMR 100 [Ⓞ] 2 shields 1LM-MBNA-	50 Ω ^③ SIG 195 [Ⓞ] 2 shields [Ⓞ] 19C-MBNA-	50 Ω ^③ LMR 195 [Ⓞ] 2 shields [Ⓞ] 19M-MBNA-	50 Ω ^③ SIG 200 [Ⓞ] 2 shields 2LC-MBNA-	50 Ω ^③ LMR 200 [Ⓞ] 2 shields 2LM-MBNA-		
Solder Center, Crimp Outer, Low Loss Flexible									
24	-0240	\$25.40	\$25.64	\$23.80	\$24.08	\$23.78	\$23.88		
60	-0600	\$27.02	\$27.62	\$25.51	\$26.21	\$25.82	\$26.07		
120	-1200	\$29.72	\$30.92	\$28.36	\$29.76	\$29.22	\$29.72		
180	-1800	\$32.42	\$34.22	\$31.21	\$33.31	\$32.62	\$33.37		
240	-2400	\$35.12	\$37.52	\$34.06	\$36.86	\$36.02	\$37.02		
300	-3000	\$37.82	\$40.82	\$36.91	\$40.41	\$39.42	\$40.67		
Solder Center, Crimp Outer, Low Loss Flexible									
LENGTH IN INCHES	DASH NUMBER	50 Ω ^③ SIG 240 [Ⓞ] 2 shields 24C-MBNA-	50 Ω ^③ LMR 240 [Ⓞ] 2 shields 24L-MBNA-	50 Ω ^③ SIG 240UF [Ⓞ] 2 shields 24U-MBNA-	50 Ω ^③ LMR 240UF [Ⓞ] 2 shields 24UF-MBNA-	50 Ω ^④ SIG 400 [Ⓞ] 2 shields 4LC-MBNA-	50 Ω ^④ LMR 400 [Ⓞ] 2 shields 4LM-MBNA-		
24	-0240	\$24.30	\$25.14	\$24.42	\$25.46	\$28.76	\$29.80		
60	-0600	\$26.10	\$28.20	\$26.40	\$29.00	\$31.34	\$33.94		
120	-1200	\$29.10	\$33.30	\$29.70	\$34.90	\$35.64	\$40.84		
180	-1800	\$32.10	\$38.40	\$33.00	\$40.80	\$39.94	\$47.74		
240	-2400	\$35.10	\$43.50	\$36.30	\$46.70	\$44.24	\$54.64		
300	-3000	\$38.10	\$48.60	\$39.60	\$52.60	\$48.54	\$61.54		
Solder Center, Crimp Outer, Low Loss Flexible									
LENGTH IN INCHES	DASH NUMBER	50 Ω ^④ SIG 400DB 2 shields 4DC-MBNA-	50 Ω ^④ LMR 400DB 2 shields 4LD-MBNA-	50 Ω ^④ SIG 400FR 2 shields 4RC-MBNA-	50 Ω ^④ LMR 400FR 2 shields 4LR-MBNA-	50 Ω ^④ SIG 400UF 2 shields 4UC-MBNA-	50 Ω ^④ LMR 400UF 2 shields [Ⓞ] 4UF-MBNA-	50 Ω ^④ LMR 600 [Ⓞ] 2 shields 6LM-MBNA-	
24	-0240	\$29.00	\$30.24	\$29.00	\$30.84	\$29.00	\$30.84	\$31.04	
60	-0600	\$31.94	\$35.04	\$31.94	\$36.54	\$31.94	\$36.54	\$37.04	
120	-1200	\$36.84	\$43.04	\$36.84	\$46.04	\$36.84	\$46.04	\$47.04	
180	-1800	\$41.74	\$51.04	\$41.74	\$55.54	\$41.74	\$55.54	\$57.04	
240	-2400	\$46.64	\$59.04	\$46.64	\$65.04	\$46.64	\$65.04	\$67.04	
300	-3000	\$51.54	\$67.04	\$51.54	\$74.54	\$51.54	\$74.54	\$77.04	
Color Designators (add letter to the end of the part number and add \$1.00 to price)									
Black - B		Blue - L		Brown - N		Gray - A		Green - G	
Orange - O		Red - R		Violet - V		Yellow - Y		White - W	

See Page B5 for Cable Characteristics

* Contact Factory for delivery, Consider new RD316 for (RD188)

10% Discount @ 25 pcs. up

4% Discount @ 10 pcs. up

N Male Plug x SMA Male Plug

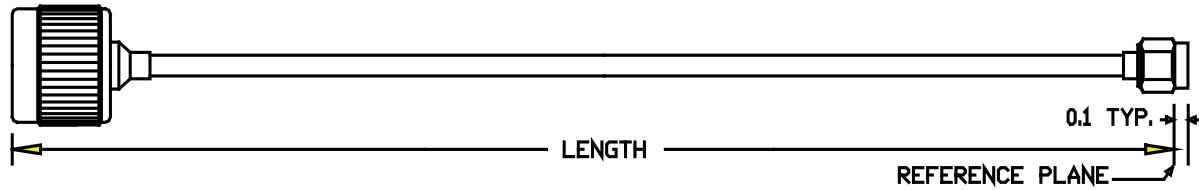

LENGTH IN INCHES	DASH NUMBER	50 Ω ^⑦ RG 58C ^③ 1 shield 058-MANA-	50 Ω ^{③①} RG 223 2 shields ^⑦ 223-MANA-	50 Ω ^{④②} RG142B 2 shields ^⑦ 142-MANA-	50 Ω ^{①⑦} RG 400* ^④ 2 shields 400-MANA-	75 Ω ^⑤ RG 59B ^{③†} 1 shield ^⑧ 059-MANA-	93 Ω ^⑤ RG 62 ^{③‡} 1 shield ^⑧ 062-MANA-	50 Ω ^④ RG 393 ^{①⑦} 2 shields 393-MANA-
Solder Center, Crimp Outer								
12	-0120	\$28.19	\$30.55	\$31.38	\$32.08	\$37.15	\$37.41	\$78.99
24	-0240	\$28.59	\$32.02	\$33.68	\$35.08	\$37.59	\$38.11	\$87.62
36	-0360	\$28.99	\$33.49	\$35.98	\$38.08	\$38.03	\$38.81	\$96.25
48	-0480	\$29.39	\$34.96	\$38.28	\$41.08	\$38.47	\$39.51	\$104.88
60	-0600	\$29.79	\$36.43	\$40.58	\$44.08	\$38.91	\$40.21	\$113.51
72	-0720	\$30.19	\$37.90	\$42.88	\$47.08	\$39.35	\$40.91	\$122.14
Solder Center, Crimp Outer								
LENGTH IN INCHES	DASH NUMBER	50 Ω RG 174 ^{③⑤} 1 shield ^⑦ 174-MANA-	50 Ω RG 316 ^{④②} 1 shield ^⑧ 316-MANA-	50 Ω RD316 ^{④②} 2 shields ^⑦ 31D-MANA-	50 Ω RG188* ^{④②} 1 shield ^⑧ 188-MANA-	50 Ω RG 178B/U ^② 1 shield ^⑧ 178-MANA-	50 Ω RG 196 ^② 1 shield ^⑧ 196-MANA-	
12	-0120	\$24.65	\$25.06	\$24.71	\$25.41	\$32.84	\$40.72	
24	-0240	\$24.89	\$25.71	\$26.56	\$26.41	\$33.58	\$41.46	
36	-0360	\$25.13	\$26.36	\$28.41	\$27.41	\$34.32	\$42.20	
48	-0480	\$25.37	\$27.01	\$30.26	\$28.41	\$35.06	\$42.94	
60	-0600	\$25.61	\$27.66	\$32.11	\$29.41	\$35.80	\$43.68	
72	-0720	\$25.85	\$28.31	\$33.96	\$30.41	\$36.54	\$44.42	
Solder Center, Crimp Outer								
LENGTH IN INCHES	DASH NUMBER	50 Ω RG 8* ^{③③⑧} 1 shield 008-MANA-	50 Ω ^③ RG 213 ^{③⑧} 1 shield 213-MANA-	50 Ω RG 214 ^{③①} 2 shields ^⑦ 214-MANA-	75 Ω RG179A ^{④②} 1 shield ^⑧ 179-MANA-	50 Ω ^{④⑨} SIG 400 ^③ 2 shields 4LC-MANA-	50 Ω ^{④⑨} LMR 400 ^③ 2 shields 4LM-MANA-	
12	-0120	\$30.94	\$31.12	\$72.86	\$25.14	\$29.96	\$31.00	
24	-0240	\$32.34	\$32.70	\$76.36	\$25.87	\$32.54	\$35.14	
36	-0360	\$33.74	\$34.28	\$79.86	\$26.60	\$36.84	\$42.04	
48	-0480	\$35.14	\$35.86	\$83.36	\$27.33	\$41.14	\$48.94	
60	-0600	\$36.54	\$37.44	\$86.86	\$28.06	\$45.44	\$55.84	
72	-0720	\$37.94	\$39.02	\$90.36	\$28.79	\$49.74	\$62.74	
Color Designators (add letter to the end of the part number and add \$1.00 to price)								
Black - B		Blue - L		Brown - N		Gray - A		Green - G
Orange - O		Red - R		Violet - V		Yellow - Y		White - W

See Page B5 for Cable Characteristics

* Contact Factory for delivery, Consider new RD316 for (RD188) 10% Discount @ 25 pcs. up 4% Discount @ 10 pcs. up

‡ Brass Body Stainless Steel Nut



RF Depot.com Inc.

Phone 856-488-2000 Fax 856-488-2020

B100

7850 Browning Rd. Pennsauken, NJ 08109

Online @ www.rfdepot.com

Toll Free 877-RF Depot

N Male Plug x SMA Male Plug

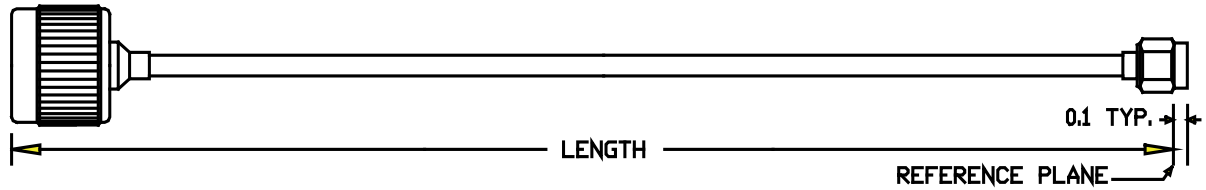

LENGTH IN INCHES	DASH NUMBER	50Ω RG 401① M17/129-RG401 .250 Cu Jacket 401-M0N0-	50Ω RG 401① No QPL List .250 Tin Plate Al 25A-M0N0-	50Ω RG 401② M17/129-00001 .250 Tin Plate Cu 2TS-M0N0-	50Ω MaxiFlex② No QPL List .250 Tin Plate Braid 25F-M0N0-	
.250" Diameter SEMIRIGID and Maxi Flex. Direct Solder Connectors						
12	-0120	\$106.98	\$107.92	\$112.17	\$106.98	
24	-0240	\$110.00	\$111.88	\$120.38	\$110.00	
36	-0360	\$113.02	\$115.84	\$128.59	\$113.02	
48	-0480	\$116.04	\$119.80	\$136.80	\$116.04	
60	-0600	\$119.06	\$123.76	\$145.01	\$119.06	
72	-0720	\$122.08	\$127.72	\$153.22	\$122.08	
.141" Diameter SEMIRIGID and Maxi Flex. Direct Solder Connectors						
LENGTH IN INCHES	DASH NUMBER	50Ω RG 402② M17/130-00004 .141 Cu Jacket 402-M0N0-	50Ω RG 402② M17/130-00005 .141 Tin Plate Cu 1TS-M0N0-	50Ω RG 402① M17/130-00009 .141 Tin Pl Al 1AT-M0N0-	50Ω MaxiFlex② No QPL List .141 Tin Pl 14F-M0N0-	50Ω RG 402② M17/130-00012 .141 Silver Pl 1SS-M0N0-
12	-0120	\$40.64	\$40.28	\$40.64	\$40.28	\$49.85
24	-0240	\$44.24	\$43.52	\$44.24	\$43.52	\$62.66
36	-0360	\$47.84	\$46.76	\$47.84	\$46.76	\$75.47
48	-0480	\$51.44	\$50.00	\$51.44	\$50.00	\$88.28
60	-0600	\$55.04	\$53.24	\$55.04	\$53.24	\$101.09
72	-0720	\$58.64	\$56.48	\$58.64	\$56.48	\$113.90
.085" Diameter SEMIRIGID and Maxi Flex. Direct Solder Connectors						
LENGTH IN INCHES	DASH NUMBER	50Ω RG 405② M17/133-00007 .085 Tin Pl Cu 405-M0N0-	50Ω RG 405② M17/133-00007 .085 Tin Pl Cu 8TS-M0N0-	50Ω RG 405② M17/133-00013 .085 Tin Pl Al 8AT-M0N0-	50Ω MaxiFlex② No QPL List .085 Tin Pl 08F-M0N0-	50Ω RG 405② M17/133-00016 .085 Silver Pl 8SS-M0N0-
12	-0120	\$40.01	\$40.01	\$40.95	\$41.24	\$45.20
24	-0240	\$43.03	\$43.03	\$44.91	\$45.49	\$53.41
36	-0360	\$46.05	\$46.05	\$48.87	\$49.74	\$61.62
48	-0480	\$49.07	\$49.07	\$52.83	\$53.99	\$69.83
60	-0600	\$52.09	\$52.09	\$56.79	\$58.24	\$78.04
72	-0720	\$55.11	\$55.11	CALL	\$62.49	CALL

①Silver Plated Copper Center Conductor ②Silver Plated Copper Clad Steel Center Conductor

10% Discount @ 25 pcs. up 4% Discount @ 10 pcs. up



N Male Plug x SMA Male Plug Commercial

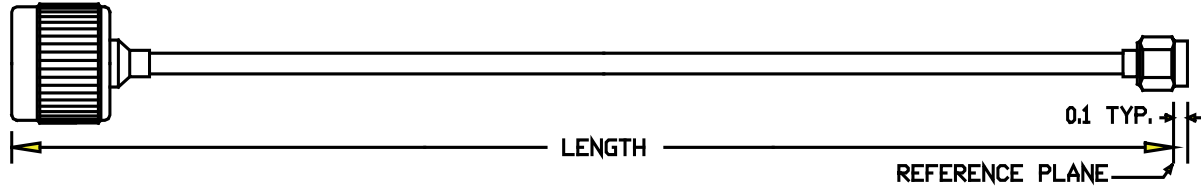

LENGTH IN INCHES	DASH NUMBER	50Ω RG 401① M17/129-RG401 .250 Cu Jacket 401-M0N0-	50Ω RG 401① No QPL List .250 Tin Plate Al 25A-M0N0-	50Ω RG 401② M17/129-00001 .250 Tin Plate Cu 2TS-M0N0-	50Ω MaxiFlex② No QPL List .250 Tin Plate Braid 25F-M0N0-	
.250" Diameter SEMIRIGID and Maxi Flex. Direct Solder Connectors						
24	-0240C	\$29.99	\$31.87	\$40.37	\$29.99	
36	-0360C	\$33.01	\$35.83	\$48.58	\$33.01	
48	-0480C	\$36.03	\$39.79	\$56.79	\$36.03	
60	-0600C	\$39.05	\$43.75	\$65.00	\$39.05	
72	-0720C	\$42.07	\$47.71	\$73.21	\$42.07	
.141" Diameter SEMIRIGID and Maxi Flex. Direct Solder Connectors						
LENGTH IN INCHES	DASH NUMBER	50Ω RG 402② M17/130-00004 .141 Cu Jacket 402-M0N0-	50Ω RG 402② M17/130-00005 .141 Tin Plate Cu 1TS-M0N0-	50Ω RG 402① M17/130-00009 .141 Tin Pl Al 1AT-M0N0-	50ΩMaxiFlex② No QPL List .141 Tin Pl 14F-M0N0-	50Ω RG 402② M17/130-00012 .141 Silver Pl 1SS-M0N0-
12	-0120C	\$22.18	\$21.82	\$22.18	\$21.82	\$26.79
24	-0240C	\$25.78	\$25.06	\$25.78	\$25.06	\$35.00
36	-0360C	\$29.38	\$28.30	\$29.38	\$28.30	\$43.21
48	-0480C	\$32.98	\$31.54	\$32.98	\$31.54	\$51.42
60	-0600C	\$36.58	\$34.78	\$36.58	\$34.78	\$59.63
72	-0720C	\$40.18	\$38.02	\$40.18	\$38.02	\$67.84
.085" Diameter SEMIRIGID and Maxi Flex. Direct Solder Connectors						
LENGTH IN INCHES	DASH NUMBER	50Ω RG 405② M17/133-00007 .085 Tin Plate Cu 405-M0N0-	50Ω RG 405② M17/133-00007 .085 Tin Plate Cu 8TS-M0N0-	50Ω RG 405② M17/133-00013 .085 Tin Plate Al 8AT-M0N0-	50ΩMaxiFlex② No QPL List .085 Tin Pl 08F-M0N0-	50Ω RG 405② M17/133-00016 .085 Silver Pl 8SS-M0N0-
12	-0120C	\$25.76	\$25.76	\$26.70	\$26.99	\$30.95
24	-0240C	\$28.78	\$28.78	\$30.66	\$31.24	\$39.16
36	-0360C	\$31.80	\$31.80	\$34.62	\$35.49	\$47.37
48	-0480C	\$34.82	\$34.82	\$38.58	\$39.74	\$55.58
60	-0600C	\$37.84	\$37.84	\$42.54	\$43.99	\$63.79
72	-0720C	\$40.86	\$40.86	CALL	\$48.24	CALL
.047" Diameter SEMIRIGID and Maxi Flex. Direct Solder Connectors						
LENGTH IN INCHES	DASH NUM	50Ω ② M17/151-00001 .047 Cu Jacket 4CU-M0N0-	50Ω No QPL List .047 Tin Plate Al 4AT-M0N0-	50Ω② M17/151-00002 .047 Tin Plate Cu 4TS-M0N0-	50Ω ② MaxiFlex No QPL List .047 Tin Pl 04F-M0N0-	50Ω ① Non-Magnetic .085 Tin Plate Cu 8CT-M0N0-
12	-0120C	\$26.59	\$28.04	\$26.59	\$27.29	\$24.97
24	-0240C	\$30.39	\$33.29	\$30.39	\$31.79	\$27.15
60	-0600C	\$41.79	\$49.04	\$41.79	\$45.29	\$33.69

①Silver Plated Copper Center Conductor ②Silver Plated Copper Clad Steel Center Conductor

10% Discount @ 25 pcs. up 4% Discount @ 10 pcs. up



RF Depot.com Inc.

Phone 856-488-2000 Fax 856-488-2020

B102

7850 Browning Rd. Pennsauken, NJ 08109

Online @ www.rfdepot.com

Toll Free 877-RF Depot

N Male Plug x SMA Reverse Polarity Plug

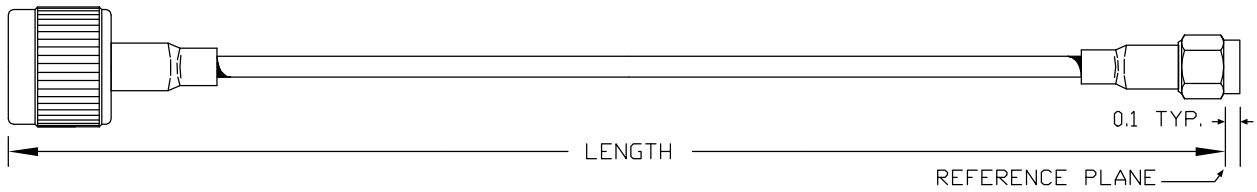

LTH IN INS	DASH NUM	50 Ω RG 58C ③⑥ 1 shield ⑦ 058-MMNA-	50 Ω RG 142 ④② 2 shields ⑦ 142-MMNA-	50 Ω RG 174 ③⑤ 1 shield ⑦ 174-MMNA-	50 Ω RG188*④② 1 shield ⑩ 188-MMNA-	50 Ω③ RG 223 ① 2 shields ⑦ 223-MMNA-	50 Ω RG 316 ④② 1 shield ⑩ 316-MMNA-	50 Ω④ RD 316 ②⑦ 2 shields 31D-MMNA-
Solder Center, Crimp Outer with Strain Relief								
12	-0120C	\$28.81	\$37.55	\$27.65	\$28.41	\$36.72	\$28.06	\$29.26
24	-0240C	\$29.21	\$39.85	\$27.89	\$29.41	\$38.19	\$28.71	\$31.11
36	-0360C	\$29.61	\$42.15	\$28.13	\$30.41	\$39.66	\$29.36	\$32.96
48	-0480C	\$30.01	\$44.45	\$28.37	\$31.41	\$41.13	\$30.01	\$34.81
60	-0600C	\$30.41	\$46.75	\$28.61	\$32.41	\$42.60	\$30.66	\$36.66
72	-0720C	\$30.81	\$49.05	\$28.85	\$33.41	\$44.07	\$31.31	\$38.51

N Male Plug x SMA Reverse Polarity Right Angle Plug

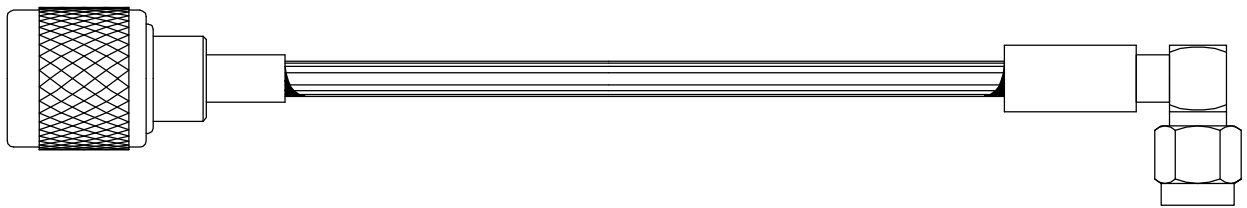

LTH IN INS	DASH NUM	50 Ω RG 58C ③⑥ 1 shield ⑦ 058-MPNA-	50 Ω RG 142 ④② 2 shields ⑦ 142-MPNA-	50 Ω RG 174 ③⑤ 1 shield ⑦ 174-MPNA-	50 Ω RG188*④② 1 shield ⑩ 188-MPNA-	50 Ω③ RG 223 ① 2 shields ⑦ 223-MPNA-	50 Ω RG 316 ④② 1 shield ⑩ 316-MPNA-	50 Ω④ RD 316 ②⑦ 2 shields 31D-MPNA-
Solder Center, Crimp Outer with Strain Relief								
12	-0120C	\$28.24	\$29.86	\$28.26	\$29.02	\$29.03	\$27.20	\$28.73
24	-0240C	\$28.64	\$32.16	\$28.50	\$30.02	\$30.50	\$27.85	\$30.58
36	-0360C	\$29.04	\$34.46	\$28.74	\$31.02	\$31.97	\$28.50	\$32.43
48	-0480C	\$29.44	\$36.76	\$28.98	\$32.02	\$33.44	\$29.15	\$34.28
60	-0600C	\$29.84	\$39.06	\$29.22	\$33.02	\$34.91	\$29.80	\$36.13
72	-0720C	\$30.24	\$41.36	\$29.46	\$34.02	\$36.38	\$30.45	\$37.98
Color Designators (add letter to the end of the part number and add \$1.00 to price)								
Black - B		Blue - L		Brown - N		Gray - A		Green - G
Orange - O		Red - R		Violet - V		Yellow - Y		White - W

See Page B5 for Cable Characteristics

* Contact Factory for delivery, Consider new RD316 for (RD188)

10% Discount @ 25 pcs. up

4% Discount @ 10 pcs. up

N Male Plug x SMA Right Angle Male Plug



LENGTH IN INCHES	DASH NUMBER	50 Ω ^⑦ RG 58C ^⑦ 1 shield 058-MCNA-	50 Ω ^{①⑦} RG 223 2 shields ^⑦ 223-MCNA-	50 Ω ^{④②} RG142B 2 shields ^⑦ 142-MCNA-	50 Ω ^{①⑦} RG 400 ^{✕④} 2 shields 400-MCNA-	75 Ω ^⑤ RG 59B ^{⑤†} 1 shield ^⑤ 059-MCNA-	93 Ω ^⑤ RG 62 ^{⑤†} 1 shield ^⑤ 062-MCNA-	75 Ω ^② RG179A ^④ 1 shield ^② 179-MCNA-
Solder Center, Crimp Outer								
12	-0120	\$34.29	\$33.32	\$34.15	\$34.85	\$37.25	\$37.51	\$32.60
24	-0240	\$34.69	\$34.79	\$36.45	\$37.85	\$37.69	\$38.21	\$33.33
36	-0360	\$35.09	\$36.26	\$38.75	\$40.85	\$38.13	\$38.91	\$34.06
48	-0480	\$35.49	\$37.73	\$41.05	\$43.85	\$38.57	\$39.61	\$34.79
60	-0600	\$35.89	\$39.20	\$43.35	\$46.85	\$39.01	\$40.31	\$35.52
72	-0720	\$36.29	\$40.67	\$45.65	\$49.85	\$39.45	\$41.01	\$36.25
Solder Center, Crimp Outer								
LENGTH IN INCHES	DASH NUMBER	50 Ω RG 174 ^{⑤⑦} 1 shield ^⑦ 174-MCNA-	50 Ω RG 316 ^{④②} 1 shield ^② 316-MCNA-	50 Ω RD316 ^{④②} 2 shields ^⑦ 31D-MCNA-	50 Ω RG188* ^{④②} 1 shield ^② 188-MCNA-	50 Ω RG 178B/U ^② 1 shield ^② 178-MCNA-	50 Ω RG 196 ^② 1 shield ^② 196-MCNA-	
12	-0120	\$32.11	\$32.52	\$26.63	\$32.87	\$41.06	\$52.82	
24	-0240	\$32.35	\$33.17	\$28.48	\$33.87	\$41.80	\$53.56	
36	-0360	\$32.59	\$33.82	\$30.33	\$34.87	\$42.54	\$54.30	
48	-0480	\$32.83	\$34.47	\$32.18	\$35.87	\$43.28	\$55.04	
60	-0600	\$33.07	\$35.12	\$34.03	\$36.87	\$44.02	\$55.78	
72	-0720	\$33.31	\$35.77	\$35.88	\$37.87	\$44.76	\$56.52	
Solder Center, Crimp Outer, Commercial (Brass) Connectors								
LENGTH IN INCHES	DASH NUMBER	50 Ω RG 8* ^{③③③} 1 shield 008-MCNA-	50 Ω ^③ RG 213 ^{③③} 1 shield 213-MCNA-	50 Ω RG 214 ^{④①} 2 shields ^⑦ 214-MCNA-	50 Ω ^④ RG 393 ^{①⑦} 2 shields 393-MCNA-	50 Ω ^{④⑤} SIG 400 ^⑤ 2 shields 4LC-MCNA-	50 Ω ^{④⑤} LMR 400 ^⑤ 2 shields 4LM-MCNA-	
12	-0120C	\$27.65	\$27.83	\$72.86	\$77.99	\$32.96	\$34.00	
24	-0240C	\$29.05	\$29.41	\$76.36	\$86.62	\$35.54	\$38.14	
36	-0360C	\$30.45	\$30.99	\$79.86	\$95.25	\$39.84	\$45.04	
48	-0480C	\$31.85	\$32.57	\$83.36	\$103.88	\$44.14	\$51.94	
60	-0600C	\$33.25	\$34.15	\$86.86	\$112.51	\$48.44	\$58.84	
72	-0720C	\$34.65	\$35.73	\$90.36	\$121.14	\$52.74	\$65.74	
Color Designators (add letter to the end of the part number and add \$1.00 to price)								
Black - B		Blue - L		Brown - N		Gray - A		Green - G
Orange - O		Red - R		Violet - V		Yellow - Y		White - W

See Page B5 for Cable Characteristics

* Contact Factory for delivery, Consider new RD316 for (RD188) 10% Discount @ 25 pcs. up 4% Discount @ 10 pcs. up

† Brass Body Stainless Steel Nut



RF Depot.com Inc.

Phone 856-488-2000 Fax 856-488-2020

N Male Plug x TNC Male Plug

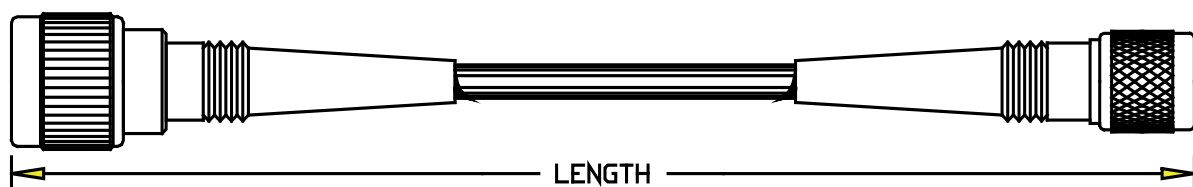

LENGTH IN INCHES	DASH NUMBER	50 Ω ^⑦ RG 58C ^③ 1 shield 058-NATA-	50 Ω ^{③①} RG 223 2 shields ^⑦ 223-NATA-	50 Ω ^{④②} RG142B 2 shields ^⑦ 142-NATA-	50 Ω ^{①⑦} RG 400 ^{✕④} 2 shields 400-NATA-	75 Ω RG179A ^{④②} 1 shield ^⑩ 179-NATA-	
Solder Center, Crimp Outer							
12	-0120	\$25.05	\$29.44	\$30.27	\$30.97	\$26.55	
24	-0240	\$25.45	\$30.91	\$32.57	\$33.97	\$27.28	
36	-0360	\$25.85	\$32.38	\$34.87	\$36.97	\$28.01	
48	-0480	\$26.25	\$33.85	\$37.17	\$39.97	\$28.74	
60	-0600	\$26.65	\$35.32	\$39.47	\$42.97	\$29.47	
72	-0720	\$27.05	\$36.79	\$41.77	\$45.97	\$30.20	
Solder Center, Crimp and Clamp Outer							
LENGTH IN INCHES	DASH NUMBER	50 Ω RG 174 ^{③⑤} 1 shield ^⑦ 174-NATA-	50 Ω RG 316 ^{④②} 1 shield ^⑩ 316-NATA-	50 Ω RD316 ^{④②} 2 shields ^⑦ 31D-NATA-	50 Ω RG188* ^{④②} 1 shield ^⑩ 188-NATA-	50 Ω RG 178B/U ^② 1 shield ^⑩ 178-NAT0-	50 Ω RG 196 ^② 1 shield ^⑩ 196-NAT0-
12	-0120	\$25.16	\$25.57	\$26.77	\$25.92	\$33.82	\$33.82
24	-0240	\$25.40	\$26.22	\$28.62	\$26.92	\$34.56	\$34.56
36	-0360	\$25.64	\$26.87	\$30.47	\$27.92	\$35.30	\$35.30
48	-0480	\$25.88	\$27.52	\$32.32	\$28.92	\$36.04	\$36.04
60	-0600	\$26.12	\$28.17	\$34.17	\$29.92	\$36.78	\$36.78
72	-0720	\$26.36	\$28.82	\$36.02	\$30.92	\$37.52	\$37.52
Solder Center, Crimp Outer							
LENGTH IN INCHES	DASH NUMBER	50 Ω RG 8* ^{③③③} 1 shield 008-NATA-	50 Ω ^③ RG 213 ^{③③} 1 shield 213-NATA-	50 Ω RG 214 ^{③①} 2 shields ^⑦ 214-NATA-	75 Ω ^{⑤⑧†} RG 59B ^③ 1 shield 059-NATA-	93 Ω ^{⑤⑧†} RG 62 ^③ 1 shield 062-NATA-	50 Ω ^④ RG 393 ^{①⑦} 2 shields 393-NATA-
12	-0120	\$25.10	\$25.28	\$29.02	\$24.42	\$24.68	\$33.98
24	-0240	\$26.50	\$26.86	\$32.52	\$24.86	\$25.38	\$42.61
36	-0360	\$27.90	\$28.44	\$36.02	\$25.30	\$26.08	\$51.24
48	-0480	\$29.30	\$30.02	\$39.52	\$25.74	\$26.78	\$59.87
60	-0600	\$30.70	\$31.60	\$43.02	\$26.18	\$27.48	\$68.50
72	-0720	\$32.10	\$33.18	\$46.52	\$26.62	\$28.18	\$77.13
Color Designators (add letter to the end of the part number and add \$1.00 to price)							
Black - B		Blue - L		Brown - N		Gray - A	
Orange - O		Red - R		Violet - V		Green - G	
						White - W	

See Page B5 for Cable Characteristics

* Contact Factory for delivery, Consider new RD316 for (RD188)

10% Discount @ 25 pcs. up

4% Discount @ 10 pcs. up

† Brass Body Stainless Steel Nut



N Male Plug x 7-16 Male Plug



←————— LENGTH —————→

LENGTH IN INCHES	DASH NUMBER	50Ω RG 401① M17/129-RG401 .250 Cu Jacket 401-N07160-	50Ω RG 401① No OPL List .250 Tin Plate Al 25A-N07160-	50Ω RG 401② M17/129-00001 .250 Tin Plate Cu 2TS-N07160-	50Ω MaxiFlex② No OPL List .250 Tin Pl 25F-N07160-	50 Ω FSJ4-50B④ 1 shield .500" SUPERFLEX 50J-N07160-			
.250" Diameter SEMIRIGID and Maxi Flex. Direct Solder Connectors									
24	-0240	\$98.32	\$100.20	\$108.70	\$98.32	\$92.41			
36	-0360	\$101.34	\$104.16	\$116.91	\$101.34	\$98.01			
48	-0480	\$104.36	\$108.12	\$125.12	\$104.36	\$103.61			
60	-0600	\$107.38	\$112.08	\$133.33	\$107.38	\$109.21			
72	-0720	\$110.40	\$116.04	\$141.54	\$110.40	\$114.81			
.141" Diameter SEMIRIGID and Maxi Flex. Direct Solder Connectors									
LTH IN INS	DASH NUM	50Ω RG 402② M17/130-00004 .141 Cu Jacket 402-N07160-	50Ω RG 402② M17/130-00005 .141 Tin Pl Cu 1TS-N07160-	50Ω RG 402① M17/130-00009 .141 Tin Plate Al 1AT-N07160-	50Ω MaxiFlex② No OPL List .141 Tin Pl 14F-N07160-	50Ω RG 402② M17/130-00012 .141 Silver Pl 1SS-N07160-	50 Ω LDF4-50A 1 shield .500" Corrugated 50L-N07160-		
24	-0240	\$83.13	\$82.41	\$83.13	\$82.41	\$101.55	\$101.23		
36	-0360	\$86.73	\$85.65	\$86.73	\$85.65	\$114.36	\$104.03		
48	-0480	\$90.33	\$88.89	\$90.33	\$88.89	\$127.17	\$106.83		
60	-0600	\$93.93	\$92.13	\$93.93	\$92.13	\$139.98	\$109.63		
72	-0720	\$97.53	\$95.37	\$97.53	\$95.37	\$152.79	\$112.43		
.085" Diameter SEMIRIGID and Maxi Flex. Direct Solder Connectors									
LTH IN INS	DASH NUM	50Ω RG 405② M17/133-00007 .085 Tin Plate Cu 405-N07160-	50Ω RG 405② M17/133-00007 .085 Tin Plate Cu 8TS-N07160-	50Ω RG 405② M17/133-00013 .085 Tin Plate Al 8AT-N07160-	50Ω MaxiFlex② No OPL List .085 Tin Plate Braid 08F-N07160-	50Ω RG 405② M17/133-00016 .085 Silver Plate Cu 8SS-N07160-			
24	-0240	\$81.92	\$81.92	\$83.80	\$84.38	\$92.30			
36	-0360	\$84.94	\$84.94	\$87.76	\$88.63	\$101.51			
48	-0480	\$87.96	\$87.96	\$91.72	\$92.88	\$108.72			
60	-0600	\$90.98	\$90.98	\$95.68	\$97.13	\$116.93			
72	-0720	\$94.00	\$94.00	CALL	\$101.38	CALL			
Solder Center, Crimp Outer									
LTH IN INS	DASH NUM	50 Ω⑦ RG 58C③ 1 shield 058-NA716A-	50 Ω⑧① RG 223 2 shields⑦ 223-NA716A-	50 Ω④② RG142B 2 shields⑦ 142-NA716A-	50 Ω RG 213③③③ 1 shield 213-NA716A-	50 Ω RG 214③① 2 shields⑦ 214-NA716A-	50 Ω RG 316④② 1 shield⑧ 316-NA716A-	50 Ω④ RG 393①⑦ 2 shields 393-NA716A-	
24	-0240	\$51.96	\$54.10	\$53.46	\$58.36	\$54.48	\$53.01	\$64.75	
36	-0360	\$52.36	\$55.57	\$55.76	\$59.94	\$57.98	\$53.66	\$73.38	
48	-0480	\$52.76	\$57.04	\$58.06	\$61.52	\$61.48	\$54.31	\$82.01	
60	-0600	\$53.16	\$58.51	\$60.36	\$63.10	\$64.98	\$64.96	\$90.64	
72	-0720	\$53.56	\$59.98	\$62.66	\$64.68	\$68.48	\$55.61	\$99.27	
Color Designators (add color's letter to the end of the part number and add \$1.00 to price)									
Black - B		Blue - L		Brown - N		Gray - A		Green - G	
Orange - O		Red - R		Violet - V		Yellow - Y		White - W	

See Page B5 for Cable Characteristics

* Contact Factory for delivery, Consider new RD316 for (RD188) 10%Discount @ 25 pcs. up 4% Discount @ 10 pcs. up
 ①Silver Plated Copper Center Conductor ②Silver Plated Copper Clad Steel Center Conductor



RF Depot.com Inc.

Phone 856-488-2000 Fax 856-488-2020

N Right Angle Male Plug x N Right Angle Male Plug

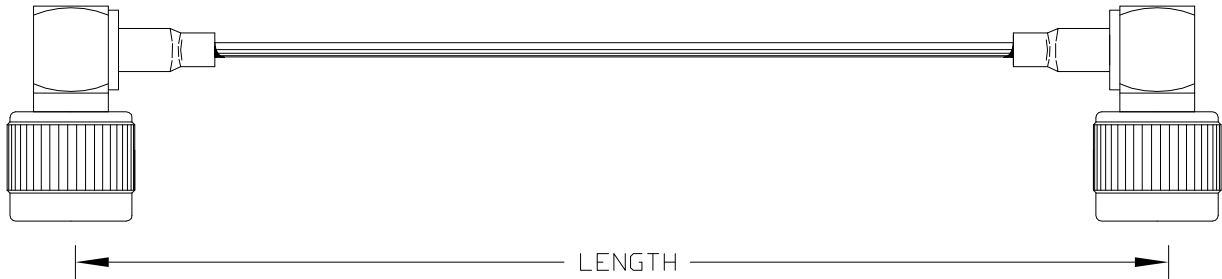

LENGTH IN INCHES	DASH NUM	50 Ω ^{⑥⑦} RG 58C ^⑧ 1 shield 058-NCNC-	50 Ω ^{⑧①} RG 223 2 shields ^⑦ 223-NCNC-	50 Ω ^{④②} RG142B 2 shields ^⑦ 142-NCNC-	50 Ω ^{①⑦} RG 400 ^{✕④} 2 shields 400-NCNC-	75 Ω RG179A ^{④②} 1 shield ^⑧ 179-NCNC-	50 Ω FSJ4-50B ^④ 1 shield .500" SUPERFLEX 50J-N2N2-
Solder Center, Crimp Outer							
12	-0120	\$27.92	\$29.51	\$30.34	\$31.04	\$26.39	\$71.42
24	-0240	\$28.32	\$30.98	\$32.64	\$34.04	\$27.12	\$77.02
36	-0360	\$28.72	\$32.45	\$34.94	\$37.04	\$27.85	\$82.62
48	-0480	\$29.12	\$33.92	\$37.24	\$40.04	\$28.58	\$88.22
60	-0600	\$29.52	\$35.39	\$39.54	\$43.04	\$29.31	\$93.82
72	-0720	\$29.92	\$36.86	\$41.84	\$46.04	\$30.04	\$99.42
Solder Center, Crimp Outer							
LENGTH IN INCHES	DASH NUMBER	50 Ω RG 174 ^{⑥⑤} 1 shield ^⑦ 174-NCNC-	50 Ω RG 316 ^{④②} 1 shield ^⑧ 316-NCNC-	50 Ω RD316 ^{④②} 2 shields ^⑦ 31D-NCNC-	50 Ω RG188* ^{④②} 1 shield ^⑧ 188-NCNC-		
12	-0120	\$25.90	\$26.31	\$27.51	\$26.66		
24	-0240	\$26.14	\$26.96	\$29.36	\$27.66		
36	-0360	\$26.38	\$27.61	\$31.21	\$28.66		
48	-0480	\$26.62	\$28.26	\$33.06	\$29.66		
60	-0600	\$26.86	\$28.91	\$34.91	\$30.66		
72	-0720	\$27.10	\$29.56	\$36.76	\$31.66		
Solder Center, Crimp and Clamp Outer							
LENGTH IN INCHES	DASH NUM	50 Ω RG 8* ^{⑥③⑧} 1 shield 008-NCNC-	50 Ω RG 213 ^{⑥③⑧} 1 shield 213-NCNC-	50 Ω RG 214 ^{⑥①} 2 shields ^⑦ 214-NCNC-	75 Ω ^⑤ RG 59B ^{⑥†} 1 shield ^⑧ 059-NCNC-	93 Ω ^⑤ RG 62 ^{⑥†} 1 shield ^⑧ 062-NCNC-	50 Ω ^④ RG 393 ^{①⑦} 2 shields 393-NCNC-
12	-0120	\$40.12	\$40.30	\$36.88	\$32.34	\$32.60	\$42.01
24	-0240	\$41.52	\$41.88	\$40.38	\$32.78	\$33.30	\$50.64
36	-0360	\$42.92	\$43.46	\$43.88	\$33.22	\$34.00	\$59.27
48	-0480	\$44.32	\$45.04	\$47.38	\$33.66	\$34.70	\$67.90
60	-0600	\$45.72	\$46.62	\$50.88	\$34.10	\$35.40	\$76.53
Color Designators (add letter to the end of the part number and add \$1.00 to price)							
Black - B		Blue - L		Brown - N		Gray - A	
Orange - O		Red - R		Violet - V		Green - G	
						White - W	

See Page B5 for Cable Characteristics

* Contact Factory for delivery, Consider new RD316 for (RD188) 10% Discount @ 25 pcs. up 4% Discount @ 10 pcs. up

† Brass Body Stainless Steel Nut



RF Depot.com Inc.

Phone 856-488-2000 Fax 856-488-2020

7850 Browning Rd. Pennsauken, NJ 08109

Online @ www.rfdepot.com

Toll Free 877-RF Depot

B107

QMA Female Bulkhead Jack x QMA Male Plug

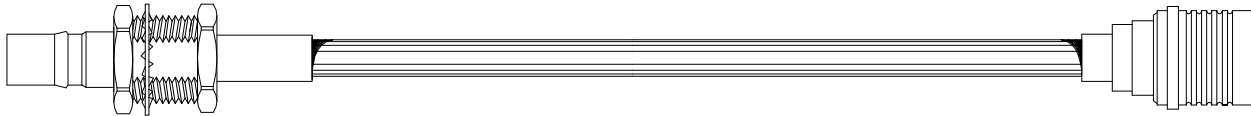

LENGTH IN INCHES	DASH NUMBER	50 Ω ^⑦ RG 58C ^③ 1 shield 058-QAQF-	50 Ω ^{③①} RG 223 2 shields ^⑦ 223-QAQF-	50 Ω ^{④②} RG142B 2 shields ^⑦ 142-QAQF-	50 Ω ^{①⑦} RG 400* ^④ 2 shields 400-QAQF-	50 Ω ^③ SIG 195 ^③ 2 shields ^③ 19C-QAQF-	50 Ω ^③ LMR 195 ^③ 2 shields ^③ 19M-QAQF-
Solder Center, Crimp Outer							
12	-0120	\$26.73	\$27.80	\$28.63	\$29.33	\$26.90	\$27.04
24	-0240	\$27.13	\$29.27	\$30.93	\$32.33	\$27.47	\$27.75
36	-0360	\$27.53	\$30.74	\$33.23	\$35.33	\$28.04	\$28.46
48	-0480	\$27.93	\$32.21	\$35.53	\$38.33	\$28.61	\$29.17
60	-0600	\$28.33	\$33.68	\$37.83	\$41.33	\$29.18	\$29.88
72	-0720	\$28.73	\$35.15	\$40.13	\$44.33	\$29.75	\$30.59
Solder Center, Crimp Outer							
LENGTH IN INCHES	DASH NUMBER	50 Ω RG 174 ^{③⑤} 1 shield ^⑦ 174-QAQF-	50 Ω RG 316 ^{④②} 1 shield ^③ 316-QAQF-	50 Ω RD316 ^{④②} 2 shields ^⑦ 31D-QAQF-	50 Ω RG188* ^{④②} 1 shield ^③ 188-QAQF-	75 Ω RG179A ^{④②} 1 shield ^③ 179-QAQF-	
12	-0120	\$25.90	\$26.31	\$27.51	\$26.66	\$26.39	
24	-0240	\$26.14	\$26.96	\$29.36	\$27.66	\$27.12	
36	-0360	\$26.38	\$27.61	\$31.21	\$28.66	\$27.85	
48	-0480	\$26.62	\$28.26	\$33.06	\$29.66	\$28.58	
60	-0600	\$26.86	\$28.91	\$34.91	\$30.66	\$29.31	
72	-0720	\$27.10	\$29.56	\$36.76	\$31.66	\$30.04	
.141" Diameter SEMIRIGID and Maxi Flex. Direct Solder Connectors							
LENGTH IN INCHES	DASH NUMBER	50Ω RG 402 ^② M17/130-00004 .141 Cu Jacket 402-Q0Q5-	50Ω RG 402 ^② M17/130-00005 .141 Tin Plate Cu 1TS-Q0Q5-	50Ω RG 402 ^① M17/130-00009 .141 Tin Plate Al 1AT-Q0Q5-	50ΩMaxiFlex ^② No QPL List .141 Tin Pl 14F-Q0Q5-	50Ω RG 402 ^② M17/130-00012 .141 Silver Pl 1SS-Q0Q5-	
12	-0120	\$27.42	\$27.06	\$27.42	\$27.06	\$36.63	
24	-0240	\$31.02	\$30.30	\$31.02	\$30.30	\$49.44	
36	-0360	\$34.62	\$33.54	\$34.62	\$33.54	\$62.25	
48	-0480	\$38.22	\$36.78	\$38.22	\$36.78	\$75.06	
60	-0600	\$41.82	\$40.02	\$41.82	\$40.02	\$87.87	
72	-0720	\$45.42	\$43.26	\$45.42	\$43.26	\$100.68	
Color Designators (add letter to the end of the part number and add \$1.00 to price)							
Black - B		Blue - L		Brown - N		Gray - A	
Orange - O		Red - R		Violet - V		Green - G	
						White - W	

See Page B5 for Cable Characteristics

* Contact Factory for delivery, Consider new RD316 for (RD188) 10% Discount @ 25 pcs. up 4% Discount @ 10 pcs. up

①Silver Plated Copper Center Conductor ②Silver Plated Copper Clad Steel Center Conductor



RF Depot.com Inc.

Phone 856-488-2000 Fax 856-488-2020

QMA Male Plug x QMA Male Plug

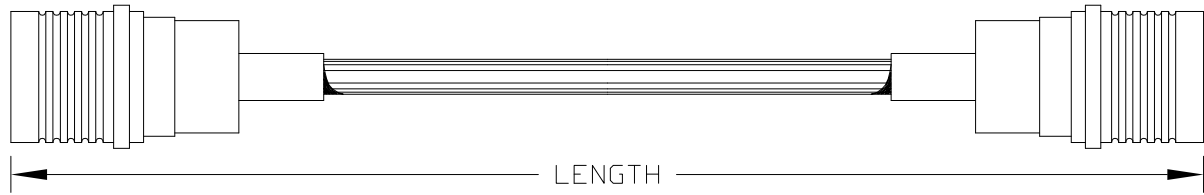

LENGTH IN INCHES	DASH NUMBER	50 Ω ^{⑥⑦} RG 58C ^③ 1 shield 058-QAQA-	50 Ω RG 223 ^{④①} 2 shields ^⑦ 223-QAQA-	50 Ω ^{④②} RG142B 2 shields ^⑦ 142-QAQA-	50 Ω ^{①⑦} RG 400* ^④ 2 shields 400-QAQA-	50 Ω ^③ SIG 195 ^⑥ 2 shields ^⑨ 19C-QAQA-	50 Ω ^③ LMR 195 ^⑥ 2 shields ^⑨ 19M-QAQA-	
Solder Center, Crimp Outer								
12	-0120	\$23.14	\$24.21	\$25.04	\$25.74	\$23.31	\$23.45	
24	-0240	\$23.54	\$25.68	\$27.34	\$28.74	\$23.88	\$24.16	
36	-0360	\$23.94	\$27.15	\$29.64	\$31.74	\$24.45	\$24.87	
48	-0480	\$24.34	\$28.62	\$31.94	\$34.74	\$25.02	\$25.58	
60	-0600	\$24.74	\$30.09	\$34.24	\$37.74	\$25.59	\$26.29	
72	-0720	\$25.14	\$31.56	\$36.54	\$40.74	\$26.16	\$27.00	
Solder Center, Crimp Outer								
LTH IN INS	DASH NUM	50 Ω RG 174 ^{⑤⑥} 1 shield ^⑦ 174-QAQA-	50 Ω RG 316 ^{④②} 1 shield ^⑩ 316-QAQA-	50 Ω RD316 ^{④②} 2 shields ^⑦ 31D-QAQA-	50 Ω RG188* ^{④②} 1 shield ^⑩ 188-QAQA-	75 Ω RG179A ^{④②} 1 shield ^⑩ 179-QAQA-	50 Ω ^{③⑨} SIG 240 ^⑥ 2 shields 24C-QAQA-	50 Ω ^{③⑨} LMR 240 ^⑥ 2 shields 24L-QAQA-
12	-0120	\$22.48	\$22.89	\$24.09	\$23.24	\$22.97	\$32.40	\$32.82
24	-0240	\$22.72	\$23.54	\$25.94	\$24.24	\$23.70	\$33.00	\$33.84
36	-0360	\$22.96	\$24.19	\$27.79	\$25.24	\$24.43	\$33.60	\$34.86
48	-0480	\$23.20	\$24.84	\$29.64	\$26.24	\$25.16	\$34.20	\$35.88
60	-0600	\$23.44	\$25.49	\$31.49	\$27.24	\$25.89	\$34.80	\$36.90
72	-0720	\$23.68	\$26.14	\$33.34	\$28.24	\$26.62	\$35.40	\$37.92
.141/.085" Diameter SEMIRIGID and Maxi Flex. Direct Solder Connectors								
LTH IN INS	DASH NUM	50Ω RG 402 ^② M17/130-00004 .141 Cu Jacket 402-QAQA-	50Ω RG 402 ^② M17/130-00005 .141 Tin Pl Cu 1TS-QAQA-	50ΩMaxiFlex ^② No QPL List .141 Tin Pl 14F-QAQA-	50Ω RG 405 ^② M17/133-00007 .085 Tin Pl Cu 405-QAQA-	50Ω RG 405 ^② M17/133-00007 .085 Tin Pl Cu 8TS-QAQA-	50ΩMaxiFlex ^② No QPL List .085 Tin Pl 08F-QAQA-	
12	-0120	\$26.34	\$25.98	\$25.98	\$25.76	\$25.76	\$26.99	
24	-0240	\$29.94	\$29.22	\$29.22	\$28.78	\$28.78	\$31.24	
36	-0360	\$33.54	\$32.46	\$32.46	\$31.80	\$31.80	\$35.49	
48	-0480	\$37.14	\$35.70	\$35.70	\$34.82	\$34.82	\$39.74	
60	-0600	\$40.74	\$38.94	\$38.94	\$37.84	\$37.84	\$43.99	
72	-0720	\$44.34	\$42.18	\$42.18	\$40.86	\$40.86	\$48.24	
Color Designators (add letter to the end of the part number and add \$1.00 to price)								
Black - B		Blue - L		Brown - N		Gray - A		
Orange - O		Red - R		Violet - V		Green - G		
						White - W		

See Page B5 for Cable Characteristics

* Contact Factory for delivery, Consider new RD316 for (RD188) 10% Discount @ 25 pcs. up 4% Discount @ 10 pcs. up

①Silver Plated Copper Center Conductor ②Silver Plated Copper Clad Steel Center Conductor



RF Depot.com Inc.

Phone 856-488-2000 Fax 856-488-2020

7850 Browning Rd. Pennsauken, NJ 08109

Online @ www.rfdepot.com

Toll Free 877-RF Depot

B109

QMA Male Plug x QMA Right Angle Male Plug



←————— LENGTH —————→

LENGTH IN INCHES	DASH NUMBER	50 Ω ^① RG 58C ^③ 1 shield 058-QAQC-	50 Ω ^② ^① RG 223 2 shields ^⑦ 223-QAQC-	50 Ω ^④ ^② RG142B 2 shields ^⑦ 142-QAQC-	50 Ω ^① ^⑦ RG 400 [✕] ^④ 2 shields 400-QAQC-	50 Ω ^③ SIG 195 ^⑥ 2 shields ^⑧ 19C-QAQC-	50 Ω ^③ LMR 195 ^⑥ 2 shields ^⑧ 19M-QAQC-
------------------	-------------	---	---	---	--	--	--

Solder Center, Crimp Outer

12	-0120	\$23.62	\$24.69	\$25.52	\$26.22	\$23.79	\$23.93
24	-0240	\$24.02	\$26.16	\$27.82	\$29.22	\$24.36	\$24.64
36	-0360	\$24.42	\$27.63	\$30.12	\$32.22	\$24.93	\$25.35
48	-0480	\$24.82	\$29.10	\$32.42	\$35.22	\$25.50	\$26.06
60	-0600	\$25.22	\$30.57	\$34.72	\$38.22	\$26.07	\$26.77
72	-0720	\$25.62	\$32.04	\$37.02	\$41.22	\$26.64	\$27.48

Solder Center, Crimp Outer

LENGTH IN INCHES	DASH NUMBER	50 Ω RG 174 ^⑥ ^⑤ 1 shield ^⑦ 174-QAQC-	50 Ω RG 316 ^⑥ ^② 1 shield ^⑧ 316-QAQC-	50 Ω RD316 ^⑥ ^② 2 shields ^⑦ 31D-QAQC-	50 Ω RG188 [✕] ^④ ^② 1 shield ^⑧ 188-QAQC-	75 Ω RG179A ^⑥ ^② 1 shield ^⑧ 179-QAQC-	50 Ω ^③ ^⑧ SIG 240 ^⑥ 2 shields 24C-QAQC-	50 Ω ^③ ^⑧ LMR 240 ^⑥ 2 shields 24L-QAQC-
12	-0120	\$22.93	\$23.34	\$24.54	\$23.69	\$23.42	\$33.10	\$33.52
24	-0240	\$23.17	\$23.99	\$26.39	\$24.69	\$24.15	\$33.70	\$34.54
36	-0360	\$23.41	\$24.64	\$28.24	\$25.69	\$24.88	\$34.30	\$35.56
48	-0480	\$23.65	\$25.29	\$30.09	\$26.69	\$25.61	\$34.90	\$36.58
60	-0600	\$23.89	\$25.94	\$31.94	\$27.69	\$26.34	\$35.50	\$37.60
72	-0720	\$24.13	\$26.59	\$33.79	\$28.69	\$27.07	\$36.10	\$38.62

.141/.085" Diameter SEMIRIGID and Maxi Flex. Direct Solder Connectors

LTH IN INS	DASH NUM	50Ω RG 402 ^② M17/130-00004 .141 Cu Jacket 402-Q0Q2-	50Ω RG 402 ^② M17/130-00005 .141 Tin Pl Cu 1TS-Q0Q2-	50ΩMaxiFlex ^② No QPL List .141 Tin Pl 14F-Q0Q2-	50Ω RG 405 ^② M17/133-00007 .085 Tin Pl Cu 405-Q0Q2-	50Ω RG 405 ^② M17/133-00007 .085 Tin Pl Cu 8TS-Q0Q2-	50ΩMaxiFlex ^② No QPL List .085 Tin Pl 08F-Q0Q2-
12	-0120	\$27.07	\$26.71	\$26.71	\$26.49	\$26.49	\$27.72
24	-0240	\$30.67	\$29.95	\$29.95	\$29.51	\$29.51	\$31.97
36	-0360	\$34.27	\$33.19	\$33.19	\$32.53	\$32.53	\$36.22
48	-0480	\$37.87	\$36.43	\$36.43	\$35.55	\$35.55	\$40.47
60	-0600	\$41.47	\$39.67	\$39.67	\$38.57	\$38.57	\$44.72
72	-0720	\$45.07	\$42.91	\$42.91	\$41.59	\$41.59	\$48.97

Color Designators (add letter to the end of the part number and add \$1.00 to price)

Black - B	Blue - L	Brown - N	Gray - A	Green - G
Orange - O	Red - R	Violet - V	Yellow - Y	White - W

See Page B5 for Cable Characteristics

* Contact Factory for delivery, Consider new RD316 for (RD188) 10% Discount @ 25 pcs. up 4% Discount @ 10 pcs. up

①Silver Plated Copper Center Conductor ②Silver Plated Copper Clad Steel Center Conductor



RF Depot.com Inc.

Phone 856-488-2000 Fax 856-488-2020

B110

7850 Browning Rd. Pennsauken, NJ 08109

Online @ www.rfdepot.com

Toll Free 877-RF Depot

QMA Male Plug x SMA Male Plug

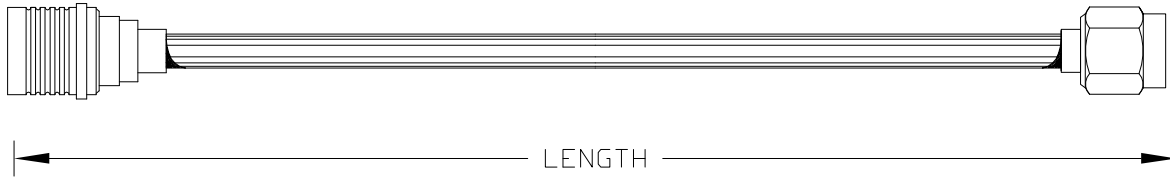

LTH IN INS	DASH NUM	50 Ω ^⑦ RG 58C ^⑤ 1 shield 058-MAQA-	50 Ω ^{③①} RG 223 2 shields ^⑦ 223-MAQA-	50 Ω ^{④②} RG142B 2 shields ^⑦ 142-MAQA-	50 Ω ^{①⑦} RG 400 ^{✕④} 2 shields 400-MAQA-	50 Ω ^③ SIG 195 ^⑥ 2 shields ^③ 19C-MAQA-	50 Ω ^③ LMR 195 ^⑥ 2 shields ^③ 19M-MAQA-	
Solder Center, Crimp Outer								
12	-0120	\$25.30	\$27.66	\$28.49	\$29.19	\$25.47	\$25.61	
24	-0240	\$25.70	\$29.13	\$30.79	\$32.19	\$26.04	\$26.32	
36	-0360	\$26.10	\$30.60	\$33.09	\$35.19	\$26.61	\$27.03	
48	-0480	\$26.50	\$32.07	\$35.39	\$38.19	\$27.18	\$27.74	
60	-0600	\$26.90	\$33.54	\$37.69	\$41.19	\$27.75	\$28.45	
72	-0720	\$27.30	\$35.01	\$39.99	\$44.19	\$28.32	\$29.16	
Solder Center, Crimp Outer								
LTH IN INS	DASH NUM	50 Ω RG 174 ^{⑤⑦} 1 shield ^⑦ 174-MAQA-	50 Ω RG 316 ^{④②} 1 shield ^⑩ 316-MAQA-	50 Ω RD316 ^{④②} 2 shields ^⑦ 31D-MAQA-	50 Ω RG188 ^{*④②} 1 shield ^⑩ 188-MAQA-	75 Ω RG179A ^{④②} 1 shield ^⑩ 179-MAQA-	50 Ω ^{③③} SIG 240 ^⑥ 2 shields 24C-MAQA-	50 Ω ^{③③} LMR 240 ^⑥ 2 shields 24L-MAQA-
12	-0120	\$22.94	\$23.35	\$23.00	\$23.70	\$23.43	\$28.08	\$28.52
24	-0240	\$23.18	\$24.00	\$24.85	\$24.70	\$24.16	\$28.68	\$29.54
36	-0360	\$23.42	\$24.65	\$26.70	\$25.70	\$24.89	\$29.28	\$30.56
48	-0480	\$23.66	\$25.30	\$28.55	\$26.70	\$25.62	\$29.88	\$31.58
60	-0600	\$23.90	\$25.95	\$30.40	\$27.70	\$26.35	\$30.48	\$32.50
72	-0720	\$24.14	\$26.60	\$32.25	\$28.70	\$27.08	\$31.08	\$33.62
.141/.085" Diameter SEMIRIGID and Maxi Flex. Direct Solder Connectors								
LTH IN INS	DASH NUM	50Ω RG 402 ^② M17/130-00004 .141 Cu Jacket 402-M0Q0-	50Ω RG 402 ^② M17/130-00005 .141 Tin Pl Cu 1TS-M0Q0-	50ΩMaxiFlex ^② No QPL List .141 Tin Pl 14F-M0Q0-	50Ω RG 405 ^② M17/133-00007 .085 Tin Pl Cu 405-M0Q0-	50Ω RG 405 ^② M17/133-00007 .085 Tin Pl Cu 8TS-M0Q0-	50ΩMaxiFlex ^② No QPL List .085 Tin Pl 08F-M0Q0-	
12	-0120	\$26.01	\$25.65	\$25.65	\$25.11	\$25.11	\$26.34	
24	-0240	\$29.61	\$28.89	\$28.89	\$28.13	\$28.13	\$30.59	
36	-0360	\$33.21	\$32.13	\$32.13	\$31.15	\$31.15	\$34.84	
48	-0480	\$36.81	\$35.37	\$35.37	\$34.17	\$34.17	\$39.09	
60	-0600	\$40.41	\$38.61	\$38.61	\$37.19	\$37.19	\$43.34	
72	-0720	\$44.01	\$41.85	\$41.85	\$40.21	\$40.21	\$47.59	
Color Designators (add letter to the end of the part number and add \$1.00 to price)								
Black - B		Blue - L		Brown - N		Gray - A		
Orange - O		Red - R		Violet - V		Yellow - Y		
						Green - G		
						White - W		

See Page B5 for Cable Characteristics

* Contact Factory for delivery, Consider new RD316 for (RD188) 10% Discount @ 25 pcs. up 4% Discount @ 10 pcs. up

①Silver Plated Copper Center Conductor ②Silver Plated Copper Clad Steel Center Conductor



RF Depot.com Inc.

Phone 856-488-2000 Fax 856-488-2020

7850 Browning Rd. Pennsauken, NJ 08109

Online @ www.rfdepot.com

Toll Free 877-RF Depot

B111

QMA Right Angle Male Plug x QMA Right Angle Male Plug

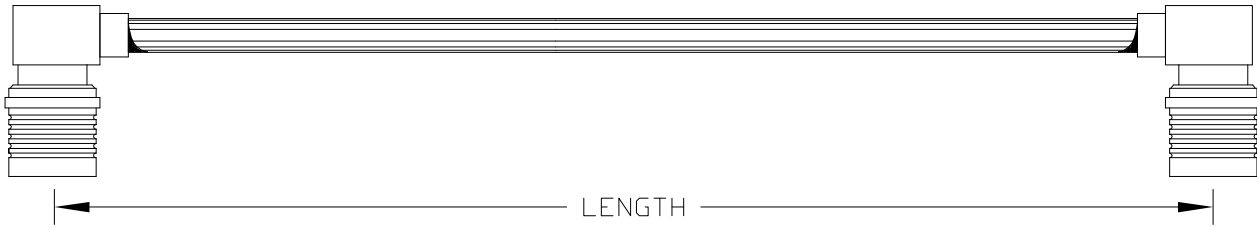

LENGTH IN INCHES	DASH NUMBER	50 Ω ^⑦ RG 58C ^⑥ 1 shield 058-QCQC-	50 Ω ^{③①} RG 223 2 shields ^⑦ 223-QCQC-	50 Ω ^{④②} RG142B 2 shields ^⑦ 142-QCQC-	50 Ω ^{①⑦} RG 400* ^④ 2 shields 400-QCQC-	50 Ω ^③ SIG 195 ^⑥ 2 shields ^⑥ 19C-QCQC-	50 Ω ^③ LMR 195 ^⑥ 2 shields ^⑥ 19M-QCQC-	
Solder Center, Crimp Outer								
12	-0120	\$24.10	\$25.17	\$26.00	\$26.70	\$24.27	\$24.41	
24	-0240	\$24.50	\$26.64	\$28.30	\$29.70	\$24.84	\$25.12	
36	-0360	\$24.90	\$28.11	\$30.60	\$32.70	\$25.41	\$25.83	
48	-0480	\$25.30	\$29.58	\$32.90	\$35.70	\$25.98	\$26.54	
60	-0600	\$25.70	\$31.05	\$35.20	\$38.70	\$26.55	\$27.25	
72	-0720	\$26.10	\$32.52	\$37.50	\$41.70	\$27.12	\$27.96	
Solder Center, Crimp Outer								
LENGTH IN INCHES	DASH NUM	50 Ω ^{⑥⑦} RG 174 ^{⑥⑦} 1 shield ^⑦ 174-QCQC-	50 Ω ^{④②} RG 316 ^{④②} 1 shield ^⑥ 316-QCQC-	50 Ω ^{④②} RD316 ^{④②} 2 shields ^⑦ 31D-QCQC-	50 Ω ^{④②} RG188* ^{④②} 1 shield ^⑥ 188-QCQC-	75 Ω ^{④②} RG179A ^{④②} 1 shield ^⑥ 179-QCQC-	50 Ω ^{③⑥} SIG 240 ^⑥ 2 shields 24C-QCQC-	50 Ω ^{③⑥} LMR 240 ^⑥ 2 shields 24L-QCQC-
12	-0120	\$23.38	\$23.79	\$24.99	\$24.14	\$23.87	\$33.80	\$34.22
24	-0240	\$23.62	\$24.44	\$26.84	\$25.14	\$24.60	\$34.40	\$35.24
36	-0360	\$23.86	\$25.09	\$28.69	\$26.14	\$25.33	\$35.00	\$36.26
48	-0480	\$24.10	\$25.74	\$30.54	\$27.14	\$26.06	\$35.60	\$37.28
60	-0600	\$24.34	\$26.39	\$32.39	\$28.14	\$26.79	\$36.20	\$38.30
72	-0720	\$24.58	\$27.04	\$34.24	\$29.14	\$27.52	\$36.80	\$39.32
.141/.085" Diameter SEMIRIGID and Maxi Flex. Direct Solder Connectors								
LTH IN INS	DASH NUM	50Ω RG 402 ^② M17/130-00004 .141 Cu Jacket 402-Q2Q2-	50Ω RG 402 ^② M17/130-00005 .141 Tin Plate Cu 1TS-Q2Q2-	50ΩMaxiFlex ^② No QPL List .141 Tin Pl 14F-Q2Q2-	50Ω RG 405 ^② M17/133-00007 .085 Tin Plate Cu 405-Q2Q2-	50Ω RG 405 ^② M17/133-00007 .085 Tin Plate Cu 8TS-Q2Q2-	50ΩMaxiFlex ^② No QPL List .085 Tin Pl 08F-Q2Q2-	
12	-0120	\$29.26	\$28.90	\$28.90	\$27.86	\$27.86	\$29.09	
24	-0240	\$32.86	\$32.14	\$32.14	\$30.88	\$30.88	\$33.34	
36	-0360	\$36.46	\$35.38	\$35.38	\$33.90	\$33.90	\$37.59	
48	-0480	\$40.06	\$38.62	\$38.62	\$36.92	\$36.92	\$41.84	
60	-0600	\$43.66	\$41.86	\$41.86	\$39.94	\$39.94	\$46.09	
72	-0720	\$47.26	\$45.10	\$45.10	\$42.96	\$42.96	\$50.34	
Color Designators (add letter to the end of the part number and add \$1.00 to price)								
Black - B		Blue - L		Brown - N		Gray - A		
Orange - O		Red - R		Violet - V		Green - G		
						White - W		

See Page B5 for Cable Characteristics

* Contact Factory for delivery, Consider new RD316 for (RD188) 10% Discount @ 25 pcs. up 4% Discount @ 10 pcs. up

①Silver Plated Copper Center Conductor ②Silver Plated Copper Clad Steel Center Conductor



RF Depot.com Inc.

Phone 856-488-2000 Fax 856-488-2020

QMA Right Angle Male Plug x SMA Male Plug

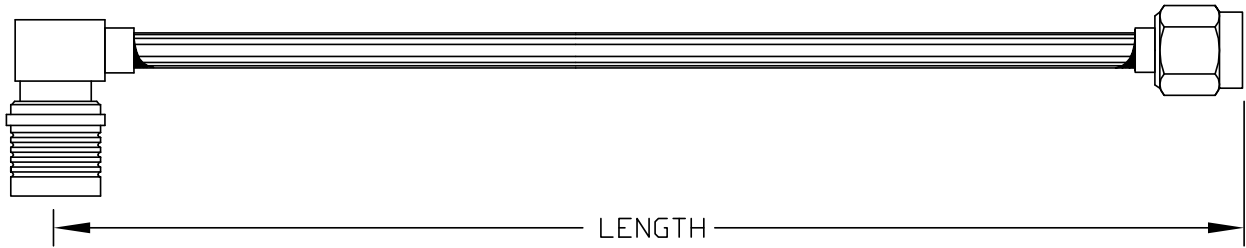

LENGTH IN INCHES	DASH NUMBER	50 Ω ^⑦ RG 58C ^⑥ 1 shield 058-MAQC-	50 Ω ^{⑧①} RG 223 2 shields ^⑦ 223-MAQC-	50 Ω ^{④②} RG142B 2 shields ^⑦ 142-MAQC-	50 Ω ^{①⑦} RG 400* ^④ 2 shields 400-MAQC-	50 Ω ^③ SIG 195 ^⑥ 2 shields ^⑥ 19C-MAQC-	50 Ω ^③ LMR 195 ^⑥ 2 shields ^⑥ 19M-MAQC-	
Solder Center, Crimp Outer								
12	-0120	\$25.78	\$29.54	\$30.37	\$31.07	\$25.95	\$26.09	
24	-0240	\$26.18	\$31.01	\$32.67	\$34.07	\$26.52	\$26.80	
36	-0360	\$26.58	\$32.48	\$34.97	\$37.07	\$27.09	\$27.51	
48	-0480	\$26.98	\$33.95	\$37.27	\$40.07	\$27.66	\$28.22	
60	-0600	\$27.38	\$35.42	\$39.57	\$43.07	\$28.23	\$28.93	
72	-0720	\$27.78	\$36.89	\$41.87	\$46.07	\$28.80	\$29.64	
Solder Center, Crimp Outer								
LENGTH IN INCHES	DASH NUMBER	50 Ω RG 174 ^{⑥⑦} 1 shield ^⑦ 174-MAQC-	50 Ω RG 316 ^{④②} 1 shield ^⑥ 316-MAQC-	50 Ω RD316 ^{④②} 2 shields ^⑦ 31D-MAQC-	50 Ω RG188* ^{④②} 1 shield ^⑥ 188-MAQC-	75 Ω RG179A ^{④②} 1 shield ^⑥ 179-MAQC-	50 Ω ^{③⑥} SIG 240 ^⑥ 2 shields 24C-MAQC-	50 Ω ^{③⑥} LMR 240 ^⑥ 2 shields 24L-MAQC-
12	-0120	\$23.39	\$23.80	\$23.45	\$24.15	\$23.88	\$28.78	\$29.22
24	-0240	\$23.63	\$24.45	\$25.30	\$25.15	\$24.61	\$29.38	\$30.24
36	-0360	\$23.87	\$25.10	\$27.15	\$26.15	\$25.34	\$29.98	\$31.26
48	-0480	\$24.11	\$25.75	\$29.00	\$27.15	\$26.07	\$30.58	\$32.28
60	-0600	\$24.35	\$26.40	\$30.85	\$28.15	\$26.80	\$31.18	\$33.30
72	-0720	\$24.59	\$27.05	\$32.70	\$29.15	\$27.53	\$31.78	\$34.32
.141/.085" Diameter SEMIRIGID and Maxi Flex. Direct Solder Connectors								
LTH IN INS	DASH NUM	50Ω RG 402 ^② M17/130-00004 .141 Cu Jacket 402-M0Q2-	50Ω RG 402 ^② M17/130-00005 .141 Tin Pl Cu 1TS-M0Q2-	50ΩMaxiFlex ^② No QPL List .141 Tin Pl 14F-M0Q2-	50Ω RG 405 ^② M17/133-00007 .085 Tin Plate Cu 405-M0Q2-	50Ω RG 405 ^② M17/133-00007 .085 Tin Pl Cu 8TS-M0Q2-	50ΩMaxiFlex ^② No QPL List .085 Tin Pl 08F-M0Q2-	
12	-0120	\$27.47	\$27.11	\$27.11	\$26.48	\$26.48	\$27.71	
24	-0240	\$31.07	\$30.35	\$30.35	\$29.50	\$29.50	\$31.96	
36	-0360	\$34.67	\$33.59	\$33.59	\$32.52	\$32.52	\$36.21	
48	-0480	\$38.27	\$36.83	\$36.83	\$35.54	\$35.54	\$40.46	
60	-0600	\$41.87	\$40.07	\$40.07	\$38.56	\$38.56	\$44.71	
72	-0720	\$45.47	\$43.31	\$43.31	\$41.58	\$41.58	\$48.96	
Color Designators (add letter to the end of the part number and add \$1.00 to price)								
Black - B		Blue - L		Brown - N		Gray - A		
Orange - O		Red - R		Violet - V		Green - G		
						White - W		

See Page B5 for Cable Characteristics

* Contact Factory for delivery, Consider new RD316 for (RD188) 10% Discount @ 25 pcs. up 4% Discount @ 10 pcs. up

①Silver Plated Copper Center Conductor ②Silver Plated Copper Clad Steel Center Conductor



RF Depot.com Inc.

Phone 856-488-2000 Fax 856-488-2020

7850 Browning Rd. Pennsauken, NJ 08109

Online @ www.rfdepot.com

Toll Free 877-RF Depot

B113

QN Female Jack x QN Male Plug

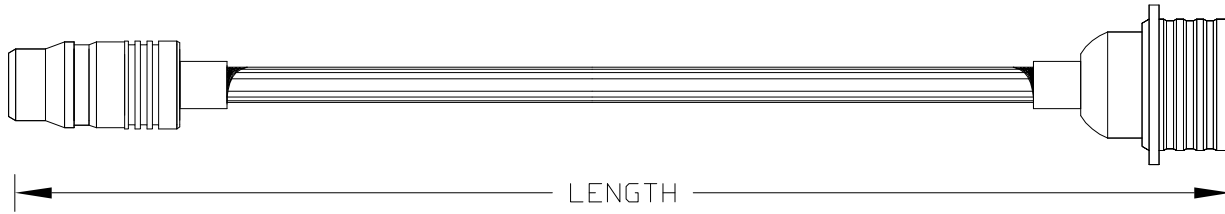

LENGTH IN INCHES	DASH NUMBER	50Ω RG 401① M17/129-RG401 .250 Cu Jacket 401-QN0QN1-	50Ω RG 401① No QPL List .250 Tin Plate Al 25A-QN0QN1-	50Ω RG 401② M17/129-00001 .250 Tin Plate Cu 2TS-QN0QN1-	50Ω MaxiFlex② No QPL List .250 Tin Plate Braid 25F-QN0QN1-	
.250" Diameter SEMIRIGID and Maxi Flex. Direct Solder Connectors						
12	-0120	\$48.75	\$49.69	\$53.94	\$48.75	
18	-0180	\$50.26	\$51.67	\$58.05	\$50.26	
24	-0240	\$51.77	\$53.65	\$62.15	\$51.77	
30	-0300	\$53.28	\$55.63	\$66.26	\$53.28	
36	-0360	\$54.79	\$57.61	\$70.36	\$54.79	
42	-0420	\$56.30	\$59.59	\$74.47	\$56.30	
48	-0480	\$57.81	\$61.57	\$78.57	\$57.81	
54	-0540	\$59.32	\$63.55	\$82.68	\$59.32	
60	-0600	\$60.83	\$65.53	\$86.78	\$60.83	
66	-0660	\$62.34	\$67.51	\$90.89	\$62.34	
72	-0720	\$63.85	\$69.49	\$94.99	\$63.85	
.141" Diameter SEMIRIGID and Maxi Flex. Direct Solder Connectors						
LENGTH IN INCHES	DASH NUMBER	50Ω RG 402② M17/130-00004 .141 Cu Jacket 402-QN0QN1-	50Ω RG 402② M17/130-00005 .141 Tin Plate Cu 1TS-QN0QN1-	50Ω RG 402① M17/130-00009 .141 Tin Plate Al 1AT-QN0QN1-	50Ω MaxiFlex② No QPL List .141 Tin Pl 14F-QN0QN1-	50Ω RG 402② M17/130-00012 .141 Silver Pl 1SS-QN0QN1-
12	-0120	\$40.46	\$40.10	\$40.46	\$40.10	\$49.67
18	-0180	\$42.26	\$41.72	\$42.26	\$41.72	\$46.08
24	-0240	\$44.06	\$43.34	\$44.06	\$43.34	\$62.48
30	-0300	\$45.86	\$44.96	\$45.86	\$44.96	\$65.55
36	-0360	\$47.66	\$46.58	\$47.66	\$46.58	\$71.96
42	-0420	\$49.46	\$48.20	\$49.46	\$48.20	\$78.36
48	-0480	\$51.26	\$49.82	\$51.26	\$49.82	\$84.77
54	-0540	\$53.06	\$51.44	\$53.06	\$51.44	\$91.17
60	-0600	\$54.86	\$53.06	\$54.86	\$53.06	\$97.58
66	-0660	\$56.66	\$54.68	\$56.66	\$54.68	\$103.98
72	-0720	\$58.46	\$56.30	\$58.46	\$56.30	\$113.72

①Silver Plated Copper Center Conductor ②Silver Plated Copper Clad Steel Center Conductor

10% Discount @ 25 pcs. up 4% Discount @ 10 pcs. up



RF Depot.com Inc.

Phone 856-488-2000 Fax 856-488-2020

B114

7850 Browning Rd. Pennsauken, NJ 08109

Online @ www.rfdepot.com

Toll Free 877-RF Depot

QN Male Plug x QN Male Plug

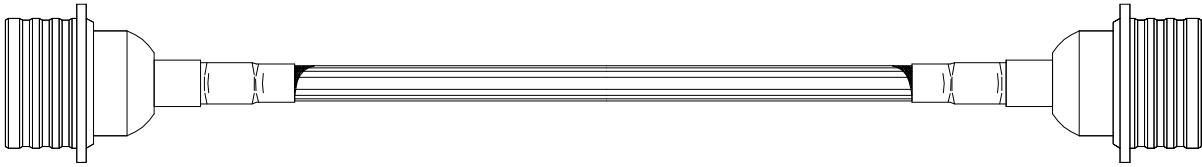

←————— LENGTH —————→

LTH IN INS	DASH NUM	50 Ω ^① RG 58C ^② 1 shield 058-QNAQNA-	50 Ω ^① RG 223 2 shields ^③ 223-QNAQNA-	50 Ω ^① RG142B 2 shields ^③ 142-QNAQNA-	50 Ω ^① RG 400* ^④ 2 shields 400-QNAQNA-	50 Ω SF 142B ^② ^③ 3 shields S42-QNAQNA-	50 Ω ^③ SIG 195 ^③ 2 shields ^③ 19C-QNAQNA-	50 Ω ^③ LMR 195 ^③ 2 shields ^③ 19M-QNAQNA-
Solder Center, Crimp Outer								
12	-0120	\$29.48	\$30.55	\$31.38	\$32.08	\$35.40	\$29.65	\$29.79
24	-0240	\$29.88	\$32.02	\$33.68	\$35.08	\$41.72	\$30.22	\$30.50
36	-0360	\$30.28	\$33.49	\$35.98	\$38.08	\$48.04	\$30.79	\$31.21
48	-0480	\$30.68	\$34.96	\$38.28	\$41.08	\$54.36	\$31.36	\$31.92
60	-0600	\$31.08	\$36.43	\$40.58	\$44.08	\$60.68	\$31.93	\$32.63
72	-0720	\$31.48	\$37.90	\$42.88	\$47.08	\$67.00	\$32.50	\$33.34
Solder Center, Crimp Outer								
LENGTH IN INCHES	DASH NUM	50 Ω RG 8* ^③ ^③ ^③ 1 shield 008-QNAQNA-	50 Ω RG 213 ^③ ^③ ^③ 1 shield 213-QNAQNA-	50 Ω RG 214 ^③ ^① 2 shields ^③ 214-QNAQNA-	50 Ω RG 393 ^③ ^① ^③ 2 shields 393-QNAQNA-	50Ω RG 401 ^① M17/129-RG401 .250 Cu Jacket 401-QNAQNA-	50Ω RG 402 ^② M17/130-00004 .141 Cu Jacket 402-QNAQNA-	
12	-0120	\$29.68	\$29.39	\$31.78	\$43.83	\$50.64	\$40.82	
24	-0240	\$31.08	\$31.44	\$35.28	\$52.46	\$53.66	\$44.42	
36	-0360	\$32.48	\$33.02	\$38.78	\$61.09	\$56.68	\$48.02	
48	-0480	\$33.88	\$34.60	\$42.28	\$69.72	\$59.70	\$51.62	
60	-0600	\$35.28	\$36.18	\$45.78	\$78.35	\$62.72	\$55.22	
72	-0720	\$36.68	\$37.76	\$49.28	\$86.98	\$65.74	\$58.82	
Solder Center, Crimp Outer								
LENGTH IN INCHES	DASH NUM	50 Ω ^④ SIG 400 ^③ 2 shields 4LC-QNAQNA-	50 Ω ^④ LMR 400 ^③ 2 shields 4LM-QNAQNA-	50 Ω ^④ SIG 400DB ^③ 2 shields 4DC-QNAQNA-	50 Ω ^④ LMR 400DB ^③ 2 shields 4LD-QNAQNA-	50 Ω ^④ SIG 400FR ^③ 2 shields 4RC-QNAQNA-	50 Ω ^④ LMR 400FR ^③ 2 shields 4LR-QNAQNA-	
12	-0120	\$123.86	\$124.38	\$123.98	\$124.60	\$123.98	\$124.90	
24	-0240	\$124.72	\$125.76	\$124.96	\$126.20	\$124.96	\$126.80	
36	-0360	\$125.58	\$127.14	\$125.94	\$127.80	\$125.94	\$128.70	
48	-0480	\$126.44	\$128.52	\$126.92	\$129.40	\$126.92	\$130.60	
60	-0600	\$127.30	\$129.90	\$127.90	\$131.00	\$127.90	\$132.50	
72	-0720	\$128.16	\$131.28	\$128.88	\$132.60	\$128.88	\$134.40	
Color Designators (add letter to the end of the part number and add \$1.00 to price)								
Black - B		Blue - L		Brown - N		Gray - A		Green - G
Orange - O		Red - R		Violet - V		Yellow - Y		White - W

See Page B5 for Cable Characteristics

* Contact Factory for delivery, Consider new RD316 for (RD188) 10% Discount @ 25 pcs. up 4% Discount @ 10 pcs. up

①Silver Plated Copper Center Conductor ②Silver Plated Copper Clad Steel Center Conductor



QN Male Plug x QN Right Angle Male Plug

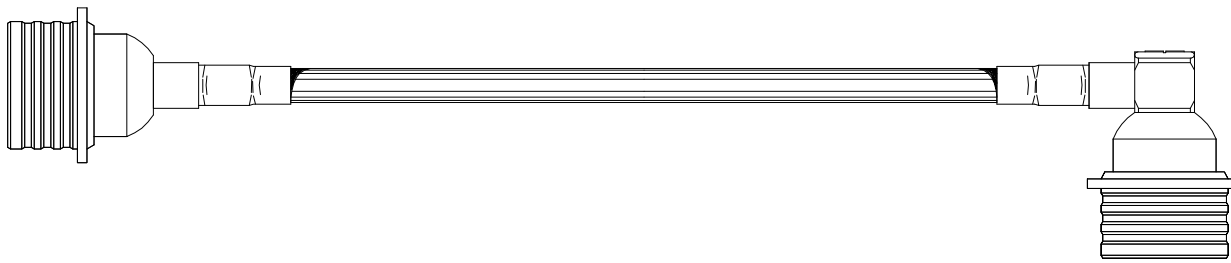

←————— LENGTH —————→

LENGTH IN INCHES	DASH NUMBER	50 Ω ^⑦ RG 58C ^③ 1 shield 058-QNAQNC-	50 Ω ^{②①} RG 223 2 shields ^⑦ 223-QNAQNC-	50 Ω ^{④②} RG142B 2 shields ^⑦ 142-QNAQNC-	50 Ω ^{①⑦} RG 400 ^{✕④} 2 shields 400-QNAQNC-
Solder Center, Crimp Outer					
12	-0120	\$32.36	\$34.63	\$35.46	\$36.16
24	-0240	\$32.76	\$36.10	\$37.76	\$39.16
36	-0360	\$33.16	\$37.57	\$40.06	\$42.16
48	-0480	\$33.56	\$39.04	\$42.36	\$45.16
60	-0600	\$33.96	\$40.51	\$44.66	\$48.16
72	-0720	\$34.36	\$41.98	\$46.96	\$51.16
Solder Center, Crimp and Solder Outer					
LENGTH IN INCHES	DASH NUMBER	50 Ω RG 393 ^{④①⑦} 2 shields 393-QNAQNC-	50 Ω EF 393 ^① 2 shields ^⑦ 93E-QNAQNC-	50 Ω RG 8* ^{③③⑧} 1 shield 008-QNAQNC-	50 Ω RG 213 ^{③③⑧} 1 shield 213-QNAQNC-
12	-0120	\$50.80	\$50.80	\$32.42	\$32.60
24	-0240	\$59.43	\$59.43	\$33.82	\$34.18
36	-0360	\$68.06	\$68.06	\$35.22	\$35.76
48	-0480	\$76.69	\$76.69	\$36.62	\$37.34
60	-0600	\$85.32	\$85.32	\$38.02	\$38.92
72	-0720	\$93.95	\$93.95	\$39.42	\$40.50
Solder Center, Crimp and Solder Outer					
LENGTH IN INCHES	DASH NUMBER	50 Ω RG 214 ^{③①} 2 shields ^⑦ 214-QNAQNC-	50 Ω ^③ SIG 195 ^① 2 shields ^③ 19C-QNAQNC-	50 Ω ^③ LMR 195 ^① 2 shields ^③ 19M-QNAQNC-	50Ω RG 402 ^② M17/130-00004 .141 Cu Jacket 402-QN0QN2-
12	-0120	\$35.45	\$32.53	\$32.67	\$46.45
24	-0240	\$38.95	\$33.10	\$33.38	\$50.05
36	-0360	\$42.45	\$33.67	\$34.09	\$53.65
48	-0480	\$45.95	\$34.24	\$34.80	\$57.25
60	-0600	\$49.45	\$34.81	\$35.51	\$60.85
Color Designators (add letter to the end of the part number and add \$1.00 to price)					
Black - B	Blue - L	Brown - N	Gray - A	Green - G	White - W
Orange - O	Red - R	Violet - V	Yellow - Y		

See Page B5 for Cable Characteristics

* Contact Factory for delivery, Consider new RD316 for (RD188) 10% Discount @ 25 pcs. up 4% Discount @ 10 pcs. up

①Silver Plated Copper Center Conductor ②Silver Plated Copper Clad Steel Center Conductor



RF Depot.com Inc.

Phone 856-488-2000 Fax 856-488-2020

B116

7850 Browning Rd. Pennsauken, NJ 08109

Online @ www.rfdepot.com

Toll Free 877-RF Depot

QN Right Angle Male Plug x QN Right Angle Male Plug

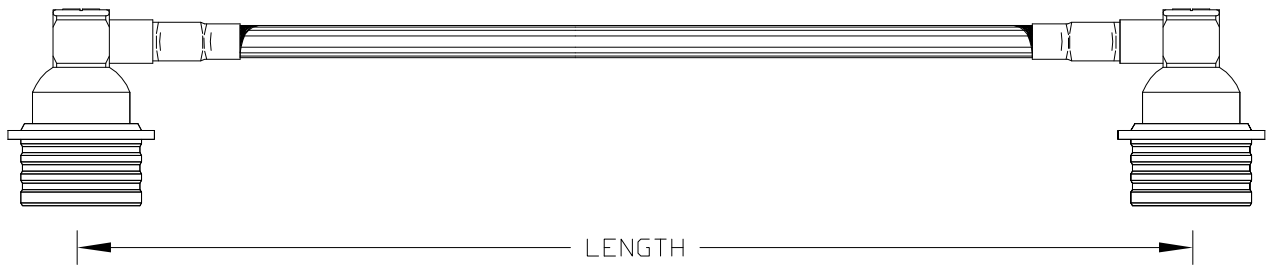

LENGTH IN INCHES	DASH NUMBER	50 Ω ^③ SIG 195 [Ⓞ] 2 shields [Ⓞ] 19C-QNCQNC-	50 Ω ^③ LMR 195 [Ⓞ] 2 shields [Ⓞ] 19M-QNCQNC-	50 Ω ^{③④} SIG 240 [Ⓞ] 2 shields 24C-QNCQNC-	50 Ω ^{③④} LMR 240 [Ⓞ] 2 shields 24L-QNCQNC-				
Solder Center, Crimp Outer									
12	-0120	\$35.41	\$35.55	\$53.26	\$53.68				
24	-0240	\$35.98	\$36.26	\$53.86	\$54.70				
36	-0360	\$36.55	\$36.97	\$54.46	\$55.72				
48	-0480	\$37.12	\$37.68	\$55.06	\$56.74				
60	-0600	\$37.69	\$38.39	\$55.66	\$57.76				
72	-0720	\$38.26	\$39.10	\$56.26	\$58.78				
Solder Center, Crimp Outer									
LENGTH IN INCHES	DASH NUMBER	50 Ω ^{⑥⑦} RG 58C [Ⓞ] 1 shield 058-QNCQNC-	50 Ω ^{⑧①} RG 223 2 shields ^⑦ 223-QNCQNC-	50 Ω ^{④②} RG142B 2 shields ^⑦ 142-QNCQNC-	50 Ω ^① RG 400 ^{✕④} 2 shields ^⑦ 400-QNCQNC-				
12	-0120	\$35.24	\$38.71	\$39.54	\$40.24				
24	-0240	\$35.64	\$40.18	\$41.84	\$43.24				
36	-0360	\$36.04	\$41.65	\$44.14	\$46.24				
48	-0480	\$36.44	\$43.12	\$46.44	\$49.24				
60	-0600	\$36.84	\$44.59	\$48.74	\$52.24				
72	-0720	\$37.24	\$46.06	\$51.04	\$55.24				
Solder Center, Crimp Outer									
LENGTH IN INCHES	DASH NUMBER	50 Ω RG 8* ^{Ⓞ③③} 1 shield 008-QNCQNC-	50 Ω RG 213 ^{Ⓞ③③} 1 shield 213-QNCQNC-	50 Ω RG 214 ^{Ⓞ①} 2 shields ^⑦ 214-QNCQNC-	50 Ω RG 393 ^{Ⓞ①⑦} 2 shields 393-QNCQNC-	50Ω RG 402 [Ⓞ] M17/130-00004 .141 Cu Jacket 402-QNCQNC-			
12	-0120	\$35.16	\$35.34	\$39.12	\$44.25	\$52.08			
24	-0240	\$36.56	\$36.92	\$42.62	\$52.88	\$55.68			
36	-0360	\$37.96	\$38.50	\$46.12	\$61.51	\$59.28			
48	-0480	\$39.36	\$40.08	\$49.62	\$70.14	\$62.88			
60	-0600	\$40.76	\$41.66	\$53.12	\$78.77	\$66.48			
72	-0720	\$42.16	\$43.24	\$56.62	\$87.40	\$70.08			
Color Designators (add letter to the end of the part number and add \$1.00 to price)									
Black - B		Blue - L		Brown - N		Gray - A		Green - G	
Orange - O		Red - R		Violet - V		Yellow - Y		White - W	

See Page B5 for Cable Characteristics

* Contact Factory for delivery, Consider new RD316 for (RD188) 10% Discount @ 25 pcs. up 4% Discount @ 10 pcs. up

①Silver Plated Copper Center Conductor ②Silver Plated Copper Clad Steel Center Conductor



RF Depot.com Inc.

Phone 856-488-2000 Fax 856-488-2020

7850 Browning Rd. Pennsauken, NJ 08109

Online @ www.rfdepot.com

Toll Free 877-RF Depot

B117

SC Male Plug x SC Male Plug

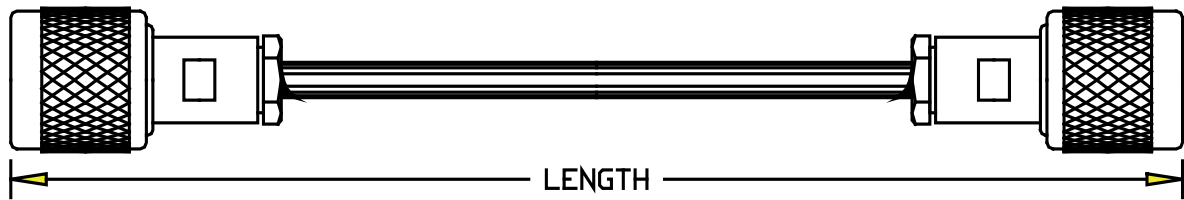

LENGTH IN INCHES	DASH NUMBER	50 Ω ⑥⑦ RG 58C③ 1 shield 058-SC0SC0-	50 Ω ③① RG 223 2 shields⑦ 223-SC0SC0-	50 Ω ④② RG 142B 2 shields⑦ 142-SC0SC0-	50 Ω ③③ RG 217/U 2 shields 217-SC0SC0-	50 Ω ③⑧ RG 218 1 shield 218-SC0SC0-
Solder Center, Clamp Outer						
12	-0120	\$157.15	\$153.97	\$154.80	\$284.50	\$336.68
24	-0240	\$157.55	\$155.44	\$157.10	\$286.00	\$350.76
36	-0360	\$157.95	\$156.91	\$159.40	\$287.50	\$364.84
48	-0480	\$158.35	\$158.38	\$161.70	\$289.00	\$378.92
60	-0600	\$158.75	\$159.85	\$164.00	\$290.50	\$393.00
72	-0720	\$159.15	\$161.32	\$166.30	\$292.00	\$407.08
Solder Center, Crimp Outer						
LENGTH IN INCHES	DASH NUMBER	50 Ω ⑥⑦ RG 58C③ 1 shield 058-SCASCA-	50 Ω ③① RG 223 2 shields⑦ 223-SCASCA-	50 Ω ④② RG 142B 2 shields⑦ 142-SCASCA-	50 Ω ①⑦ RG 400×④ 2 shields 400-SCASCA-	50 Ω ② ⁴ RG 141A 2 shields⑧ 141-SCASCA-
12	-0120	\$157.15	\$153.92	\$154.80	\$155.50	\$158.23
24	-0240	\$157.55	\$155.34	\$157.10	\$158.50	\$159.71
36	-0360	\$157.95	\$156.76	\$159.40	\$161.50	\$161.19
48	-0480	\$158.35	\$158.18	\$161.70	\$164.50	\$162.67
60	-0600	\$158.75	\$159.60	\$164.00	\$167.50	\$164.15
72	-0720	\$159.15	\$161.02	\$166.30	\$170.50	\$165.63
Solder Center, Crimp and Clamp Outer						
LENGTH IN INCHES	DASH NUMBER	50 Ω RG 8* ③③③ 1 shield 008-SCASCA-	50 Ω RG 213③③③ 1 shield 213-SCASCA-	50 Ω RG 214③① 2 shield⑦ 214-SCASCA-	50 Ω ①⑦ RG 225 1 shields 225-SCASCA-	50 Ω ④⑥ ⁴ RG 393 2 shields 393-SCASCA-
12	-0120	\$99.90	\$100.08	\$101.50	\$116.54	\$106.63
24	-0240	\$101.30	\$101.66	\$105.00	\$135.08	\$115.26
36	-0360	\$102.70	\$103.24	\$108.50	\$153.62	\$123.89
48	-0480	\$104.10	\$104.82	\$112.00	\$172.16	\$132.52
60	-0600	\$105.50	\$106.40	\$115.50	\$190.70	\$141.15
72	-0720	\$106.90	\$107.98	\$119.00	\$209.24	\$149.78
Color Designators (add letter to the end of the part number and add \$1.00 to price)						
Black - B		Blue - L		Brown - N		Gray - A
Orange - O		Red - R		Violet - V		Green - G
						White - W

See Page B5 for Cable Characteristics

* Contact Factory for delivery, Consider new RD316 for (RD188) 10% Discount @ 25 pcs. up 4% Discount @ 10 pcs. up

⁴ Brass Type N Jack. Contact Factory for Stainless Steel



RF Depot.com Inc.

Phone 856-488-2000 Fax 856-488-2020

SHV Male Plug x SHV Male Plug



LENGTH IN INCHES	DASH NUMBER	50 Ω [Ⓞ] Ⓣ RG 58C [Ⓢ] 1 shield 058-SHASHA-	50 Ω [Ⓢ] Ⓣ RG 223 2 shields [Ⓣ] 223-SHASHA-	50 Ω [Ⓢ] Ⓣ RG142B 2 shields [Ⓣ] 142-SHASHA-	50 Ω [Ⓣ] Ⓣ RG 400* [Ⓢ] [Ⓢ] 2 shields 400-SHASHA-	50 Ω [Ⓢ] RG 141A 2 shields [Ⓢ] 141-SHASHA-	50 Ω [Ⓣ] Ⓣ RG 225 2 shield 225-SHASHA-
Solder Center, Crimp Outer							
12	-0120	\$59.40	\$60.87	\$61.70	\$62.40	\$60.48	\$105.74
24	-0240	\$59.80	\$62.34	\$64.00	\$65.40	\$61.96	\$124.28
36	-0360	\$60.20	\$63.81	\$66.30	\$68.40	\$63.44	\$142.82
48	-0480	\$60.60	\$65.28	\$68.60	\$71.40	\$64.92	\$161.36
60	-0600	\$61.00	\$66.75	\$70.90	\$74.40	\$66.40	\$179.90
72	-0720	\$61.40	\$68.22	\$73.20	\$77.40	\$67.88	\$198.44
Solder Center, Crimp Outer							
LENGTH IN INCHES	DASH NUMBER	50 Ω RG 174 [Ⓢ] Ⓣ 1 shield [Ⓣ] 174-SHASHA-	50 Ω RG 316 [Ⓢ] Ⓣ 1 shield [Ⓢ] 316-SHASHA-	50 Ω RD316 [Ⓢ] Ⓣ 2 shields [Ⓣ] 31D-SHASHA-	50 Ω RG188* [Ⓢ] Ⓣ 1 shield [Ⓢ] 188-SHASHA-	50 Ω RG 393 [Ⓢ] Ⓣ [Ⓣ] 2 shields 393-SHASHA-	
12	-0120	\$121.14	\$121.55	\$122.75	\$121.90	\$99.95	
24	-0240	\$121.38	\$122.20	\$124.60	\$122.90	\$108.58	
36	-0360	\$121.62	\$122.85	\$126.45	\$123.90	\$117.21	
48	-0480	\$121.86	\$123.50	\$128.30	\$124.90	\$125.84	
60	-0600	\$122.10	\$124.15	\$130.15	\$125.90	\$134.47	
72	-0720	\$122.34	\$124.80	\$132.00	\$126.90	\$143.10	
Solder Center, Crimp Outer							
LENGTH IN INCHES	DASH NUMBER	50 Ω RG 8* [Ⓢ] Ⓣ [Ⓢ] 1 shield 008-SHASHA-	50 Ω RG 213 [Ⓢ] Ⓣ [Ⓢ] 1 shield 213-SHASHA-	50 Ω RG 214 [Ⓢ] Ⓣ [Ⓢ] 2 shields [Ⓣ] 214-SHASHA-	75 Ω [Ⓢ] RG 59B [Ⓢ] ‡ 1 shield [Ⓢ] 059-SHASHA-	93 Ω [Ⓢ] RG 62 [Ⓢ] ‡ 1 shield [Ⓢ] 062-SHASHA-	
12	-0120	\$88.60	\$88.78	\$90.70	\$57.98	\$58.24	
24	-0240	\$90.00	\$90.36	\$94.20	\$58.42	\$58.94	
36	-0360	\$91.40	\$91.94	\$97.70	\$58.86	\$59.64	
48	-0480	\$92.80	\$93.52	\$101.20	\$59.30	\$60.34	
60	-0600	\$94.20	\$95.10	\$104.70	\$59.74	\$61.04	
72	-0720	\$95.60	\$96.68	\$108.20	\$60.18	\$61.74	
Color Designators (add letter to the end of the part number and add \$1.00 to price)							
Black - B		Blue - L		Brown - N		Gray - A	
Orange - O		Red - R		Violet - V		Green - G	
						White - W	

See Page B5 for Cable Characteristics

* Contact Factory for delivery, Consider new RD316 for (RD188) 10% Discount @ 25 pcs. up 4% Discount @ 10 pcs. up

SMA Female Bulkhead Jack x SMA Female Bulkhead Jack

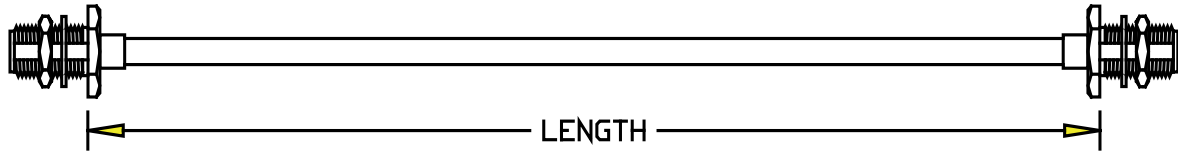

LENGTH IN INCHES	DASH NUMBER	50Ω RG 401① M17/129-RG401 .250 Cu Jacket 401-M5M5-	50Ω RG 401① No QPL List .250 Tin Plate Al 25A-M5M5-	50Ω RG 401② M17/129-00001 .250 Tin Plate Cu 2TS-M5M5-	50Ω MaxiFlex② No QPL List .250 Tin Plate Braid 25F-M5M5-	
.250" Diameter SEMIRIGID and Maxi Flex. Direct Solder Connectors						
24	-0240	\$218.04	\$219.92	\$228.42	\$218.04	
36	-0360	\$221.06	\$223.88	\$236.63	\$221.06	
48	-0480	\$224.08	\$227.84	\$244.84	\$224.08	
60	-0600	\$227.10	\$231.80	\$253.05	\$227.10	
72	-0720	\$230.12	\$235.76	\$261.26	\$230.12	
.141" Diameter SEMIRIGID and Maxi Flex. Direct Solder Connectors						
LENGTH IN INCHES	DASH NUMBER	50Ω RG 402② M17/130-00004 .141 Cu Jacket 402-M5M5-	50Ω RG 402② M17/130-00005 .141 Tin Plate Cu 1TS-M5M5-	50Ω RG 402① M17/130-00009 .141 Tin Plate Al 1AT-M5M5-	50Ω MaxiFlex② No QPL List .141 Tin Pl 14F-M5M5-	50Ω RG 402② M17/130-00012 .141 Silver Pl 1SS-M5M5-
12	-0120	\$44.60	\$44.24	\$44.60	\$44.24	\$53.81
24	-0240	\$48.20	\$47.48	\$48.20	\$47.48	\$66.62
36	-0360	\$51.80	\$50.72	\$51.80	\$50.72	\$79.43
48	-0480	\$55.40	\$53.96	\$55.40	\$53.96	\$92.24
60	-0600	\$59.00	\$57.20	\$59.00	\$57.20	\$105.05
72	-0720	\$62.60	\$60.44	CALL	\$60.44	CALL
.085" Diameter SEMIRIGID and Maxi Flex. Direct Solder Connectors						
LENGTH IN INCHES	DASH NUMBER	50Ω RG 405② M17/133-00007 .085 Tin Plate Cu 405-M5M5-	50Ω RG 405② M17/133-00007 .085 Tin Plate Cu 8TS-M5M5-	50Ω RG 405② M17/133-00013 .085 Tin Plate Al 8AT-M5M5-	50Ω MaxiFlex② No QPL List .085 Tin Pl 08F-M5M5-	50Ω RG 405② M17/133-00016 .085 Silver Pl 8SS-M5M5-
12	-0120	\$44.02	\$44.02	\$44.96	\$45.25	\$49.21
24	-0240	\$47.04	\$47.04	\$48.92	\$49.50	\$57.42
36	-0360	\$50.06	\$50.06	\$52.88	\$53.75	\$65.63
48	-0480	\$53.08	\$53.08	\$56.84	\$58.00	\$73.84
60	-0600	\$56.10	\$56.10	\$60.80	\$62.25	\$82.05
72	-0720	\$59.12	\$59.12	CALL	\$66.50	CALL
.047" Diameter SEMIRIGID and Maxi Flex. Direct Solder Connectors						
LENGTH IN INCHES	DASH NUMBER	50Ω ② M17/151-00001 .047 Cu Jacket 4CU-M5M5-	50Ω No QPL List .047 Tin Plate Al 4AT-M5M5-	50Ω② M17/151-00002 .047 Tin Plate Cu 4TS-M5M5-	50Ω ②MaxiFlex No QPL List .047 Tin Pl 04F-M5M5-	50Ω② M17/154-00002 .034 Tin Plate Cu 3TS-M5M5-
12	-0120	\$52.86	\$54.31	\$52.86	\$53.56	\$89.17
24	-0240	\$56.66	\$59.56	\$56.66	\$56.66	\$97.28
60	-0600	\$68.06	\$75.31	\$68.06	\$68.06	\$121.61

①Silver Plated Copper Center Conductor ②Silver Plated Copper Clad Steel Center Conductor

10% Discount @ 25 pcs. up 4% Discount @ 10 pcs. up



RF Depot.com Inc.

Phone 856-488-2000 Fax 856-488-2020

B120

7850 Browning Rd. Pennsauken, NJ 08109

Online @ www.rfdepot.com

Toll Free 877-RF Depot

SMA Female Bulkhead Jack x SMA Female Bulkhead Jack Commercial

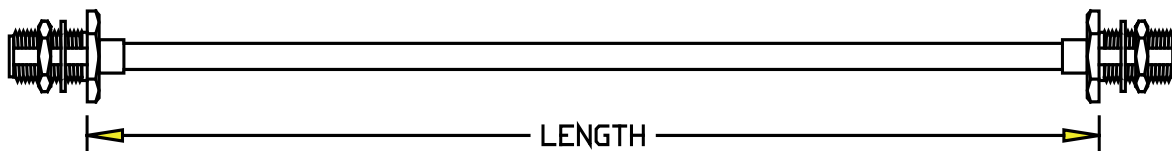

LTH IN INS	DASH NUM	50Ω RG 401① M17/129-RG401 .250 Cu Jacket 401-M5M5-	50Ω RG 401① No QPL List .250 Tin Plate Al 25A-M5M5-	50Ω RG 401② M17/129-00001 .250 Tin Plate Cu 2TS-M5M5-	50Ω MaxiFlex② No QPL List .250 Tin Plate Braid 25F-M5M5-		
.250" Diameter SEMIRIGID and Maxi Flex. Direct Solder Connectors							
24	-0240C	\$36.06	\$37.94	\$46.44	\$36.06		
36	-0360C	\$39.08	\$41.90	\$54.65	\$39.08		
48	-0480C	\$42.10	\$45.86	\$62.86	\$42.10		
60	-0600C	\$45.12	\$49.82	\$71.07	\$45.12		
72	-0720C	\$48.14	\$53.78	\$79.28	\$48.14		
.141" Diameter SEMIRIGID and Maxi Flex. Direct Solder Connectors							
LTH IN INS	DASH NUM	50Ω RG 402② M17/130-00004 .141 Cu Jacket 402-M5M5-	50Ω RG 402② M17/130-00005 .141 Tin Plate Cu 1TS-M5M5-	50Ω RG 402① M17/130-00009 .141 Tin Plate Al 1AT-M5M5-	50ΩMaxiFlex② No QPL List .141 Tin Pl 14F-M5M5-	50Ω RG 402② M17/130-00012 .141 Silver Pl 1SS-M5M5-	
12	-0120C	\$28.88	\$28.52	\$28.88	\$28.52	\$38.09	
24	-0240C	\$32.48	\$31.76	\$32.48	\$31.76	\$50.90	
36	-0360C	\$36.08	\$35.00	\$36.08	\$35.00	\$63.71	
48	-0480C	\$39.68	\$38.24	\$39.68	\$38.24	\$76.52	
60	-0600C	\$43.28	\$41.48	\$43.28	\$41.48	\$89.33	
72	-0720C	\$46.88	\$44.72	\$46.88	\$44.72	\$102.14	
.085" Diameter SEMIRIGID and Maxi Flex. Direct Solder Connectors							
LTH IN INS	DASH NUM	50Ω RG 405② M17/133-00007 .085 Tin Plate Cu 405-M5M5-	50Ω RG 405② M17/133-00007 .085 Tin Plate Cu 8TS-M5M5-	50Ω RG 405② M17/133-00013 .085 Tin Plate Al 8AT-M5M5-	50ΩMaxiFlex② No QPL List .085 Tin Pl 08F-M5M5-	50Ω RG 405② M17/133-00016 .085 Silver Pl 8SS-M5M5-	
12	-0120C	\$28.30	\$28.30	\$29.24	\$29.53	\$33.49	
24	-0240C	\$31.32	\$31.32	\$33.20	\$33.78	\$41.70	
36	-0360C	\$34.34	\$34.34	\$37.16	\$38.03	\$49.91	
48	-0480C	\$37.36	\$37.36	\$41.12	\$42.28	\$58.12	
60	-0600C	\$40.38	\$40.38	\$45.08	\$46.53	\$66.33	
72	-0720C	\$43.40	\$43.40	CALL	\$50.78	CALL	
.047" Diameter SEMIRIGID and Maxi Flex. Direct Solder Connectors							
LTH IN INS	DASH NUM	50Ω ② M17/151-00001 .047 Cu Jacket 4CU-M5M5-	50Ω No QPL List .047 Tin Pla Al 4AT-M5M5-	50Ω② M17/151-00002 .047 Tin Pl Cu 4TS-M5M5-	50Ω ② MaxiFlex No QPL List .047 Tin Pl 04F-M5M5-	50Ω ① Non-Magnetic .085 Tin Pl Cu 8CT-M5M5-	50Ω MaxiFlex① Non-Magnetic .085Tin Pl Cu 08C-M5M5-
12	-0120C	\$30.38	\$31.83	\$30.38	\$31.08	\$28.76	\$30.83
24	-0240C	\$34.18	\$37.08	\$34.18	\$35.58	\$30.94	\$35.08
60	-0600C	\$45.58	\$52.83	\$45.58	\$49.08	\$37.48	\$47.83

①Silver Plated Copper Center Conductor ②Silver Plated Copper Clad Steel Center Conductor

10% Discount @ 25 pcs. up 4% Discount @ 10 pcs. up



SMA Female Bulkhead Jack x SMA Female Jack

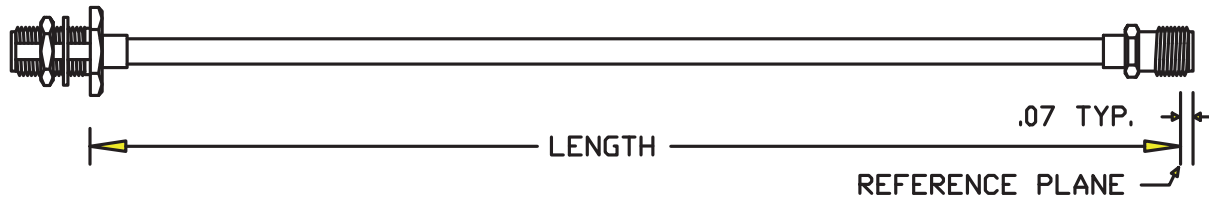

LENGTH IN INCHES	DASH NUMBER	50Ω RG 402Ⓢ M17/130-00004 .141 Cu Jacket 402-M1M5-	50Ω RG 402Ⓢ M17/130-00005 .141 Tin Pl Cu 1TS-M1M5-	50Ω RG 402Ⓢ M17/130-00009 .141 Tin Pl Al 1AT-M1M5-	50ΩMaxiFlexⓈ No QPL List .141 Tin Pl 14F-M1M5-	50Ω RG 402Ⓢ M17/130-00012 .141 Silver Pl 1SS-M1M5-
.141" Diameter SEMIRIGID and Maxi Flex. Direct Solder Connectors						
12	-0120	\$34.72	\$34.36	\$34.72	\$34.36	\$43.93
24	-0240	\$38.32	\$37.60	\$38.32	\$37.60	\$56.74
36	-0360	\$41.92	\$40.84	\$41.92	\$40.84	\$69.55
48	-0480	\$45.52	\$44.08	\$45.52	\$44.08	\$82.36
60	-0600	\$49.12	\$47.32	\$49.12	\$47.32	\$95.17
72	-0720	\$52.72	\$50.56	CALL	\$50.56	CALL
.085" Diameter SEMIRIGID and Maxi Flex. Direct Solder Connectors						
LENGTH IN INCHES	DASH NUMBER	50Ω RG 405Ⓢ M17/133-00007 .085 Tin Pl Cu 405-M1M5-	50Ω RG 405Ⓢ M17/133-00007 .085 Tin Pl Cu 8TS-M1M5-	50Ω RG 405Ⓢ M17/133-00013 .085 Tin Plate Al 8AT-M1M5-	50ΩMaxiFlexⓈ No QPL List .085 Tin Pl 08F-M1M5-	50Ω RG 405Ⓢ M17/133-00016 .085 Silver Pl 8SS-M1M5-
12	-0120	\$37.05	\$37.05	\$37.99	\$38.28	\$42.24
24	-0240	\$40.07	\$40.07	\$41.95	\$42.53	\$50.45
36	-0360	\$43.09	\$43.09	\$45.91	\$46.78	\$58.66
48	-0480	\$46.11	\$46.11	\$49.87	\$51.03	\$66.87
60	-0600	\$49.13	\$49.13	\$53.83	\$55.28	\$75.08
72	-0720	CALL	\$52.15	CALL	\$59.53	CALL
.047" Diameter SEMIRIGID and Maxi Flex. Direct Solder Connectors						
LENGTH IN INCHES	DASH NUMBER	50Ω Ⓢ M17/151-00001 .047 Cu Jacket 4CU-M1M5-	50Ω No QPL List .047 Tin Pl Al 4AT-M1M5-	50ΩⓈ M17/151-00002 .047 Tin Pl Cu 4TS-M1M5-	50Ω MaxiFlexⓈ No QPL List .047 Tin Pl 04F-M1M5-	50ΩⓈ M17/154-00002 .034 Tin Pl Cu 3TS-M1M5-
12	-0120	\$52.58	\$54.03	\$52.58	\$53.28	\$88.89
24	-0240	\$56.38	\$59.28	\$56.38	\$57.78	\$97.00
36	-0360	\$60.18	\$64.53	\$60.18	\$62.28	\$105.11
48	-0480	\$63.98	\$69.78	\$63.98	\$66.78	\$113.22
60	-0600	\$67.78	\$75.03	\$67.78	\$71.28	\$121.33
72	-0720	\$71.58	\$80.28	\$71.58	\$75.78	\$129.44

ⓈSilver Plated Copper Center Conductor ⓈSilver Plated Copper Clad Steel Center Conductor

10% Discount @ 25 pcs. up 4% Discount @ 10 pcs. up



RF Depot.com Inc.

Phone 856-488-2000 Fax 856-488-2020

SMA Female Bulkhead Jack x SMA Female Jack Commercial

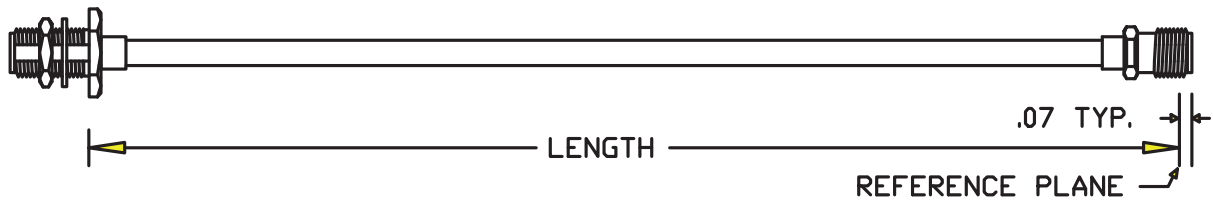

LTH IN INS	DASH NUM	50Ω RG 401 ^① Ⓐ M17/129-RG401 .250 Cu Jacket 401-M1M5-	50Ω RG 401 ^① Ⓐ No QPL List .250 Tin Plate Al 25A-M1M5-	50Ω RG 401 ^② Ⓐ M17/129-00001 .250 Tin Plate Cu 2TS-M1M5-	50Ω MaxiFlex ^② Ⓐ No QPL List .250 Tin Plate Braid 25F-M1M5-		
.250" Diameter SEMIRIGID and Maxi Flex. Direct Solder Connectors							
24	-0240C	\$36.06	\$37.94	\$46.44	\$36.06		
36	-0360C	\$39.08	\$41.90	\$54.65	\$39.08		
48	-0480C	\$42.10	\$45.86	\$62.86	\$42.10		
60	-0600C	\$45.12	\$49.82	\$71.07	\$45.12		
72	-0720C	\$48.14	\$53.78	\$79.28	\$48.14		
.141" Diameter SEMIRIGID and Maxi Flex. Direct Solder Connectors							
LTH IN INS	DASH NUM	50Ω RG 402 ^② M17/130-00004 .141 Cu Jacket 402-M1M5-	50Ω RG 402 ^② M17/130-00005 .141 Tin Plate Cu 1TS-M1M5-	50Ω RG 402 ^① M17/130-00009 .141 Tin Plate Al 1AT-M1M5-	50Ω MaxiFlex ^② No QPL List .141 Tin Pl 14F-M1M5-	50Ω RG 402 ^② M17/130-00012 .141 Silver Pl 1SS-M1M5-	
12	-0120C	\$25.81	\$25.45	\$25.81	\$25.45	\$35.02	
24	-0240C	\$29.41	\$28.69	\$29.41	\$28.69	\$47.83	
36	-0360C	\$33.01	\$31.93	\$33.01	\$31.93	\$60.64	
48	-0480C	\$36.61	\$35.17	\$36.61	\$35.17	\$73.45	
60	-0600C	\$40.21	\$38.41	\$40.21	\$38.41	\$86.26	
72	-0720C	\$43.81	\$41.65	\$43.81	\$41.65	\$99.07	
.085" Diameter SEMIRIGID and Maxi Flex. Direct Solder Connectors							
LTH IN INS	DASH NUM	50Ω RG 405 ^② M17/133-00007 .085 Tin Plate Cu 405-M1M5	50Ω RG 405 ^② M17/133-00007 .085 Tin Plate Cu 8TS-M1M5	50Ω RG 405 ^② M17/133-00013 .085 Tin Plate Al 8AT-M1M5	50Ω MaxiFlex ^② No QPL List .085 Tin Pl 08F-M1M5-	50Ω RG 405 ^② M17/133-00016 .085 Silver Pl 8SS-M1M5-	
12	-0120C	\$25.32	\$25.32	\$26.26	\$26.55	\$30.51	
24	-0240C	\$28.34	\$28.34	\$30.22	\$30.80	\$38.72	
36	-0360C	\$31.36	\$31.36	\$34.18	\$35.05	\$46.93	
48	-0480C	\$34.38	\$34.38	\$38.14	\$39.30	\$55.14	
60	-0600C	\$37.40	\$37.40	\$42.10	\$43.55	\$63.35	
72	-0720C	\$40.42	\$40.42	CALL	\$47.80	CALL	
.047" Diameter SEMIRIGID and Maxi Flex. Direct Solder Connectors							
LTH IN INS	DASH NUM	50Ω ^② M17/151-00001 .047 Cu Jacket 4CU-M1M5-	50Ω No QPL List .047 Tin Plate Al 4AT-M1M5-	50Ω ^② M17/151-00002 .047 Tin Plate Cu 4TS-M1M5-	50Ω MaxiFlex ^② No QPL List .047 Tin Pl 04F-M1M5-	50Ω ^① Ⓐ Non-Magnetic .085 Tin Pl Cu 8CT-M1M5-	50Ω MaxiFlex ^① Non-Magnetic [Ⓐ] .085 Tin Pl Cu 08C-M1M5-
12	-0120C	\$27.60	\$29.05	\$27.60	\$28.30	\$36.21	\$38.28
24	-0240C	\$31.40	\$34.30	\$31.40	\$32.80	\$38.39	\$42.53
60	-0600C	\$35.20	\$38.55	\$35.20	\$37.30	\$44.93	\$55.28

Ⓐ Order Stainless Steel SMA Bulkhead Jack x Bulkhead Jack Cable Assembly on Page B120

① Silver Plated Copper Center Conductor ② Silver Plated Copper Clad Steel Center Conductor

10% Discount @ 25 pcs. up 4% Discount @ 10 pcs. up

SMA Female Bulkhead Jack x SMA Male Plug

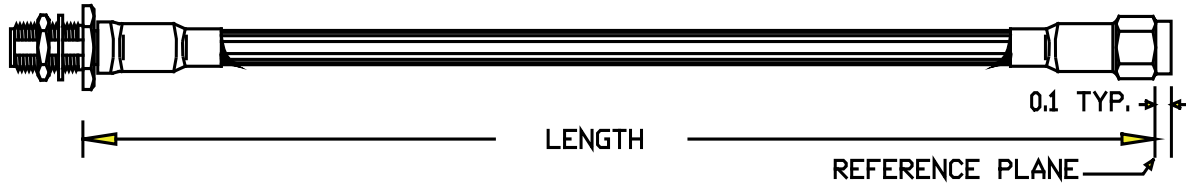

LENGTH IN INCHES	DASH NUMBER	50 Ω ^{⑥⑦} RG 58C ^⑥ 1 shield 058-MAMF-	50 Ω ^{⑧①} RG 223 2 shields ^⑦ 223-MAMF-	50 Ω ^{④②} RG142B 2 shields ^⑦ 142-MAMF-	50 Ω ^{①⑦} RG 400 ^{✕④} 2 shields 400-MAMF-	50 Ω RG 196 ^② 1 shield ^⑩ 196-MAMF-	
Solder Center, Crimp Outer							
12	-0120	\$30.78	\$32.94	\$33.77	\$34.47	\$41.92	
24	-0240	\$31.18	\$34.41	\$36.07	\$37.47	\$42.66	
36	-0360	\$31.58	\$35.88	\$38.37	\$40.47	\$43.40	
48	-0480	\$31.98	\$37.35	\$40.67	\$43.47	\$44.14	
60	-0600	\$32.38	\$38.82	\$42.97	\$46.47	\$44.88	
72	-0720	\$32.78	\$40.29	\$45.27	\$49.47	\$45.62	
Solder Center, Crimp Outer							
LENGTH IN INCHES	DASH NUMBER	50 Ω RG 174 ^{⑨⑤} 1 shield ^⑦ 174-MAMF-	50 Ω RG 316 ^{④②} 1 shield ^⑩ 316-MAMF-	50 Ω RD 316 ^{④②} 2 shields ^⑦ 31D-MAMF-	50 Ω RG188* ^{④②} 1 shield ^⑩ 188-MAMF-	50 Ω RG 178B/U ^② 1 shield ^⑩ 178-MAMF-	
12	-0120	\$30.45	\$30.86	\$30.51	\$31.21	\$31.92	
24	-0240	\$30.69	\$31.51	\$32.36	\$32.21	\$32.66	
36	-0360	\$30.93	\$32.16	\$34.21	\$33.21	\$33.40	
48	-0480	\$31.17	\$32.81	\$36.06	\$34.21	\$34.14	
60	-0600	\$31.41	\$33.46	\$37.91	\$35.21	\$34.88	
72	-0720	\$31.65	\$34.11	\$39.76	\$36.21	\$35.62	
Solder Center, Crimp Outer							
LENGTH IN INCHES	DASH NUMBER	50 Ω RG 8* ^{⑧③⑧} 1 shield 008-MAMF-	50 Ω RG 213 ^{⑧③⑧} 1 shield 213-MAMF-	50 Ω RG 214 ^{⑧①} 2 shields ^⑦ 214-MAMF-	50 Ω ^④ RG 393 ^{①⑦} 2 shields 393-MAMF-	50 Ω ^{③⑨} SIG 240 ^⑩ 2 shields 24C-MAMF-	50 Ω ^{③⑨} LMR 240 ^⑩ 2 shields 24L-MAMF-
12	-0120C	\$36.99	\$37.17	\$37.64	\$43.38	\$26.05	\$26.47
24	-0240C	\$38.39	\$38.75	\$41.14	\$52.01	\$26.65	\$27.49
36	-0360C	\$39.79	\$40.33	\$44.64	\$60.64	\$27.25	\$28.51
48	-0480C	\$41.19	\$41.91	\$48.14	\$69.27	\$27.85	\$29.53
60	-0600C	\$42.59	\$43.49	\$51.64	\$77.90	\$28.45	\$30.55
72	-0720C	\$43.99	\$45.07	\$55.14	\$86.53	\$29.05	\$31.57
Color Designators (add letter to the end of the part number and add \$1.00 to price)							
Black - B		Blue - L		Brown - N		Gray - A	
Orange - O		Red - R		Violet - V		Green - G	
						White - W	

See Page B5 for Cable Characteristics

* Contact Factory for delivery, Consider new RD316 for (RD188) 10% Discount @ 25 pcs. up 4% Discount @ 10 pcs. up



RF Depot.com Inc.

Phone 856-488-2000 Fax 856-488-2020

SMA Female Bulkhead Jack x SMA Male Plug

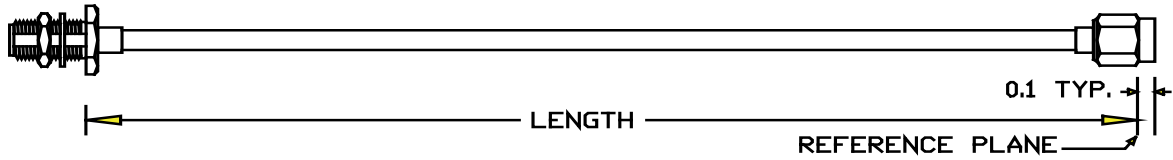

LENGTH IN INCHES	DASH NUMBER	50Ω RG 401 ^① M17/129-RG401 .250 Cu Jacket 401-M0M5-	50Ω RG 401 ^① No QPL List .250 Tin Plate Al 25A-M0M5-	50Ω RG 401 ^② M17/129-00001 .250 Tin Plate Cu 2TS-M0M5-	50Ω MaxiFlex ^② No QPL List .250 Tin Plate Braid 25F-M0M5-	
.250" Diameter SEMIRIGID and Maxi Flex. Direct Solder Connectors						
24	-0240	\$181.14	\$183.02	\$181.14	\$181.14	
36	-0360	\$184.16	\$186.98	\$184.16	\$184.16	
48	-0480	\$187.18	\$190.94	\$187.18	\$187.18	
60	-0600	\$190.20	\$194.90	\$190.20	\$190.20	
72	-0720	\$193.22	\$198.86	\$193.22	\$193.22	
.141" Diameter SEMIRIGID and Maxi Flex. Direct Solder Connectors						
LENGTH IN INCHES	DASH NUMBER	50Ω RG 402 ^② M17/130-00004 .141 Cu Jacket 402-M0M5-	50Ω RG 402 ^② M17/130-00005 .141 Tin Pl Cu 1TS-M0M5-	50Ω RG 402 ^① M17/130-00009 .141 Tin Pl Al 1AT-M0M5-	50Ω MaxiFlex ^② No QPL List .141 Tin Pl 14F-M0M5-	50Ω RG 402 ^② M17/130-00012 .141 Silver Pl 1SS-M0M5-
12	-0120	\$32.23	\$31.87	\$32.23	\$31.87	\$41.44
24	-0240	\$35.83	\$35.11	\$35.83	\$35.11	\$54.25
36	-0360	\$39.43	\$38.35	\$39.43	\$38.35	\$67.06
48	-0480	\$43.06	\$41.59	\$43.06	\$41.59	\$79.87
60	-0600	\$46.63	\$44.83	\$46.63	\$44.83	\$92.68
72	-0720	\$50.23	\$48.07	CALL	\$48.07	CALL
.085" Diameter SEMIRIGID and Maxi Flex. Direct Solder Connectors						
LENGTH IN INCHES	DASH NUMBER	50Ω RG 405 ^② M17/133-00007 .085 Tin Pl Cu 405-M0M5-	50Ω RG 405 ^② M17/133-00007 .085 Tin Pl Cu 8TS-M0M5-	50Ω RG 405 ^② M17/133-00013 .085 Tin Pl Al 8AT-M0M5-	50Ω MaxiFlex ^② No QPL List .085 Tin Pl 08F-M0M5-	50Ω RG 405 ^② M17/133-00016 .085 Silver Pl 8SS-M0M5-
12	-0120	\$34.56	\$34.56	\$35.50	\$35.79	\$39.75
24	-0240	\$37.58	\$37.58	\$39.46	\$40.04	\$47.96
36	-0360	\$40.60	\$40.60	\$43.42	\$44.29	\$56.17
48	-0480	\$43.62	\$43.62	\$47.38	\$48.54	\$64.38
60	-0600	\$46.64	\$46.64	\$51.34	\$52.79	\$72.59
72	-0720	\$49.66	\$49.66	CALL	\$57.04	CALL
.047" Diameter SEMIRIGID and Maxi Flex. Direct Solder Connectors						
LENGTH IN INCHES	DASH NUMBER	50Ω ^② M17/151-00001 .047 Cu Jacket 4CU-M0M5-	50Ω No QPL List .047 Tin Pl Al 4AT-M0M5-	50Ω ^② M17/151-00002 .047 Tin Pl Cu 4TS-M0M5-	50Ω MaxiFlex ^② No QPL List .047 Tin Pl 04F-M0M5-	50Ω ^② M17/154-00002 .034 Tin Pl Cu 3TS-M0M5-
12	-0120	\$40.11	\$41.56	\$40.11	\$40.81	\$76.42
24	-0240	\$43.91	\$46.81	\$43.91	\$45.31	\$84.53
60	-0600	\$55.31	\$62.56	\$55.31	\$58.81	\$108.86

^①Silver Plated Copper Center Conductor ^②Silver Plated Copper Clad Steel Center Conductor

10% Discount @ 25 pcs. up 4% Discount @ 10 pcs. up

SMA Female Bulkhead Jack x SMA Male Plug Commercial

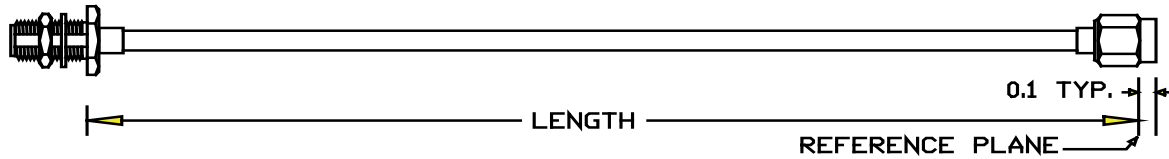

LTH IN INS	DASH NUM	50Ω RG 401① M17/129-RG401 .250 Cu Jacket 401-M0M5-	50Ω RG 401① No QPL List .250 Tin Plate Al 25A-M0M5-	50Ω RG 401② M17/129-00001 .250 Tin Plate Cu 2TS-M0M5-	50Ω MaxiFlex② No QPL List .250 Tin Plate Braid 25F-M0M5-		
.250" Diameter SEMIRIGID and Maxi Flex. Direct Solder Connectors							
24	-0240C	\$32.73	\$34.61	\$34.90	\$32.73		
36	-0360C	\$35.75	\$38.57	\$43.11	\$35.75		
48	-0480C	\$38.77	\$42.53	\$51.32	\$38.77		
60	-0600C	\$41.79	\$46.49	\$59.53	\$41.79		
72	-0720C	\$44.81	\$50.45	\$67.74	\$44.81		
.141" Diameter SEMIRIGID and Maxi Flex. Direct Solder Connectors							
LTH IN INS	DASH NUM	50Ω RG 402② M17/130-00004 .141 Cu Jacket 402-M0M5-	50Ω RG 402② M17/130-00005 .141 Tin Plate Cu 1TS-M0M5-	50Ω RG 402① M17/130-00009 .141 Tin Plate Al 1AT-M0M5-	50ΩMaxiFlex② No QPL List .141 Tin Pl 14F-M0M5-	50Ω RG 402② M17/130-00012 .141 Silver Pl 1SS-M0M5-	
12	-0120C	\$24.17	\$23.81	\$24.17	\$23.81	\$33.38	
24	-0240C	\$27.77	\$27.05	\$27.77	\$27.05	\$46.19	
36	-0360C	\$31.37	\$30.29	\$31.37	\$30.29	\$59.00	
48	-0480C	\$34.97	\$33.53	\$34.97	\$33.53	\$71.81	
60	-0600C	\$38.57	\$36.77	\$38.57	\$36.77	\$84.62	
72	-0720C	\$42.17	\$40.01	CALL	\$40.01	CALL	
.085" Diameter SEMIRIGID and Maxi Flex. Direct Solder Connectors							
LTH IN INS	DASH NUM	50Ω RG 405② M17/133-00007 .085 Tin Plate Cu 405-M0M5	50Ω RG 405② M17/133-00007 .085 Tin Plate Cu 8TS-M0M5	50Ω RG 405② M17/133-00013 .085 Tin Plate Al 8AT-M0M5	50ΩMaxiFlex② No QPL List .085 Tin Pl 08F-M0M5-	50Ω RG 405② M17/133-00016 .085 Silver Pl 8SS-M0M5-	
12	-0120C	\$26.03	\$26.03	\$26.97	\$27.26	\$31.22	
24	-0240C	\$29.05	\$29.05	\$30.93	\$31.51	\$39.43	
36	-0360C	\$32.07	\$32.07	\$34.89	\$35.76	\$47.64	
48	-0480C	\$35.09	\$35.09	\$38.85	\$40.01	\$55.85	
60	-0600C	\$38.11	\$38.11	\$42.81	\$44.26	\$64.06	
72	-0720C	\$41.13	\$41.13	CALL	\$48.51	CALL	
.047" Diameter SEMIRIGID and Maxi Flex. Direct Solder Connectors							
LTH IN INS	DASH NUM	50Ω ② M17/151-00001 .047 Cu Jacket 4CU-M0M5-	50Ω No QPL List .047 Tin Pl Al 4AT-M0M5-	50Ω② M17/151-00002 .047 Tin Pl Cu 4TS-M0M5-	50Ω ② MaxiFlex No QPL List .047 Tin Pl 04F-M0M5-	50Ω ① Non-Magnetic .085 Tin Pl Cu 8CT-M0M5-	50Ω MaxiFlex① Non-Magnetic .085 Tin Pl Cu 08C-M0M5-
12	-0120C	\$27.49	\$28.94	\$27.49	\$28.19	\$25.87	\$27.94
24	-0240C	\$31.29	\$34.19	\$31.29	\$32.69	\$28.05	\$32.19
60	-0600C	\$42.69	\$49.94	\$42.69	\$46.19	\$34.59	\$44.94

①Silver Plated Copper Center Conductor ②Silver Plated Copper Clad Steel Center Conductor

10% Discount @ 25 pcs. up 4% Discount @ 10 pcs. up

SMA Female Bulkhead Jack x SMA Right Angle Male Plug

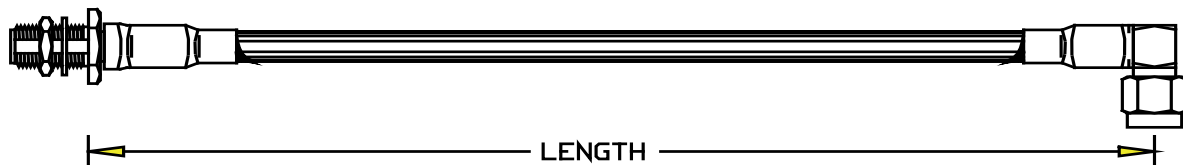

LENGTH IN INCHES	DASH NUMBER	50 Ω ^{⑥⑦} RG 58C ^③ 1 shield 058-MCMF-	50 Ω ^{③①} RG 223 2 shields ^⑦ 223-MCMF-	50 Ω ^{④②} RG142B 2 shields ^⑦ 142-MCMF-	50 Ω ^{①⑦} RG 400* ^④ 2 shields 400-MCMF-	50 Ω RG 178B/U ^② 1 shield ^⑧ 178-MCMF-	
Solder Center, Crimp Outer							
12	-0120	\$36.88	\$35.71	\$36.54	\$37.24	\$50.14	
24	-0240	\$37.28	\$37.18	\$38.84	\$40.24	\$50.88	
36	-0360	\$37.68	\$38.65	\$41.14	\$43.24	\$51.62	
48	-0480	\$38.08	\$40.12	\$43.44	\$46.24	\$52.36	
60	-0600	\$38.48	\$41.59	\$45.74	\$49.24	\$53.10	
72	-0720	\$38.88	\$43.06	\$48.04	\$52.24	\$53.84	
Solder Center, Crimp Outer							
LENGTH IN INCHES	DASH NUMBER	50 Ω RG 174 ^{③⑤} 1 shield ^⑦ 174-MCMF-	50 Ω RG 316 ^{④②} 1 shield ^⑧ 316-MCMF-	50 Ω RD316 ^{④②} 2 shields ^⑦ 31D-MCMF-	50 Ω RG188* ^{④②} 1 shield ^⑧ 188-MCMF-	50 Ω RG 196 ^② 1 shield ^⑧ 196-MCMF-	75 Ω RG179A ^{④②} 1 shield ^⑧ 179-MCMF-
12	-0120	\$37.91	\$38.32	\$32.43	\$38.67	\$50.14	\$38.40
24	-0240	\$38.15	\$38.97	\$34.28	\$39.67	\$50.88	\$39.13
36	-0360	\$38.39	\$39.62	\$36.13	\$40.67	\$51.62	\$39.86
48	-0480	\$38.63	\$40.27	\$37.98	\$41.67	\$52.36	\$40.59
60	-0600	\$38.87	\$40.92	\$39.83	\$42.67	\$53.10	\$41.32
72	-0720	\$39.11	\$41.57	\$41.68	\$43.67	\$53.84	\$42.05
Solder Center, Crimp Outer, Low Loss Flexible							
LENGTH IN INCHES	DASH NUMBER	50 Ω ^③ SIG 195 ^⑥ 2 shields ^⑧ 19C-MCMF-	50 Ω ^③ LMR 195 ^⑥ 2 shields ^⑧ 19M-MCMF-	50 Ω ^{③③} SIG 200 ^⑥ 2 shields 2LC-MCMF-	50 Ω ^{③③} LMR 200 ^⑥ 2 shields 2LM-MCMF-	50 Ω ^{③③} SIG 240 ^⑥ 2 shields 24C-MCMF-	50 Ω ^{③③} LMR 240 ^⑥ 2 shields 24L-MCMF-
12	-0120	\$37.05	\$37.19	\$27.36	\$27.41	\$29.13	\$29.55
24	-0240	\$37.62	\$37.90	\$28.04	\$28.14	\$29.73	\$30.57
36	-0360	\$38.19	\$38.61	\$28.72	\$28.87	\$30.33	\$31.59
48	-0480	\$38.76	\$39.32	\$29.40	\$29.60	\$30.93	\$32.61
60	-0600	\$39.33	\$40.03	\$30.08	\$30.33	\$31.53	\$33.63
72	-0720	\$39.90	\$40.74	\$30.76	\$31.06	\$32.13	\$34.65
Color Designators (add letter to the end of the part number and add \$1.00 to price)							
Black - B		Blue - L		Brown - N		Gray - A	
Orange - O		Red - R		Violet - V		Green - G	
						White - W	

See Page B5 for Cable Characteristics

* Contact Factory for delivery, Consider new RD316 for (RD188)

10% Discount @ 25 pcs. up

4% Discount @ 10 pcs. up

SMA Female Bulkhead Jack x SMA Right Angle Male Plug

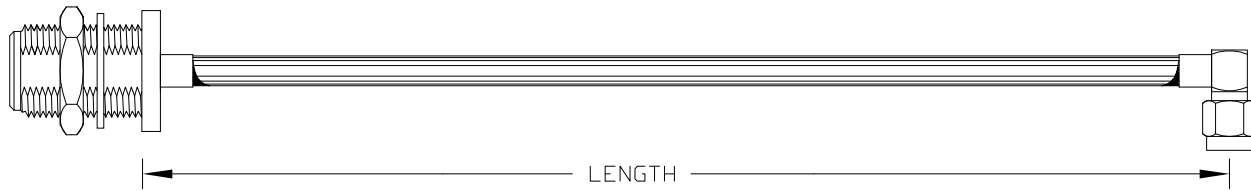

LENGTH IN INCHES	DASH NUMBER	50Ω [Ⓢ] M17/151-00001 .047 Cu Jacket 4CU-M2M5-	50Ω No QPL List .047 Tin Plate Al 4AT-M2M5-	50Ω [Ⓢ] M17/151-00002 .047 Tin Plate Cu 4TS-M2M5-	50Ω MaxiFlex [Ⓢ] No QPL List .047 Tin Plate Braid 04F-M2M5-		
.047" Diameter SEMIRIGID and Maxi Flex. Direct Solder Connectors							
12	-0120	\$58.01	\$59.46	\$58.01	\$58.71		
24	-0240	\$61.81	\$64.71	\$61.81	\$63.21		
36	-0360	\$65.61	\$69.96	\$65.61	\$67.71		
48	-0480	\$69.41	\$75.21	\$69.41	\$72.21		
60	-0600	\$73.21	\$80.46	\$73.21	\$76.71		
72	-0720	\$77.01	\$85.71	\$77.01	\$81.21		
.141" Diameter SEMIRIGID and Maxi Flex. Solder Clamp Connectors, Field Clockable							
LENGTH IN INCHES	DASH NUM	50Ω RG 402 [Ⓢ] M17/130-00004 .141 Cu Jacket 402-M2M5-	50Ω RG 402 [Ⓢ] M17/130-00005 .141 Tin Plate Cu 1TS-M2M5-	50Ω RG 402 [Ⓢ] M17/130-00009 .141 Tin Plate Al 1AT-M2M5-	50Ω MaxiFlex [Ⓢ] No QPL List .141 Tin Pl 14F-M2M5-	50Ω RG 402 [Ⓢ] M17/130-00012 .141 Silver Plate Cu 1SS-M2M5-	
12	-0120E	\$38.02	\$37.66	\$38.02	\$37.66	\$47.23	
24	-0240E	\$41.62	\$40.90	\$41.62	\$40.90	\$60.04	
36	-0360E	\$45.22	\$44.14	\$45.22	\$44.14	\$72.85	
48	-0480E	\$48.82	\$47.38	\$48.82	\$47.38	\$85.66	
60	-0600E	\$52.42	\$50.62	\$52.42	\$50.62	\$98.47	
72	-0720E	\$56.02	\$53.86	CALL	\$53.86	CALL	
.085" Diameter SEMIRIGID and Maxi Flex. Solder Clamp Connectors, Field Clockable							
LENGTH IN INCHES	DASH NUM	50Ω RG 405 [Ⓢ] M17/133-00007 .085 Tin Plate Cu 405-M2M5-	50Ω RG 405 [Ⓢ] M17/133-00007 .085 Tin Plate Cu 8TS-M2M5-	50Ω RG 405 [Ⓢ] M17/133-00013 .085 Tin Plate Al 8AT-M2M5-	50Ω MaxiFlex [Ⓢ] No QPL List .085 Tin Pl 08F-M2M5-	50Ω RG 405 [Ⓢ] M17/133-00016 .085 Silver Pl 8SS-M2M5-	50Ω MaxiFlex [Ⓢ] No QPL List .085 Tin Pl 08J-M2M5-
12	-0120E	\$40.35	\$40.35	\$41.29	\$41.58	\$45.54	\$41.14
24	-0240E	\$43.37	\$43.37	\$45.25	\$45.83	\$53.75	\$44.95
36	-0360E	\$46.39	\$46.39	\$49.21	\$50.08	\$61.96	\$48.76
48	-0480E	\$49.41	\$49.41	\$53.17	\$54.33	\$70.17	\$52.57
60	-0600E	\$52.43	\$52.43	\$57.13	\$58.58	\$78.38	\$56.38
72	-0720E	\$55.45	\$55.45	CALL	\$62.83	CALL	\$60.19

Ⓢ Silver Plated Copper Center Conductor Ⓢ Silver Plated Copper Clad Steel Center Conductor

10% Discount @ 25 pcs. up 4% Discount @ 10 pcs. up



RF Depot.com Inc.

Phone 856-488-2000 Fax 856-488-2020

B128

7850 Browning Rd. Pennsauken, NJ 08109

Online @ www.rfdepot.com

Toll Free 877-RF Depot

SMA Female Bulkhead Jack x SMA Right Angle Male Plug Commercial

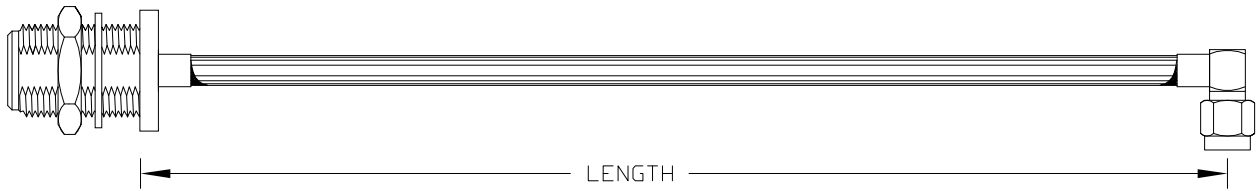

LENGTH IN INCHES	DASH NUMBER	50Ω RG 402 [Ⓢ] M17/130-00004 .141 Cu Jacket 402-M2M5-	50Ω RG 402 [Ⓢ] M17/130-00005 .141 Tin Plate Cu 1TS-M2M5-	50Ω RG 402 [Ⓢ] M17/130-00009 .141 Tin Plate Al 1AT-M2M5-	50Ω MaxiFlex [Ⓢ] No QPL List .141 Tin Pl 14F-M2M5-	50Ω RG 402 [Ⓢ] M17/130-00012 .141 Silver Pl 1SS-M2M5-
.141" Diameter SEMIRIGID and Maxi Flex. Direct Solder Connectors						
12	-0120C	\$41.22	\$40.86	\$41.22	\$42.89	\$50.43
24	-0240C	\$44.82	\$44.10	\$44.82	\$46.13	\$63.24
36	-0360C	\$48.42	\$47.34	\$48.42	\$49.37	\$76.05
48	-0480C	\$52.02	\$50.58	\$52.02	\$52.61	\$88.86
60	-0600C	\$55.62	\$53.82	\$55.62	\$55.85	\$101.67
72	-0720C	\$59.22	\$57.06	CALL	\$59.09	CALL
.085" Diameter SEMIRIGID and Maxi Flex. Direct Solder Connectors						
LENGTH IN INCHES	DASH NUMBER	50Ω RG 405 [Ⓢ] M17/133-00007 .085 Tin Plate Cu 405-M2M5-	50Ω RG 405 [Ⓢ] M17/133-00007 .085 Tin Plate Cu 8TS-M2M5-	50Ω RG 405 [Ⓢ] M17/133-00013 .085 Tin Plate Al 8AT-M2M5-	50Ω MaxiFlex [Ⓢ] Non-Magnetic .085 Tin Pl 08F-M2M5-	50Ω RG 405 [Ⓢ] M17/133-00016 .085 Silver Pl 8SS-M2M5-
12	-0120C	\$38.26	\$38.26	\$39.20	\$43.24	\$43.45
24	-0240C	\$41.28	\$41.28	\$43.16	\$47.49	\$51.66
36	-0360C	\$44.30	\$44.30	\$47.12	\$51.74	\$59.87
48	-0480C	\$47.32	\$47.32	\$51.08	\$55.99	\$68.08
60	-0600C	\$50.34	\$50.34	\$55.04	\$60.24	\$76.29
72	-0720C	\$53.36	\$53.36	CALL	\$54.49	CALL
.047/.085" Diameter SEMIRIGID and Maxi Flex. Direct Solder Connectors						
LENGTH IN INCHES	DASH NUMBER	50Ω [Ⓢ] M17/151-00001 .047 Cu Jacket 4CU-M2M5-	50Ω [Ⓢ] (No QPL List) .047 Tin Plate Al 4AT-M2M5-	50Ω [Ⓢ] M17/151-00002 .047 Tin Plate Cu 4TS-M2M5-	50Ω [Ⓢ] MaxiFlex (No QPL List) .047 Tin Pl 04F-M2M5-	50Ω [Ⓢ] Non-Magnetic .085 Tin Plate Cu 8CT-M2M5-
12	-0120C	\$44.75	\$46.20	\$44.75	\$45.45	\$43.13
24	-0240C	\$48.55	\$51.45	\$48.55	\$49.95	\$45.31
36	-0360C	\$52.35	\$56.70	\$52.35	\$54.45	\$47.49
48	-0480C	\$56.15	\$61.95	\$56.15	\$58.95	\$49.67
60	-0600C	\$59.95	\$67.20	\$59.95	\$63.45	\$51.85
72	-0720C	\$63.75	\$72.45	\$63.75	\$67.95	\$54.03

See Page B5 for Cable Characteristics

Ⓢ Silver Plated Copper Center Conductor Ⓢ Silver Plated Copper Clad Steel Center Conductor

10% Discount @ 25 pcs. up 4% Discount @ 10 pcs. up



SMA Female Bulkhead Jack x SMB Female Plug

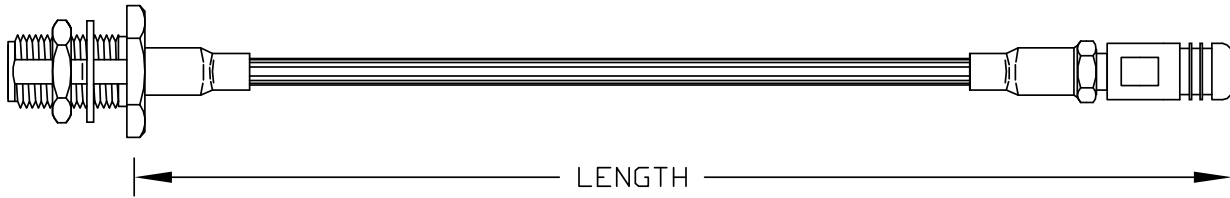

LENGTH IN INCHES	DASH NUMBER	50 Ω ^⑦ RG 58C ^⑤ 1 shield 058-MBAMF-	50 Ω ^{③①} RG 223 2 shields ^⑦ 223-MBAMF-	50 Ω ^{④②} RG142B 2 shields ^⑦ 142-MBAMF-	50 Ω ^{①⑦} RG 400* ^④ 2 shields 400-MBAMF-	75 Ω RG179A ^{④②} 1 shield ^⑩ 179-MBAMF-	50 Ω RG 196 ^② 1 shield ^⑩ 196-MBAMF-
Solder Center, Crimp Outer							
12	-0120	\$28.93	\$30.46	\$31.29	\$31.99	\$32.68	\$37.74
18	-0180	\$29.13	\$31.20	\$32.44	\$33.49	\$33.05	\$38.11
24	-0240	\$29.33	\$31.93	\$33.59	\$34.99	\$33.41	\$38.48
30	-0300	\$29.53	\$32.67	\$34.74	\$36.49	\$33.78	\$38.85
36	-0360	\$29.73	\$33.40	\$35.89	\$37.99	\$34.14	\$39.22
42	-0420	\$29.93	\$34.14	\$37.04	\$39.49	\$34.51	\$39.59
48	-0480	\$30.13	\$34.87	\$38.19	\$40.99	\$34.87	\$39.96
54	-0540	\$30.33	\$35.61	\$39.34	\$42.49	\$35.24	\$40.33
60	-0600	\$30.53	\$36.34	\$40.49	\$43.99	\$35.60	\$40.70
66	-0660	\$30.73	\$37.08	\$41.64	\$45.49	\$35.97	\$41.07
72	-0720	\$30.93	\$37.81	\$42.79	\$46.99	\$36.33	\$41.44
Solder Center, Crimp Outer							
LENGTH IN INCHES	DASH NUMBER	50 Ω RG 174 ^{⑤⑤} 1 shield ^⑦ 174-MBAMF-	50 Ω RG 316 ^{④②} 1 shield ^⑩ 316-MBAMF-	50 Ω RD316 ^{④②} 2 shields ^⑦ 31D-MBAMF-	50 Ω RG188* ^{④②} 1 shield ^⑩ 188-MBAMF-	50 Ω RG 178B/U ^② 1 shield ^⑩ 178-MBAMF-	50 Ω ^{②⑦①} RD*188 2 shields 88D-MBAMF-
12	-0120	\$30.94	\$31.35	\$32.55	\$31.70	\$37.74	\$34.22
18	-0180	\$31.06	\$31.68	\$33.48	\$32.20	\$38.11	\$35.98
24	-0240	\$31.18	\$32.00	\$34.40	\$32.70	\$38.48	\$37.74
30	-0300	\$31.30	\$32.33	\$35.33	\$33.20	\$38.85	\$39.50
36	-0360	\$31.42	\$32.65	\$36.25	\$33.70	\$39.22	\$41.26
42	-0420	\$31.54	\$32.98	\$37.18	\$34.20	\$39.59	\$43.02
48	-0480	\$31.66	\$33.30	\$38.10	\$34.70	\$39.96	\$44.78
54	-0540	\$31.78	\$33.63	\$39.03	\$35.20	\$40.33	\$46.54
60	-0600	\$31.90	\$33.95	\$39.95	\$35.70	\$40.70	\$48.30
66	-0660	\$32.02	\$34.28	\$40.88	\$36.20	\$41.07	\$50.06
72	-0720	\$32.14	\$34.60	\$41.80	\$37.70	\$41.44	\$51.82
Color Designators (add letter to the end of the part number and add \$1.00 to price)							
Black - B		Blue - L		Brown - N		Gray - A	
Orange - O		Red - R		Violet - V		Green - G	
						White - W	

See Page B5 for Cable Characteristics

* Contact Factory for delivery, Consider new RD316 for (RD188) 10% Discount @ 25 pcs. up 4% Discount @ 10 pcs. up

SMA Female Bulkhead Jack x SMB Right Angle Female Plug

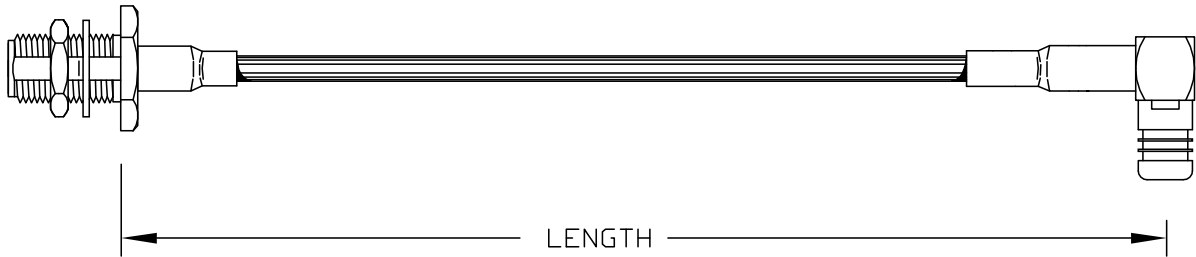

LENGTH IN INCHES	DASH NUMBER	50 Ω ^{⑥⑦} RG 58C ^③ 1 shield 058-MBCMF-	50 Ω ^{③①} RG 223 2 shields ^⑦ 223-MBCMF-	50 Ω ^{④②} RG142B 2 shields ^⑦ 142-MBCMF-	50 Ω ^{①⑦} RG 400 ^{✖④} 2 shields 400-MBCMF-	75 Ω RG179A ^{④②} 1 shield ^⑥ 179-MBCMF-	50 Ω RG 196 ^② 1 shield ^⑥ 196-MBCMF-
Solder Center, Crimp Outer							
12	-0120	\$29.26	\$42.39	\$43.22	\$43.92	\$29.70	\$38.38
18	-0180	\$29.46	\$43.13	\$44.37	\$45.42	\$30.07	\$38.75
24	-0240	\$29.66	\$43.86	\$45.52	\$46.92	\$30.43	\$39.12
30	-0300	\$29.86	\$44.60	\$46.67	\$48.42	\$30.80	\$39.49
36	-0360	\$30.06	\$45.33	\$47.82	\$49.92	\$31.16	\$39.86
42	-0420	\$30.26	\$46.07	\$48.97	\$51.42	\$31.53	\$40.23
48	-0480	\$30.46	\$46.80	\$50.12	\$52.92	\$31.89	\$40.60
54	-0540	\$30.66	\$47.54	\$51.27	\$54.42	\$32.26	\$40.97
60	-0600	\$30.86	\$48.27	\$52.42	\$55.92	\$32.62	\$41.34
66	-0660	\$31.06	\$49.01	\$53.57	\$57.42	\$32.99	\$41.71
72	-0720	\$31.26	\$49.74	\$54.72	\$58.92	\$33.35	\$42.08
Solder Center, Crimp Outer							
LENGTH IN INCHES	DASH NUMBER	50 Ω RG 174 ^{⑥⑤} 1 shield ^⑦ 174-MBCMF-	50 Ω RG 316 ^{④②} 1 shield ^⑥ 316-MBCMF-	50 Ω RD316 ^{④②} 2 shields ^⑦ 31D-MBCMF-	50 Ω RG188* ^{④②} 1 shield ^⑥ 188-MBCMF-	50 Ω RG 178B/U ^② 1 shield ^⑥ 178-MBCMF-	50 Ω ^{②⑦①} RD*188 2 shields 88D-MBCMF-
12	-0120	\$30.30	\$30.71	\$37.96	\$31.06	\$35.36	\$39.63
18	-0180	\$30.42	\$31.04	\$38.89	\$31.56	\$35.73	\$41.39
24	-0240	\$30.54	\$31.36	\$39.81	\$32.06	\$36.10	\$43.15
30	-0300	\$30.66	\$31.69	\$40.74	\$32.56	\$36.47	\$44.91
36	-0360	\$30.78	\$32.01	\$41.66	\$33.06	\$36.84	\$46.67
42	-0420	\$30.90	\$32.34	\$42.59	\$33.56	\$37.21	\$48.43
48	-0480	\$31.02	\$32.66	\$43.51	\$34.06	\$37.58	\$50.19
54	-0540	\$31.14	\$32.99	\$44.44	\$34.56	\$37.95	\$51.95
60	-0600	\$31.26	\$33.31	\$45.36	\$35.06	\$38.32	\$53.71
66	-0660	\$31.38	\$33.64	\$46.29	\$35.56	\$38.69	\$55.47
Color Designators (add letter to the end of the part number and add \$1.00 to price)							
Black - B		Blue - L		Brown - N		Gray - A	
Orange - O		Red - R		Violet - V		Green - G	
						White - W	

See Page B5 for Cable Characteristics

* Contact Factory for delivery, Consider new RD316 for (RD188)

10% Discount @ 25 pcs. up

4% Discount @ 10 pcs. up

SMA 2 Hole Panel Jack x SMA 2 Hole Panel Jack



LTH IN INS	DASH NUM	50Ω RG 402 [Ⓢ] M17/130-00004 .141 Cu Jacket 402-M7M7-	50Ω MaxiFlex [Ⓢ] No QPL List .141 Tin Pl 14F-M7M7-	50Ω RG 405 [Ⓢ] M17/133-00007 .085 Tin Plate Cu 405-M7M7-	50Ω MaxiFlex [Ⓢ] No QPL List .085 Tin Pl 08F-M7M7-	50Ω [Ⓢ] M17/151-00001 .047 Cu Jacket 4CU-M7M7-	50Ω [Ⓢ] MaxiFlex No QPL List .047 Tin Pl 04F-M7M7-
.141/.085/.047" Diameter SEMIRIGID and Maxi Flex. Direct Solder Connectors							
12	-0120	\$50.04	\$49.68	\$49.46	\$50.69	\$50.24	\$50.94
24	-0240	\$53.64	\$52.92	\$52.48	\$54.94	\$54.04	\$55.44
36	-0360	\$57.24	\$56.16	\$55.50	\$59.19	\$57.84	\$59.94
48	-0480	\$60.84	\$59.40	\$58.52	\$63.44	\$61.64	\$64.44
60	-0600	\$64.44	\$62.64	\$61.54	\$67.69	\$65.44	\$68.94
72	-0720	\$68.04	\$65.88	\$64.56	\$71.49	\$69.24	\$73.44

SMA 4 Hole Panel Jack x SMA 4 Hole Panel Jack

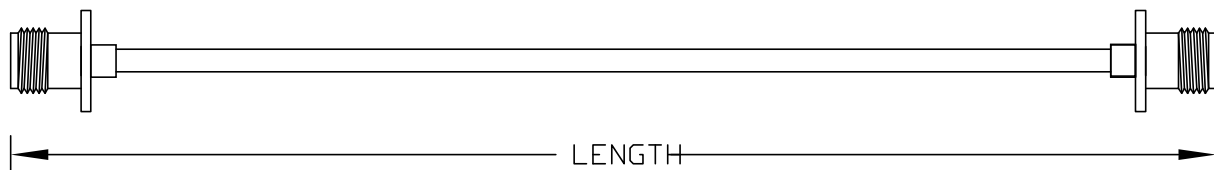

LTH IN INS	DASH NUM	50Ω RG 402 [Ⓢ] M17/130-00004 .141 Cu Jacket 402-M9M9-	50Ω MaxiFlex [Ⓢ] No QPL List .141 Tin Pl 14F-M9M9-	50Ω RG 405 [Ⓢ] M17/133-00007 .085 Tin Plate Cu 405-M9M9-	50Ω MaxiFlex [Ⓢ] No QPL List .085 Tin Pl 08F-M9M9-	50Ω [Ⓢ] M17/151-00001 .047 Cu Jacket 4CU-M9M9-	50Ω [Ⓢ] MaxiFlex No QPL List .047 Tin Pl 04F-M9M9-
.141/.085/.047" Diameter SEMIRIGID and Maxi Flex. Direct Solder Connectors							
12	-0120	\$46.92	\$46.56	\$46.34	\$47.57	\$47.12	\$47.82
24	-0240	\$50.52	\$49.80	\$49.36	\$51.82	\$50.92	\$52.32
36	-0360	\$54.12	\$53.04	\$52.38	\$56.07	\$54.72	\$56.82
48	-0480	\$57.72	\$56.28	\$55.40	\$60.32	\$58.52	\$61.32
60	-0600	\$61.32	\$59.52	\$58.42	\$64.57	\$62.32	\$65.82
72	-0720	\$64.92	\$62.76	\$61.44	\$68.82	\$66.12	\$70.32

Ⓢ Silver Plated Copper Center Conductor Ⓢ Silver Plated Copper Clad Steel Center Conductor

10% Discount @ 25 pcs. up 4% Discount @ 10 pcs. up



RF Depot.com Inc.

Phone 856-488-2000 Fax 856-488-2020

SMA 4 Hole Panel Jack x SMA Male Plug

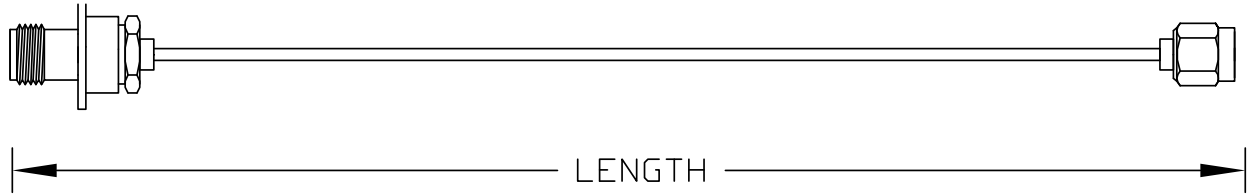

LENGTH IN INCHES	DASH NUMBER	50Ω RG 402 [Ⓢ] M17/130-00004 .141 Cu Jacket 402-M0M9-	50Ω MaxiFlex [Ⓢ] No QPL List .141 Tin Pl 14F-M0M9-	50Ω RG 405 [Ⓢ] M17/133-00007 .085 Tin Plate Cu 405-M0M9-	50Ω MaxiFlex [Ⓢ] No QPL List .085 Tin Pl 08F-M0M9-	50Ω [Ⓢ] M17/151-00001 .047 Cu Jacket 4CU-M0M9-	50Ω [Ⓢ] MaxiFlex No QPL List .047 Tin Pl 04F-M0M9-
.141/.085/.047" Diameter SEMIRIGID and Maxi Flex. Direct Solder Connectors							
12	-0120	\$36.30	\$35.94	\$35.72	\$36.95	\$32.25	\$32.95
24	-0240	\$39.90	\$39.18	\$38.74	\$41.20	\$36.05	\$37.45
36	-0360	\$43.50	\$42.42	\$41.76	\$45.45	\$39.85	\$41.95
48	-0480	\$47.10	\$45.66	\$44.78	\$49.70	\$43.65	\$46.45
60	-0600	\$50.70	\$48.90	\$47.80	\$53.95	\$47.45	\$50.95
72	-0720	\$54.30	\$52.14	\$50.82	\$58.20	\$51.25	\$55.45

SMA 4 Hole Panel Jack x TNC Male Plug

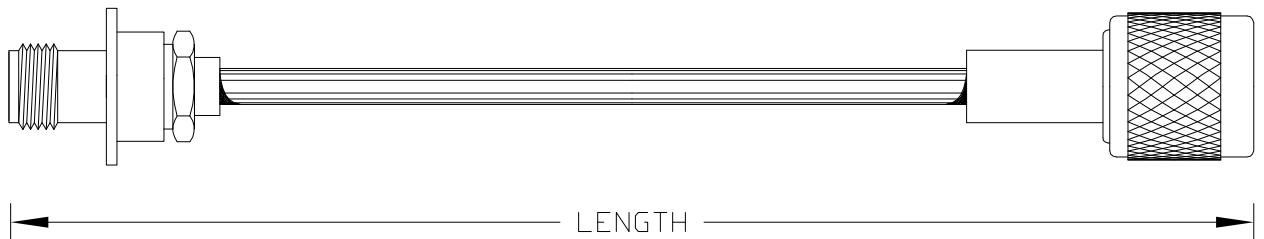

LENGTH IN INCHES	DASH NUMBER	50Ω RG 402 [Ⓢ] M17/130-00004 .141 Cu Jacket 402-M9T0-	50Ω MaxiFlex [Ⓢ] No QPL List .141 Tin Pl 14F-M9T0-	50Ω RG 405 [Ⓢ] M17/133-00007 .085 Tin Plate Cu 405-M9T0-	50Ω MaxiFlex [Ⓢ] No QPL List .085 Tin Pl 08F-M9T0-	50Ω [Ⓢ] M17/151-00001 .047 Cu Jacket 4CU-M9T0-	50Ω [Ⓢ] MaxiFlex No QPL List .047 Tin Pl 04F-M9T0-
.141/.085/.047" Diameter SEMIRIGID and Maxi Flex. Direct Solder Connectors							
12	-0120	\$78.96	\$78.60	\$75.68	\$76.91	\$44.47	\$45.17
24	-0240	\$82.56	\$81.84	\$78.70	\$81.16	\$48.27	\$49.67
36	-0360	\$86.16	\$85.08	\$81.72	\$85.41	\$52.07	\$54.17
48	-0480	\$89.76	\$88.32	\$84.74	\$89.66	\$55.87	\$58.67
60	-0600	\$93.36	\$91.56	\$87.76	\$93.91	\$59.67	\$63.17
72	-0720	\$96.96	\$94.80	\$90.78	\$98.16	\$63.47	\$67.67

Ⓢ Silver Plated Copper Center Conductor Ⓢ Silver Plated Copper Clad Steel Center Conductor

10% Discount @ 25 pcs. up 4% Discount @ 10 pcs. up

SMA Female Jack x SMA Female Jack

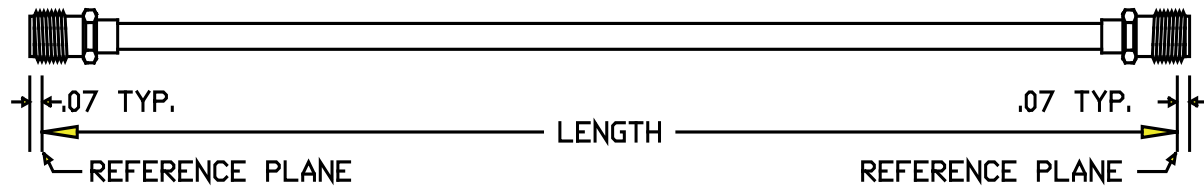

LENGTH IN INCHES	DASH NUMBER	50Ω RG 401① M17/129-RG401 .250 Cu Jacket 401-M1M1-	50Ω RG 401① No QPL List .250 Tin Plate Al 25A-M1M1-	50Ω RG 401② M17/129-00001 .250 Tin Plate Cu 2TS-M1M1-	50Ω MaxiFlex② No QPL List .250 Tin Plate Braid 25F-M1M1-	
.250" Diameter SEMIRIGID and Maxi Flex. Direct Solder Connectors						
24	-0240	Ⓐ	Ⓐ	Ⓐ	Ⓐ	
48	-0480	Ⓐ	Ⓐ	Ⓐ	Ⓐ	
72	-0720	Ⓐ	Ⓐ	Ⓐ	Ⓐ	
.141" Diameter SEMIRIGID and Maxi Flex. Direct Solder Connectors						
LENGTH IN INCHES	DASH NUMBER	50Ω RG 402② M17/130-00004 .141 Cu Jacket 402-M1M1-	50Ω RG 402② M17/130-00005 .141 Tin Plate Cu 1TS-M1M1-	50Ω RG 402① M17/130-00009 .141 Tin Plate Al 1AT-M1M1-	50ΩMaxiFlex② No QPL List .141 Tin Pl 14F-M1M1-	50Ω RG 402② M17/130-00012 .141 Silver Pl 1SS-M1M1-
12	-0120	\$30.66	\$30.30	\$30.66	\$30.30	\$39.87
24	-0240	\$34.26	\$33.54	\$34.26	\$33.54	\$52.68
36	-0360	\$37.86	\$36.78	\$37.86	\$36.78	\$65.49
48	-0480	\$41.46	\$40.02	\$41.46	\$40.02	\$78.30
60	-0600	\$45.06	\$43.26	\$45.06	\$43.26	\$91.11
72	-0720	\$48.66	\$46.50	\$48.66	\$46.50	\$103.92
.085" Diameter SEMIRIGID and Maxi Flex. Direct Solder Connectors						
LENGTH IN INCHES	DASH NUMBER	50Ω RG 405② M17/133-00007 .085 Tin Plate Cu 405-M1M1-	50Ω RG 405② M17/133-00007 .085 Tin Plate Cu 8TS-M1M1-	50Ω RG 405② M17/133-00013 .085 Tin Plate Al 8AT-M1M1-	50ΩMaxiFlex② No QPL List .085 Tin Pl 08F-M1M1-	50Ω RG 405② M17/133-00016 .085 Silver Pl 8SS-M1M1-
12	-0120	\$30.08	\$30.08	\$31.02	\$31.31	\$35.27
24	-0240	\$33.10	\$33.10	\$34.98	\$35.56	\$43.48
36	-0360	\$36.12	\$36.12	\$38.94	\$39.81	\$51.69
48	-0480	\$39.14	\$39.14	\$42.90	\$44.06	\$59.90
60	-0600	\$42.16	\$42.16	\$46.86	\$48.31	\$68.11
72	-0720	\$45.18	\$45.18	CALL	\$52.56	CALL
.047" Diameter SEMIRIGID and Maxi Flex. Direct Solder Connectors						
LENGTH IN INCHES	DASH NUMBER	50Ω ② M17/151-00001 .047 Cu Jacket 4CU-M1M1-	50Ω② No QPL List .047 Tin Plate Al 4AT-M1M1-	50Ω② M17/151-00002 .047 Tin Plate Cu 4TS-M1M1-	50Ω ② MaxiFlex No QPL List .047 Tin Plate Braid 04F-M1M1-	
12	-0120	\$52.30	\$53.75	\$52.30	\$53.00	
24	-0240	\$56.10	\$59.00	\$56.10	\$57.50	
36	-0360	\$59.90	\$64.25	\$59.90	\$62.00	
48	-0480	\$63.70	\$69.50	\$63.70	\$66.50	
60	-0600	\$67.50	\$74.75	\$67.50	\$71.00	

Ⓐ Order Stainless Steel SMA Bulkhead Jack x Bulkhead Jack Cable Assembly on Page B120

①Silver Plated Copper Center Conductor ②Silver Plated Copper Clad Steel Center Conductor

10% Discount @ 25 pcs. up 4% Discount @ 10 pcs. up

SMA Female Jack x SMA Female Jack Commercial

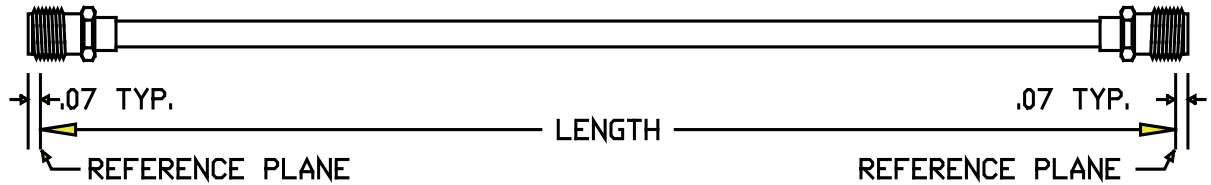

LENGTH IN INCHES	DASH NUMBER	50Ω RG 401Ⓞ M17/129-RG401 .250 Cu Jacket 401-M1M1-	50Ω RG 401Ⓞ No QPL List .250 Tin Plate Al 25A-M1M1-	50Ω RG 401Ⓞ M17/129-00001 .250 Tin Plate Cu 2TS-M1M1-	50Ω MaxiFlexⓄ No QPL List .250 Tin Plate Braid 25F-M1M1-		
.250" Diameter SEMIRIGID and Maxi Flex. Direct Solder Connectors							
24	-0240C	\$36.06	\$37.94	\$46.44	\$36.06		
36	-0360C	\$39.08	\$41.90	\$54.65	\$39.08		
48	-0480C	\$42.10	\$45.86	\$62.86	\$42.10		
60	-0600C	\$45.12	\$49.82	\$71.07	\$45.12		
72	-0720C	\$48.14	\$53.78	\$79.28	\$48.14		
.141" Diameter SEMIRIGID and Maxi Flex. Direct Solder Connectors							
LENGTH IN INCHES	DASH NUMBER	50Ω RG 402Ⓞ M17/130-00004 .141 Cu Jacket 402-M1M1-	50Ω RG 402Ⓞ M17/130-00005 .141 Tin Plate Cu 1TS-M1M1-	50Ω RG 402Ⓞ M17/130-00009 .141 Tin Plate Al 1AT-M1M1-	50Ω MaxiFlexⓄ No QPL List .141 Tin Pl 14F-M1M1-	50Ω RG 402Ⓞ M17/130-00012 .141 Silver Pl 1SS-M1M1-	
12	-0120C	\$22.74	\$22.38	\$22.74	\$22.38	\$31.95	
24	-0240C	\$26.34	\$25.62	\$26.34	\$25.62	\$44.76	
36	-0360C	\$29.94	\$28.86	\$29.94	\$28.86	\$57.57	
48	-0480C	\$33.54	\$32.10	\$33.54	\$32.10	\$70.38	
60	-0600C	\$37.14	\$35.34	\$37.14	\$35.34	\$83.19	
72	-0720C	\$40.74	\$38.58	CALL	\$38.58	CALL	
.085" Diameter SEMIRIGID and Maxi Flex. Direct Solder Connectors							
LENGTH IN INCHES	DASH NUMBER	50Ω RG 405Ⓞ M17/133-00007 .085 Tin Plate Cu 405-M1M1-	50Ω RG 405Ⓞ M17/133-00007 .085 Tin Plate Cu 8TS-M1M1-	50Ω RG 405Ⓞ M17/133-00013 .085 Tin Plate Al 8AT-M1M1-	50Ω MaxiFlexⓄ No QPL List .085 Tin Pl 08F-M1M1-	50Ω RG 405Ⓞ M17/133-00016 .085 Silver Pl 8SS-M1M1-	
12	-0120C	\$22.34	\$22.34	\$23.28	\$23.57	\$27.53	
24	-0240C	\$25.36	\$25.36	\$27.24	\$27.82	\$35.74	
36	-0360C	\$28.38	\$28.38	\$31.20	\$32.07	\$43.95	
48	-0480C	\$31.40	\$31.40	\$35.16	\$36.32	\$52.16	
60	-0600C	\$34.42	\$34.42	\$39.12	\$40.57	\$60.37	
72	-0720C	\$37.44	\$37.44	CALL	\$44.82	CALL	
.047/.085" Diameter SEMIRIGID and Maxi Flex. Direct Solder Connectors							
LTH IN INS	DASH NUM	50Ω Ⓞ M17/151-00001 .047 Cu Jacket 4CU-M1M1-	50Ω Ⓞ No QPL List .047 Tin Pl Al 4AT-M1M1-	50Ω Ⓞ M17/151-00002 .047 Tin Pl Cu 4TS-M1M1-	50Ω Ⓞ MaxiFlex No QPL List .047 Tin Pl 04F-M1M1-	50Ω Ⓞ Non-Magnetic .085 Tin Pl Cu 8CT-M1M1-	50Ω MaxiFlexⓄ Non-Magnetic .085 Tin Pl Cu 08C-M1M1-
12	-0120C	\$24.82	\$26.27	\$24.82	\$25.52	Ⓐ	Ⓐ
24	-0240C	\$28.62	\$31.52	\$28.62	\$30.02	Ⓐ	Ⓐ
60	-0600C	\$40.02	\$47.27	\$40.02	\$43.52	Ⓐ	Ⓐ

Ⓞ Silver Plated Copper Center Conductor Ⓞ Silver Plated Copper Clad Steel Center Conductor

10% Discount @ 25 pcs. up 4% Discount @ 10 pcs. up

Ⓐ Order Stainless Steel SMA Bulkhead Jack x Bulkhead Jack Cable Assembly on Page B120



SMA Female Jack x SMA Male Plug

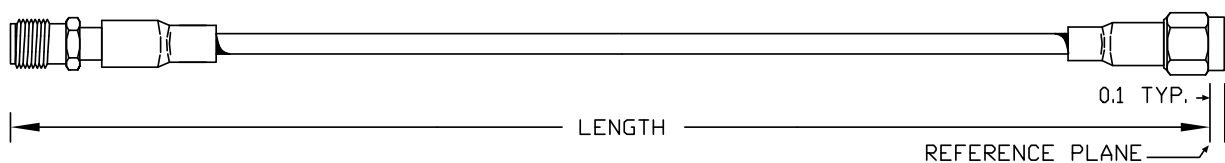

LENGTH IN INCHES	DASH NUMBER	50 Ω ^{⑥⑦} RG 58C ^⑧ 1 shield 058-MAMB-	50 Ω ^{⑨①} RG 223 2 shields ^⑦ 223-MAMB-	50 Ω ^② RG142B 2 shields ^⑦ 142-MAMB-	50 Ω ^{①⑦} RG 400 ^{✕④} 2 shields ^⑦ 400-MAMB-	75 Ω RG179A ^② 1 shield ^⑩ 179-MAMB-	
Solder Center, Crimp Outer							
12	-0120	\$34.54	\$36.70	\$37.53	\$38.23	\$29.80	
24	-0240	\$34.94	\$38.17	\$39.83	\$41.23	\$30.53	
36	-0360	\$35.34	\$39.64	\$42.13	\$44.23	\$31.26	
48	-0480	\$35.74	\$41.11	\$44.43	\$47.23	\$31.99	
60	-0600	\$36.14	\$42.58	\$46.73	\$50.23	\$32.72	
72	-0720	\$36.54	\$44.05	\$49.03	\$53.23	\$33.45	
Solder Center, Crimp Outer							
LENGTH IN INCHES	DASH NUMBER	50 Ω RG 174 ^{③⑤} 1 shield ^⑦ 174-MAMB-	50 Ω RG 316 ^{④②} 1 shield ^⑩ 316-MAMB-	50 Ω RD316 ^{④②} 2 shields ^⑦ 31D-MAMB-	50 Ω RG188 ^{*④②} 1 shield ^⑩ 188-MAMB-	50 Ω RG 178B/U ^② 1 shield ^⑩ 178-MAMB-	50 Ω RG 196 ^② 1 shield ^⑩ 196-MAMB-
12	-0120	\$29.31	\$29.72	\$29.37	\$30.07	\$34.40	\$34.40
24	-0240	\$29.55	\$30.37	\$31.22	\$31.07	\$35.14	\$35.14
36	-0360	\$29.79	\$31.02	\$33.07	\$32.07	\$35.88	\$35.88
48	-0480	\$30.03	\$31.67	\$34.92	\$33.07	\$36.62	\$36.62
60	-0600	\$30.27	\$32.32	\$36.77	\$34.07	\$37.36	\$37.36
72	-0720	\$30.51	\$32.97	\$38.62	\$35.07	\$38.10	\$38.10
Solder Center, Crimp Outer							
LENGTH IN INCHES	DASH NUMBER	50 Ω ^③ SIG 195 ^⑥ 2 shields ^⑩ 19C-MAMB-	50 Ω ^③ LMR 195 ^⑥ 2 shields ^⑩ 19M-MAMB-	50 Ω ^{④⑨} SIG 400 ^⑥ 2 shields 4LC-MAMB-	50 Ω ^{④⑨} LMR 400 ^⑥ 2 shields 4LM-MAMB-	50 Ω LL 142 2 shields 4LL-MAMB-	
12	-0120C	\$34.71	\$34.85	\$25.22	\$25.74	\$34.71	
24	-0240C	\$35.28	\$35.56	\$26.08	\$27.12	\$35.28	
36	-0360C	\$35.85	\$36.27	\$26.94	\$28.50	\$35.85	
48	-0480C	\$36.42	\$36.98	\$27.80	\$29.88	\$36.42	
60	-0600C	\$36.99	\$37.69	\$28.66	\$31.26	\$36.99	
72	-0720C	\$37.56	\$38.40	\$29.52	\$32.64	\$37.56	
Color Designators (add letter to the end of the part number and add \$1.00 to price)							
Black - B		Blue - L		Brown - N		Gray - A	
Orange - O		Red - R		Violet - V		Yellow - Y	
						Green - G	
						White - W	

See Page B5 for Cable Characteristics

* Contact Factory for delivery, Consider new RD316 for (RD188) 10% Discount @ 25 pcs. up 4% Discount @ 10 pcs. up



RF Depot.com Inc.

Phone 856-488-2000 Fax 856-488-2020

SMA Female Jack x SMA Male Plug

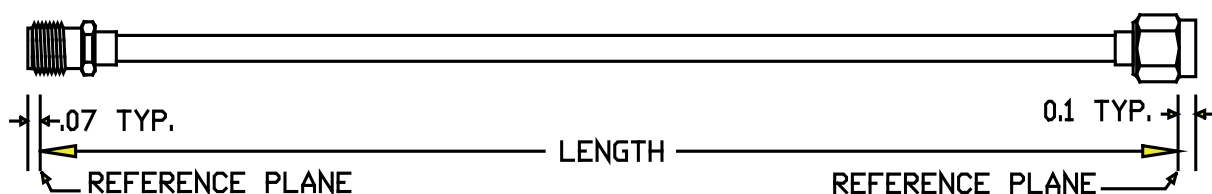

LENGTH IN INCHES	DASH NUMBER	50Ω RG 401 [ⓐ] M17/129-RG401 .250 Cu Jacket 401-M0M1-	50Ω RG 401 [ⓐ] No QPL List .250 Tin Plate Al 25A-M0M1-	50Ω RG 401 [ⓐ] M17/129-00001 .250 Tin Plate Cu 2TS-M0M1-	50Ω MaxiFlex [ⓐ] No QPL List .250 Tin Plate Braid 25F-M0M1-		
.250" Diameter SEMIRIGID and Maxi Flex. Direct Solder Connectors							
24	-0240	(A)	(A)	(A)	(A)		
48	-0480	(A)	(A)	(A)	(A)		
72	-0720	(A)	(A)	(A)	(A)		
.141" Diameter SEMIRIGID and Maxi Flex. Direct Solder Connectors							
LTH IN INS	DASH NUM	50Ω RG 402 [ⓐ] M17/130-00004 .141 Cu Jacket 402-M0M1-	50Ω RG 402 [ⓐ] M17/130-00005 .141 Tin Plate Cu 1TS-M0M1-	50Ω RG 402 [ⓐ] M17/130-00009 .141 Tin Plate Al 1AT-M0M1-	50Ω MaxiFlex [ⓐ] No QPL List .141 Tin Pl 14F-M0M1-	50Ω RG 402 [ⓐ] M17/130-00012 .141 Silver Plate Cu 1SS-M0M1-	
12	-0120	\$28.17	\$27.81	\$28.17	\$27.81	\$37.38	
24	-0240	\$31.77	\$31.05	\$31.77	\$31.05	\$50.19	
36	-0360	\$35.37	\$34.29	\$35.37	\$34.29	\$63.00	
48	-0480	\$38.97	\$37.53	\$38.97	\$34.53	\$75.81	
60	-0600	\$42.57	\$40.77	\$42.57	\$40.77	\$88.62	
72	-0720	\$46.17	\$44.01	\$46.17	\$44.01	\$101.43	
.085" Diameter SEMIRIGID and Maxi Flex. Direct Solder Connectors							
LTH IN INS	DASH NUM	50Ω RG 405 [ⓐ] M17/133-00007 .085 Tin Plate Cu 405-M0M1-	50Ω RG 405 [ⓐ] M17/133-00007 .085 Tin Plate Cu 8TS-M0M1-	50Ω RG 405 [ⓐ] M17/133-00013 .085 Tin Plate Al 8AT-M0M1-	50Ω MaxiFlex [ⓐ] No QPL List .085 Tin Pl 08F-M0M1-	50Ω RG 405 [ⓐ] M17/133-00016 .085 Silver Plate Cu 8SS-M0M1-	
12	-0120	\$27.59	\$27.59	\$28.53	\$28.82	\$32.78	
24	-0240	\$30.61	\$30.61	\$32.49	\$33.07	\$40.99	
36	-0360	\$33.63	\$33.63	\$36.45	\$37.32	\$49.20	
48	-0480	\$36.65	\$36.65	\$40.41	\$41.57	\$57.41	
60	-0600	\$39.67	\$39.67	\$44.37	\$45.82	\$65.62	
72	-0720	\$42.69	\$42.69	CALL	\$50.07	CALL	
.085"/.047" Diameter SEMIRIGID and Maxi Flex. Direct Solder Connectors							
LTH IN INS	DASH NUM	50Ω [ⓐ] M17/151-00001 .047 Cu Jacket 4CU-M0M1-	50Ω [ⓐ] No QPL List .047 Tin Plate Al 4AT-M0M1-	50Ω [ⓐ] M17/151-00002 .047 Tin Plate Cu 4TS-M0M1-	50Ω [ⓐ] MaxiFlex No QPL List .047 Tin Pl 04F-M0M1-	50 Ω MaxiFlex [ⓐ] No QPL List .085 Tin Pl 08J-M0M1-	50Ω ^{ⓐ1} M17/154-00002 .034 Tin Pl Cu 3TS-M0M1-
12	-0120	\$47.05	\$48.50	\$47.05	\$47.75	(A)	(A)
24	-0240	\$50.85	\$53.75	\$50.85	\$52.25	(A)	(A)
36	-0360	\$54.65	\$59.00	\$54.65	\$56.75	(A)	(A)
48	-0480	\$58.45	\$64.25	\$58.45	\$61.25	(A)	(A)
60	-0600	\$62.25	\$69.50	\$62.25	\$65.75	(A)	(A)

[ⓐ] Order SMA Bulkhead Jack x Bulkhead Cable Assembly

^{ⓐ1} Gold Plated Copper Beryllium Connector

[ⓐ]Silver Plated Copper Center Conductor

[ⓐ]Silver Plated Copper Clad Steel Center Conductor

10% Discount @ 25 pcs. up

4% Discount @ 10 pcs. up

SMA Female Jack x SMA Male Plug Commercial

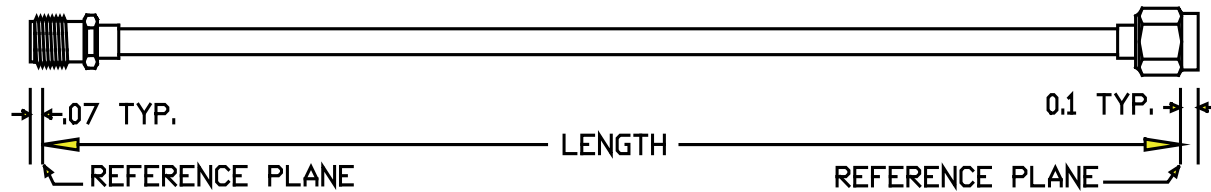

LENGTH IN INCHES	DASH NUMBER	50Ω RG 401 [Ⓞ] M17/129-RG401 .250 Cu Jacket 401-M0M1-	50Ω RG 401 [Ⓞ] No QPL List .250 Tin Plate Al 25A-M0M1-	50Ω RG 401 [Ⓢ] M17/129-00001 .250 Tin Plate Cu 2TS-M0M1-	50Ω MaxiFlex [Ⓢ] No QPL List .250 Tin Plate Braid 25F-M0M1-	
.250" Diameter SEMIRIGID and Maxi Flex. Direct Solder Connectors						
24	-0240C	\$32.73	\$34.61	\$43.11	\$32.73	
36	-0360C	\$35.75	\$38.57	\$51.32	\$35.75	
48	-0480C	\$38.77	\$42.53	\$59.53	\$38.77	
60	-0600C	\$41.79	\$46.49	\$67.74	\$41.79	
72	-0720C	\$44.81	\$50.45	\$75.95	\$44.81	
.141" Diameter SEMIRIGID and Maxi Flex. Direct Solder Connectors						
LENGTH IN INCHES	DASH NUMBER	50Ω RG 402 [Ⓢ] M17/130-00004 .141 Cu Jacket 402-M0M1-	50Ω RG 402 [Ⓢ] M17/130-00005 .141 Tin Pl Cu 1TS-M0M1-	50Ω RG 402 [Ⓞ] M17/130-00009 .141 Tin Pl Al 1AT-M0M1-	50Ω MaxiFlex [Ⓢ] No QPL List .141 Tin Pl 14F-M0M1-	50Ω RG 402 [Ⓢ] M17/130-00012 .141 Silver Pl 1SS-M0M1-
12	-0120C	\$21.10	\$20.74	\$21.10	\$20.74	\$30.31
24	-0240C	\$24.70	\$23.98	\$24.70	\$23.98	\$43.12
36	-0360C	\$28.30	\$27.22	\$28.30	\$27.22	\$55.93
48	-0480C	\$31.90	\$30.46	\$31.90	\$30.46	\$68.74
60	-0600C	\$35.50	\$33.70	\$35.50	\$33.70	\$81.55
72	-0720C	\$39.10	\$36.94	\$39.10	\$36.94	\$94.36
.085" Diameter SEMIRIGID and Maxi Flex. Direct Solder Connectors						
LENGTH IN INCHES	DASH NUMBER	50Ω RG 405 [Ⓢ] M17/133-00007 .085 Tin Pl Cu 405-M0M1-	50Ω RG 405 [Ⓢ] M17/133-00007 .085 Tin Pl Cu 8TS-M0M1-	50Ω RG 405 [Ⓢ] M17/133-00013 .085 Tin Pl Al 8AT-M0M1-	50Ω MaxiFlex [Ⓢ] No QPL List .085 Tin Pl 08F-M0M1-	50Ω RG 405 [Ⓢ] M17/133-00016 .085 Silver Pl 8SS-M0M1-
12	-0120C	\$23.05	\$23.05	\$23.99	\$24.28	\$28.24
24	-0240C	\$26.07	\$26.07	427.95	\$28.53	\$36.45
36	-0360C	\$29.09	\$29.09	\$31.91	\$32.78	\$44.66
48	-0480C	\$32.11	\$32.11	\$35.87	\$37.03	\$52.87
60	-0600C	\$35.13	\$35.13	\$39.83	\$41.28	\$61.08
72	-0720C	\$38.15	\$38.15	CALL	\$45.53	CALL
.047" Diameter SEMIRIGID and Maxi Flex. Direct Solder Connectors						
LENGTH IN INCHES	DASH NUMBER	50Ω [Ⓢ] M17/151-00001 .047 Cu Jacket 4CU-M0M1-	50Ω [Ⓢ] No QPL List .047 Tin Pl Al 4AT-M0M1-	50Ω [Ⓢ] M17/151-00002 .047 Tin Pl Cu 4TS-M0M1-	50Ω [Ⓢ] MaxiFlex [Ⓢ] No QPL List .047 Tin Pl 04F-M0M1-	50Ω [Ⓞ] Non-Magnetic .085 Tin Pl Cu 8CT-M0M1-
12	-0120C	\$24.71	\$26.16	\$24.71	\$25.41	\$23.09
24	-0240C	\$28.51	\$31.41	\$28.51	\$29.91	\$25.27
60	-0600C	\$39.91	\$47.16	\$39.91	\$43.41	\$31.81

Ⓞ Silver Plated Copper Center Conductor Ⓢ Silver Plated Copper Clad Steel Center Conductor

10% Discount @ 25 pcs. up 4% Discount @ 10 pcs. up

SMA Male Plug x SMA Male Plug

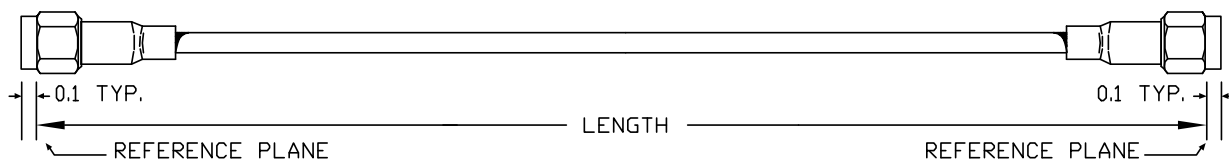

LENGTH IN INCHES	DASH NUM	50 Ω RG 58C ⑤⑥ 1 shield⑦ 058-MAMA-	50 Ω RG 223⑤① 2 shields⑦ 223-MAMA-	50 Ω RG 142B④② 2 shields⑦ 142-MAMA-	50 Ω RG 178 ② 1 shield⑥ 178-MAMA-	50 Ω① RG 400*④ 2 shields ⑦ 400-MAMA-	75 Ω⑤ RG59B ⑤‡ 1 shield⑥ 059-MAMA-	93 Ω⑤ RG 62⑤‡ 1 shield⑥ 062-MAMA-
Solder Center, Crimp Outer with Strain Relief								
12	-0120	\$29.36	\$31.11	\$31.94	\$38.28	\$31.94	\$53.10	\$53.10
24	-0240	\$27.86	\$32.58	\$34.24	\$37.46	\$35.64	\$51.68	\$52.20
36	-0360	\$28.26	\$34.05	\$36.54	\$38.20	\$38.64	\$52.12	\$52.90
48	-0480	\$28.66	\$35.52	\$38.84	\$38.94	\$41.64	\$52.56	\$53.60
60	-0600	\$29.06	\$36.99	\$41.14	\$39.68	\$44.64	\$53.00	\$54.30
72	-0720	\$29.46	\$38.46	\$43.44	\$40.42	\$47.64	\$53.44	\$55.00
Solder Center, Crimp Outer								
LENGTH IN INCHES	DASH NUM	50 Ω RG 174 ⑤⑤ 1 shield⑦ 174-MAMA-	50 Ω RG 316④② 1 shield⑥ 316-MAMA-	50 Ω RD 316④② 2 shields⑦ 31D-MAMA-	50 Ω RG188*④② 1 shield⑥ 188-MAMA-	50 Ω RG 196② 1 shield⑥ 196-MAMA-	75 Ω RG 179A④② 1 shield⑥ 179-MAMA-	
12	-0120	\$23.40	\$23.81	\$21.91	\$24.16	\$36.72	\$23.89	
24	-0240	\$23.64	\$24.46	\$23.76	\$25.16	\$37.46	\$24.62	
36	-0360	\$23.88	\$25.11	\$25.61	\$26.16	\$38.20	\$25.35	
48	-0480	\$24.12	\$25.76	\$27.46	\$27.16	\$38.94	\$26.08	
60	-0600	\$24.36	\$26.41	\$29.31	\$28.16	\$39.68	\$26.81	
72	-0720	\$24.60	\$27.06	\$31.16	\$29.16	\$40.42	\$27.54	
Solder Center, Crimp and Clamp Outer								
LENGTH IN INCHES	DASH NUM	50 Ω RG 8A* ⑤⑤ 1 shield⑥ 008-MAMA-	50 Ω RG 213 ⑤⑤ 1 shield⑥ 213-MAMA-	50 Ω RG 214 ⑤① 2 shields⑦ 214-MAMA-	75 Ω⑤ RG 59B ⑤‡ 1 shield⑥ 059-MAMA-	50 Ω RG 393④①⑤ 2 shields 393-MAMA-	93 Ω⑤ RG 62 ⑤‡ 1 shield⑥ 062-MAMA-	
12	-0120C	\$37.44	\$37.62	\$39.86	\$51.24	\$44.99	\$51.50	
24	-0240C	\$38.84	\$39.20	\$43.36	\$51.68	\$53.62	\$52.20	
36	-0360C	\$40.24	\$40.78	\$46.86	\$52.12	\$62.25	\$52.90	
48	-0480C	\$41.64	\$42.36	\$50.36	\$52.56	\$70.88	\$53.60	
60	-0480C	\$43.04	\$43.94	\$53.86	\$53.00	\$79.51	\$54.30	
72	-0720C	\$44.44	\$45.52	\$57.36	\$53.44	\$88.14	\$55.00	
Color Designators (add letter to the end of the part number and add \$1.00 to price)								
Black - B		Blue - L		Brown - N		Gray - A		Green - G
Orange - O		Red - R		Violet - V		Yellow - Y		White - W

See Page B5 for Cable Characteristics

* Contact Factory for delivery, Consider new RD316 for (RD188)

10% Discount @ 25 pcs. up

4% Discount @ 10 pcs. up

‡ Brass Body Stainless Steel Nut



SMA Male Plug x SMA Male Plug

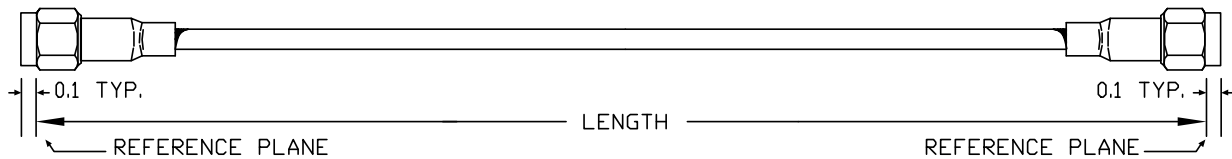

LENGTH IN INCHES	DASH NUMBER	50 Ω SF 142B② 3 shields③ S42-MAMA-	50 Ω SFT 142B① 3 shields③ 42T-MAMA-	50 Ω LL 142②③ 2 shields 4LL-MAMA-	50 Ω SFT 316 3 shields 16T-MAMA-	50 Ω SFT 304 3 shields 04T-MAMA-	50 Ω SFT 205 3 shields 20T-MAMA-
Solder Center, Crimp Outer with Strain Relief							
24	-0240	\$42.28	\$122.96	\$125.04	\$125.44	\$145.30	\$113.88
48	-0480	\$54.92	\$144.48	\$148.64	\$149.44	\$180.74	\$132.32
72	-0720	\$67.56	\$166.00	\$172.24	\$173.44	\$216.18	\$150.76
96	-0960	\$80.20	\$187.52	\$195.84	\$197.44	\$251.62	\$169.20
120	-1200	\$92.84	\$209.04	\$219.44	\$221.44	\$287.06	\$187.64
144	-1440	\$105.48	\$230.56	\$243.04	\$245.44	\$322.50	\$206.08
180	-1800	\$124.44	\$262.84	\$278.44	\$281.44	\$375.66	\$233.74
240	-2400	\$156.04	\$316.64	\$313.84	\$317.44	\$464.26	\$279.84
Solder Center, Crimp and Clamp Outer							
LENGTH IN INCHES	DASH NUMBER	50 Ω EF 142① 2 shields⑦ 42E-MAMA-	50 Ω EF 400① 2 shields⑦ 40E-MAMA-	50 Ω EF 316D② 2 shields⑦ 16E-MAMA-	50 Ω EF 393① 2 shields⑦ 93E-MAMA-	50 Ω SIG 100④⑤ 2 shields③ 1LC-MAMA-	50 Ω LMR 100④⑤ 2 shields③ 1LM-MAMA-
24	-0240C	\$34.68	\$34.76	\$28.10	\$54.92	\$21.30	\$21.54
48	-0480C	\$39.72	\$39.88	\$33.04	\$73.48	\$22.38	\$22.86
72	-0720C	\$44.76	\$45.00	\$37.98	\$92.04	\$23.46	\$24.18
96	-0960C	\$49.80	\$50.12	\$42.92	\$110.60	\$24.54	\$25.50
120	-1200C	\$54.84	\$55.24	\$47.86	\$129.16	\$25.62	\$26.82
144	-1440C	\$59.88	\$60.36	\$52.80	\$147.72	\$26.70	\$28.14
180	-1800C	\$67.44	\$68.04	\$60.21	\$175.56	\$28.32	\$30.12
240	-2400C	\$80.04	\$80.84	\$72.56	\$221.96	\$31.02	\$33.42
Solder Center, Crimp Outer with Strain Relief							
LENGTH IN INCHES	DASH NUMBER	50 Ω SIG 195④③ 2 shields③ 19C-MAMA-	50 Ω LMR195④③ 2 shields③ 19M-MAMA-	50 Ω③ SIG 195FR④ 2 shields③ 19F-MAMA-	50 Ω③ LMR 195FR④ 2 shields③ 19R-MAMA-	50 Ω③ SIG 195DB④ 2 shields③ 19B-MAMA-	50 Ω③ LMR 195DB④ 2 shields③ 19D-MAMA-
24	-0240C	\$23.36	\$23.64	\$21.42	\$22.20	\$21.38	\$21.76
48	-0480C	\$24.50	\$25.06	\$22.62	\$24.18	\$22.54	\$23.30
72	-0720C	\$25.64	\$26.48	\$23.82	\$26.16	\$23.70	\$24.84
96	-0960C	\$26.78	\$27.90	\$25.02	\$28.14	\$24.86	\$26.38
120	-1200C	\$27.92	\$29.32	\$26.22	\$30.12	\$26.02	\$27.92
144	-1440C	\$29.06	\$30.74	\$27.42	\$32.10	\$27.18	\$29.46
180	-1800C	\$30.77	\$32.87	\$29.22	\$35.07	\$28.92	\$31.77
Color Designators (add letter to the end of the part number and add \$1.00 to price)							
Black - B		Blue - L		Brown - N		Gray - A	
Orange - O		Red - R		Violet - V		Green - G	
						White - W	

See Page B5 for Cable Characteristics

* Contact Factory for delivery, Consider new RD316 for (RD188)

10% Discount @ 25 pcs. up

4% Discount @ 10 pcs. up



RF Depot.com Inc.

Phone 856-488-2000 Fax 856-488-2020

B140

7850 Browning Rd. Pennsauken, NJ 08109

Online @ www.rfdepot.com

Toll Free 877-RF Depot

SMA Male Plug x SMA Male Plug

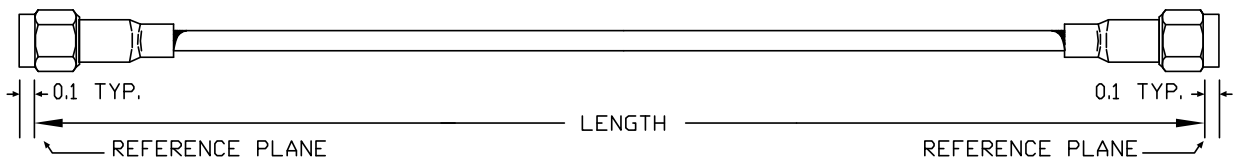

LENGTH IN INCHES	DASH NUMBER	50 Ω SIG 200 [Ⓞ] ^③ 2 shields [Ⓞ] 2LC-MAMA-	50 Ω LMR 200 [Ⓞ] ^③ 2 shields [Ⓞ] 2LM-MAMA-	50 Ω ^③ SIG 200DB [Ⓞ] 2 shields [Ⓞ] 20B-MAMA-	50 Ω ^③ LMR 200DB [Ⓞ] 2 shields [Ⓞ] 2LD-MAMA-	50 Ω ^③ SIG 240 [Ⓞ] 2 shields [Ⓞ] 24C-MAMA-	50 Ω ^③ LMR 240 [Ⓞ] 2 shields [Ⓞ] 24L-MAMA-
Solder Center, Crimp Outer with Strain Relief							
24	-0240C	\$23.86	\$23.96	\$21.98	\$22.08	\$26.76	\$27.60
48	-0480C	\$25.22	\$25.42	\$23.46	\$23.66	\$27.96	\$29.64
72	-0720C	\$26.58	\$26.88	\$24.94	\$25.24	\$29.16	\$31.68
96	-0960C	\$27.94	\$28.34	\$26.42	\$26.82	\$30.36	\$33.72
120	-1200C	\$29.30	\$29.80	\$27.90	\$28.40	\$31.56	\$35.76
144	-1440C	\$30.66	\$31.26	\$29.38	\$29.98	\$32.76	\$37.80
180	-1800C	\$32.70	\$33.45	\$31.60	\$32.35	\$34.56	\$40.86
Solder Center, Crimp and Clamp Outer							
LENGTH IN INCHES	DASH NUMBER	50 Ω ^③ SIG 240UF [Ⓞ] 2 shields [Ⓞ] 2U4-MAMA-	50 Ω ^③ LMR 240UF [Ⓞ] 2 shields [Ⓞ] 24U-MAMA-	50 Ω ^③ SIG 300 [Ⓞ] ^③ 2 shields [Ⓞ] 3LC-MAMA-	50 Ω ^③ LMR 300 [Ⓞ] ^③ 2 shields [Ⓞ] 3LM-MAMA-	50 Ω ^④ SIG 400 [Ⓞ] 2 shields [Ⓞ] 4LC-MAMA-	50 Ω ^④ LMR 400 [Ⓞ] ^④ 2 shields [Ⓞ] 4LM-MAMA-
24	-0240C	\$26.88	\$27.92	\$38.74	\$39.54	\$27.28	\$28.32
48	-0480C	\$28.20	\$30.28	\$40.18	\$41.78	\$29.00	\$31.08
72	-0720C	\$29.52	\$32.64	\$41.62	\$44.02	\$30.72	\$33.84
96	-0960C	\$30.84	\$35.00	\$43.06	\$46.26	\$32.44	\$36.60
120	-1200C	\$32.16	\$37.36	\$44.50	\$48.50	\$34.16	\$39.36
144	-1440C	\$33.48	\$39.72	\$45.94	\$50.74	\$35.88	\$42.12
180	-1800C	\$35.46	\$43.26	\$48.10	\$54.10	\$38.46	\$46.26
Solder Center, Crimp and Clamp Outer							
LENGTH IN INCHES	DASH NUMBER	50 Ω ^④ SIG 400DB [Ⓞ] 2 shields [Ⓞ] 4DC-MAMA-	50 Ω ^④ LMR 400DB [Ⓞ] 2 shields [Ⓞ] 4LD-MAMA-	50 Ω ^④ SIG 400FR [Ⓞ] 2 shields [Ⓞ] 4RC-MAMA-	50 Ω ^④ LMR 400FR [Ⓞ] 2 shields [Ⓞ] 4LR-MAMA-	50 Ω ^④ SIG 400UF [Ⓞ] 2 shields [Ⓞ] 4UC-MAMA-	50 Ω ^④ LMR 400UF [Ⓞ] 2 shields [Ⓞ] 4UF-MAMA-
24	-0240C	\$27.52	\$28.76	\$27.52	\$29.36	\$27.52	\$29.36
48	-0480C	\$29.48	\$31.96	\$29.48	\$33.16	\$29.48	\$33.16
72	-0720C	\$31.44	\$35.16	\$31.44	\$36.96	\$31.44	\$36.96
96	-0960C	\$33.40	\$38.36	\$33.40	\$40.76	\$33.40	\$40.76
120	-1200C	\$35.36	\$41.56	\$35.36	\$44.56	\$35.36	\$44.56
144	-1440C	\$37.32	\$44.76	\$37.32	\$48.36	\$37.32	\$48.36
180	-1800C	\$40.26	\$49.56	\$40.26	\$54.06	\$40.26	\$54.06
240	-2400C	\$45.16	\$57.56	\$45.16	\$63.56	\$45.16	\$63.56
Color Designators (add letter to the end of the part number and add \$1.00 to price)							
Black - B		Blue - L		Brown - N		Gray - A	
Orange - O		Red - R		Violet - V		Green - G	
						White - W	

See Page B5 for Cable Characteristics

* Contact Factory for delivery, Consider new RD316 for (RD188)

10% Discount @ 25 pcs. up

4% Discount @ 10 pcs. up

SMA Male Plug x SMA Male Plug

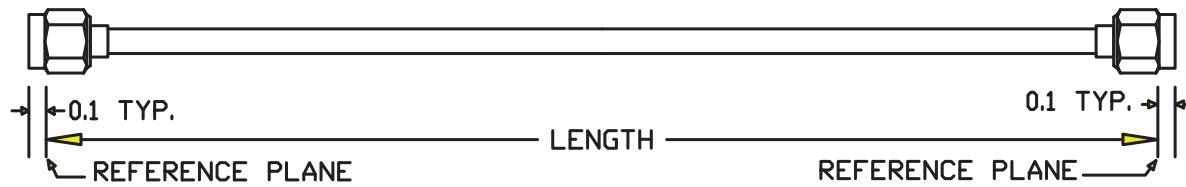

LENGTH IN INCHES	DASH NUMBER	50 Ω RG 401 [Ⓞ] M17/129-RG401 .250 Cu Jacket 401-M0M0-	50 Ω RG 401 [Ⓞ] No QPL List .250 Tin Plate Al 25A-M0M0-	50 Ω RG 401 [Ⓢ] M17/129-00001 .250 Tin Plate Cu 2TS-M0M0-	50 Ω MaxiFlex [Ⓢ] No QPL List .250 Tin Plate Braid 25F-M0M0-	
.250" Diameter SEMIRIGID Direct Solder Connectors						
24	-0240	\$144.24	\$146.12	\$154.62	\$144.24	
36	-0360	\$147.26	\$150.08	\$162.83	\$147.26	
48	-0480	\$150.28	\$154.04	\$171.04	\$150.28	
60	-0600	\$153.30	\$158.00	\$179.25	\$153.30	
72	-0720	\$156.32	\$161.96	\$187.46	\$156.32	
SEMIRIGID Direct Solder Connectors						
LTH IN INS	DASH NUM	50 Ω RG 402 [Ⓢ] M17/130-00004 .141 Cu Jacket 402-M0M0-	50 Ω RG 402 [Ⓢ] M17/130-00005 .141 Tin Plate Cu 1TS-M0M0-	50 Ω RG 402 [Ⓞ] M17/130-00009 .141 Tin Plate Al 1AT-M0M0-	50 Ω TeeFlex [Ⓞ] No QPL List .141 Tin Pl Braid 14T-M0M0-	50 Ω RG 402 [Ⓢ] M17/130-00012 .141 Silver Pl 1SS-M0M0-
12	-0120	\$25.68	\$25.68	\$25.68	\$19.67	\$34.89
24	-0240	\$29.28	\$29.28	\$29.28	\$23.48	\$47.70
36	-0360	\$32.88	\$32.88	\$32.88	\$27.29	\$60.51
48	-0480	\$36.48	\$36.48	\$36.48	\$31.10	\$73.32
60	-0600	\$40.08	\$40.08	\$40.08	\$34.91	\$86.13
72	-0720	\$43.68	\$43.68	\$43.68	\$38.72	\$98.94
SEMIRIGID and MaxiFlex Direct Solder Connectors						
LTH IN INS	DASH NUM	50 Ω RG 405 [Ⓢ] M17/133-00006 .085 Cu Jacket 405-M0M0-	50 Ω RG 405 [Ⓢ] M17/133-00007 .085 Tin Plate Cu 8TS-M0M0-	50 Ω RG 405 [Ⓢ] M17/133-00013 .085 Tin Plate Al 8AT-M0M0-	50 Ω Tee-Flex [Ⓢ] No QPL List .085 Helix Braid 08T-M0M0-	50 Ω RG 405 [Ⓢ] M17/133-00016 .085 Silver Pl 8SS-M0M0-
12	-0120	\$25.10	\$25.10	\$26.04	\$24.21	\$30.29
24	-0240	\$28.12	\$28.12	\$30.00	\$26.34	\$38.50
36	-0360	\$31.14	\$31.14	\$33.96	\$28.47	\$46.71
48	-0480	\$34.16	\$34.16	\$37.92	\$30.60	\$54.92
60	-0600	\$37.18	\$37.18	\$41.88	\$32.73	\$63.13
72	-0720	\$40.20	\$40.20	CALL	\$34.86	CALL
.047" Diameter SEMIRIGID Direct Solder Connectors						
LTH IN INS	DASH NUM	50 Ω [Ⓢ] M17/151-00001 .047 Cu Jacket 4CU-M0M0-	50 Ω [Ⓢ] No QPL List .047 Tin Plate Al 4AT-M0M0-	50 Ω [Ⓢ] M17/151-00002 .047 Tin Plate Cu 4TS-M0M0-	50 Ω MaxiFlex [Ⓢ] No QPL List .047 Tin Pl Braid 04F-M0M0-	50 Ω ^{Ⓢ1} M17/154-00002 .034 Tin Plate Cu 3TS-M0M0-
12	-0120	\$27.36	\$28.81	\$27.36	\$28.06	\$55.97
36	-0360	\$34.96	\$39.31	\$34.96	\$37.06	\$72.19
60	-0600	\$42.56	\$49.81	\$42.56	\$46.06	\$88.41

[Ⓞ]Silver Plated Copper Center Conductor [Ⓢ]Silver Plated Copper Clad Steel Center Conductor

10% Discount @ 25 pcs. up 4% Discount @ 10 pcs. up

¹ Gold Plated Copper Beryllium Connector



Phone 856-488-2000 Fax 856-488-2020

SMA Male Plug x SMA Male Plug Jacketed Maxi-Flex SMA Male Plug x SMA Male Plug MaxiFlex

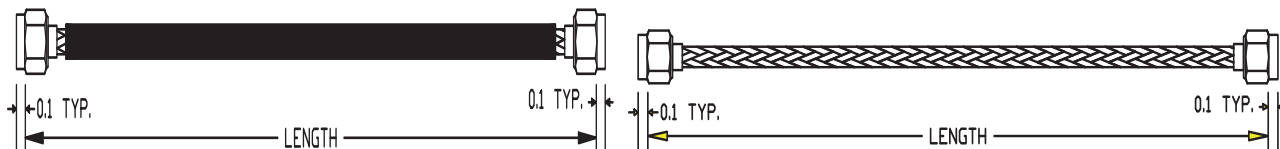

LENGTH IN INCHES	DASH NUMBER	50 Ω MaxiFlex No QPL List .141 Tin Pl 08J-M0M0-	50 Ω MaxiFlex No QPL List .141 Tin Pl 14J-M0M0-	50 Ω MaxiFlex [Ⓢ] No QPL List .250 Tin Plate 25X-M0M0-	50 Ω MaxiFlex No QPL List .141 Tin Pl 08F-M0M0-	50 Ω MaxiFlex No QPL List .141 Tin Pl 14F-M0M0-	50 Ω MaxiFlex No QPL List .141 Tin Pl 04F-M0M0-
Direct Solder Connectors							
2	-0020	\$22.71	\$22.73	\$138.87	\$22.79	\$22.62	\$22.83
4	-0040	\$23.35	\$23.38	\$139.54	\$23.50	\$23.16	\$23.58
6	-0060	\$23.99	\$24.03	\$140.21	\$24.21	\$23.70	\$24.33
8	-0080	\$24.59	\$24.65	\$140.88	\$24.89	\$24.22	\$25.05
10	-0100	\$25.25	\$25.33	\$141.55	\$25.62	\$24.78	\$25.83
12	-0120	\$25.89	\$25.98	\$142.22	\$26.33	\$25.32	\$26.58
18	-0180	\$27.80	\$27.93	\$144.23	\$28.46	\$26.94	\$28.83
24	-0240	\$29.70	\$29.88	\$146.24	\$30.58	\$28.56	\$31.08
30	-0300	\$31.61	\$31.83	\$148.25	\$32.71	\$30.18	\$33.33
36	-0360	\$33.51	\$33.78	\$150.26	\$34.83	\$31.80	\$35.58
48	-0480	\$37.32	\$37.68	\$154.28	\$39.08	\$35.04	\$40.08
54	-0540	\$39.23	\$39.63	CALL	\$41.21	\$36.66	\$42.33
60	-0600	\$41.13	\$41.58	CALL	\$43.33	\$38.28	\$44.58
72	-0720	\$44.94	\$45.48	CALL	\$47.58	\$41.52	\$49.08
84	-0840	\$48.75	\$49.38	CALL	\$51.83	\$44.76	\$53.58
96	-0960	\$52.56	\$53.28	CALL	\$56.08	\$48.00	\$58.08
108	-1080	\$56.37	\$57.18	CALL	\$60.33	\$51.24	\$62.58
120	-1200	\$60.18	\$61.08	CALL	\$64.58	\$54.48	\$67.08
132	-1320	\$63.99	\$64.98	CALL	\$68.83	\$57.72	\$71.58
144	-1440	\$67.80	\$68.88	CALL	\$73.08	\$60.96	\$76.08
156	-1560	\$71.61	\$72.78	CALL	\$77.33	\$64.20	\$80.58
168	-1680	\$75.42	\$76.68	CALL	\$81.58	\$67.44	\$85.08
180	-1800	\$79.23	\$80.58	CALL	\$85.83	\$70.68	\$89.58
196	-1960	\$84.30	\$85.77	CALL	\$91.48	\$74.99	\$95.57

Ⓢ Silver Plated Copper Center Conductor Ⓢ Silver Plated Copper Clad Steel Center Conductor

10% Discount @ 25 pcs. up 4% Discount @ 10 pcs. up



7850 Browning Rd. Pennsauken, NJ 08109

Online @ www.rfdepot.com

Phone 856-488-2000 Fax 856-488-2020

Toll Free 877-RF Depot

B143

SMA Male Plug x SMA Male Plug Commercial

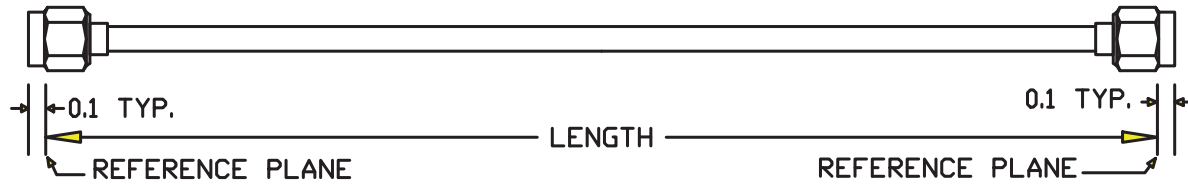

LENGTH IN INCHES	DASH NUMBER	50 Ω RG 401① M17/129-RG401 .250 Cu Jacket 401-M0M0-	50 Ω RG 401① No QPL List .250 Tin Plate Al 25A-M0M0-	50 Ω RG 401② M17/129-00001 .250 Tin Plate Cu 2TS-M0M0-	50 Ω MaxiFlex② No QPL List .250 Tin Plate Braid 25F-M0M0-		
SEMIRIGID Direct Solder Connectors							
24	-0240C	\$144.24	\$146.12	\$154.62	\$144.24		
36	-0360C	\$147.26	\$150.08	\$162.83	\$147.26		
48	-0480C	\$150.28	\$154.04	\$171.04	\$150.28		
60	-0600C	\$153.30	\$158.00	\$179.25	\$153.30		
72	-0720C	\$156.32	\$161.96	\$187.46	\$156.32		
SEMIRIGID and MaxiFlex Direct Solder Connectors							
LTH IN INS	DASH NUM	50 Ω RG 402② M17/130-00004 .141 Cu Jacket 402-M0M0-	50 Ω RG 402① M17/130-00009 .141 Tin Plate Al 1AT-M0M0-	50 Ω RG 402② M17/130-00012 .141 Silver Pl 1SS-M0M0-	50 Ω RG 402② M17/130-00005 .141 Tin Plate Cu 1TS-M0M0-	50 Ω TeeFlex① No QPL List .141 Tin Pl 14T-M0M0-	
12	-0120C	\$25.68	\$25.68	\$34.89	\$25.32	\$19.46	
24	-0240C	\$29.28	\$29.28	\$47.70	\$28.56	\$23.06	
36	-0360C	\$32.88	\$32.88	\$60.51	\$31.80	\$26.66	
48	-0480C	\$36.48	\$36.48	\$73.32	\$35.04	\$30.26	
60	-0600C	\$40.08	\$40.08	\$86.13	\$38.28	\$33.86	
72	-0720C	\$43.68	\$43.68	\$98.94	\$41.52	\$37.46	
SEMIRIGID and MaxiFlex Direct Solder Connectors							
LTH IN INS	DASH NUM	50 Ω RG 405② M17/133-00006 .86 Cu Jacket 405-M0M0-	50 Ω RG 405② M17/133-00013 .86 Tin Plate Al 8AT-M0M0-	50 Ω RG 405② M17/133-00007 .085 Tin Pl Cu 8TS-M0M0-	50 Ω TeeFlex② No QPL List .085 Helix Braid 08T-M0M0-	50 Ω① Non-Magnetic .085 Tin Plate Cu 8CT-M0M0-	50 Ω MaxiFlex Non-Magnetic .085 Tin Pl 08C-M0M0-
12	-0120C	\$25.10	\$26.04	\$25.10	\$24.21	\$22.98	\$25.05
24	-0240C	\$28.12	\$30.00	\$28.12	\$26.34	\$25.16	\$29.30
36	-0360C	\$31.14	\$33.96	\$31.14	\$28.47	\$27.34	\$33.55
48	-0480C	\$34.16	\$37.92	\$34.16	\$30.60	\$29.52	\$37.80
60	-0600C	\$37.18	\$41.88	\$37.18	\$32.73	\$31.70	\$42.05
72	-0720C	\$40.20	CALL	\$40.20	\$34.86	\$33.88	\$46.30
SEMIRIGID and MaxiFlex Direct Solder Connectors							
LENGTH IN INCHES	DASH NUMBER	50 Ω ② M17/151-00001 .047 Cu Jacket 4CU-M0M0-	50 Ω ② No QPL List .047 Tin Plate Al 4AT-M0M0-	50 Ω ② M17/151-00002 .047 Tin Plate Cu 4TS-M0M0-	50 Ω MaxiFlex② No QPL List .047 Tin Plate Braid 04F-M0M0-		
12	-0120C	\$24.60	\$26.05	\$24.60	\$25.30		
36	-0360C	\$32.20	\$36.55	\$32.20	\$34.30		
60	-0600C	\$39.80	\$47.05	\$39.80	\$43.30		

10% Discount @ 25 pcs. up 4% Discount @ 10 pcs. up

① Silver Plated Copper Center Conductor ② Silver Plated Copper Clad Steel Center Conductor



RF Depot.com Inc.

Phone 856-488-2000 Fax 856-488-2020

SMA Male Plug x SMA Reverse Polarity Bulkhead Jack



LENGTH IN INCHES	DASH NUMBER	50 Ω RG 58C ③⑥ 1 shield⑦ 058-MAMW-	50 Ω RG 223③① 2 shields⑦ 223-MAMW-	50 Ω RG 142 ④② 2 shields⑦ 142-MAMA-	50 Ω RG 178 ② 1 shield⑩ 178-MAMW-	50 Ω RG 196② 1 shield⑩ 196-MAMW-	
Solder Center, Crimp Outer with Strain Relief							
12	-0120	\$25.58	\$27.94	\$28.77	\$31.00	\$31.00	
24	-0240	\$25.98	\$29.41	\$31.07	\$31.74	\$31.74	
36	-0360	\$26.38	\$30.88	\$33.37	\$32.48	\$32.48	
48	-0480	\$26.78	\$32.35	\$35.67	\$33.22	\$33.22	
60	-0600	\$27.18	\$33.82	\$37.97	\$33.96	\$33.96	
72	-0720	\$27.58	\$35.29	\$40.27	\$34.70	\$34.70	
Solder Center, Crimp Outer with Strain Relief							
LENGTH IN INCHES	DASH NUMBER	50 Ω RG 174 ③⑤ 1 shield⑦ 174-MAMW-	50 Ω RG188* ④② 1 shield⑩ 188-MAMW-	50 Ω RD 188* ④②⑦ 2 shields 88D-MAMW-	50 Ω RG 316 ④② 1 shield⑩ 316-MAMW-	50 Ω④ RD 316 ②⑦ 2 shields 31D-MAMW-	
12	-0120	\$26.27	\$23.19	\$27.94	\$23.60	\$27.65	
24	-0240	\$26.51	\$23.43	\$29.41	\$24.25	\$29.50	
36	-0360	\$26.75	\$23.67	\$30.88	\$24.90	\$31.35	
48	-0480	\$26.99	\$23.91	\$32.35	\$25.55	\$33.20	
60	-0600	\$27.23	\$24.15	\$33.82	\$26.20	\$35.05	
72	-0720	\$27.47	\$24.39	\$35.29	\$26.85	\$36.90	
Solder Center, Crimp Outer with Strain Relief							
LTH IN INS	DASH NUM	50 Ω RG 402② M17/130-00004 .141 Cu Jacket 402-MAMW-	50 Ω RG 402① M17/130-00009 .141 Tin Plate Al 1AT-MAMW-	50 Ω RG 405② M17/133-00006 .86 Cu Jacket 405-MAMW-	50 Ω RG 405② M17/133-00013 .86 Tin Plate Al 8AT-MAMW-	50 Ω RG 405② M17/133-00007 .085 Tin Plate Cu 8TS-MAMW-	
12	-0120	\$29.46	\$29.46	\$28.88	\$29.82	\$28.88	
24	-0240	\$33.06	\$33.06	\$31.90	\$33.78	\$31.90	
36	-0360	\$36.66	\$36.66	\$34.92	\$37.74	\$34.92	
48	-0480	\$40.26	\$40.26	\$37.94	\$41.70	\$37.94	
60	-0600	\$43.86	\$43.86	\$40.96	\$45.66	\$40.96	
72	-0720	\$47.46	\$47.46	\$43.98	CALL	\$43.98	
Color Designators (add letter to the end of the part number and add \$1.00 to price)							
Black - B		Blue - L		Brown - N		Gray - A	
Orange - O		Red - R		Violet - V		Yellow - Y	
						Green - G	
						White - W	

See Page B5 for Cable Characteristics

* Contact Factory for delivery, Consider new RD316 for (RD188)

10% Discount @ 25 pcs. up

4% Discount @ 10 pcs. up

SMA Male Plug x SMA Reverse Polarity Plug

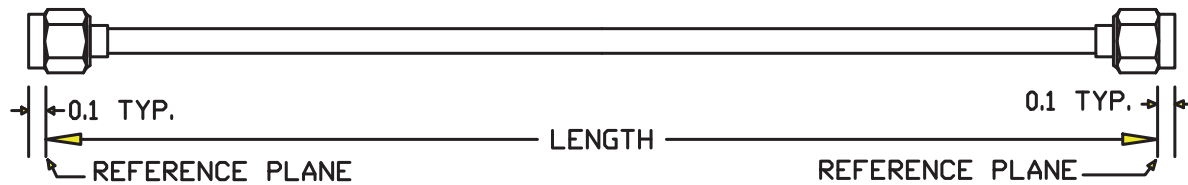

LENGTH IN INCHES	DASH NUM	50 Ω RG 58C ③⑥ 1 shield⑦ 058-MAMM-	50 Ω RG 142④② 2 shields⑦ 142-MAMM-	50 Ω RG 174 ③⑤ 1 shield⑦ 174-MAMM-	50 Ω RG188* ④② 1 shield⑧ 188-MAMM-	50 Ω⑨ RG 223 ① 2 shields⑦ 223-MAMM-	50 Ω RG 316 ④② 1 shield⑧ 316-MAMM-	50 Ω④ RD 316 ②⑦ 2 shields 31D-MAMM-
SMA Connectors Are Plated Brass								
Solder Center, Crimp Outer with Strain Relief								
12	-0120C	\$25.08	\$32.12	\$23.40	\$27.01	\$31.29	\$26.66	\$26.31
24	-0240C	\$25.48	\$34.42	\$23.64	\$28.01	\$32.76	\$27.31	\$28.16
36	-0360C	\$25.88	\$36.72	\$23.88	\$29.01	\$34.23	\$27.96	\$30.01
48	-0480C	\$26.28	\$39.02	\$24.12	\$30.01	\$35.70	\$28.61	\$31.86
60	-0600C	\$26.68	\$41.32	\$24.36	\$31.01	\$37.17	\$29.26	\$33.71
72	-0720C	\$27.08	\$43.62	\$24.60	\$32.01	\$38.64	\$29.91	\$35.56
Solder Center, Crimp Outer with Strain Relief								
LENGTH IN INCHES	DASH NUMBER	50 Ω RG 178 ② 1 shield⑧ 178-MAMM-	50 Ω SIG 100①⑤ 2 shields⑨ 1LC-MAMM-	50 Ω LMR100 ①⑤ 2 shields⑨ 1LM-MAMM-	50 Ω SIG195 ①③ 2 shields⑨ 19C-MAMM-	50 Ω LMR195①③ 2 shields⑨ 19M-MAMM-		
12	-0120C	\$29.88	\$25.08	\$25.20	\$21.83	\$21.97		
24	-0240C	\$30.62	\$25.62	\$25.86	\$22.40	\$22.68		
36	-0360C	\$31.36	\$26.16	\$26.52	\$22.97	\$23.39		
48	-0480C	\$32.10	\$26.70	\$27.18	\$23.54	\$24.10		
60	-0600C	\$32.84	\$27.24	\$27.84	\$24.11	\$24.81		
72	-0720C	\$33.58	\$27.78	\$28.50	\$24.68	\$25.52		
Solder Center, Crimp Outer with Strain Relief								
LENGTH IN INCHES	DASH NUM	50 Ω SIG 200①③ 2 shields⑨ 2LC-MAMM-	50 Ω LMR 200①③ 2 shields⑨ 2LM-MAMM-	50 Ω SIG 240①③ 2 shields⑨ 24C-MAMM-	50 Ω③ LMR 240① 2 shields⑨ 24L-MAMM-	50 Ω SIG 400①④ 2 shields⑨ 4LC-MAMM-	50 Ω LMR 400①④ 2 shields⑨ 4LM-MAMM-	
12	-0120C	\$22.05	\$22.10	\$27.55	\$27.97	\$28.65	\$29.17	
24	-0240C	\$22.73	\$22.83	\$28.15	\$28.99	\$29.51	\$30.55	
36	-0360C	\$23.41	\$23.56	\$28.75	\$30.01	\$30.37	\$31.93	
48	-0480C	\$24.09	\$24.29	\$29.35	\$31.03	\$31.23	\$33.31	
60	-0600C	\$24.77	\$25.02	\$29.95	\$32.05	\$32.09	\$34.69	
72	-0720C	\$25.45	\$25.75	\$30.55	\$33.07	\$32.95	\$36.07	
Color Designators (add letter to the end of the part number and add \$1.00 to price)								
Black - B		Blue - L		Brown - N		Gray - A		Green - G
Orange - O		Red - R		Violet - V		Yellow - Y		White - W

See Page B5 for Cable Characteristics

* Contact Factory for delivery, Consider new RD316 for (RD188) 10% Discount @ 25 pcs. up 4% Discount @ 10 pcs. up



RF Depot.com Inc.

Phone 856-488-2000 Fax 856-488-2020

SMA Male Plug x SMA Reverse Thread Plug

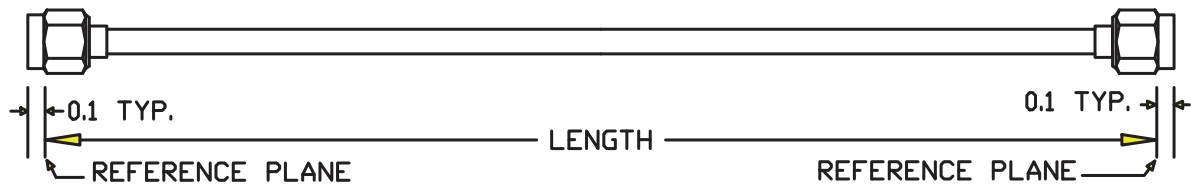

LENGTH IN INCHES	DASH NUMBER	50 Ω RG 58C ③⑥ 1 shield⑦ 058-MAMRA-	50 Ω RG 142 ④② 2 shields⑦ 142-MAMRA-	50 Ω RG 174 ③⑤ 1 shield⑦ 174-MAMRA-	50 Ω RG 223 ③① 2 shields⑦ 223-MAMRA-		
Solder Center, Crimp Outer, Low Loss Flexible							
12	-0120C	\$24.14	\$26.63	\$22.10	\$27.70		
24	-0240C	\$24.54	\$27.03	\$22.50	\$29.17		
36	-0360C	\$24.94	\$27.43	\$22.90	\$30.64		
48	-0480C	\$25.34	\$27.83	\$23.30	\$32.11		
60	-0600C	\$25.74	\$28.23	\$23.70	\$33.58		
72	-0720C	\$26.14	\$28.63	\$24.10	\$35.05		
Solder Center, Crimp Outer, Low Loss Flexible							
LENGTH IN INCHES	DASH NUMBER	50 Ω RG 316 ④② 1 shield⑩ 316-MAMRA-	50 Ω RD 316 ④②⑦ 2 shields 31D-MAMRA-	50 Ω RG188* ④② 1 shield⑩ 188-MAMRA-	50 Ω RG 178 ② 1 shield⑩ 178-MAMRA-		
12	-0120C	\$22.35	\$23.55	\$21.94	\$30.99		
24	-0240C	\$23.00	\$25.40	\$22.18	\$31.73		
36	-0360C	\$23.65	\$27.25	\$22.42	\$32.47		
48	-0480C	\$24.30	\$29.10	\$22.66	\$33.21		
60	-0600C	\$24.95	\$30.95	\$22.90	\$33.95		
72	-0720C	\$25.60	\$32.80	\$23.14	\$34.69		
Solder Center, Crimp Outer, Low Loss Flexible							
LTH IN INS	DASH NUM	50 Ω SIG 100①⑤ 2 shields⑨ 1LC-MAMRA-	50 Ω LMR100 ①⑤ 2 shields⑨ 1LM-MAMRA-	50 Ω SIG195 ①③ 2 shields⑨ 19C-MAMRA-	50 Ω LMR195①③ 2 shields⑨ 19M-MAMRA-	50 Ω SIG240 ①③ 2 shields⑨ 24C-MAMRA-	50 Ω LMR240①③ 2 shields⑨ 24L-MAMRA-
12	-0120C	\$20.77	\$20.89	\$20.89	\$21.03	\$26.56	\$26.98
24	-0240C	\$21.31	\$21.55	\$21.46	\$21.74	\$27.16	\$28.00
36	-0360C	\$21.85	\$22.21	\$22.03	\$22.45	\$27.76	\$29.02
48	-0480C	\$22.39	\$22.87	\$22.60	\$23.16	\$28.36	\$30.04
60	-0600C	\$22.93	\$23.53	\$23.17	\$23.87	\$28.96	\$31.06
72	-0720C	\$23.47	\$24.19	\$23.74	\$24.58	\$29.56	\$32.08
Color Designators (add letter to the end of the part number and add \$1.00 to price)							
Black - B		Blue - L		Brown - N		Gray - A	
Orange - O		Red - R		Violet - V		Green - G	
						White - W	

See Page B5 for Cable Characteristics

* Contact Factory for delivery, Consider new RD316 for (RD188)

10% Discount @ 25 pcs. up

4% Discount @ 10 pcs. up

SMA Male Plug X SMA Right Angle Male Plug

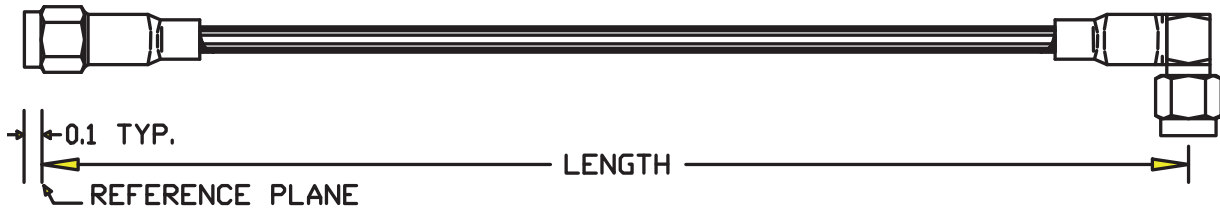

LTH IN INS	DASH NUM	50 Ω RG 58C [Ⓢ] [Ⓢ] 1 shield [Ⓢ] 058-MAMC-	50 Ω RG 223 [Ⓢ] [Ⓢ] [Ⓢ] 2 shields [Ⓢ] 223-MAMC-	50 Ω RG 142B [Ⓢ] [Ⓢ] [Ⓢ] 2 shields [Ⓢ] 142-MAMC-	50 Ω RG 178 [Ⓢ] 1 shield [Ⓢ] 178-MAMC-	50 Ω RG 400 [Ⓢ] [Ⓢ] [Ⓢ] [Ⓢ] 2 shields [Ⓢ] 400-MAMC-	75 Ω RG 59B [Ⓢ] [Ⓢ] [Ⓢ] [‡] 1 shield [Ⓢ] 059-MAMC-	93 Ω RG 62 [Ⓢ] [Ⓢ] [‡] 1 shield [Ⓢ] 062-MAMC-
Solder Center, Crimp Outer with Strain Relief								
12	-0120	\$33.32	\$32.41	\$32.41	\$53.23	\$32.41	\$106.80	\$106.80
24	-0240	\$33.52	\$33.47	\$33.71	\$53.60	\$34.66	\$107.11	\$107.32
36	-0360	\$33.72	\$34.53	\$35.01	\$53.97	\$36.91	\$107.11	\$107.32
48	-0480	\$33.92	\$35.59	\$36.31	\$54.34	\$39.16	\$107.42	\$107.84
60	-0600	\$34.32	\$37.71	\$38.91	\$55.08	\$43.66	\$107.73	\$108.36
72	-0720	\$34.52	\$38.77	\$40.21	\$55.45	\$45.91	\$108.04	\$108.88
Solder Center, Crimp and Clamp Outer								
LENGTH IN INCHES	DASH NUMBER	50 Ω RG 174 [Ⓢ] [Ⓢ] 1 shield [Ⓢ] 174-MAMC-	50 Ω RG 316 [Ⓢ] [Ⓢ] [Ⓢ] 1 shield [Ⓢ] 316-MAMC-	50 Ω RD 316 [Ⓢ] [Ⓢ] [Ⓢ] 2 shields [Ⓢ] 31D-MAMC-	50 Ω RG188* [Ⓢ] [Ⓢ] [Ⓢ] 1 shield [Ⓢ] 188-MAMC-	50 Ω RG 196 [Ⓢ] 1 shield [Ⓢ] 196-MAMC-	50 Ω RG 179 [Ⓢ] [Ⓢ] 1 shield [Ⓢ] 179-MAMC-	
12	-0120	\$30.99	\$30.99	\$30.99	\$30.99	\$53.23	\$30.99	
24	-0240	\$31.11	\$31.31	\$31.96	\$31.49	\$53.60	\$31.36	
36	-0360	\$31.23	\$31.63	\$32.93	\$31.99	\$53.97	\$31.73	
48	-0480	\$31.35	\$31.95	\$33.90	\$32.49	\$54.34	\$32.10	
60	-0600	\$31.47	\$32.27	\$34.87	\$32.99	\$54.71	\$32.47	
72	-0720	\$31.59	\$32.59	\$35.84	\$33.49	\$55.08	\$32.84	
Solder Center, Crimp and Clamp Outer								
LENGTH IN INCHES	DASH NUMBER	50 Ω SIG 100 [Ⓢ] [Ⓢ] 2 shields [Ⓢ] 1LC-MAMC-	50 Ω LMR100 [Ⓢ] [Ⓢ] 2 shields [Ⓢ] 1LM-MAMC-	50 Ω SIG195 [Ⓢ] 2 shields [Ⓢ] 19C-MAMC-	50 Ω LMR195 [Ⓢ] [Ⓢ] 2 shields [Ⓢ] 19M-MAMC-	50 Ω SIG240 [Ⓢ] 2 shields [Ⓢ] 24C-MAMC-	50 Ω LMR240 [Ⓢ] [Ⓢ] 2 shields [Ⓢ] 24L-MAMC-	
12	-0120C	\$22.88	\$23.05	\$24.12	\$24.26	\$29.16	\$29.58	
24	-0240C	\$23.42	\$23.76	\$24.69	\$24.97	\$29.76	\$30.60	
36	-0360C	\$23.96	\$24.47	\$25.26	\$25.68	\$30.36	\$31.62	
48	-0480C	\$24.50	\$25.18	\$25.83	\$26.39	\$30.96	\$32.64	
60	-0600C	\$25.04	\$25.89	\$26.40	\$27.10	\$31.56	\$33.66	
72	-0720C	\$25.58	\$26.60	\$26.97	\$27.81	\$32.16	\$34.68	
Color Designators (add letter to the end of the part number and add \$1.00 to price)								
Black - B		Blue - L		Brown - N		Gray - A		Green - G
Orange - O		Red - R		Violet - V		Yellow - Y		White - W

See Page B5 for Cable Characteristics

* Contact Factory for delivery, Consider new RD316 for (RD188) 10% Discount @ 25 pcs. up 4% Discount @ 10 pcs. up

‡ Brass Body Stainless Steel Nut



RF Depot.com Inc.

Phone 856-488-2000 Fax 856-488-2020

B148

7850 Browning Rd. Pennsauken, NJ 08109

Online @ www.rfdepot.com

Toll Free 877-RF Depot

SMA Male Plug x SMA Right Angle Male Plug

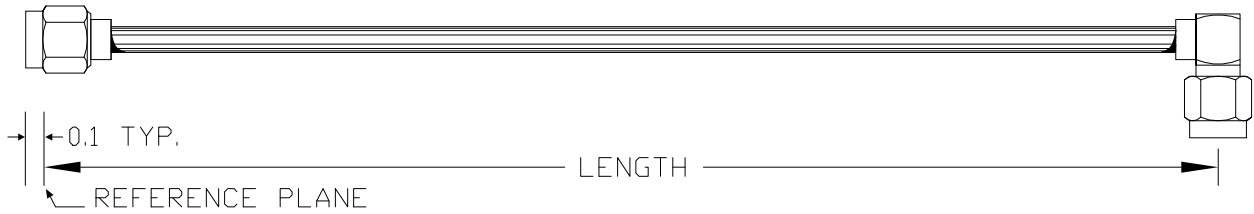

LTH IN INS	DASH NUM	50Ω RG 402 [Ⓞ] M17/130-00004 .141 Cu Jacket 402-MOM2-	50Ω RG 402 [Ⓞ] M17/130-00004 .141 Tin Plate Al 1AT-MOM2-	50Ω RG 402 [Ⓞ] M17/130-00012 .141 Silver Plate Cu 1SS-MOM2-	50Ω RG 402 [Ⓞ] M17/130-00012 .141 Tin Plate Cu 1TS-MOM2-	50 MaxiFlex No QPL List .86 Tin Pl 14F-MOM2-
SEMIRIGID Direct Solder Connectors						
12	-0120	\$31.47	\$31.47	\$40.68	\$31.11	\$31.11
24	-0240	\$38.67	\$38.67	\$66.30	\$37.59	\$37.59
36	-0360	\$44.07	\$44.07	\$85.52	\$42.45	\$42.45
48	-0480	\$47.67	\$47.67	\$98.33	\$45.69	\$45.69
60	-0600	\$51.27	\$51.27	\$111.14	\$48.93	\$48.93
72	-0720	\$54.87	CALL	CALL	\$52.17	\$52.17
SEMIRIGID and MaxiFlex Direct Solder Connectors						
LTH IN INS	DASH NUM	50Ω RG 405 [Ⓞ] M17/133-00006 .085 Cu Jacket 405-MOM2-	50Ω RG 405 [Ⓞ] M17/133-00013 .085 Tin Plate Al 8AT-MOM2-	50Ω RG 405 [Ⓞ] M17/133-00007 .085 Tin Plate Cu 8TS-MOM2-	50Ω RG 405 [Ⓞ] No QPL List .085 Tin Pl 08F-MOM2-	50Ω RG 405 [Ⓞ] M17/133-00016 .085 Silver Pl 8SS-MOM2-
12	-0120	\$30.14	\$31.08	\$30.14	\$31.37	\$35.33
24	-0240	\$36.18	\$39.00	\$36.18	\$39.87	\$51.75
36	-0360	\$40.71	\$44.94	\$40.71	\$46.25	\$64.07
48	-0480	\$43.73	\$48.90	\$43.73	\$50.50	\$72.28
60	-0600	\$46.75	\$52.86	\$46.75	\$54.75	\$80.49
72	-0720	\$49.77	CALL	\$49.77	\$59.00	CALL
SEMIRIGID and MaxiFlex Direct Solder Connectors						
LTH IN INS	DASH NUM	50Ω RG 405 [Ⓞ] No QPL List .085 Tin Pl 08J-MOM0-	50Ω [Ⓞ] M17/151-00001 .047 Cu Jacket 4CU-MOM2-	50Ω [Ⓞ] No QPL List .047 Tin Plate Al 4AT-MOM2-	50Ω [Ⓞ] M17/151-00002 .047 Tin Plate Cu 4TS-MOM2-	50Ω MaxiFlex [Ⓞ] No QPL List .047 Tin Pl 04F-MOM2-
12	-0120	\$30.93	\$52.48	\$53.93	\$52.48	\$53.18
24	-0240	\$38.55	\$56.28	\$59.18	\$56.28	\$57.68
36	-0360	\$44.27	\$60.08	\$64.43	\$60.08	\$62.18
48	-0480	\$48.08	\$63.88	\$69.68	\$63.88	\$66.68
60	-0600	\$51.89	\$67.68	\$74.93	\$67.68	\$71.18
72	-0720	\$55.70	\$71.48	\$80.18	\$71.48	\$75.68

ⓄSilver Plated Copper Center Conductor ⓄSilver Plated Copper Clad Steel Center Conductor

10% Discount @ 25 pcs. up 4% Discount @ 10 pcs. up



SMA Male Plug x SMA Right Angle Male Plug Commercial

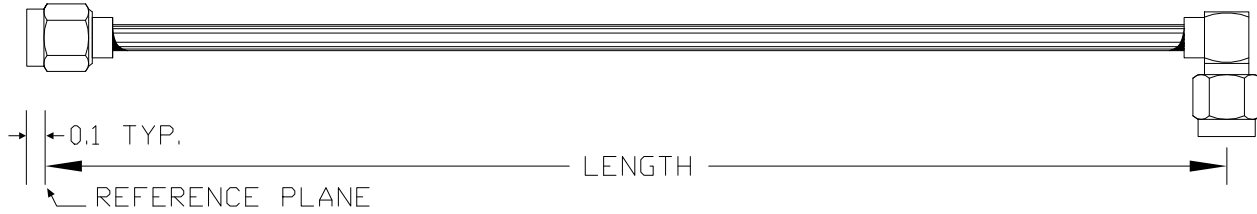

LENGTH IN INCHES	DASH NUMBER	50Ω RG 402 [Ⓢ] M17/130-00004 .141 Cu Jacket 402-M0M2-	50Ω RG 402 [Ⓣ] M17/130-00009 .141 Tin Plate Al 1AT-M0M2-	50Ω RG 402 [Ⓢ] M17/130-00012 .141 Silver Pl 1SS-M0M2-	50Ω RG 402 [Ⓢ] M17/130-00005 .141 Tin Plate Cu 1TS-M0M2-	50Ω MaxiFlex No QPL List .141 Tin Pl 14F-M0M2-	
SEMIRIGID Direct Solder Connectors							
12	-0120C	\$24.02	\$24.02	\$33.23	\$23.66	\$23.66	
24	-0240C	\$27.62	\$27.62	\$46.04	\$26.90	\$26.90	
36	-0360C	\$31.22	\$31.22	\$58.85	\$30.14	\$30.14	
48	-0480C	\$34.82	\$34.82	\$71.66	\$33.38	\$33.38	
60	-0600C	\$38.42	\$38.42	\$84.47	\$36.62	\$36.62	
72	-0720C	\$42.02	\$42.02	\$97.28	\$39.86	\$39.86	
SEMIRIGID and MaxiFlex Direct Solder Connectors							
LENGTH IN INCHES	DASH NUMBER	50Ω RG 405 [Ⓢ] M17/133-00006 .085 Cu Jacket 405-M0M2-	50Ω RG 405 [Ⓣ] M17/133-00013 .085 Tin Plate Al 8AT-M0M2-	50Ω RG 405 [Ⓢ] M17/133-00007 .085 Tin Plate Cu 8TS-M0M2-	50Ω MaxiFlex No QPL List .085 Tin Pl 08F-M0M2-	50Ω RG 405 [Ⓢ] M17/133-00016 .085 Silver Pl 8SS-M0M2-	
12	-0120C	\$24.69	\$25.63	\$24.69	\$25.92	\$29.88	
24	-0240C	\$27.71	\$29.59	\$27.71	\$30.17	\$38.09	
36	-0360C	\$30.73	\$33.55	\$30.73	\$34.42	\$46.30	
48	-0480C	\$33.75	\$37.51	\$33.75	\$38.67	\$54.51	
60	-0600C	\$36.77	\$41.47	\$36.77	\$42.92	\$62.72	
72	-0720C	\$39.79	CALL	\$39.79	\$47.17	CALL	
SEMIRIGID and MaxiFlex Direct Solder Connectors							
LTH IN INS	DASH NUM	50Ω [Ⓢ] M17/151-00001 .047 Cu Jacket 4CU-M0M2-	50Ω [Ⓣ] No QPL List .047 Tin Pl Al 4AT-M0M2-	50Ω [Ⓢ] M17/151-00002 .047 Tin Pl Cu 4TS-M0M2-	50Ω MaxiFlex [Ⓢ] No QPL List .047 Tin Pl 04F-M0M2-	50Ω [Ⓣ] Non-Magnetic .085 Tin Pl Cu 8CT-M0M2-	50Ω MaxiFlex Non-Magnetic .085 Tin Pl 08C-M0M2-
12	-0120C	\$28.57	\$30.02	\$28.57	\$29.27	\$23.85	\$25.92
24	-0240C	\$32.37	\$35.27	\$32.37	\$33.77	\$26.03	\$30.17
36	-0360C	\$36.17	\$40.52	\$36.17	\$38.27	\$28.21	\$34.42
48	-0480C	\$39.97	\$45.77	\$39.97	\$42.77	\$30.39	\$38.67
60	-0600C	\$43.77	\$51.02	\$43.77	\$47.27	\$32.57	\$42.92
72	-0720C	\$47.57	\$56.27	\$47.57	\$51.77	\$34.75	\$47.17

Ⓢ Silver Plated Copper Center Conductor Ⓣ Silver Plated Copper Clad Steel Center Conductor

10% Discount @ 25 pcs. up 4% Discount @ 10 pcs. up



RF Depot.com Inc.

Phone 856-488-2000 Fax 856-488-2020

B150

7850 Browning Rd. Pennsauken, NJ 08109

Online @ www.rfdepot.com

Toll Free 877-RF Depot

SMA Male Plug x SMB Female Plug

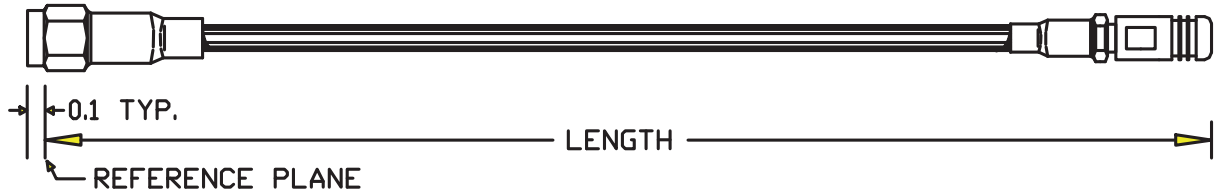

LTH IN INS	DASH NUM	50 Ω RG 58C ③⑥ 1 shield⑦ 058-MAMBA-	50 Ω RG 142B ④② 2 shields⑦ 142-MAMBA-	50 Ω RG 196 ② 1 shield⑩ 196-MAMBA-	50 Ω RG 223 ③① 2 shields⑦ 223-MAMBA-	50 Ω RG 179 ④② 1 shield⑩ 179-MAMBA-	50 Ω RG 400*④① 2 shields⑦ 400-MAMBA-
Solder Center, Crimp Outer with Strain Relief							
12	-0120	\$25.61	\$29.46	\$32.54	\$28.63	\$25.63	\$30.16
18	-0180	\$25.81	\$30.61	\$32.91	\$29.37	\$26.00	\$31.66
24	-0240	\$26.01	\$31.76	\$33.28	\$30.10	\$26.36	\$33.16
30	-0300	\$26.21	\$32.91	\$33.65	\$30.84	\$26.73	\$34.66
36	-0360	\$26.41	\$34.06	\$34.02	\$31.57	\$27.09	\$36.16
42	-0420	\$26.61	\$35.21	\$34.39	\$32.31	\$27.46	\$37.66
48	-0480	\$26.81	\$36.36	\$34.76	\$33.04	\$27.82	\$39.16
54	-0540	\$27.01	\$37.51	\$35.13	\$33.78	\$28.19	\$40.66
60	-0600	\$27.21	\$38.66	\$35.50	\$34.51	\$28.55	\$42.16
66	-0660	\$27.41	\$39.81	\$35.87	\$35.25	\$28.92	\$43.66
72	-0720	\$27.61	\$40.96	\$36.24	\$35.98	\$29.28	\$45.16
Solder Center, Crimp Outer with Strain Relief							
LTH IN INS	DASH NUM	50 Ω RG 174 ③⑤ 1 shield⑦ 174-MAMBA-	50 Ω RG 316 ④② 1 shield⑩ 316-MAMBA-	50 Ω RD 316 ④②⑦ 2 shields 31D-MAMBA-	50 Ω RG188* ④② 1 shield⑩ 188-MAMBA-	50 Ω RD 188*④② 2 shields⑦ 88D-MAMBA-	50 Ω RG 178 ② 1 shield⑩ 178-MAMBA-
12	-0120	\$23.89	\$24.30	\$23.95	\$24.65	\$25.62	\$32.54
18	-0180	\$24.01	\$24.63	\$24.88	\$25.15	\$27.38	\$32.91
24	-0240	\$24.13	\$24.95	\$25.80	\$25.65	\$29.14	\$33.28
30	-0300	\$24.25	\$25.28	\$26.73	\$26.15	\$30.90	\$33.65
36	-0360	\$24.37	\$25.60	\$27.65	\$26.65	\$32.66	\$34.02
42	-0420	\$24.49	\$25.93	\$28.58	\$27.15	\$34.42	\$34.39
48	-0480	\$24.61	\$26.25	\$29.50	\$27.65	\$36.18	\$34.76
54	-0540	\$24.73	\$26.58	\$30.43	\$28.15	\$37.94	\$35.13
60	-0600	\$24.85	\$26.90	\$31.35	\$28.65	\$39.70	\$35.50
66	-0660	\$24.97	\$27.23	\$32.28	\$29.15	\$41.46	\$35.87
72	-0720	\$25.09	\$27.55	\$33.20	\$29.65	\$43.22	\$36.24
Color Designators (add letter to the end of the part number and add \$1.00 to price)							
Black - B		Blue - L		Brown - N		Gray - A	
Orange - O		Red - R		Violet - V		Green - G	
						White - W	

See Page B5 for Cable Characteristics

* Contact Factory for delivery, Consider new RD316 for (RD188)

10% Discount @ 25 pcs. up

4% Discount @ 10 pcs. up

SMA Male Plug X SMB Male Bulkhead Jack

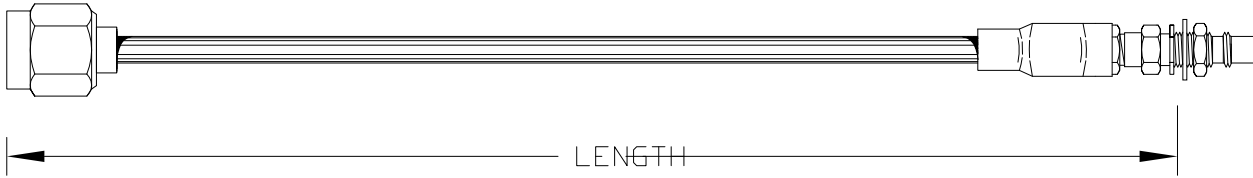

LENGTH IN INCHES	DASH NUM	50 Ω RG 58C ③⑥ 1 shield⑦ 058-MAMBF-	50 Ω RG 142 ④② 2 shields⑦ 142-MAMBF-	50 Ω RG 196 ② 1 shield⑥ 196-MAMBF-	50 Ω RG 223 ③① 2 shields⑦ 223-MAMBF-	50 Ω RG 179 ④② 1 shield⑥ 179-MAMBF-	50 Ω RG 400*④① 2 shields⑦ 400-MAMBF-
Solder Center, Crimp Outer with Strain Relief							
12	-0120	\$25.04	\$28.23	\$30.87	\$27.40	\$22.36	\$28.93
18	-0180	\$25.24	\$29.38	\$31.24	\$28.14	\$22.73	\$30.43
24	-0240	\$25.44	\$30.53	\$31.61	\$28.87	\$23.09	\$31.93
30	-0300	\$25.64	\$31.68	\$31.98	\$29.61	\$23.46	\$33.43
36	-0360	\$25.84	\$32.83	\$32.35	\$30.34	\$23.82	\$34.93
42	-0420	\$26.04	\$33.98	\$32.72	\$31.08	\$24.19	\$36.43
48	-0480	\$26.24	\$35.13	\$33.09	\$31.81	\$24.55	\$37.93
54	-0540	\$26.44	\$36.28	\$33.46	\$32.55	\$24.92	\$39.43
60	-0600	\$26.64	\$37.43	\$33.83	\$33.28	\$25.28	\$40.93
66	-0660	\$26.84	\$38.58	\$34.20	\$34.02	\$25.65	\$42.43
72	-0720	\$27.04	\$39.73	\$34.57	\$34.75	\$26.01	\$43.93
84	-0840	\$27.24	\$40.88	\$34.94	\$35.49	\$26.38	\$45.43
Solder Center, Crimp Outer with Strain Relief							
LENGTH IN INCHES	DASH NUM	50 Ω RG 174 ③⑤ 1 shield⑦ 174-MAMBF-	50 Ω RG 316 ④② 1 shield⑥ 316-MAMBF-	50 Ω RD 316④②⑦ 2 shields⑦ 31D-MAMBF-	50 Ω RG188* ④② 1 shield⑥ 188-MAMBF-	50 Ω RD 188*④②⑦ 2 shields⑦ 88D-MAMBF-	50 Ω RG 178 ② 1 shield⑥ 178-MAMBF-
12	-0120	\$21.87	\$22.28	\$21.93	\$24.72	\$23.60	\$30.87
18	-0180	\$21.99	\$22.61	\$22.86	\$25.22	\$25.36	\$31.24
24	-0240	\$22.11	\$22.93	\$23.78	\$25.72	\$27.12	\$31.61
30	-0300	\$22.23	\$23.26	\$24.71	\$26.22	\$28.88	\$31.98
36	-0360	\$22.35	\$23.58	\$25.63	\$26.72	\$30.64	\$32.35
42	-0420	\$22.47	\$23.91	\$26.56	\$27.22	\$32.40	\$32.72
48	-0480	\$22.59	\$24.23	\$27.48	\$27.72	\$34.16	\$33.09
54	-0540	\$22.71	\$24.56	\$28.41	\$28.22	\$35.92	\$33.46
60	-0600	\$22.83	\$24.88	\$29.33	\$28.72	\$37.68	\$33.83
66	-0660	\$22.95	\$25.21	\$30.26	\$29.22	\$39.44	\$34.20
72	-0720	\$23.07	\$25.53	\$31.18	\$29.72	\$41.20	\$34.57
84	-0840	\$23.19	\$25.86	\$32.11	\$30.22	\$42.96	\$34.94
Color Designators (add letter to the end of the part number and add \$1.00 to price)							
Black - B		Blue - L		Brown - N		Gray - A	
Orange - O		Red - R		Violet - V		Green - G	
						White - W	

See Page B5 for Cable Characteristics

* Contact Factory for delivery, Consider new RD316 for (RD188) 10% Discount @ 25 pcs. up 4% Discount @ 10 pcs. up



RF Depot.com Inc.

Phone 856-488-2000 Fax 856-488-2020

B152

7850 Browning Rd. Pennsauken, NJ 08109

Online @ www.rfdepot.com

Toll Free 877-RF Depot

SMA Male Plug x SMB Right Angle Female Plug

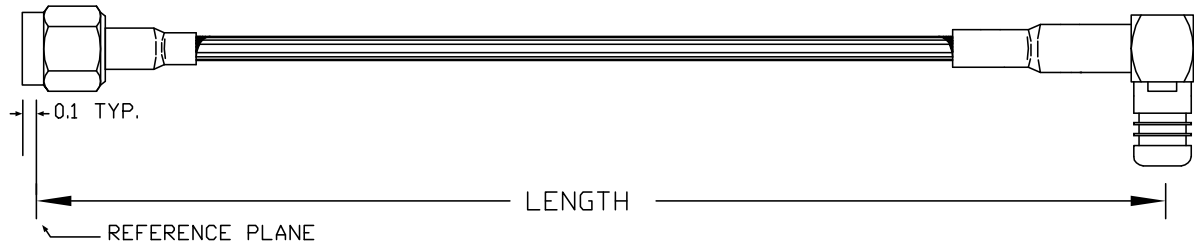

LTH IN INS	DASH NUM	50 Ω RG 58C ③⑥ 1 shield ⑦ 058-MAMBC-	50 Ω RG 142B ④② 2 shields ⑦ 142-MAMBC-	50 Ω RG 196 ②⑩ 1 shield 196-MAMBC-	50 Ω RG 223 ③① 2 shields ⑦ 223-MAMBC-	50 Ω RG 179 ④② 1 shield ⑩ 179-MAMBC-	50 Ω RG 400*④① 2 shields ⑦ 400-MAMBC-
Solder Center, Crimp Outer with Strain Relief							
12	-0120	\$25.94	\$41.39	\$30.16	\$40.56	\$24.35	\$42.09
18	-0180	\$26.14	\$42.54	\$30.53	\$41.30	\$24.72	\$43.59
24	-0240	\$26.34	\$43.69	\$30.90	\$42.03	\$25.08	\$45.09
30	-0300	\$26.54	\$44.84	\$31.27	\$42.77	\$25.45	\$46.59
36	-0360	\$26.74	\$45.99	\$31.64	\$43.50	\$25.81	\$48.09
42	-0420	\$26.94	\$47.14	\$32.01	\$44.24	\$26.18	\$49.59
48	-0480	\$27.14	\$48.29	\$32.38	\$44.97	\$26.54	\$51.09
54	-0540	\$27.34	\$49.44	\$32.75	\$45.71	\$26.91	\$52.59
60	-0600	\$27.54	\$50.59	\$33.12	\$46.44	\$27.27	\$54.09
66	-0660	\$27.74	\$51.74	\$33.49	\$47.18	\$27.64	\$55.59
72	-0720	\$27.94	\$52.89	\$33.86	\$47.91	\$28.00	\$57.09
Solder Center, Crimp Outer with Strain Relief							
LTH IN INS	DASH NUM	50 Ω RG 174 ③⑤ 1 shield ⑦ 174-MAMBA-	50 Ω RG 316 ④② 1 shield ⑩ 316-MAMBA-	50 Ω④ RD 316 ②⑦ 2 shields 316-MAMBA-	50 Ω RG188* ④③ 1 shield 188-MAMBA-	50 Ω④ RD 188* ②⑦ 2 shields 88D-MAMBA-	50 Ω RG 178 ②⑩ 1 shield 178-MAMBA-
12	-0120	\$23.24	\$23.65	\$23.46	\$24.00	\$24.97	\$30.16
18	-0180	\$23.36	\$23.98	\$24.39	\$24.50	\$26.73	\$30.53
24	-0240	\$23.48	\$24.30	\$25.31	\$25.00	\$28.49	\$30.90
30	-0300	\$23.60	\$24.63	\$26.24	\$25.50	\$30.25	\$31.27
36	-0360	\$23.72	\$24.95	\$27.16	\$26.00	\$32.01	\$31.64
42	-0420	\$23.84	\$25.28	\$28.09	\$26.50	\$33.77	\$32.01
48	-0480	\$23.96	\$25.60	\$29.01	\$27.00	\$35.53	\$32.38
54	-0540	\$24.08	\$25.93	\$29.94	\$27.50	\$37.29	\$32.75
60	-0600	\$24.20	\$26.25	\$30.86	\$28.00	\$39.05	\$33.12
66	-0660	\$24.32	\$26.58	\$31.79	\$28.50	\$40.81	\$33.49
72	-0720	\$24.44	\$26.90	\$32.71	\$29.00	\$42.57	\$33.86
Color Designators (add letter to the end of the part number and add \$1.00 to price)							
Black - B		Blue - L		Brown - N		Gray - A	
Orange - O		Red - R		Violet - V		Green - G	
						White - W	

See Page B5 for Cable Characteristics

* Contact Factory for delivery, Consider new RD316 for (RD188)

10% Discount @ 25 pcs. up

4% Discount @ 10 pcs. up

SMA Male Plug x SMC Female Plug

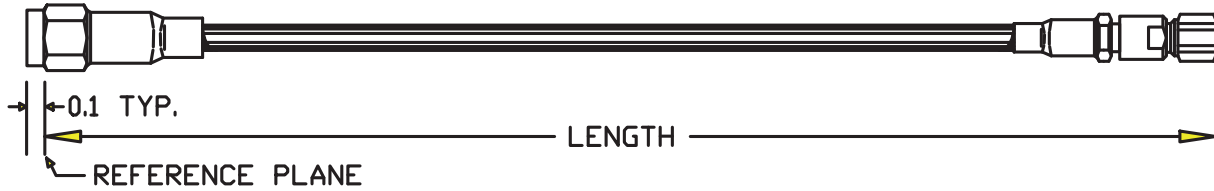

LTH IN INS	DASH NUM	50 Ω RG 58C ③⑥ 1 shield⑦ 058-MAMCA-	50 Ω RG 142B ④② 2 shields⑦ 142-MAMCA-	50 Ω RG 196 ②⑩ 1 shield 196-MAMCA-	50 Ω RG 223 ③① 2 shields⑦ 223-MAMCA-	50 Ω RG 179 ④② 1 shield⑩ 179-MAMCA-	50 Ω RG 400*④① 2 shields⑦ 400-MAMCA-
Solder Center, Crimp Outer with Strain Relief							
12	-0120	\$26.47	\$29.66	\$40.02	\$28.83	\$24.56	\$30.36
18	-0180	\$26.67	\$30.81	\$40.39	\$29.57	\$24.93	\$31.86
24	-0240	\$26.87	\$31.96	\$40.76	\$30.30	\$25.29	\$33.36
30	-0300	\$27.07	\$33.11	\$41.13	\$31.04	\$25.66	\$34.86
36	-0360	\$27.27	\$34.26	\$41.50	\$31.77	\$26.02	\$36.36
48	-0480	\$27.67	\$36.56	\$42.24	\$33.24	\$26.75	\$39.36
54	-0540	\$27.87	\$37.71	\$42.61	\$33.98	\$27.12	\$40.86
60	-0600	\$28.07	\$38.86	\$42.98	\$34.71	\$27.48	\$42.36
66	-0660	\$28.27	\$40.01	\$43.35	\$35.45	\$27.85	\$43.86
72	-0720	\$28.47	\$41.16	\$43.72	\$36.18	\$28.21	\$45.36
Solder Center, Crimp Outer with Strain Relief							
LTH IN INS	DASH NUM	50 Ω RG 174 ③⑤ 1 shield⑦ 174-MAMCA-	50 Ω RG 316 ④② 1 shield⑩ 316-MAMCA-	50 Ω④ RD 316 ②⑦ 2 shields 31D-MAMCA-	50 Ω RG188* ④③ 1 shield 188-MAMCA-	50 Ω④ RD 188* ②⑦ 2 shields 88D-MAMCA-	50 Ω RG 178 ②⑩ 1 shield 178-MAMCA-
12	-0120	\$24.30	\$24.71	\$24.91	\$25.06	\$26.58	\$40.02
18	-0180	\$24.42	\$25.04	\$25.84	\$25.56	\$28.34	\$40.39
24	-0240	\$24.54	\$25.36	\$26.76	\$26.06	\$30.10	\$40.76
30	-0300	\$24.66	\$25.69	\$27.69	\$26.56	\$31.86	\$41.13
36	-0360	\$24.78	\$26.01	\$28.61	\$27.06	\$33.62	\$41.50
42	-0420	\$24.90	\$26.34	\$29.54	\$27.56	\$35.38	\$41.87
48	-0480	\$25.02	\$26.66	\$30.46	\$28.06	\$37.14	\$42.24
54	-0540	\$25.14	\$26.99	\$31.39	\$28.56	\$38.90	\$42.61
60	-0600	\$25.26	\$27.31	\$32.31	\$29.06	\$40.66	\$42.98
66	-0660	\$25.38	\$27.64	\$33.24	\$29.56	\$42.42	\$43.35
72	-0720	\$25.50	\$27.96	\$34.16	\$30.06	\$44.18	\$43.72
Color Designators (add letter to the end of the part number and add \$1.00 to price)							
Black - B		Blue - L		Brown - N		Gray - A	
Orange - O		Red - R		Violet - V		Green - G	
						White - W	

See Page B5 for Cable Characteristics

* Contact Factory for delivery, Consider new RD316 for (RD188) 10% Discount @ 25 pcs. up 4% Discount @ 10 pcs. up



RF Depot.com Inc.

Phone 856-488-2000 Fax 856-488-2020

SMA Male Plug x SMP Socket

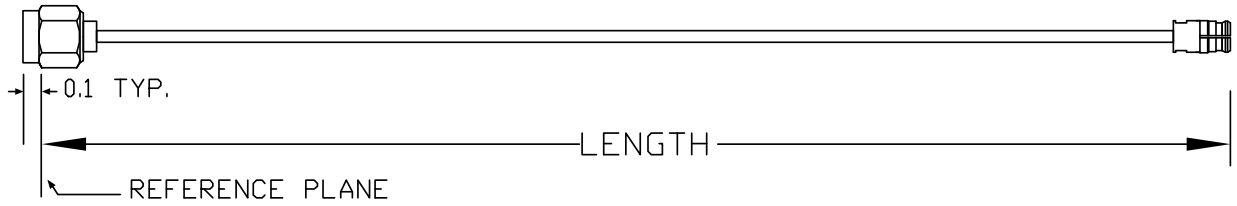

LENGTH IN INCHES	DASH NUM	50Ω RG 405② M17/133-00006 .085 Cu Jacket 405-MP0M0-	50Ω RG 405② M17/133-00007 .085 Tin Plate Cu 8TS-MP0M0-	50Ω RG 405② M17/133-00013 .085 Tin Plate Al 8AT-MP0M0-	50Ω Tee-Flex② (No QPL List) .085 Helix Braid 08T-MP0M0-	50Ω RG 405② M17/133-00016 .085 Silver Pl 8SS-MP0M0-
SEMIRIGID Direct Solder Connectors						
12	-0120	\$35.02	\$35.02	\$35.96	\$36.25	\$40.21
24	-0240	\$38.04	\$38.04	\$39.92	\$40.50	\$48.42
36	-0360	\$41.06	\$41.06	\$43.88	\$44.75	\$56.63
48	-0480	\$44.08	\$44.08	\$47.84	\$49.00	\$64.84
60	-0600	\$47.10	\$47.10	\$51.80	\$53.25	\$73.05
72	-0720	\$50.12	\$50.12	CALL	\$57.50	CALL
SEMIRIGID and MaxiFlex Direct Solder Connectors						
LENGTH IN INCHES	DASH NUM	50Ω ② M17/151-00001 .047 Cu Jacket 4CU-MP0M0-	50Ω ② (No QPL List) .047 Tin Plate Al 4AT-MP0M0-	50Ω ② M17/151-00002 .047 Tin Plate Cu 4TS-MP0M0-	50Ω MaxiFlex② (No QPL List) .047 Tin Pl 04F-MP0M0-	50 Ω LowLoss①● RG 405 .085" MicroprTin-Cu 8LT-MP0M0-
12	-0120	\$44.42	\$45.87	\$44.42	\$45.12	\$64.43
24	-0240	\$48.22	\$51.12	\$48.22	\$49.62	\$70.43
36	-0360	\$52.02	\$56.37	\$52.02	\$54.12	\$76.43
48	-0480	\$55.82	\$61.62	\$55.82	\$58.62	\$82.43
60	-0600	\$59.62	\$66.87	\$59.62	\$63.12	\$88.43
72	-0720	\$63.42	\$72.12	\$63.42	\$67.62	CALL

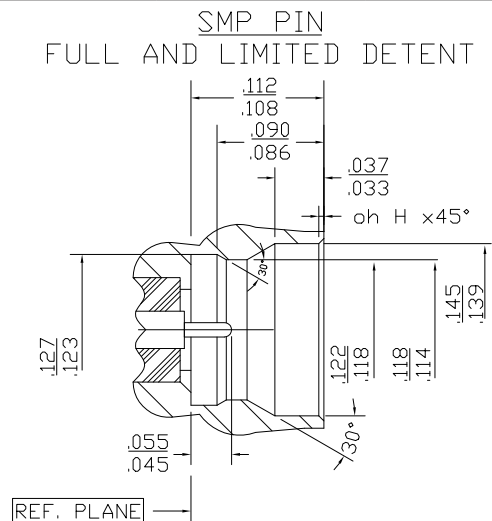
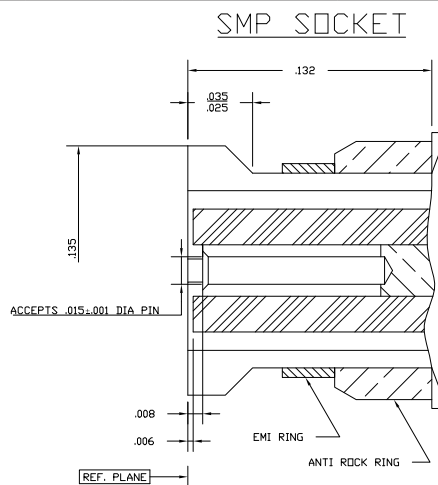

①Silver Plated Copper Center Conductor ②Silver Plated Copper Clad Steel Center Conductor
 10% Discount @ 25 pcs. up 4% Discount @ 10 pcs. up

SMA Male Plug x SSMB Female Plug

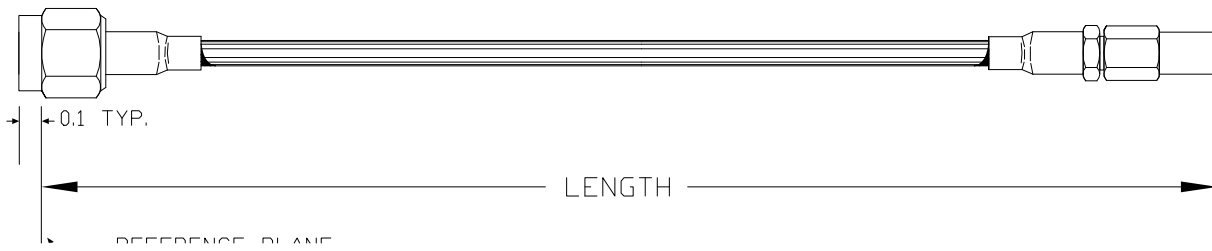

LTH IN INS	DASH NUM	50 Ω RG 174 ②⑤ 1 shield⑦ 174-MASBA-	50 Ω RG188* ④③ 1 shield 188-MASBA-	50 Ω④ RD 188* ②⑦ 2 shields 88D-MASBA-	50 Ω RG 316 ④② 1 shield⑩ 316-MASBA-	50 Ω④ RD 316 ②⑦ 2 shields 31D-MASBA-	50 Ω RG 178 ②⑩ 1 shield 178-MASBA-	50 Ω RG 196 ②⑩ 1 shield 196-MASBA-
Solder Center, Crimp Outer with Strain Relief								
12	-0120	\$30.92	\$31.68	\$32.65	\$31.33	\$30.98	\$36.22	\$36.22
24	-0240	\$31.16	\$32.68	\$36.17	\$31.98	\$32.83	\$36.96	\$36.96
36	-0360	\$31.40	\$33.68	\$39.69	\$32.63	\$34.68	\$37.70	\$37.70
48	-0480	\$31.64	\$34.68	\$43.21	\$33.28	\$36.53	\$38.44	\$38.44
60	-0600	\$31.88	\$35.68	\$46.73	\$33.93	\$38.38	\$39.18	\$39.18
72	-0720	\$32.12	\$36.68	\$50.25	\$34.58	\$40.23	\$39.92	\$39.92
Solder Center, Crimp Outer with Strain Relief								
LTH IN INS	DASH NUM	50 Ω ② M17/151-00001 .047 Cu Jacket 4CU-MASBA-	50 Ω② (No QPL List) .047 Tin Plate Al 4AT-MASBA-	50 Ω ② M17/151-00002 .047 Tin Plate Cu 4TS-MASBA-	50 Ω ② (No QPL List) .047 Tin Pl 04F-MASMA-	50 Ω ① Non-Magnetic .047 Tin Plate Cu 4CT-MASBA-		
12	-0120	\$42.53	\$43.98	\$42.53	\$43.23	\$45.41		
24	-0240	\$46.33	\$49.23	\$46.33	\$47.73	\$52.09		
36	-0360	\$50.13	\$54.48	\$50.13	\$52.23	\$58.77		
48	-0480	\$53.93	\$59.73	\$53.93	\$56.73	\$65.45		
60	-0600	\$57.73	\$64.98	\$57.73	\$61.23	\$72.13		
72	-0720	\$61.53	\$70.23	\$61.53	\$65.73	\$78.81		
Solder Center, Crimp Outer with Strain Relief								
LTH IN INS	DASH NUM	50 Ω RG 405 ② M17/133-00006 .085 Tin Plate Cu 405-MASBA-	50 Ω RG 405 ② M17/133-00007 .085 Tin Plate Cu 8TS-MASBA-	50 Ω RG 405 ② M17/133-00013 .085 Tin Plate Al 8AT-MASBA-	50 Ω RG 405 ② (No QPL List) .085 Tin Pl 08F-MASBA-	50 Ω RG 405 ② M17/133-00016 .085 Silver Pl 8SS-MASBA-		
12	-0120	\$33.79	\$33.79	\$34.73	\$35.02	\$38.98		
24	-0240	\$36.81	\$36.81	\$38.69	\$39.27	\$47.19		
36	-0360	\$39.83	\$39.83	\$42.65	\$43.52	\$55.40		
48	-0480	\$42.85	\$42.85	\$46.61	\$47.77	\$63.61		
60	-0600	\$45.87	\$45.87	\$50.57	\$52.02	\$71.82		
72	-0720	\$48.89	\$48.89	CALL	\$56.27	CALL		
Color Designators (add letter to the end of the part number and add \$1.00 to price)								
Black - B		Blue - L		Brown - N		Gray - A		Green - G
Orange - O		Red - R		Violet - V		Yellow - Y		White - W

See Page B5 for Cable Characteristics

* Contact Factory for delivery, Consider new RD316 for (RD188) 10% Discount @ 25 pcs. up 4% Discount @ 10 pcs. up

①Silver Plated Copper Center Conductor ②Silver Plated Copper Clad Steel Center Conductor



RF Depot.com Inc.

Phone 856-488-2000 Fax 856-488-2020

SMA Male Plug x SSMC Female Plug

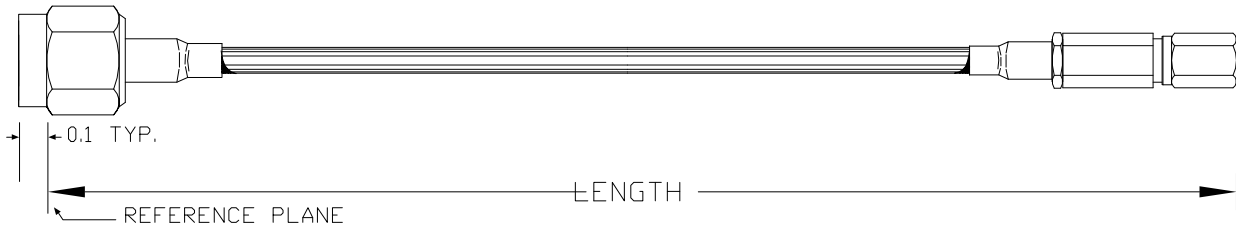

LTH IN INS	DASH NUM	50 Ω RG 174 ③⑤ 1 shield⑦ 174-MACSA-	50 Ω RG188* ④③ 1 shield 188-MACSA-	50 Ω④ RD 188* ②⑦ 2 shields 88D-MACSA-	50 Ω RG 316 ④② 1 shield⑥ 316-MACSA-	50 Ω④ RD 316 ②⑦ 2 shields 31D-MACSA	50 Ω RG 178 ②⑩ 1 shield 178-MACSA-	50 Ω RG 196 ②⑩ 1 shield 196-MACSA-
Solder Center, Crimp Outer with Strain Relief								
12	-0120	\$33.85	\$34.61	\$35.58	\$34.26	\$33.91	\$43.79	\$43.79
24	-0240	\$34.09	\$35.61	\$39.10	\$34.91	\$35.76	\$44.53	\$44.53
36	-0360	\$34.33	\$36.61	\$42.62	\$35.56	\$37.61	\$45.27	\$45.27
48	-0480	\$34.57	\$37.61	\$46.14	\$36.21	\$39.46	\$46.01	\$46.01
60	-0600	\$34.81	\$38.61	\$49.66	\$36.86	\$41.31	\$46.75	\$46.75
Solder Center, Crimp Outer with Strain Relief								
LENGTH IN INCHES	DASH NUM	50 Ω ② M17/151-00001 .047 Cu Jacket 4CU-MACSA-	50 Ω② (No QPL List) .047 Tin Plate Al 4AT-MACSA-	50 Ω ② M17/151-00002 .047 Tin Plate Cu 4TS-MACSA	50 Ω ② (No QPL List) .047 Tin Pl 04F-MACSA-	50 Ω ① Non-Magnetic .047 Tin Pl Cu 4CT-MACSA-		
12	-0120	\$42.92	\$44.37	\$42.92	\$43.62	\$45.80		
24	-0240	\$46.72	\$49.62	\$46.72	\$48.12	\$52.48		
36	-0360	\$50.52	\$54.87	\$50.52	\$52.62	\$59.16		
48	-0480	\$54.32	\$60.12	\$54.32	\$57.12	\$65.84		
60	-0600	\$58.12	\$65.37	\$58.12	\$61.62	\$72.52		
72	-0720	\$61.92	\$70.62	\$61.92	\$66.12	\$79.20		
Solder Center, Crimp Outer with Strain Relief								
LTH IN INS	DASH NUM	50 Ω RG 405 ② M17/133-00006 .085 Tin Plate Cu 405-MACSA-	50 Ω RG 405 ② M17/133-00007 .085 Tin Plate Cu 8TS-MACSA-	50 Ω RG 405 ② M17/133-00013 .085 Tin Plate Al 8AT-MACSA-	50 Ω RG 405 ② (No QPL List) .085 Tin Pl 08F-MACSA-	50 Ω RG 405 ② M17/133-00016 .085 Silver Pl 8SS-MACSA-	50 Ω RG 405 ② Non-Magnetic .085 Tin Plate Cu 8CT-MACSA-	
12	-0120	\$34.18	\$34.18	\$35.12	\$35.41	\$39.37	\$33.34	
24	-0240	\$37.20	\$37.20	\$39.08	\$39.66	\$47.58	\$35.52	
36	-0360	\$40.22	\$40.22	\$43.04	\$43.91	\$55.79	\$37.70	
48	-0480	\$43.24	\$43.24	\$47.00	\$48.16	\$64.00	\$39.88	
60	-0600	\$46.26	\$46.26	\$50.96	\$52.41	\$72.21	\$42.06	
72	-0720	\$49.28	\$49.28	CALL	\$56.66	CALL	\$44.24	
Color Designators (add letter to the end of the part number and add \$1.00 to price)								
Black - B		Blue - L		Brown - N		Gray - A		Green - G
Orange - O		Red - R		Violet - V		Yellow - Y		White - W

See Page B5 for Cable Characteristics

* Contact Factory for delivery, Consider new RD316 for (RD188) 10% Discount @ 25 pcs. up 4% Discount @ 10 pcs. up

SMA Male Plug x TNC Female Bulkhead Jack

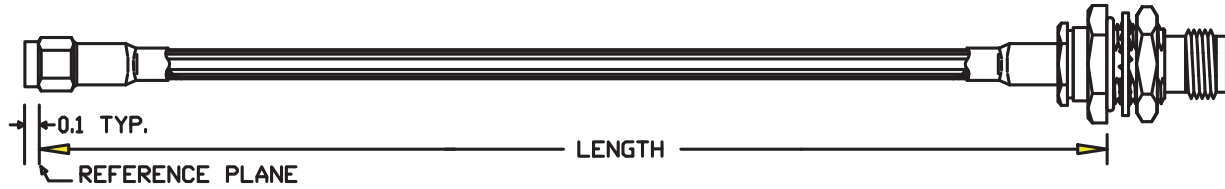

LENGTH IN INCHES	DASH NUMBER	50 Ω RG 58C ③⑥ 1 shield⑦ 058-MATF-	50 Ω RG 142B ④② 2 shields⑦ 142-MATF-	50 Ω RG 196 ② 1 shield⑩ 196-MATF-	50 Ω RG 223 ③① 2 shields⑦ 223-MATF-	50 Ω RG 179 ④② 1 shield⑩ 179-MATF-	50 Ω* RG 400④① 2 shields ⑦ 400-MATF-
Solder Center, Crimp Outer with Strain Relief							
12	-0120	\$24.32	\$27.27	\$29.45	\$26.44	\$28.43	\$27.97
18	-0180	\$24.52	\$28.42	\$29.82	\$27.18	\$28.80	\$29.47
24	-0240	\$24.72	\$29.57	\$30.19	\$27.91	\$29.16	\$30.97
30	-0300	\$24.92	\$30.72	\$30.56	\$28.65	\$29.53	\$32.47
36	-0360	\$25.12	\$31.87	\$30.93	\$29.38	\$29.89	\$33.97
42	-0420	\$25.32	\$33.02	\$31.30	\$30.12	\$30.26	\$35.47
48	-0480	\$25.52	\$34.17	\$31.67	\$30.85	\$30.62	\$36.97
54	-0540	\$25.72	\$35.32	\$32.04	\$31.59	\$30.99	\$38.47
60	-0600	\$25.92	\$36.47	\$32.41	\$32.32	\$31.35	\$39.97
66	-0660	\$26.12	\$37.62	\$32.78	\$33.06	\$31.72	\$41.47
72	0720	\$26.32	\$38.77	\$33.15	\$33.79	\$32.08	\$42.97
Solder Center, Crimp Outer with Strain Relief							
LENGTH IN INCHES	DASH NUMBER	50 Ω RG 174 ③⑤ 1 shield⑦ 174-MATF-	50 Ω RG 316 ④② 1 shield⑩ 316-MATF-	50 Ω④ RD 316 ②⑦ 2 shields 31D-MATF-	50 Ω RG188* ④③ 1 shield 188-MATF-	50 Ω④ RD 188*②⑦ 2 shields 88D-MATF-	50 Ω RG 178 ②⑩ 1 shield 178-MATF-
12	-0120	\$34.73	\$35.14	\$34.79	\$35.49	\$36.46	\$29.45
18	-0180	\$34.85	\$35.47	\$35.72	\$35.99	\$38.22	\$29.82
24	-0240	\$34.97	\$35.79	\$36.64	\$36.49	\$39.98	\$30.19
30	-0300	\$35.09	\$36.12	\$37.57	\$36.99	\$41.74	\$30.56
36	-0360	\$35.21	\$36.44	\$38.49	\$37.49	\$43.50	\$30.93
42	-0420	\$35.33	\$36.77	\$39.42	\$37.99	\$45.26	\$31.30
48	-0480	\$35.45	\$37.09	\$40.34	\$38.49	\$47.02	\$31.67
54	-0540	\$35.57	\$37.42	\$41.27	\$38.99	\$48.78	\$32.04
60	-0600	\$35.69	\$37.74	\$42.19	\$39.49	\$50.54	\$32.41
66	-0660	\$35.81	\$38.07	\$43.12	\$39.99	\$52.30	\$32.78
72	-0720	\$35.93	\$38.39	\$44.04	\$40.49	\$54.06	\$33.15
Color Designators (add letter to the end of the part number and add \$1.00 to price)							
Black - B		Blue - L		Brown - N		Gray - A	
Orange - O		Red - R		Violet - V		Green - G	
						White - W	

See Page B5 for Cable Characteristics

* Contact Factory for delivery, Consider new RD316 for (RD188) 10% Discount @ 25 pcs. up 4% Discount @ 10 pcs. up

SMA Male Plug x TNC Female Bulkhead Jack

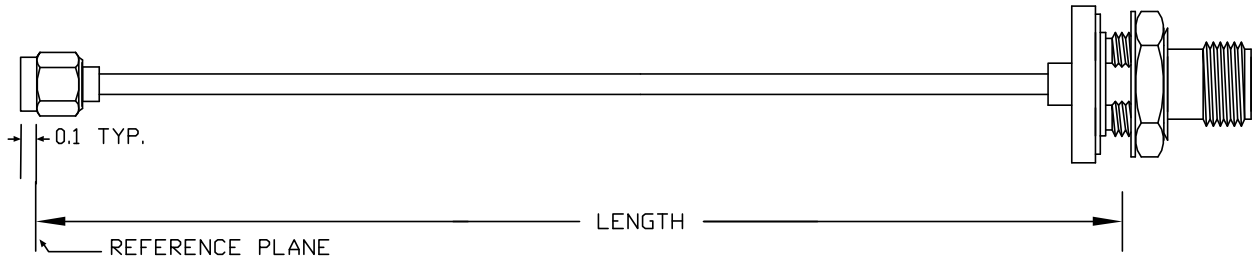

LENGTH IN INCHES	DASH NUMBER	50 Ω RG 402 ② M17/130-00004 .141 Cu Jacket 402-M0T5-	50 Ω RG 402 ② M17/130-00005 .141 Tin Plate Cu 1T5-M0T5-	50 Ω RG 402① M17/130-00009 .141 Tin Plate Al 1AT-M0T5-	50 Ω MaxiFlex (No QPL List) .141 Tin Pl 14F-M0T5-	50 Ω RG 402 ② M17/130-00012 .141 Silver Pl 1SS-M0T5-
.141" Diameter SEMIRIGID and MaxiFlex Direct Solder Connectors						
12	-0120	\$53.89	\$53.53	\$53.89	\$53.53	\$63.10
18	-0180	\$55.69	\$55.15	\$55.69	\$55.15	\$69.51
24	-0240	\$57.49	\$56.77	\$57.49	\$56.77	\$75.91
30	-0300	\$59.29	\$58.39	\$59.29	\$58.39	\$82.32
36	-0360	\$61.09	\$60.01	\$61.09	\$60.01	\$88.72
42	-0420	\$62.89	\$61.63	\$62.89	\$61.63	\$95.13
48	-0480	\$64.69	\$63.25	\$64.69	\$63.25	\$101.53
54	-0540	\$66.49	\$64.87	\$66.49	\$64.87	\$107.94
60	-0600	\$68.29	\$66.49	\$68.29	\$66.49	\$114.34
66	-0660	\$70.09	\$68.11	CALL	\$68.11	CALL
72	0720	\$71.89	\$69.73	CALL	\$69.73	CALL
.085" Diameter SEMIRIGID and MaxiFlex Direct Solder Connectors						
LENGTH IN INCHES	DASH NUMBER	50 Ω RG 405 ② M17/133-00006 .085 Cu Jacket 405-M0T5-	50 Ω RG 405 ② M17/133-00007 .085 Tin Plate Cu 8T5-M0T5-	50 Ω RG 405 ② M17/133-00013 .085 Tin Plate Al 8AT-M0T5-	50 Ω MaxiFlex (No QPL List) .085 Silver Pl 08F-M0T5-	50 Ω RG 405 ② M17/133-00016 .085 Silver Pl 8SS-M0T5-
12	-0120	\$71.86	\$71.86	\$72.80	\$73.09	\$77.05
18	-0180	\$73.37	\$73.37	\$74.78	\$75.22	\$81.16
24	-0240	\$74.88	\$74.88	\$76.76	\$77.34	\$85.26
30	-0300	\$76.39	\$76.39	\$78.74	\$79.47	\$89.37
36	-0360	\$77.90	\$77.90	\$80.72	\$81.59	\$93.47
42	-0420	\$79.41	\$79.41	\$82.70	\$83.72	\$97.58
48	-0480	\$80.92	\$80.92	\$84.68	\$85.84	\$101.68
54	-0540	\$82.43	\$82.43	\$86.66	\$87.97	\$105.79
60	-0600	\$83.94	\$83.94	\$88.64	\$90.09	\$109.89
66	-0660	\$85.45	\$85.45	CALL	\$92.22	CALL
72	-0720	\$86.96	\$86.96	CALL	\$94.34	CALL

①Silver Plated Copper Center Conductor ②Silver Plated Copper Clad Steel Center Conductor

10% Discount @ 25 pcs. up 4% Discount @ 10 pcs. up



SMA Male Plug x TNC Female Bulkhead Jack Commercial

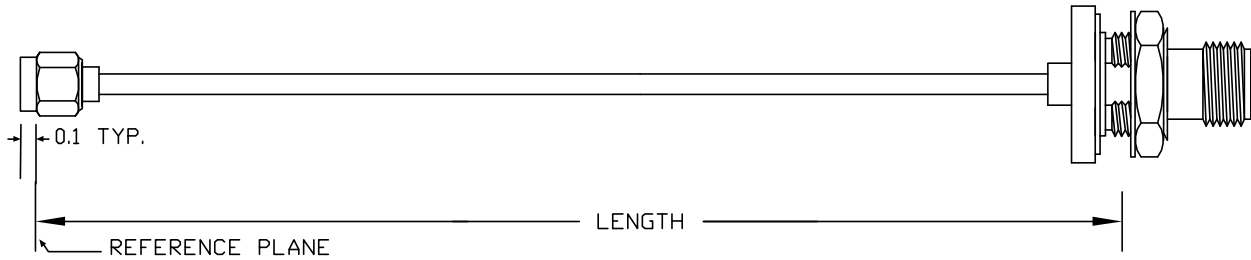

LENGTH IN INCHES	DASH NUMBER	50 Ω RG 402 ② M17/130-00004 .141 Cu Jacket 402-M0T5-	50 Ω RG 402 ② M17/130-00005 .141 Tin Plate Cu 1TS-M0T5-	50 Ω RG 402① M17/130-00009 .141 Tin Plate Al 1AT-M0T5-	50 Ω MaxiFlex (No QPL List) .141 Tin Pl 14F-M0T5-	50 Ω RG 402 ② M17/130-00012 .141 Silver Pl 1SS-M0T5-
.141" Diameter SEMIRIGID and MaxiFlex Direct Solder Connectors						
12	-0120C	\$21.61	\$21.25	\$21.61	\$21.25	\$30.82
18	-0180C	\$23.41	\$22.87	\$23.41	\$22.87	\$37.23
24	-0240C	\$25.21	\$24.49	\$25.21	\$24.49	\$43.63
30	-0360C	\$27.01	\$26.11	\$27.01	\$26.11	\$50.04
36	-0360C	\$28.81	\$27.73	\$28.81	\$27.73	\$56.44
42	-0420C	\$30.61	\$29.35	\$30.61	\$29.35	\$62.85
48	-0480C	\$32.41	\$30.97	\$32.41	\$30.97	\$69.25
54	-0540C	\$34.21	\$32.59	\$34.21	\$32.59	\$75.66
60	-0600C	\$36.01	\$34.21	\$36.01	\$34.21	\$82.06
72	0720C	\$39.61	\$37.45	CALL	\$37.45	CALL
.085" Diameter SEMIRIGID and MaxiFlex Direct Solder Connectors						
LENGTH IN INCHES	DASH NUM	50 Ω RG 405 ② M17/133-00006 .085 Cu Jacket 405-M0T5-	50 Ω RG 405 ② M17/133-00007 .085 Tin Plate Cu 8TS-M0T5-	50 Ω RG 405 ② M17/133-00013 .085 Tin Plate Al 8AT-M0T5-	50 Ω MaxiFlex (No QPL List) .085 Silver Pl 08F-M0T5-	50 Ω RG 405 ② M17/133-00016 .085 Silver Pl 8SS-M0T5-
12	-0120C	\$25.67	\$25.67	\$26.61	\$26.90	\$30.86
18	-0180C	\$27.18	\$27.18	\$28.59	\$29.03	\$34.97
24	-0240C	\$28.69	\$28.69	\$30.57	\$31.15	\$39.07
30	-0360C	\$30.20	\$30.20	\$32.55	\$33.28	\$43.18
36	-0360C	\$31.71	\$31.71	\$34.53	\$35.40	\$47.28
42	-0420C	\$33.22	\$33.22	\$36.51	\$37.53	\$51.39
48	-0480C	\$34.73	\$34.73	\$38.49	\$39.65	\$55.49
54	-0540C	\$36.24	\$36.24	\$40.47	\$41.78	\$59.60
60	-0600C	\$37.75	\$37.75	\$42.45	\$43.90	\$63.70
72	-0720C	\$40.77	\$40.77	CALL	\$48.15	CALL

①Silver Plated Copper Center Conductor ②Silver Plated Copper Clad Steel Center Conductor

10% Discount @ 25 pcs. up 4% Discount @ 10 pcs. up



B160

7850 Browning Rd. Pennsauken, NJ 08109

Online @ www.rfdepot.com

Phone 856-488-2000 Fax 856-488-2020

Toll Free 877-RF Depot

SMA Male Plug x TNC 4 Hole Panel Jack

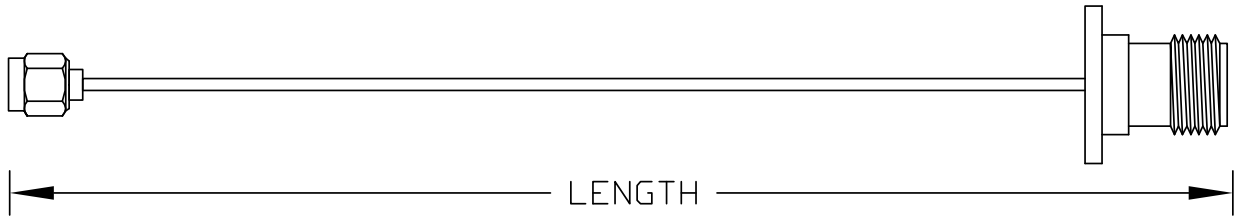

LENGTH IN INCHES	DASH NUM	50 Ω RG 58C ③⑥ 1 shield ⑦ 058-MATJ-	50 Ω RG 223 ③① 2 shields⑦ 223-MATJ-	50 Ω RG 174 ③⑤ 1 shield⑦ 174-MATJ-	50 Ω RG 316 ④② 1 shield⑩ 316-MATJ-	50 Ω RD 316 ④② 2 shields⑦ 31D-MATJ-	50 Ω RG188* ④③ 1 shield 188-MATJ-
Solder Center, Crimp Outer with Strain Relief							
12	-0120C	\$25.04	\$27.40	\$39.13	\$39.54	\$39.19	\$39.89
24	-0240C	\$25.44	\$28.87	\$39.37	\$40.19	\$41.04	\$40.89
36	-0360C	\$25.84	\$30.34	\$39.61	\$40.84	\$42.89	\$41.89
48	-0480C	\$26.24	\$31.81	\$39.85	\$41.49	\$44.74	\$42.89
60	-0600C	\$26.64	\$33.28	\$40.09	\$42.14	\$46.59	\$43.89
Solder Center, Crimp Outer with Strain Relief							
LTH IN INS	DASH NUM	50 Ω RG 402 ② M17/130-00004 .141 Cu Jacket 402-MATJ-	50 Ω RG 402 ② M17/130-00005 .141 Tin Pl Cu 1TS-MATJ-	50 Ω RG 402① M17/130-00009 .141 Tin Plate Al 1AT-MATJ-	50 Ω RG 402 ② (No QPL List) .141 Tin Pl 14F-MATJ-	50 Ω RG 402 ② M17/130-00012 .141 Silver Pl 1SS-MATJ-	
12	-0120	\$69.29	\$68.93	\$69.29	\$68.93	\$78.50	
24	-0240	\$72.89	\$72.17	\$72.89	\$72.17	\$91.31	
36	-0360	\$76.49	\$75.41	\$76.49	\$75.41	\$104.12	
60	-0600	\$83.69	\$81.89	\$83.69	\$81.89	\$129.74	
72	-0720	\$87.29	\$85.13	\$87.29	\$85.13	\$142.55	
Solder Center, Crimp Outer with Strain Relief							
LENGTH IN INCHES	DASH NUMBER	50 Ω RG 405 ② M17/133-00006 .085 Jacket Cu 405-MATJ-	50 Ω RG 405 ② M17/133-00013 .085 Tin Plate Al 8AT-MATJ-	50 Ω RG 405 ② (No QPL List) .085 Tin Pl 08F-MATJ-	50 Ω RG 400*④① 2 shields ⑦ 400-MATJ-	50 Ω SF 142B② 3 shields⑩ S42-MATJ-	
12	-0120	\$58.27	\$59.21	\$59.50	\$120.52	\$123.84	
24	-0240	\$61.29	\$63.17	\$63.75	\$123.52	\$130.16	
36	-0360	\$64.31	\$67.13	\$68.00	\$126.52	\$136.48	
48	-0480	\$67.33	\$71.09	\$72.25	\$129.52	\$142.80	
60	-0600	\$70.35	\$75.05	\$76.50	\$132.52	\$149.12	
72	-0720	\$73.37	CALL	\$80.75	\$135.52	\$155.44	
Color Designators (add letter to the end of the part number and add \$1.00 to price)							
Black - B		Blue - L		Brown - N		Gray - A	
Orange - O		Red - R		Violet - V		Green - G	
						White - W	

See Page B5 for Cable Characteristics

* Contact Factory for delivery, Consider new RD316 for (RD188) 10% Discount @ 25 pcs. up 4% Discount @ 10 pcs. up

①Silver Plated Copper Center Conductor ②Silver Plated Copper Clad Steel Center Conductor



SMA Male Plug x TNC Male Plug

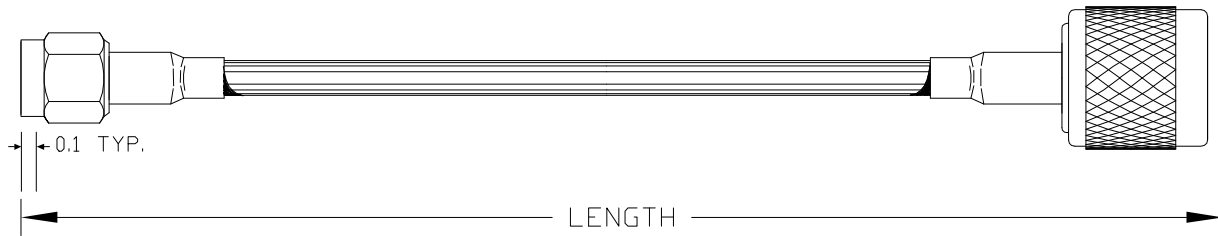

LTH IN INS	DASH NUM	50 Ω RG 58C ③⑥ 1 shield⑦ 058-MATA-	50 Ω RG 223 ③① 2 shields⑦ 223-MATA-	50 Ω RG 142B ④② 2 shields⑦ 142-MATA-	50 Ω RG 178 ②⑩ 1 shield 178-MAT0-	50 Ω* RG 400④① 2 shields⑦ 400-MATA-	50 Ω LL 142 ②③ 2 shields 4LL-M0T0-	50 Ω SF 142B② 3 shields⑨ S42-MAT0-
Solder Center, Crimp Outer with Strain Relief								
12	-0120	\$24.32	\$30.00	\$30.83	\$34.70	\$31.53	\$118.65	\$80.27
24	-0240	\$34.45	\$31.47	\$33.13	\$35.44	\$34.53	\$130.45	\$86.59
36	-0360	\$34.85	\$32.94	\$35.43	\$36.18	\$37.53	\$142.25	\$92.91
48	-0480	\$35.25	\$34.41	\$37.73	\$36.92	\$40.53	\$154.05	\$99.23
60	-0600	\$35.65	\$35.88	\$40.03	\$37.66	\$43.53	\$165.85	\$105.55
72	-0720	\$36.05	\$37.35	\$42.33	\$38.40	\$46.53	\$177.65	\$111.87
Solder Center, Crimp Outer with Strain Relief								
LENGTH IN INCHES	DASH NUMBER	50 Ω RG 174 ③⑤ 1 shield⑦ 174-MATA-	50 Ω RG 316 ④② 1 shield⑩ 316-MATA-	50 Ω④ RD 316 ②⑦ 2 shields 31D-MATA-	50 Ω RG188* ④③ 1 shield 188-MATA-	50 Ω RG 196 ②⑩ 1 shield 196-MAT0-	75 Ω RG 179A ④② 1 shield⑩ 179-MATA-	
12	-0120	\$23.91	\$24.32	\$23.97	\$24.67	\$34.70	\$25.30	
24	-0240	\$24.15	\$24.97	\$25.82	\$25.67	\$35.44	\$26.03	
36	-0360	\$24.39	\$25.62	\$27.67	\$26.67	\$36.18	\$26.76	
48	-0480	\$24.63	\$26.27	\$29.52	\$27.67	\$36.92	\$27.49	
60	-0600	\$24.87	\$26.92	\$31.37	\$28.67	\$37.66	\$28.22	
72	-0720	\$25.11	\$27.57	\$33.22	\$29.67	\$38.40	\$28.95	
Solder Center, Crimp Outer with Strain Relief								
LENGTH IN INCHES	DASH NUMBER	75 Ω RG 59 ③⑤ 1 shield⑩ 059-MATA	93 Ω RG 62③⑤ 1 shield⑩ 062-MATA-	50 Ω RG 213 ③③ 1 shield⑩ 213-MATA-	50 Ω RG 214 ③① 2 shields⑦ 214-MATA-	50 Ω RG 393④① 2 shield⑦ 393-MATA-		
12	-0120C	\$38.51	\$38.77	\$37.39	\$77.80	\$78.64		
24	-0240C	\$38.95	\$39.47	\$38.97	\$81.30	\$87.27		
36	-0360C	\$39.39	\$40.17	\$40.55	\$84.80	\$95.90		
48	-0480C	\$39.83	\$40.87	\$42.13	\$88.30	\$104.53		
60	-0600C	\$40.27	\$41.57	\$43.71	\$91.80	\$113.16		
72	-0720C	\$40.71	\$42.27	\$45.29	\$95.30	\$121.79		
Color Designators (add letter to the end of the part number and add \$1.00 to price)								
Black - B		Blue - L		Brown - N		Gray - A		Green - G
Orange - O		Red - R		Violet - V		Yellow - Y		White - W

See Page B5 for Cable Characteristics

* Contact Factory for delivery, Consider new RD316 for (RD188)

10% Discount @ 25 pcs. up

4% Discount @ 10 pcs. up



RF Depot.com Inc.

Phone 856-488-2000 Fax 856-488-2020

SMA Male Plug x TNC Male Plug

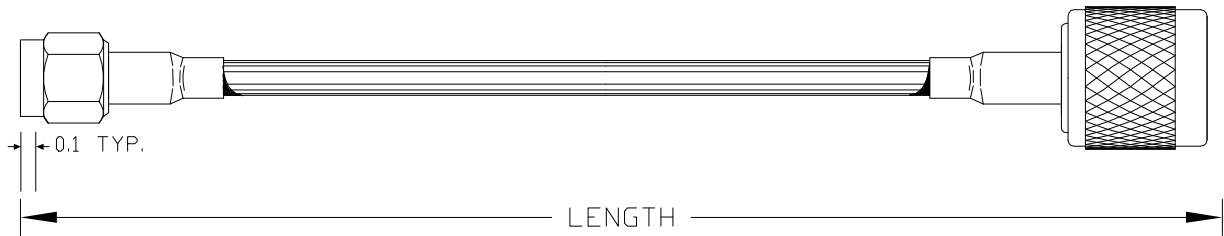

LTH IN INS	DASH NUMBER	50 Ω SIG 100 ^{①③} 2 shields ^② 1LC-MATA-	50 Ω ^⑤ LMR 100 ^① 2 shields ^② 1LM-MATA-	50 Ω SIG 195 ^{①③} 2 shields ^② 19C-MATA-	50 Ω LMR 195 ^{①③} 2 shields ^② 19M-MATA-	50 Ω ^③ SIG 200 ^① 2 shields ^② 2LC-MATA-	50 Ω LMR 200 ^{①③} 2 shields ^② 2LM-MATA-	50 Ω ^③ SIG 240 ^① 2 shields ^② 24S-MATA-
Solder Center, Crimp Outer with Strain Relief								
48	-0480C	\$21.24	\$21.72	\$20.35	\$20.91	\$20.95	\$21.15	\$23.83
72	-0720C	\$22.32	\$23.04	\$21.49	\$22.33	\$22.31	\$22.61	\$25.03
96	-0960C	\$22.86	\$23.70	\$22.06	\$23.04	\$22.99	\$23.34	\$25.63
120	-1200C	\$24.48	\$25.68	\$23.77	\$25.17	\$25.03	\$25.53	\$27.43
144	-1440C	\$25.56	\$27.00	\$24.91	\$26.59	\$26.39	\$26.99	\$28.63
180	-1800C	\$27.18	\$28.98	\$26.62	\$28.72	\$28.43	\$29.18	\$30.43
240	-2400C	\$29.88	\$32.28	\$29.47	\$32.27	\$31.83	\$32.83	\$33.43
Solder Center, Crimp Outer with Strain Relief								
LTH IN INS	DASH NUM	50 Ω ^③ LMR 240 ^① 2 shields ^② 24L-MATA-	50 Ω ^③ SIG 300 ^① 2 shields ^② 3LC-MATA-	50 Ω ^③ LMR 300 ^① 2 shields ^② 3LM-MATA-	50 Ω ^④ SIG 400 ^① 2 shields ^② 4LC-MATA-	50 Ω ^④ LMR 400 ^① 2 shields ^② 4LM-MATA-	50 Ω ^④ SIG 400DB ^① 2 shields ^② 4DC-MATA-	50 Ω ^④ LMR 400DB ^① 2 shields ^② 4LD-MATA-
48	-0480C	\$25.51	\$42.29	\$43.89	\$29.13	\$31.21	\$29.61	\$32.09
72	-0720C	\$27.55	\$43.73	\$46.13	\$30.85	\$33.97	\$31.57	\$35.29
96	-0960C	\$28.57	\$44.45	\$47.25	\$31.71	\$35.35	\$32.55	\$36.89
120	-1200C	\$31.63	\$46.61	\$50.61	\$34.29	\$39.49	\$35.49	\$41.69
144	-1440C	\$33.67	\$48.05	\$52.85	\$36.01	\$42.25	\$37.45	\$44.89
180	-1800C	\$36.73	\$50.21	\$56.21	\$38.59	\$46.39	\$40.39	\$49.69
240	-2400C	\$41.83	\$53.81	\$61.81	\$42.89	\$53.29	\$45.29	\$57.69
Solder Center, Crimp Outer with Strain Relief								
LENGTH IN INCHES	DASH NUMBER	50 Ω ^④ SIG 400FR ^① 2 shields ^② 4RC-MATA	50 Ω ^④ LMR 400FR ^① 2 shields ^② 4LR-MATA-	50 Ω ^④ SIG 400 UF ^① 2 shields ^② 4UF-MATA-	50 Ω ^④ LMR 400UF ^① 2 shields ^② 4UF-MATA-	50 Ω EF 142 ^① 2 shields ^② 42E-MATA-	50 Ω EF 400 ^① 2 shields ^② 40E-MATA-	
12	-0120C	\$26.67	\$27.59	\$26.67	\$27.59	\$35.31	\$35.35	
24	-0240C	\$27.65	\$29.49	\$27.65	\$29.49	\$37.83	\$37.91	
36	-0360C	\$28.63	\$31.39	\$28.63	\$31.39	\$40.35	\$40.47	
48	-0480C	\$29.61	\$33.29	\$29.61	\$33.29	\$42.87	\$43.03	
60	-0620C	\$30.59	\$35.19	\$30.59	\$35.19	\$45.39	\$45.59	
Color Designators (add letter to the end of the part number and add \$1.00 to price)								
Black - B		Blue - L		Brown - N		Gray - A		Green - G
Orange - O		Red - R		Violet - V		Yellow - Y		White - W

See Page B5 for Cable Characteristics

* Contact Factory for delivery, Consider new RD316 for (RD188)

10% Discount @ 25 pcs. up

4% Discount @ 10 pcs. up

SMA Male Plug x TNC Male Plug

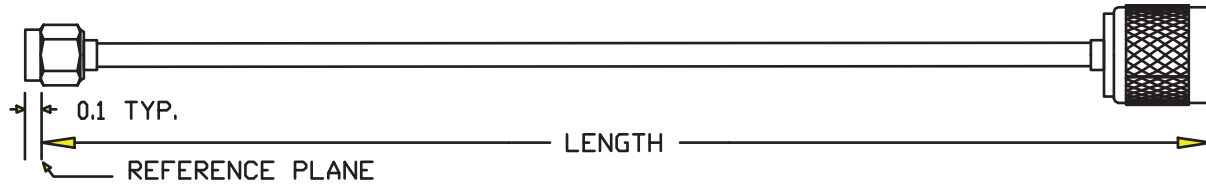

LTH IN INS	DASH NUM	50 Ω RG 401 ① M17/129-RG401 .250 Cu Jacket 401-M0T0-	50 Ω RG 401 ① (No QPL List) .250 Tin Plate Al 25A-M0T0-	50 Ω RG 401 ② M17/129-00001 .250 Cu Jacket 2TS-M0T0-	50 Ω MaxiFlex ② (No QPL List) .250 Tin Plate 25F-M0T0-	
Diameter SEMIRIGID and MaxiFlex Direct Solder Connectors						
12	-0120	\$134.03	\$134.97	\$139.22	\$134.03	
24	-0240	\$137.05	\$138.93	\$147.43	\$137.05	
36	-0360	\$140.07	\$142.89	\$155.64	\$140.07	
48	-0480	\$143.09	\$146.85	\$163.85	\$143.09	
60	-0600	\$146.11	\$150.81	\$172.06	\$146.11	
72	-0720	\$149.13	\$154.77	\$180.27	\$149.13	
84	-0840	\$152.15	\$158.73	\$188.48	\$152.15	
Diameter SEMIRIGID and MaxiFlex Direct Solder Connectors						
LTH IN INS	DASH NUM	50 Ω RG 402 ② M17/130-00004 .141 Cu Jacket 402-M0T0-	50 Ω RG 402 ② M17/130-00005 .141 Tin Plate Cu 1TS-M0T0-	50 Ω RG 402 ① M17/130-00009 .141 Tin Plate Al 1AT-M0T0-	50 Ω RG 402 ② (No QPL List) .141 Tin Pl 14F-M0T0-	50 Ω RG 402 ② M17/130-00012 .141 Silver Plate Cu 1SS-M0T0-
12	-0120	\$68.34	\$67.98	\$68.34	\$67.98	\$77.55
24	-0240	\$71.94	\$71.22	\$71.94	\$71.22	\$90.36
36	-0360	\$75.54	\$74.46	\$75.54	\$74.46	\$103.17
48	-0480	\$79.14	\$77.70	\$79.14	\$77.70	\$115.98
60	-0600	\$82.74	\$80.94	\$82.74	\$80.94	\$128.79
72	-0720	\$86.34	\$84.18	CALL	\$84.18	CALL
84	-0840	\$89.94	\$87.42	CALL	\$87.42	CALL
Diameter SEMIRIGID and MaxiFlex Direct Solder Connectors						
LTH IN INS	DASH NUM	50 Ω RG 405 ② M17/133-00006 .085 Jacket Cu 405-M0T0-	50 Ω RG 405 ② M17/133-00007 .085 Tin Plate Cu 8TS-M0T0	50 Ω RG 405 ② M17/133-00013 .085 Tin Plate Al 8AT-M0T0-	50 Ω RG 405 ② (No QPL List) .085 Tin Pl 08F-M0T0-	50 Ω RG 405 ② M17/133-00016 .085 Silver Pl 8SS-M0T0-
12	-0120	\$65.06	\$65.06	\$66.00	\$66.29	\$70.25
24	-0240	\$68.08	\$68.08	\$69.96	\$70.54	\$78.46
36	-0360	\$71.10	\$71.10	\$73.92	\$74.79	\$86.67
48	-0480	\$74.12	\$74.12	\$77.88	\$79.04	\$94.88
60	-0600	\$77.14	\$77.14	\$81.84	\$83.29	\$103.09
72	-0720	\$80.16	\$80.16	CALL	\$87.54	CALL
84	-0840	\$83.18	\$83.18	CALL	\$91.79	CALL

① Silver Plated Copper Center Conductor ② Silver Plated Copper Clad Steel Center Conductor

10% Discount @ 25 pcs. up 4% Discount @ 10 pcs. up



RF Depot.com Inc.

Phone 856-488-2000 Fax 856-488-2020

SMA Male Plug x TNC Male Plug Commercial

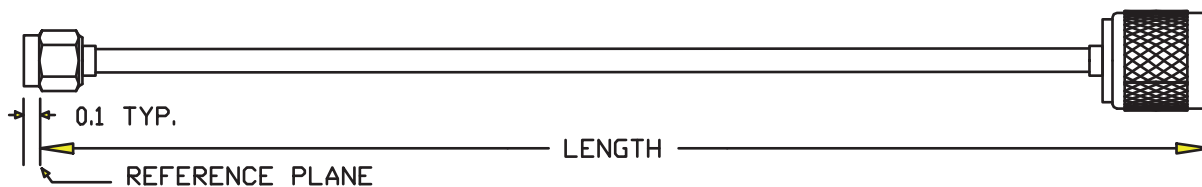

LTH IN INS	DASH NUM	50 Ω RG 401 ① M17/129-RG401 .250 Cu Jacket 401-M0T0-	50 Ω RG 401 ① (No QPL List) .250 Tin Plate Al 25A-M0T0-	50 Ω RG 401 ② M17/129-00001 .250 Cu Jacket 2TS-M0T0-	50 Ω MaxiFlex ② (No QPL List) .250 Tin Plate 25F-M0T0-	50 Ω RG 402 ② M17/130-00004 .141 Cu Jacket 402-M0T0-	50 Ω RG 402 ② M17/130-00005 .141 Tin Plate Cu 1TS-M0T0-
Diameter SEMIRIGID and MaxiFlex Direct Solder Connectors							
12	-0120	\$23.59	\$24.53	\$28.78	\$23.59	\$21.38	\$21.02
24	-0240	\$26.61	\$28.49	\$36.99	\$26.61	\$24.98	\$24.26
36	-0360	\$29.63	\$32.45	\$45.20	\$29.63	\$28.58	\$27.50
48	-0480	\$32.65	\$36.41	\$53.41	\$32.65	\$32.18	\$30.74
60	-0600	\$35.67	\$40.37	\$61.62	\$35.67	\$35.78	\$33.98
72	-0720	\$38.69	\$44.33	\$69.83	\$38.69	\$39.38	\$37.22
84	-0840	\$41.71	\$48.29	\$78.04	\$41.71	\$42.98	\$40.46
Diameter SEMIRIGID and MaxiFlex Direct Solder Connectors							
LTH IN INS	DASH NUM	50 Ω RG 402 ① M17/130-00009 .141 Tin Plate Al 1AT-M0T0-	50 Ω RG 402 ② (No QPL List) .141 Tin Pl 14F-M0T0-	50 Ω RG 402 ② M17/130-000012 .141 Silver Pl 1SS-M0T0-	50 Ω RG 405 ② M17/133-00006 .085 Jacket Cu 405-M0T0-	50 Ω RG 405 ② M17/133-00007 .085 Tin Plate Cu 8TS-M0T0	50 Ω RG 405 ② M17/133-00013 .085 Tin Plate Al 8AT-M0T0-
12	-0120	\$21.38	\$21.02	\$30.59	\$34.44	\$34.44	\$35.38
24	-0240	\$24.98	\$24.26	\$43.40	\$37.46	\$37.46	\$39.34
36	-0360	\$28.58	\$27.50	\$56.21	\$40.48	\$40.48	\$43.30
48	-0480	\$32.18	\$30.74	\$69.02	\$43.50	\$43.50	\$47.26
60	-0600	\$35.78	\$33.98	\$81.83	\$46.52	\$46.52	\$51.22
72	-0720	\$39.38	\$37.22	\$94.64	\$49.54	\$49.54	CALL
84	-0840	\$42.98	\$40.46	\$107.45	\$52.56	\$52.56	CALL
Diameter SEMIRIGID and MaxiFlex Direct Solder Connectors							
LTH IN INS	DASH NUM	50 Ω RG 405 ② (No QPL List) .085 Tin Pl 08F-M0T0-	50 Ω RG 405 ② M17/133-00016 .085 Silver Pl 8SS-M0T0-	50 Ω RG ② M17/151-00001 .047 Cu Jacket 4CU-M0T0	50 Ω RG ② (No QPL List) .047 Tin Plate Al 4AT-M0T0-	50 Ω RG ② M17/151-00002 .047 Tin Plate Cu 4TS-M0T0-	50 Ω RG ② (No QPL List) .047 Tin Pl 04F-M0T0-
12	-0120	\$35.67	\$39.63	\$38.20	\$39.65	\$38.20	\$38.90
24	-0240	\$39.92	\$47.84	\$42.00	\$44.90	\$42.00	\$43.40
36	-0360	\$44.17	\$56.05	\$45.80	\$50.15	\$45.80	\$47.90
48	-0480	\$48.42	\$64.26	\$49.60	\$55.40	\$49.60	\$52.40
60	-0600	\$52.67	\$72.47	\$53.40	\$60.65	\$53.40	\$56.90
72	-0720	\$56.92	CALL	\$57.20	\$65.90	\$57.20	\$61.40
84	-0840	\$61.17	CALL	\$61.00	\$71.15	\$61.00	\$65.90

①Silver Plated Copper Center Conductor ②Silver Plated Copper Clad Steel Center Conductor

10% Discount @ 25 pcs. up 4% Discount @ 10 pcs. up



SMA Male Plug x 1.85 Male Plug

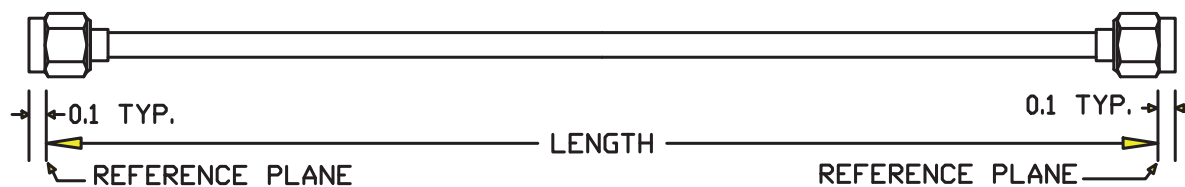

LENGTH IN INCHES	DASH NUM	50 Ω RG 405 ② M17/133-00006 .085 Cu Jacket 405-M0180-	50 Ω RG 405 ② M17/133-00007 .085 Tin Plate Cu 8TS-M0180-	50 Ω RG 405 ② M17/133-00013 .085 Tin Plate Al 8AT-M0180-	50 Ω RG 405 ② (No QPL List) .085 Tin Pl Braid 08F-M0180-	50 Ω RG 405 ② M17/133-00016 .085 Silver Pl 8SS-M0180-
.085" Diameter SEMIRIGID and MaxiFlex Direct Solder Connectors						
12	-0120	\$61.26	\$61.26	\$62.20	\$62.49	\$66.45
24	-0240	\$64.28	\$64.28	\$66.16	\$66.74	\$74.66
36	-0360	\$67.30	\$67.30	\$70.12	\$70.99	\$82.87
48	-0480	\$70.32	\$70.32	\$74.08	\$75.24	\$91.08
60	-0600	\$73.34	\$73.34	\$78.04	\$79.49	\$99.29
72	-0720	\$76.36	\$76.36	CALL	\$83.74	CALL

SMA Male Plug x 2.4 MM Male Plug

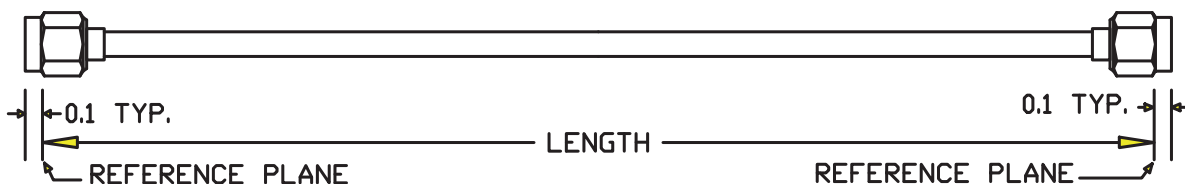

LENGTH IN INCHES	DASH NUM	50 Ω RG 405 ② M17/133-00006 .085 Cu Jacket 405-M0240-	50 Ω RG 405 ② M17/133-00007 .085 Tin Plate Cu 8TS-M0240-	50 Ω RG 405 ② M17/133-00013 .085 Tin Plate Al 8AT-M0240-	50 Ω MaxiFlex ② (No QPL List) .085 Tin Pl 08F-M0240-	50 Ω RG 405 ② M17/133-00016 .085 Silver Pl 8SS-M0240-
.085" Diameter SEMIRIGID and MaxiFlex Direct Solder Connectors						
12	-0120	\$62.88	\$62.88	\$63.82	\$64.11	\$68.07
24	-0240	\$65.90	\$65.90	\$67.78	\$68.36	\$76.28
36	-0360	\$68.92	\$68.92	\$71.74	\$72.61	\$84.49
48	-0480	\$71.94	\$71.94	\$75.70	\$76.86	\$92.70
60	-0600	\$74.96	\$74.96	\$79.66	\$81.11	\$100.91
72	-0720	\$77.98	\$77.98	CALL	\$85.36	CALL

① Silver Plated Copper Center Conductor ② Silver Plated Copper Clad Steel Center Conductor

10% Discount @ 25 pcs. up 4% Discount @ 10 pcs. up



RF Depot.com Inc.

Phone 856-488-2000 Fax 856-488-2020

SMA Male Plug x 2.9 MM Male Plug

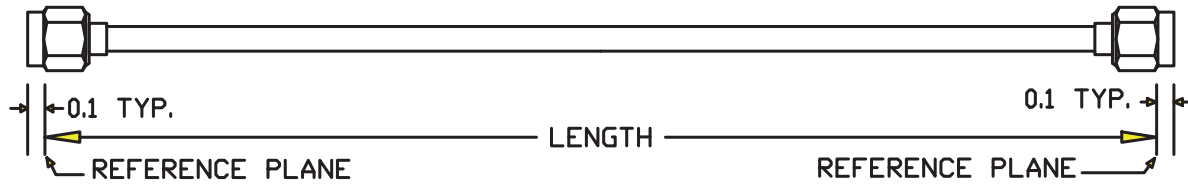

LENGTH IN INCHES	DASH NUMBER	50 Ω RG 402 [Ⓞ] M17/130-00004 .141 Cu Jacket 402-M0290-	50 Ω RG 402 [Ⓞ] M17/130-00005 .141 Tin Plate Cu 1TS-M0290-	50 Ω RG 402 [Ⓞ] M17/130-00009 .141 Tin Plate Al 1AT-M0290-	50 Ω MaxiFlex (No QPL List) .141 Tin Plate Braid 14F-M0290-	50 Ω RG 402 [Ⓞ] M17/130-00012 .141 Silver Plate Cu 1SS-M0290-
.141" Diameter SEMIRIGID and MaxiFlex Direct Solder Connectors						
12	-0120	\$64.62	\$64.26	\$64.62	\$64.26	\$73.83
18	-0180	\$66.42	\$65.88	\$66.42	\$65.88	\$80.24
24	-0240	\$68.22	\$67.50	\$68.22	\$67.50	\$86.64
30	-0300	\$70.02	\$69.12	\$70.02	\$69.12	\$93.05
36	-0360	\$71.82	\$70.74	\$71.82	\$70.74	\$99.45
42	-0420	\$73.62	\$72.36	\$73.62	\$72.36	\$105.86
48	-0480	\$75.42	\$73.98	\$75.42	\$73.98	\$112.26
54	-0540	\$77.22	\$75.60	\$77.22	\$75.60	\$118.67
60	-0600	\$79.02	\$77.22	\$79.02	\$77.22	\$125.07
66	-0660	\$80.82	\$78.84	CALL	\$78.84	CALL
72	-0720	\$82.62	\$80.46	CALL	\$80.46	CALL
.085" Diameter SEMIRIGID and MaxiFlex Direct Solder Connectors						
LENGTH IN INCHES	DASH NUMBER	50 Ω RG 405 [Ⓞ] M17/133-00006 .085 Cu Jacket 405-M0290-	50 Ω RG 405 [Ⓞ] M17/133-00007 .085 Tin Plate Cu 8TS-M0290-	50 Ω RG 405 [Ⓞ] M17/133-00013 .085 Tin Plate Al 8AT-M0290-	50 Ω MaxiFlex (No QPL List) .085 Tin Plate Braid 08F-M0290-	50 Ω RG 405 [Ⓞ] M17/133-00016 .085 Silver Plate Cu 8SS-M0290-
12	-0120	\$58.27	\$58.27	\$59.21	\$59.50	\$63.46
18	-0180	\$59.78	\$59.78	\$61.19	\$61.63	\$67.57
24	-0240	\$61.29	\$61.29	\$63.17	\$63.75	\$71.67
30	-0300	\$62.80	\$62.80	\$65.15	\$65.88	\$75.78
36	-0360	\$64.31	\$64.31	\$67.13	\$68.00	\$79.88
42	-0420	\$65.82	\$65.82	\$69.11	\$70.13	\$83.99
48	-0480	\$67.33	\$67.33	\$71.09	\$72.25	\$88.09
54	-0540	\$68.84	\$68.84	\$73.07	\$74.38	\$92.20
60	-0600	\$70.35	\$70.35	\$75.05	\$76.50	\$96.30
66	-0660	\$71.86	\$71.86	CALL	\$78.63	CALL
72	-0720	\$73.37	\$73.37	CALL	\$80.75	CALL

ⓄSilver Plated Copper Center Conductor ⓄSilver Plated Copper Clad Steel Center Conductor

10% Discount @ 25 pcs. up 4% Discount @ 10 pcs. up



SMA Male Plug x 7-16 Male Plug

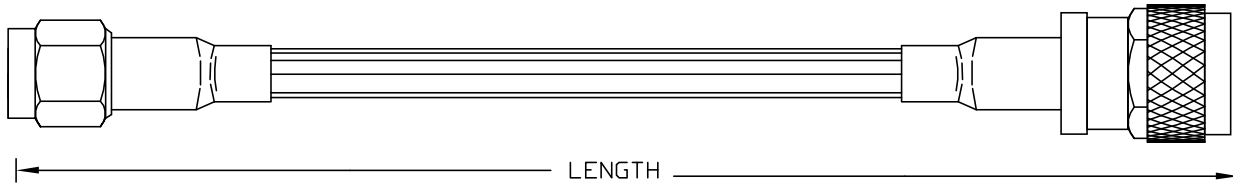

LTH IN INS	DASH NUM	50 Ω RG 58C ①② 2 shields⑦ 058-MA716A-	50 Ω RG 142 ①② 1 shield⑦ 142-MA716A-	50 Ω RG 223 ①① 2 shields⑦ 223-MA716A-	50 Ω④ RD 316 ②⑦ 2 shields 31D-MA716A-	50 Ω SF 142B② 3 shields③ S42-MA716A-	50 Ω RG 400④① 2 shields⑦ 400-MA716A-
Solder Center, Crimp Outer with Strain Relief							
12	-0120	\$50.83	\$54.02	\$53.19	\$50.76	\$58.04	\$54.72
24	-0240	\$51.23	\$56.32	\$54.66	\$52.61	\$64.36	\$57.72
36	-0360	\$51.63	\$58.62	\$56.13	\$54.46	\$70.68	\$60.72
48	-0480	\$52.03	\$60.92	\$57.60	\$56.31	\$77.00	\$63.72
60	-0600	\$52.43	\$63.22	\$59.07	\$58.16	\$83.32	\$66.72
72	-0720	\$52.83	\$65.52	\$60.54	\$60.01	\$89.64	\$69.72
SEMIRIGID Direct Solder Connectors							
LTH IN INS	DASH NUM	50 Ω RG402② M17/130-00005 .141 Tin Plate Cu 1TS-MA716A-	50 Ω MaxiFlex (No QPL List) .141 Tin Pl 14F-MA716A-	50 Ω RG402② M17/130-00004 .141 Cu Jacket 402-MA716A-	50 Ω RG402① M17/130-00009 .141 Tin Plate Al 1AT-MA716A-	50 Ω RG402② M17/130-00012 .141 Silver Pl 1SS-MA716A-	
12	-0120	\$64.21	\$64.21	\$64.57	\$64.57	\$73.78	
24	-0240	\$67.45	\$67.45	\$68.17	\$68.17	\$86.59	
36	-0360	\$70.69	\$70.69	\$71.77	\$71.77	\$99.40	
48	-0480	\$73.93	\$73.93	\$75.37	\$75.37	\$112.21	
60	-0600	\$77.17	\$77.17	\$78.97	\$78.97	\$125.02	
72	-0720	\$80.41	\$80.41	\$82.57	CALL	CALL	
SEMIRIGID Direct Solder Connectors							
LTH IN INS	DASH NUM	50 Ω RG405② M17/133-00006 .085 Cu Jacket 405-MA716A-	50 Ω RG405② M17/133-00007 .085 Tin Pl Cu 8TS-MA716A-	50 Ω RG405② M17/133-00013 .085 Tin Plate Al 8AT-MA716A-	50Ω MaxiFlex② (No QPL List) .085 Tin Pl Braid 08F-MA716A-	50 Ω RG405② M17/133-00016 .085 Silver Plate Cu 8SS-MA716A-	
12	-0120	\$63.99	\$63.99	\$64.93	\$65.22	\$69.18	
24	-0240	\$67.01	\$67.01	\$68.89	\$69.47	\$77.39	
36	-0360	\$70.03	\$70.03	\$72.85	\$73.72	\$85.60	
48	-0480	\$73.05	\$73.05	\$76.81	\$77.97	\$93.81	
60	-0600	\$76.07	\$76.07	\$80.77	\$82.22	\$102.02	
72	-0720	CALL	\$86.47	CALL	\$110.23	CALL	
Color Designators (add letter to the end of the part number and add \$1.00 to price)							
Black - B		Blue - L		Brown - N		Gray - A	
Orange - O		Red - R		Violet - V		Green - G	
						White - W	

See Page B5 for Cable Characteristics

* Contact Factory for delivery, Consider new RD316 for (RD188) 10% Discount @ 25 pcs. up 4% Discount @ 10 pcs. up

①Silver Plated Copper Center Conductor ②Silver Plated Copper Clad Steel Center Conductor



RF Depot.com Inc.

Phone 856-488-2000 Fax 856-488-2020

SMA Male Plug x 7-16 Male Plug Commercial

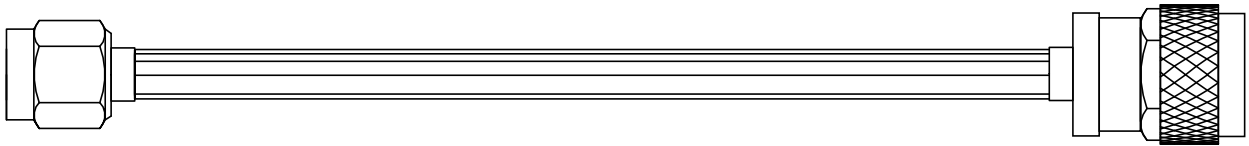

←————— LENGTH —————→

LENGTH IN INCHES	DASH NUMBER	50Ω RG 401 [Ⓛ] M17/129-RG401 .250 Cu Jacket 401-MA716A-	50Ω RG 401 [Ⓛ] (No QPL List) .250 Tin Plate Al 25A-MA716A-	50 Ω RG 401 [Ⓜ] M17/129-00001 .250 Tin Plate Cu 2TS-MA716A-	50 Ω MaxiFlex [Ⓛ] (No QPL List) .250 Tin Plate Braid 25F-MA716A-	
SEMIRIGID direct Solder Connectors						
12	-0120C	\$72.12	\$73.06	\$72.12	\$73.06	
24	-0240C	\$75.14	\$77.02	\$75.14	\$77.02	
36	-0360C	\$78.16	\$80.98	\$78.16	\$80.98	
48	-0480C	\$81.18	\$84.94	\$81.18	\$84.94	
60	-0600C	\$84.20	\$88.90	\$84.20	\$88.90	
72	-0720C	\$87.22	\$92.86	\$87.22	\$92.86	
SEMIRIGID direct Solder Connectors						
LENGTH IN INCHES	DASH NUMBER	50Ω RG 402 [Ⓜ] M17/130-00004 .141 Cu Jacket 402-MA716A-	50 Ω RG 402 [Ⓜ] M17/130-00005 .141 Tin Pl Cu 1TS-MA716A-	50 Ω MaxiFlex (No QPL List) .141 Tin Pl 14F-MA716A-	50Ω RG 402 [Ⓛ] M17/130-00009 .141 Tin Pl Al 1AT-MA716A-	50Ω RG 402 [Ⓜ] M17/130-00012 .141 Silver Pl 1SS-MA716A-
12	-0120C	\$61.46	\$61.10	\$66.42	\$61.46	\$70.67
24	-0240C	\$65.06	\$64.34	\$69.66	\$65.06	\$83.48
36	-0360C	\$68.66	\$67.58	\$72.90	\$68.66	\$96.29
48	-0480C	\$72.26	\$70.82	\$76.14	\$72.26	\$109.10
60	-0600C	\$75.86	\$74.06	\$79.38	\$75.86	\$121.91
72	-0720C	\$79.46	\$77.30	\$82.62	\$79.46	\$134.72
SEMIRIGID direct Solder Connectors						
LENGTH IN INCHES	DASH NUMBER	50Ω RG 405 [Ⓜ] M17/133-00006 .085 Cu Jacket 405-MA716A-	50 Ω RG 405 [Ⓜ] M17/133-00007 .085 Tin Plate Cu 8TS-MA716A-	50Ω RG 405 [Ⓜ] M17/133-00013 .085 Tin Plate Al 8AT-MA716A-	50Ω MaxiFlex [Ⓜ] (No QPL List) .085 Tin Pl 08F-MA716A-	50Ω RG 405 [Ⓜ] M17/133-00016 .085 Silver Pl 8SS-MA716A-
12	-0120C	\$63.32	\$63.32	\$64.26	\$64.55	\$68.51
24	-0240C	\$66.34	\$66.34	\$68.22	\$68.80	\$76.72
36	-0360C	\$69.36	\$69.36	\$72.18	\$73.05	\$84.93
48	-0480C	\$72.38	\$72.38	\$76.14	\$77.30	\$93.14
60	-0600C	\$75.40	\$75.40	\$80.10	\$81.55	\$101.35
72	-0720C	\$78.42	\$78.42	CALL	\$85.80	CALL

Ⓛ Silver Plated Copper Center Conductor Ⓜ Silver Plated Copper Clad Steel Center Conductor

10% Discount @ 25 pcs. up 4% Discount @ 10 pcs. up



SMA Male Plug x 7-16 Male Plug Commercial

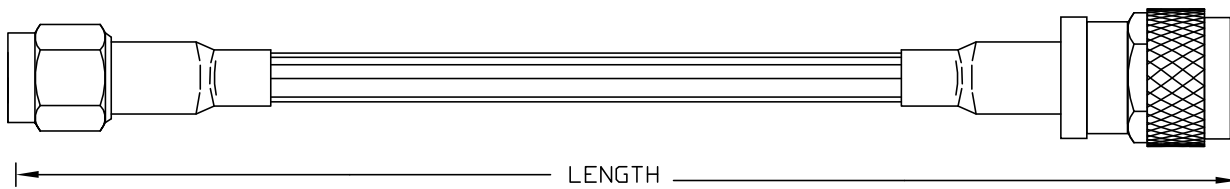

LTH IN INS	DASH NUMBER	50 Ω RG 58C ③⑥ 2 shields⑦ 058-MA716A-	50 Ω RG 223③① 2 shields⑦ 223-MA716A-	50 Ω RG 142B ④② 2 shields⑦ 142-MA716A-	50 Ω RG 400*④① 2 shields⑦ 400-MA716A-	50 Ω RG 213 ③③ 1 shield⑥ 213-MA716A-	50 Ω RG 214 ③① 2 shields⑦ 214-MA716A-
Solder Center, Crimp Outer with Strain Relief							
12	-0120C	\$47.41	\$51.53	\$52.36	\$53.06	\$63.28	\$56.31
24	-0240C	\$47.81	\$53.00	\$54.66	\$56.06	\$64.86	\$59.81
36	-0360C	\$48.21	\$54.47	\$56.96	\$59.06	\$66.44	\$63.31
48	-0480C	\$48.61	\$55.94	\$59.26	\$62.06	\$68.02	\$66.81
60	-0600C	\$49.01	\$57.41	\$61.56	\$65.06	\$69.60	\$70.31
72	-0720C	\$49.41	\$58.88	\$63.86	\$68.06	\$71.18	\$73.81
Solder Center, Crimp Outer with Strain Relief							
LENGTH IN INCHES	DASH NUMBER	50 Ω RG 174 ③⑤ 1 shield⑦ 174-MA716A-	50 Ω RG 316 ④② 1 shield⑩ 316-MA716A-	50 Ω RD 316 ④②⑦ 2 shields 31D-MA716A-	50 Ω RG188* ④③ 1 shield 188-MA716A-	50 Ω RG 393④① 2 shields⑦ 393-MA716A-	
12	-0120C	\$49.15	\$51.11	\$50.76	\$51.46	\$61.44	
24	-0240C	\$49.39	\$51.76	\$52.61	\$52.46	\$70.07	
36	-0360C	\$49.63	\$52.41	\$54.46	\$53.46	\$78.70	
48	-0480C	\$49.87	\$53.06	\$56.31	\$54.46	\$87.33	
60	-0600C	\$50.11	\$53.71	\$58.16	\$55.46	\$95.96	
72	-0720C	\$50.35	\$54.36	\$60.01	\$56.46	\$104.59	
Solder Center, Crimp Outer with Strain Relief							
LTH IN INS	DASH NUM	50 Ω SIG 200 ①③ 2 shields⑨ 2LC-MA716A-	50 Ω LMR 200①③ 2 shields⑨ 2LM-MA716A-	50 Ω SIG 240 ①③ 2 shields⑨ 24S-MA716A-	50 Ω③ LMR 240 ① 2 shields⑨ 24L-MA716A-	50 Ω SIG 400①④ 2 shields⑨ 4LC-MA716A-	50 Ω LMR 400①④ 2 shields⑨ 4LM-MA716A-
12	-0120C	\$70.93	\$70.98	\$51.84	\$52.26	\$73.26	\$73.78
24	-0240C	\$71.61	\$71.71	\$52.44	\$53.28	\$74.12	\$75.16
36	-0360C	\$72.29	\$72.44	\$53.04	\$54.30	\$74.98	\$76.54
48	-0480C	\$72.97	\$73.17	\$53.64	\$55.32	\$75.84	\$77.92
60	-0600C	\$73.65	\$73.90	\$54.24	\$56.34	\$76.70	\$79.30
72	-0720C	\$74.33	\$74.63	\$54.84	\$57.36	\$77.56	\$80.68
Color Designators (add letter to the end of the part number and add \$1.00 to price)							
Black - B		Blue - L		Brown - N		Gray - A	
Orange - O		Red - R		Violet - V		Green - G	
						White - W	

See Page B5 for Cable Characteristics

* Contact Factory for delivery, Consider new RD316 for (RD188) 10% Discount @ 25 pcs. up 4% Discount @ 10 pcs. up



RF Depot.com Inc.

Phone 856-488-2000 Fax 856-488-2020

B170

7850 Browning Rd. Pennsauken, NJ 08109

Online @ www.rfdepot.com

Toll Free 877-RF Depot

SMA Reverse Polarity Bulkhead Jack x SMA Reverse Polarity Plug



LTH IN INS	DASH NUM	50 Ω RG 58C ③⑥ 1 shield⑦ 058-MMMW-	50 Ω RG 174 ③⑤ 1 shield⑦ 174-MMMW-	50 Ω RG188* ④③ 1 shield 188-MMMW-	50 Ω RG 316 ④② 1 shield⑩ 316-MMMW-	50 Ω④ RD 316 ②⑦ 2 shields 31D-MMMW-	50 Ω RG 223 ③① 2 shields⑦ 223-MMMW-	50 Ω RG 178② 2 shields ⑩ 178-MMMW-
Solder Center, Crimp Outer with Strain Relief								
12	-0120	\$23.20	\$26.04	\$26.80	\$26.45	\$27.65	\$28.12	\$23.68
24	-0240	\$23.60	\$26.28	\$27.80	\$27.10	\$29.50	\$29.59	\$24.42
36	-0360	\$24.00	\$26.52	\$28.80	\$27.75	\$31.35	\$31.06	\$25.16
48	-0480	\$24.40	\$26.76	\$29.80	\$28.40	\$33.20	\$32.53	\$25.90
60	-0600	\$24.80	\$27.00	\$30.80	\$29.05	\$35.05	\$34.00	\$26.64
72	-0720	\$25.20	\$27.24	\$31.80	\$29.70	\$36.90	\$35.47	\$27.38

SMA Reverse Polarity Bulkhead Jack x TNC Male Plug

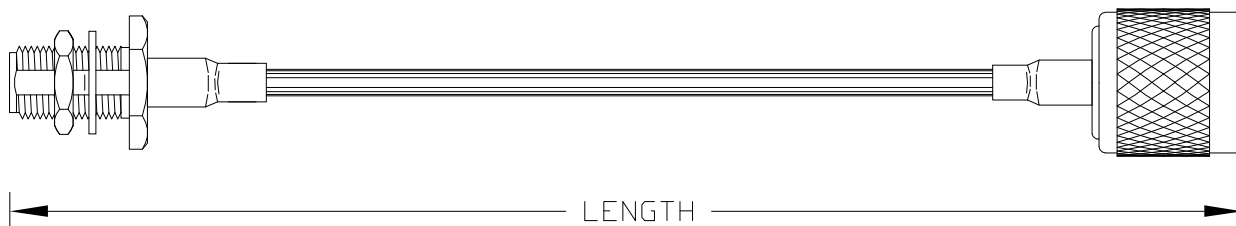

LTH IN INS	DASH NUM	50 Ω RG 58C ③⑥ 1 shield⑦ 058-MWTA-	50 Ω RG 174 ③⑤ 1 shield⑦ 174-MWTA-	50 Ω RG188* ④③ 1 shield 188-MWTA-	50 Ω RG 223③① 2 shields⑦ 223-MWTA-	50 Ω RG 316④② 1 shield⑩ 316-MWTA-	50 Ω RD 316 ④②⑦ 2 shields 31D-MWTA-	50 Ω RG 178② 2 shields ⑩ 178-MWTA-
Solder Center, Crimp Outer with Strain Relief								
12	-0120	\$22.44	\$23.70	\$24.46	\$26.83	\$24.11	\$25.31	\$21.65
24	-0240	\$22.84	\$23.94	\$25.46	\$28.30	\$24.76	\$27.16	\$22.39
36	-0360	\$23.24	\$24.18	\$26.46	\$29.77	\$25.41	\$29.01	\$23.13
48	-0480	\$23.64	\$24.42	\$27.46	\$31.24	\$26.06	\$30.86	\$23.87
60	-0600	\$24.04	\$24.66	\$28.46	\$32.71	\$26.71	\$32.71	\$24.61
72	-0720	\$24.44	\$24.90	\$29.46	\$34.18	\$27.36	\$34.56	\$25.35
Color Designators (add letter to the end of the part number and add \$1.00 to price)								
Black - B		Blue - L		Brown - N		Gray - A		Green - G
Orange - O		Red - R		Violet - V		Yellow - Y		White - W

See Page B5 for Cable Characteristics

* Contact Factory for delivery, Consider new RD316 for (RD188)

10% Discount @ 25 pcs. up

4% Discount @ 10 pcs. up

SMA Reverse Polarity Jack x SMA Reverse Polarity Plug

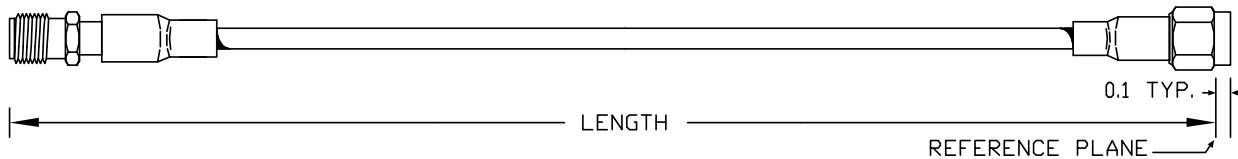

LENGTH IN INCHES	DASH NUMBER	50 Ω RG 58C ③⑥ 1 shield⑦ 058-MMMN-	50 Ω RG 174 ③⑤ 1 shield⑦ 174-MMMN-	50 Ω RG188* ④③ 1 shield 188-MMMN-	50 Ω RG 316 ④② 1 shield⑩ 316-MMMN-	50 Ω RD 316 ④② 2 shields⑦ 31D-MMMN-	50 Ω RG 223③① 2 shields⑦ 223-MMMN-
Solder Center, Crimp Outer with Strain Relief							
12	-0120	\$23.06	\$26.18	\$26.94	\$26.59	\$27.79	\$28.54
24	-0240	\$23.46	\$26.42	\$27.94	\$27.24	\$29.64	\$30.01
36	-0360	\$23.86	\$26.66	\$28.94	\$27.89	\$31.49	\$31.48
48	-0480	\$24.26	\$26.90	\$29.94	\$28.54	\$33.34	\$32.95
60	-0600	\$24.66	\$27.14	\$30.94	\$29.19	\$35.19	\$34.42
72	-0720	\$25.06	\$27.38	\$31.94	\$29.84	\$37.04	\$35.89

SMA Reverse Polarity Plug x SMA Reverse Polarity Plug

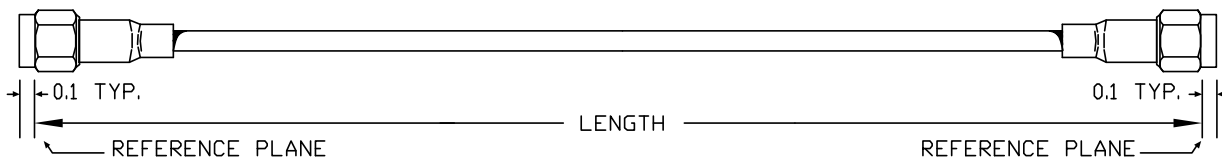

LTH IN INS	DASH NUM	50 Ω RG 58C ③⑥ 1 shield⑦ 058-MMMM-	50 Ω RG 174 ③⑤ 1 shield⑦ 174-MMMM-	50 Ω RG188* ④③ 1 shield 188-MMMM-	50 Ω RG 223 ③① 2 shields⑦ 223-MMMM-	50 Ω RG 316④② 1 shield⑩ 316-MMMM-	50 Ω④ RD 316 ②⑦ 2 shields 31D-MMMM-	50 Ω RG 178② 2 shields ⑩ 178-MMMM-
Solder Center, Crimp Outer with Strain Relief								
12	-0120	\$22.70	\$23.40	\$24.16	\$37.45	\$23.81	\$25.01	\$27.66
24	-0240	\$23.10	\$23.64	\$25.16	\$38.92	\$24.46	\$26.86	\$28.40
36	-0360	\$23.50	\$23.88	\$26.16	\$40.39	\$25.11	\$28.71	\$29.14
48	-0480	\$23.90	\$24.12	\$27.16	\$41.86	\$25.76	\$30.56	\$29.88
60	-0600	\$24.30	\$24.36	\$28.16	\$43.33	\$26.41	\$32.41	\$30.62
72	-0720	\$24.70	\$24.60	\$29.16	\$44.80	\$27.06	\$34.26	\$31.36
Color Designators (add letter to the end of the part number and add \$1.00 to price)								
Black - B		Blue - L		Brown - N		Gray - A		Green - G
Orange - O		Red - R		Violet - V		Yellow - Y		White - W

See Page B5 for Cable Characteristics

* Contact Factory for delivery, Consider new RD316 for (RD188) 10% Discount @ 25 pcs. up 4% Discount @ 10 pcs. up

SMA Reverse Polarity Male Plug x TNC Male Plug

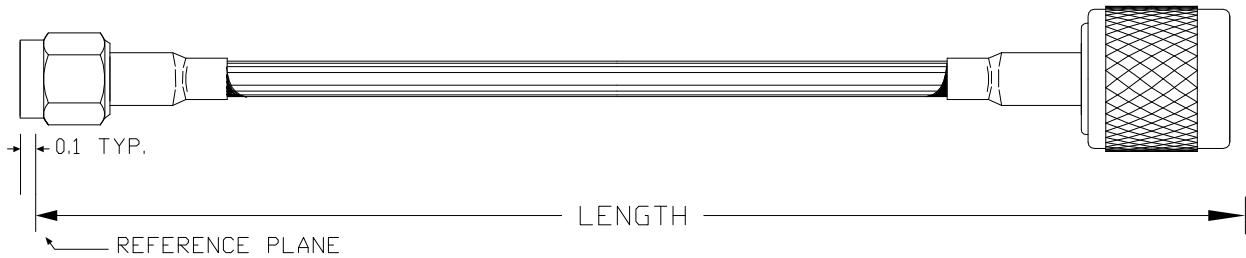

LENGTH IN INCHES	DASH NUMBER	50 Ω RG 58C ③⑥ 1 shield⑦ 058-MMTA-	50 Ω RG 223 ③⑩ 2 shields⑦ 223-MMTA-	50 Ω RG 142 ④② 2 shields⑦ 142-MMTA-	50 Ω RG 178② 2 shields⑩ 178-MMTA-				
Solder Center, Crimp Outer with Strain Relief									
12	-0120	\$21.94	\$30.18	\$31.01	\$32.70				
24	-0240	\$22.34	\$31.65	\$33.31	\$33.44				
36	-0360	\$22.74	\$33.12	\$35.61	\$34.18				
48	-0480	\$23.14	\$34.59	\$37.91	\$34.92				
60	-0600	\$23.54	\$36.06	\$40.21	\$35.66				
Solder Center, Crimp Outer with Strain Relief									
LENGTH IN INCHES	DASH NUMBER	50 Ω RG 174 ③⑤ 1 shield⑦ 174-MMTA-	50 Ω RG 316④② 1 shield⑩ 316-MMTA-	50 Ω RD 316 ④② 2 shields⑦ 31D-MMTA-	50 Ω SIG 200①③ 2 shields⑨ 2LC-MMTA-	50 Ω LMR 200①③ 2 shields⑨ 2LM-MMTA-			
12	-0120	\$26.76	\$27.14	\$28.34	\$19.78	\$19.83			
24	-0240	\$27.00	\$27.79	\$30.19	\$20.46	\$20.56			
36	-0360	\$27.24	\$28.44	\$32.04	\$21.14	\$21.29			
48	-0480	\$27.48	\$29.09	\$33.89	\$21.82	\$22.02			
60	-0600	\$27.72	\$29.74	\$35.74	\$22.50	\$22.75			
Solder Center, Crimp Outer with Strain Relief									
LENGTH IN INCHES	DASH NUMBER	50 Ω RG188* ④③ 1 shield 188-MA716A-	50 Ω SIG 240 ①③ 2 shields⑨ 24S-MMTA-	50 Ω③ LMR 240① 2 shields⑨ 24L-MMTA-	50 Ω SIG 400①④ 2 shields⑨ 4LC-MMTA-	50 Ω LMR 400①④ 2 shields⑨ 4LM-MMTA-			
24	-0240	\$28.52	\$24.02	\$24.86	\$29.64	\$30.68			
36	-0360	\$29.52	\$24.62	\$25.88	\$30.50	\$32.06			
48	-0480	\$30.52	\$25.22	\$26.90	\$31.36	\$33.44			
60	-0600	\$31.52	\$25.82	\$27.92	\$32.22	\$34.82			
72	-0720	\$32.52	\$26.42	\$28.94	\$33.08	\$36.20			
Color Designators (add letter to the end of the part number and add \$1.00 to price)									
Black - B		Blue - L		Brown - N		Gray - A		Green - G	
Orange - O		Red - R		Violet - V		Yellow - Y		White - W	

See Page B5 for Cable Characteristics

* Contact Factory for delivery, Consider new RD316 for (RD188) 10% Discount @ 25 pcs. up 4% Discount @ 10 pcs. up

SMA Reverse Thread Plug x SMA Reverse Thread Plug

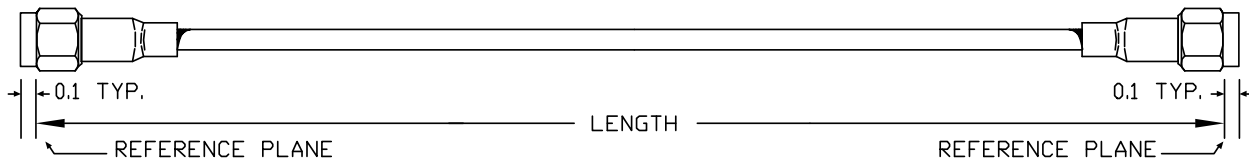

LENGTH IN INCHES	DASH NUMBER	50 Ω RG 58C ^{①②} 1 shield ^⑦ 058-MRAMRA-	50 Ω RG 223 ^{①①} 2 shields ^⑦ 223-MRAMRA-	50 Ω RG 142 ^{④②} 2 shields ^⑦ 142-MRAMRA-	50 Ω RG 178 ^② 2 shields ^⑧ 178-MRAMRA-		
Solder Center, Crimp Outer with Strain Relief							
12	-0120	\$20.82	\$24.29	\$25.12	\$25.26		
24	-0240	\$21.22	\$25.76	\$27.42	\$26.00		
36	-0360	\$21.62	\$27.23	\$29.72	\$26.74		
48	-0480	\$22.02	\$28.70	\$32.02	\$27.48		
60	-0600	\$22.42	\$30.17	\$34.32	\$28.22		
72	-0720	\$22.82	\$31.64	\$36.62	\$28.96		
Solder Center, Crimp Outer with Strain Relief							
LENGTH IN INCHES	DASH NUMBER	50 Ω RG 174 ^{①⑤} 1 shield ^⑦ 174-MRAMRA-	50 Ω RG 316 ^{④②} 1 shield ^⑧ 316-MRAMRA-	50 Ω RD 316 ^{④②⑦} 2 shields 31D-MRAMRA-	50 Ω RG188* ^{④③} 1 shield 188-MRAMRA-		
12	-0120	\$20.48	\$20.89	\$22.09	\$21.24		
24	-0240	\$20.72	\$21.54	\$23.94	\$22.24		
36	-0360	\$20.96	\$22.19	\$25.79	\$23.24		
48	-0480	\$21.20	\$22.84	\$27.64	\$24.24		
60	-0600	\$21.44	\$23.49	\$29.49	\$25.24		
72	-0720	\$21.68	\$24.14	\$31.34	\$26.24		
Solder Center, Crimp Outer with Strain Relief							
LTH IN INS	DASH NUM	50 Ω SIG 240 ^{①③} 2 shields ^⑧ 24C-MRAMRA-	50 Ω LMR 240 ^{①③} 2 shields ^⑧ 24L-MRAMRA-	50 Ω ^③ SIG 240UF ^① 2 shields ^⑧ 2U4-MRAMRA-	50 Ω ^③ LMR 240UF ^① 2 shields ^⑧ 24U-MRAMRA-	50 Ω ^③ SIG 240FR ^① 2 shields ^⑧ 24F-MRAMRA-	50 Ω ^③ LMR 240FR ^① 2 shields ^⑧ 24R-MRAMRA-
12	-0120C	\$26.96	\$27.38	\$27.02	\$27.54	\$27.10	\$27.58
24	-0240C	\$27.56	\$28.40	\$27.68	\$28.72	\$27.84	\$28.80
36	-0360C	\$28.16	\$29.42	\$28.34	\$29.90	\$28.58	\$30.02
48	-0480C	\$28.76	\$30.44	\$29.00	\$31.08	\$29.32	\$31.24
60	-0600C	\$29.36	\$31.46	\$29.66	\$32.26	\$30.06	\$32.46
72	-0720C	\$29.96	\$32.48	\$30.32	\$33.44	\$30.80	\$33.68
Color Designators (add letter to the end of the part number and add \$1.00 to price)							
Black - B		Blue - L		Brown - N		Gray - A	
Orange - O		Red - R		Violet - V		Green - G	
						White - W	

See Page B5 for Cable Characteristics

* Contact Factory for delivery, Consider new RD316 for (RD188) 10% Discount @ 25 pcs. up 4% Discount @ 10 pcs. up



RF Depot.com Inc.

Phone 856-488-2000 Fax 856-488-2020

B174

7850 Browning Rd. Pennsauken, NJ 08109

Online @ www.rfdepot.com

Toll Free 877-RF Depot

SMA Right Angle Male Plug x SMA Right Angle Male Plug

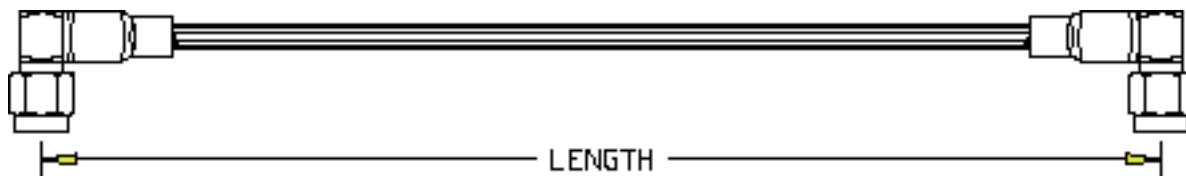

LENGTH IN INCHES	DASH NUMBER	50 Ω RG 58C ^{③⑥} 1 shield ^⑦ 058-MCMC-	50 Ω RG 223 ^{③①} 2 shields ^⑦ 223-MCMC-	50 Ω RG 142B ^{④②} 2 shields ^⑦ 142-MCMC-	50 Ω RG 400 ^{✕④①} 2 shields ^⑦ 400-MCMC-	50 Ω CCS 195 ^{①③} 2 shields ^⑧ 19C-MCMC-	50 Ω LMR 195 ^{①③} 2 shields ^⑧ 19M-MCMC-
Solder Center, Crimp Outer with Strain Relief							
12	-0120	\$47.66	\$39.11	\$39.94	\$40.64	\$33.73	\$33.87
24	-0240	\$48.06	\$40.58	\$42.24	\$43.64	\$34.30	\$34.58
36	-0360	\$48.46	\$42.05	\$44.54	\$46.64	\$34.87	\$35.29
48	-0480	\$48.86	\$43.52	\$46.84	\$49.64	\$35.44	\$36.00
60	-0600	\$49.26	\$44.99	\$49.14	\$52.64	\$36.01	\$36.71
72	-0720	\$49.66	\$46.46	\$51.44	\$55.64	\$36.58	\$37.42
Solder Center, Crimp Outer with Strain Relief (Brass Connectors for RG 59)							
LENGTH IN INCHES	DASH NUMBER	50 Ω RG 174 ^{③⑤} 1 shield ^⑦ 174-MCMC-	50 Ω RG 316 ^{④②} 1 shield ^⑧ 316-MCMC-	50 Ω RD 316 ^{④②} 2 shields ^⑦ 31D-MCMC-	50 Ω RG188 ^{✕④③} 1 shield ^⑧ 188-MCMC-	75 Ω RG 179A ^{④②} 1 shield ^⑧ 179-MCMC-	75 Ω ^⑤ RG 59B ^⑤ 1 shield ^⑧ 059-MCMC-
12	-0120	\$46.32	\$46.73	\$33.75	\$47.08	\$46.81	\$29.28
24	-0240	\$46.56	\$47.38	\$35.60	\$48.08	\$47.54	\$29.72
36	-0360	\$46.80	\$48.03	\$37.45	\$49.08	\$48.27	\$30.16
48	-0480	\$47.04	\$48.68	\$39.30	\$50.08	\$49.00	\$30.60
60	-0600	\$47.28	\$49.33	\$41.15	\$51.08	\$49.73	\$31.04
72	-0720	\$47.52	\$49.98	\$43.00	\$52.08	\$50.46	\$31.48
Solder Center, Crimp and Clamp Outer, Commercial (Brass) SMA							
LENGTH IN INCHES	DASH NUM	50 Ω ^⑤ CCS 100 ^① 2 shields ^⑧ 1LC-MCMC-	50 Ω ^⑤ LMR 100 ^① 2 shields ^⑧ 1LM-MCMC-	50 Ω ^③ CCS 195 ^① 2 shields ^⑧ 19C-MCMC-	50 Ω ^③ LMR 195 ^① 2 shields ^⑧ 19M-MCMC-	50 Ω ^③ CCS 240 ^① 2 shields ^⑧ 24C-MCMC-	50 Ω ^③ LMR 240 ^① 2 shields ^⑧ 24L-MCMC-
12	-0120C	\$31.23	\$31.35	\$34.89	\$35.03	\$41.94	\$42.36
24	-0240C	\$31.77	\$32.01	\$35.46	\$35.74	\$42.54	\$43.38
36	-0360C	\$32.31	\$32.67	\$36.03	\$36.45	\$43.14	\$44.40
48	-0480C	\$32.85	\$33.33	\$36.60	\$37.16	\$43.74	\$45.42
60	-0600C	\$33.39	\$33.99	\$37.17	\$37.87	\$44.34	\$46.44
72	-0720C	\$33.93	\$34.65	\$37.74	\$38.58	\$44.94	\$47.46
Color Designators (add letter to the end of the part number and add \$1.00 to price)							
Black - B		Blue - L		Brown - N		Gray - A	
Orange - O		Red - R		Violet - V		Green - G	
						White - W	

See Page B5 for Cable Characteristics

* Contact Factory for delivery, Consider new RD316 for (RD188)

10% Discount @ 25 pcs. up

4% Discount @ 10 pcs. up

SMA Right Angle Male Plug x SMA Right Angle Male Plug

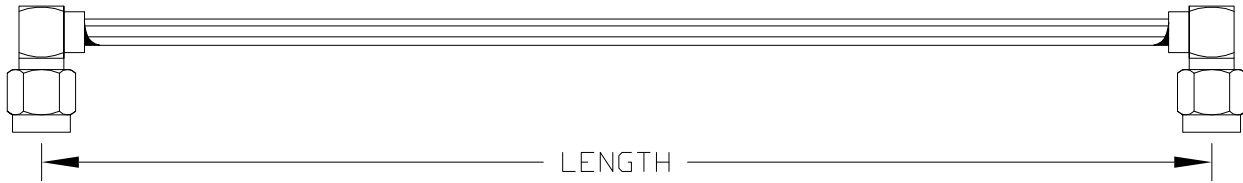

LTH IN INS	DASH NUM	50Ω RG 402Ⓢ M17/130-00004 .141 Cu Jacket 402-M2M2-	50Ω RG 402Ⓣ M17/130-00009 .141 Tin Plate Al 1AT-M2M2-	50Ω RG 402Ⓡ M17/130-00012 .141 Silver Pl 1SS-M2M2-	50Ω RG 402Ⓡ M17/130-00005 .141 Tin Pl Cu 1TS-M2M2-	50Ω MaxiFlex (No QPL List) .141 Tin Pl 14F-M2M2-
SEMIRIGID Direct Solder Crimp/Clamp Connectors						
12	-0120E	\$54.09	\$54.09	\$63.30	\$53.73	\$53.73
24	-0240E	\$57.69	\$57.69	\$76.11	\$56.97	\$56.97
36	-0360E	\$61.29	\$61.29	\$88.92	\$60.21	\$60.21
48	-0480E	\$64.89	\$64.89	\$101.73	\$63.45	\$63.45
60	-0600E	\$68.49	\$68.49	\$114.54	\$66.69	\$66.69
72	-0720E	\$72.09	CALL	CALL	\$69.93	\$69.93
SEMIRIGID and MaxiFlex Direct Solder Crimp/Clamp Connectors						
LTH IN INS	DASH NUMBER	50Ω RG 405Ⓢ M17/133-00006 .085 Cu Jacket 405-M2M2-	50Ω RG 405Ⓣ M17/133-00013 .085 Tin Plate Al 8AT-M2M2-	50Ω RG 405Ⓡ M17/133-00007 .085 Tin Plate Cu 8TS-M2M2-	50Ω MaxiFlex (No QPL List) .085 Tin Pl 08F-M2M2-	50Ω RG 405Ⓡ M17/133-00016 .085 Silver Pl 8SS-M2M2-
12	-0120E	\$53.51	\$54.45	\$53.51	\$54.74	\$58.70
24	-0240E	\$56.53	\$58.41	\$56.53	\$58.99	\$66.91
36	-0360E	\$59.55	\$62.37	\$59.55	\$63.24	\$75.12
48	-0480E	\$62.57	\$66.33	\$62.57	\$67.49	\$83.33
60	-0600E	\$65.59	\$70.29	\$65.59	\$71.74	\$91.54
72	-0720E	\$68.61	CALL	\$68.61	\$75.99	CALL
SEMIRIGID and MaxiFlex Direct Solder Connectors						
LTH IN INS	DASH NUM	50Ω MaxiFlex Non-Magnetic .85 Tin Pl 08J-M2M2-	50Ω Ⓢ M17/151-00001 .047 Cu Jacket 4CU-M2M2-	50Ω Ⓡ (No QPL List) .047 Tin Plate Al 4AT-M2M2-	50Ω RG 402Ⓡ M17/151-00002 .047 Tin Plate Cu 4TS-M2M2-	50Ω MaxiFlexⓈ (No QPL List) .047 Tin Pl 04F-M2M2-
12	-0120	\$54.30	\$87.20	\$88.65	\$87.20	\$87.90
24	-0240	\$58.11	\$91.00	\$93.90	\$91.00	\$92.40
36	-0360	\$61.92	\$94.80	\$99.15	\$94.80	\$96.90
48	-0480	\$65.73	\$98.60	\$104.40	\$98.60	\$101.40
60	-0600	\$69.54	\$102.40	\$109.65	\$102.40	\$105.90
72	-0720	\$73.35	\$106.20	\$114.90	\$106.20	\$110.40

Ⓢ Silver Plated Copper Center Conductor Ⓡ Silver Plated Copper Clad Steel Center Conductor

10% Discount @ 25 pcs. up 4% Discount @ 10 pcs. up



SMA Right Angle Male Plug x SMA Right Angle Male Plug Commercial

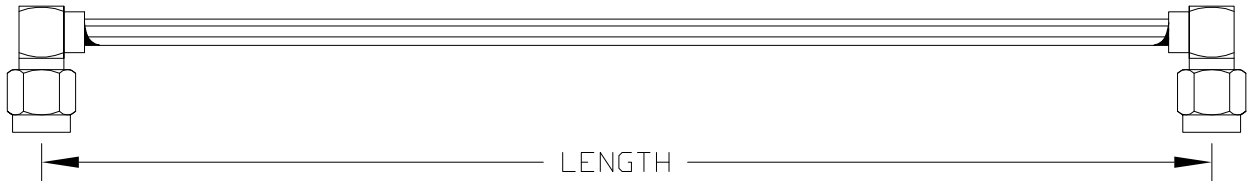

LENGTH IN INCHES	DASH NUMBER	50Ω RG 401 [Ⓛ] M17/129-RG401 .250 Cu Jacket 401-M2M2-	50Ω RG 401 [Ⓛ] (No QPL List) .250 Tin Plate Al 25A-M2M2-	50 Ω RG 401 [Ⓢ] M17/129-00001 .250 Tin Plate Cu 2TS-M2M2-	50 Ω MaxiFlex [Ⓛ] (No QPL List) .250 Tin Plate Braid 25F-M2M2-	
SEMIRIGID direct Solder Connectors						
12	-0120C	\$40.31	\$41.25	\$45.50	\$40.31	
24	-0240C	\$43.33	\$45.21	\$53.71	\$43.33	
36	-0360C	\$46.35	\$49.17	\$61.92	\$46.35	
48	-0480C	\$49.37	\$53.13	\$70.13	\$49.37	
60	-0600C	\$52.39	\$57.09	\$78.34	\$52.39	
72	-0720C	\$55.41	\$61.05	\$86.55	\$55.41	
SEMIRIGID Direct Solder Connectors						
LENGTH IN INCHES	DASH NUMBER	50Ω RG 402 [Ⓢ] M17/130-00004 .141 Cu Jacket 402-M2M2-	50Ω RG 402 [Ⓛ] M17/130-00009 .141 Tin Plate Al 1AT-M2M2-	50Ω RG 402 [Ⓢ] M17/130-00012 .141 Silver Plate Cu 1SS-M2M2-	50Ω RG 402 [Ⓢ] M17/130-00005 .141 Tin Plate Cu 1TS-M2M2-	50Ω MaxiFlex (No QPL List) .141 Tin Pl 14F-M2M2-
12	-0120C	\$41.07	\$41.07	\$50.28	\$40.71	\$40.71
24	-0240C	\$44.67	\$44.67	\$63.09	\$43.95	\$43.95
36	-0360C	\$48.27	\$48.27	\$75.90	\$47.19	\$47.19
48	-0480C	\$51.87	\$51.87	\$88.71	\$50.43	\$50.43
60	-0600C	\$55.47	\$55.47	\$101.52	\$53.67	\$53.67
72	-0720C	\$59.07	CALL	CALL	\$56.91	\$56.91
SEMIRIGID and MaxiFlex Direct Solder Connectors						
LENGTH IN INCHES	DASH NUMBER	50Ω RG 405 [Ⓢ] M17/133-00006 .085 Cu Jacket 405-M2M2-	50Ω RG 405 [Ⓢ] M17/133-00013 .085 Tin Plate Al 8AT-M2M2-	50Ω RG 405 [Ⓢ] M17/133-00007 .085 Tin Plate Cu 8TS-M2M2-	50Ω MaxiFlex (No QPL List) .085 Tin Plate Braid 08F-M2M2-	50Ω RG 405 [Ⓢ] M17/133-00016 .085 Silver Plate Cu 8SS-M2M2-
12	-0120C	\$36.92	\$37.86	\$36.92	\$38.15	\$42.11
24	-0240C	\$39.94	\$41.82	\$39.94	\$42.40	\$50.32
36	-0360C	\$42.96	\$45.78	\$42.96	\$46.65	\$58.53
48	-0480C	\$45.98	\$49.74	\$45.98	\$50.90	\$66.74
60	-0600C	\$49.00	\$53.70	\$49.00	\$55.15	\$74.95
72	-0720C	\$52.02	CALL	\$52.02	\$59.40	CALL
SEMIRIGID and MaxiFlex Direct Solder Connectors						
LENGTH IN INCHES	DASH NUMBER	50Ω [Ⓢ] M17/151-00001 .047 Cu Jacket 4CU-M2M2-	50Ω [Ⓢ] (No QPL List) .047 Tin Plate Al 4AT-M2M2-	50Ω RG 402 [Ⓢ] M17/151-00002 .047 Tin Plate Cu 4TS-M2M2-	50Ω MaxiFlex (No QPL List) .047 Tin Pl 04F-M2M2-	50Ω MaxiFlex [Ⓛ] Non-Magnetic .085 Tin Plate Cu 8CT-M2M2-
12	-0120C	\$46.91	\$48.36	\$46.91	\$47.61	\$45.29
36	-0360C	\$54.51	\$58.86	\$54.51	\$56.61	\$49.65
60	-0600C	\$62.11	\$69.36	\$62.11	\$65.61	\$54.01

[Ⓛ]Silver Plated Copper Center Conductor [Ⓢ]Silver Plated Copper Clad Steel Center Conductor

10% Discount @ 25 pcs. up 4% Discount @ 10 pcs. up

SMA Right Angle Male Plug x TNC Female Bulkhead Jack

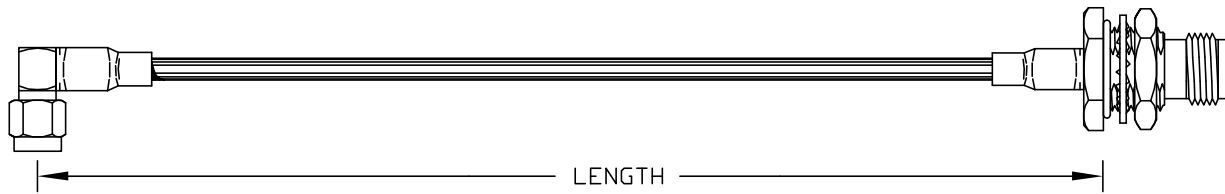

LENGTH IN INCHES	DASH NUMBER	50 Ω RG 58C ⑤⑥ 1 shield⑦ 058-MCTF-	50 Ω RG 142B ④② 2 shields⑦ 142-MCTF-	50 Ω RG 196 ②⑩ 1 shield 196-MCTF-	50 Ω RG 223 ⑤① 2 shields⑦ 223-MCTF-	50 Ω RG 179 ④② 1 shield⑩ 179-MCTF-	50 Ω RG 400*④① 2 shields⑦ 400-MCTF-
Solder Center, Crimp/Clamp Outer with Strain Relief							
12	-0120E	\$53.77	\$53.39	\$52.75	\$52.56	\$45.57	\$54.09
24	-0240E	\$54.21	\$55.69	\$53.49	\$54.03	\$46.30	\$57.09
36	-0360E	\$54.65	\$57.99	\$54.23	\$55.50	\$47.03	\$60.09
48	-0480E	\$55.09	\$60.29	\$54.97	\$56.97	\$47.76	\$63.09
60	-0600E	\$55.53	\$62.59	\$55.71	\$58.44	\$48.49	\$66.09
72	-0720E	\$55.97	\$64.89	\$56.45	\$59.91	\$49.22	\$69.09
Solder Center, Crimp Outer							
LENGTH IN INCHES	DASH NUMBER	50 Ω RG 174 ⑤⑤ 1 shield⑦ 174-MCTF-	50 Ω RG 316 ④② 1 shield⑩ 316-MCTF-	50 Ω RD 316 ④② 2 shields⑦ 31D-MCTF-	50 Ω RG188* ④③ 1 shield 188-MCTF-	50 Ω RD 188* ④② 2 shields⑦ 88D-MCTF-	50 Ω RG 178 ②⑩ 1 shield 178-MCTF-
12	-0120E	\$45.08	\$45.49	\$39.60	\$45.84	\$41.27	\$52.75
24	-0240E	\$45.32	\$46.14	\$41.45	\$46.84	\$44.79	\$53.49
36	-0360E	\$45.56	\$46.79	\$43.30	\$47.84	\$48.31	\$54.23
48	-0480E	\$45.80	\$47.44	\$45.15	\$48.84	\$51.83	\$54.97
60	-0600E	\$46.04	\$48.09	\$47.00	\$49.84	\$55.35	\$55.71
72	-0720E	\$46.28	\$48.74	\$48.85	\$50.84	\$58.87	\$56.45
Solder Center, Crimp Outer							
LENGTH IN INCHES	DASH NUMBER	50 Ω SIG 200①③ 2 shields⑨ 2LC-MCTF-	50 Ω LMR 200①③ 2 shields⑨ 2LM-MCTF-	50 Ω③ SIG 240 ① 2 shields⑨ 24S-MCTF-	50 Ω③ LMR 240 ① 2 shields⑨ 24L-MCTF-	50 Ω SIG 400①④ 2 shields⑨ 4LC-MCTF-	50 Ω LMR 400①④ 2 shields⑨ 4LM-MCTF-
12	-0120C	\$36.92	\$36.97	\$33.64	\$34.06	\$41.38	\$41.90
24	-0240C	\$37.60	\$37.70	\$34.24	\$35.08	\$42.24	\$43.28
36	-0360C	\$38.28	\$38.43	\$34.84	\$36.10	\$43.10	\$44.66
48	-0480C	\$38.96	\$39.16	\$35.44	\$37.12	\$43.96	\$46.04
60	-0600C	\$39.64	\$39.89	\$36.04	\$38.14	\$44.82	\$47.42
72	-0720C	\$40.32	\$40.62	\$36.64	\$39.16	\$45.68	\$48.80
Color Designators (add letter to the end of the part number and add \$1.00 to price)							
Black - B		Blue - L		Brown - N		Gray - A	
Orange - O		Red - R		Violet - V		Green - G	
						White - W	

See Page B5 for Cable Characteristics

* Contact Factory for delivery, Consider new RD316 for (RD188)

10% Discount @ 25 pcs. up

4% Discount @ 10 pcs. up



RF Depot.com Inc.

Phone 856-488-2000 Fax 856-488-2020

B178

7850 Browning Rd. Pennsauken, NJ 08109

Online @ www.rfdepot.com

Toll Free 877-RF Depot

SMA Right Angle Male Plug x TNC Female Bulkhead Jack

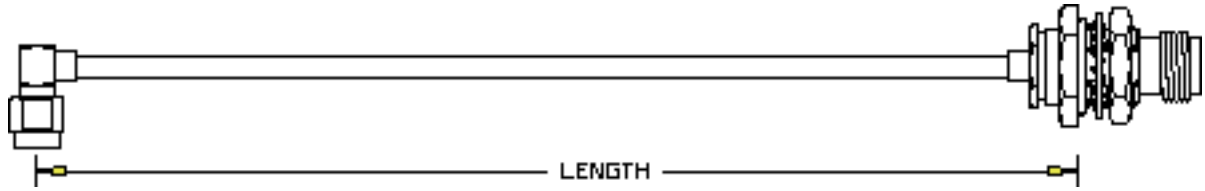

LENGTH IN INCHES	DASH NUMBER	50 Ω RG 402 M17/130-00004 .141 Cu Jacket 402-M2T5	50 Ω RG 402 M17/130-00005 .141 Tin Plate Cu 1TS-M2T5	50 Ω RG 402 ^① M17/130-00009 .141 Tin Plate Al 1AT-M2T5	50 Ω RG 402 (No QPL List) .141 Tin Pl 14F-M2T5	50 Ω RG 402 M17/130-00012 .141 Silver Pl 1SS-M2T5
.141" Diameter SEMIRIGID and MaxiFlex Direct Solder Connectors						
12	-0120E	\$46.23	\$45.87	\$46.23	\$45.87	\$55.44
18	-0180E	\$48.03	\$47.49	\$48.03	\$47.49	\$61.85
24	-0240E	\$49.83	\$49.11	\$49.83	\$49.11	\$68.25
30	-0300E	\$51.63	\$50.73	\$51.63	\$50.73	\$74.66
36	-0360E	\$53.43	\$52.35	\$53.43	\$52.35	\$81.06
42	-0420E	\$55.23	\$53.97	\$55.23	\$53.97	\$87.47
48	-0480E	\$57.03	\$55.59	\$57.03	\$55.59	\$93.87
54	-0540E	\$58.83	\$57.21	\$58.83	\$57.21	\$100.28
60	-0600E	\$60.63	\$58.83	\$60.63	\$58.83	\$106.68
66	-0660E	\$62.43	\$60.45	\$62.43	\$60.45	\$113.09
72	-0720E	\$64.23	\$62.07	CALL	\$62.07	CALL
.085" Diameter SEMIRIGID and MaxiFlex Direct Solder Connectors						
LENGTH IN INCHES	DASH NUMBER	50 Ω RG 405 ^② M17/133-00006 .085 Tin Plate Cu 405-M2T5	50 Ω RG 405 ^② M17/133-00007 .085 Tin Plate Cu 8TS-M2T5	50 Ω RG 405 ^② M17/133-00013 .085 Tin Plate Al 8AT-M2T5	50 Ω RG 405 ^② (No QPL List) .085 Tin Pl 08F-M2T5	50 Ω RG 405 ^② M17/133-00016 .085 Silver Pl 8SS-M2T5
12	-0120E	\$45.65	\$45.65	\$46.59	\$54.58	\$58.54
18	-0180E	\$47.16	\$47.16	\$48.57	\$56.71	\$62.65
24	-0240E	\$48.67	\$48.67	\$50.55	\$58.83	\$66.75
30	-0300E	\$50.18	\$50.18	\$52.53	\$60.96	\$70.86
36	-0360E	\$51.69	\$51.69	\$54.51	\$63.08	\$74.96
42	-0420E	\$53.20	\$53.20	\$56.49	\$65.21	\$79.07
48	-0480E	\$54.71	\$54.71	\$58.47	\$67.33	\$83.17
54	-0540E	\$56.22	\$56.22	\$60.45	\$69.46	\$87.28
60	-0600E	\$57.73	\$57.73	\$62.43	\$71.58	\$91.38
66	-0660E	\$59.24	\$59.24	CALL	\$73.71	CALL
72	-0720E	\$60.75	\$60.75	CALL	\$75.83	CALL

①Silver Plated Copper Center Conductor ②Silver Plated Copper Clad Steel Center Conductor

10% Discount @ 25 pcs. up 4% Discount @ 10 pcs. up



SMA Right Angle Male Plug x TNC Female Bulkhead Jack Commercial

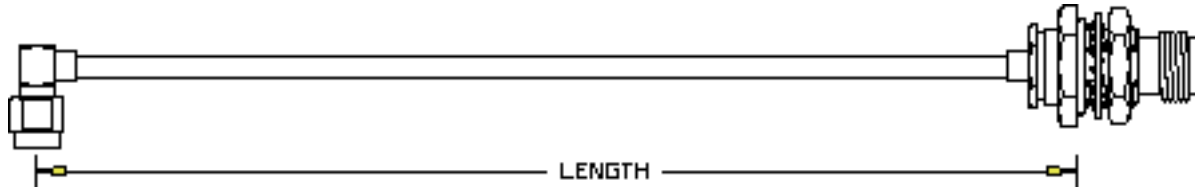

LTH IN INS	DASH NUMBER	50 Ω RG 402 M17/130-00004 .141 Cu Jacket 402-M2T5	50 Ω RG 402 M17/130-00005 .141 Tin Plate Cu 1TS-M2T5	50 Ω RG 402 [Ⓞ] M17/130-00009 .141 Tin Plate Al 1AT-M2T5	50 Ω RG 402 (No QPL List) .141 Tin Pl 14F-M2T5	50 Ω RG 402 M17/130-00012 .141 Silver Pl 1SS-M2T5	50 Ω RG 402 (No QPL List) .141 Tin Pl 14J-M2T5
.141" Diameter SEMIRIGID and MaxiFlex Direct Solder Connectors							
12	-0120EC	\$44.89	\$44.53	\$44.89	\$44.53	\$54.10	\$45.19
18	-0180EC	\$46.69	\$46.15	\$46.69	\$46.15	\$60.51	\$47.14
24	-0240EC	\$48.49	\$47.77	\$48.49	\$47.77	\$66.91	\$49.09
30	-0300EC	\$50.29	\$49.39	\$50.29	\$49.39	\$73.32	\$51.04
36	-0360EC	\$52.09	\$51.01	\$52.09	\$51.01	\$79.72	\$52.99
42	-0420EC	\$53.89	\$52.63	\$53.89	\$52.63	\$86.13	\$54.94
48	-0480EC	\$55.69	\$54.25	\$55.69	\$54.25	\$92.53	\$56.89
54	-0540EC	\$57.49	\$55.87	\$57.49	\$55.87	\$98.94	\$58.84
60	-0600EC	\$59.29	\$57.49	\$59.29	\$57.49	\$105.34	\$60.79
66	-0660EC	\$61.09	\$59.11	\$61.09	\$59.11	\$111.75	\$62.74
72	-0720EC	\$62.89	\$60.73	\$62.89	\$60.73	\$118.15	\$64.69
.085" Diameter SEMIRIGID and MaxiFlex Direct Solder Connectors							
LTH IN INS	DASH NUMBER	50 Ω RG 405 [Ⓢ] M17/133-00006 .085 Tin Pl Cu 405-M2T5	50 Ω RG 405 [Ⓢ] M17/133-00007 .085 Tin Plate Cu 8TS-M2T5	50 Ω RG 405 [Ⓢ] M17/133-00013 .085 Tin Plate Al 8AT-M2T5	50 Ω RG 405 [Ⓢ] (No QPL List) .085 Tin Pl 08F-M2T5	50 Ω RG 405 [Ⓢ] M17/133-00016 .085 Silver Pl 8SS-M2T5	50 Ω RG 405 [Ⓢ] (No QPL List) .085 Tin Pl 08J-M2T5
12	-0120EC	\$43.12	\$43.12	\$44.06	\$44.35	\$48.31	\$43.91
18	-0180EC	\$44.63	\$44.63	\$46.04	\$46.48	\$52.42	\$45.81
24	-0240EC	\$46.14	\$46.14	\$48.02	\$48.60	\$56.52	\$47.72
30	-0300EC	\$47.65	\$47.65	\$50.00	\$50.73	\$60.63	\$49.63
36	-0360EC	\$49.16	\$49.16	\$51.98	\$52.85	\$64.73	\$51.53
42	-0420EC	\$50.67	\$50.67	\$53.96	\$54.98	\$68.84	\$53.44
48	-0480EC	\$52.18	\$52.18	\$55.94	\$57.10	\$72.94	\$55.34
54	-0540EC	\$53.69	\$53.69	\$57.92	\$59.23	\$77.05	\$57.25
60	-0600EC	\$55.20	\$55.20	\$59.90	\$61.35	\$81.15	\$59.15
66	-0660EC	\$56.71	\$56.71	CALL	\$63.48	CALL	\$61.06
72	-0720EC	\$58.22	\$58.22	CALL	\$65.60	CALL	\$62.96

Ⓞ Silver Plated Copper Center Conductor Ⓢ Silver Plated Copper Clad Steel Center Conductor

10% Discount @ 25 pcs. up 4% Discount @ 10 pcs. up



SMA Right Angle Male Plug x TNC Male Plug

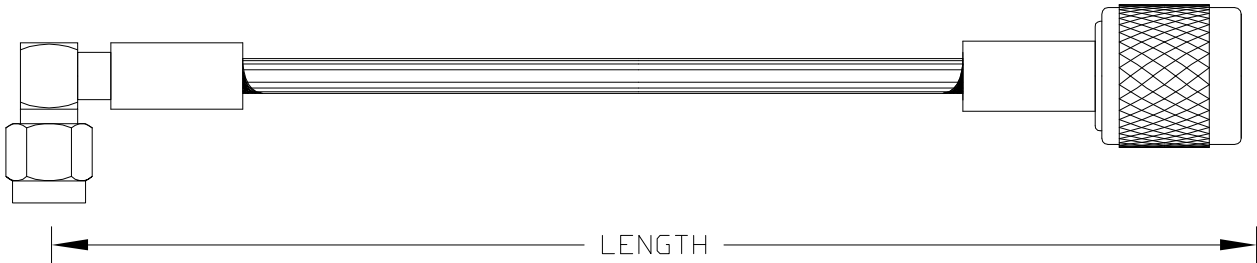

LENGTH IN INCHES	DASH NUMBER	50 Ω RG 58C ③⑥ 1 shield ⑦ 058-MCTA-	50 Ω RG 223 ③① 2 shields ⑦ 223-MCTA-	50 Ω RG 142B ④② 2 shields ⑦ 142-MCTA-	50 Ω RG 178 ② 2 shields ⑩ 178-MCTA-	50 Ω RG 400 ✕④① 2 shields ⑦ 400-MCTA-	
Solder Center, Crimp Outer with Strain Relief							
12	-0120	\$30.48	\$32.77	\$33.60	\$35.59	\$34.30	
24	-0240	\$30.88	\$34.24	\$35.90	\$36.33	\$37.30	
36	-0360	\$31.28	\$35.71	\$38.20	\$37.07	\$40.30	
48	-0480	\$31.68	\$37.18	\$40.50	\$37.81	\$43.30	
60	-0600	\$32.08	\$38.65	\$42.80	\$38.55	\$46.30	
72	-0720	\$32.48	\$40.12	\$45.10	\$39.29	\$49.30	
Solder Center, Crimp Outer with Strain Relief							
LENGTH IN INCHES	DASH NUMBER	50 Ω RG 174 ③⑤ 1 shield ⑦ 174-MCTA-	50 Ω RG 316 ④② 1 shield ⑩ 316-MCTA-	50 Ω RD 316 ④② 2 shields ⑦ 31D-MCTA-	50 Ω RG188* ④ 1 shield ③ 188-MCTA-	50 Ω RG 196 ② 1 shield ⑩ 196-MCTA-	50 Ω RG 179A ④② 1 shield ⑩ 179-MCTA-
12	-0120	\$31.37	\$31.78	\$25.89	\$32.13	\$35.59	\$32.76
24	-0240	\$31.61	\$32.43	\$27.74	\$33.13	\$36.33	\$33.49
36	-0360	\$31.85	\$33.08	\$29.59	\$34.13	\$37.07	\$34.22
48	-0480	\$32.09	\$33.73	\$31.44	\$35.13	\$37.81	\$34.95
60	-0600	\$32.33	\$34.38	\$33.29	\$36.13	\$38.55	\$35.68
72	-0720	\$32.57	\$35.03	\$35.14	\$37.13	\$39.29	\$36.41
Solder Center, Crimp and Clamp Outer							
LENGTH IN INCHES	DASH NUMBER	50 Ω RG 8* ③③ 1 shield ⑧ 008-MCTA-	50 Ω RG 213 ③③ 1 shield ⑧ 213-MCTA-	50 Ω RG 214 ③① 2 shields ⑦ 214-MCTA-	75 Ω RG 59B ③⑤ 1 shield ⑧ 059-MCTA-	50 Ω RG 393 ④① 2 shields ⑦ 393-MCTA-	50 Ω RG 62 ③⑤ 1 shield ⑧ 062-MCTA-
12	-0120C	\$28.31	\$28.49	\$31.10	\$38.61	\$35.65	\$38.70
24	-0240C	\$29.71	\$30.07	\$34.60	\$39.05	\$44.28	\$39.40
36	-0360C	\$31.11	\$31.65	\$38.10	\$39.49	\$52.91	\$40.10
48	-0480C	\$32.51	\$33.23	\$41.60	\$39.93	\$61.54	\$40.80
60	-0600C	\$33.91	\$34.81	\$45.10	\$40.37	\$70.17	\$41.50
72	-0720C	\$35.31	\$36.39	\$48.60	\$40.81	\$78.80	\$42.20
Color Designators (add letter to the end of the part number)							
Black - B		Blue - L		Brown - N		Gray - A	
Orange - O		Red - R		Violet - V		Yellow - Y	
						Green - G	
						White - W	

See Page B5 for Cable Characteristics

* Contact Factory for delivery, Consider new RD316 for (RD188)

10% Discount @ 25 pcs. up

4% Discount @ 10 pcs. up



SMA Right Angle Male Plug x TNC Male Plug

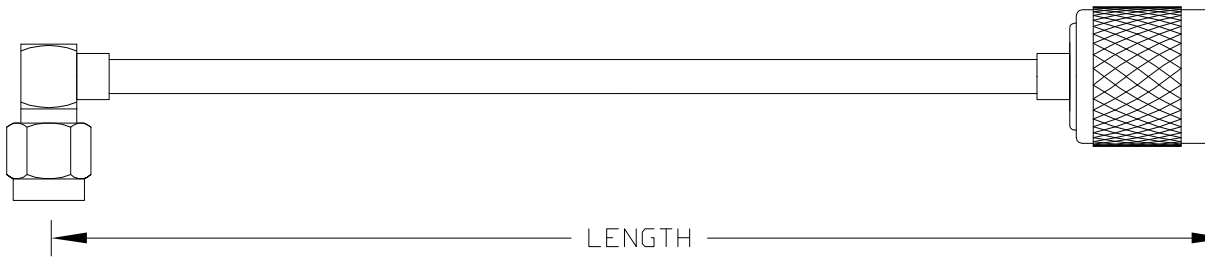

LENGTH IN INCHES	DASH NUMBER	50Ω RG 402 ② M17/130-00004 .141 Cu Jacket 402-M2T0-	50Ω RG 402 ② M17/130-00005 .141 Tin Plate Cu 1TS-M2T0-	50Ω RG 402 ① M17/130-00009 .141 Tin Plate Al 1AT-M2T0-	50Ω MaxiFlex (No QPL List) .141 Tin Pl 14F-M2T0-	50Ω RG 402 ② M17/130-00012 .141 Silver Pl 1SS-M2T0-
.141" Diameter SEMIRIGID and MaxiFlex Direct Solder Connectors						
12	-0120	\$74.13	\$73.77	\$74.13	\$73.77	\$83.34
24	-0240	\$77.73	\$77.01	\$77.73	\$77.01	\$96.15
36	-0360	\$81.33	\$80.25	\$81.33	\$80.25	\$108.96
48	-0480	\$84.93	\$83.49	\$84.93	\$83.49	\$121.77
60	-0600	\$88.53	\$86.73	\$88.53	\$86.73	\$134.58
72	-0720	\$92.13	\$89.97	\$92.13	\$89.97	\$147.39
.085" Diameter SEMIRIGID and MaxiFlex Direct Solder Connectors						
LENGTH IN INCHES	DASH NUMBER	50Ω RG 405 ② M17/133-00006 .085 Tin Plate Cu 405-M2T0-	50Ω RG 405 ② M17/133-00007 .085 Tin Plate Cu 8TS-M2T0-	50Ω RG 405 ② M17/133-00013 .085 Tin Plate Al 8AT-M2T0-	50Ω MaxiFlex (No QPL List) .085 Tin Pl 08F-M2T0-	50Ω RG 405 ② M17/133-00016 .085 Silver Pl 8SS-M2T0-
12	-0120	\$70.85	\$70.85	\$71.79	\$72.08	\$76.04
24	-0240	\$73.87	\$73.87	\$75.75	\$76.33	\$84.25
36	-0360	\$76.89	\$76.89	\$79.71	\$80.58	\$92.46
48	-0480	\$79.91	\$79.91	\$83.67	\$84.83	\$100.67
60	-0600	\$82.93	\$82.93	\$87.63	\$89.08	\$108.88
72	-0720	\$85.95	\$85.95	CALL	\$93.33	CALL
.047" Diameter SEMIRIGID and MaxiFlex Direct Solder Connectors						
LENGTH IN INCHES	DASH NUMBER	50 Ω ② M17/151-00001 .047 Cu Jacket 4CU-M2T0-	50 Ω ② (No QPL List) .047 Tin Plate Al 4AT-M2T0-	50 Ω ② M17/151-00002 .047 Tin Plate Cu 4TS-M2T0-	50 Ω MaxiFlex ② (No QPL List) .047 Tin Plate Braid 04F-M2T0-	
12	-0120C	\$42.17	\$43.62	\$42.17	\$42.87	
24	-0240C	\$45.97	\$48.87	\$45.97	\$47.37	
36	-0360C	\$49.77	\$54.12	\$49.77	\$51.87	
48	-0480C	\$53.57	\$59.37	\$53.57	\$56.37	
60	-0600C	\$57.37	\$64.62	\$57.37	\$60.87	
72	-0720C	\$61.17	\$69.87	\$61.17	\$65.37	

① Silver Plated Copper Center Conductor ② Silver Plated Copper Clad Steel Center Conductor

10% Discount @ 25 pcs. up 4% Discount @ 10 pcs. up



RF Depot.com Inc.

Phone 856-488-2000 Fax 856-488-2020

B182

7850 Browning Rd. Pennsauken, NJ 08109

Online @ www.rfdepot.com

Toll Free 877-RF Depot

SMA Right Angle Male Plug x TNC Male Plug Commercial

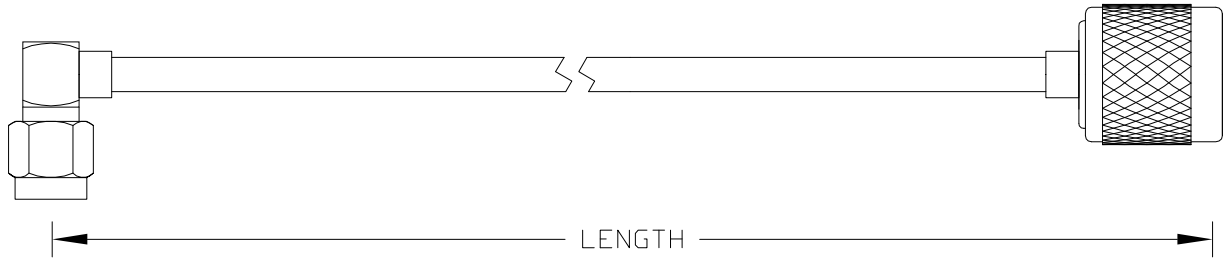

LENGTH IN INCHES	DASH NUMBER	50 Ω RG 402 [Ⓢ] M17/130-00004 .141 Cu Jacket 402-M2T0-	50 Ω RG 402 [Ⓢ] M17/130-00005 .141 Tin Plate Cu 1TS-M2T0-	50 Ω RG 402 [Ⓢ] M17/130-00009 .141 Tin Plate Al 1AT-M2T0-	50 Ω MaxiFlex (No QPL List) .141 Tin Pl 14F-M2T0-	50 Ω RG 402 [Ⓢ] M17/130-00012 .141 Silver Pl 1SS-M2T0-
.141" Diameter SEMIRIGID and MaxiFlex Direct Solder Connectors						
12	-0120C	\$34.23	\$33.87	\$34.23	\$33.87	\$43.44
24	-0240C	\$37.83	\$37.11	\$37.83	\$37.11	\$56.25
36	-0360C	\$41.43	\$40.35	\$41.43	\$40.35	\$69.06
48	-0480C	\$45.03	\$43.59	\$45.03	\$43.59	\$81.87
60	-0600C	\$48.63	\$46.83	\$48.63	\$46.83	\$94.68
72	-0720C	\$52.23	\$50.07	\$52.23	\$50.07	\$107.49
.085" Diameter SEMIRIGID and MaxiFlex Direct Solder Connectors						
LENGTH IN INCHES	DASH NUMBER	50 Ω RG 405 [Ⓢ] M17/133-00006 .085 Tin Plate Cu 405-M2T0-	50 Ω RG 405 [Ⓢ] M17/133-00007 .085 Tin Plate Cu 8TS-M2T0-	50 Ω RG 405 [Ⓢ] M17/133-00013 .085 Tin Plate Al 8AT-M2T0-	50 Ω MaxiFlex (No QPL List) .085 Tin Pl 08F-M2T0-	50 Ω RG 405 [Ⓢ] M17/133-00016 .085 Silver Pl 8SS-M2T0-
12	-0120C	\$35.37	\$35.37	\$36.31	\$36.60	\$40.56
24	-0240C	\$38.39	\$38.39	\$40.27	\$40.85	\$48.77
36	-0360C	\$41.41	\$41.41	\$44.23	\$45.10	\$56.98
48	-0480C	\$44.43	\$44.43	\$48.19	\$49.35	\$65.19
60	-0600C	\$47.45	\$47.45	\$52.15	\$53.60	\$73.40
72	-0720C	\$50.47	\$50.47	CALL	\$57.85	CALL
.047" Diameter SEMIRIGID and MaxiFlex Direct Solder Connectors						
LENGTH IN INCHES	DASH NUMBER	50 Ω [Ⓢ] M17/151-00001 .047 Cu Jacket 4CU-M2T0-	50 Ω [Ⓢ] (No QPL List) .047 Tin Plate Al 4AT-M2T0-	50 Ω M17/151-00002 .047 Tin Plate Cu 4TS-M2T0-	50 Ω MaxiFlex [Ⓢ] (No QPL List) .047 Tin Plate Braid 04F-M2T0-	
12	-0120C	\$42.17	\$43.62	\$42.17	\$42.87	
24	-0240C	\$45.97	\$48.87	\$45.97	\$47.37	
36	-0360C	\$49.77	\$54.12	\$49.77	\$51.87	
48	-0480C	\$53.57	\$59.37	\$53.57	\$56.37	
60	-0600C	\$57.37	\$64.62	\$57.37	\$60.87	
72	-0720C	\$61.17	\$69.87	\$61.17	\$65.37	

[Ⓢ]Silver Plated Copper Center Conductor [Ⓢ]Silver Plated Copper Clad Steel Center Conductor

10% Discount @ 25 pcs. up 4% Discount @ 10 pcs. up

SMB Female Plug x SMB Female Plug



LTH IN INS	DASH NUM	50 Ω RG 58C ③⑥ 1 shield⑦ 058-MBAMBA-	50 Ω RG 142B④② 2 shields⑦ 142-MBAMBA-	50 Ω RG 223 ③① 2 shields⑦ 223-MBAMBA-	50 Ω RG 174③⑤ 1 shield⑦ 174-MBAMBA-	50 Ω RG 179 ④② 1 shield⑩ 178-MBAMBA-	50 Ω RG 196 ②⑩ 1 shields 196-MBAMBA-
Solder Center, Crimp Outer with Strain Relief							
12	-0120	\$23.76	\$26.98	\$26.15	\$24.38	\$27.37	\$28.36
24	-0240	\$24.16	\$29.28	\$27.62	\$24.62	\$28.10	\$29.10
36	-0360	\$24.56	\$31.58	\$29.09	\$24.86	\$28.83	\$29.84
48	-0480	\$24.96	\$33.88	\$30.56	\$25.10	\$29.56	\$30.58
60	-0600	\$25.36	\$36.18	\$32.03	\$25.34	\$30.29	\$31.32
72	-0720	\$25.76	\$38.48	\$33.50	\$25.58	\$31.02	\$32.06
Solder Center, Crimp Outer with Strain Relief							
LENGTH IN INCHES	DASH NUMBER	50 Ω RG188* ④③ 1 shield 188-MBAMBA-	50 Ω④ RD 188* ② 2 shields ⑦ 88D-MBAMBA-	50 Ω RG 316 ④② 1 shield⑩ 316-MBAMBA-	50 Ω RD 316④② 2 shields⑦ 31D-MBAMBA--	50 Ω RG 400*④① 2 shields⑦ 400-MBAMBA-	
12	-0120	\$25.14	\$27.66	\$24.79	\$25.99	\$27.68	
24	-0240	\$26.14	\$31.18	\$25.44	\$27.84	\$30.68	
36	-0360	\$27.14	\$34.70	\$26.09	\$29.69	\$33.68	
48	-0480	\$28.14	\$38.22	\$26.74	\$31.54	\$36.68	
60	-0600	\$29.14	\$41.74	\$27.39	\$33.39	\$39.68	
72	-0720	\$30.14	\$45.26	\$28.04	\$35.24	\$42.68	
Diameter SEMIRIGID and Maxi Flex. Direct Solder Connectors							
LTH IN INS	DASH NUM	50 Ω RG 405 ② M17/133-00006 .085 Cu Jacket 405-MBAMBA-	50 Ω RG 405 ② M17/133-00007 .085 Tin Pl Cu 8TS-MBAMBA-	50 Ω RG 405 ② M17/133-00013 .085 Tin Pl Al 8AT-MBAMBA-	50 Ω RG405② (No QPL List) .085 Tin Pl 08F-MBAMBA-	50 Ω RG 402 ② M17/130-00005 .141 Tin Plate Cu 1TS-MBAMBA-	50 Ω MaxiFlex (No QPL List) .141 Tin Pl 14F-MB0MBO-
12	-0120	\$26.38	\$26.38	\$27.32	\$27.61	\$37.60	\$37.24
24	-0240	\$29.40	\$29.40	\$31.28	\$31.86	\$41.20	\$40.48
36	-0360	\$32.42	\$32.42	\$35.24	\$36.11	\$44.80	\$43.72
48	-0480	\$35.44	\$35.44	\$39.20	\$40.36	\$48.40	\$46.96
60	-0600	\$38.46	\$38.46	\$43.16	\$44.61	\$52.00	\$50.20
72	-0720	\$41.48	\$41.48	CALL	\$48.86	\$55.60	\$53.44
Color Designators (add letter to the end of the part number and add \$1.00 to price)							
Black - B		Blue - L		Brown - N		Gray - A	
Orange - O		Red - R		Violet - V		Green - G	
						White - W	

See Page B5 for Cable Characteristics

* Contact Factory for delivery, Consider new RD316 for (RD188) 10% Discount @ 25 pcs. up 4% Discount @ 10 pcs. up

①Silver Plated Copper Center Conductor ②Silver Plated Copper Clad Steel Center Conductor



RF Depot.com Inc.

Phone 856-488-2000 Fax 856-488-2020

SMB Female Plug x SMB Right Angle Female Plug

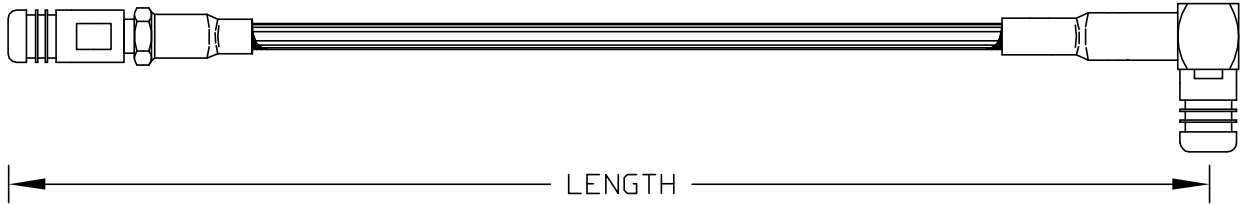

LTH IN INS	DASH NUM	50 Ω RG 58C ③⑥ 1 shield⑦ 058-MBAMBC-	50 Ω RG 142B ④② 2 shields⑦ 142-MBAMBC-	50 Ω RG 223 ③① 2 shields⑦ 223-MBAMBC-	50 Ω RG 174③⑤ 1 shield⑦ 174-MBAMBC-	50 Ω RG 178 ②⑧ 1 shield 178-MBAMBC-	50 Ω RG 196 ②⑧ 1 shields 196-MBAMBC-
Solder Center, Crimp Outer with Strain Relief							
12	-0120	\$24.09	\$28.03	\$27.20	\$23.73	\$25.98	\$25.98
24	-0240	\$24.49	\$30.33	\$28.67	\$23.97	\$26.72	\$26.72
36	-0360	\$24.89	\$32.63	\$30.14	\$24.21	\$27.46	\$27.46
48	-0480	\$25.29	\$34.93	\$31.61	\$24.45	\$28.20	\$28.20
60	-0600	\$25.69	\$37.23	\$33.08	\$24.69	\$28.94	\$28.94
72	-0720	\$26.09	\$39.53	\$34.55	\$24.93	\$29.68	\$29.68
Solder Center, Crimp Outer with Strain Relief							
LENGTH IN INCHES	DASH NUMBER	50 Ω RG188* ④③ 1 shield 188-MBAMBC-	50 Ω④ RD 188* ② 2 shields ⑦ 88D-MBAMBC-	50 Ω RG 316 ④② 1 shield⑧ 316-MBAMBC-	50 Ω RD 316④② 2 shields⑦ 31D-MBAMBC-	50 Ω RG 400*④① 2 shields⑦ 400-MBAMBC-	
12	-0120	\$24.49	\$33.07	\$24.14	\$31.40	\$28.73	
24	-0240	\$25.49	\$36.59	\$24.79	\$33.25	\$31.73	
36	-0360	\$26.49	\$40.11	\$25.44	\$35.10	\$34.73	
48	-0480	\$27.49	\$43.63	\$26.09	\$36.95	\$37.73	
60	-0600	\$28.49	\$47.15	\$26.74	\$38.80	\$40.73	
72	-0720	\$29.49	\$50.67	\$27.39	\$40.65	\$43.73	
Diameter SEMIRIGID and Maxi Flex. Direct Solder Connectors							
LTH IN INS	DASH NUM	50 Ω RG 405 ② M17/133-00006 .085 Cu Jacket 405-MBAMBC-	50 Ω RG 405 ② M17/133-00007 .085 Tin Plate Cu 8TS-MBAMBC-	50 Ω RG 405 ② (No QPL List) .085 Tin Pl 08F-MBAMBC-	50 Ω RG 405 ② M17/133-00016 .085 Silver Pl 8SS-MBAMBC-	50 Ω RG 402 ② M17/130-00005 .141 Tin Pl Cu 1TS-MBAMBC-	50 Ω MaxiFlex (No QPL List) .141 Tin Pl 14F-MBAMBC-
12	-0120	\$27.46	\$27.46	\$28.69	\$32.65	\$39.87	\$39.51
24	-0240	\$30.48	\$30.48	\$32.94	\$40.86	\$43.47	\$42.75
36	-0360	\$33.50	\$33.50	\$37.19	\$49.07	\$47.07	\$45.99
48	-0480	\$36.52	\$36.52	\$41.44	\$57.28	\$50.67	\$49.23
60	-0600	\$39.54	\$39.54	\$45.69	\$65.49	\$54.27	\$52.47
72	-0720	\$42.56	\$42.56	\$49.94	CALL	\$57.87	\$55.71
Color Designators (add letter to the end of the part number and add \$1.00 to price)							
Black - B		Blue - L		Brown - N		Gray - A	
Orange - O		Red - R		Violet - V		Green - G	
						White - W	

See Page B5 for Cable Characteristics

* Contact Factory for delivery, Consider new RD316 for (RD188) 10% Discount @ 25 pcs. up 4% Discount @ 10 pcs. up

①Silver Plated Copper Center Conductor ②Silver Plated Copper Clad Steel Center Conductor

SMB Female Plug x SMC Male Bulkhead Jack

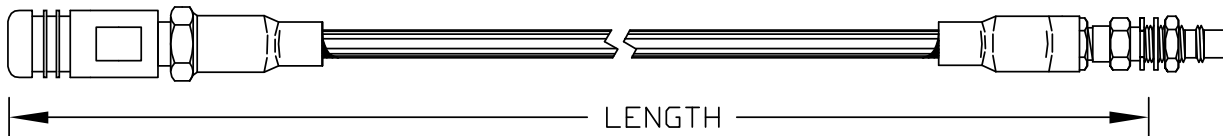

LTH IN INS	DASH NUM	50 Ω RG 58C ③⑥ 1 shield⑦ 058-MBAMCF-	50 Ω RG 142B ④② 2 shields⑦ 142-MBAMCF-	50 Ω RG 223 ③① 2 shields⑦ 223-MBAMCF-	50 Ω RG 174 ③⑤ 1 shield⑦ 174-MBAMCF-	50 Ω RG 178 ②⑩ 1 shield 178-MBAMCF-	50 Ω RG 196 ②⑩ 1 shields 196-MBAMCF-
Solder Center, Crimp Outer with Strain Relief							
12	-0120	\$33.44	\$35.34	\$34.51	\$33.28	\$25.89	\$25.89
24	-0240	\$33.84	\$37.64	\$35.98	\$33.52	\$26.63	\$26.63
36	-0360	\$34.24	\$39.94	\$37.45	\$33.76	\$27.37	\$27.37
48	-0480	\$34.64	\$42.24	\$38.92	\$34.00	\$28.11	\$28.11
60	-0600	\$35.04	\$44.54	\$40.39	\$34.24	\$28.85	\$28.85
72	-0720	\$35.44	\$46.84	\$41.86	\$34.48	\$29.59	\$29.59
Solder Center, Crimp Outer with Strain Relief							
LENGTH IN INCHES	DASH NUMBER	50 Ω RG188* ④③ 1 shield 188-MBAMCF-	50 Ω④ RD 188* ② 2 shields ⑦ 88D-MBAMCF-	50 Ω RG 316 ④② 1 shield⑩ 316-MBAMCF-	50 Ω RD 316④② 2 shields⑦ 31D-MBAMCF-	50 Ω RG 400*④① 2 shields⑦ 400-MBAMCF-	
12	-0120	\$32.66	\$35.18	\$32.31	\$33.51	\$36.04	
24	-0240	\$33.66	\$38.70	\$32.96	\$35.36	\$39.04	
36	-0360	\$34.66	\$42.22	\$33.61	\$37.21	\$42.04	
48	-0480	\$35.66	\$45.74	\$34.26	\$39.06	\$45.04	
60	-0600	\$36.66	\$49.26	\$34.91	\$40.91	\$48.04	
72	-0720	\$37.66	\$52.78	\$35.56	\$42.76	\$51.04	
Diameter SEMIRIGID. Direct Solder Connectors							
LENGTH IN INCHES	DASH NUMBER	50 Ω RG 405 ② M17/133-00006 .085 Cu Jacket 405-MBAMCF-	50 Ω RG 405 ② M17/133-00007 .085 Tin Plate Cu 8TS-MBAMCF-	50 Ω RG 405 ② M17/133-00013 .085 Tin Plate Al 8AT-MBAMCF-	50 Ω RG 405 ② (No QPL List) .085 Tin Pl 08F-MBAMCF-	50 Ω RG 405 ② M17/133-00016 .085 Silver Pl 8SS-MBAMCF-	
12	-0120	\$28.60	\$28.60	\$29.54	\$29.83	\$33.79	
24	-0240	\$31.62	\$31.62	\$33.50	\$34.08	\$42.00	
36	-0360	\$34.64	\$34.64	\$37.46	\$38.33	\$50.21	
48	-0480	\$37.66	\$37.66	\$41.42	\$42.58	\$58.42	
60	-0600	\$40.68	\$40.68	\$45.38	\$46.83	\$66.63	
72	-0720	\$43.70	\$43.70	CALL	\$51.08	CALL	
Color Designators (add letter to the end of the part number and add \$1.00 to price)							
Black - B		Blue - L		Brown - N		Gray - A	
Orange - O		Red - R		Violet - V		Green - G	
						White - W	

See Page B5 for Cable Characteristics

* Contact Factory for delivery, Consider new RD316 for (RD188) 10% Discount @ 25 pcs. up 4% Discount @ 10 pcs. up

① Silver Plated Copper Center Conductor ② Silver Plated Copper Clad Steel Center Conductor



RF Depot.com Inc.

Phone 856-488-2000 Fax 856-488-2020

SMB Female Plug x TNC Male Plug

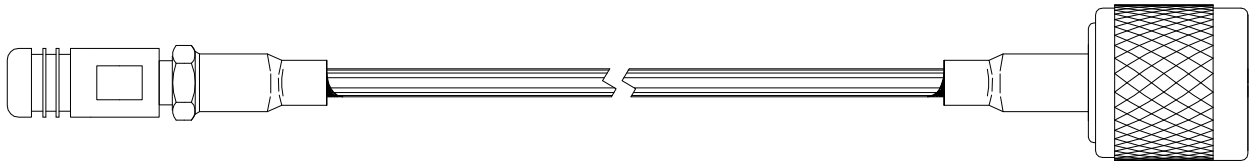

← LENGTH →

LENGTH IN INCHES	DASH NUM	50Ω RG 58C ③⑥ 1 shield⑦ 058-MBATA-	50Ω RG 142B ④② 2 shields⑦ 142-MBATA-	50Ω RG 223 ③① 2 shields⑦ 223-MBATA-	50Ω RG 174 ③⑤ 1 shield⑦ 174-MBATA-	50Ω RG 178 ②⑦ 1 shield 178-MBATA-	50Ω RG 196 ②⑦ 1 shield 196-MBATA-
Solder Center, Crimp Outer with Strain Relief							
12	-0120	\$22.47	\$28.35	\$27.52	\$24.90	\$23.19	\$23.19
24	-0240	\$22.87	\$30.65	\$28.99	\$25.64	\$23.93	\$23.93
36	-0360	\$23.27	\$32.95	\$30.46	\$26.38	\$24.67	\$24.67
48	-0480	\$23.67	\$35.25	\$31.93	\$27.12	\$25.41	\$25.41
60	-0600	\$24.07	\$37.55	\$33.40	\$27.86	\$26.15	\$26.15
72	-0720	\$24.47	\$39.85	\$34.87	\$28.60	\$26.89	\$26.89
Solder Center, Crimp Outer with Strain Relief							
LENGTH IN INCHES	DASH NUMBER	50Ω RG188* ④③ 1 shield 188-MBATA-	50Ω RD 188* ④② 2 shields⑦ 88D-MBATA-	50Ω RG 316 ④② 1 shield⑩ 316-MBATA-	50Ω RD 316 ④⑦ 2 shields 31D-MBATA-	50Ω RG 400* ④① 2 shields⑦ 400-MBATA-	
12	-0120	\$25.16	\$27.68	\$24.81	\$26.01	\$29.05	
24	-0240	\$26.16	\$31.20	\$25.46	\$27.86	\$32.05	
36	-0360	\$27.16	\$34.72	\$26.11	\$29.71	\$35.05	
48	-0480	\$28.16	\$38.24	\$26.76	\$31.56	\$38.05	
60	-0600	\$29.16	\$41.76	\$27.41	\$33.41	\$41.05	
72	-0720	\$30.16	\$45.28	\$28.06	\$35.26	\$44.05	
Solder Center, Crimp Outer with Strain Relief							
LTH IN INS	DASH NUM	50Ω RG 405② M17/133-00006 .085 Cu Jacket 405-MBATA-	50Ω RG 405② M17/133-00007 .085 Tin Plate Cu 8TS-MBATA-	50Ω RG 405② M17/133-00013 .085 Tin Plate Al 8AT-MBATA-	50Ω MaxiFlex② (No QPL List) .085 Tin Pl 08F-MBATA-	50Ω RG 405② M17/133-00016 .085 Silver Pl 8SS-MBATA-	
12	-0120	\$68.70	\$68.70	\$69.64	\$69.93	\$73.89	
24	-0240	\$71.72	\$71.72	\$73.60	\$74.18	\$82.10	
36	-0360	\$74.74	\$74.74	\$77.56	\$78.43	\$90.31	
48	-0480	\$77.76	\$77.76	\$81.52	\$82.68	\$98.52	
60	-0600	\$80.78	\$80.78	\$85.48	\$86.93	\$106.73	
72	-0720	\$83.80	\$83.80	CALL	\$91.18	CALL	
Color Designators (add letter to the end of the part number and add \$1.00 to price)							
Black - B		Blue - L		Brown - N		Gray - A	
Orange - O		Red - R		Violet - V		Green - G	
						White - W	

See Page B5 for Cable Characteristics

* Contact Factory for delivery, Consider new RD316 for (RD188) 10% Discount @ 25 pcs. up 4% Discount @ 10 pcs. up

① Silver Plated Copper Center Conductor ② Silver Plated Copper Clad Steel Center Conductor



SMB Male Bulkhead Jack x SMB Female Plug

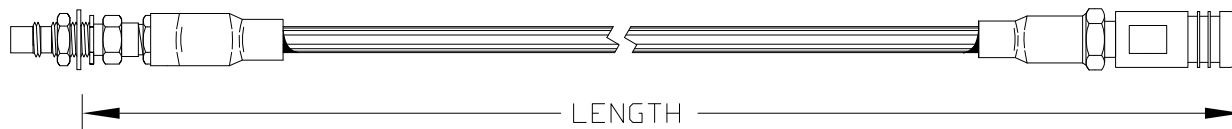

LENGTH IN INCHES	DASH NUMBER	50 Ω RG 58C ③⑥ 1 shield ⑦ 058-MBAMBB-	50 Ω RG 142B ④② 2 shields ⑦ 142-MBAMBB-	50 Ω RG 223 ③① 2 shields ⑦ 223-MBAMBB-	50 Ω RG 174 ③⑤ 1 shield ⑦ 174-MBAMBB-	50 Ω RG 178 ②⑩ 1 shield 178-MBAMBB-	50 Ω RG 196 ②⑩ 1 shield 196-MBAMBB-
Solder Center, Crimp Outer with Strain Relief							
12	-0120	\$22.59	\$31.17	\$24.80	\$22.00	\$28.96	\$28.96
24	-0240	\$22.99	\$33.47	\$25.54	\$22.24	\$29.70	\$29.70
36	-0360	\$23.39	\$35.77	\$26.28	\$22.48	\$30.44	\$30.44
48	-0480	\$23.79	\$38.07	\$27.02	\$22.72	\$31.18	\$31.18
60	-0600	\$24.19	\$40.37	\$27.76	\$22.96	\$31.92	\$31.92
72	0720	\$24.59	\$42.67	\$28.50	\$23.20	\$32.66	\$32.66
Solder Center, Crimp Outer with Strain Relief							
LENGTH IN INCHES	DASH NUMBER	50 Ω RG188* ④③ 1 shield 188-MBAMBB-	50 Ω RD 188* ④② 2 shields ⑦ 88D-MBAMBB-	50 Ω RG 316 ④② 1 shield ⑩ 316-MBAMBB-	50 Ω ④ RD 316 ②⑦ 2 shields 31D-MBAMBB-	50 Ω RG 400* ④① 2 shields ⑦ 400-MBAMBB-	
12	-0120	\$22.76	\$25.28	\$22.41	\$23.61	\$31.87	
24	-0240	\$23.76	\$28.80	\$23.06	\$25.46	\$34.87	
36	-0360	\$24.76	\$32.32	\$23.71	\$27.31	\$37.87	
48	-0480	\$25.76	\$35.84	\$24.36	\$29.16	\$40.87	
60	-0600	\$26.76	\$39.36	\$25.01	\$31.01	\$43.87	
72	0720	\$27.76	\$42.88	\$25.66	\$32.86	\$46.87	
Solder Center, Crimp Outer with Strain Relief							
LENGTH IN INCHES	DASH NUM	50Ω RG 405② M17/133-00006 .085 Cu Jacket 405-MBAMBB-	50Ω RG 405② M17/133-00007 .085 Tin Plate Cu 8TS-MBAMBB-	50Ω RG 405② M17/133-00013 .085 Tin Plate Al 8AT-MBAMBB-	50Ω MaxiFlex② (No QPL List) .085 Tin Pl 08F-MBAMBB-	50Ω RG 405② M17/133-00016 .085 Silver Pl Cu 8SS-MBAMBB-	
12	-0120	\$31.05	\$31.05	\$31.99	\$32.28	\$36.24	
24	-0240	\$34.07	\$34.07	\$35.95	\$36.53	\$44.45	
36	-0360	\$37.09	\$37.09	\$39.91	\$40.78	\$52.66	
48	-0480	\$40.11	\$40.11	\$43.87	\$45.03	\$60.87	
60	-0600	\$43.13	\$43.13	\$47.83	\$49.28	\$69.08	
72	-0720	\$46.15	\$46.15	CALL	\$53.53	CALL	
Color Designators (add letter to the end of the part number and add \$1.00 to price)							
Black - B		Blue - L		Brown - N		Gray - A	
Orange - O		Red - R		Violet - V		Green - G	
						White - W	

See Page B5 for Cable Characteristics

* Contact Factory for delivery, Consider new RD316 for (RD188) 10% Discount @ 25 pcs. up 4% Discount @ 10 pcs. up

①Silver Plated Copper Center Conductor ②Silver Plated Copper Clad Steel Center Conductor



RF Depot.com Inc.

Phone 856-488-2000 Fax 856-488-2020

SMB Male Bulkhead Jack x SMB Right Angle Female Plug

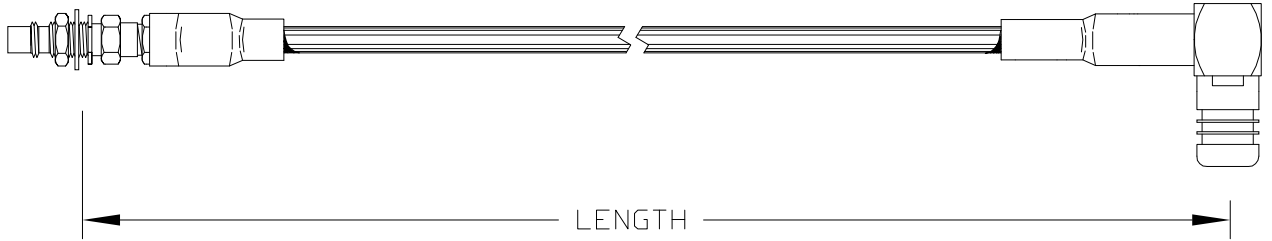

LENGTH IN INCHES	DASH NUM	50 Ω RG 58C ③⑥ 1 shield⑦ 058-MBCMBF-	50 Ω RG 142B ④② 2 shields⑦ 142-MBCMBF-	50 Ω RG 223 ③① 2 shields⑦ 223-MBCMBF-	50 Ω RG 174 ③⑤ 1 shield⑦ 174-MBCMBF-	50 Ω RG 178 ② 1 shield⑥ 178-MBCMBF-	50 Ω RG 196 ②⑩ 1 shield 196-MBCMBF-
Solder Center, Crimp/Clamp Outer with Strain Relief							
12	-0120E	\$31.27	\$34.35	\$33.52	\$23.80	\$24.31	\$24.31
24	-0240E	\$31.67	\$36.65	\$34.99	\$24.04	\$25.05	\$25.05
36	-0360E	\$32.07	\$38.95	\$36.46	\$24.28	\$25.79	\$25.79
48	-0480E	\$32.47	\$41.25	\$37.93	\$24.52	\$26.53	\$26.53
60	-0600E	\$32.87	\$43.55	\$39.40	\$24.76	\$27.27	\$27.27
Solder Center, Crimp/Clamp Outer with Strain Relief							
LENGTH IN INCHES	DASH NUMBER	50 Ω RG188* ④③ 1 shield 188-MBCMBF-	50 Ω RD 188* ④② 2 shields⑦ 88D-MBCMBF-	50 Ω RG 316 ④② 1 shield⑥ 316-MBCMBF-	50 Ω ④ RD 316 ②⑦ 2 shields 31D-MBCMBF-	50 Ω RG 400* ④① 2 shields⑦ 400-MBCMBF-	
Solder Center, Crimp/Clamp Outer with Strain Relief							
12	-0120E	\$24.56	\$27.08	\$24.21	\$25.41	\$35.05	
24	-0240E	\$25.56	\$30.60	\$24.86	\$27.26	\$38.05	
36	-0360E	\$26.56	\$34.12	\$25.51	\$29.11	\$41.05	
48	-0480E	\$27.56	\$37.64	\$26.16	\$30.96	\$44.05	
60	-0600E	\$28.56	\$41.16	\$26.81	\$32.81	\$47.05	
Solder Center, Crimp Outer with Strain Relief							
LTH IN INS	DASH NUM	50 Ω RG 405 ② M17/133-00006 .085 Cu Jacket 405-MBCMBF-	50 Ω RG 405 ② M17/133-00007 .085 Tin Plate Cu 8TS-MBCMBF-	50 Ω MaxiFlex (No QPL List) .085 Tin Pl 08F-MBCMBF-	50 Ω ① Non-Magnetic .085 Tin Plate Cu 8CT-MBCMBF-	50 Ω RG 402 ② M17/130-00005 .141 Tin Plate Cu 1TS-MBCMBF-	50 Ω MaxiFlex (No QPL List) .141 Tin Pl 14F-MBCMBF-
12	-0120	\$30.57	\$30.57	\$31.80	\$39.45	\$40.51	\$40.51
24	-0240	\$33.59	\$33.59	\$36.05	\$41.63	\$43.75	\$43.75
36	-0360	\$36.61	\$36.61	\$40.30	\$43.81	\$46.99	\$46.99
48	-0480	\$39.63	\$39.63	\$44.55	\$45.99	\$50.23	\$50.23
60	-0600	\$42.65	\$42.65	\$48.80	\$48.17	\$53.47	\$53.47
72	-0720	\$45.67	\$45.67	\$53.05	\$50.35	\$56.71	\$56.71
Color Designators (add letter to the end of the part number and add \$1.00 to price)							
Black - B		Blue - L		Brown - N		Gray - A	
Orange - O		Red - R		Violet - V		Green - G	
						White - W	

See Page B5 for Cable Characteristics

* Contact Factory for delivery, Consider new RD316 for (RD188) 10% Discount @ 25 pcs. up 4% Discount @ 10 pcs. up

① Silver Plated Copper Center Conductor ② Silver Plated Copper Clad Steel Center Conductor



SMB Male Bulkhead Jack x SMC Female Plug



LENGTH IN INCHES	DASH NUMBER	50 Ω RG 58C ③⑥ 1 shield⑦ 058-MCAMBF-	50 Ω RG 223 ③① 2 shields⑦ 223-MCAMBF-	50 Ω RG 142B ④② 2 shields⑦ 142-MCAMBF-	50 Ω RG 400*④① 2 shields⑦ 400-MBCMBF-
Solder Center, Crimp Outer with Strain Relief					
12	-0120	\$24.05	\$25.12	\$25.95	\$26.65
24	-0240	\$24.45	\$26.59	\$28.25	\$29.65
36	-0360	\$24.85	\$28.06	\$30.55	\$32.65
48	-0480	\$25.25	\$29.53	\$32.85	\$35.65
60	-0600	\$25.65	\$31.00	\$35.15	\$38.65
72	-0720	\$26.05	\$32.47	\$37.45	\$41.65
Solder Center, Crimp Outer with Strain Relief					
LENGTH IN INCHES	DASH NUMBER	50 Ω RG 179 ④② 1 shield⑩ 179-MCAMBF-	50 Ω RG 178 ②⑩ 1 shield 178-MCAMBF-	50 Ω RG 196 ②⑩ 1 shield 196-MCAMBF-	50 Ω RG 174 ③⑤ 1 shield⑦ 174-MCAMBF-
12	-0120	\$24.76	\$34.17	\$34.17	\$23.76
24	-0240	\$25.49	\$34.91	\$34.91	\$24.00
36	-0360	\$26.22	\$35.65	\$35.65	\$24.24
48	-0480	\$26.95	\$36.39	\$36.39	\$24.48
60	-0600	\$27.68	\$37.13	\$37.13	\$24.72
72	-0720	\$28.41	\$37.87	\$37.87	\$24.96
Solder Center, Crimp Outer with Strain Relief					
LENGTH IN INCHES	DASH NUMBER	50 Ω RG 316 ④② 1 shield⑩ 316-MCAMBF-	50 Ω RD 316 ④②⑦ 2 shields 31D-MCAMBF-	50 Ω RG188* ④② 1 shield⑩ 188-MCAMBF-	50 Ω RD 188* ④②⑦ 2 shields 88D-MCAMBF-
12	-0120	\$23.17	\$24.92	\$23.52	\$26.59
24	-0240	\$23.82	\$26.77	\$24.52	\$30.11
36	-0360	\$24.47	\$28.62	\$25.52	\$33.63
48	-0480	\$25.12	\$30.47	\$26.52	\$37.15
60	-0600	\$25.77	\$32.32	\$27.52	\$40.67
72	-0720	\$26.42	\$34.17	\$28.52	\$44.19
Color Designators (add letter to the end of the part number and add \$1.00 to price)					
Black - B		Blue - L	Brown - N	Gray - A	Green - G
Orange - O		Red - R	Violet - V	Yellow - Y	White - W

See Page B5 for Cable Characteristics

* Contact Factory for delivery, Consider new RD316 for (RD188) 10% Discount @ 25 pcs. up 4% Discount @ 10 pcs. up

①Silver Plated Copper Center Conductor ②Silver Plated Copper Clad Steel Center Conductor



RF Depot.com Inc.

Phone 856-488-2000 Fax 856-488-2020

SMB Male Jack x SMB Female Plug

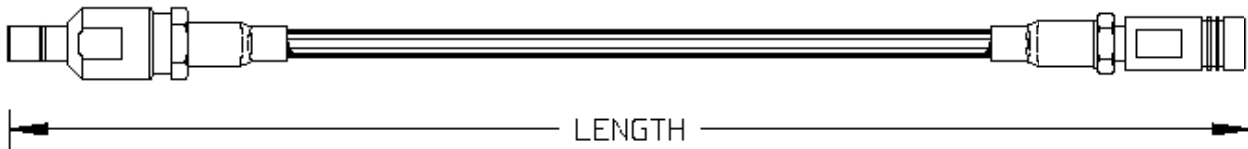

LENGTH IN INCHES	DASH NUMBER	50 Ω RG 58C ③⑥ 1 shield ⑦ 058-MBAMBB-	50 Ω RG 142B ④② 1 shield ⑦ 142-MBAMBB-	50 Ω RG 223 ③① 2 shields ⑦ 223-MBAMBB-	50 Ω RG 174 ③⑤ 1 shield ⑦ 174-MBAMBB-	50 Ω RG 178 ②⑩ 1 shield 178-MBAMBB-	50 Ω RG 196 ②⑩ 1 shield 196-MBAMBB-
Solder Center, Crimp Outer with Strain Relief							
12	-0120	\$22.59	\$25.35	\$24.52	\$22.00	\$28.96	\$28.96
24	-0240	\$22.99	\$27.65	\$25.99	\$22.24	\$29.70	\$29.70
36	-0360	\$23.39	\$29.95	\$27.46	\$22.48	\$30.44	\$30.44
48	-0480	\$23.79	\$32.25	\$28.93	\$22.72	\$31.18	\$31.18
60	-0600	\$24.19	\$34.55	\$30.40	\$22.96	\$31.92	\$31.92
72	-0720	\$24.59	\$36.85	\$31.87	\$23.20	\$32.66	\$32.66
Solder Center, Crimp Outer with Strain Relief							
LENGTH IN INCHES	DASH NUMBER	50 Ω RG188* ④③ 1 shield 188-MBAMBB-	50 Ω RD 188* ④②⑦ 2 shields 88D-MBAMBB-	50 Ω RG 316 ④② 1 shield ⑩ 316-MBAMBB-	50 Ω ④ RD 316 ②⑦ 2 shields 31D-MBAMBB-	50 Ω RG 400* ④⑩ 2 shields ⑦ 400-MBAMBB-	
12	-0120	\$22.76	\$25.28	\$22.41	\$23.61	\$26.05	
24	-0240	\$23.76	\$28.80	\$23.06	\$25.46	\$29.05	
36	-0360	\$24.76	\$32.32	\$23.71	\$27.31	\$32.05	
48	-0480	\$25.76	\$35.84	\$24.36	\$29.16	\$35.05	
60	-0600	\$26.76	\$39.36	\$25.01	\$31.01	\$38.05	
72	-0720	\$27.76	\$42.88	\$25.66	\$32.86	\$41.05	
SEMIRIGID and MaxiFlex Direct Solder Connectors							
LENGTH IN INCHES	DASH NUMBER	50 Ω RG 405② M17/133-00006 .085 Cu Jacket 405-MBAMBB-	50 Ω RG 405② M17/133-00007 .085 Tin Plate Cu 8TS-MBAMBB-	50 Ω RG 405② M17/133-00013 .085 Tin Plate Al 8AT-MBAMBB-	50 Ω MaxiFlex② (No QPL List) .085 Tin Pl 08F-MBAMBB-	50 Ω RG 405② M17/133-00016 .085 Silver Pl 8SS-MBAMBB-	
12	-0120	\$28.41	\$28.41	\$29.35	\$29.64	\$33.60	
24	-0240	\$31.43	\$31.43	\$33.31	\$33.89	\$41.81	
36	-0360	\$34.45	\$34.45	\$37.27	\$38.14	\$50.02	
48	-0480	\$37.47	\$37.47	\$41.23	\$42.39	\$58.23	
60	-0600	\$40.49	\$40.49	\$45.19	\$46.64	\$66.44	
72	-0720	\$43.51	\$43.51	CALL	\$50.89	CALL	
Color Designators (add letter to the end of the part number and add \$1.00 to price)							
Black - B		Blue - L		Brown - N		Gray - A	
Orange - O		Red - R		Violet - V		Green - G	
						White - W	

See Page B5 for Cable Characteristics

* Contact Factory for delivery, Consider new RD316 for (RD188) 10% Discount @ 25 pcs. up 4% Discount @ 10 pcs. up

①Silver Plated Copper Center Conductor ②Silver Plated Copper Clad Steel Center Conductor



RF Depot.com Inc.

Phone 856-488-2000 Fax 856-488-2020

7850 Browning Rd. Pennsauken, NJ 08109

Online @ www.rfdepot.com

Toll Free 877-RF Depot

B191

SMB Right Angle Female Plug x SMB Right Angle Female Plug

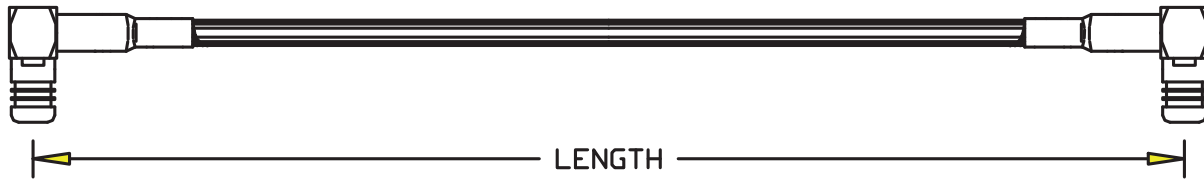

LENGTH IN INCHES	DASH NUMBER	50 Ω RG 58C ④⑥ 1 shield ⑦ 058-MBCMBC-	50 Ω RG 142B ④② 2 shields ⑦ 142-MBCMBC-	50 Ω RG 223 ④① 2 shields ⑦ 223-MBCMBC-	50 Ω RG 174 ④⑤ 1 shield ⑦ 174-MBCMBC-	50 Ω RG 178 ②⑥ 1 shield 178-MBCMBC-	50 Ω RG 196 ②⑥ 1 shield 196-MBCMBC-
Solder Center, Crimp Outer with Strain Relief							
12	-0120	\$36.43	\$42.47	\$41.64	\$34.50	\$35.03	\$35.03
24	-0240	\$36.83	\$44.77	\$43.11	\$34.74	\$35.77	\$35.77
36	-0360	\$37.23	\$47.07	\$44.58	\$34.98	\$36.51	\$36.51
48	-0480	\$37.63	\$49.37	\$46.05	\$35.22	\$37.25	\$37.25
60	-0600	\$38.03	\$51.67	\$47.52	\$35.46	\$37.99	\$37.99
72	-0720	\$38.43	\$53.97	\$48.99	\$35.70	\$38.73	\$38.73
Solder Center, Crimp Outer with Strain Relief							
LENGTH IN INCHES	DASH NUMBER	50 Ω RG188* ④③ 1 shield 188-MBCMBC-	50 Ω RD 188* ④② 2 shields ⑦ 88D-MBCMBC-	50 Ω RG 316 ④② 1 shield ⑥ 316-MBCMBC-	50 Ω ④ RD 316 ②⑦ 2 shields 31D-MBCMBC-	50 Ω RG 400* ④① 2 shields ⑦ 400-MBCMBC-	
12	-0120	\$35.26	\$38.38	\$34.91	\$36.71	\$43.17	
24	-0240	\$36.26	\$41.90	\$35.56	\$38.56	\$46.17	
36	-0360	\$37.26	\$45.42	\$36.21	\$40.41	\$49.17	
48	-0480	\$38.26	\$48.94	\$36.86	\$42.26	\$52.17	
60	-0600	\$39.26	\$52.46	\$37.51	\$44.11	\$55.17	
72	-0720	\$40.26	\$55.98	\$38.16	\$45.96	\$58.17	
SEMIRIGID and MaxiFlex Direct Solder Connectors							
LTH IN INS	DASH NUM	50 Ω RG 402② M17/130-00005 .141 Tin Plate Cu 1TS-MBCMBC-	50 Ω RG 402 ② (No QPL List) .141 Tin Pl 14F-MBCMBC-	50 Ω RG 405② M17/133-00006 .085 Cu Jacket 405-MBCMBC-	50 Ω RG 405② M17/133-00007 .085 Tin Plate Cu 8TS-MBCMBC-	50 Ω RG 405② M17/133-00013 .085 Tin Plate Al 8AT-MBCMBC-	50 Ω MaxiFlex② (No QPL List) .085 Tin Pl 08F-MBCMBC-
12	-0120E	\$45.14	\$45.14	\$31.16	\$31.16	\$32.10	\$32.39
24	-0240E	\$48.38	\$48.38	\$34.18	\$34.18	\$36.06	\$36.64
36	-0360E	\$51.62	\$51.62	\$37.20	\$37.20	\$40.02	\$40.89
48	-0480E	\$54.86	\$54.86	\$40.22	\$40.22	\$43.98	\$45.14
60	-0600E	\$58.10	\$58.10	\$43.24	\$43.24	\$47.94	\$49.39
72	-0720E	\$61.34	\$61.34	\$46.26	\$46.26	CALL	\$53.64
Color Designators (add letter to the end of the part number and add \$1.00 to price)							
Black - B		Blue - L		Brown - N		Gray - A	
Orange - O		Red - R		Violet - V		Green - G	
						White - W	

See Page B5 for Cable Characteristics

* Contact Factory for delivery, Consider new RD316 for (RD188) 10% Discount @ 25 pcs. up 4% Discount @ 10 pcs. up

① Silver Plated Copper Center Conductor ② Silver Plated Copper Clad Steel Center Conductor



RF Depot.com Inc.

Phone 856-488-2000 Fax 856-488-2020

SMB Right Angle Female Plug x SSMC Right Angle Female Plug

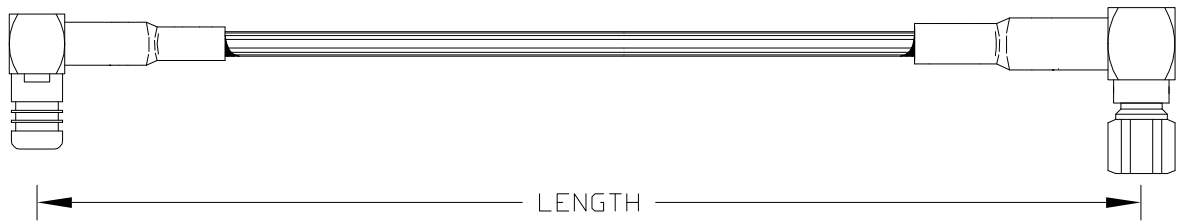

LTH IN INS	DASH NUM	50 Ω RG188* ④③ 1 shield 188-MBCCSC-	50 Ω ④ RD 188* ② 2 shields ⑦ 88D-MBCCSC-	50 Ω RG 316 ④② 1 shield⑧ 316-MBCCSC-	50 Ω RD 316④② 2 shields⑦ 31D-MBCCSC-	50 Ω RG 174④⑤ 1 shield⑦ 174-MBCCSC-	50 Ω RG 178 ② 1 shield⑧ 178-MBCCSC-	50 Ω RG196② 1 shield⑧ 196-MBCCSC-
Solder Center, Crimp Outer with Strain Relief								
12	-0120	\$42.16	\$45.28	\$41.81	\$43.61	\$41.40	\$41.92	\$41.92
24	-0240	\$43.16	\$48.80	\$42.46	\$45.46	\$41.64	\$42.66	\$42.66
36	-0360	\$44.16	\$52.32	\$43.11	\$47.31	\$41.88	\$43.40	\$43.40
48	-0480	\$45.16	\$55.84	\$43.76	\$49.16	\$42.12	\$44.14	\$44.14
60	-0600	\$46.16	\$59.36	\$44.41	\$51.01	\$42.36	\$44.88	\$44.88
72	-0720	\$47.16	\$62.88	\$45.06	\$52.86	\$42.60	\$45.62	\$45.62
SEMIRIGID and MaxiFlex Direct Solder Connectors								
LENGTH IN INCHES	DASH NUM	50Ω RG 405② M17/133-00006 .085 Cu Jacket 405-MB2CS2-	50Ω RG 405② M17/133-00007 .085 Tin Plate Cu 8TS-MBCCSC-	50Ω RG 405② M17/133-00013 .085 Tin Plate Al 8AT-MBCCSC-	50 Ω MaxiFlex② (No OPL Listing) .085 Tin Pl 08F-MBCCSC-	50 Ω RG 405② M17/133-00016 .085 Silver Pl 8SS-MBCCSC-		
12	-0120	\$46.70	\$46.70	\$47.64	\$47.93	\$51.89		
24	-0240	\$49.72	\$49.72	\$51.60	\$52.18	\$60.10		
36	-0360	\$52.74	\$52.74	\$55.56	\$56.43	\$68.31		
48	-0480	\$55.76	\$55.76	\$59.52	\$60.68	\$76.52		
60	-0600	\$58.78	\$58.78	\$63.48	\$64.93	\$84.73		
72	-0720	\$61.80	\$61.80	CALL	\$69.18	CALL		
SEMIRIGID and MaxiFlex Direct Solder Connectors								
LTH IN INS	DASH NUM	50 Ω ② M17/151-00001 .047 Cu Jacket 4CU-MBCCSC-	50 Ω ② (No OPL List) .047 Tin Plate Al 4AT-MBCCSC-	50 Ω M17/151-00002 .047 Tin Plate Cu 4TS-MBCCSC-	50 Ω MaxiFlex ② (No OPL List) .047 Tin Pl 04F-MBCCSC-	50 Ω ① Non-Magnetic .047 Tin Plate Cu 4CT-MBCCSC-		
12	-0120	\$66.87	\$68.32	\$66.87	\$67.57	\$69.75		
24	-0240	\$70.67	\$73.57	\$70.67	\$72.07	\$76.43		
36	-0360	\$74.47	\$78.82	\$74.47	\$76.57	\$83.11		
48	-0480	\$78.27	\$84.07	\$78.27	\$81.07	\$89.79		
60	-0600	\$82.07	\$89.32	\$82.07	\$85.57	\$96.47		
72	-0720	\$85.87	\$94.57	\$85.87	\$90.07	\$103.15		
Color Designators (add letter to the end of the part number and add \$1.00 to price)								
Black - B		Blue - L		Brown - N		Gray - A		Green - G
Orange - O		Red - R		Violet - V		Yellow - Y		White - W

See Page B5 for Cable Characteristics

* Contact Factory for delivery, Consider new RD316 for (RD188) 10% Discount @ 25 pcs. up 4% Discount @ 10 pcs. up

① Silver Plated Copper Center Conductor ② Silver Plated Copper Clad Steel Center Conductor



RF Depot.com Inc.

Phone 856-488-2000 Fax 856-488-2020

7850 Browning Rd. Pennsauken, NJ 08109

Online @ www.rfdepot.com

Toll Free 877-RF Depot

SMB Right Angle Female Plug x TNC Male Plug

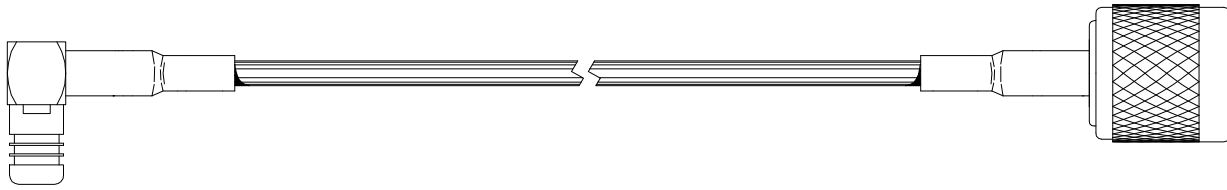

←————— LENGTH —————→

LENGTH IN INCHES	DASH NUMBER	50 Ω RG 58C ③⑥ 1 shield ⑦ 058-SBCTA-	50 Ω RG 142B ④② 2 shields ⑦ 142-SBCTA-	50 Ω RG 223 ③① 2 shields ⑦ 223-SBCTA-	50 Ω RG 174 ③⑤ 1 shield ⑦ 174-SBCTA-	50 Ω RG 178 ②⑩ 1 shield 178-SBCTA-	50 Ω RG 196 ②⑩ 1 shield 196-SBCTA-
Solder Center, Crimp Outer with Strain Relief							
12	-0120	\$22.80	\$29.40	\$28.57	\$23.75	\$20.81	\$20.81
24	-0240	\$23.20	\$31.70	\$30.04	\$23.99	\$21.55	\$21.55
36	-0360	\$23.60	\$34.00	\$31.51	\$24.23	\$22.29	\$22.29
48	-0480	\$24.00	\$36.30	\$32.98	\$24.47	\$23.03	\$23.03
60	-0600	\$24.40	\$38.60	\$34.45	\$24.71	\$23.77	\$23.77
Solder Center, Crimp Outer with Strain Relief							
LENGTH IN INCHES	DASH NUMBER	50 Ω RG 174 ③⑤ 1 shield ⑦ 174-SBCTA-	50 Ω RG 316 ④② 1 shield ⑩ 316-SBCTA-	50 Ω RD 316 ④② 2 shields ⑦ 31D-SBCTA-	50 Ω RG188* ④③ 1 shield 188-SBCTA-	50 Ω RG 400* ④① 2 shields ⑦ 400-MBAMBB-	
12	-0120	\$23.75	\$24.16	\$25.36	\$24.51	\$30.10	
24	-0240	\$23.99	\$24.81	\$27.21	\$25.51	\$33.10	
36	-0360	\$24.23	\$25.46	\$29.06	\$26.51	\$36.10	
48	-0480	\$24.47	\$26.11	\$30.91	\$27.51	\$39.10	
60	-0600	\$24.71	\$26.76	\$32.76	\$28.51	\$42.10	
72	-0720	\$24.95	\$27.41	\$34.61	\$29.51	\$45.10	
SEMIRIGID and MaxiFlex Direct Solder Connectors							
LTH IN INS	DASH NUM	50 Ω RG 402 ② M17/130-00005 .141 Tin Pl Cu 1TS-SBCTA-	50 Ω RG402 ② (No QPL List) .141 Tin Pl 14F-SBCTA-	50 Ω RG 405 ② M17/133-00007 .085 Tin Pl Cu 8TS-SBCTA-	50Ω MaxiFlex ② (No QPL List) .085 Tin Pl 08F-SBCTA-	50 Ω ② M17/151-00002 .047 Tin Pl Cu 4TS-SBCTA-	50 Ω ② (No QPL List) .047 Tin Pl 04F-SBCTA-
12	-0120	\$40.65	\$40.65	\$69.78	\$71.01	\$54.55	\$55.25
24	-0240	\$43.89	\$43.89	\$72.80	\$75.26	\$58.35	\$59.75
36	-0360	\$47.13	\$47.13	\$75.82	\$79.51	\$62.15	\$64.25
48	-0480	\$50.37	\$50.37	\$78.84	\$83.76	\$65.95	\$68.75
60	-0600	\$53.61	\$53.61	\$81.86	\$88.01	\$69.75	\$73.25
72	-0720	\$56.85	\$56.85	\$84.88	\$92.26	\$73.55	\$77.75
Color Designators (add letter to the end of the part number and add \$1.00 to price)							
Black - B		Blue - L		Brown - N		Gray - A	
Orange - O		Red - R		Violet - V		Green - G	
						White - W	

See Page B5 for Cable Characteristics

* Contact Factory for delivery, Consider new RD316 for (RD188) 10% Discount @ 25 pcs. up 4% Discount @ 10 pcs. up

① Silver Plated Copper Center Conductor ② Silver Plated Copper Clad Steel Center Conductor



RF Depot.com Inc.

Phone 856-488-2000 Fax 856-488-2020

SMC Female Plug x SMC Female Plug



LENGTH IN INCHES	DASH NUMBER	50 Ω RG 58C ①⑥ 1 shield ⑦ 058-MCAMCA-	50 Ω RG 142B ④② 2 shields ⑦ 142-MCAMCA-	50 Ω RG 223 ①① 2 shields ⑦ 223-MCAMCA-	50 Ω RG 174 ①⑤ 1 shield ⑦ 174-MCAMCA-	50 Ω RG 178 ② 1 shield ⑧ 178-MCAMCA-	50 Ω RG 196 ② 1 shield ⑧ 196-MCAMCA-
Solder Center, Crimp Outer with Strain Relief							
12	-0120	\$27.48	\$29.38	\$28.55	\$25.20	\$43.32	\$43.32
24	-0240	\$27.88	\$31.68	\$30.02	\$25.44	\$44.06	\$44.06
36	-0360	\$28.28	\$33.98	\$31.49	\$25.68	\$44.80	\$44.80
48	-0480	\$28.68	\$36.28	\$32.96	\$25.92	\$45.54	\$45.54
60	-0600	\$29.08	\$38.58	\$34.43	\$26.16	\$46.28	\$46.28
72	-0720	\$29.48	\$40.88	\$35.90	\$26.40	\$47.02	\$47.02
Solder Center, Crimp Outer with Strain Relief							
LENGTH IN INCHES	DASH NUMBER	50 Ω RG188* ④③ 1 shield 188-MCAMCA-	50 Ω RD 188* ④② 2 shields ⑦ 88D-MCAMCA-	50 Ω RG 316 ④② 1 shield ⑧ 316-MCAMCA-	50 Ω RD 316 ④②⑦ 2 shields 31D-MCAMCA-	50 Ω RG 400* ④① 2 shields ⑦ 400-MCAMCA-	
12	-0120	\$25.96	\$29.58	\$25.61	\$27.91	\$30.08	
24	-0240	\$26.96	\$33.10	\$26.26	\$29.76	\$33.08	
36	-0360	\$27.96	\$36.62	\$26.91	\$31.61	\$36.08	
48	-0480	\$28.96	\$40.14	\$27.56	\$33.46	\$39.08	
60	-0600	\$29.96	\$43.66	\$28.21	\$35.31	\$42.08	
72	-0720	\$30.96	\$47.18	\$28.86	\$37.16	\$45.08	
SEMIRIGID and MaxiFlex Direct Solder Connectors							
LTH IN INS	DASH NUM	50 Ω RG 405② M17/133-00006 .085 Cu Jacket 405-MCAMCA-	50 Ω RG 405② M17/133-00007 .085 Tin Pl Cu 8TS-MCAMCA-	50 Ω RG 405② M17/133-00013 .085 Tin Plate Al 8AT-MCAMCA-	50 Ω MaxiFlex② (No QPL List) .085 Tin Pl 08F-MCAMCA-	50 Ω RG 405② M17/133-00016 .085 Silver Pl 8SS-MCAMCA-	50Ω RG 405① Non-Magnetic .085 Tin Plate Cu 8CT-MCAMCA-
12	-0120	\$28.02	\$28.02	\$28.96	\$29.25	\$33.21	\$27.18
24	-0240	\$31.04	\$31.04	\$32.92	\$33.50	\$41.42	\$29.36
36	-0360	\$34.06	\$34.06	\$36.88	\$37.75	\$49.63	\$31.54
48	-0480	\$37.08	\$37.08	\$40.84	\$42.00	\$57.84	\$33.72
60	-0600	\$40.10	\$40.10	\$44.80	\$46.25	\$66.05	\$35.90
72	-0720	\$43.12	\$43.12	CALL	\$50.50	CALL	\$38.08
Color Designators (add letter to the end of the part number and add \$1.00 to price)							
Black - B		Blue - L		Brown - N		Gray - A	
Orange - O		Red - R		Violet - V		Green - G	
						White - W	

See Page B5 for Cable Characteristics

* Contact Factory for delivery, Consider new RD316 for (RD188) 10% Discount @ 25 pcs. up 4% Discount @ 10 pcs. up

①Silver Plated Copper Center Conductor ②Silver Plated Copper Clad Steel Center Conductor



RF Depot.com Inc.

Phone 856-488-2000 Fax 856-488-2020

7850 Browning Rd. Pennsauken, NJ 08109

Online @ www.rfdepot.com

Toll Free 877-RF Depot

B195

SMC Female Plug x SMC Male Bulkhead Jack

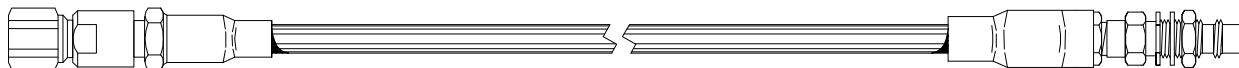

← LENGTH →

LENGTH IN INCHES	DASH NUMBER	50 Ω RG 58C ④⑥ 1 shield⑦ 058-MCFMCA-	50 Ω RG 142B ④② 2 shields⑦ 142-MCFMCA-	50 Ω RG 223 ④① 2 shields⑦ 223-MCFMCA-	50 Ω RG 174 ④⑤ 1 shield⑦ 174-MCFMCA-	50 Ω RG 178 ②⑩ 1 shield 178-MCFMCA-	50 Ω RG 196 ②⑩ 1shield 196-MCFMCA-
Solder Center, Crimp Outer with Strain Relief							
12	-0120	\$33.64	\$35.54	\$34.71	\$32.31	\$33.37	\$33.37
24	-0240	\$34.04	\$37.84	\$36.18	\$32.55	\$34.11	\$34.11
36	-0360	\$34.44	\$40.14	\$37.65	\$32.79	\$34.85	\$34.85
48	-0480	\$34.84	\$42.44	\$39.12	\$33.03	\$35.59	\$35.59
60	-0600	\$35.24	\$44.74	\$40.59	\$33.27	\$36.33	\$36.33
Solder Center, Crimp Outer with Strain Relief							
LENGTH IN INCHES	DASH NUMBER	50 Ω RG188* ④③ 1 shield 188-MCFMCA-	50 Ω RD 188* ④②⑦ 2 shields 88D-MCFMCA-	50 Ω RG 316 ④② 1 shield⑩ 316-MCFMCA-	50 Ω RD 316 ④②⑦ 2 shields 31D-MCFMCA-	50 Ω RG 400*④① 2 shields⑦ 400-MCFMCA-	
12	-0120	\$33.07	\$36.14	\$32.72	\$34.47	\$36.24	
24	-0240	\$34.07	\$39.66	\$33.37	\$36.32	\$39.24	
36	-0360	\$35.07	\$43.18	\$34.02	\$38.17	\$42.24	
48	-0480	\$36.07	\$46.70	\$34.67	\$40.02	\$45.24	
60	-0600	\$37.07	\$50.22	\$35.32	\$41.87	\$48.24	
72	-0720	\$38.07	\$53.74	\$35.97	\$43.72	\$51.24	
SEMIRIGID and MaxiFlex Direct Solder Connectors							
LTH IN INS	DASH NUM	50Ω RG405 ② M17/133-00006 .085 Cu Jacket 405-MCFMCA-	50Ω RG405 ② M17/133-00007 .085 Tin Plate Cu 8TS-MCFMCA-	50Ω RG405② M17/133-00013 .085 Tin Plate Al 8AT-MCFMCA-	50Ω RG405 ② (No QPL List) .085 Tin Pl 08F-MCFMCA-	50Ω RG405② M17/133-00016 .085 Silver Pl 8SS-MCFMCA-	50Ω ① Non-Magnetic .085 Tin Plate Cu 8CT-MCFMCA-
12	-0120	\$34.76	\$34.76	\$35.70	\$35.99	\$39.95	\$33.92
24	-0240	\$37.78	\$37.78	\$39.66	\$40.24	\$48.16	\$36.10
36	-0360	\$40.80	\$40.80	\$43.62	\$44.49	\$56.37	\$38.28
48	-0480	\$43.82	\$43.82	\$47.58	\$48.74	\$64.58	\$40.46
60	-0600	\$46.84	\$46.84	\$51.54	\$52.99	\$72.79	\$42.64
72	-0720	\$49.86	\$49.86	CALL	\$57.24	CALL	\$44.82
Color Designators (add letter to the end of the part number and add \$1.00 to price)							
Black - B		Blue - L		Brown - N		Gray - A	
Orange - O		Red - R		Violet - V		Green - G	
						White - W	

See Page B5 for Cable Characteristics

* Contact Factory for delivery, Consider new RD316 for (RD188) 10% Discount @ 25 pcs. up 4% Discount @ 10 pcs. up

①Silver Plated Copper Center Conductor ②Silver Plated Copper Clad Steel Center Conductor



RF Depot.com Inc.

Phone 856-488-2000 Fax 856-488-2020

B196

7850 Browning Rd. Pennsauken, NJ 08109

Online @ www.rfdepot.com

Toll Free 877-RF Depot

SMC Female Plug x SMC Male Jack

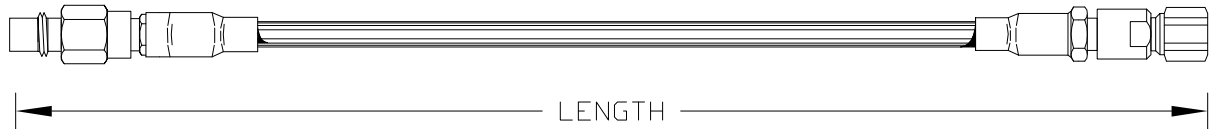

LENGTH IN INCHES	DASH NUMBER	50 Ω RG 58C ①⑥ 1 shield ⑦ 058-MCAMCB-	50 Ω RG 142B ①② 2 shields ⑦ 142-MCAMCB-	50 Ω RG 223 ①① 2 shields ⑦ 223-MCAMCB-	50 Ω RG 174 ①⑤ 1 shield ⑦ 174-MCAMCB-	50 Ω RG 178 ② 1 shield ⑥ 178-MCAMCB-	50 Ω RG 196 ② 1 shield ⑥ 196-MCAMCB-
Solder Center, Crimp Outer with Strain Relief							
12	-0120	\$30.70	\$32.60	\$31.77	\$27.18	\$33.95	\$33.95
24	-0240	\$31.10	\$34.90	\$33.24	\$27.42	\$34.69	\$34.69
36	-0360	\$31.50	\$37.20	\$34.71	\$27.66	\$35.43	\$35.43
48	-0480	\$31.90	\$39.50	\$36.18	\$27.90	\$36.17	\$36.17
60	-0600	\$32.30	\$41.80	\$37.65	\$28.14	\$36.91	\$36.91
72	-0720	\$32.70	\$44.10	\$39.12	\$28.38	\$37.65	\$37.65
Solder Center, Crimp Outer with Strain Relief							
LENGTH IN INCHES	DASH NUMBER	50 Ω RG188* ①③ 1 shield 188-MCAMCB-	50 Ω④ RD 188* ② 2 shields ⑦ 88D-MCAMCB-	50 Ω RG 316 ①② 1 shield ⑥ 316-MCAMCB-	50 Ω RD 316 ①②⑦ 2 shields 31D-MCAMCB-	50 Ω RG 400*④① 2 shields ⑦ 400-MCAMCB-	
12	-0120	\$27.94	\$31.01	\$27.59	\$29.34	\$33.30	
24	-0240	\$28.94	\$34.53	\$28.24	\$31.19	\$36.30	
36	-0360	\$29.94	\$38.05	\$28.89	\$33.04	\$39.30	
48	-0480	\$30.94	\$41.57	\$29.54	\$34.89	\$42.30	
60	-0600	\$31.94	\$45.09	\$30.19	\$36.74	\$45.30	
72	-0720	\$32.94	\$48.61	\$30.84	\$38.59	\$48.30	
SEMIRIGID and MaxiFlex Direct Solder Connectors							
LTH IN INS	DASH NUM	50 Ω RG 405② M17/133-00006 .085 Cu Jacket 405-MCAMCB-	50 Ω RG 405② M17/133-00007 .085 Tin Plate Cu 8TS-MCAMCB-	50 Ω RG 405② M17/133-00013 .085 Tin Plate Al 8AT-MCAMCB-	50 Ω MaxiFlex② (No QPL List) .085 Tin Pl 08F-MCAMCB-	50 Ω RG 405② M17/133-00016 .085 Silver Pl 8SS-MCAMCB-	50 Ω① Non-Magnetic .085 Tin Plate Cu 8CT-MCAMCB-
12	-0120	\$30.92	\$30.92	\$31.86	\$32.15	\$36.11	\$30.08
24	-0240	\$33.94	\$33.94	\$35.82	\$36.40	\$44.32	\$32.26
36	-0360	\$36.96	\$36.96	\$39.78	\$40.65	\$52.53	\$34.44
48	-0480	\$39.98	\$39.98	\$43.74	\$44.90	\$60.74	\$36.62
60	-0600	\$43.00	\$43.00	\$47.70	\$49.15	\$68.95	\$38.80
72	-0720	\$46.02	\$46.02	CALL	\$53.40	CALL	\$40.98
Color Designators (add letter to the end of the part number and add \$1.00 to price)							
Black - B		Blue - L		Brown - N		Gray - A	
Orange - O		Red - R		Violet - V		Green - G	
						White - W	

See Page B5 for Cable Characteristics

* Contact Factory for delivery, Consider new RD316 for (RD188) 10% Discount @ 25 pcs. up 4% Discount @ 10 pcs. up

① Silver Plated Copper Center Conductor ② Silver Plated Copper Clad Steel Center Conductor



RF Depot.com Inc.

Phone 856-488-2000 Fax 856-488-2020

7850 Browning Rd. Pennsauken, NJ 08109

Online @ www.rfdepot.com

Toll Free 877-RF Depot

B197

SMC Female Plug x SMC Right Angle Female Plug

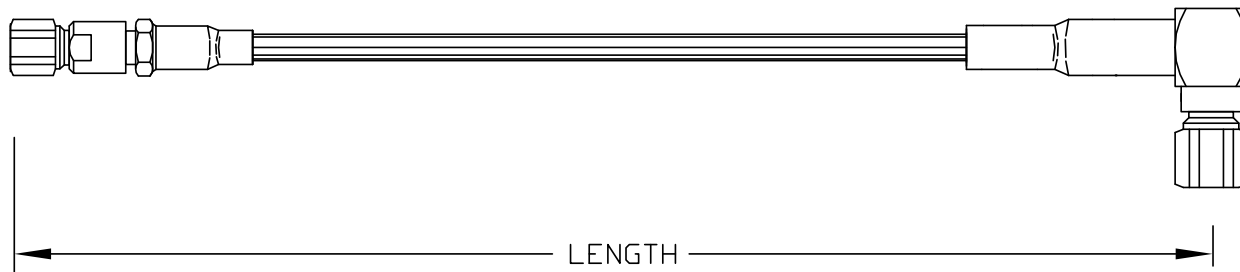

LTH IN INS	DASH NUM	50 Ω RG 58C ③⑥ 1 shield 058-MCAMCC-	50 Ω RG 142B ④② 2 shields 142-MCAMCC-	50 Ω RG 223 ③① 2 shields 223-MCAMCC-	50 Ω RG 174 ③⑤ 1 shield 174-MCAMCC-	50 Ω RG 178 ② 1 shield 178-MCAMCC-	50 Ω RG 196 ② 1 shield 196-MCAMCC-
Solder Center, Crimp Outer							
12	-0120	\$34.94	\$36.84	\$36.01	\$26.64	\$39.07	\$39.07
24	-0240	\$35.34	\$39.14	\$37.48	\$26.88	\$39.81	\$39.81
36	-0360	\$35.74	\$41.44	\$38.95	\$27.12	\$40.55	\$40.55
48	-0480	\$36.14	\$43.74	\$40.42	\$27.36	\$41.29	\$41.29
60	-0600	\$36.54	\$46.04	\$41.89	\$27.60	\$42.03	\$42.03
Solder Center, Crimp Outer							
LTH IN INS	DASH NUM	50 Ω RG188* ④③ 1 shield 188-MCAMCC-	50 Ω RD 188* ④② 2 shields 88D-MCAMCC-	50 Ω RG 316 ④② 1 shield 316-MCAMCC-	50 Ω RD 316 ④②⑦ 2 shields 31D-MCAMCC-	50 Ω RG 400* ④① 2 shields 400-MCAMCC-	50 Ω CCS 195 ①③ 2 shields 19C-MCAMCC-
12	-0120	\$25.40	\$29.80	\$25.05	\$28.13	\$35.54	\$33.11
24	-0240	\$26.40	\$33.32	\$25.70	\$29.98	\$38.54	\$33.68
36	-0360	\$27.40	\$36.84	\$26.35	\$31.83	\$41.54	\$34.25
48	-0480	\$28.40	\$40.36	\$27.00	\$33.68	\$44.54	\$34.82
60	-0600	\$29.40	\$43.88	\$27.65	\$35.53	\$47.54	\$35.39
72	-0720	\$30.40	\$47.40	\$28.30	\$37.38	\$50.54	\$35.96
SEMIRIGID and MaxiFlex Direct Solder Connectors							
LENGTH IN INCHES	DASH NUMBER	50 Ω RG 405② M17/133-00006 .085 Cu Jacket 405-MCAMCC-	50 Ω RG 405② M17/133-00007 .085 Tin Plate Cu 8TS-MCAMCC-	50 Ω RG 405② M17/133-00013 .085 Tin Plate Al 8AT-MCAMCC-	50 Ω MaxiFlex② (No QPL List) .085 Tin Pl 08F-MCAMCC-	50 Ω RG 405② M17/133-00016 .085 Silver Pl 8SS-MCAMCC-	
12	-0120	\$30.99	\$30.99	\$31.93	\$32.22	\$36.18	
24	-0240	\$34.01	\$34.01	\$35.89	\$36.47	\$44.39	
36	-0360	\$37.03	\$37.03	\$39.85	\$40.72	\$52.60	
48	-0480	\$40.05	\$40.05	\$43.81	\$44.97	\$60.81	
60	-0600	\$43.07	\$43.07	\$47.77	\$49.22	\$69.02	
72	-0720	\$46.09	\$46.09	CALL	\$53.47	CALL	
Color Designators (add letter to the end of the part number and add \$1.00 to price)							
Black - B		Blue - L		Brown - N		Gray - A	
Orange - O		Red - R		Violet - V		Yellow - Y	
						Green - G	
						White - W	

See Page B5 for Cable Characteristics

* Contact Factory for delivery, Consider new RD316 for (RD188) 10% Discount @ 25 pcs. up 4% Discount @ 10 pcs. up

①Silver Plated Copper Center Conductor ②Silver Plated Copper Clad Steel Center Conductor



RF Depot.com Inc.

Phone 856-488-2000 Fax 856-488-2020

SMC Male Bulkhead Jack x SMC Male Bulkhead Jack



LENGTH IN INCHES	DASH NUMBER	50 Ω RG 58C ③⑥ 1 shield ⑦ 058-MCFMCF-	50 Ω RG 142B ④② 2 shields ⑦ 142-MCFMCF-	50 Ω RG 223 ③① 2 shields ⑦ 223-MCFMCF-	50 Ω RG 174 ③⑤ 1 shield ⑦ 174-MCFMCF-	50 Ω RG 178 ② 1 shield ⑩ 178-MCFMCF-	50 Ω RG 196 ② 1 shield ⑩ 196-MCFMCF-
Solder Center, Crimp Outer							
12	-0120	\$47.80	\$49.70	\$48.87	\$39.42	\$40.84	\$40.84
24	-0240	\$48.20	\$52.00	\$50.34	\$39.66	\$41.58	\$41.58
36	-0360	\$48.60	\$54.30	\$51.81	\$39.90	\$42.32	\$42.32
48	-0480	\$49.00	\$56.60	\$53.28	\$40.14	\$43.06	\$43.06
60	-0600	\$49.40	\$58.90	\$54.75	\$40.38	\$43.80	\$43.80
72	-0720	\$49.80	\$61.20	\$56.22	\$40.62	\$44.54	\$44.54
Solder Center, Crimp Outer							
LENGTH IN INCHES	DASH NUMBER	50 Ω RG188* ④③ 1 shield ⑦ 188-MCFMCF-	50 Ω RD 188* ④②⑦ 2 shields 88D-MCFMCF-	50 Ω RG 316 ④② 1 shield ⑩ 316-MCFMCF-	50 Ω ④ RD 316 ②⑦ 2 shields 31D-MCFMCF-	50 Ω RG 400* ④① 2 shields ⑦ 400-MCFMCF-	
12	-0120	\$40.18	\$42.70	\$39.83	\$41.03	\$50.40	
24	-0240	\$41.18	\$46.22	\$40.48	\$42.88	\$53.40	
36	-0360	\$42.18	\$49.74	\$41.13	\$44.73	\$56.40	
48	-0480	\$43.18	\$53.26	\$41.78	\$46.58	\$59.40	
60	-0600	\$44.18	\$56.78	\$42.43	\$48.43	\$62.40	
72	-0720	\$45.18	\$60.30	\$43.08	\$50.28	\$65.40	
SEMIRIGID and MaxiFlex Direct Solder Connectors							
LENGTH IN INCHES	DASH NUMBER	50 Ω RG 405② M17/133-00006 .085 Tin Plate Cu 405-MCFMCF-	50 Ω RG 405② M17/133-00007 .085 Tin Plate Cu 8TS-MCFMCF-	50 Ω RG 405② M17/133-00013 .085 Tin Plate Al 8AT-MCFMCF-	50 Ω RG 405② (No QPL List) .085 Tin Pl 08F-MCFMCF-	50 Ω RG 405② M17/133-00016 .085 Silver Pl 8SS-MCFMCF-	
12	-0120	\$35.82	\$35.82	\$36.76	\$37.05	\$41.01	
24	-0240	\$38.84	\$38.84	\$40.72	\$41.30	\$49.22	
36	-0360	\$41.86	\$41.86	\$44.68	\$45.55	\$57.43	
48	-0480	\$44.88	\$44.88	\$48.64	\$49.80	\$65.64	
60	-0600	\$47.90	\$47.90	\$52.60	\$54.05	\$73.85	
72	-0720	\$50.92	\$50.92	CALL	\$58.30	CALL	
Color Designators (add letter to the end of the part number and add \$1.00 to price)							
Black - B		Blue - L		Brown - N		Gray - A	
Orange - O		Red - R		Violet - V		Green - G	
						White - W	

See Page B5 for Cable Characteristics

* Contact Factory for delivery, Consider new RD316 for (RD188) 10% Discount @ 25 pcs. up 4% Discount @ 10 pcs. up

①Silver Plated Copper Center Conductor ②Silver Plated Copper Clad Steel Center Conductor



RF Depot.com Inc.

Phone 856-488-2000 Fax 856-488-2020

7850 Browning Rd. Pennsauken, NJ 08109

Online @ www.rfdepot.com

Toll Free 877-RF Depot

SMC Male Bulkhead Jack x SMC Right Angle Female Plug

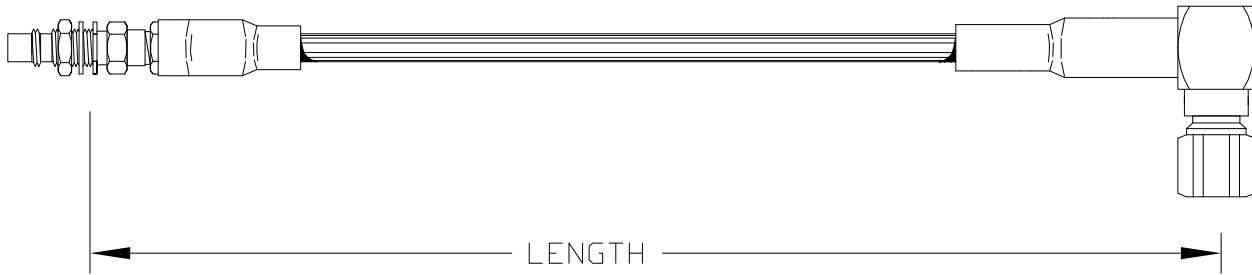

LENGTH IN INCHES	DASH NUMBER	50 Ω RG 58C ③⑥ 1 shield⑦ 058-MCCMCF-	50 Ω RG 142B ④② 2 shields⑦ 142-MCCMCF-	50 Ω RG 223 ③① 2 shields⑦ 223-MCCMCF-	50 Ω RG 174 ③⑤ 1 shield⑦ 174-MCCMCF-	50 Ω RG 178 ② 1 shield⑧ 178-MCCMCF-	50 Ω RG 196 ② 1 shield⑧ 196-MCCMCF-
Solder Center, Crimp/Clamp Outer with Strain Relief							
12	-0120E	\$39.30	\$43.27	\$42.44	\$24.45	\$30.07	\$30.07
24	-0240E	\$39.70	\$45.57	\$43.91	\$24.69	\$30.81	\$30.81
36	-0360E	\$40.10	\$47.87	\$45.38	\$24.93	\$31.55	\$31.55
48	-0480E	\$40.50	\$50.17	\$46.85	\$25.17	\$32.29	\$32.29
60	-0600E	\$40.90	\$52.47	\$48.32	\$25.41	\$33.03	\$33.03
Solder Center, Crimp/Clamp Outer with Strain Relief							
LENGTH IN INCHES	DASH NUMBER	50 Ω RG188* ④③ 1 shield 188-MCCMCF-	50 Ω RD 188* ④② 2 shields ⑦ 88D-MCCMCF-	50 Ω RG 316 ④② 1 shield⑧ 316-MCCMCF-	50 Ω RD 316 ④②⑦ 2 shields 31D-MCCMCF-	50 Ω RG 400*④① 2 shields ⑦ 400-MCCMCF-	
12	-0120E	\$25.21	\$29.06	\$24.86	\$27.39	\$45.97	
24	-0240E	\$26.21	\$32.58	\$25.51	\$29.24	\$48.97	
36	-0360E	\$27.21	\$36.10	\$26.16	\$31.09	\$51.97	
48	-0480E	\$28.21	\$39.62	\$26.81	\$32.94	\$54.97	
60	-0600E	\$29.21	\$43.14	\$27.46	\$34.79	\$57.97	
Solder Center, Crimp/Clamp Outer with Strain Relief							
LTH IN INS	DASH NUMBER	50 Ω RG 405② M17/133-00006 .085 Cu Jacket 405-MCCMCF-	50 Ω RG 405② M17/133-00007 .085 Tin Plate Cu 8TS-MCCMCF-	50 Ω RG 405② M17/133-00013 .085 Tin Plate Al 8AT-MCCMCF-	50 Ω RG 405② (No QPL List) .085 Tin Pl 08F-MCCMCF-	50 Ω RG 402② M17/130-00005 .141 Tin Plate Cu 1TS-MCCMCF-	50 Ω MaxiFlex (No QPL List) .141 Tin Pl 14F-MCCMCF-
24	-0240E	\$36.82	\$36.82	\$38.70	\$39.28	\$41.47	\$41.47
36	-0360E	\$39.84	\$39.84	\$42.66	\$43.53	\$44.71	\$44.71
48	-0480E	\$42.86	\$42.86	\$46.62	\$47.78	\$47.95	\$47.95
60	-0600E	\$45.88	\$45.88	\$50.58	\$52.03	\$51.19	\$51.19
72	-0720E	\$48.90	\$48.90	CALL	\$56.28	\$54.43	\$54.43
Color Designators (add letter to the end of the part number and add \$1.00 to price)							
Black - B		Blue - L		Brown - N		Gray - A	
Orange - O		Red - R		Violet - V		Green - G	
						White - W	

See Page B5 for Cable Characteristics

* Contact Factory for delivery, Consider new RD316 for (RD188) 10% Discount @ 25 pcs. up 4% Discount @ 10 pcs. up

① Silver Plated Copper Center Conductor ② Silver Plated Copper Clad Steel Center Conductor



RF Depot.com Inc.

Phone 856-488-2000 Fax 856-488-2020

B200

7850 Browning Rd. Pennsauken, NJ 08109

Online @ www.rfdepot.com

Toll Free 877-RF Depot

SMC Right Angle Female Plug x SMC Right Angle Female Plug

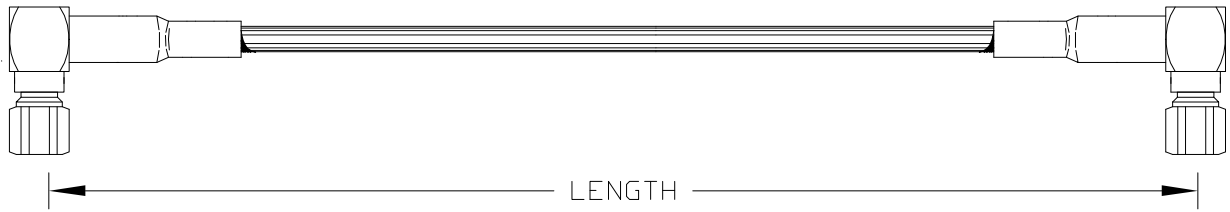

LENGTH IN INCHES	DASH NUMBER	50 Ω RG 58C ①⑥ 1 shield ⑦ 058-MCCMCC-	50 Ω RG 142B ①② 2 shields ⑦ 142-MCCMCC-	50 Ω RG 223 ①① 2 shields ⑦ 223-MCCMCC-	50 Ω RG 174 ①⑤ 1 shield ⑦ 174-MCCMCC-	50 Ω RG 178 ② 1 shield ⑧ 178-MCCMCC-	50 Ω RG 196 ② 1 shield ⑧ 196-MCCMCC-
Solder Center, Crimp Outer with Strain Relief							
12	-0120	\$39.30	\$40.80	\$39.97	\$36.00	\$34.82	\$34.82
24	-0240	\$39.70	\$43.10	\$41.44	\$36.24	\$35.56	\$35.56
36	-0360	\$40.10	\$45.40	\$42.91	\$36.48	\$36.30	\$36.30
48	-0480	\$40.50	\$47.70	\$44.38	\$36.72	\$37.04	\$37.04
60	-0600	\$40.90	\$50.00	\$45.85	\$36.96	\$37.78	\$37.78
72	-0720	\$41.30	\$52.30	\$47.32	\$37.20	\$38.52	\$38.52
Solder Center, Crimp Outer with Strain Relief							
LTH IN INS	DASH NUM	50 Ω RG188* ①③ 1 shield ⑦ 188-MCCMCC-	50 Ω RD 188* ①② 2 shields ⑦ 88D-MCCMCC-	50 Ω RG 316 ①② 1 shield ⑧ 316-MCCMCC-	50 Ω RD 316 ①②⑦ 2 shields ⑦ 31D-MCCMCC-	50 Ω RG 400* ①① 2 shields ⑦ 400-MCCMCC-	50 Ω LMR 195 ①③ 2 shields ⑧ 19M-MCCMCC-
12	-0120	\$36.76	\$37.27	\$36.41	\$41.60	\$41.50	\$40.71
24	-0240	\$37.76	\$40.79	\$37.06	\$43.45	\$44.50	\$41.42
36	-0360	\$38.76	\$44.31	\$37.71	\$45.30	\$47.50	\$42.13
48	-0480	\$39.76	\$47.83	\$38.36	\$47.15	\$50.50	\$42.84
60	-0600	\$40.76	\$51.35	\$39.01	\$49.00	\$53.50	\$43.55
72	-0720	\$41.76	\$54.87	\$39.66	\$50.85	\$56.50	\$44.26
SEMIRIGID and MaxiFlex Direct Solder Connectors							
LENGTH IN INCHES	DASH NUMBER	50 Ω RG 405② M17/133-00006 .085 Cu Jacket 405-MCCMCC-	50 Ω RG 405② M17/133-00007 .085 Tin Plate Cu 8TS-MCCMCC-	50 Ω RG 405② M17/133-00013 .085 Tin Plate Al 8AT-MCCMCC-	50 Ω MaxiFlex② (No QPL List) .085 Tin Pl 08F-MCCMCC-	50 Ω RG 405② M17/133-00016 .085 Silver Pl 8SS-MCCMCC-	
12	-0120E	\$36.18	\$36.18	\$37.12	\$37.41	\$41.37	
24	-0240E	\$39.20	\$39.20	\$41.08	\$41.66	\$49.58	
36	-0360E	\$42.22	\$42.22	\$45.04	\$45.91	\$57.79	
48	-0480E	\$45.24	\$45.24	\$49.00	\$50.16	\$66.00	
60	-0600E	\$48.26	\$48.26	\$52.96	\$54.41	\$74.21	
72	-0720E	\$51.28	\$51.28	CALL	\$58.66	CALL	
Color Designators (add letter to the end of the part number and add \$1.00 to price)							
Black - B		Blue - L		Brown - N		Gray - A	
Orange - O		Red - R		Violet - V		Green - G	
						White - W	

See Page B5 for Cable Characteristics

* Contact Factory for delivery, Consider new RD316 for (RD188) 10% Discount @ 25 pcs. up 4% Discount @ 10 pcs. up

① Silver Plated Copper Center Conductor ② Silver Plated Copper Clad Steel Center Conductor



SMC 90° Female Plug x SSMB 90° Female Plug

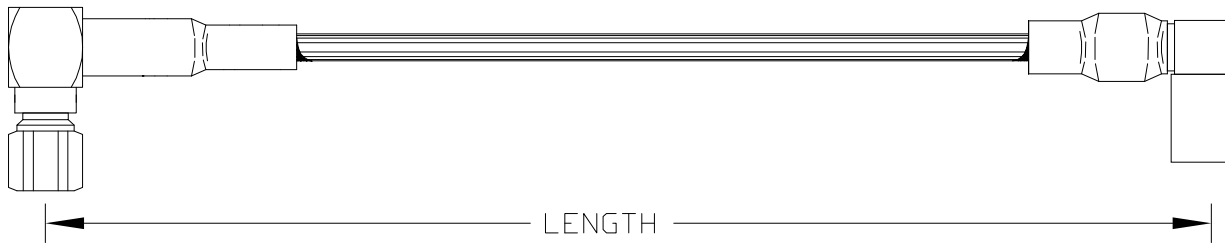

LENGTH IN INCHES	DASH NUMBER	50 Ω RG 174 ③⑤ 1 shield ⑦ 174-MCCSBC-	50 Ω RG188* ④③ 1 shield 188-MCCSBC-	50 Ω RD 188* ④② 2 shields ⑦ 88D-MCCSBC-	50 Ω RG 316 ④② 1 shield ⑩ 316-MCCSBC-	50 Ω RD 316 ④②⑦ 2 shields 31D-MCCSBC-
Solder Center, Crimp Outer with Strain Relief						
12	-0120	\$41.56	\$42.32	\$47.50	\$41.97	\$45.83
24	-0240	\$41.80	\$43.32	\$51.02	\$42.62	\$47.68
36	-0360	\$42.04	\$44.32	\$54.54	\$43.27	\$49.53
48	-0480	\$42.28	\$45.32	\$58.06	\$43.92	\$51.38
60	-0600	\$42.52	\$46.32	\$61.58	\$44.57	\$53.23
72	-0720	\$42.76	\$47.32	\$65.10	\$45.22	\$55.08
Solder Center, Crimp Outer with Strain Relief						
LENGTH IN INCHES	DASH NUMBER	75 Ω RG 179A ④② 1 shield ⑩ 179-MCCSBC-	75 Ω RD 179 ② 2 shields ⑦ 179D-MCCSBC-	75 Ω RG 187 ② 1 shield ⑩ 187-MCCSBC-	50 Ω RG 178 ② 1 shield ⑩ 178-MCCSBC-	50 Ω RG 196 ②⑩ 1 shield 196-MCCSBC-
12	-0120	\$42.05	\$45.88	\$42.92	\$52.30	\$52.30
24	-0240	\$42.78	\$47.58	\$44.52	\$53.04	\$53.04
36	-0360	\$43.51	\$49.28	\$46.12	\$53.78	\$53.78
48	-0480	\$44.24	\$50.98	\$47.72	\$54.52	\$54.52
60	-0600	\$44.97	\$52.68	\$49.32	\$55.26	\$55.26
72	-0720	\$45.70	\$54.38	\$50.92	\$56.00	\$56.00
SEMIRIGID and MaxiFlex Direct Solder Connectors						
LENGTH IN INCHES	DASH NUMBER	50 Ω RG 405② M17/133-00006 .085 Tin Plate Cu 405-MCCSBC-	50 Ω RG 405② M17/133-00007 .085 Tin Plate Cu 8TS-MCCSBC-	50 Ω RG 405② M17/133-00013 .085 Tin Plate Al 8AT-MCCSBC-	50 Ω MaxiFlex② (No QPL List) .085 Tin Pl 08F-MCCSBC-	50 Ω RG 405② M17/133-00016 .085 Silver Pl 8SS-MCCSBC-
12	-0120	\$50.56	\$50.56	\$51.50	\$51.79	\$55.75
24	-0240	\$53.58	\$53.58	\$55.46	\$56.04	\$63.96
36	-0360	\$56.60	\$56.60	\$59.42	\$60.29	\$72.17
48	-0480	\$59.62	\$59.62	\$63.38	\$64.54	\$80.38
60	-0600	\$62.64	\$62.64	\$67.34	\$68.79	\$88.59
72	-0720	\$65.66	\$65.66	CALL	\$73.04	CALL
Color Designators (add letter to the end of the part number and add \$1.00 to price)						
Black - B		Blue - L		Brown - N		Gray - A
Orange - O		Red - R		Violet - V		Yellow - Y
						Green - G
						White - W

See Page B5 for Cable Characteristics

* Contact Factory for delivery, Consider new RD316 for (RD188) 10% Discount @ 25 pcs. up 4% Discount @ 10 pcs. up

① Silver Plated Copper Center Conductor ② Silver Plated Copper Clad Steel Center Conductor



RF Depot.com Inc.

Phone 856-488-2000 Fax 856-488-2020

SMC Right Angle Female Plug x TNC Female Bulkhead Jack

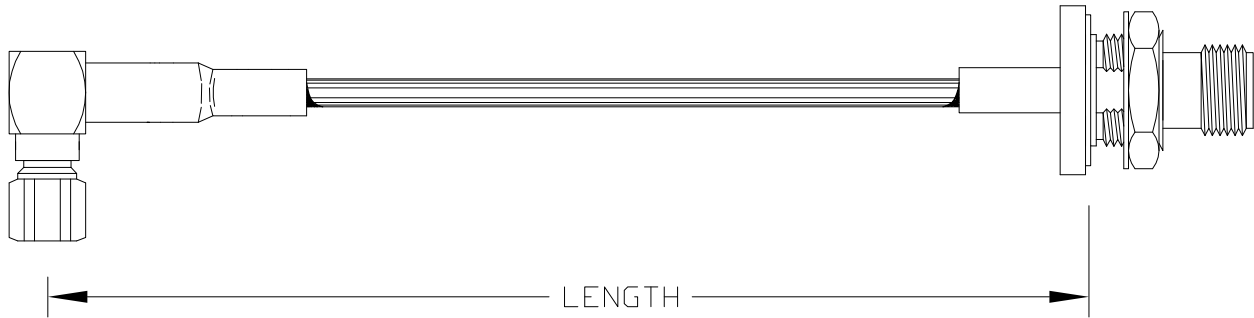

LENGTH IN INCHES	DASH NUMBER	50 Ω RG 58C ③⑥ 1 shield ⑦ 058-MCCTF-	50 Ω RG 142B ④② 2 shields ⑦ 142-MCCTF-	50 Ω RG 223 ③① 2 shields ⑦ 223-MCCTF-	50 Ω RG 174 ③⑤ 1 shield ⑦ 174-MCCTF-	50 Ω RG 178 ② 1 shield ⑦ 178-MCCTF-	50 Ω RG 196 ② 1 shield ⑦ 196-MCCTF-
Solder Center, Crimp/Clamp Outer with Strain Relief							
12	-0120E	\$53.90	\$55.80	\$54.97	\$39.96	\$43.58	\$43.58
24	-0240E	\$54.30	\$58.10	\$56.44	\$40.20	\$44.32	\$44.32
36	-0360E	\$54.70	\$60.40	\$57.91	\$40.44	\$45.06	\$45.06
48	-0480E	\$55.10	\$62.70	\$59.38	\$40.68	\$45.80	\$45.80
60	-0600E	\$55.50	\$65.00	\$60.85	\$40.92	\$46.54	\$46.54
Solder Center, Crimp/Clamp Outer with Strain Relief							
LENGTH IN INCHES	DASH NUMBER	50 Ω RG188* ④③ 1 shield 188-MCCTF-	50 Ω④ RD 188* ② 2 shields ⑦ 88D-MCCTF-	50 Ω RG 316 ④② 1 shield ⑦ 316-MCCTF-	50 Ω RD 316 ④②⑦ 2 shields 31D-MCCTF-	50 Ω RG 400* ④① 2 shields ⑦ 400-MCCTF-	
12	-0120E	\$38.72	\$42.57	\$40.37	\$40.90	\$56.50	
24	-0240E	\$39.72	\$46.09	\$41.02	\$42.75	\$59.50	
36	-0360E	\$40.72	\$49.61	\$41.67	\$44.60	\$62.50	
48	-0480E	\$41.72	\$53.13	\$42.32	\$46.45	\$65.50	
60	-0600E	\$42.72	\$56.65	\$42.97	\$48.30	\$68.50	
SEMIRIGID and MaxiFlex Direct Solder Connectors							
LENGTH IN INCHES	DASH NUMBER	50 Ω RG 405② M17/133-00006 .085 Tin Plate Cu 405-MCCTF-	50 Ω RG 405② M17/133-00007 .085 Tin Plate Cu 8TS-MCCTF-	50 Ω RG 405② M17/133-00013 .085 Tin Plate Al 8AT-MCCTF-	50 Ω MaxiFlex② (No QPL List) .085 Tin Pl 08F-MCCTF-	50 Ω RG 405② M17/133-00016 .085 Silver Pl 8SS-MCCTF-	
12	-0120E	\$44.29	\$44.29	\$45.23	\$45.52	\$49.48	
24	-0240E	\$47.31	\$47.31	\$49.19	\$49.77	\$57.69	
36	-0360E	\$50.33	\$50.33	\$53.15	\$54.02	\$65.90	
48	-0480E	\$53.35	\$53.35	\$57.11	\$58.27	\$74.11	
60	-0600E	\$56.37	\$56.37	\$61.07	\$62.52	\$82.32	
72	-0720E	\$59.39	\$59.39	CALL	\$66.77	CALL	
Color Designators (add letter to the end of the part number and add \$1.00 to price)							
Black - B		Blue - L		Brown - N		Gray - A	
Orange - O		Red - R		Violet - V		Green - G	
						White - W	

See Page B5 for Cable Characteristics

* Contact Factory for delivery, Consider new RD316 for (RD188) 10% Discount @ 25 pcs. up 4% Discount @ 10 pcs. up

① Silver Plated Copper Center Conductor ② Silver Plated Copper Clad Steel Center Conductor



SMC Right Angle Female Plug x TNC Male Plug

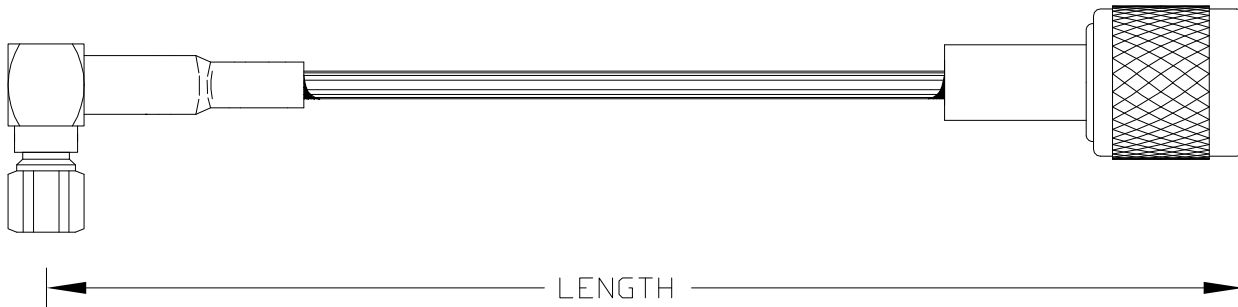

LENGTH IN INCHES	DASH NUMBER	50 Ω RG 174 ③⑤ 1 shield ⑦ 174-TACSC-	50 Ω RG 316 ④② 1 shield ⑩ 316-TACSC-	50 Ω RD 316 ④②⑦ 2 shields 31D-TACSC-	50 Ω RG188* ④③ 1 shield 188-TACSC-	50 Ω RD 188* ④② 2 shields ⑦ 88D-TACSC-
Solder Center, Crimp Outer with Strain Relief						
12	-0120	\$24.25	\$24.66	\$27.19	\$25.01	\$28.86
24	-0240	\$24.49	\$25.31	\$29.04	\$26.01	\$32.38
36	-0360	\$24.73	\$25.96	\$30.89	\$27.01	\$35.90
48	-0480	\$24.97	\$26.61	\$32.74	\$28.01	\$39.42
60	-0600	\$25.21	\$27.26	\$34.59	\$29.01	\$42.94
Solder Center, Crimp Outer with Strain Relief						
LENGTH IN INCHES	DASH NUMBER	50 Ω RG 58C ③⑥ 1 shield ⑦ 058-TACSC-	50 Ω RG 142B ④② 2 shields ⑦ 142-TACSC-	50 Ω RG 223 ③① 2 shields ⑦ 223-TACSC-	50 Ω RG 178 ②⑩ 1 shield 178-TACSC-	50 Ω RG 196 ②⑩ 1 shield 196-TACSC-
12	-0120	\$30.79	\$36.01	\$35.18	\$26.42	\$26.42
24	-0240	\$31.19	\$38.31	\$36.65	\$27.16	\$27.16
36	-0360	\$31.59	\$40.61	\$38.12	\$27.90	\$27.90
48	-0480	\$31.99	\$42.91	\$39.59	\$28.64	\$28.64
60	-0600	\$32.39	\$45.21	\$41.06	\$29.38	\$29.38
Solder Center, Crimp Outer with Strain Relief						
LENGTH IN INCHES	DASH NUMBER	50 Ω SIG 100 ①⑤ 2 shields ⑨ 1LC-TACSC-	50 Ω LMR100 ①⑤ 2 shields ⑨ 1LM-TACSC-	50 Ω CCS 195 ①③ 2 shields ⑨ 19C-TACSC-	50 Ω LMR 195 ①③ 2 shields ⑨ 19M-TACSC-	50 Ω RG 400* ④① 2 shields ⑦ 400-TACSC-
12	-0120	\$24.55	\$24.67	\$30.96	\$31.10	\$36.71
24	-0240	\$25.09	\$25.33	\$31.53	\$31.81	\$39.71
36	-0360	\$25.63	\$25.99	\$32.10	\$32.52	\$42.71
48	-0480	\$26.17	\$26.65	\$32.67	\$33.23	\$45.71
60	-0600	\$26.71	\$27.31	\$33.24	\$33.94	\$48.71
72	-0720	\$27.25	\$27.97	\$33.81	\$34.65	\$51.71
Color Designators (add letter to the end of the part number and add \$1.00 to price)						
Black - B		Blue - L		Brown - N		Gray - A
Orange - O		Red - R		Violet - V		Yellow - Y
						Green - G
						White - W

See Page B5 for Cable Characteristics

* Contact Factory for delivery, Consider new RD316 for (RD188) 10% Discount @ 25 pcs. up 4% Discount @ 10 pcs. up



RF Depot.com Inc.

Phone 856-488-2000 Fax 856-488-2020

SMP Socket x SMP Socket

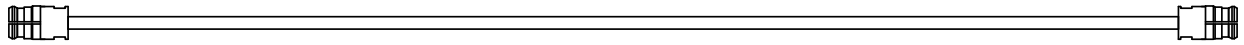

LTH IN INS	DASH NUM	50 Ω RG 405② M17/133-00006 .085 Cu Jacket 405-MPOMPO-	50 Ω RG 405② M17/133-00013 .085 Tin Plate Al 8AT-MPOMPO-	50 Ω RG 405② M17/133-00007 .085 Tin Pl Cu 8TS-MPOMPO-	50Ω Tee-Flex② Non-Magnetic .085 Helix Braid 08T-MPOMPO-	50 Ω RG 405② M17/133-00016 .085 Silver Pl Cu 8SS-MPOMPO-
SEMIRIGID Direct Solder Connectors						
12	-0120	\$44.94	\$45.88	\$44.94	\$44.05	\$50.13
24	-0240	\$47.96	\$49.84	\$47.96	\$46.18	\$58.34
36	-0360	\$50.98	\$53.80	\$50.98	\$48.31	\$66.55
48	-0480	\$54.00	\$57.76	\$54.00	\$50.44	\$74.76
60	-0600	\$57.02	\$61.72	\$57.02	\$52.57	\$82.97
72	-0720	\$60.04	CALL	\$60.04	\$54.70	CALL
SEMIRIGID and MaxiFlex Direct Solder Connectors						
LTH IN INS	DASH NUM	50 Ω RG 405② M17/151-00001 .047 Cu Jacket 4CU-MPOMPO-	50 Ω RG 405② (No QPL List) .047 Tin Plate Al 4AT-MPOMPO-	50 Ω RG 405② M17/151-00002 .047 Tin Pl Cu 4TS-MPOMPO-	50Ω Tee-Flex② (No QPL List) .047 Helix Braid 04F-MPOMPO-	50 Ω LowLess① RG 405① .085 Microprs Tin-Cu 8LT-MPOMPO-
12	-0120	\$47.04	\$48.49	\$47.04	\$47.74	\$57.20
24	-0240	\$50.84	\$53.74	\$50.84	\$52.24	\$66.38
36	-0360	\$54.64	\$58.99	\$54.64	\$56.74	\$75.56
48	-0480	\$58.44	\$64.24	\$58.44	\$61.24	\$84.74
60	-0600	\$62.24	\$69.49	\$62.24	\$65.74	\$93.92
72	-0720	\$66.04	\$74.74	\$66.04	\$70.24	CALL

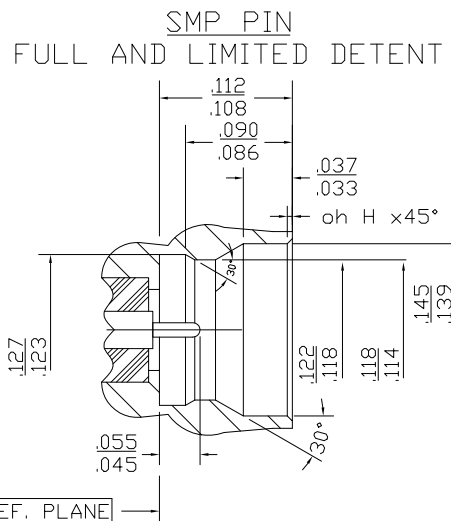
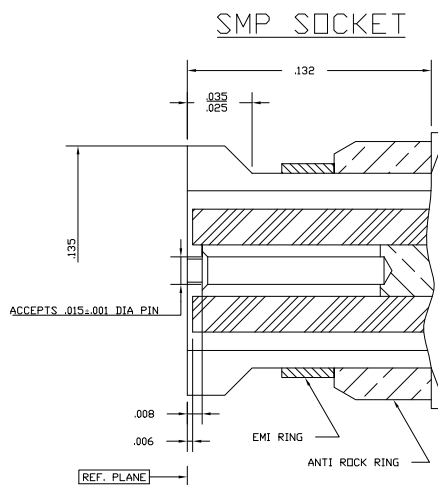

①Silver Plated Copper Center Conductor ②Silver Plated Copper Clad Steel Center Conductor
 10% Discount @ 25 pcs. up 4% Discount @ 10 pcs. up

SMP Socket x SMP Right Angle Socket



LENGTH IN INCHES	DASH NUMBER	50 Ω RG 405 [Ⓜ] M17/133-00006 .085 Cu Jacket 405-MP0MP2-	50 Ω RG 405 [Ⓜ] M17/133-00013 .085 Tin Plate Al 8AT-MP0MP2-	50 Ω RG 405 [Ⓜ] M17/133-00007 .085 Tin Plate Cu 8TS-MP0MP2-	50Ω Tee-Flex [Ⓜ] Non-Magnetic .085 Helix Braid 08T-MP0MP2-	50 Ω RG 405 [Ⓜ] M17/133-00016 .085 Silver Pl Cu 8SS-MP0MP2-
SEMIRIGID Direct Solder Connectors						
12	-0120	\$51.35	\$52.29	\$51.35	\$50.46	\$56.54
24	-0240	\$54.37	\$56.25	\$54.37	\$52.59	\$64.75
36	-0360	\$57.39	\$60.21	\$57.39	\$54.72	\$72.96
48	-0480	\$60.41	\$64.17	\$60.41	\$56.85	\$81.17
60	-0600	\$63.43	\$68.13	\$63.43	\$58.98	\$89.38
72	-0720	\$66.45	CALL	\$66.45	\$61.11	CALL
SEMIRIGID and MaxiFlex Direct Solder Connectors						
LENGTH IN INCHES	DASH NUMBER	50 Ω RG 405 [Ⓜ] M17/151-00001 .047 Cu Jacket 4CU-MP0MP2-	50 Ω RG 405 [Ⓜ] (No QPL List) .047 Tin Plate Al 4AT-MP0MP2-	50 Ω RG 405 [Ⓜ] M17/151-00002 .047 Tin Pl Cu 4TS-MP0MP2-	50Ω Tee-Flex [Ⓜ] (No QPL List) .047 Helix Braid 04F-MP0MP2-	50 Ω LowLoss [Ⓜ] RG 405 [Ⓜ] .085 Microprs Tin-Cu 8LT-MP0MP2-
12	-0120	\$51.84	\$53.29	\$51.84	\$52.54	\$63.69
24	-0240	\$55.64	\$58.54	\$55.64	\$57.04	\$79.34
36	-0360	\$59.44	\$63.79	\$59.44	\$61.54	\$94.99
48	-0480	\$63.24	\$69.04	\$63.24	\$66.04	\$110.64
60	-0600	\$67.04	\$74.29	\$67.04	\$70.54	\$126.29
72	-0720	\$70.84	\$79.54	\$70.84	\$75.04	CALL

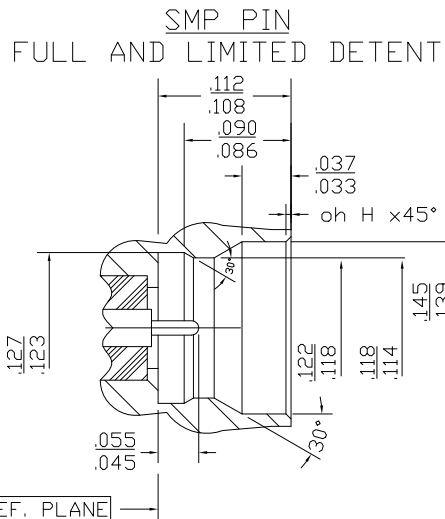
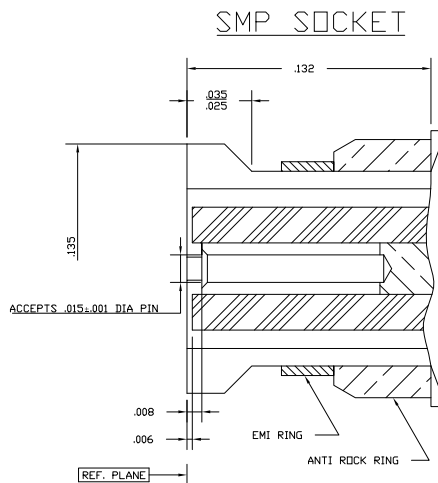

Ⓜ Silver Plated Copper Center Conductor Ⓜ Silver Plated Copper Clad Steel Center Conductor
 10% Discount @ 25 pcs. up 4% Discount @ 10 pcs. up



RF Depot.com Inc.

B206

7850 Browning Rd. Pennsauken, NJ 08109

Online @ www.rfdepot.com

Phone 856-488-2000 Fax 856-488-2020

Toll Free 877-RF Depot

SSMB Female Plug x SSMB Female Plug

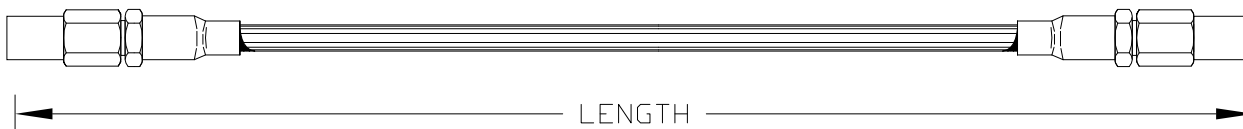

LTH IN INS	DASH NUM	50 Ω RG 174 ①⑤ 1 shield⑦ 174-SBASBA-	50 Ω RG188* ①③ 1 shield 188-SBASBA-	50 Ω RD 188* ①② 2 shields ⑦ 88D-SBASBA-	50 Ω RG 316 ①② 1 shield⑧ 316-SBASBA-	50 Ω RD 316 ①②⑦ 2 shields 31D-SBASBA-	50 Ω RG 178 ② 1 shield⑧ 178-SBASBA-	50 Ω RG 196 ② 1 shield⑧ 196-SBASBA-
Solder Center, Crimp Outer with Strain Relief								
12	-0120	\$38.44	\$39.20	\$41.72	\$38.85	\$40.05	\$35.72	\$35.72
24	-0240	\$38.68	\$40.20	\$45.24	\$39.50	\$41.90	\$36.46	\$36.46
36	-0360	\$38.92	\$41.20	\$48.76	\$40.15	\$43.75	\$37.20	\$37.20
48	-0480	\$39.16	\$42.20	\$52.28	\$40.80	\$45.60	\$37.94	\$37.94
60	-0600	\$39.40	\$43.20	\$55.80	\$41.45	\$47.45	\$38.68	\$38.68
72	-0720	\$39.64	\$44.20	\$59.32	\$42.10	\$49.30	\$39.42	\$39.42
Solder Center, Crimp Outer with Strain Relief								
LENGTH IN INCHES	DASH NUMBER	50 Ω ② M17/151-00001 .047 Cu Jacket 4CU-SBASBA-	50 Ω ② (No QPL List) .047 Tin Plate Al 4AT-SBASBA-	50 Ω ② M17/151-00002 .047 Tin Plate Cu 4TS-SBASBA-	50 Ω MaxiFlex ② (No QPL List) .047 Tin Pl 04F-SBASBA-	50 Ω ① Non-Magnetic .047 Tin Plate Cu 4CT-SBASBA-		
12	-0120	\$43.26	\$44.71	\$43.26	\$43.96	\$46.14		
24	-0240	\$47.06	\$49.96	\$47.06	\$48.46	\$52.82		
36	-0360	\$50.86	\$55.21	\$50.86	\$52.96	\$59.50		
48	-0480	\$54.66	\$60.46	\$54.66	\$57.46	\$66.18		
60	-0600	\$58.46	\$65.71	\$58.46	\$61.96	\$72.86		
72	-0720	\$62.26	\$70.96	\$62.26	\$66.46	\$79.54		
SEMIRIGID and MaxiFlex Direct Solder Connectors								
LTH IN INS	DASH NUM	50 Ω RG 405② M17/133-00006 .085 Tin Pl Cu 405-SBASBA-	50 Ω RG 405② M17/133-00007 .085 Tin Pl Cu 8TS-SBASBA-	50 Ω RG 405② M17/133-00013 .085 Tin Pl Al 8AT-SBASBA-	50 Ω MaxiFlex② (No QPL List) .085 Tin Pl 08F-SBASBA-	50 Ω RG 405② M17/133-00016 .085 Silver Pl 8SS-SBASBA-	50 Ω ① Non-Magnetic .085 Tin Pl Cu 8CT-SBASBA-	
12	-0120	\$42.48	\$42.48	\$43.42	\$43.71	\$47.67	\$41.64	
24	-0240	\$45.50	\$45.50	\$47.38	\$47.96	\$55.88	\$43.82	
36	-0360	\$48.52	\$48.52	\$51.34	\$52.21	\$64.09	\$46.00	
48	-0480	\$51.54	\$51.54	\$55.30	\$56.46	\$72.30	\$48.18	
60	-0600	\$54.57	\$54.57	\$59.26	\$60.71	\$80.51	\$50.36	
72	-0720	\$57.59	\$57.59	CALL	\$64.96	CALL	\$52.54	
Color Designators (add letter to the end of the part number and add \$1.00 to price)								
Black - B		Blue - L		Brown - N		Gray - A		Green - G
Orange - O		Red - R		Violet - V		Yellow - Y		White - W

See Page B5 for Cable Characteristics

* Contact Factory for delivery, Consider new RD316 for (RD188) 10% Discount @ 25 pcs. up 4% Discount @ 10 pcs. up

① Silver Plated Copper Center Conductor ② Silver Plated Copper Clad Steel Center Conductor



RF Depot.com Inc.

Phone 856-488-2000 Fax 856-488-2020

7850 Browning Rd. Pennsauken, NJ 08109

Online @ www.rfdepot.com

Toll Free 877-RF Depot

B207

SSMB Female Plug x SSMB Right Angle Female Plug



← LENGTH →

LTH IN INS	DASH NUMBER	50 Ω RG 174 ②⑤ 1 shield⑦ 174-SBASBC-	50 Ω RG188* ①③ 1 shield 188-SBASBC-	50 Ω RD 188* ①② 2 shields ⑦ 88D-SBASBC-	50 Ω RG 316 ①② 1 shield⑧ 316-SBASBC-	50 Ω RD 316 ①②⑦ 2 shields 31D-SBASBC-	50 Ω RG 178 ② 1 shield⑧ 178-SBASBC-	50 Ω RG 196 ② 1 shield⑧ 196-SBASBC-
------------	-------------	---	--	--	---	--	--	--

Solder Center, Crimp Outer with Strain Relief

12	-0120	\$36.82	\$37.58	\$40.10	\$37.23	\$38.43	\$33.09	\$33.09
24	-0240	\$37.06	\$38.58	\$43.62	\$37.88	\$40.28	\$33.83	\$33.83
36	-0360	\$37.30	\$39.58	\$47.14	\$38.53	\$42.13	\$34.57	\$34.57
48	-0480	\$37.54	\$40.58	\$50.66	\$39.18	\$43.98	\$35.31	\$35.31
60	-0600	\$37.78	\$41.58	\$54.18	\$39.83	\$45.83	\$36.05	\$36.05

Solder Center, Crimp Outer with Strain Relief

LENGTH IN INCHES	DASH NUMBER	50 Ω ② M17/151-00001 .047 Cu Jacket 4CU-SBASBC-	50 Ω ② (No QPL List) .047 Tin Plate Al 4AT-SBASBC-	50 Ω ② M17/151-00002 .047 Tin Plate Cu 4TS-SBASBC-	50 Ω MaxiFlex ② (No QPL List) .047 Tin Pl 04F-SBASBC-	50 Ω ① Non-Magnetic .047 Tin Plate Cu 4CT-SBASBC-
12	-0120	\$40.13	\$41.58	\$40.13	\$40.83	\$43.01
24	-0240	\$43.93	\$46.83	\$43.93	\$45.33	\$49.69
36	-0360	\$47.73	\$52.08	\$47.73	\$49.83	\$56.37
48	-0480	\$51.53	\$57.33	\$51.53	\$54.33	\$63.05
60	-0600	\$55.33	\$62.58	\$55.33	\$58.83	\$69.73
72	-0720	\$59.13	\$67.83	\$59.13	\$63.33	\$76.41

SEMIRIGID and MaxiFlex Direct Solder Connectors

LTH IN INS	DASH NUM	50 Ω RG 405② M17/133-00006 .085 Tin Plate Cu 405-SBASBC-	50 Ω RG 405② M17/133-00007 .085 Tin Plate Cu 8TS-SBASBC-	50 Ω RG 405② M17/133-00013 .085 Tin Plate Al 8AT-SBASBC-	50 Ω MaxiFlex② (No QPL List) .085 Tin Pl 08F-SBASBC-	50 Ω RG 405② M17/133-00016 .085 Silver Pl 8SS-SBASBC-	50 Ω ① Non-Magnetic .085 Tin Plate Cu 8CT-SBASBC-
12	-0120	\$39.35	\$39.35	\$40.29	\$40.58	\$44.54	\$38.51
24	-0240	\$42.37	\$42.37	\$44.25	\$44.83	\$52.75	\$40.69
36	-0360	\$45.39	\$45.39	\$48.21	\$49.08	\$60.96	\$42.87
48	-0480	\$48.41	\$48.41	\$52.17	\$53.33	\$69.17	\$45.05
60	-0600	\$51.43	\$51.43	\$56.13	\$57.58	\$77.38	\$47.23
72	-0720	\$54.45	\$54.45	CALL	\$61.83	CALL	\$49.41

Color Designators (add letter to the end of the part number and add \$1.00 to price)

Black - B	Blue - L	Brown - N	Gray - A	Green - G
Orange - O	Red - R	Violet - V	Yellow - Y	White - W

See Page B5 for Cable Characteristics

* Contact Factory for delivery, Consider new RD316 for (RD188) 10% Discount @ 25 pcs. up 4% Discount @ 10 pcs. up

①Silver Plated Copper Center Conductor ②Silver Plated Copper Clad Steel Center Conductor



RF Depot.com Inc.

Phone 856-488-2000 Fax 856-488-2020

B208

7850 Browning Rd. Pennsauken, NJ 08109

Online @ www.rfdepot.com

Toll Free 877-RF Depot

SSMB Female Plug x SSMC Male Bulkhead Jack



LENGTH IN INCHES	DASH NUM	50 Ω RG 174 ①⑤ 1 shield⑦ 174-CSFSBA-	50 Ω RG188* ①③ 1 shield 188-CSFSBA-	50 Ω RD 188* ①② 2 shields ⑦ 88D-CSFSBA-	50 Ω RG 316 ①② 1 shield⑧ 316-CSFSBA-	50 Ω RD 316 ①② 2 shields⑦ 31D-CSFSBA-	50 Ω RG 178 ② 1 shield⑧ 178-CSFSBA-	50 Ω RG 196 ②⑧ 1 shield 196-CSFSBA-	
Solder Center, Crimp Outer with Strain Relief									
12	-0120	\$39.52	\$40.28	\$42.80	\$39.93	\$41.13	\$38.41	\$38.41	
24	-0240	\$39.76	\$41.28	\$46.32	\$40.58	\$42.98	\$39.15	\$39.15	
36	-0360	\$40.00	\$42.28	\$49.84	\$41.23	\$44.83	\$39.89	\$39.89	
48	-0480	\$40.24	\$43.28	\$53.36	\$41.88	\$46.68	\$40.63	\$40.63	
60	-0600	\$40.48	\$44.28	\$56.88	\$42.53	\$48.53	\$41.37	\$41.37	
72	-0720	\$40.72	\$45.28	\$60.40	\$43.18	\$50.38	\$42.11	\$42.11	
SEMIRIGID and MaxiFlex Direct Solder Connectors									
LENGTH IN INCHES	DASH NUMBER	50 Ω ② M17/151-00001 .047 Cu Jacket 4CU-CSFSBA-	50 Ω ② (No QPL List) .047 Tin Plate Al 4AT-CSFSBA-	50 Ω ② M17/151-00002 .047 Tin Plate Cu 4TS-CSFSBA-	50 Ω MaxiFlex ② (No QPL List) .047 Tin Pl 04F-CSFSBA-	50 Ω ① Non-Magnetic .047 Tin Plate Cu 4CT-CSFSBA-			
12	-0120	\$43.71	\$45.16	\$43.71	\$44.41	\$46.59			
24	-0240	\$47.51	\$50.41	\$47.51	\$48.91	\$53.27			
36	-0360	\$51.31	\$55.66	\$51.31	\$53.41	\$59.95			
48	-0480	\$55.11	\$60.91	\$55.11	\$57.91	\$66.63			
60	-0600	\$58.91	\$66.16	\$58.91	\$62.41	\$73.31			
72	-0720	\$62.71	\$71.41	\$62.71	\$66.91	\$79.99			
SEMIRIGID and MaxiFlex Direct Solder Connectors									
LTH IN INS	DASH NUM	50 Ω RG 405② M17/133-00006 .085 Tin Plate Cu 405-CSFSBA-	50 Ω RG 405② M17/133-00007 .085 Tin Plate Cu 8TS-CSFSBA-	50 Ω RG 405② M17/133-00013 .085 Tin Plate Al 8AT-CSFSBA-	50 Ω MaxiFlex② (No QPL List) .085 Tin Pl 08F-CSFSBA-	50 Ω RG 405② M17/133-00016 .085 Silver Pl 8SS-CSFSBA-	50 Ω ① Non-Magnetic .085 Tin Plate Cu 8CT-CSFSBA-		
12	-0120	\$45.27	\$45.27	\$46.21	\$46.50	\$50.46	\$44.43		
24	-0240	\$48.29	\$48.29	\$50.17	\$50.75	\$58.67	\$46.61		
36	-0360	\$51.31	\$51.31	\$54.13	\$55.00	\$66.88	\$48.79		
48	-0480	\$54.33	\$54.33	\$58.09	\$59.25	\$75.09	\$50.97		
60	-0600	\$57.35	\$57.35	\$62.05	\$63.50	\$83.30	\$53.15		
72	-0720	\$60.37	\$60.37	CALL	\$67.75	CALL	\$55.33		
Color Designators (add letter to the end of the part number and add \$1.00 to price)									
Black - B		Blue - L		Brown - N		Gray - A		Green - G	
Orange - O		Red - R		Violet - V		Yellow - Y		White - W	

See Page B5 for Cable Characteristics

* Contact Factory for delivery, Consider new RD316 for (RD188) 10% Discount @ 25 pcs. up 4% Discount @ 10 pcs. up

①Silver Plated Copper Center Conductor ②Silver Plated Copper Clad Steel Center Conductor



RF Depot.com Inc.

Phone 856-488-2000 Fax 856-488-2020

7850 Browning Rd. Pennsauken, NJ 08109

Online @ www.rfdepot.com

Toll Free 877-RF Depot

B209

SSMB Female Plug x TNC Male Plug

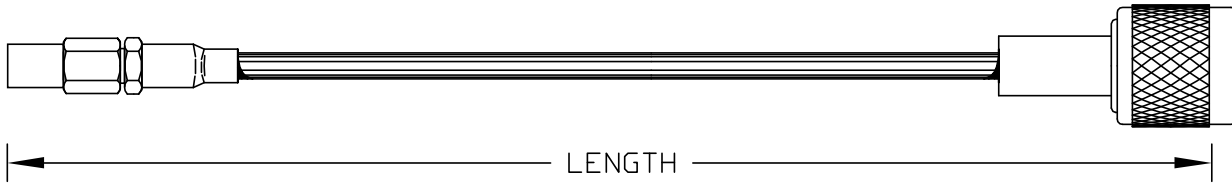

LENGTH IN INCHES	DASH NUMBER	50 Ω RG 174 ③⑤ 1 shield ⑦ 174-SBATA-	50 Ω RG 316 ④② 1 shield ⑩ 316-SBATA-	50 Ω RD 316 ④② 2 shields ⑦ 31D-SBATA-	50 Ω RG188* ④③ 1 shield 188-SBATA-	50 Ω RD 188* ④② 2 shields ⑦ 88D-SBATA-	
Solder Center, Crimp Outer with Strain Relief							
12	-0120	\$31.43	\$31.84	\$33.04	\$32.19	\$33.09	
18	-0180	\$31.55	\$32.17	\$33.97	\$32.69	\$34.85	
24	-0240	\$31.67	\$32.49	\$34.89	\$33.19	\$36.61	
30	-0300	\$31.79	\$32.82	\$35.82	\$33.69	\$38.37	
36	-0360	\$31.91	\$33.14	\$36.74	\$34.19	\$40.13	
42	-0420	\$32.03	\$33.47	\$37.67	\$34.69	\$41.89	
48	-0480	\$32.15	\$33.79	\$38.59	\$35.19	\$43.65	
54	-0540	\$32.27	\$34.12	\$39.52	\$35.69	\$45.41	
60	-0600	\$32.39	\$34.44	\$40.44	\$36.19	\$47.17	
66	-0660	\$32.51	\$34.77	\$41.37	\$36.69	\$48.93	
Solder Center, Crimp Outer with Strain Relief							
LENGTH IN INCHES	DASH NUMBER	50 Ω RG 58C ③⑥ 1 shield ⑦ 058-SBATA-	50 Ω RG 142B ④② 2 shields ⑦ 142-SBATA-	50 Ω RG 223 ③① 2 shields ⑦ 223-SBATA-	50 Ω RG 178 ②⑩ 1 shield 178-SBATA-	50 Ω RG 196 ②⑩ 1 shield 196-SBATA-	
12	-0120	\$21.30	\$26.72	\$25.89	\$31.93	\$31.93	
18	-0180	\$21.50	\$27.87	\$26.63	\$32.30	\$32.30	
24	-0240	\$21.70	\$29.02	\$27.36	\$32.67	\$32.67	
30	-0300	\$21.90	\$30.17	\$28.10	\$33.04	\$33.04	
36	-0360	\$22.10	\$31.32	\$28.83	\$33.41	\$33.41	
42	-0420	\$22.30	\$32.47	\$29.57	\$33.78	\$33.78	
48	-0480	\$22.50	\$33.62	\$30.30	\$34.15	\$34.15	
54	-0540	\$22.70	\$34.77	\$31.04	\$34.52	\$34.52	
60	-0600	\$22.90	\$35.92	\$31.77	\$34.89	\$34.89	
66	-0660	\$23.10	\$37.07	\$32.51	\$35.26	\$35.26	
Color Designators (add letter to the end of the part number and add \$1.00 to price)							
Black - B		Blue - L		Brown - N		Gray - A	
Orange - O		Red - R		Violet - V		Green - G	
						White - W	

See Page B5 for Cable Characteristics

* Contact Factory for delivery, Consider new RD316 for (RD188) 10% Discount @ 25 pcs. up 4% Discount @ 10 pcs. up

SSMB Male Bulkhead Jack x SSMB Right Angle Female Plug

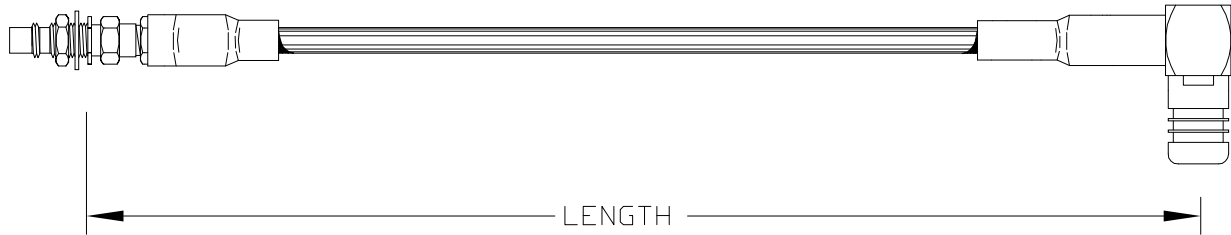

LTH IN INS	DASH NUM	50 Ω RG 174 ③⑤ 1 shield⑦ 174-SBFSBC-	50 Ω RG188* ④③ 2 shields 188-SBFSBC-	50 Ω④ RD 188* ②⑦ 2 shields 88D-SBFSBC-	50 Ω RG 316 ④② 2 shields⑥ 316-SBFSBC-	50 Ω RD 316 ④②⑦ 1 shield 31D-SBFSBC-	50 Ω RG 178 ② 1 shield⑥ 178-SBFSBC-	50 Ω RG 196 ② 1 shield⑥ 196-SBFSBC-
Solder Center, Crimp/Clamp Outer with Strain Relief								
12	-0120E	\$36.52	\$37.28	\$39.80	\$36.93	\$38.13	\$31.48	\$31.48
24	-0240E	\$36.76	\$38.28	\$43.32	\$37.58	\$39.98	\$32.22	\$32.22
36	-0360E	\$37.00	\$39.28	\$46.84	\$38.23	\$41.83	\$32.96	\$32.96
48	-0480E	\$37.24	\$40.28	\$50.36	\$38.88	\$43.68	\$33.70	\$33.70
60	-0600E	\$37.48	\$41.28	\$53.88	\$39.53	\$45.53	\$34.44	\$34.44
SEMIRIGID and MaxiFlex Direct Solder Connectors								
LENGTH IN INCHES	DASH NUMBER	50 Ω M17/151-00001 .047 Cu Jacket 4CU-SBFSBC-	50 Ω (No QPL List) .047 Tin Plate Al 4AT-SBFSBC-	50 Ω M17/151-00001 .047 Tin Plate Cu 4TS-SBFSBC-	50 Ω (No QPL List) .047 Tin Pl 04F-SBFSBC-	50 Ω Non-Magnetic .047 Tin Plate Cu 4CT-SBFSBC-		
12	-0120E	\$34.94	\$36.39	\$34.94	\$35.64	\$37.82		
24	-0240E	\$38.74	\$41.64	\$38.74	\$40.14	\$44.50		
36	-0360E	\$42.54	\$46.89	\$42.54	\$44.64	\$51.18		
48	-0480E	\$46.34	\$52.14	\$46.34	\$49.14	\$57.86		
60	-0600E	\$50.14	\$57.39	\$50.14	\$53.64	\$64.54		
72	-0720E	\$53.94	\$62.64	\$53.94	\$58.14	\$71.22		
SEMIRIGID and MaxiFlex Direct Solder Connectors								
LTH IN INS	DASH NUM	50 Ω RG 405② M17/133-00006 .085 Tin Pl Cu 405-SBFSBC-	50 Ω RG 405② M17/133-00007 .085 Tin Pl Cu 8TS-SBFSBC-	50 Ω RG 405② M17/133-00013 .085 Tin Plate Al 8AT-SBFSBC-	50 Ω MaxiFlex② (No QPL List) .085 Tin Pl 08F-SBFSBC-	50 Ω RG 405② M17/130-00009 .085 Silver Pl 8SS-SBFSBC-	50 Ω RG 405② Non-Magnetic .085 Tin Pl Cu 8CT-SBFSBC-	
12	-0120E	\$34.16	\$34.16	\$35.10	\$35.39	\$39.35	\$33.32	
24	-0240E	\$37.18	\$37.18	\$39.06	\$39.64	\$47.56	\$35.50	
36	-0360E	\$40.20	\$40.20	\$43.02	\$43.89	\$55.77	\$37.68	
48	-0480E	\$43.22	\$43.22	\$46.98	\$48.14	\$63.98	\$39.86	
60	-0600E	\$46.24	\$46.24	\$50.94	\$52.39	\$72.19	\$42.04	
72	-0720E	\$49.26	\$49.26	CALL	\$56.64	CALL	\$44.22	
Color Designators (add letter to the end of the part number and add \$1.00 to price)								
Black - B		Blue - L		Brown - N		Gray - A		Green - G
Orange - O		Red - R		Violet - V		Yellow - Y		White - W

See Page B5 for Cable Characteristics

* Contact Factory for delivery, Consider new RD316 for (RD188) 10% Discount @ 25 pcs. up 4% Discount @ 10 pcs. up

①Silver Plated Copper Center Conductor ②Silver Plated Copper Clad Steel Center Conductor



RF Depot.com Inc.

Phone 856-488-2000 Fax 856-488-2020

7850 Browning Rd. Pennsauken, NJ 08109

Online @ www.rfdepot.com

Toll Free 877-RF Depot

B211

SSMB Male Bulkhead Jack x SSMC Female Plug



LTH IN INS	DASH NUM	50 Ω RG 174 ②⑤ 1 shield⑦ 174-CSASBF-	50 Ω RG188* ④③ 1 shield 188-CSASBF-	50 Ω RD 188* ④② 2 shields⑦ 88D-CSASBF-	50 Ω RG 316 ④② 1 shield⑧ 316-CSASBF-	50 Ω RD 316 ④②⑦ 2 shields 31D-CSASBF-	50 Ω RG 178 ② 1 shield⑧ 178-CSASBF-	50 Ω RG 196 ② 1 shield⑧ 196-CSASBF-
------------------	-------------	---	--	---	---	--	--	--

Solder Center, Crimp Outer with Strain Relief

12	-0120	\$41.07	\$41.83	\$44.35	\$41.48	\$42.68	\$41.68	\$41.68
24	-0240	\$41.31	\$42.83	\$47.87	\$42.13	\$44.53	\$42.42	\$42.42
36	-0360	\$41.55	\$43.83	\$51.39	\$42.78	\$46.38	\$43.16	\$43.16
48	-0480	\$41.79	\$44.83	\$54.91	\$43.43	\$48.23	\$43.90	\$43.90
60	-0600	\$42.03	\$45.83	\$58.43	\$44.08	\$50.08	\$44.64	\$44.64
72	-0720	\$42.27	\$46.83	\$61.95	\$44.73	\$51.93	\$45.38	\$45.38

SEMIRIGID and MaxiFlex Direct Solder Connectors

LENGTH IN INCHES	DASH NUMBER	50 Ω ② M17/151-00001 .047 Cu Jacket 4CU-CSASBF-	50 Ω ② (No QPL List) .047 Tin Plate Al 4AT-CSASBF-	50 Ω ② M17/151-00002 .047 Tin Plate Cu 4TS-CSASBF-	50 Ω MaxiFlex ② (No QPL List) .047 Tin Pl 04F-CSASBF-	50 Ω ① Non-Magnetic .047 Tin Plate Cu 4CT-CSASBF-
12	-0120	\$38.46	\$39.91	\$38.46	\$39.16	\$41.34
24	-0240	\$42.26	\$45.16	\$42.26	\$43.66	\$48.02
36	-0360	\$46.06	\$50.41	\$46.06	\$48.16	\$54.70
48	-0480	\$49.86	\$55.66	\$49.86	\$52.66	\$61.38
60	-0600	\$53.66	\$60.91	\$53.66	\$57.16	\$68.06
72	-0720	\$57.46	\$66.16	\$57.46	\$61.66	\$74.74

SEMIRIGID and MaxiFlex Direct Solder Connectors

LTH IN INS	DASH NUM	50 Ω RG 405② M17/133-00006 .085 Tin Pl Cu 405-CSASBF-	50 Ω RG 405② M17/133-00007 .085 Tin Pl Cu 8TS-CSASBF-	50 Ω RG 405② M17/133-00013 .085 Tin Plate Al 8AT-CSASBF-	50 Ω MaxiFlex② (No QPL List) .085 Tin Pl 08F-CSASBF-	50 Ω RG 405② M17/133-00016 .085 Silver Pl 8SS-CSASBF-	50 Ω ① Non-Magnetic .085 Tin Pl Cu 8CT-CSASBF-
12	-0120	\$37.68	\$37.68	\$38.62	\$38.91	\$42.87	\$36.84
24	-0240	\$40.70	\$40.70	\$42.58	\$43.16	\$51.08	\$39.02
36	-0360	\$43.72	\$43.72	\$46.54	\$47.41	\$59.29	\$41.20
48	-0480	\$46.74	\$46.74	\$50.50	\$51.66	\$67.50	\$43.38
60	-0600	\$49.76	\$49.76	\$54.46	\$55.91	\$75.71	\$45.56
72	-0720	\$52.78	\$52.78	CALL	\$60.16	CALL	\$47.74

Color Designators (add letter to the end of the part number and add \$1.00 to price)

Black - B	Blue - L	Brown - N	Gray - A	Green - G
Orange - O	Red - R	Violet - V	Yellow - Y	White - W

See Page B5 for Cable Characteristics

* Contact Factory for delivery, Consider new RD316 for (RD188) 10% Discount @ 25 pcs. up 4% Discount @ 10 pcs. up

① Silver Plated Copper Center Conductor ② Silver Plated Copper Clad Steel Center Conductor



RF Depot.com Inc.

Phone 856-488-2000 Fax 856-488-2020

B212

7850 Browning Rd. Pennsauken, NJ 08109

Online @ www.rfdepot.com

Toll Free 877-RF Depot

SSMB 90° Female Plug x SSMB 90° Female Plug

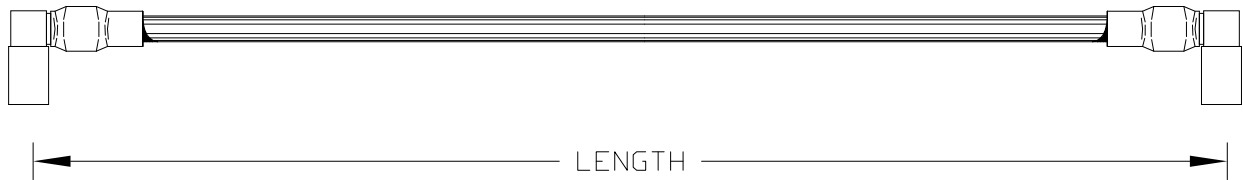

LTH IN INS	DASH NUM	50 Ω RG 174 ⑤⑤ 1 shield ⑦ 174-SBCSBC-	50 Ω RG188* ④③ 1 shield 188-SBCSBC-	50 Ω RD 188* ④② 2 shields ⑦ 88D-SBCSBC-	50 Ω RG 316 ④② 1 shield ⑩ 316-SBCSBC-	50 Ω RD 316 ④②⑦ 2 shields 31D-SBCSBC-	50 Ω RG 178 ② 1 shield ⑩ 178-SBCSBC-	50 Ω RG 196 ②⑩ 1 shield 196-SBCSBC-	
Solder Center, Crimp Outer with Strain Relief									
12	-0120	\$52.68	\$53.44	\$56.56	\$50.09	\$51.89	\$39.32	\$39.32	
24	-0240	\$52.92	\$54.44	\$60.08	\$50.74	\$53.74	\$40.06	\$40.06	
36	-0360	\$53.16	\$55.44	\$63.60	\$51.39	\$55.59	\$40.80	\$40.80	
48	-0480	\$53.40	\$56.44	\$67.12	\$52.04	\$57.44	\$41.54	\$41.54	
60	-0600	\$53.64	\$57.44	\$70.64	\$52.69	\$59.29	\$42.28	\$42.28	
72	-0720	\$53.88	\$58.44	\$74.16	\$53.34	\$61.14	\$43.02	\$43.02	
SEMIRIGID and MaxiFlex Direct Solder Connectors									
LENGTH IN INCHES	DASH NUMBER	50 Ω ② M17/151-00001 .047 Cu Jacket 4CU-SBCSBC-	50 Ω ② (No QPL List) .047 Tin Plate Al 4AT-SBCSBC-	50 Ω ② M17/151-00002 .047 Tin Plate Cu 4TS-SBCSBC-	50 Ω MaxiFlex ② (No QPL List) .047 Tin Pl 04F-SBCSBC-	50 Ω ① Non-Magnetic .047 Tin Plate Cu 4CT-SBCSBC-			
12	-0120	\$53.60	\$55.05	\$53.60	\$54.30	\$56.48			
24	-0240	\$57.40	\$60.30	\$57.40	\$58.80	\$63.16			
36	-0360	\$61.20	\$65.55	\$61.20	\$63.30	\$69.84			
48	-0480	\$65.00	\$70.80	\$65.00	\$67.80	\$76.52			
60	-0600	\$68.80	\$76.05	\$68.80	\$72.30	\$83.20			
72	-0720	\$72.60	\$81.30	\$72.60	\$76.80	\$89.88			
SEMIRIGID and MaxiFlex Direct Solder Connectors									
LTH IN INS	DASH NUM	50 Ω RG 405② M17/133-00006 .085 Tin Pl Cu 405-SBCSBC-	50 Ω RG 405② M17/133-00007 .085 Tin Plate Cu 8TS-SBCSBC-	50 Ω RG 405② M17/133-00013 .085 Tin Plate Al 8AT-SBCSBC-	50 Ω MaxiFlex② (No QPL List) .085 Tin Pl 08F-SBCSBC-	50 Ω RG 405② M17/133-00016 .085 Silver Pl 8SS-SBCSBC-	50 Ω ① Non-Magnetic .085 Tin Pl Cu 8CT-SBCSBC-		
12	-0120	\$52.82	\$52.82	\$53.76	\$54.05	\$58.01	\$51.98		
24	-0240	\$55.84	\$55.84	\$57.72	\$58.30	\$66.22	\$54.16		
36	-0360	\$58.86	\$58.86	\$61.68	\$62.55	\$74.43	\$56.34		
48	-0480	\$61.88	\$61.88	\$65.64	\$66.80	\$82.64	\$58.52		
60	-0600	\$64.90	\$64.90	\$69.60	\$71.05	\$90.85	\$60.70		
72	-0720	\$67.92	\$67.92	CALL	\$75.30	CALL	\$62.88		
Color Designators (add letter to the end of the part number and add \$1.00 to price)									
Black - B		Blue - L		Brown - N		Gray - A		Green - G	
Orange - O		Red - R		Violet - V		Yellow - Y		White - W	

See Page B5 for Cable Characteristics

* Contact Factory for delivery, Consider new RD316 for (RD188) 10% Discount @ 25 pcs. up 4% Discount @ 10 pcs. up

①Silver Plated Copper Center Conductor ②Silver Plated Copper Clad Steel Center Conductor



SSMC Female Plug x SSMC Female Plug



LTH IN INS	DASH NUM	50 Ω RG 174 ③⑤ 1 shield ⑦ 174-CSACSA-	50 Ω RG188* ④③ 1 shield 188-CSACSA-	50 Ω RD 188* ④② 2 shields ⑦ 88D-CSACSA-	50 Ω RG 316 ④② 1 shield ⑩ 316-CSACSA-	50 Ω RD 316 ④②⑦ 2 shields 31D-CSACSA-	50 Ω RG 178 ②⑩ 1 shield 178-CSACSA-	50 Ω RG 196 ②⑩ 1 shield 196-CSACSA-
------------	----------	--	--	--	--	--	--	--

Solder Center, Crimp Outer with Strain Relief

12	-0120	\$44.30	\$45.06	\$47.58	\$44.71	\$45.91	\$50.86	\$50.86
24	-0240	\$44.54	\$46.06	\$51.10	\$45.36	\$47.76	\$51.60	\$51.60
36	-0360	\$44.78	\$47.06	\$54.62	\$46.01	\$49.61	\$52.34	\$52.34
48	-0480	\$45.02	\$48.06	\$58.14	\$46.66	\$51.46	\$53.08	\$53.08
60	-0600	\$45.26	\$49.06	\$61.66	\$47.31	\$53.31	\$53.82	\$53.82
72	-0720	\$45.50	\$50.06	\$65.18	\$47.96	\$55.16	\$54.56	\$54.56

SEMIRIGID and MaxiFlex Direct Solder Connectors

LENGTH IN INCHES	DASH NUMBER	50 Ω ② M17/151-00001 .047 Cu Jacket 4CU-CSACSA-	50 Ω ② (No QPL List) .047 Tin Plate Al 4AT-CSACSA-	50 Ω ② M17/151-00002 .047 Tin Plate Cu 4TS-CSACSA-	50 Ω MaxiFlex ② (No QPL List) .047 Tin Pl 04F-CSACSA-	50 Ω ① Non-Magnetic .047 Tin Plate Cu 4CT-CSACSA-
12	-0120	\$44.04	\$45.49	\$44.04	\$44.74	\$46.92
24	-0240	\$47.84	\$50.74	\$47.84	\$49.24	\$53.60
36	-0360	\$51.64	\$55.99	\$51.64	\$53.74	\$60.28
48	-0480	\$55.44	\$61.24	\$55.44	\$58.24	\$66.96
60	-0600	\$59.24	\$66.49	\$59.24	\$62.74	\$73.64
72	-0720	\$63.04	\$71.74	\$63.04	\$67.24	\$80.32

SEMIRIGID and MaxiFlex Direct Solder Connectors

LTH IN INS	DASH NUM	50 Ω RG 405 ② M17/133-00006 .085 Tin Plate Cu 405-CSACSA-	50 Ω RG 405 ② M17/133-00007 .085 Tin Plate Cu 8TS-CSACSA-	50 Ω RG 405 ② M17/133-00013 .085 Tin Plate Al 8AT-CSACSA-	50 Ω MaxiFlex ② (No QPL List) .085 Tin Pl 08F-CSACSA-	50 Ω RG 405 ② M17/133-00016 .085 Silver Pl 8SS-CSACSA-	50 Ω ① Non-Magnetic .085 Tin Plate Cu 8CT-CSACSA-
12	-0120	\$43.26	\$43.26	\$44.20	\$44.49	\$48.45	\$42.42
24	-0240	\$46.28	\$46.28	\$48.16	\$48.74	\$56.66	\$44.60
36	-0360	\$49.30	\$49.30	\$52.12	\$52.99	\$64.87	\$46.78
48	-0480	\$52.32	\$52.32	\$56.08	\$57.24	\$73.08	\$48.96
60	-0600	\$55.34	\$55.34	\$60.04	\$61.49	\$81.29	\$51.14
72	-0720	\$58.36	\$58.36	CALL	\$65.74	CALL	\$53.32

Color Designators (add letter to the end of the part number and add \$1.00 to price)

Black - B	Blue - L	Brown - N	Gray - A	Green - G
Orange - O	Red - R	Violet - V	Yellow - Y	White - W

See Page B5 for Cable Characteristics

* Contact Factory for delivery, Consider new RD316 for (RD188) 10% Discount @ 25 pcs. up 4% Discount @ 10 pcs. up

① Silver Plated Copper Center Conductor ② Silver Plated Copper Clad Steel Center Conductor



RF Depot.com Inc.

Phone 856-488-2000 Fax 856-488-2020

SSMC Female Plug x SSMC Male Bulkhead Jack



LTH IN INS	DASH NUM	50 Ω RG 174 ③⑤ 1 shield⑦ 174-CSACSF-	50 Ω RG188* ④③ 1 shield 188-CSACSF-	50 Ω RD 188* ④② 2 shields ⑦ 88D-CSACSF-	50 Ω RG 316 ④② 1 shield⑧ 316-CSACSF-	50 Ω RD 316 ④②⑦ 2 shields 31D-CSACSF-	50 Ω RG 178 ②⑧ 1 shield 178-CSACSF-	50 Ω RG 196 ②⑧ 1 shield 196-CSACSF-	
Solder Center, Crimp Outer with Strain Relief									
12	-0120	\$42.45	\$43.21	\$45.73	\$42.86	\$44.06	\$45.98	\$45.98	
24	-0240	\$42.69	\$44.21	\$49.25	\$43.51	\$45.91	\$46.72	\$46.72	
36	-0360	\$42.93	\$45.21	\$52.77	\$44.16	\$47.76	\$47.46	\$47.46	
48	-0480	\$43.17	\$46.21	\$56.29	\$44.81	\$49.61	\$48.20	\$48.20	
60	-0600	\$43.41	\$47.21	\$59.81	\$45.46	\$51.46	\$48.94	\$48.94	
72	-0720	\$43.65	\$48.21	\$63.33	\$46.11	\$53.31	\$49.68	\$49.68	
SEMIRIGID and MaxiFlex Direct Solder Connectors									
LENGTH IN INCHES	DASH NUMBER	50 Ω ② M17/151-00001 .047 Cu Jacket 4CU-CSACSF-	50 Ω ② (No QPL List) .047 Tin Plate Al 4AT-CSACSF-	50 Ω ② M17/151-00002 .047 Tin Plate Cu 4TS-CSACSF-	50 Ω MaxiFlex ② (No QPL List) .047 Tin Plate Braid 04F-CSACSF-	50 Ω ① Non-Magnetic .047 Tin Plate Cu 4CT-CSACSF-			
12	-0120	\$44.10	\$45.55	\$44.10	\$44.80	\$46.98			
24	-0240	\$47.90	\$50.80	\$47.90	\$49.30	\$53.66			
36	-0360	\$51.70	\$56.05	\$51.70	\$53.80	\$60.34			
48	-0480	\$55.50	\$61.30	\$55.50	\$58.30	\$67.02			
60	-0600	\$59.30	\$66.55	\$59.30	\$62.80	\$73.70			
72	-0720	\$63.10	\$71.80	\$63.10	\$67.30	\$80.38			
SEMIRIGID and MaxiFlex Direct Solder Connectors									
LTH IN INS	DASH NUM	50 Ω RG 405② M17/133-00006 .085 Tin Plate Cu 405-CSACSF-	50 Ω RG 405② M17/133-00007 .085 Tin Plate Cu 8TS-CSACSF-	50 Ω RG 405② M17/133-00013 .085 Tin Plate Al 8AT-CSACSF-	50 Ω MaxiFlex② (No QPL List) .085 Tin Pl 08F-CSACSF-	50 Ω RG 405② M17/133-00016 .085 Silver Pl 8SS-CSACSF-	50 Ω ① Non-Magnetic .085 Tin Plate Cu 8CT-CSACSF-		
12	-0120	\$45.66	\$45.66	\$46.60	\$46.89	\$50.85	\$44.82		
24	-0240	\$48.68	\$48.68	\$50.56	\$51.14	\$59.06	\$47.00		
36	-0360	\$51.70	\$51.70	\$54.52	\$55.39	\$67.27	\$49.18		
48	-0480	\$54.72	\$54.72	\$58.48	\$59.64	\$75.48	\$51.36		
60	-0600	\$57.74	\$57.74	\$62.44	\$63.89	\$83.69	\$53.54		
72	-0720	\$60.76	\$60.76	CALL	\$68.14	CALL	\$55.72		
Color Designators (add letter to the end of the part number and add \$1.00 to price)									
Black - B		Blue - L		Brown - N		Gray - A		Green - G	
Orange - O		Red - R		Violet - V		Yellow - Y		White - W	

See Page B5 for Cable Characteristics

* Contact Factory for delivery, Consider new RD316 for (RD188) 10% Discount @ 25 pcs. up 4% Discount @ 10 pcs. up

①Silver Plated Copper Center Conductor ②Silver Plated Copper Clad Steel Center Conductor



RF Depot.com Inc.

Phone 856-488-2000 Fax 856-488-2020

7850 Browning Rd. Pennsauken, NJ 08109

Online @ www.rfdepot.com

Toll Free 877-RF Depot

B215

SSMC Female Plug x SSMC Right Angle Female Plug

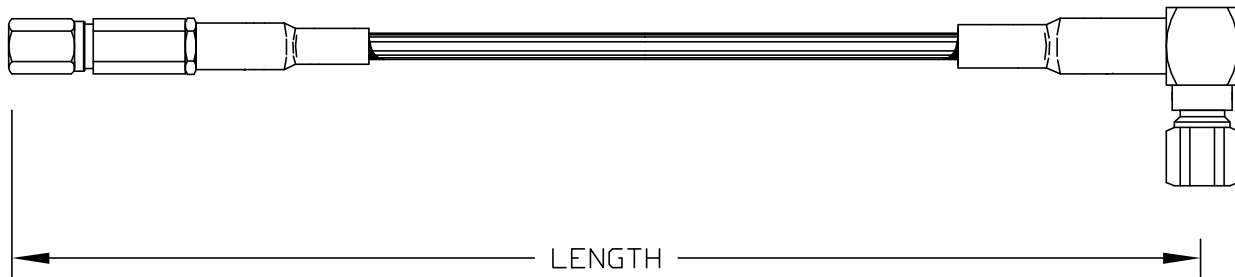

LTH IN INS	DASH NUM	50 Ω RG 174 ①② 1 shield 174-CSACSC-	50 Ω RG188* ①③ 1 shield 188-CSACSC-	50 Ω RD 188* ①② 2 shields 88D-CSACSC-	50 Ω RG 316 ①② 1 shield 316-CSACSC-	50 Ω RD 316 ①②⑦ 2 shields 31D-CSACSC-	50 Ω RG 178 ②⑧ 1 shield 178-CSACSC-	50 Ω RG 196 ②⑧ 1 shield 196-CSACSC-
Solder Center, Crimp Outer with Strain Relief								
12	-0120	\$40.59	\$41.35	\$43.87	\$41.00	\$42.20	\$41.09	\$41.09
24	-0180	\$40.83	\$42.35	\$47.39	\$41.65	\$44.05	\$41.83	\$41.83
36	-0240	\$41.07	\$43.35	\$50.91	\$42.30	\$45.90	\$42.57	\$42.57
48	-0480	\$41.31	\$44.35	\$54.43	\$42.95	\$47.75	\$43.31	\$43.31
SEMIRIGID and MaxiFlex Direct Solder Connectors								
LENGTH IN INCHES	DASH NUMBER	50 Ω ② M17/151-00001 .047 Cu Jacket 4CU-CSACSC-	50 Ω ② (No QPL List) .047 Tin Plate Al 4AT-CSACSC-	50 Ω ② M17/151-00002 .047 Tin Plate Cu 4TS-CSACSC-	50 Ω MaxiFlex ② (No QPL List) .047 Tin Plate Braid 04F-CSACSC-	50 Ω ① Non-Magnetic .047 Tin Plate Cu 4CT-CSACSC-		
12	-0120	\$42.08	\$43.53	\$42.08	\$42.78	\$44.96		
24	-0240	\$45.88	\$48.78	\$45.88	\$47.28	\$51.64		
36	-0360	\$49.68	\$54.03	\$49.68	\$51.78	\$58.32		
48	-0480	\$53.48	\$59.28	\$53.48	\$56.28	\$65.00		
60	-0600	\$57.28	\$64.53	\$57.28	\$60.78	\$71.68		
72	-0720	\$61.08	\$69.78	\$61.08	\$65.28	\$78.36		
SEMIRIGID and MaxiFlex Direct Solder Connectors								
LTH IN INS	DASH NUM	50 Ω RG 405② M17/133-00006 .085 Tin Pl Cu 405-CSACSC-	50 Ω RG 405② M17/133-00007 .085 Tin Plate Cu 8TS-CSACSC-	50 Ω RG 405② M17/133-00013 .085 Tin Plate Al 8AT-CSACSC-	50 Ω MaxiFlex② (No QPL List) .085 Tin Pl 08F-CSACSC-	50 Ω RG 405② M17/133-00016 .085 Silver Pl 8SS-CSACSC-	50 Ω ① Non-Magnetic .085 Tin Pl Cu 8CT-CSACSC-	
12	-0120	\$41.30	\$41.30	\$42.24	\$42.53	\$46.49	\$40.46	
24	-0240	\$44.32	\$44.32	\$46.20	\$46.78	\$54.70	\$42.64	
36	-0360	\$47.34	\$47.34	\$50.16	\$51.03	\$62.91	\$44.82	
48	-0480	\$50.36	\$50.36	\$54.12	\$55.28	\$71.12	\$47.00	
60	-0600	\$53.38	\$53.38	\$58.08	\$59.53	\$79.33	\$49.18	
72	-0720	\$56.40	\$56.40	CALL	\$63.78	CALL	\$51.36	
Color Designators (add letter to the end of the part number and add \$1.00 to price)								
Black - B		Blue - L		Brown - N		Gray - A		Green - G
Orange - O		Red - R		Violet - V		Yellow - Y		White - W

See Page B5 for Cable Characteristics

* Contact Factory for delivery, Consider new RD316 for (RD188) 10% Discount @ 25 pcs. up 4% Discount @ 10 pcs. up

①Silver Plated Copper Center Conductor ②Silver Plated Copper Clad Steel Center Conductor



RF Depot.com Inc.

Phone 856-488-2000 Fax 856-488-2020

B216

7850 Browning Rd. Pennsauken, NJ 08109

Online @ www.rfdepot.com

Toll Free 877-RF Depot

SSMC Male Bulkhead Jack x SSMC Right Angle Female Plug

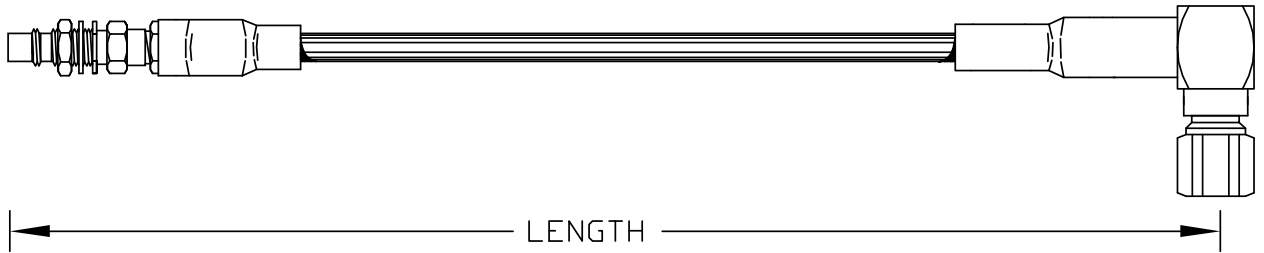

LENGTH IN INCHES	DASH NUM	50 Ω RG 174 ②⑤ 1 shield ⑦ 174-CSCCSF-	50 Ω RG188* ④③ 1 shield 188-CSCCSF-	50 Ω RD 188* ④② 2 shields ⑦ 88D-CSCCSF-	50 Ω RG 316 ④② 1 shield ⑧ 316-CSCCSF-	50 Ω RD 316 ④②⑦ 2 shields 31D-CSCCSF-	50 Ω RG 178 ②⑩ 1 shield 178-CSCCSF-	50 Ω RG 196 ②⑩ 1 shield 196-CSCCSF-	
Solder Center, Crimp/Clamp Outer with Strain Relief									
12	-0120E	\$38.74	\$39.50	\$42.02	\$39.15	\$40.35	\$39.24	\$39.24	
24	-0240E	\$38.98	\$40.50	\$45.54	\$39.80	\$42.20	\$39.98	\$39.98	
36	-0360E	\$39.22	\$41.50	\$49.06	\$40.45	\$44.05	\$40.72	\$40.72	
48	-0480E	\$39.46	\$42.50	\$52.58	\$41.10	\$45.90	\$41.46	\$41.46	
60	-0600E	\$39.70	\$43.50	\$56.10	\$41.75	\$47.75	\$42.20	\$42.20	
72	-0720E	\$39.94	\$44.50	\$59.62	\$42.40	\$49.60	\$42.94	\$42.94	
SEMIRIGID and MaxiFlex Direct Solder Connectors									
LENGTH IN INCHES	DASH NUMBER	50 Ω ② M17/151-00001 .047 Cu Jacket 4CU-CSCCSF-	50 Ω ② (No QPL List) .047 Tin Plate Al 4AT-CSCCSF-	50 Ω ② M17/151-00002 .047 Tin Plate Cu 4TS-CSCCSF-	50 Ω MaxiFlex ② (No QPL List) .047 Tin Pl 04F-CSCCSF-	50 Ω ① Non-Magnetic .047 Tin Plate Cu 4CT-CSCCSF-			
12	-0120E	\$42.14	\$43.59	\$42.14	\$42.84	\$45.02			
24	-0240E	\$45.94	\$48.84	\$45.94	\$47.34	\$51.70			
36	-0360E	\$49.74	\$54.09	\$49.74	\$51.84	\$58.38			
48	-0480E	\$53.54	\$59.34	\$53.54	\$56.34	\$65.06			
60	-0600E	\$57.34	\$64.59	\$57.34	\$60.84	\$71.74			
72	-0720E	\$61.14	\$69.84	\$61.14	\$65.34	\$78.42			
SEMIRIGID and MaxiFlex Direct Solder Connectors									
LTH IN INS	DASH NUM	50 Ω RG 405② M17/133-00006 .085 Tin Plate Cu 405-CSCCSF-	50 Ω RG 405② M17/133-00007 .085 Tin Plate Cu 8TS-CSCCSF-	50 Ω RG 405② M17/133-00013 .085 Tin Plate Al 8AT-CSCCSF-	50 Ω MaxiFlex② (No QPL List) .085 Tin Pl 08F-CSCCSF-	50 Ω RG 405② M17/133-00016 .085 Silver Pl 8SS-CSCCSF-	50 Ω ① Non-Magnetic .085 Tin Plate Cu 8CT-CSCCSF-		
12	-0120E	\$43.70	\$43.70	\$44.64	\$44.93	\$48.89	\$42.86		
24	-0240E	\$46.72	\$46.72	\$48.60	\$49.18	\$57.10	\$45.04		
36	-0360E	\$49.74	\$49.74	\$52.56	\$53.43	\$65.31	\$47.22		
48	-0480E	\$52.76	\$52.76	\$56.52	\$57.68	\$73.52	\$49.40		
60	-0600E	\$55.78	\$55.78	\$60.48	\$61.93	\$81.73	\$51.58		
72	-0720E	\$58.80	\$58.80	CALL	\$66.18	CALL	\$53.76		
Color Designators (add letter to the end of the part number and add \$1.00 to price)									
Black - B		Blue - L		Brown - N		Gray - A		Green - G	
Orange - O		Red - R		Violet - V		Yellow - Y		White - W	

See Page B5 for Cable Characteristics

* Contact Factory for delivery, Consider new RD316 for (RD188) 10% Discount @ 25 pcs. up 4% Discount @ 10 pcs. up

①Silver Plated Copper Center Conductor ②Silver Plated Copper Clad Steel Center Conductor



RF Depot.com Inc.

Phone 856-488-2000 Fax 856-488-2020

7850 Browning Rd. Pennsauken, NJ 08109

Online @ www.rfdepot.com

Toll Free 877-RF Depot

B217

SSMC Right Angle Female Plug x SSMC Right Angle Female Plug

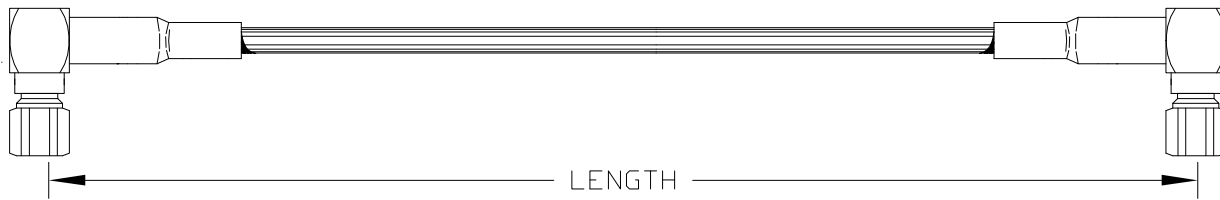

LTH IN INS	DASH NUM	50 Ω RG 174 ②③ 1 shield ⑦ 174-CSCCSC-	50 Ω RG188* ④③ 1 shield 188-CSCCSC-	50 Ω RD 188* ④② 2 shields ⑦ 88D-CSCCSC-	50 Ω RG 316 ④② 1 shield ⑩ 316-CSCCSC-	50 Ω RD 316 ④②⑦ 2 shields 31D-CSCCSC-	50 Ω RG 178 ②⑩ 1 shield 178-CSCCSC-	50 Ω RG 196 ②⑩ 1 shield 196-CSCCSC-	
Solder Center, Crimp Outer with Strain Relief									
12	-0120	\$55.20	\$55.96	\$59.08	\$55.61	\$57.41	\$55.70	\$55.70	
24	-0240	\$55.44	\$56.96	\$62.60	\$56.26	\$59.26	\$56.44	\$56.44	
36	-0360	\$55.68	\$57.96	\$66.12	\$56.91	\$61.11	\$57.18	\$57.18	
48	-0480	\$55.92	\$58.96	\$69.64	\$57.56	\$62.96	\$57.92	\$57.92	
60	-0600	\$56.16	\$59.96	\$73.16	\$58.21	\$64.81	\$58.66	\$58.66	
72	-0600	\$56.40	\$60.96	\$76.68	\$58.86	\$66.66	\$59.40	\$59.40	
SEMIRIGID and MaxiFlex Direct Solder Connectors									
LENGTH IN INCHES	DASH NUMBER	50 Ω ② M17/151-00001 .047 Cu Jacket 4CU-CSCCSC-	50 Ω ② (No QPL List) .047 Tin Plate Al 4AT-CSCCSC-	50 Ω ② M17/151-00002 .047 Tin Plate Cu 4TS-CSCCSC-	50 Ω MaxiFlex ② (No QPL List) .047 Tin Plate Braid 04F-CSCCSC-	50 Ω ① Non-Magnetic .047 Tin Plate Cu 4CT-CSCCSC-			
12	-0120	\$58.28	\$59.73	\$58.28	\$58.98	\$61.16			
24	-0240	\$62.08	\$64.98	\$62.08	\$63.48	\$67.84			
36	-0360	\$65.88	\$70.23	\$65.88	\$67.98	\$74.52			
48	-0480	\$69.68	\$75.48	\$69.68	\$72.48	\$81.20			
60	-0600	\$73.48	\$80.73	\$73.48	\$76.98	\$87.88			
72	-0600	\$77.28	\$85.98	\$77.28	\$81.48	\$94.56			
SEMIRIGID and MaxiFlex Direct Solder Connectors									
LENGTH IN INCHES	DASH NUM	50 Ω RG 405 ② M17/133-00006 .085 Tin Pl Cu 405-CSCCSC-	50 Ω RG 405 ② M17/133-00007 .085 Tin Pl Cu 8TS-CSCCSC-	50 Ω RG 405 ② M17/133-00013 .085 Tin Plate Al 8AT-CSCCSC-	50 Ω MaxiFlex ② (No QPL List) .085 Tin Pl 08F-CSCCSC-	50 Ω RG 405 ② M17/133-00016 .085 Silver Pl 8SS-CSCCSC-	50 Ω RG 405 ① Non-Magnetic .085 Tin Pl Cu 8CT-CSCCSC-		
12	-0120	\$57.50	\$57.50	\$58.44	\$58.73	\$62.69	\$56.66		
24	-0240	\$60.52	\$60.52	\$62.40	\$62.98	\$70.90	\$58.84		
36	-0360	\$63.54	\$63.54	\$66.36	\$67.23	\$79.11	\$61.02		
48	-0480	\$66.56	\$66.56	\$70.32	\$71.48	\$87.32	\$63.20		
60	-0600	\$69.58	\$69.58	\$74.28	\$75.73	\$95.53	\$65.38		
72	-0600	\$72.60	\$72.60	CALL	\$79.98	CALL	\$67.56		
Color Designators (add letter to the end of the part number and add \$1.00 to price)									
Black - B		Blue - L		Brown - N		Gray - A		Green - G	
Orange - O		Red - R		Violet - V		Yellow - Y		White - W	

See Page B5 for Cable Characteristics

* Contact Factory for delivery, Consider new RD316 for (RD188) 10% Discount @ 25 pcs. up 4% Discount @ 10 pcs. up

① Silver Plated Copper Center Conductor ② Silver Plated Copper Clad Steel Center Conductor



RF Depot.com Inc.

Phone 856-488-2000 Fax 856-488-2020

TNC Male Plug x TNC Male Plug

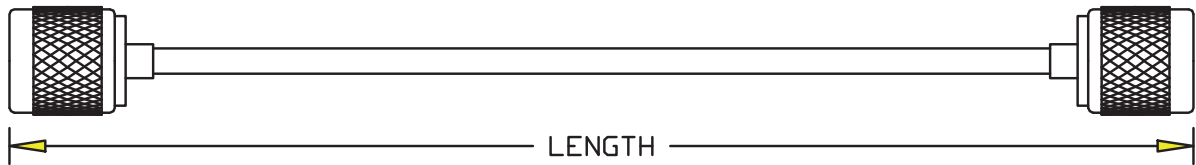

LENGTH IN INCHES	DASH NUMBER	50 Ω RG 58C ③⑥ 1 shield ⑦ 058-TATA-	50 Ω RG 223 ③① 2 shields⑦ 223-TATA-	50 Ω RG 142B④② 2 shields⑦ 142-TATA-	50 Ω RG 400×④① 2 shields ⑦ 400-TATA-	75 Ω RG 179A ④② 1 shield ⑩ 179-TATA-	
Solder Center, Crimp Outer with Strain Relief							
12	-0120	\$21.18	\$28.89	\$29.72	\$30.42	\$26.71	
24	-0240	\$21.58	\$30.36	\$32.02	\$33.42	\$27.44	
36	-0360	\$21.98	\$31.83	\$34.32	\$36.42	\$28.17	
48	-0480	\$22.38	\$33.30	\$36.62	\$39.42	\$28.90	
60	-0600	\$22.78	\$34.77	\$38.92	\$42.42	\$29.63	
72	-0720	\$23.18	\$36.24	\$41.22	\$45.42	\$30.36	
Solder Center, Crimp Outer with Strain Relief							
LENGTH IN INCHES	DASH NUMBER	50 Ω RG174 ③⑤ 1 shield ⑦ 174-TATA-	50 Ω RG 316 ④② 1 shield ⑩ 316-TATA-	50 Ω RD 316 ④② 2 shields ⑦ 31D-TATA-	50 Ω RG188* ④ 1 shield ③ 188-TATA-	50 Ω RG 178 ② 2 shields ⑩ 178-TATA-	50 Ω RG 196② 2 shields ⑩ 196-TATA-
12	-0120	\$24.42	\$24.83	\$26.43	\$25.18	\$38.00	\$38.00
24	-0240	\$24.66	\$25.48	\$28.28	\$26.18	\$39.00	\$39.00
36	-0360	\$24.90	\$26.13	\$30.13	\$27.18	\$40.00	\$40.00
48	-0480	\$25.14	\$26.78	\$31.98	\$28.18	\$41.00	\$41.00
60	-0600	\$25.38	\$27.43	\$33.83	\$29.18	\$42.00	\$42.00
72	-0720	\$25.62	\$28.08	\$35.68	\$30.18	\$43.00	\$43.00
Solder Center, Crimp Outer with Strain Relief							
LENGTH IN INCHES	DASH NUMBER	50 Ω RG 8* ③③ 1 shield ⑧ 008-TATA-	50 Ω RG 213 ③③ 1 shield ⑧ 213-TATA-	50 Ω RG 214③① 2 shields⑦ 214-TATA-	75 Ω RG 59B③⑤ 1 shield ⑧ 059-TATA-	75 Ω RG 62 ③⑤ 1 shield ⑧ 062-TATA-	50 Ω RG 393④① 2 shields⑦ 393-TATA-
12	-0120	\$25.76	\$25.94	\$28.84	\$31.00	\$31.26	\$33.97
24	-0240	\$27.16	\$27.52	\$32.34	\$31.44	\$31.96	\$42.60
36	-0360	\$28.56	\$29.10	\$35.84	\$31.88	\$32.66	\$51.23
48	-0480	\$29.96	\$30.68	\$39.34	\$32.32	\$33.36	\$59.86
60	-0600	\$31.36	\$32.26	\$42.84	\$32.76	\$34.06	\$68.49
72	-0720	\$32.76	\$33.84	\$46.34	\$33.20	\$34.76	\$77.12
Color Designators (add letter to the end of the part number and add \$1.00 to price)							
Black - B		Blue - L		Brown - N		Gray - A	
Orange - O		Red - R		Violet - V		Green - G	
						White - W	

See Page B5 for Cable Characteristics

* Contact Factory for delivery, Consider new RD316 for (RD188)

10% Discount @ 25 pcs. up

4% Discount @ 10 pcs. up

TNC Male Plug x TNC Male Plug

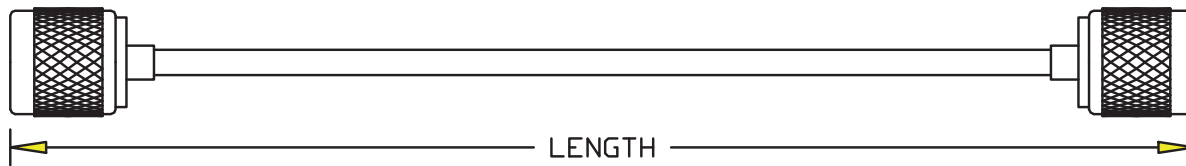

LENGTH IN INCHES	DASH NUM	50 Ω ^⑤ CCS 100 [Ⓞ] 2 shields [Ⓢ] 1LC-TATA-	50 Ω ^⑤ LMR 100 [Ⓞ] 2 shields [Ⓢ] 1LM-TATA-	50 Ω ^③ CCS 195 [Ⓞ] 2 shields [Ⓢ] 19C-TATA-	50 Ω ^③ LMR 195 [Ⓞ] 2 shields [Ⓢ] 19M-TATA-	50 Ω ^③ CCS 200 [Ⓞ] 2 shields [Ⓢ] 2LC-TATA-	50 Ω ^③ LMR 200 [Ⓞ] 2 shields [Ⓢ] 2LM-TATA-	50 Ω ^③ CCS 240 [Ⓞ] 2 shields [Ⓢ] 24C-TATA-	50 Ω ^③ LMR 240 [Ⓞ] 2 shields [Ⓢ] 24L-TATA-
Solder Center, Crimp Outer with Strain Relief, Low Loss Flexible									
48	-0480	\$28.14	\$28.62	\$23.06	\$23.62	\$22.68	\$22.88	\$23.70	\$25.38
72	-0720	\$29.22	\$29.94	\$24.20	\$25.04	\$24.04	\$24.34	\$24.90	\$27.42
96	-0960	\$30.30	\$31.26	\$25.34	\$26.46	\$25.40	\$25.80	\$26.10	\$29.46
120	-1200	\$31.38	\$32.58	\$26.48	\$27.88	\$26.76	\$27.26	\$27.30	\$31.50
144	-1440	\$32.46	\$33.90	\$27.62	\$29.30	\$28.12	\$28.72	\$28.50	\$33.54
180	-1800	\$34.08	\$35.88	\$29.33	\$31.43	\$30.16	\$30.91	\$30.30	\$36.60
240	-2400	\$36.78	\$39.18	\$32.18	\$34.98	\$33.56	\$34.56	\$33.30	\$41.70
Solder Center, Crimp and Clamp Outer, Low Loss Flexible									
LTH IN INS	DASH NUM	50 Ω ^③ CCS 300 [Ⓞ] 2 shields [Ⓢ] 3LC-TATA-	50 Ω ^③ LMR 300 [Ⓞ] 2 shields [Ⓢ] 3LM-TATA-	50 Ω ^④ CCS 400 [Ⓞ] 2 shields [Ⓢ] 4LC-TATA-	50 Ω ^④ LMR 400 [Ⓞ] 2 shields [Ⓢ] 4LM-TATA-	50 Ω ^④ CCS 400DB [Ⓞ] 2 shields [Ⓢ] 4DC-TATA-	50 Ω ^④ LMR 400DB [Ⓞ] 2 shields [Ⓢ] 4LD-TATA-	50 Ω ^④ CCS 400FR [Ⓞ] 2 shields [Ⓢ] 4RC-TATA-	50 Ω ^④ LMR 400FR [Ⓞ] 2 shields [Ⓢ] 4LR-TATA-
48	-0480	\$44.40	\$46.00	\$29.26	\$31.34	\$29.74	\$32.22	\$29.74	\$33.42
72	-0720	\$45.84	\$48.24	\$30.98	\$34.10	\$31.70	\$35.42	\$31.70	\$37.22
96	-0960	\$47.28	\$50.48	\$32.70	\$36.86	\$33.66	\$38.62	\$33.66	\$41.02
120	-1200	\$48.72	\$52.72	\$34.42	\$39.62	\$35.62	\$41.82	\$35.62	\$44.82
144	-1440	\$50.16	\$54.96	\$36.14	\$42.38	\$37.58	\$45.02	\$37.58	\$48.62
180	-1800	\$52.32	\$58.32	\$38.72	\$46.52	\$40.52	\$49.82	\$40.52	\$54.32
240	-2400	\$55.92	\$63.92	\$43.02	\$53.42	\$45.42	\$57.82	\$45.42	\$63.82
Solder Center, Crimp Outer with Strain Relief									
LTH IN INS	DASH NUM	50 Ω ^④ CCS 400UF [Ⓞ] 2 shields [Ⓢ] 4UC-TATA-	50 Ω ^④ LMR 400UF [Ⓞ] 2 shields [Ⓢ] 4UF-TATA-	50 Ω LL 142 2 shields [Ⓢ] 4LL-TATA-	50 Ω EF 142 [Ⓞ] 2 shields [Ⓢ] 42E-TATA-	50 Ω EF 400 [Ⓞ] 2 shields [Ⓢ] 40E-TATA-	50 Ω T COM 195 3 shields [Ⓢ] 19T-TATA-	50 Ω SF 142B [Ⓞ] 3 shields [Ⓢ] S42-TATA-	50 Ω SFT 142 [Ⓞ] 3 shields [Ⓢ] 42T-TATA-
72	-0720	\$31.70	\$37.22	\$189.06	\$51.06	\$56.42	\$47.94	\$73.86	\$100.50
96	-0960	\$33.66	\$41.02	\$212.66	\$56.10	\$61.54	\$55.94	\$86.50	\$124.02
120	-1200	\$35.62	\$44.82	\$236.26	\$61.14	\$66.66	\$63.94	\$99.14	\$147.54
144	-1440	\$37.58	\$48.62	\$259.86	\$66.18	\$71.30	\$71.94	\$111.78	\$171.06
180	-1800	\$40.52	\$54.32	\$295.26	\$73.74	\$78.98	\$83.94	\$130.74	\$206.34
Color Designators (add letter to the end of the part number and add \$1.00 to price)									
Black - B		Blue - L		Brown - N		Gray - A		Green - G	
Orange - O		Red - R		Violet - V		Yellow - Y		White - W	

See Page B5 for Cable Characteristics

* Contact Factory for delivery, Consider new RD316 for (RD188) 10% Discount @ 25 pcs. up 4% Discount @ 10 pcs. up



RF Depot.com Inc.

Phone 856-488-2000 Fax 856-488-2020

B220

7850 Browning Rd. Pennsauken, NJ 08109

Online @ www.rfdepot.com

Toll Free 877-RF Depot

TNC Male Plug x TNC Male Plug

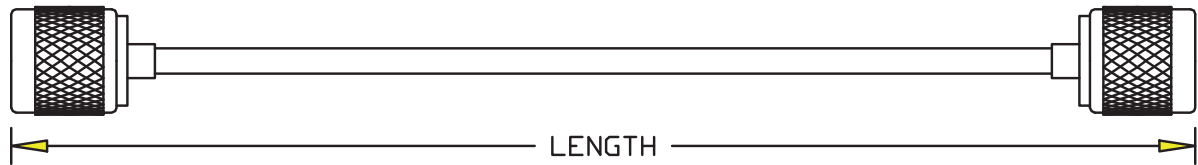

LENGTH IN INCHES	DASH NUMBER	50Ω RG 401Ⓢ M17/129-RG401 .250 Cu Jacket 401-T0T0-	50Ω RG 401Ⓢ (No QPL List) .250 Tin Plate Al 25A-T0T0-	50Ω RG 401Ⓢ M17/129-0001 .250 Tin Plate Cu 2TS-T0T0-	50Ω MaxiFlexⓈ (No QPL List) .250 Tin Plate Braid 25A-T0T0-		
.250" Diameter SEMIRIGID and MaxiFlex Direct Solder Connectors							
12	-0120	\$126.84	\$127.78	\$132.03	\$126.84		
24	-0240	\$129.86	\$131.74	\$140.24	\$129.86		
36	-0360	\$132.88	\$135.70	\$148.45	\$132.88		
48	-0480	\$135.90	\$139.66	\$156.66	\$135.90		
60	-0600	\$138.92	\$143.62	\$164.87	\$138.92		
72	-0720	\$141.94	\$147.58	\$173.08	\$141.94		
.141" Diameter SEMIRIGID and MaxiFlex Direct Solder Connectors							
LENGTH IN INCHES	DASH NUM	50Ω RG 402Ⓢ M17/130-00004 .141 Cu Jacket 402-T0T0-	50Ω RG 402Ⓢ M17/130-00005 .141 Tin Plate Cu 1TS-T0T0-	50Ω RG 402Ⓢ M17/130-00009 .141 Tin Plate Al 1AT-T0T0-	50Ω MaxiFlexⓈ (No QPL List) .141 Tin Pl 14F-T0T0-	50Ω RG 402Ⓢ M17/130-00012 .141 Silver Pl 1SS-T0T0-	
12	-0120	\$111.00	\$110.64	\$111.00	\$110.64	\$120.21	
24	-0240	\$114.60	\$113.88	\$114.60	\$113.88	\$133.02	
36	-0360	\$118.20	\$117.12	\$118.20	\$117.12	\$145.83	
48	-0480	\$121.80	\$120.36	\$121.80	\$120.36	\$158.64	
60	-0600	\$125.40	\$123.60	\$125.40	\$123.60	\$171.45	
72	-0720	\$129.00	\$126.84	CALL	\$126.84	CALL	
.085" Diameter SEMIRIGID and MaxiFlex Direct Solder Connectors							
LENGTH IN INCHES	DASH NUM	50Ω RG 405Ⓢ M17/133-00007 .085 Tin Pl Cu 405-T0T0-	50Ω RG 405Ⓢ M17/133-00007 .085 Tin Pl Cu 8TS-T0T0-	50Ω RG 405Ⓢ M17/133-00013 .085 Tin Plate Al 8AT- T0T0-	50Ω MaxiFlexⓈ (No QPL List) .086 Tin Pl 08F-T0T0-	50Ω RG 405Ⓢ M17/133-00016 .085 Silver Pl 8SS-T0T0-	
12	-0120	\$105.02	\$105.02	\$105.96	\$106.25	\$110.21	
24	-0240	\$108.04	\$108.04	\$109.92	\$110.50	\$118.42	
36	-0360	\$111.06	\$111.06	\$113.88	\$114.75	\$126.63	
48	-0480	\$114.08	\$114.08	\$117.84	\$119.00	\$134.84	
60	-0600	\$117.10	\$117.10	\$121.80	\$123.25	\$143.05	
72	-0720	\$120.12	\$120.12	CALL	\$127.50	CALL	
Color Designators (add letter to the end of the part number and add \$1.00 to price)							
Black - B		Blue - L		Brown - N		Gray - A	
Orange - O		Red - R		Violet - V		Yellow - Y	
						Green - G	
						White - W	

See Page B5 for Cable Characteristics

* Contact Factory for delivery, Consider new RD316 for (RD188) 10% Discount @ 25 pcs. up 4% Discount @ 10 pcs. up

ⓈSilver Plated Copper Center Conductor ⓈSilver Plated Copper Clad Steel Center Conductor



RF Depot.com Inc.

Phone 856-488-2000 Fax 856-488-2020

7850 Browning Rd. Pennsauken, NJ 08109

Online @ www.rfdepot.com

Toll Free 877-RF Depot

B221

TNC Male Plug x TNC Male Plug Commercial

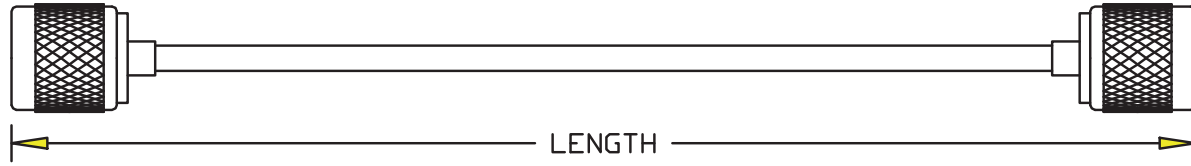

LENGTH IN INCHES	DASH NUMBER	50Ω RG 402 [Ⓢ] M17/130-00004 .141 Cu Jacket 402-T0T0-	50Ω RG 402 [Ⓢ] M17/130-00005 .141 Tin Pl Cu 1TS-T0T0-	50Ω RG 402 [Ⓢ] M17/130-00009 .141 Tin Pl Al 1AT-T0T0-	50Ω MaxiFlex [Ⓢ] (No QPL List) .141 Tin Pl 14F-T0T0-	50Ω RG 402 [Ⓢ] M17/130-00012 .141 Silver Pl 1SS-T0T0-
.141" Diameter SEMIRIGID and MaxiFlex Direct Solder Connectors						
12	-0120C	\$45.30	\$44.94	\$45.30	\$44.94	\$54.51
24	-0240C	\$48.90	\$48.18	\$48.90	\$48.18	\$67.32
36	-0360C	\$52.50	\$51.42	\$52.50	\$51.42	\$80.13
48	-0480C	\$56.10	\$54.66	\$56.10	\$54.66	\$92.94
60	-0600C	\$59.70	\$57.90	\$59.70	\$57.90	\$105.75
72	-0720C	\$63.30	\$61.14	CALL	\$61.14	CALL
.085" Diameter SEMIRIGID and Maxi Flex. Direct Solder Connectors						
LENGTH IN INCHES	DASH NUM	50Ω RG 405 [Ⓢ] M17/133-00006 .085 Tin Pl Cu 405-T0T0-	50Ω RG 405 [Ⓢ] M17/133-00007 .085 Tin Pl Cu 8TS-T0T0-	50Ω RG 405 [Ⓢ] M17/133-00013 .085 Tin Pl Al 8AT-T0T0-	50Ω MaxiFlex [Ⓢ] (No QPL List) .086 Tin Pl 08F-T0T0-	50Ω RG 405 [Ⓢ] M17/133-00016 .085 Silver Pl 8SS-T0T0-
12	-0120C	\$45.12	\$45.12	\$46.06	\$46.35	\$50.31
24	-0240C	\$48.14	\$48.14	\$50.02	\$50.60	\$58.52
36	-0360C	\$51.16	\$51.16	\$53.98	\$54.85	\$66.73
48	-0480C	\$54.18	\$54.18	\$57.94	\$59.10	\$74.94
60	-0600C	\$57.20	\$57.20	\$61.90	\$63.35	\$83.15
72	-0720C	\$60.22	\$60.22	CALL	\$67.60	CALL
.047" Diameter SEMIRIGID and Maxi Flex. Direct Solder Connectors						
LENGTH IN INCHES	DASH NUMBER	50Ω [Ⓢ] M17/151-00001 .047 Cu Jacket 4CU-T0T0-	50Ω [Ⓢ] (No QPL List) .047 Tin Plate Al 4AT-T0T0-	50Ω [Ⓢ] M17/151-00002 .047 Tin Plate Cu 4TS-T0T0-	50Ω MaxiFlex [Ⓢ] (No QPL List) .047 Tin Plate Braid 04F-T0T0-	
12	-0120C	\$51.80	\$53.25	\$51.80	\$52.50	
24	-0240C	\$55.60	\$58.50	\$55.60	\$57.00	
36	-0360C	\$59.40	\$63.75	\$59.40	\$61.50	
48	-0480C	\$63.20	\$69.00	\$63.20	\$66.00	
60	-0600C	\$67.00	\$74.25	\$67.00	\$70.50	
72	-0720C	\$70.80	\$79.50	\$70.80	\$75.00	

Ⓢ Silver Plated Copper Center Conductor Ⓢ Silver Plated Copper Clad Steel Center Conductor

10% Discount @ 25 pcs. up 4% Discount @ 10 pcs. up



RF Depot.com Inc.

Phone 856-488-2000 Fax 856-488-2020

B222

7850 Browning Rd. Pennsauken, NJ 08109

Online @ www.rfdepot.com

Toll Free 877-RF Depot

TNC Male Plug x TNC Reverse Polarity Jack

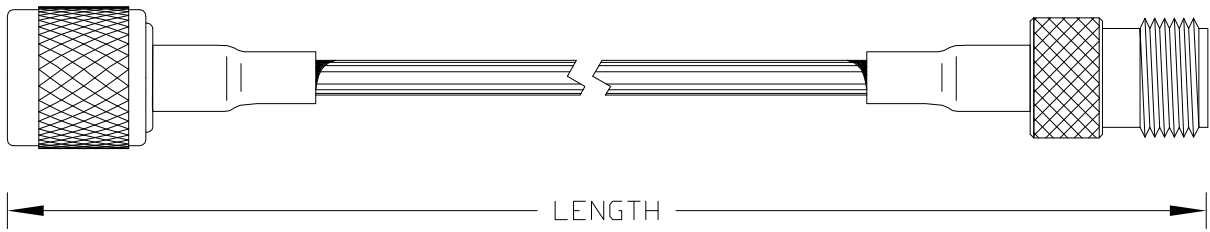

LENGTH IN INCHES	DASH NUMBER	50 Ω SIG 100 ①② 2 shields③ 1LC-TATN-	50 Ω LMR 100 ①② 2 shields③ 1LM-TATN-	50 Ω SIG 195 ①③ 2 shields③ 19C-TATN-	50 Ω③ LMR 195 ① 2 shields③ 19M-TATN-	50 Ω LMR 200 ① 2 shields 2LC-TATN-	50 Ω LMR 200 ① 2 shields 2LM-TATN-		
Solder Center, Crimp Outer with Strain Relief									
12	-0120	\$21.75	\$21.87	\$23.07	\$23.21	\$22.54	\$22.59		
24	-0240	\$22.29	\$22.53	\$23.64	\$23.92	\$23.22	\$23.32		
36	-0360	\$22.83	\$23.19	\$24.21	\$24.63	\$23.90	\$24.05		
48	-0480	\$23.37	\$23.85	\$24.78	\$25.34	\$24.58	\$24.78		
60	-0600	\$23.91	\$24.51	\$25.35	\$26.05	\$25.26	\$25.51		
Solder Center, Crimp Outer with Strain Relief									
LENGTH IN INCHES	DASH NUMBER	50 Ω③ SIG 240 ① 2 shields③ 24C-TATN-	50 Ω LMR 240 ①③ 2 shields③ 24L-TATN-	50 Ω③ SIG 300 ① 2 shields③ 3LC-TATN-	50 Ω LMR 300 ①③ 2 shields③ 3LM-TATN-	50 Ω SIG 400 ①④ 2 shields③ 4LC-TATN-	50 Ω④ LMR 400 ① 2 shields③ 4LM-TATN-		
12	-0120	\$30.77	\$31.19	\$44.71	\$45.11	\$26.61	\$27.13		
24	-0240	\$31.37	\$32.21	\$45.43	\$46.23	\$27.47	\$28.51		
36	-0360	\$31.97	\$33.23	\$46.15	\$47.35	\$28.33	\$29.89		
48	-0480	\$32.57	\$34.25	\$46.87	\$48.47	\$29.19	\$31.27		
60	-0600	\$33.17	\$35.27	\$47.59	\$49.59	\$30.05	\$32.65		
Solder Center, Crimp Outer with Strain Relief									
LTH IN INS	DASH NUM	50 Ω④ SIG 400DB ① 2 shields③ 4DC-TATN-	50 Ω④ LMR 400DB ① 2 shields③ 4LD-TATN-	50 Ω SIG 400FR ①④ 2 shields③ 4RC-TATN-	50 Ω④ LMR 400FR ① 2 shields③ 4LR-TATN-	50 Ω④ SIG 400UF ① 2 shields③ 4UC-TATN-	50 Ω④ LMR 400UF ① 2 shields③ 4UF-TATN-	50 Ω④ LMR 600 ① 2 shields③ 6LM-TATN-	
12	-0120	\$26.73	\$27.35	\$26.73	\$27.65	\$26.73	\$27.65	\$40.06	
24	-0240	\$27.71	\$28.95	\$27.71	\$29.55	\$27.71	\$29.55	\$42.06	
36	-0360	\$28.69	\$30.55	\$28.69	\$31.45	\$28.69	\$31.45	\$44.06	
48	-0480	\$29.67	\$32.15	\$29.67	\$33.35	\$29.67	\$33.35	\$46.06	
60	-0600	\$30.65	\$33.75	\$30.65	\$35.25	\$30.65	\$35.25	\$48.06	
72	-0720	\$31.63	\$35.35	\$31.63	\$37.15	\$31.63	\$37.15	\$50.06	
Color Designators (add letter to the end of the part number and add \$1.00 to price)									
Black - B		Blue - L		Brown - N		Gray - A		Green - G	
Orange - O		Red - R		Violet - V		Yellow - Y		White - W	

See Page B5 for Cable Characteristics

* Contact Factory for delivery, Consider new RD316 for (RD188)

10% Discount @ 25 pcs. up

4% Discount @ 10 pcs. up

TNC Male Plug x TNC Reverse Polarity Plug

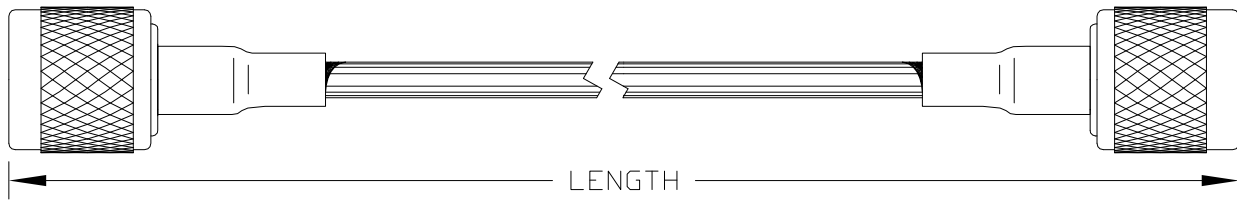

LENGTH IN INCHES	DASH NUMBER	50 Ω SIG 100 [Ⓞ] [Ⓜ] 2 shields [Ⓞ] 1LC-TATM-	50 Ω [Ⓞ] LMR 100 [Ⓞ] 2 shields [Ⓞ] 1LM-TATM-	50 Ω SIG 195 [Ⓞ] [Ⓜ] 2 shields [Ⓞ] 19C-TATM-	50 Ω LMR 195 [Ⓞ] [Ⓜ] 2 shields [Ⓞ] 19M-TATM-	50 Ω SIG 200 [Ⓞ] [Ⓜ] 2 shields [Ⓞ] 2LC-TATM-	50 Ω LMR 200 [Ⓞ] 2 shields [Ⓞ] 2LM-TATM-		
Solder Center, Crimp Outer with Strain Relief									
12	-0120	\$22.65	\$22.77	\$22.50	\$22.64	\$22.54	\$22.59		
24	-0240	\$23.19	\$23.43	\$23.07	\$23.35	\$23.22	\$23.32		
36	-0360	\$23.73	\$24.09	\$23.64	\$24.06	\$23.90	\$24.05		
48	-0480	\$24.27	\$24.75	\$24.21	\$24.77	\$24.58	\$24.78		
60	-0600	\$24.81	\$25.41	\$24.78	\$25.48	\$25.26	\$25.51		
72	-0720	\$25.35	\$26.07	\$25.35	\$26.19	\$25.94	\$26.24		
Solder Center, Crimp and Crimp Outer									
LENGTH IN INCHES	DASH NUMBER	50 Ω SIG 240 [Ⓞ] [Ⓜ] 2 shields [Ⓞ] 24C-TATM-	50 Ω LMR 240 [Ⓞ] [Ⓜ] 2 shields [Ⓞ] 24L-TATM-	50 Ω SIG 300 [Ⓞ] [Ⓜ] 2 shields [Ⓞ] 3LC-TATM-	50 Ω LMR 300 [Ⓞ] [Ⓜ] 2 shields [Ⓞ] 3LM-TATM-	50 Ω SIG 400 [Ⓞ] [Ⓜ] 2 shields [Ⓞ] 4LC-TATM-	50 Ω LMR 400 [Ⓞ] [Ⓜ] 2 shields [Ⓞ] 4LM-TATM-		
12	-0120	\$30.77	\$31.19	\$44.71	\$45.11	\$26.61	\$27.13		
24	-0240	\$31.37	\$32.21	\$45.43	\$46.23	\$27.47	\$28.51		
36	-0360	\$31.97	\$33.23	\$46.15	\$47.35	\$28.33	\$29.89		
48	-0480	\$32.57	\$34.25	\$46.87	\$48.47	\$29.19	\$31.27		
60	-0600	\$33.17	\$35.27	\$47.59	\$49.59	\$30.05	\$32.65		
72	-0720	\$33.77	\$36.29	\$48.31	\$50.71	\$30.91	\$34.03		
Solder Center, Crimp and Crimp Outer									
LTH IN INS	DASH NUM	50 Ω [Ⓞ] SIG 400DB [Ⓞ] 2 shields [Ⓞ] 4DC-TATM-	50 Ω [Ⓞ] LMR 400DB [Ⓞ] 2 shields [Ⓞ] 4LD-TATM-	50 Ω [Ⓞ] SIG 400FR [Ⓞ] 2 shields [Ⓞ] 4RC-TATM-	50 Ω [Ⓞ] LMR 400FR [Ⓞ] 2 shields [Ⓞ] 4LR-TATM-	50 Ω [Ⓞ] SIG 400UF [Ⓞ] 2 shields [Ⓞ] 4UC-TATM-	50 Ω [Ⓞ] LMR 400UF [Ⓞ] 2 shields [Ⓞ] 4UF-TATM-	50 Ω LMR 600 [Ⓞ] [Ⓜ] 2 shields [Ⓞ] 6LM-TATM-	
12	-0120	\$26.73	\$27.35	\$26.73	\$27.65	\$26.73	\$27.65	\$40.06	
24	-0240	\$27.71	\$28.95	\$27.71	\$29.55	\$27.71	\$29.55	\$42.06	
36	-0360	\$28.69	\$30.55	\$28.69	\$31.45	\$28.69	\$31.45	\$44.06	
48	-0480	\$29.67	\$32.15	\$29.67	\$33.35	\$29.67	\$33.35	\$46.06	
60	-0600	\$30.65	\$33.75	\$30.65	\$35.25	\$30.65	\$35.25	\$48.06	
72	-0720	\$31.63	\$35.35	\$31.63	\$37.15	\$31.63	\$37.15	\$50.06	
Color Designators (add letter to the end of the part number and add \$1.00 to price)									
Black - B		Blue - L		Brown - N		Gray - A		Green - G	
Orange - O		Red - R		Violet - V		Yellow - Y		White - W	

See Page B5 for Cable Characteristics

* Contact Factory for delivery, Consider new RD316 for (RD188) 10 % Discount @ 25 pcs. up 4% Discount @ 10 pcs. up

TNC Male Plug x TNC Reverse Polarity Right Angle Plug

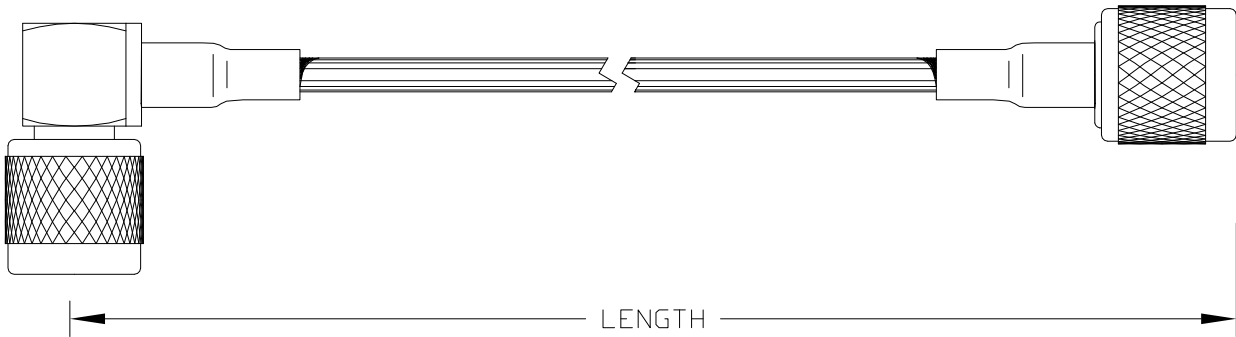

LENGTH IN INCHES	DASH NUM	50 Ω RG 58C ^{③⑥} 1 shield ^⑦ 058-TATP-	50 Ω RG 223 ^{③①} 2 shields ^⑦ 223-TATP-	50 Ω RG 174 ^{③⑤} 1 shield ^⑦ 174-TATP-	50 Ω RD 316 ^{④②} 2 shields ^⑦ 31D-TATP-	50 Ω ^⑤ CCS 100 ^⑥ 2 shields ^⑧ 1LC-TATP-	50 Ω ^⑤ LMR 100 ^⑥ 2 shields ^⑧ 1LM-TATP-	50 Ω ^③ CCS 195 ^⑥ 2 shields ^⑧ 19C-TATP-
Solder Center, Crimp Outer with Strain Relief								
12	-0120	\$21.33	\$29.86	\$27.11	\$28.72	\$31.71	\$31.83	\$25.50
24	-0240	\$21.73	\$31.33	\$27.35	\$30.57	\$32.25	\$32.49	\$26.07
36	-0360	\$22.13	\$32.80	\$27.59	\$32.42	\$32.79	\$33.15	\$26.64
48	-0480	\$22.53	\$34.27	\$27.83	\$34.27	\$33.33	\$33.81	\$27.21
60	-0600	\$22.93	\$35.74	\$28.07	\$36.12	\$33.87	\$34.47	\$27.78
Solder Center, Crimp and Clamp Outer								
LENGTH IN INCHES	DASH NUM	50 Ω ^③ LMR 195 ^⑥ 2 shields ^⑧ 19M-TATP-	50 Ω ^③ CCS 240 ^⑥ 2 shields ^⑧ 24C-TATP-	50 Ω ^③ LMR 240 ^⑥ 2 shields ^⑧ 24L-TATP-	50 Ω ^③ CCS 300 ^⑥ 2 shields ^⑧ 3LC-TATP-	50 Ω ^③ LMR 300 ^⑥ 2 shields ^⑧ 3LM-TATP-	50 Ω ^④ CCS 400 ^⑥ 2 shields ^⑧ 4LC-TATP-	50 Ω ^④ LMR 400 ^⑥ 2 shields ^⑧ 4LM-TATP-
12	-0120	\$25.64	\$31.02	\$31.44	\$48.95	\$49.35	\$28.45	\$28.97
24	-0240	\$26.35	\$31.62	\$32.46	\$49.67	\$50.47	\$29.31	\$30.35
36	-0360	\$27.06	\$32.22	\$33.48	\$50.39	\$51.59	\$30.17	\$31.73
48	-0480	\$27.77	\$32.82	\$34.50	\$51.11	\$52.71	\$31.03	\$33.11
60	-0600	\$28.48	\$33.42	\$35.52	\$51.83	\$53.83	\$31.89	\$34.49
Solder Center, Crimp and Clamp Outer								
LTH IN INS	DASH NUM	50 Ω ^④ CCS 400DB ^⑥ 2 shields ^⑧ 4DC-TATP-	50 Ω ^④ LMR 400DB ^⑥ 2 shields ^⑧ 4LD-TATP-	50 Ω ^④ CCS 400FR ^⑥ 2 shields ^⑧ 4RC-TATP-	50 Ω ^④ LMR 400FR ^⑥ 2 shields ^⑧ 4LR-TATP-	50 Ω ^④ CCS 400UF ^⑥ 2 shields ^⑧ 4UC-TATP-	50 Ω ^④ LMR 400UF ^⑥ 2 shields ^⑧ 4UF-TATP-	50 Ω ^④ LMR 600 ^{⑥④} 2 shields ^⑧ 6LM-TATP-
12	-0120	\$28.57	\$29.19	\$28.57	\$29.49	\$28.57	\$29.49	\$40.06
24	-0240	\$29.55	\$30.79	\$29.55	\$31.39	\$29.55	\$31.39	\$42.06
36	-0360	\$30.53	\$32.39	\$30.53	\$33.29	\$30.53	\$33.29	\$44.06
48	-0480	\$31.51	\$33.99	\$31.51	\$35.19	\$31.51	\$35.19	\$46.06
60	-0600	\$32.49	\$35.59	\$32.49	\$37.09	\$32.49	\$37.09	\$48.06
Color Designators (add letter to the end of the part number and add \$1.00 to price)								
Black - B		Blue - L		Brown - N		Gray - A		Green - G
Orange - O		Red - R		Violet - V		Yellow - Y		White - W

See Page B5 for Cable Characteristics

* Contact Factory for delivery, Consider new RD316 for (RD188)

10% Discount @ 25 pcs. up

4% Discount @ 10 pcs. up

TNC Male Plug x TNC Right Angle Male Plug

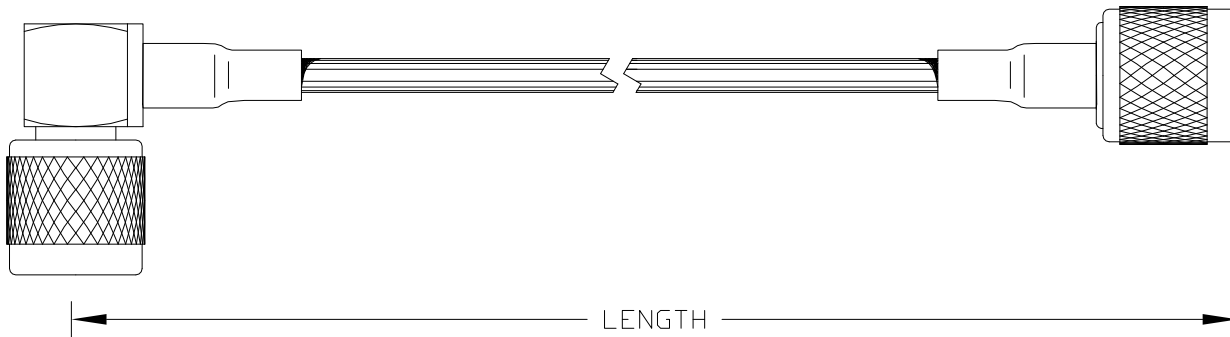

LENGTH IN INCHES	DASH NUMBER	50 Ω CCS 100 ^⑤ 2 shields ^⑨ 1LC-TATC-	50 Ω LMR 100 ^⑤ 2 shields ^⑨ 1LM-TATC-	50 Ω CCS 195 ^③ 2 shields ^⑨ 19C-TATC-	50 Ω LMR 195 ^③ 2 shields ^⑨ 19M-TATC-	50 Ω CCS 200 ^③ 2 shields ^⑨ 2LC-TATC-	50 Ω LMR 200 ^④ 2 shields ^⑨ 2LM-TATC-		
Solder Center, Crimp Outer with Strain Relief									
12	-0120	\$24.71	\$24.83	\$23.27	\$23.41	\$30.18	\$30.23		
24	-0240	\$25.25	\$25.49	\$23.84	\$24.12	\$30.86	\$30.96		
36	-0360	\$25.79	\$26.15	\$24.41	\$24.83	\$31.54	\$31.69		
48	-0480	\$26.33	\$26.81	\$24.98	\$25.54	\$32.22	\$32.42		
60	-0600	\$26.87	\$27.47	\$25.55	\$26.25	\$32.90	\$33.15		
72	-0720	\$27.41	\$28.13	\$26.12	\$26.96	\$33.58	\$33.88		
Solder Center, Crimp and Clamp Outer									
LENGTH IN INCHES	DASH NUMBER	50 Ω CCS 240 ^③ 2 shields ^⑨ 24C-TATC-	50 Ω LMR 240 ^③ 2 shields ^⑨ 24L-TATC-	50 Ω ^③ CCS 240UF ^① 2 shields ^⑨ 24U-TATC-	50 Ω ^③ LMR 240UF ^① 2 shields ^⑨ 24U-TATC-	50 Ω CCS 400 ^④ 2 shields ^⑨ 4LC-TATC-	50 Ω LMR 400 ^④ 2 shields ^⑨ 4LM-TATC-		
12	-0120	\$21.90	\$22.32	\$21.96	\$22.48	\$27.00	\$27.52		
24	-0240	\$22.50	\$23.34	\$22.62	\$23.66	\$27.86	\$28.90		
36	-0360	\$23.10	\$24.36	\$23.28	\$24.84	\$28.72	\$30.28		
48	-0480	\$23.70	\$25.38	\$23.94	\$26.02	\$29.58	\$31.66		
60	-0600	\$24.30	\$26.40	\$24.60	\$27.20	\$30.44	\$33.04		
72	-0720	\$24.90	\$27.42	\$25.26	\$28.38	\$31.30	\$34.42		
Solder Center, Crimp and Clamp Outer									
LTH IN INS	DASH NUM	50 Ω ^④ CCS 400DB ^① 2 shields ^⑨ 4DC-TATC-	50 Ω ^④ LMR 400DB ^① 2 shields ^⑨ 4LD-TATC-	50 Ω ^④ CCS 400FR ^① 2 shields ^⑨ 4RC-TATC-	50 Ω ^④ LMR 400FR ^① 2 shields ^⑨ 4LR-TATC-	50 Ω ^④ CCS 400UF ^① 2 shields ^⑨ 4UC-TATC-	50 Ω ^④ LMR 400UF ^① 2 shields ^⑨ 4UF-TATC-	50 Ω ^④ LMR 600 ^② 2 shields ^⑨ 6LM-TATC-	
12	-0120	\$27.12	\$27.74	\$27.12	\$28.04	\$27.12	\$28.04	\$55.34	
24	-0240	\$28.10	\$29.34	\$28.10	\$29.94	\$28.10	\$29.94	\$57.34	
36	-0360	\$29.08	\$30.94	\$29.08	\$31.84	\$29.08	\$31.84	\$59.34	
48	-0480	\$30.06	\$32.54	\$30.06	\$33.74	\$30.06	\$33.74	\$61.34	
60	-0600	\$31.04	\$34.14	\$31.04	\$35.64	\$31.04	\$35.64	\$63.34	
72	-0720	\$32.02	\$35.74	\$32.02	\$37.54	\$32.02	\$37.54	\$65.34	
Color Designators (add letter to the end of the part number and add \$1.00 to price)									
Black - B		Blue - L		Brown - N		Gray - A		Green - G	
Orange - O		Red - R		Violet - V		Yellow - Y		White - W	

See Page B5 for Cable Characteristics

* Contact Factory for delivery, Consider new RD316 for (RD188) 10 % Discount @ 25 pcs. up 4% Discount @ 10 pcs. up



RF Depot.com Inc.

Phone 856-488-2000 Fax 856-488-2020

B226

7850 Browning Rd. Pennsauken, NJ 08109

Online @ www.rfdepot.com

Toll Free 877-RF Depot

TNC Male Plug x 7-16 Male Plug

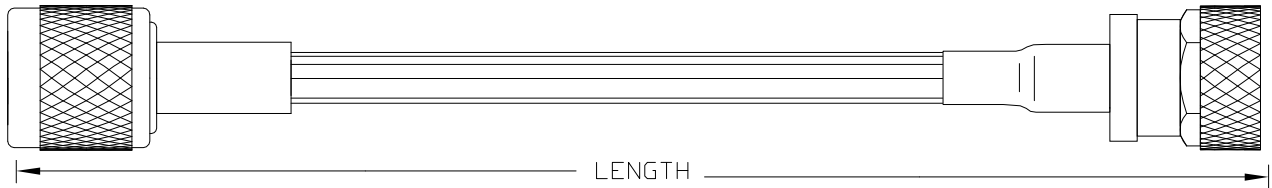

LENGTH IN INCHES	DASH NUMBER	50 Ω RG 58C ③⑥ 1 shield⑦ 058-TA716A-	50 Ω RG 223 ③① 2 shields⑦ 223-TA716A-	50 Ω RG 142 ④② 2 shields⑦ 142-TA716A-	50 Ω RG 316 ④② 1 shield⑧ 316-TA716A-	50 Ω RG 393 ④① 2 shields⑦ 393-TA716A-
Solder Center, Crimp Outer with Strain Relief						
12	-0120	\$47.69	\$52.08	\$52.91	\$51.62	\$55.76
24	-0240	\$48.09	\$53.55	\$55.21	\$52.27	\$64.39
36	-0360	\$48.49	\$55.02	\$57.51	\$52.92	\$73.02
48	-0480	\$48.89	\$56.49	\$59.81	\$53.57	\$81.65
60	-0600	\$49.29	\$57.96	\$62.11	\$54.22	\$90.28
72	-0720	\$49.69	\$59.43	\$64.41	\$54.87	\$98.91
Solder Center, Crimp Outer with Strain Relief						
LENGTH IN INCHES	DASH NUMBER	50 Ω RG 214 ③① 2 shields⑦ 214-TA716A-	50 Ω RG 213 ③③ 1 shield⑧ 213-TA716A-	50 Ω SIG 195 ③③ 2 shields⑨ 19C-TA716A-	50 Ω LMR 195 ③③ 2 shields⑨ 19M-TA716A-	50 Ω CCS 200③③ 2 shields⑨ 2LC-TA716A-
12	-0120	\$50.80	\$57.44	\$47.86	\$48.00	\$71.66
24	-0240	\$54.30	\$59.02	\$48.43	\$48.71	\$72.34
36	-0360	\$57.80	\$60.60	\$49.00	\$49.42	\$73.02
48	-0480	\$61.30	\$62.18	\$49.57	\$50.13	\$73.70
60	-0600	\$64.80	\$63.76	\$50.14	\$50.84	\$74.38
72	-0720	\$68.30	\$65.34	\$50.71	\$51.55	\$75.06
Solder Center, Crimp Outer with Strain Relief						
LENGTH IN INCHES	DASH NUMBER	50 Ω LMR 200③ 2 shields⑨ 2LM-TA716A-	50 Ω CCS 240③③ 2 shields⑨ 24C-TA716A-	50 Ω LMR 240③③ 2 shields⑨ 24L-TA716A-	50 Ω④ CCS 400③ 2 shields⑨ 4LC-TA716A-	50 Ω④ LMR 400③ 2 shields⑨ 4LM-TA716A-
12	-0120	\$71.71	\$50.71	\$51.13	\$76.39	\$76.91
24	-0240	\$72.44	\$51.31	\$52.15	\$77.25	\$78.29
36	-0360	\$73.17	\$51.91	\$53.17	\$78.11	\$79.67
48	-0480	\$73.90	\$52.51	\$54.19	\$78.97	\$81.05
60	-0600	\$74.63	\$53.11	\$55.21	\$79.83	\$82.43
72	-0720	\$75.36	\$53.71	\$56.23	\$80.69	\$83.81
Color Designators (add letter to the end of the part number and add \$1.00 to price)						
Black - B		Blue - L		Brown - N		Gray - A
Orange - O		Red - R		Violet - V		Yellow - Y
						Green - G
						White - W

See Page B5 for Cable Characteristics

* Contact Factory for delivery, Consider new RD316 for (RD188)

10% Discount @ 25 pcs. up

4% Discount @ 10 pcs. up

UHF Male Plug x UHF Male Plug



LENGTH IN INCHES	DASH NUMBER	50 Ω RG 8* ③③ 1 shield⑧ 008-UAUA-	50 Ω RG 213 ③③ 1 shield⑧ 213-UAUA-	50 Ω RG 214 ③① 2 shields⑦ 214-UAUA-	75 Ω RG 59B ③⑤ 1 shield⑧ 059-UAUA-	93 Ω RG 62 ③⑤ 1 shield⑧ 062-UAUA-	
Solder Center, Crimp Outer							
12	-0120	\$19.86	\$20.04	\$22.46	\$23.74	\$24.00	
24	-0240	\$21.26	\$21.62	\$25.96	\$24.18	\$24.70	
36	-0360	\$22.66	\$23.20	\$29.46	\$24.62	\$25.40	
48	-0480	\$24.06	\$24.78	\$32.96	\$25.06	\$26.10	
60	-0600	\$25.46	\$26.36	\$36.46	\$25.50	\$26.80	
72	-0720	\$26.86	\$27.94	\$39.96	\$25.94	\$27.50	
Solder Center, Crimp Outer							
LENGTH IN INCHES	DASH NUMBER	50 Ω RG 58C ③⑥ 1 shield⑦ 058-UAUA-	50 Ω RG 223 ③① 2 shields⑦ 223-UAUA-	50 Ω RG 142B ④② 2 shields⑦ 142-UAUA-	50 Ω RG 400 ④① 2 shields⑦ 400-UAUA-	50 Ω RG 393 ④① 2 shields⑦ 393-UAUA-	
12	-0120	\$18.38	\$18.65	\$19.48	\$20.18	\$27.59	
24	-0240	\$18.78	\$20.12	\$21.78	\$23.18	\$36.22	
36	-0360	\$19.18	\$21.59	\$24.08	\$26.18	\$44.85	
48	-0480	\$19.58	\$23.06	\$26.38	\$29.18	\$53.48	
60	-0600	\$19.98	\$24.53	\$28.68	\$32.18	\$62.11	
72	-0720	\$20.38	\$26.00	\$30.98	\$35.18	\$70.74	
Solder Center, Crimp Outer							
LENGTH IN INCHES	DASH NUM	50 Ω③ CCS 240 ① 2 shields⑨ 24C-UAUA-	50 Ω③ LMR 240 ① 2 shields⑨ 24L-UAUA-	50 Ω④ CCS 400DB ① 2 shields⑨ 4DC-UAUA-	50 Ω④ LMR 400DB ① 2 shields⑨ 4LD-UAUA-	50 Ω④ CCS 400FR ① 2 shields⑨ 4RC-UAUA-	50 Ω④ LMR 400FR ① 2 shields⑨ 4LR-UAUA-
12	-0120	\$18.76	\$19.18	\$18.16	\$18.78	\$18.16	\$19.08
24	-0240	\$19.36	\$20.20	\$19.14	\$20.38	\$19.14	\$20.98
36	-0360	\$19.96	\$21.22	\$20.12	\$21.98	\$20.12	\$22.88
48	-0480	\$20.56	\$22.24	\$21.10	\$23.58	\$21.10	\$24.78
60	-0600	\$21.16	\$23.26	\$22.08	\$25.18	\$22.08	\$26.68
72	-0720	\$21.76	\$24.28	\$23.06	\$26.78	\$23.06	\$28.58
Color Designators (add letter to the end of the part number and add \$1.00 to price)							
Black - B		Blue - L		Brown - N		Gray - A	
Orange - O		Red - R		Violet - V		Green - G	
						White - W	

See Page B5 for Cable Characteristics

* Contact Factory for delivery, Consider new RD316 for (RD188) 10 % Discount @ 25 pcs. up 4% Discount @ 10 pcs. up



RF Depot.com Inc.

Phone 856-488-2000 Fax 856-488-2020

UMP Cable Assemblies

The UMP connector is very low-profile connector (2, 2.6 & 3mm) manufactured by Radiall.

UMP H2 x MCX Male Plug

UMP H2 x SMA Bulkhead Jack

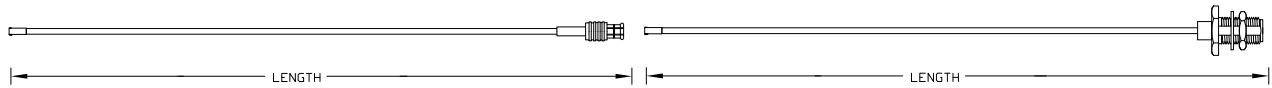

In	DASH NUM	50 Ω 0.83MMⓈ 1 shieldⓈ	50 Ω 1.17MMⓈ 1 shieldⓈ	50 Ω 1.37MMⓈ 1 shieldⓈ	50 Ω 0.83MMⓈ 1 shieldⓈ	50 Ω 1.17MMⓈ 1 shieldⓈ	50 Ω 1.37MMⓈ 1 shieldⓈ
		001-U2ACXA-	001-U2ACXA-	001-U2ACXA-	001-U2AMF-	001-U2AMF-	001-U2AMF-
Direct Solder Connectors							
1	-0010	\$29.77	\$29.77	\$29.77	\$39.50	\$39.50	\$39.50
8	-0080	\$29.77	\$29.77	\$29.77	\$39.50	\$39.50	\$39.50

UMP H2 x SMA Male Plug

UMP H2 x MMCX Male Plug

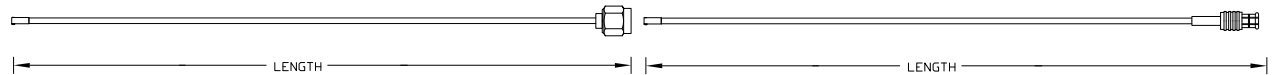

In	DASH NUM	50 Ω .83MMⓈ 1 shieldⓈ	50 Ω 1.17MMⓈ 1 shieldⓈ	50 Ω 1.37MMⓈ 1 shieldⓈ	50 Ω .83MMⓈ 1 shieldⓈ	50 Ω 1.17MMⓈ 1 shieldⓈ	50 Ω 1.37MMⓈ 1 shieldⓈ
		001-U2AMA-	001-U2AMA-	001-U2AMA-	001-U2AMCXA-	001-U2AMCXA-	001-U2AMCXA-
Direct Solder Connectors							
1	-0010	\$39.50	\$39.50	\$39.50	\$30.33	\$30.33	\$30.33
8	-0080	\$39.50	\$39.50	\$39.50	\$30.33	\$30.33	\$30.33

UMP H2 x UMP H2

UMP H2 x SSMC Male Plug

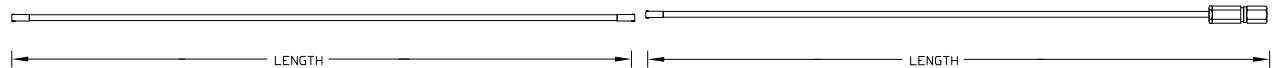

In	DASH NUM	50 Ω 0.83MM Ⓢ 1 shieldⓈ	50 Ω 1.17MM Ⓢ 1 shieldⓈ	In	DASH NUM	50 Ω 0.83MM Ⓢ 1 shieldⓈ	50 Ω 1.17MM Ⓢ 1 shieldⓈ
		001-U2AU2A-	001-U2AU2A-			001-U2ACSA-	001-U2ACSA-
Direct Solder Connectors				Direct Solder Connectors			
100MM		\$77.00	\$65.12	1	-0010	CALL	CALL
-	-	-	-	8	-0080	CALL	CALL

All UMP H2 Connectors are Locking Type. For Snap or Sliding Type, Contact Factory.

Color Designators (add letter to the end of the part number and add \$1.00 to price)

Black - B	Blue - L	Brown - N	Gray - A	Green - G
Orange - O	Red - R	Violet - V	Yellow - Y	White - W

See Page B5 for Cable Characteristics

* Contact Factory for delivery, Consider new RD316 for (RD188)

10% Discount @ 25 pcs. up

4% Discount @ 10 pcs. up

1.6/5.6 Male Plug x 1.6/5.6 Male Plug

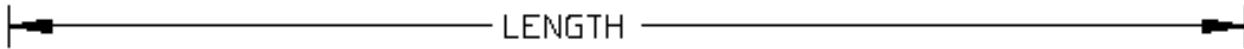

LENGTH IN INCHES	DASH NUMBER	75 Ω RG 59 ③⑤ 1 shield⑧ 059-D2AD2A-	93 Ω RG 62 ③⑤ 1 shield⑧ 062-D2AD2A-	75 Ω RG 179 ④② 1 shield⑩ 179-D2AD2A-	75 Ω RD 179 ② 2 shields⑦ 179D-D2AD2A-	75 Ω RG 187 ② 1 shield⑩ 187-D2AD2A-
Solder Center, Crimp Outer with Strain Relief						
12	-0120	\$27.84	\$28.10	\$27.13	\$29.18	\$28.00
24	-0240	\$28.28	\$28.80	\$27.86	\$30.88	\$29.60
36	-0360	\$28.72	\$29.50	\$28.59	\$32.58	\$31.20
48	-0480	\$29.16	\$30.20	\$29.32	\$34.28	\$32.80
60	-0600	\$29.60	\$30.90	\$30.05	\$35.98	\$34.40
72	-0720	\$30.04	\$31.60	\$30.78	\$37.68	\$36.00

1.6/5.6 Male Plug x 1.6/5.6 Right Angle Male Plug

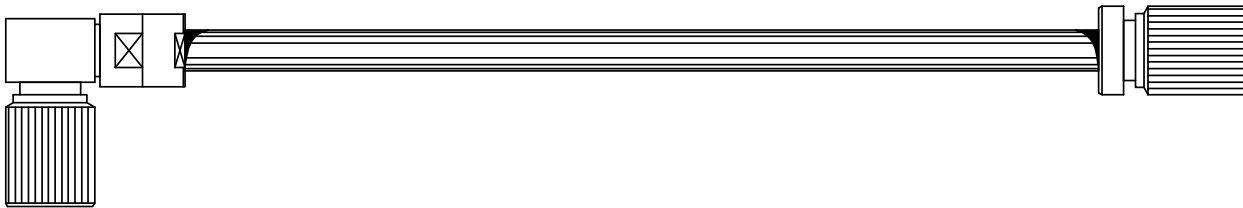

LENGTH IN INCHES	DASH NUMBER	75 Ω RG 59 ③⑤ 1 shield⑧ 059-D2AD2C-	93 Ω RG 62 ③⑤ 1 shield⑧ 062-D2AD2C-	75 Ω RG 179 ④② 1 shield⑩ 179-D2AD22-	75 Ω RD 179 ② 2 shields⑦ 179-D2AD22-	75 Ω RG 187 ② 1 shield⑩ 187-D2AD22-
Solder Center, Clamp and Crimp Outer with Strain Relief						
12	-0120	\$44.00	\$44.26	\$38.26	\$40.77	\$39.13
24	-0240	\$44.44	\$44.96	\$38.99	\$42.47	\$40.73
36	-0360	\$44.88	\$45.66	\$39.72	\$44.17	\$42.33
48	-0480	\$45.32	\$46.36	\$40.45	\$45.87	\$43.93
60	-0600	\$45.76	\$47.06	\$41.18	\$47.57	\$45.53
72	-0720	\$46.20	\$47.76	\$41.91	\$49.27	\$47.13
Color Designators (add letter to the end of the part number and add \$1.00 to price)						
Black - B		Blue - L		Brown - N		Gray - A
Orange - O		Red - R		Violet - V		Yellow - Y
						Green - G
						White - W

See Page B5 for Cable Characteristics

* Contact Factory for delivery, Consider new RD316 for (RD188) 10 % Discount @ 25 pcs. up 4% Discount @ 10 pcs. up

1.6/5.6 Male Plug x 75 Ω BNC Male Plug

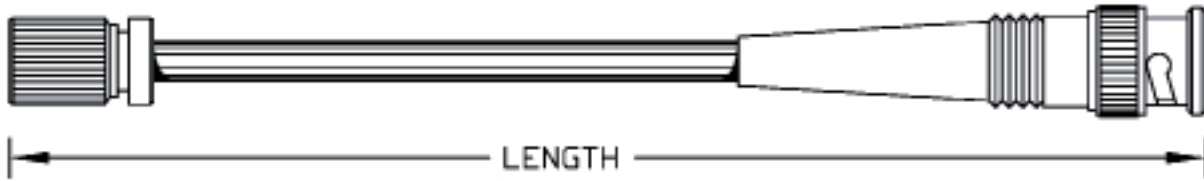

LENGTH IN INCHES	DASH NUMBER	75 Ω RG 59 ③⑤ 1 shield⑧ 059-D2ASA-	93 Ω RG 62 ③⑤ 1 shield⑧ 062-D2ASA-	75 Ω RG 179 ④② 1 shield⑧ 179-D2ASA-	75 Ω RD 179 ② 2 shields⑦ 179D-D2ASA-	75 Ω RG 187 ② 1 shield⑧ 187-D2ASA-
Solder Center, Clamp and Crimp Outer with Strain Relief						
12	-0120	\$23.90	\$24.16	\$24.11	\$25.82	\$24.98
24	-0240	\$24.34	\$24.86	\$24.84	\$27.52	\$26.58
36	-0360	\$24.78	\$25.56	\$25.57	\$29.22	\$28.18
48	-0480	\$25.22	\$26.26	\$26.30	\$30.92	\$29.78
60	-0600	\$25.66	\$26.96	\$27.03	\$32.62	\$31.38
72	-0720	\$26.10	\$27.66	\$27.76	\$34.32	\$32.98

1.6/5.6 Right Angle Plug x 1.6/5.6 Right Angle Plug

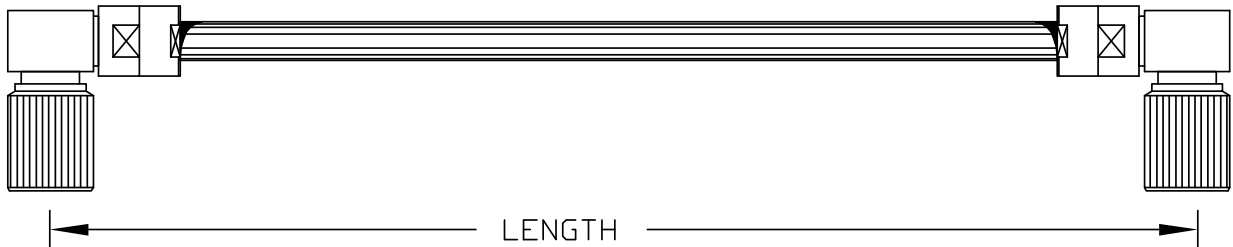

LENGTH IN INCHES	DASH NUMBER	75 Ω RG 59 ③⑤ 1 shield⑧ 059-D22D22-	93 Ω RG 62 ③⑤ 1 shield⑧ 062-D22D22-	75 Ω RG 179 ④② 1 shield⑧ 179-D2CD2C-	75 Ω RD 179 ② 2 shields⑦ 179D-D2CD2C-	75 Ω RG 187 ② 1 shield⑧ 187-D2CD2C-	
Solder Center, Clamp and Crimp Outer with Strain Relief							
12	-0120	\$62.16	\$62.42	\$46.39	\$48.36	\$47.26	
24	-0240	\$62.60	\$63.12	\$47.12	\$50.06	\$48.86	
36	-0360	\$63.04	\$63.82	\$47.85	\$51.76	\$50.46	
48	-0480	\$63.48	\$64.52	\$48.58	\$53.46	\$52.06	
60	-0600	\$63.92	\$65.22	\$49.31	\$55.16	\$53.66	
72	-0720	\$64.36	\$65.92	\$50.04	\$56.86	\$55.26	
Color Designators (add letter to the end of the part number and add \$1.00 to price)							
Black - B		Blue - L		Brown - N		Gray - A	
Orange - O		Red - R		Violet - V		Yellow - Y	
						Green - G	
						White - W	

See Page B5 for Cable Characteristics

* Contact Factory for delivery, Consider new RD316 for (RD188)

10% Discount @ 25 pcs. up

4% Discount @ 10 pcs. up

1.85 mm Male Plug x 1.85 mm Male Plug

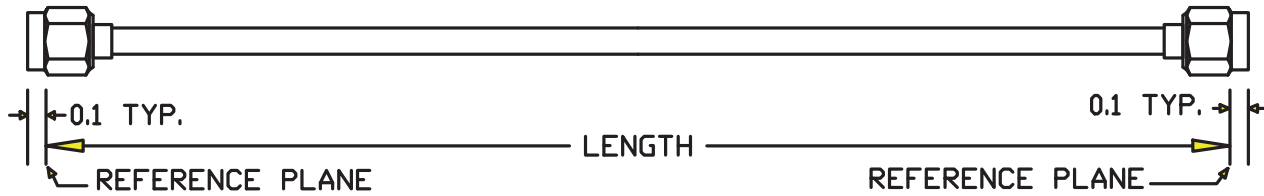

LENGTH IN INCHES	DASH NUMBER	50Ω RG 405② M17/133-00006 .085 Cu Jacket 405-180180-	50Ω RG 405② M17/133-00007 .085 Tin Plate Cu 8TS- 180180-	50Ω RG 405② M17/133-00013 .085 Tin Plate Al 8AT-180180-	50ΩMaxiFlex② (No QPL List) .085 Tin Pl 08F-180180-	50Ω RG 405② M17/133-00016 .085 Silver Pl 8SS-180180-
.085" Diameter SEMIRIGID and MaxiFlex Direct Solder Connectors						
12	-0120	\$136.06	\$136.06	\$137.00	\$137.29	\$141.25
24	-0240	\$139.08	\$139.08	\$140.96	\$141.54	\$149.46
36	-0360	\$142.10	\$142.10	\$144.92	\$145.79	\$157.67
48	-0480	\$145.12	\$145.12	\$148.88	\$150.04	\$165.88
60	-0600	\$148.14	\$148.14	\$152.84	\$154.29	\$174.09
72	-0720	\$151.16	\$151.16	CALL	\$158.54	CALL

1.85 mm Male Plug x 2.4 mm Male Plug

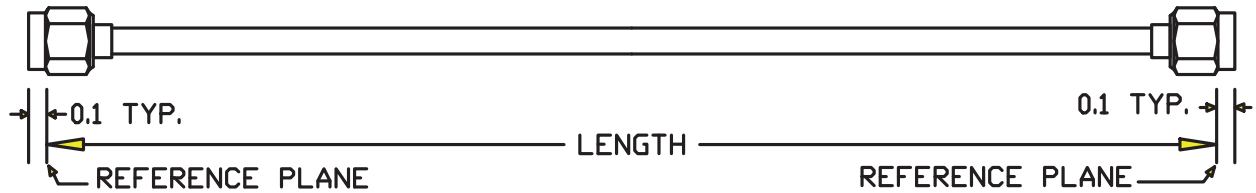

LENGTH IN INCHES	DASH NUMBER	50Ω RG 405② M17/133-00006 .085 Cu Jacket 405-180240-	50Ω RG 405② M17/133-00007 .085 Tin Plate Cu 8TS-180240-	50Ω RG 405② M17/133-00013 .085 Tin Plate Al 8AT-180240-	50ΩMaxiFlex② (No QPL List) .085 Tin Pl 08F-180240-	50Ω RG 405② M17/133-00016 .085 Silver Pl 8SS-180240-
.141" Diameter SEMIRIGID and MaxiFlex Direct Solder Connectors						
12	-0120	\$118.36	\$118.36	\$119.30	\$119.59	\$123.55
24	-0240	\$121.38	\$121.38	\$123.26	\$123.84	\$131.76
36	-0360	\$124.40	\$124.40	\$127.22	\$128.09	\$139.97
48	-0480	\$127.42	\$127.42	\$131.18	\$132.34	\$148.18
60	-0600	\$130.44	\$130.44	\$135.14	\$136.59	\$156.39
72	-0720	\$133.46	\$133.46	CALL	\$140.84	CALL

①Silver Plated Copper Center Conductor ②Silver Plated Copper Clad Steel Center Conductor

10% Discount @ 25 pcs. up 4% Discount @ 10 pcs. up



1.85 mm Male Plug x 2.9 mm Male Plug

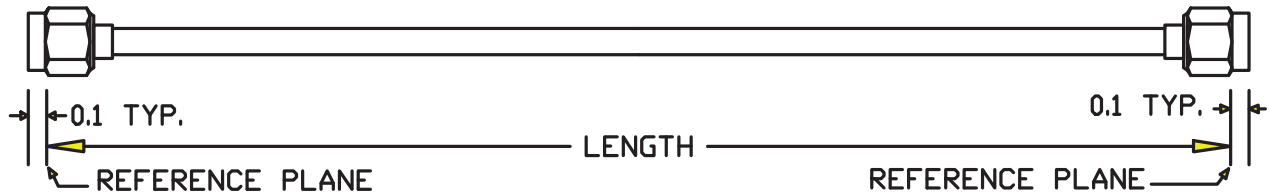

LENGTH IN INCHES	DASH NUMBER	50Ω RG 405 [Ⓢ] M17/133-00006 .085 Cu Jacket 405-180290-	50Ω RG 405 [Ⓢ] M17/133-00007 .085 Tin Plate Cu 8TS- 180290-	50Ω RG 405 [Ⓢ] M17/133-00013 .085 Tin Plate Al 8AT-180290-	50ΩMaxiFlex [Ⓢ] (No QPL List) .085 Tin Pl 08F-180290-	50Ω RG 405 [Ⓢ] M17/133-00016 .085 Silver Pl 8SS-180290-
.085" Diameter SEMIRIGID and MaxiFlex Direct Solder Connectors						
12	-0120	\$94.43	\$94.43	\$95.37	\$95.66	\$99.62
24	-0240	\$97.45	\$97.45	\$99.33	\$99.91	\$107.83
36	-0360	\$100.47	\$100.47	\$103.29	\$104.16	\$116.04
48	-0480	\$103.49	\$103.49	\$107.25	\$108.41	\$124.25
54	-0540	\$105.00	\$105.00	\$109.23	\$110.54	\$128.36
60	-0600	\$106.51	\$106.51	\$111.21	\$112.66	\$132.46
72	-0720	\$109.53	\$109.53	CALL	\$116.91	CALL

1.85 mm Male Plug x 3.5 mm Male Plug

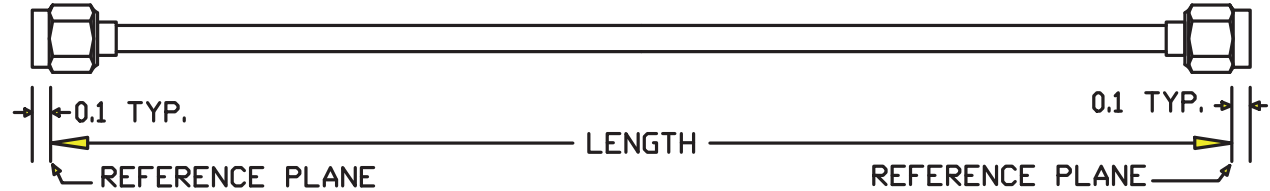

LENGTH IN INCHES	DASH NUMBER	50Ω RG 405 [Ⓢ] M17/133-00006 .085 Cu Jacket 405-180350-	50Ω RG 405 [Ⓢ] M17/133-00007 .085 Tin Plate Cu 8TS-180350-	50Ω RG 405 [Ⓢ] M17/133-00013 .085 Tin Plate Al 8AT-180350-	50ΩMaxiFlex [Ⓢ] (No QPL List) .085 Tin Pl 08F-180350-	50Ω RG 405 [Ⓢ] M17/133-00016 .085 Silver Pl 8SS-180350-
.141" Diameter SEMIRIGID and MaxiFlex Direct Solder Connectors						
12	-0120	\$109.35	\$109.35	\$110.29	\$110.58	\$114.54
24	-0240	\$112.37	\$112.37	\$114.25	\$114.83	\$122.75
36	-0360	\$115.39	\$115.39	\$118.21	\$119.08	\$130.96
48	-0480	\$118.41	\$118.41	\$122.17	\$123.33	\$139.17
54	-0540	\$119.92	\$119.92	\$124.15	\$125.46	\$143.28
60	-0600	\$121.43	\$121.43	\$126.13	\$127.58	\$147.38
72	-0720	\$124.45	\$124.45	CALL	\$131.83	CALL

Ⓢ Silver Plated Copper Center Conductor Ⓢ Silver Plated Copper Clad Steel Center Conductor

10% Discount @ 25 pcs. up 4% Discount @ 10 pcs. up

2.4 MM Male Plug x 2.4 MM Female Jack



LENGTH IN INCHES	DASH NUMBER	50Ω RG 405 [Ⓢ] M17/133-00006 .085 Cu Jacket 405-240241-	50Ω RG 405 [Ⓢ] M17/133-00007 .085 Tin Pl Cu 8TS-240241-	50Ω RG 405 [Ⓢ] M17/133-00013 .085 Tin Pl Al 8AT-240241-	50ΩMaxiFlex [Ⓢ] (No QPL List) .085 Tin Pl 08F-240241-	50Ω RG 405 [Ⓢ] M17/133-00016 .085 Silver Pl 8SS-240241-
.085" Diameter SEMIRIGID and MaxiFlex Direct Solder Connectors						
2	-0020	\$123.93	\$123.93	\$124.09	\$124.14	\$124.81
3	-0030	\$124.19	\$124.19	\$124.42	\$124.49	\$125.49
4	-0040	\$124.44	\$124.44	\$124.75	\$124.85	\$126.18
5	-0050	\$124.69	\$124.69	\$125.08	\$125.20	\$126.87
6	-0060	\$124.94	\$124.94	\$125.41	\$125.56	\$127.56
7	-0070	\$125.19	\$125.19	\$125.74	\$125.91	\$128.24
8	-0080	\$125.44	\$125.44	\$126.07	\$126.26	\$128.93
9	-0090	\$125.70	\$125.70	\$126.40	\$126.62	\$129.62
10	-0100	\$125.95	\$125.95	\$126.73	\$126.97	\$130.31
11	-0110	\$126.20	\$126.20	\$127.06	\$127.33	\$130.99
12	-0120	\$126.45	\$126.45	\$127.39	\$127.68	\$131.68
13	-0130	\$126.70	\$126.70	\$127.72	\$128.03	\$132.37
14	-0140	\$126.95	\$126.95	\$128.05	\$128.39	\$133.06
15	-0150	\$127.21	\$127.21	\$128.38	\$128.74	\$133.74
16	-0160	\$127.46	\$127.46	\$128.71	\$129.10	\$134.43
17	-0170	\$127.71	\$127.71	\$129.04	\$129.45	\$135.12
18	-0180	\$127.96	\$127.96	\$129.37	\$129.81	\$135.81
19	-0190	\$128.21	\$128.21	\$129.70	\$130.16	\$136.49
20	-0200	\$128.46	\$128.46	\$130.03	\$130.51	\$137.18
21	-0210	\$128.72	\$128.72	\$130.36	\$130.87	\$137.87
22	-0220	\$128.97	\$128.97	\$130.69	\$131.22	\$138.56
23	-0230	\$129.22	\$129.22	\$131.02	\$131.58	\$139.24
24	-0240	\$129.47	\$129.47	\$131.35	\$131.93	\$139.93
36	-0360	\$132.49	\$132.49	\$135.31	\$136.18	\$148.18
48	-0480	\$135.51	\$135.51	\$139.27	\$140.43	\$156.43
60	-0600	\$138.53	\$138.53	\$143.23	\$144.68	\$164.68
72	-0720	\$141.55	\$141.55	CALL	\$148.93	CALL

Ⓢ Silver Plated Copper Center Conductor Ⓢ Silver Plated Copper Clad Steel Center Conductor

10% Discount @ 25 pcs. up 4% Discount @ 10 pcs. up



RF Depot.com Inc.

Phone 856-488-2000 Fax 856-488-2020

B234

7850 Browning Rd. Pennsauken, NJ 08109

Online @ www.rfdepot.com

Toll Free 877-RF Depot

2.4 MM Male Plug x 2.4 MM Male Plug



LENGTH IN INCHES	DASH NUMBER	50Ω RG 405② M17/133-00006 .085 Cu Jacket 405-240240-	50Ω RG 405② M17/133-00007 .085 Tin Pl Cu 8TS-240240-	50Ω RG 405② M17/133-00013 .085 Tin Plate Al 8AT-240240-	50ΩMaxiFlex② (No QPL List) .085 Tin Pl 08F-240240-	50Ω RG 405② M17/133-00016 .085 Silver Pl 8SS-240240-
.085" Diameter SEMIRIGID and MaxiFlex Direct Solder Connectors						
2	-0020	\$70.36	\$70.36	\$70.52	\$70.57	\$71.24
3	-0030	\$70.62	\$70.62	\$70.85	\$70.92	\$71.92
4	-0040	\$70.87	\$70.87	\$71.18	\$71.28	\$72.61
5	-0050	\$71.12	\$71.12	\$71.51	\$71.63	\$73.30
6	-0060	\$71.37	\$71.37	\$71.84	\$71.99	\$73.99
7	-0070	\$71.62	\$71.62	\$72.17	\$72.34	\$74.67
8	-0080	\$71.87	\$71.87	\$72.50	\$72.69	\$75.36
9	-0090	\$72.13	\$72.13	\$72.83	\$73.05	\$76.05
10	-0100	\$72.38	\$72.38	\$73.16	\$73.40	\$76.74
11	-0110	\$72.63	\$72.63	\$73.49	\$73.76	\$77.42
12	-0120	\$72.88	\$72.88	\$73.82	\$74.11	\$78.07
18	-0180	\$74.39	\$74.39	\$75.80	\$76.24	\$82.24
24	-0240	\$75.90	\$75.90	\$77.78	\$78.36	\$86.28
36	-0360	\$78.92	\$78.92	\$81.74	\$82.61	\$94.49
48	-0480	\$81.94	\$81.94	\$85.70	\$86.86	\$102.70
60	-0600	\$84.96	\$84.96	\$89.66	\$91.11	\$110.91
72	-0720	\$87.98	\$87.98	CALL	\$95.36	CALL
.047" Diameter SEMIRIGID and MaxiFlex Direct Solder Connectors						
LENGTH IN INCHES	DASH NUM	50 Ω ② M17/151-00001 .047 Cu Jacket 4CU-240240-	50 Ω ② (No QPL List) .047 Tin Plate Al 4AT-240240-	50 Ω ② M17/151-00002 .047 Tin Pl Cu 4TS-240240-	50 Ω MaxiFlex ② (No QPL List) .047 Tin Pl 04F-240240-	50 Ω ① Non-Magnetic .047 Tin Pl Cu 4CT-240240-
12	-0120	\$120.10	\$121.55	\$120.10	\$120.80	\$122.98
24	-0240	\$123.90	\$126.80	\$123.90	\$125.30	\$129.66
36	-0360	\$127.70	\$132.05	\$127.70	\$129.80	\$136.34
48	-0480	\$131.50	\$137.30	\$131.50	\$134.30	\$143.02
60	-0600	\$135.30	\$142.55	\$135.30	\$138.80	\$149.70
72	-0720	\$139.10	\$147.80	\$139.10	\$143.30	\$156.38

①Silver Plated Copper Center Conductor ②Silver Plated Copper Clad Steel Center Conductor

10% Discount @ 25 pcs. up 4% Discount @ 10 pcs. up



2.4 MM Male Plug x 2.9 MM Male Plug



LENGTH IN INCHES	DASH NUMBER	50Ω RG 402 [Ⓞ] M17/130-00004 .141 Cu Jacket 402-240290-	50Ω RG 402 [Ⓞ] M17/130-00005 .141 Tin Plate Cu 1TS-240290-	50Ω RG 402 [Ⓛ] M17/130-00009 .141 Tin Plate Al 1AT-240290-	50ΩMaxiFlex [Ⓞ] (No QPL List) .141 Tin Pl 14F-240290-	50Ω RG 402 [Ⓞ] M17/130-00012 .141 Silver Pl 1SS-240290-
.141" Diameter SEMIRIGID and MaxiFlex Direct Solder Connectors						
12	-0120	\$102.40	\$102.04	\$102.40	\$102.04	\$111.61
24	-0240	\$106.00	\$105.28	\$106.00	\$105.28	\$124.42
36	-0360	\$109.60	\$108.52	\$109.60	\$108.52	\$137.23
48	-0480	\$113.20	\$111.76	\$113.20	\$111.76	\$150.04
60	-0600	\$116.80	\$115.00	\$116.80	\$115.00	\$162.85
72	-0720	\$120.40	\$118.24	\$120.40	\$118.24	\$175.66
.085" Diameter SEMIRIGID and MaxiFlex Direct Solder Connectors						
LENGTH IN INCHES	DASH NUMBER	50Ω RG 405 [Ⓞ] M17/133-00006 .085 Cu Jacket 405-240290-	50Ω RG 405 [Ⓞ] M17/133-00007 .085 Tin Plate Cu 8TS-240290-	50Ω RG 405 [Ⓞ] M17/133-00013 .085 Tin Plate Al 8AT-240290-	50ΩMaxiFlex [Ⓞ] (No QPL List) .085 Tin Pl 08F-240290-	50Ω RG 405 [Ⓞ] M17/133-00016 .085 Silver Pl 8SS-240290-
12	-0120	\$96.05	\$96.05	\$96.99	\$97.28	\$101.24
24	-0240	\$99.07	\$99.07	\$100.95	\$101.53	\$109.45
36	-0360	\$102.09	\$102.09	\$104.91	\$105.78	\$117.66
48	-0480	\$105.11	\$105.11	\$108.87	\$110.03	\$125.87
60	-0600	\$108.13	\$108.13	\$112.83	\$114.28	\$134.08
72	-0720	\$111.15	\$111.15	CALL	\$118.53	CALL
.047" Diameter SEMIRIGID and MaxiFlex Direct Solder Connectors						
LENGTH IN INCHES	DASH NUM	50 Ω [Ⓞ] M17/151-00001 .047 Cu Jacket 4CU-240290-	50 Ω [Ⓞ] (No QPL List) .047 Tin Plate Al 4AT-240290-	50 Ω [Ⓞ] M17/151-00002 .047 Tin Pl Cu 4TS-240290-	50 Ω MaxiFlex [Ⓞ] (No QPL List) .047 Tin Pl 04F-240290-	50 Ω [Ⓛ] Non-Magnetic .047 Tin Pl Cu 4CT-240290-
12	-0120	\$105.60	\$107.05	\$105.60	\$106.30	\$108.48
24	-0240	\$109.40	\$112.30	\$109.40	\$110.80	\$115.16
36	-0360	\$113.20	\$117.55	\$113.20	\$115.30	\$121.84
48	-0480	\$117.00	\$122.80	\$117.00	\$119.80	\$128.52
60	-0600	\$120.80	\$128.05	\$120.80	\$124.30	\$135.20
72	-0720	\$124.60	\$133.30	\$124.60	\$128.80	\$141.88

Ⓛ Silver Plated Copper Center Conductor Ⓞ Silver Plated Copper Clad Steel Center Conductor

10% Discount @ 25 pcs. up 4% Discount @ 10 pcs. up



2.9 MM Female Bulkhead Jack x 2.9 MM Male Plug

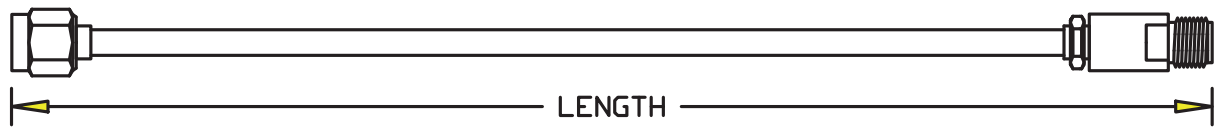

LENGTH IN INCHES	DASH NUMBER	50Ω RG 402Ⓞ M17/130-00004 .141 Cu Jacket 402-290295-	50Ω RG 402Ⓞ M17/130-00005 .141 Tin Plate Cu 1TS-290295-	50Ω RG 402Ⓛ M17/130-00009 .141 Tin Plate Al 1AT-290295-	50ΩMaxiFlexⓄ (No QPL List) .141 Tin Pl 14F-290295-	50Ω RG 402Ⓞ M17/130-00012 .141 Silver Pl 1SS-290295-
.141" Diameter SEMIRIGID and MaxiFlex Direct Solder Connectors						
12	-0120	\$150.78	\$150.42	\$150.78	\$150.42	\$159.99
24	-0240	\$154.38	\$153.66	\$154.38	\$153.66	\$172.80
36	-0360	\$157.98	\$156.90	\$157.98	\$156.90	\$185.61
48	-0480	\$161.58	\$160.14	\$161.58	\$160.14	\$198.42
60	-0600	\$165.18	\$163.38	\$165.18	\$163.38	\$211.23
72	-0720	\$168.78	\$166.62	CALL	\$166.62	CALL
.085" Diameter SEMIRIGID and MaxiFlex Direct Solder Connectors						
LENGTH IN INCHES	DASH NUMBER	50Ω RG 405Ⓞ M17/133-00006 .085 Cu Jacket 405-290295-	50Ω RG 405Ⓞ M17/133-00007 .085 Tin Plate Cu 8TS- 290295-	50Ω RG 405Ⓞ M17/133-00013 .085 Tin Plate Al 8AT-290295-	50ΩMaxiFlexⓄ (No QPL List) .085 Tin Pl 08F-290295-	50Ω RG 405Ⓞ M17/133-00016 .085 Silver Pl 8SS-290295-
12	-0120	\$129.11	\$129.11	\$130.05	\$130.34	\$134.30
24	-0240	\$132.13	\$132.13	\$134.01	\$134.59	\$142.51
36	-0360	\$135.15	\$135.15	\$137.97	\$138.84	\$150.72
48	-0480	\$138.17	\$138.17	\$141.93	\$143.09	\$158.93
60	-0600	\$141.19	\$141.19	\$145.89	\$147.34	\$167.14
72	-0720	\$144.21	\$144.21	CALL	\$151.59	CALL
.047" Diameter SEMIRIGID and MaxiFlex Direct Solder Connectors						
LENGTH IN INCHES	DASH NUM	50 Ω Ⓞ M17/151-00001 .047 Cu Jacket 4CU-290295-	50 Ω Ⓞ (No QPL List) .047 Tin Plate Al 4AT-290295-	50 Ω Ⓞ M17/151-00002 .047 Tin Pl Cu 4TS-290295-	50 Ω MaxiFlex Ⓞ (No QPL List) .047 Tin Pl 04F-290295-	50 Ω Ⓛ Non-Magnetic .047 Tin Pl Cu 4CT-290295-
12	-0120	\$96.08	\$97.53	\$96.08	\$96.78	\$98.96
24	-0240	\$99.88	\$102.78	\$99.88	\$101.28	\$105.64
36	-0360	\$103.68	\$108.03	\$103.68	\$105.78	\$112.32
48	-0480	\$107.48	\$113.28	\$107.48	\$110.28	\$119.00
60	-0600	\$111.28	\$118.53	\$111.28	\$114.78	\$125.68
72	-0720	\$115.08	\$123.78	\$115.08	\$119.28	\$132.36

ⓁSilver Plated Copper Center Conductor ⓄSilver Plated Copper Clad Steel Center Conductor

10% Discount @ 25 pcs. up 4% Discount @ 10 pcs. up



2.9 MM Female Jack x 2.9 MM Male Plug



LENGTH IN INCHES	DASH NUMBER	50Ω RG 402 [Ⓢ] M17/130-00004 .141 Cu Jacket 402-290291-	50Ω RG 402 [Ⓢ] M17/130-00005 .141 Tin Plate Cu 1TS-290291-	50Ω RG 402 [Ⓢ] M17/130-00009 .141 Tin Plate Al 1AT-290291-	50ΩMaxiFlex [Ⓢ] (No QPL List) .141 Tin Pl 14F-290291-	50Ω RG 402 [Ⓢ] M17/130-00012 .141 Silver Pl 1SS-290291-
.141" Diameter SEMIRIGID and MaxiFlex Direct Solder Connectors						
12	-0120	\$135.46	\$135.10	\$135.46	\$135.10	\$144.67
18	-0180	\$137.26	\$136.72	\$137.26	\$136.72	\$151.08
24	-0240	\$139.06	\$138.34	\$139.06	\$138.34	\$157.48
30	-0300	\$140.86	\$139.96	\$140.86	\$139.96	\$163.89
36	-0360	\$142.66	\$141.58	\$142.66	\$141.58	\$170.29
42	-0420	\$144.46	\$143.20	\$144.46	\$143.20	\$176.70
48	-0480	\$146.26	\$144.82	\$146.26	\$144.82	\$183.10
54	-0540	\$148.06	\$146.44	\$148.06	\$146.44	\$189.51
60	-0600	\$149.86	\$148.06	\$149.86	\$148.06	\$195.91
66	-0660	\$151.66	\$149.68	CALL	\$149.68	CALL
72	-0720	\$153.46	\$151.30	CALL	\$151.30	CALL
.085" Diameter SEMIRIGID and MaxiFlex Direct Solder Connectors						
LENGTH IN INCHES	DASH NUMBER	50Ω RG 405 [Ⓢ] M17/133-00006 .085 Cu Jacket 405-290291-	50Ω RG 405 [Ⓢ] M17/133-00007 .085 Tin Plate Cu 8TS- 290291-	50Ω RG 405 [Ⓢ] M17/133-00013 .085 Tin Plate Al 8AT-290291-	50ΩMaxiFlex [Ⓢ] (No QPL List) .085 Tin Pl 08F-290291-	50Ω RG 405 [Ⓢ] M17/133-00016 .085 Silver Pl 8SS-290291-
12	-0120	\$119.28	\$119.28	\$120.22	\$120.51	\$124.47
18	-0180	\$120.79	\$120.79	\$122.20	\$122.64	\$128.58
24	-0240	\$122.30	\$122.30	\$124.18	\$124.76	\$132.68
30	-0300	\$123.81	\$123.81	\$126.16	\$126.89	\$136.79
36	-0360	\$125.32	\$125.32	\$128.14	\$129.01	\$140.89
42	-0420	\$126.83	\$126.83	\$130.12	\$131.14	\$145.00
48	-0480	\$128.34	\$128.34	\$132.10	\$133.26	\$149.10
54	-0540	\$129.85	\$129.85	\$134.08	\$135.39	\$153.21
60	-0600	\$131.36	\$131.36	\$136.06	\$137.51	\$157.31
66	-0660	\$132.87	\$132.87	CALL	\$139.64	CALL
72	-0720	\$134.38	\$134.38	CALL	\$141.76	CALL

Ⓢ Silver Plated Copper Center Conductor Ⓢ Silver Plated Copper Clad Steel Center Conductor

10% Discount @ 25 pcs. up 4% Discount @ 10 pcs. up



2.9 MM Male Plug x 2.9 MM Male Plug



LENGTH IN INCHES	DASH NUMBER	50Ω RG 402Ⓢ M17/130-00004 .141 Cu Jacket 402-290290-	50Ω RG 402Ⓢ M17/130-00005 .141 Tin Plate Cu 1TS-290290-	50Ω RG 402Ⓢ M17/130-00009 .141 Tin Plate Al 1AT-290290-	50ΩMaxiFlexⓈ (No QPL List) .141 Tin Pl 14F-290290-	50Ω RG 402Ⓢ M17/130-00012 .141 Silver Pl 1SS-290290-
.141" Diameter SEMIRIGID and MaxiFlex Direct Solder Connectors						
12	-0120	\$79.80	\$79.44	\$79.80	\$79.44	\$89.01
24	-0240	\$83.40	\$82.68	\$83.40	\$82.68	\$101.82
36	-0360	\$87.00	\$85.92	\$87.00	\$85.92	\$114.63
48	-0480	\$90.60	\$89.16	\$90.60	\$89.16	\$127.44
60	-0600	\$94.20	\$92.40	\$94.20	\$92.40	\$140.25
72	-0720	\$97.80	\$95.64	CALL	\$95.64	CALL
.085" Diameter SEMIRIGID and MaxiFlex Direct Solder Connectors						
LENGTH IN INCHES	DASH NUMBER	50Ω RG 405Ⓢ M17/133-00006 .085 Cu Jacket 405-290290-	50Ω RG 405Ⓢ M17/133-00007 .085 Tin Plate Cu 8TS- 290290-	50Ω RG 405Ⓢ M17/133-00013 .085 Tin Plate Al 8AT-290290-	50ΩMaxiFlexⓈ (No QPL List) .085 Tin Pl 08F-290290-	50Ω RG 405Ⓢ M17/133-00016 .085 Silver Pl 8SS-290290-
12	-0120	\$79.22	\$79.22	\$80.16	\$80.45	\$84.41
24	-0240	\$82.24	\$82.24	\$84.12	\$84.70	\$92.62
36	-0360	\$85.26	\$85.26	\$88.08	\$88.95	\$100.83
48	-0480	\$88.28	\$88.28	\$92.04	\$93.20	\$109.04
60	-0600	\$91.30	\$91.30	\$96.00	\$97.45	\$117.25
72	-0720	\$94.32	\$94.32	CALL	\$101.70	CALL
.047" Diameter SEMIRIGID and MaxiFlex Direct Solder Connectors						
LENGTH IN INCHES	DASH NUM	50 Ω Ⓢ M17/151-00001 .047 Cu Jacket 4CU-290290-	50 Ω Ⓢ (No QPL List) .047 Tin Plate Al 4AT-290290-	50 Ω Ⓢ M17/151-00002 .047 Tin Pl Cu 4TS-290290-	50 Ω MaxiFlex Ⓢ (No QPL List) .047 Tin Pl 04F-290290-	50 Ω Ⓢ Non-Magnetic .047 Tin Pl Cu 4CT-290290-
12	-0120	\$107.76	\$109.21	\$107.76	\$108.46	\$110.64
24	-0240	\$111.56	\$114.46	\$111.56	\$112.96	\$117.32
36	-0360	\$115.36	\$119.71	\$115.36	\$117.46	\$124.00
48	-0480	\$119.16	\$124.96	\$119.16	\$121.96	\$130.68
60	-0600	\$122.96	\$130.21	\$122.96	\$126.46	\$137.36
72	-0720	\$126.76	\$135.46	\$126.76	\$130.96	\$144.04

ⓈSilver Plated Copper Center Conductor ⓈSilver Plated Copper Clad Steel Center Conductor

10% Discount @ 25 pcs. up 4% Discount @ 10 pcs. up



3.5 MM Female Bulkhead Jack x 3.5 MM Male Plug



LENGTH IN INCHES	DASH NUMBER	50Ω RG 402 [Ⓢ] M17/130-00004 .141 Cu Jacket 402-350355-	50Ω RG 402 [Ⓢ] M17/130-00005 .141 Tin Plate Cu 1TS-350355-	50Ω RG 402 [Ⓢ] M17/130-00009 .141 Tin Plate Al 1AT-350355-	50ΩMaxiFlex [Ⓢ] (No QPL List) .141 Tin Pl 14F-350355-	50Ω RG 402 [Ⓢ] M17/130-00012 .141 Silver Pl 1SS-350355-
.141" Diameter SEMIRIGID and MaxiFlex Direct Solder Connectors						
4	-0040	\$239.75	\$239.63	\$239.75	\$239.63	\$242.82
6	-0060	\$240.35	\$240.17	\$240.35	\$240.17	\$244.96
8	-0080	\$240.95	\$240.71	\$240.95	\$240.71	\$247.09
10	-0100	\$241.55	\$241.25	\$241.55	\$241.25	\$249.23
12	-0120	\$242.15	\$241.79	\$242.15	\$241.79	\$251.36
16	-0160	\$243.35	\$242.87	\$243.35	\$242.87	\$255.63
24	-0240	\$245.75	\$245.03	\$245.75	\$245.03	\$264.17
36	-0360	\$249.35	\$248.27	\$249.35	\$248.27	\$276.98
48	-0480	\$252.95	\$251.51	\$252.95	\$251.51	\$289.79
60	-0600	\$256.55	\$254.75	\$256.55	\$254.75	\$302.60
72	-0720	\$260.15	\$257.99	\$260.15	\$257.99	\$315.41
.085" Diameter SEMIRIGID and MaxiFlex Direct Solder Connectors						
LENGTH IN INCHES	DASH NUMBER	50Ω RG 405 [Ⓢ] M17/133-00006 .085 Cu Jacket 405-350355-	50Ω RG 405 [Ⓢ] M17/133-00007 .085 Tin Plate Cu 8TS-350355-	50Ω RG 405 [Ⓢ] M17/133-00013 .085 Tin Plate Al 8AT-350355-	50ΩMaxiFlex [Ⓢ] (No QPL List) .085 Tin Pl 08F-350355-	50Ω RG 405 [Ⓢ] M17/133-00016 .085 Silver Pl 8SS-350355-
4	-0040	\$135.06	\$135.06	\$135.36	\$135.47	\$136.79
6	-0060	\$135.56	\$135.56	\$136.02	\$136.18	\$138.16
8	-0080	\$136.06	\$136.06	\$136.67	\$136.88	\$139.52
10	-0100	\$136.57	\$136.57	\$137.33	\$137.59	\$140.89
12	-0120	\$137.07	\$137.07	\$137.98	\$138.30	\$142.26
16	-0160	\$138.08	\$138.08	\$139.29	\$139.72	\$145.00
24	-0240	\$140.09	\$140.09	\$141.91	\$142.55	\$150.47
36	-0360	\$143.11	\$143.11	\$145.84	\$146.80	\$158.68
48	-0480	\$146.13	\$146.13	\$149.77	\$151.05	\$166.89
60	-0600	\$149.15	\$149.15	\$153.70	\$155.30	\$175.10
72	-0720	\$152.17	\$152.17	CALL	\$159.55	CALL

Ⓢ Silver Plated Copper Center Conductor Ⓢ Silver Plated Copper Clad Steel Center Conductor

10% Discount @ 25 pcs. up 4% Discount @ 10 pcs. up



3.5 MM Female Jack x 3.5 Male Plug



LENGTH IN INCHES	DASH NUMBER	50Ω RG 402② M17/130-00004 .141 Cu Jacket 402-350351-	50Ω RG 402② M17/130-00005 .141 Tin Plate Cu 1TS-350351-	50Ω RG 402① M17/130-00009 .141 Tin Plate Al 1AT-350351-	50ΩMaxiFlex② (No QPL List) .141 Tin Pl 14F-350351-	50Ω RG 402② M17/130-00012 .141 Silver Pl 1SS-350351-
.141" Diameter SEMIRIGID and MaxiFlex Direct Solder Connectors						
4	-0040	\$138.61	\$138.49	\$138.61	\$138.49	\$141.68
6	-0060	\$139.21	\$139.03	\$139.21	\$139.03	\$143.82
8	-0080	\$139.81	\$139.57	\$139.81	\$139.57	\$145.95
10	-0100	\$140.41	\$140.11	\$140.41	\$140.11	\$148.09
12	-0120	\$141.01	\$140.65	\$141.01	\$140.65	\$150.22
16	-0160	\$142.21	\$141.73	\$142.21	\$141.73	\$154.49
24	-0240	\$144.61	\$143.89	\$144.61	\$143.89	\$163.03
36	-0360	\$148.21	\$147.13	\$148.21	\$147.13	\$175.84
48	-0480	\$151.81	\$150.37	\$151.81	\$150.37	\$188.65
60	-0600	\$155.41	\$153.61	\$155.41	\$153.61	\$201.46
72	-0720	\$159.01	\$156.85	\$159.01	\$156.85	\$214.27
.085" Diameter SEMIRIGID and MaxiFlex Direct Solder Connectors						
LENGTH IN INCHES	DASH NUMBER	50Ω RG 405② M17/133-00006 .085 Cu Jacket 405-350351-	50Ω RG 405② M17/133-00007 .085 Tin Plate Cu 8TS-350351-	50Ω RG 405② M17/133-00013 .085 Tin Plate Al 8AT-350351-	50ΩMaxiFlex② (No QPL List) .085 Tin Pl 08F-350351-	50Ω RG 405② M17/133-00016 .085 Silver Pl 8SS-350351-
4	-0040	\$113.54	\$113.54	\$113.85	\$113.95	\$115.27
6	-0060	\$114.04	\$114.04	\$114.51	\$114.66	\$116.64
8	-0080	\$114.54	\$114.54	\$115.17	\$115.36	\$118.00
10	-0100	\$115.05	\$115.05	\$115.83	\$116.07	\$119.37
12	-0120	\$115.55	\$115.55	\$116.49	\$116.78	\$120.74
16	-0160	\$116.56	\$116.56	\$117.81	\$118.20	\$123.48
24	-0240	\$118.57	\$118.57	\$120.45	\$121.03	\$128.95
36	-0360	\$121.59	\$121.59	\$124.41	\$125.28	\$137.16
48	-0480	\$124.61	\$124.61	\$128.37	\$129.53	\$145.37
60	-0600	\$127.63	\$127.63	\$132.33	\$133.78	\$153.58
72	-0720	\$130.65	\$130.65	CALL	\$138.03	CALL

①Silver Plated Copper Center Conductor ②Silver Plated Copper Clad Steel Center Conductor

10% Discount @ 25 pcs. up 4% Discount @ 10 pcs. up



Phone 856-488-2000 Fax 856-488-2020

7850 Browning Rd. Pennsauken, NJ 08109

Online @ www.rfdepot.com

Toll Free 877-RF Depot

B241

3.5 MM Male Plug x 3.5 MM Male Plug



LENGTH IN INCHES	DASH NUMBER	50Ω RG 402 [Ⓞ] M17/130-00004 .141 Cu Jacket 402-350350-	50Ω RG 402 [Ⓞ] M17/130-00005 .141 Tin Plate Cu 1TS-350350-	50Ω RG 402 [Ⓛ] M17/130-00009 .141 Tin Plate Al 1AT-350350-	50ΩMaxiFlex [Ⓞ] (No QPL List) .141 Tin Pl 14F-350350-	50Ω RG 402 [Ⓞ] M17/130-00012 .141 Silver Pl 1SS-350350-
.141" Diameter SEMIRIGID and MaxiFlex Direct Solder Connectors						
12	-0120	\$125.56	\$125.20	\$125.56	\$125.20	\$134.77
24	-0240	\$129.16	\$128.44	\$129.16	\$128.44	\$147.58
36	-0360	\$132.76	\$131.68	\$132.76	\$131.68	\$160.39
48	-0480	\$136.36	\$134.92	\$136.36	\$134.92	\$173.20
60	-0600	\$139.96	\$138.16	\$139.96	\$138.16	\$186.01
72	-0720	\$143.56	\$141.40	\$143.56	\$141.40	\$198.82
.085" Diameter SEMIRIGID and MaxiFlex Direct Solder Connectors						
LENGTH IN INCHES	DASH NUMBER	50Ω RG 405 [Ⓞ] M17/133-00006 .085 Cu Jacket 405-350350-	50Ω RG 405 [Ⓞ] M17/133-00007 .085 Tin Plate Cu 8TS-350350-	50Ω RG 405 [Ⓞ] M17/133-00013 .085 Tin Plate Al 8AT-350350-	50ΩMaxiFlex [Ⓞ] (No QPL List) .085 Tin Pl 08F-350350-	50Ω RG 405 [Ⓞ] M17/133-00016 .085 Silver Pl 8SS-350350-
12	-0120	\$121.28	\$121.28	\$122.22	\$122.51	\$126.47
24	-0240	\$124.30	\$124.30	\$126.18	\$126.76	\$134.68
36	-0360	\$127.32	\$127.32	\$130.14	\$131.01	\$142.89
48	-0480	\$130.34	\$130.34	\$134.10	\$135.26	\$151.10
60	-0600	\$133.36	\$133.36	\$138.06	\$139.51	\$159.31
72	-0720	\$136.38	\$136.38	CALL	\$143.76	CALL
.047" Diameter SEMIRIGID and MaxiFlex Direct Solder Connectors						
LENGTH IN INCHES	DASH NUM	50 Ω [Ⓞ] M17/151-00001 .047 Cu Jacket 4CU-350350-	50 Ω [Ⓞ] (No QPL List) .047 Tin Plate Al 4AT-350350-	50 Ω [Ⓞ] M17/151-00002 .047 Tin Pl Cu 4TS-350350-	50 Ω MaxiFlex [Ⓞ] (No QPL List) .047 Tin Pl 04F-350350-	50 Ω [Ⓛ] Non-Magnetic .047 Tin Pl Cu 4CT-350350-
12	-0120	\$130.76	\$132.21	\$130.76	\$131.46	\$133.64
24	-0240	\$134.56	\$137.46	\$134.56	\$135.96	\$140.32
36	-0360	\$138.36	\$142.71	\$138.36	\$140.46	\$147.00
48	-0480	\$142.16	\$147.96	\$142.16	\$144.96	\$153.68
60	-0600	\$145.96	\$153.21	\$145.96	\$149.46	\$160.36
72	-0720	\$149.76	\$158.46	\$149.76	\$153.96	\$167.04

Ⓛ Silver Plated Copper Center Conductor Ⓞ Silver Plated Copper Clad Steel Center Conductor

10% Discount @ 25 pcs. up 4% Discount @ 10 pcs. up



7-16 Female Bulkhead Jack x 7-16 Male Plug

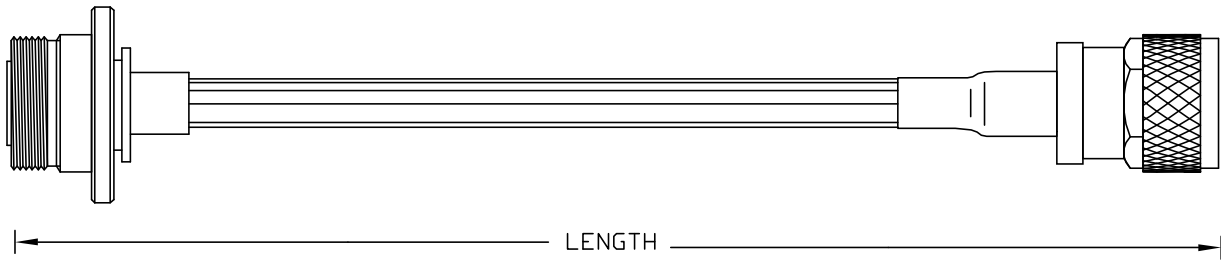

LTH IN INS	DASH NUM	50 Ω CCS 195 ^{①③} 2 shields ^② 19C-716A716F-	50 Ω LMR 195 ^{①③} 2 shields ^② 19M-716A716F-	50 Ω CCS 240 ^{①③} 2 shields ^② 24C-716A716F-	50 Ω LMR 240 ^{①③} 2 shields ^② 24L-716A716F-	50 Ω CCS 240UF ^{①③} 2 shields ^② 24U-716A716F-	50 Ω LMR 240UF ^{①③} 2 shields ^② 24UF-716A716F-
Solder Center, Crimp Outer with Strain Relief							
48	-0480	\$82.80	\$83.36	\$79.04	\$80.72	\$79.28	\$81.36
72	-0720	\$83.94	\$84.78	\$80.24	\$82.76	\$80.60	\$83.72
96	-0960	\$85.08	\$86.20	\$81.44	\$84.80	\$81.92	\$86.08
120	-1200	\$86.22	\$87.62	\$82.64	\$86.84	\$83.24	\$88.44
144	-1440	\$87.36	\$89.04	\$83.84	\$88.88	\$84.56	\$90.80
180	-1800	\$89.07	\$91.17	\$85.64	\$91.94	\$86.54	\$94.34
240	-2400	\$91.92	\$94.72	\$88.64	\$97.04	\$89.84	\$100.24
Solder Center, Crimp and Clamp Outer							
LTH IN INS	DASH NUM	50 Ω CCS 400 ^{①④} 2 shields ^② 4LC-716A716F-	50 Ω LMR 400 ^{①④} 2 shields ^② 4LM-716A716F-	50 Ω CCS 400DB ^{①④} 2 shields ^② 4DC-716A716F-	50 Ω ^④ LMR 400DB ^① 2 shields ^② 4LD-716A716F-	50 Ω CCS 400FR ^{①④} 2 shields ^② 4RC-716A716F-	50 Ω LMR 400FR ^{①④} 2 shields ^② 4LR-716A716F-
48	-0480	\$116.68	\$118.76	\$117.16	\$119.64	\$117.16	\$120.84
72	-0720	\$118.40	\$121.52	\$119.12	\$122.84	\$119.12	\$124.64
96	-0960	\$120.12	\$124.28	\$121.08	\$126.04	\$121.08	\$128.44
120	-1200	\$121.84	\$127.04	\$123.04	\$129.24	\$123.04	\$132.24
144	-1440	\$123.56	\$129.80	\$125.00	\$132.44	\$125.00	\$136.04
180	-1800	\$126.14	\$133.94	\$127.94	\$137.24	\$127.94	\$141.74
240	-2400	\$130.44	\$140.84	\$132.84	\$145.24	\$132.84	\$151.24
Solder Center, Crimp and Clamp Outer							
LENGTH IN INCHES	DASH NUMBER	50 Ω CCS 400UF ^{①④} 2 shields ^② 4UC-716A716F-	50 Ω LMR 400UF ^{①④} 2 shields ^② 4LU-716A716F-	50 Ω LMR 600 ^{①④} 2 shields ^② 6LM-716A716F-	50 Ω EF 142 ^① 2 shields ^② 42E-716A716F-	50 Ω EF 393 ^① 2 shields ^② 93E-716A716F-	
48	-0480	\$117.16	\$120.84	\$122.52	\$99.97	\$128.18	
72	-0720	\$119.12	\$124.64	\$126.52	\$105.01	\$146.74	
96	-0960	\$121.08	\$128.44	\$130.52	\$110.05	\$165.30	
120	-1200	\$123.04	\$132.24	\$134.52	\$115.09	\$183.86	
144	-1440	\$125.00	\$136.04	\$138.52	\$120.13	\$202.42	
180	-1800	\$127.94	\$141.74	\$144.52	\$127.69	\$230.26	
Color Designators (add letter to the end of the part number and add \$1.00 to price)							
Black - B		Blue - L		Brown - N		Gray - A	
Orange - O		Red - R		Violet - V		Green - G	
						White - W	

See Page B5 for Cable Characteristics

* Contact Factory for delivery, Consider new RD316 for (RD188) 10% Discount @ 25 pcs. up 4% Discount @ 10 pcs. up

7-16 Female Jack x 7-16 Male Plug

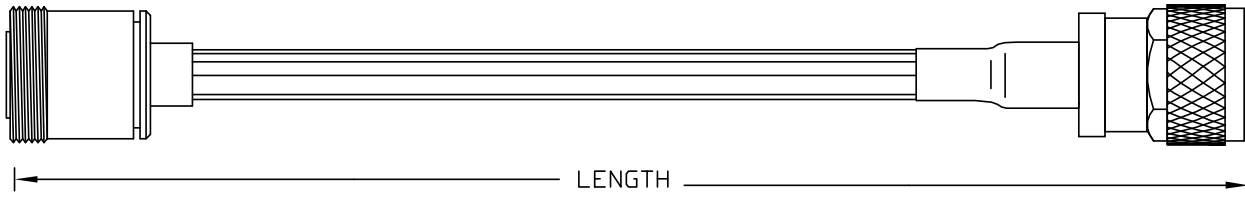

LTH IN INS	DASH NUM	50 Ω CSS 195 ① 2 shields 19C-716B716C-	50 Ω LMR 195 ①③ 2 shields③ 19M-716B716C-	50 Ω CCS 240 ①③ 2 shields③ 24C-716B716C-	50 Ω LMR 240 ①③ 2 shields③ 24L-716B716C-	50 Ω CCS 240UF ①③ 2 shields③ 24U-716B716C-	50 Ω LMR 240UF ①③ 2 shields③ 24UF-716B716C-
Solder Center, Crimp Outer							
48	-0480	\$77.76	\$78.32	\$79.04	\$80.72	\$79.28	\$81.36
72	-0720	\$78.90	\$79.74	\$80.24	\$82.76	\$80.60	\$83.72
96	-0960	\$80.04	\$81.16	\$81.44	\$84.80	\$81.92	\$86.08
120	-1200	\$81.18	\$82.58	\$82.64	\$86.84	\$83.24	\$88.44
144	-1440	\$82.32	\$84.00	\$83.84	\$88.88	\$84.56	\$90.80
180	-1800	\$84.03	\$86.13	\$85.64	\$91.94	\$86.54	\$94.34
240	-2400	\$86.88	\$89.68	\$88.64	\$97.04	\$89.84	\$100.24
Solder Center, Crimp Outer							
LTH IN INS	DASH NUM	50 Ω CCS 400 ①④ 2 shields④ 4LC-716B716C-	50 Ω LMR 400 ①④ 2 shields④ 4LM-716B716C-	50 Ω CCS 400DB ①④ 2 shields④ 4DC-716B716C-	50 Ω④ LMR 400DB ① 2 shields④ 4LD-716B716C-	50 Ω CCS 400FR ①④ 2 shields④ 4RC-716B716C-	50 Ω LMR 400FR①④ 2 shields④ 4LR716B716C-
48	-0480	\$107.26	\$109.34	\$107.74	\$110.22	\$107.74	\$111.42
72	-0720	\$108.98	\$112.10	\$109.70	\$113.42	\$109.70	\$115.22
96	-0960	\$110.70	\$114.86	\$111.66	\$116.62	\$111.66	\$119.02
120	-1200	\$112.42	\$117.62	\$113.62	\$119.82	\$113.62	\$122.82
180	-1800	\$114.14	\$120.38	\$115.58	\$123.02	\$115.58	\$126.62
240	-2400	\$119.30	\$128.66	\$121.46	\$132.62	\$121.46	\$138.02
Solder Center, Crimp Outer							
LENGTH IN INCHES	DASH NUMBER	50 Ω CSS 400 ① 2 shields 4LC-726B716C-	50 Ω LMR 400UF ①④ 2 shields④ 4LU-716B716C-	50 Ω LMR 600 ①④ 2 shields④ 6LM-716B716C-	50 Ω EF 142 ① 2 shields⑦ 42E-716B716C-	50 Ω EF 393 ① 2 shields⑦ 93E-716B716C-	
48	-0480	\$107.74	\$111.42	\$115.10	\$93.18	\$108.96	
72	-0720	\$109.70	\$115.22	\$119.10	\$98.22	\$127.52	
96	-0960	\$111.66	\$119.02	\$123.10	\$103.26	\$146.08	
120	-1200	\$113.62	\$122.82	\$127.10	\$108.30	\$164.64	
144	-1440	\$115.58	\$126.62	\$131.10	\$113.34	\$183.20	
180	-1800	\$118.52	\$132.32	\$137.10	\$120.90	\$211.04	
240	-2400	\$125.42	\$143.82	\$147.10	\$133.50	\$257.44	
Color Designators (add letter to the end of the part number and add \$1.00 to price)							
Black - B		Blue - L		Brown - N		Gray - A	
Orange - O		Red - R		Violet - V		Green - G	
						White - W	

See Page B5 for Cable Characteristics

* Contact Factory for delivery, Consider new RD316 for (RD188) 10 % Discount @ 25 pcs. up 4% Discount @ 10 pcs. up



RF Depot.com Inc.

Phone 856-488-2000 Fax 856-488-2020

B244

7850 Browning Rd. Pennsauken, NJ 08109

Online @ www.rfdepot.com

Toll Free 877-RF Depot

7-16 Male Plug x 7-16 Male Plug



←————— LENGTH —————→

LTH IN INS	DASH NUM	50 Ω CSS 100 ①③ 2 shields③ 1LC-716A716A-	50 Ω LMR 100 ①③ 2 shields③ 1LM-716A716A-	50 Ω CCS 195 ①③ 2 shields③ 19C-716A716A-	50 Ω LMR 195 ①③ 2 shields③ 19M-716A716A-	50 Ω CCS 200 ①③ 2 shields③ 2LC-716A716A-	50 Ω LMR 200 ① 2 shields 2LM-716A716A-
Solder Center, Crimp Outer							
12	-0120	\$78.30	\$78.42	\$74.37	\$74.51	\$120.68	\$120.73
24	-0240	\$78.84	\$79.08	\$74.94	\$75.22	\$121.36	\$121.46
36	-0360	\$79.38	\$79.74	\$75.51	\$75.93	\$122.04	\$122.19
48	-0480	\$79.92	\$80.40	\$76.08	\$76.64	\$122.72	\$122.92
72	-0720	\$81.00	\$81.72	\$77.22	\$78.06	\$124.08	\$124.38
96	-0960	\$82.08	\$83.04	\$78.36	\$79.48	\$125.44	\$125.84
120	-1200	\$83.16	\$84.36	\$79.50	\$80.90	\$126.80	\$127.30
144	-1440	\$84.24	\$85.68	\$80.64	\$82.32	\$128.16	\$128.76
180	-1800	\$85.86	\$87.66	\$82.35	\$84.45	\$130.20	\$130.95
216	-2160	\$87.48	\$89.64	\$84.06	\$86.58	\$132.24	\$133.14
240	-2400	\$88.56	\$90.96	\$85.20	\$88.00	\$133.60	\$134.60
Solder Center, Crimp Outer							
LTH IN INS	DASH NUM	50 Ω CCS 240 ①③ 2 shields③ 24C-716A716A-	50 Ω LMR 240 ①③ 2 shields③ 24L-716A716A-	50 Ω CCS 400 ①④ 2 shields③ 4LC-716A716A-	50 Ω LMR 400 ①④ 2 shields③ 4LM-716A716A-	50 Ω CSS 400DB ① 2 shields 4DC-716A716A-	50 Ω LMR 400DB①④ 2 shields③ 4LD-716A716A-
48	-0480	\$79.32	\$81.00	\$122.68	\$124.76	\$123.16	\$125.64
72	-0720	\$80.52	\$83.04	\$124.40	\$127.52	\$125.12	\$128.84
96	-0960	\$81.72	\$85.08	\$126.12	\$130.28	\$127.08	\$132.04
120	-1200	\$82.92	\$87.12	\$127.84	\$133.04	\$129.04	\$135.24
144	-1440	\$84.12	\$89.16	\$129.56	\$135.80	\$131.00	\$138.44
180	-1800	\$85.92	\$92.22	\$132.14	\$139.94	\$133.94	\$143.24
216	-2160	\$87.72	\$95.28	\$134.72	\$144.08	\$136.88	\$148.04
240	-2400	\$88.92	\$97.32	\$136.44	\$146.84	\$138.84	\$151.24
Color Designators (add letter to the end of the part number and add \$1.00 to price)							
Black - B		Blue - L		Brown - N		Gray - A	
Orange - O		Red - R		Violet - V		Green - G	
						White - W	

See Page B5 for Cable Characteristics

* Contact Factory for delivery, Consider new RD316 for (RD188)

10% Discount @ 25 pcs. up

4% Discount @ 10 pcs. up

7-16 Male Plug x 7-16 Male Plug



←————— LENGTH —————→

LENGTH IN INCHES	DASH NUMBER	50 Ω CCS 400FR ^④ 2 shields ^⑦ 4RC-716A716A-	50 Ω LMR 400FR ^④ 2 shields ^⑦ 4LR-716A716A-	50 Ω CCS 400UF ^④ 2 shields ^⑦ 4UC-716A716-	50 Ω ^④ LMR 400UF ^④ 2 shields ^⑦ 4LU-716A716-	50 Ω LMR 600 ^④ 2 shields ^⑦ 6LM-716A716A-
Solder Center, Crimp Outer						
72	-0720	\$125.12	\$130.64	\$125.12	\$130.64	\$85.80
96	-0960	\$127.08	\$134.44	\$127.08	\$134.44	\$89.80
120	-1200	\$129.04	\$138.24	\$129.04	\$138.24	\$93.80
144	-1440	\$131.00	\$142.04	\$131.00	\$142.04	\$97.80
180	-1800	\$133.94	\$147.74	\$133.94	\$147.74	\$103.80
240	-2400	\$138.84	\$157.24	\$138.84	\$157.24	\$113.80
Solder Center, Crimp Outer						
LENGTH IN INCHES	DASH NUM	50 Ω RG 58C ^{③⑥} 1 shield ^⑦ 058-716A716A-	50 Ω RG 142 ^{④②} 2 shields ^⑦ 142-716A716A-	50 Ω RG 223 ^{③①} 2 shields ^⑦ 223-716A716A-	50 Ω RG 316 ^{④②} 2 shields ^⑦ 316-716A716A	50 Ω EF 142 ^① 2 shields ^⑦ 42E-716A716A-
72	-0720	\$76.20	\$87.60	\$82.62	\$81.66	\$88.92
96	-0960	\$77.00	\$92.20	\$85.56	\$82.96	\$93.96
120	-1200	\$77.80	\$96.80	\$88.50	\$84.26	\$99.00
144	-1440	\$78.60	\$101.40	\$91.44	\$85.56	\$104.04
180	-1800	\$79.80	\$108.30	\$95.85	\$87.51	\$111.60
240	-2400	\$81.80	\$119.80	\$103.20	\$90.76	\$124.20
Solder Center, Crimp Outer						
LENGTH IN INCHES	DASH NUMBER	50 Ω RG 213 ^{③③} 2 shields ^⑦ 213-716A716A-	50 Ω RG 214 ^{③①} 2 shields ^⑦ 214-716A716A-	50 Ω RG 393 ^{④①} 2 shields ^⑦ 393-719A719A-	50 Ω FSJF-50B ^④ 1 shield .500" SUPERFLEX 50J-71607160-	
72	-0720	\$96.84	\$90.26	\$121.04	\$130.20	
96	-0960	\$100.00	\$97.26	\$138.30	\$141.40	
120	-1200	\$103.16	\$104.26	\$155.56	\$152.60	
144	-1440	\$106.32	\$111.26	\$172.82	\$163.80	
180	-1800	\$111.06	\$121.76	\$198.71	\$180.60	
240	-2400	\$118.96	\$139.26	\$241.86	\$208.60	
Color Designators (add letter to the end of the part number and add \$1.00 to price)						
Black - B		Blue - L	Brown - N	Gray - A	Green - G	
Orange - O		Red - R	Violet - V	Yellow - Y	White - W	

See Page B5 for Cable Characteristics

* Contact Factory for delivery, Consider new RD316 for (RD188) 10 % Discount @ 25 pcs. up 4% Discount @ 10 pcs. up



RF Depot.com Inc.

Phone 856-488-2000 Fax 856-488-2020

B246

7850 Browning Rd. Pennsauken, NJ 08109

Online @ www.rfdepot.com

Toll Free 877-RF Depot

7-16 Male Plug x 7-16 Male Right Angle Plug

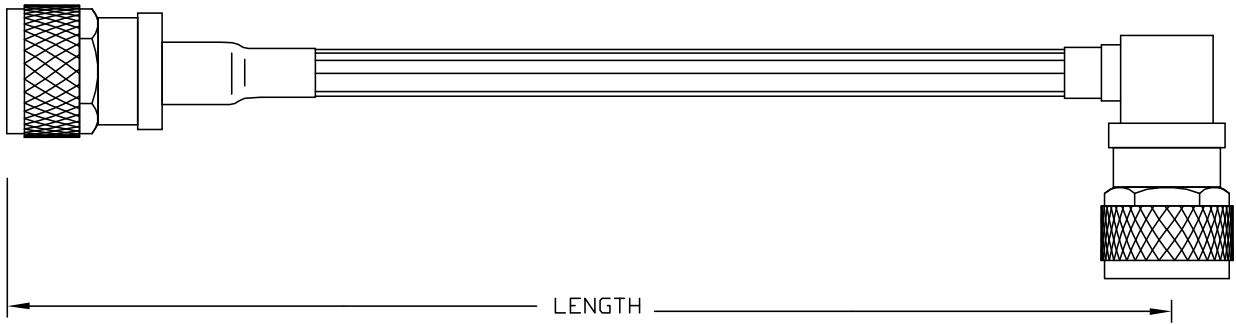

LTH IN INS	DASH NUM	50 Ω CCS 195③ 2 shields③ 19C-16A716C-	50 Ω LMR 195③ 2 shields③ 24C-16A716C-	50 Ω CCS 240③ 2 shields③ 24C-16A716C-	50 Ω LMR 240③ 2 shields③ 24L-716A716C-	50 Ω CSS-240UF① 2 shields 24U-16A716C-	50 Ω LMR 240UF③ 2 shields③ 24UF-716A716C-
Solder Center, Crimp Outer							
48	-0480	\$97.09	\$97.65	\$85.86	\$87.54	\$86.10	\$88.18
72	-0720	\$98.23	\$99.07	\$87.06	\$89.58	\$87.42	\$90.54
96	-0960	\$99.37	\$100.49	\$88.26	\$91.62	\$88.74	\$92.90
120	-1200	\$100.51	\$101.91	\$89.46	\$93.66	\$90.06	\$95.26
144	-1440	\$101.65	\$103.33	\$90.66	\$95.70	\$91.38	\$97.62
180	-1800	\$103.36	\$105.46	\$92.46	\$98.76	\$93.36	\$101.16
Solder Center, Crimp Outer							
LTH IN INS	DASH NUM	50 Ω CCS 400④ 2 shields③ 4LC-716A716C-	50 Ω LMR 400④ 2 shields③ 4LM-716A716C-	50 Ω CCS 400DB④ 2 shields③ 4DC-716A716C-	50 Ω LMR 400DB④ 2 shields③ 4LD-716A716C-	50 Ω CCS 400FR④ 2 shields③ 4RC-716A716C-	50 Ω LMR 400FR④ 2 shields③ 4LR-716A716C-
48	-0480	\$114.12	\$116.20	\$114.60	\$117.08	\$114.60	\$118.28
72	-0720	\$115.84	\$118.96	\$116.56	\$120.28	\$116.56	\$122.08
96	-0960	\$117.56	\$121.72	\$118.52	\$123.48	\$118.52	\$125.88
120	-1200	\$119.28	\$124.48	\$120.48	\$126.68	\$120.48	\$129.68
144	-1440	\$121.00	\$127.24	\$122.44	\$129.88	\$122.44	\$133.48
180	-1800	\$123.58	\$131.38	\$125.38	\$134.68	\$125.38	\$139.18
Solder Center, Crimp Outer							
LENGTH IN INCHES	DASH NUMBER	50 Ω CCS 400UF④ 2 shields③ 4CU-716A716C-	50 Ω LMR 400UF④ 2 shields③ 4LU-716A716C-	50 Ω LMR 600④ 2 shields③ 6LM-716A716C-	50 Ω EF 142① 2 shields③ 42E-716A716C-	50 Ω EF 393① 2 shields③ 93E-716A716C-	
48	-0480	\$114.60	\$118.28	\$123.30	\$105.09	\$120.72	
72	-0720	\$116.56	\$122.08	\$129.30	\$110.13	\$139.28	
96	-0960	\$118.52	\$125.88	\$135.30	\$115.17	\$157.84	
120	-1200	\$120.48	\$129.68	\$141.30	\$120.21	\$176.40	
144	-1440	\$122.44	\$133.48	\$147.30	\$125.25	\$194.96	
180	-1800	\$125.38	\$139.18	\$156.30	\$132.81	\$222.80	
Color Designators (add letter to the end of the part number and add \$1.00 to price)							
Black - B		Blue - L		Brown - N		Gray - A	
Orange - O		Red - R		Violet - V		Green - G	
						White - W	

See Page B5 for Cable Characteristics

* Contact Factory for delivery, Consider new RD316 for (RD188)

10% Discount @ 25 pcs. up

4% Discount @ 10 pcs. up

75 Ω BNC Female Bulkhead Jack x 75 Ω MCX Male Plug

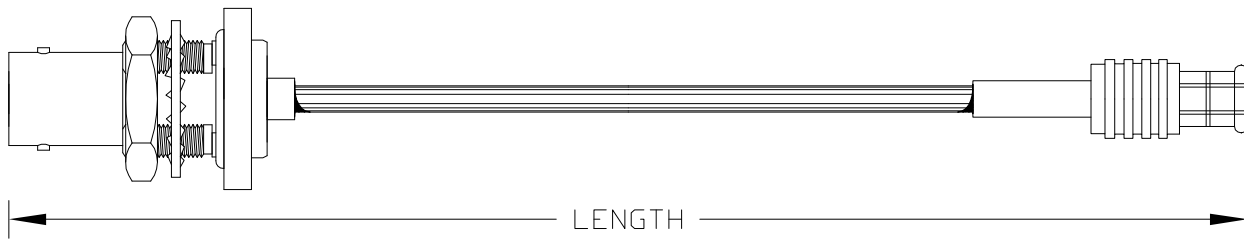

LENGTH IN INCHES	DASH NUMBER	75 Ω RG 179 ④② 2 shields⑩ 179-7XASF-	75 Ω RD 179A ② 1 shield⑦ 179D-7XASF-	75 Ω RD 187 ②③① 1 shield 187-7XASF-	75 Ω 735A ①⑤ 2 shields 735A-7XASF-
Solder Center, Crimp Outer with Strain Relief					
12	-0120	\$21.90	\$22.87	\$22.77	\$27.85
24	-0240	\$22.63	\$24.57	\$24.37	\$28.32
36	-0360	\$23.36	\$26.27	\$25.97	\$28.79
48	-0480	\$24.09	\$27.97	\$27.57	\$29.26
60	-0600	\$24.82	\$29.67	\$29.17	\$29.73
72	-0720	\$25.55	\$31.37	\$30.77	\$30.20

75 Ω BNC Female Bulkhead Jack x 75 Ω N Male Plug

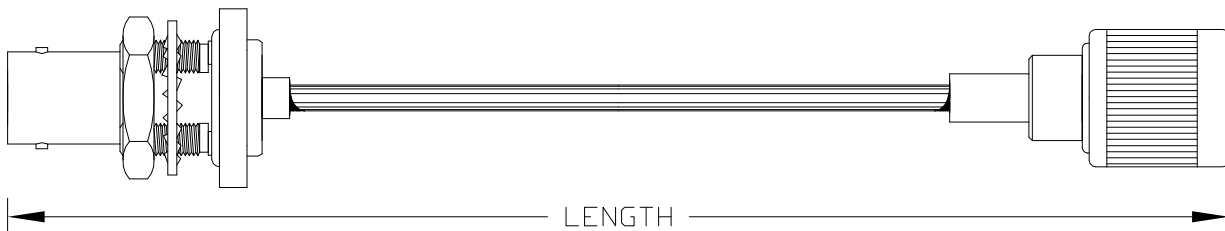

LENGTH IN INCHES	DASH NUMBER	75 Ω RG 6 ①⑤ 2 shields 006-N0S5-	75 Ω RG 59 ③⑤ 1 shield⑧ 059-NAS5-	75 Ω RG 62③⑤ 1 shield⑧ 062-NAS5-	75 Ω RG 179 ④② 1 shield⑩ 179-NASF-	75 Ω RG 187 ② 1 shield⑩ 187-NASF-
Solder Center, Clamp and Crimp Outer						
12	-0120	\$54.01	\$30.92	\$31.18	\$36.04	\$37.91
24	-0240	\$54.71	\$31.36	\$31.88	\$36.77	\$39.51
36	-0360	\$55.41	\$31.80	\$32.58	\$37.50	\$41.11
48	-0480	\$56.11	\$32.24	\$33.28	\$38.23	\$42.71
60	-0600	\$56.81	\$32.68	\$33.98	\$38.96	\$44.31
72	-0720	\$57.51	\$33.12	\$34.68	\$39.69	\$45.91
Color Designators (add letter to the end of the part number and add \$1.00 to price)						
Black - B		Blue - L		Brown - N		Gray - A
Orange - O		Red - R		Violet - V		Yellow - Y
						Green - G
						White - W

See Page B5 for Cable Characteristics

* Contact Factory for delivery, Consider new RD316 for (RD188) 10 % Discount @ 25 pcs. up 4% Discount @ 10 pcs. up



RF Depot.com Inc.

Phone 856-488-2000 Fax 856-488-2020

75 Ω BNC Female Jack x 75 Ω BNC Female Jack

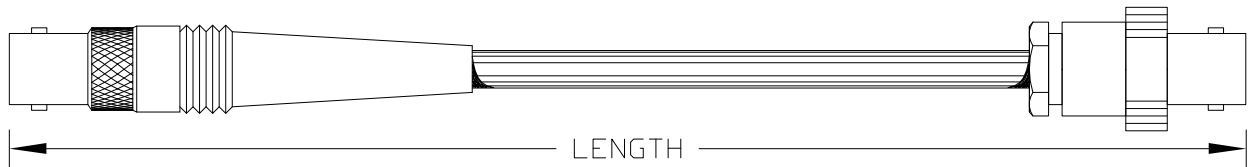

LENGTH IN INCHES	DASH NUMBER	75 Ω RG 6 ①⑤ 2 shields 006-S1S1-	75 Ω RG 11 ⑥ 1 shield⑥ 011-SBSB-	75 Ω RG 59 ③⑤ 1 shield⑧ 059-SBSB-	93 Ω RG 62 ③⑤ 1 shield⑧ 062-SBSB-	75 Ω RG 179 ④② 1 shield⑩ 179-SBSB-	75 Ω RG 187② 1 shield⑩ 187-SBSB-
Solder Center, Crimp Outer							
12	-0120	\$19.04	\$33.23	\$18.08	\$18.34	\$18.57	\$19.44
24	-0240	\$19.74	\$34.28	\$18.52	\$19.04	\$19.30	\$21.04
36	-0360	\$20.44	\$35.33	\$18.96	\$19.74	\$20.03	\$22.64
48	-0480	\$21.14	\$36.38	\$19.40	\$20.44	\$20.76	\$24.24
60	-0600	\$21.84	\$37.43	\$19.84	\$21.14	\$21.49	\$25.84
72	-0720	\$22.54	\$38.48	\$20.28	\$21.84	\$22.22	\$27.44

75 Ω BNC Female Jack x 75 Ω BNC Male Plug



LENGTH IN INCHES	DASH NUMBER	75 Ω RG 6 ①⑤ 2 shields 006-SASB-	75 Ω RG 11 ⑥ 1 shield⑥ 011-S0SB-	75 Ω RG 59 ③⑤ 1 shield⑧ 059-S0SB-	93 Ω RG 62 ③⑤ 1 shield⑧ 062-S0SB-	75 Ω RG 179 ④② 1 shield⑩ 179-S0SB-	75 Ω RG 187② 1 shield⑩ 187-S0SB-
Solder Center, Clamp and Crimp Outer							
12	-0120	\$18.15	\$30.31	\$18.32	\$18.58	\$18.44	\$19.31
24	-0240	\$18.85	\$31.36	\$18.76	\$19.28	\$19.17	\$20.91
36	-0360	\$19.55	\$32.41	\$19.20	\$19.98	\$19.90	\$22.51
48	-0480	\$20.25	\$33.46	\$19.64	\$20.68	\$20.63	\$24.11
60	-0600	\$20.95	\$34.51	\$20.08	\$21.38	\$21.36	\$25.71
72	-0720	\$21.65	\$35.56	\$20.52	\$22.08	\$22.09	\$27.31
Color Designators (add letter to the end of the part number and add \$1.00 to price)							
Black - B		Blue - L		Brown - N		Gray - A	
Orange - O		Red - R		Violet - V		Green - G	
						White - W	

See Page B5 for Cable Characteristics

* Contact Factory for delivery, Consider new RD316 for (RD188)

10% Discount @ 25 pcs. up

4% Discount @ 10 pcs. up

75 BNC Male Plug x 75 BNC Male Plug



LTH IN INS	DASH NUM	75 Ω RG 6 ①③ 2 shields 006-SASA-	75 Ω RG 11 ⑥ 1 shield⑥ 011-SASA-	75 Ω RG 59 ③⑤ 1 shield⑧ 059-SASA-	93 Ω RG 62 ③⑤ 1 shield⑧ 062-SASA-	75 Ω RG 179 ④② 1 shield⑩ 179-SASA-	75 Ω RG 187⑦ 1 shield⑩ 187-SASA-	75 Ω RG 216③ 2 shields⑥ 216-SASA-
Solder Center, Crimp Outer with Strain Relief								
12	-0120	\$17.26	\$27.39	\$18.56	\$18.82	\$18.31	\$19.18	\$23.12
24	-0240	\$17.96	\$28.44	\$19.00	\$19.52	\$19.04	\$20.78	\$24.42
36	-0360	\$18.66	\$29.49	\$19.44	\$20.22	\$19.77	\$22.38	\$25.72
48	-0480	\$19.36	\$30.54	\$19.88	\$20.92	\$20.50	\$23.98	\$27.02
60	-0600	\$20.06	\$31.59	\$20.32	\$21.62	\$21.23	\$25.58	\$28.32
72	-0720	\$20.76	\$32.64	\$20.76	\$22.32	\$21.96	\$27.18	\$29.62

75 Ω BNC Male Plug x 75 Ω BNC Right Angle Male Plug



LTH IN INS	DASH NUM	75 Ω RG 6 ①③ 2 shields 006-SASC-	75 Ω RG 11 ⑥ 1 shield⑥ 011-SASC-	75 Ω RG 59 ③⑤ 1 shield⑧ 059-SASC-	93 Ω RG 62 ③⑤ 1 shield⑧ 062-SASC-	75 Ω RG 179 ④② 1 shield⑩ 179-SASC-	75 Ω RG 187⑦ 1 shield⑩ 187-SASC-	75 Ω RG 216③ 2 shields⑥ 216-SASC-
Solder Center, Clamp and Crimp Outer with Strain Relief								
12	-0120	\$21.63	\$51.48	\$23.67	\$23.93	\$28.51	\$29.38	\$33.62
24	-0240	\$22.33	\$52.53	\$24.11	\$24.63	\$29.24	\$30.98	\$34.92
36	-0360	\$23.03	\$53.58	\$24.55	\$25.33	\$29.97	\$32.58	\$36.22
48	-0480	\$23.73	\$54.63	\$24.99	\$26.03	\$30.70	\$34.18	\$37.52
60	-0600	\$24.43	\$55.68	\$25.43	\$26.73	\$31.43	\$35.78	\$38.82
72	-0720	\$25.13	\$56.73	\$25.87	\$27.43	\$32.16	\$37.38	\$40.12
Color Designators (add letter to the end of the part number and add \$1.00 to price)								
Black - B		Blue - L		Brown - N		Gray - A		Green - G
Orange - O		Red - R		Violet - V		Yellow - Y		White - W

See Page B5 for Cable Characteristics

* Contact Factory for delivery, Consider new RD316 for (RD188) 10 % Discount @ 25 pcs. up 4% Discount @ 10 pcs. up

75 Ω BNC Male Plug x 75 Ω Maxi-SMB Female Plug

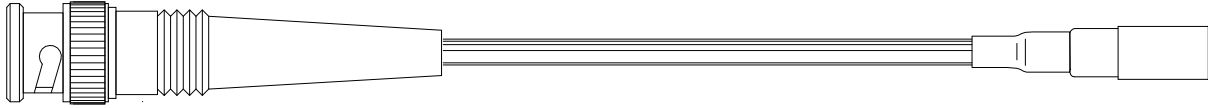

←————— LENGTH —————→

LENGTH IN INCHES	DASH NUMBER	75 Ω BELDEN 8218① 8218-SA7MA-	75 Ω RG 59B ③⑤ 1 shield⑥ 059-SA7MA-	75 Ω RG 179A ④② 2 shields⑥ 179-SA7MA-	75 Ω RD 179 ② 1 shield⑦ 179D-SA7MA-	75 Ω RG 187 ② 1 shield⑥ 187-SA7MA-
Solder Center, Crimp Outer with Strain Relief						
12	-0120	\$23.98	CALL	\$27.19	\$28.16	\$28.06
24	-0240	\$24.49	CALL	\$27.92	\$29.86	\$29.66
36	-0360	\$25.00	CALL	\$28.65	\$31.56	\$31.26
48	-0480	\$25.51	CALL	\$29.38	\$33.26	\$32.86
60	-0600	\$26.02	CALL	\$30.11	\$34.96	\$34.46
72	-0720	\$26.53	CALL	\$30.84	\$36.66	\$36.06

75 Ω BNC Male Plug x 75 Ω MCX Male Plug

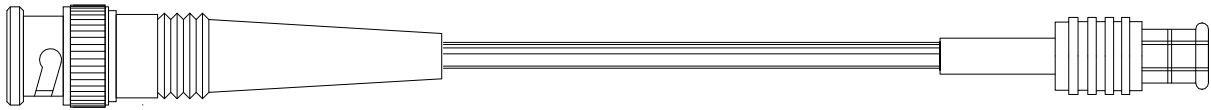

←————— LENGTH —————→

LENGTH IN INCHES	DASH NUMBER	75 Ω RG 179A ④② 1 shield⑥ 179-SA7XA-	75 Ω RD 179 ② 2 shields⑦ 179D-SA7XA-	75 Ω RG 187 ② 1 shield⑥ 187-SA7XA-	75 Ω 735A①⑦ 2 shields 735A-SA7XA-
Solder Center, Crimp Outer with Strain Relief					
12	-0120	\$21.71	\$22.68	\$22.58	\$25.07
24	-0240	\$22.44	\$24.38	\$24.18	\$25.54
36	-0360	\$23.17	\$26.08	\$25.78	\$26.01
48	-0480	\$23.90	\$27.78	\$27.38	\$26.48
60	-0600	\$24.63	\$29.48	\$28.98	\$26.95
72	-0720	\$25.36	\$31.18	\$30.58	\$27.42
Color Designators (add letter to the end of the part number and add \$1.00 to price)					
Black - B	Blue - L	Brown - N	Gray - A	Green - G	White - W
Orange - O	Red - R	Violet - V	Yellow - Y		

See Page B5 for Cable Characteristics

* Contact Factory for delivery, Consider new RD316 for (RD188)

10% Discount @ 25 pcs. up

4% Discount @ 10 pcs. up

75 Ω BNC Male Plug x 75 Ω Mini-SMB Female Plug

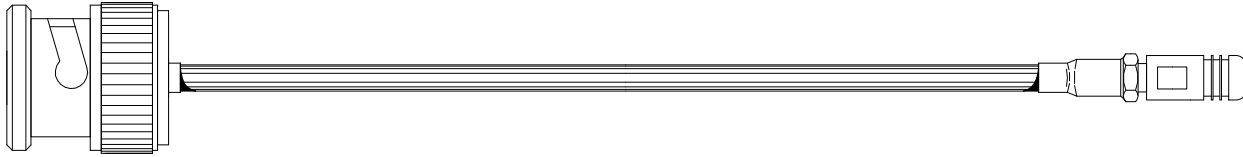

← LENGTH →

LENGTH IN INCHES	DASH NUM	75 Ω BELDEN 8218● 1 shield 8218-7BC7BC-	75 Ω RG 59B ●◎ 1 shield◎ 059-SA7BA-	93 Ω RG 62 ●◎ 1 shield◎ 062-SA7BA-	75 Ω RD 179 ② 2 shields⑦ 179D-SA7BA-	75 Ω RG 179A ④② 1 shield◎ 179-SA7BA-	75 Ω RG 187 ② 1 shield◎ 187-SA7BA-
Solder Center, Crimp Outer							
12	-0120	\$24.39	\$30.50	\$30.66	\$26.56	\$26.67	\$26.46
24	-0240	\$24.90	\$30.94	\$31.26	\$28.26	\$28.27	\$28.06
36	-0360	\$25.41	\$31.38	\$31.86	\$29.96	\$29.87	\$29.66
48	-0480	\$25.92	\$31.82	\$32.46	\$31.66	\$31.47	\$31.26
60	-0600	\$26.43	\$32.26	\$33.06	\$33.36	\$33.07	\$32.86
72	-0720	\$26.94	\$32.70	\$33.66	\$35.06	\$34.67	\$34.46

75 Ω BNC Male Plug x 75 Ω N Male Plug



← LENGTH →

LTH IN INS	DASH NUM	75 Ω RG 6 ①◎ 2 shields 006-NOSA-	75 Ω RG 11 ⑥ 1 shield◎ 011-NASA-	75 Ω RG 59 ●◎ 1 shield◎ 059-NASA-	93 Ω RG 62 ●◎ 1 shield◎ 062-NASA-	75 Ω RG 179 ④② 1 shield◎ 179-NASA-	75 Ω RG 187 ② 1 shield◎ 187-NASA-	75 Ω RG 216 ● 2 shields◎ 216-NASA-
Solder Center, Clamp and Crimp Outer with Strain Relief								
12	-0120	\$40.52	\$32.80	\$30.38	\$30.64	\$34.46	\$35.33	\$39.41
24	-0240	\$41.22	\$33.85	\$30.82	\$31.34	\$35.19	\$36.93	\$40.71
36	-0360	\$41.92	\$34.90	\$31.26	\$32.04	\$35.92	\$38.53	\$42.01
48	-0480	\$42.62	\$35.95	\$31.70	\$32.74	\$36.65	\$40.13	\$43.31
60	-0600	\$43.32	\$37.00	\$32.14	\$33.44	\$37.38	\$41.73	\$44.61
72	-0720	\$44.02	\$38.05	\$32.58	\$34.14	\$38.11	\$43.33	\$45.91
Color Designators (add letter to the end of the part number and add \$1.00 to price)								
Black - B		Blue - L		Brown - N		Gray - A		Green - G
Orange - O		Red - R		Violet - V		Yellow - Y		White - W

See Page B5 for Cable Characteristics

* Contact Factory for delivery, Consider new RD316 for (RD188) 10 % Discount @ 25 pcs. up 4% Discount @ 10 pcs. up

75 Ω BNC Male Plug x 75 Ω SMC Female Plug

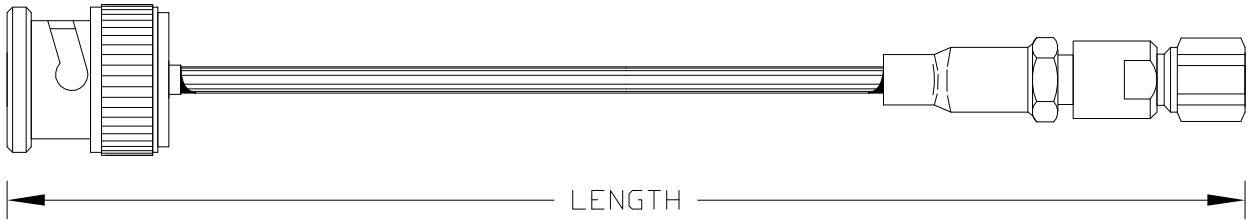

LENGTH IN INCHES	DASH NUM	75 Ω BELDEN 8218 ① 1 shield 8218-7MCASA-	75 Ω RG 59B ③⑤ 1 shield⑥ 059-7MCASA-	93 Ω RG 62 ③⑤ 1 shield⑥ 062-7MCASA-	75 Ω RD 179 ② 2 shields⑦ 179D-7MCASA-	75 Ω RG 179A ④② 1 shield⑥ 179-7MCASA-	75 Ω RG 187 ② 1 shield⑥ 187-7MCASA-
Solder Center, Crimp Outer							
12	-0120	\$28.48	\$28.74	\$29.00	\$31.12	\$28.76	\$29.63
24	-0240	\$28.99	\$29.18	\$29.70	\$32.82	\$29.49	\$31.23
36	-0360	\$29.50	\$29.62	\$30.40	\$34.52	\$30.22	\$32.83
48	-0480	\$30.01	\$30.06	\$31.10	\$36.22	\$30.95	\$34.43
60	-0600	\$30.52	\$30.50	\$31.80	\$37.92	\$31.68	\$36.03
72	-0720	\$31.03	\$30.94	\$32.50	\$39.62	\$32.41	\$37.63

75 Ω BNC Male Plug x 75 Ω TNC Male Plug



LTH IN INS	DASH NUM	75 Ω RG 6A ①③ 2 shields 006-SARA-	75 Ω RG 11A⑥ 1 shield⑥ 011-SARA-	75 Ω RG 59B ③⑤ 1 shield⑥ 059-SARA-	93 Ω RG 62 ③⑤ 1 shield⑥ 062-SARA-	75 Ω RD 179B ② 2 shields⑦ 179D-SARA-	75 Ω RG 179B ④② 1 shield⑥ 179-SARA-	75 Ω RG 187A ② 1 shield⑥ 187-SARA-	75 Ω RG 216 ③ 2 shields⑥ 216-SARA-
Solder Center, Clamp and Crimp Outer with Strain Relief									
12	-0120	\$16.95	\$25.13	\$24.78	\$25.04	\$22.06	\$21.09	\$19.70	\$20.57
24	-0240	\$17.65	\$26.18	\$25.22	\$25.74	\$23.76	\$21.82	\$20.43	\$22.17
36	-0360	\$18.35	\$27.23	\$25.66	\$26.44	\$25.46	\$22.55	\$21.16	\$23.77
48	-0480	\$19.05	\$28.28	\$26.10	\$27.14	\$27.16	\$23.28	\$21.89	\$25.37
60	-0600	\$19.75	\$29.33	\$26.54	\$27.84	\$28.86	\$24.01	\$22.62	\$26.97
72	-0720	\$20.45	\$30.38	\$26.98	\$28.54	\$30.56	\$24.74	\$23.35	\$28.57
Color Designators (add letter to the end of the part number and add \$1.00 to price)									
Black - B		Blue - L		Brown - N		Gray - A		Green - G	
Orange - O		Red - R		Violet - V		Yellow - Y		White - W	

See Page B5 for Cable Characteristics

* Contact Factory for delivery, Consider new RD316 for (RD188)

10% Discount @ 25 pcs. up

4% Discount @ 10 pcs. up

75 Ω BNC Right Angle Plug x 75 Ω BNC Right Angle Plug

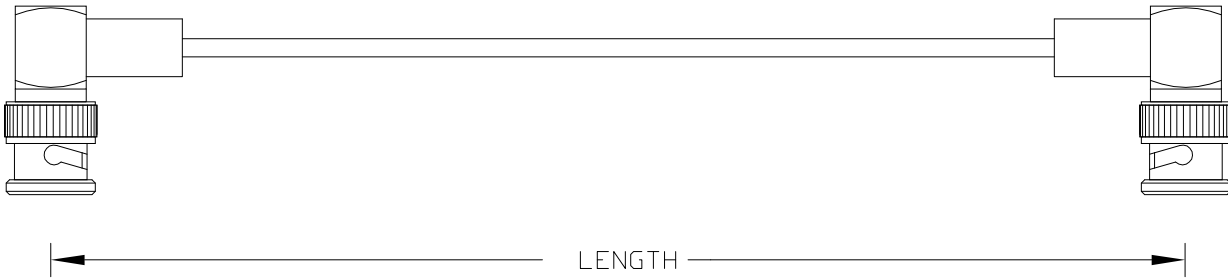

LENGTH IN INCHES	DASH NUMBER	75 Ω RG 6 ① 2 shields 006-SCSC-	75 Ω RG 59 ②⑤ 1 shield⑥	93 Ω RG 62 ②⑤ 1 shield⑥ 062-S2S2-	75 Ω RD 179 ② 2 shields⑦ 179D-S2S2-	75 Ω RG 179④② 1 shield⑥ 179-S2S2-	75 Ω RG 187② 1 shield⑥ 187-S2S2-
Solder Center, Crimp Outer with Strain Relief							
12	-0120	\$26.00	\$30.58	\$30.74	\$33.68	\$32.71	\$33.58
24	-0240	\$26.70	\$31.02	\$31.34	\$35.38	\$33.44	\$35.18
36	-0360	\$27.40	\$31.46	\$31.94	\$37.08	\$34.17	\$36.78
48	-0480	\$28.10	\$31.90	\$32.54	\$38.78	\$34.90	\$38.38
60	-0600	\$28.80	\$32.34	\$33.14	\$40.48	\$35.63	\$39.98

75 Ω Maxi-SMB Female Plug x 75 Ω Maxi-SMB Female Plug



LENGTH IN INCHES	DASH NUMBER	75 Ω BELDEN 8218① 1 shield 8218-7MA7MA-	75 Ω RG 59B ②⑤ 1 shield⑥ 059-7MA7MA-	75 Ω RD 179 ② 2 shields⑦ 179D-7MA7MA-	75 Ω RG 179A ④② 1 shield⑥ 179-7MA7MA-	75 Ω RG 187 ② 1 shield⑥ 187-7MA7MA-
Solder Center, Crimp Outer with Strain Relief						
12	-0120	\$29.69	CALL	\$34.26	\$33.29	\$34.16
24	-0240	\$30.20	CALL	\$35.96	\$34.02	\$35.76
36	-0360	\$30.71	CALL	\$37.66	\$34.75	\$37.36
48	-0480	\$31.22	CALL	\$39.36	\$35.48	\$38.96
60	-0600	\$31.73	CALL	\$41.06	\$36.21	\$40.56
72	-0720	\$32.24	CALL	\$42.76	\$36.94	\$42.16
Color Designators (add letter to the end of the part number and add \$1.00 to price)						
Black - B		Blue - L		Brown - N		Gray - A
Orange - O		Red - R		Violet - V		Green - G
						White - W

See Page B5 for Cable Characteristics

* Contact Factory for delivery, Consider new RD316 for (RD188) 10 % Discount @ 25 pcs. up 4% Discount @ 10 pcs. up

75 Ω MCX Male Plug x 75 Ω MCX Male Plug

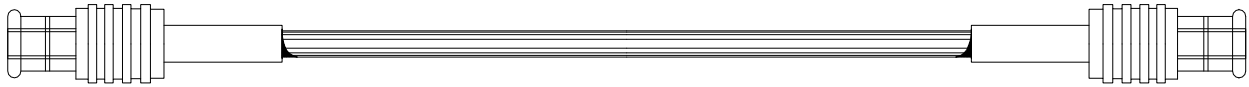

LENGTH IN INCHES	DASH NUMBER	75 Ω RD 179 ② 2 shields⑦ 179D-7XA7XA-	75 Ω RG 179A ④② 1 shield⑩ 179-7XA7XA-	75 Ω RG 187 ② 1 shield⑩ 187-7XA7XA-	75 Ω 735A⑨ 2 shields 735A-7XA7XA-
Solder Center, Crimp Outer with Strain Relief					
12	-0120	\$23.30	\$22.33	\$23.20	\$33.79
24	-0240	\$25.00	\$23.06	\$24.80	\$34.26
36	-0360	\$26.70	\$23.79	\$26.40	\$34.73
48	-0480	\$28.40	\$24.52	\$28.00	\$35.20
60	-0600	\$30.10	\$25.25	\$29.60	\$35.67
72	-0720	\$31.80	\$25.98	\$31.20	\$36.14

75 Ω Mini-SMB Female Plug x 75 Ω Mini-SMB Female Plug



LENGTH IN INCHES	DASH NUMBER	75 Ω RG 59B ③⑤ 1 shield⑧ 059-7BA7BA-	93 Ω RG 62 ③⑤ 1 shield⑧ 062-7BA7BA-	75 Ω RD 179 ② 2 shields⑦ 179D-7BA7BA-	75 Ω RG 179A ④② 1 shield⑩ 179-7BA7BA-	75 Ω RG 187 ② 1 shield⑩ 187-7BA7BA-
Solder Center, Crimp Outer with Strain Relief						
12	-0120	\$43.04	\$43.20	\$31.06	\$30.09	\$30.96
24	-0240	\$43.48	\$43.80	\$32.76	\$30.82	\$32.56
36	-0360	\$43.92	\$44.40	\$34.46	\$31.55	\$34.16
48	-0480	\$44.36	\$45.00	\$36.16	\$32.28	\$35.76
60	-0600	\$44.80	\$45.60	\$37.86	\$33.01	\$37.36
72	-0720	\$45.24	\$46.20	\$39.56	\$33.74	\$38.96
Color Designators (add letter to the end of the part number and add \$1.00 to price)						
Black - B		Blue - L		Brown - N		Gray - A
Orange - O		Red - R		Violet - V		Yellow - Y
						Green - G
						White - W

See Page B5 for Cable Characteristics

* Contact Factory for delivery, Consider new RD316 for (RD188)

10% Discount @ 25 pcs. up

4% Discount @ 10 pcs. up

75 Ω Mini-SMB Female Plug x 75 Ω Mini-SMB 90° Female Plug

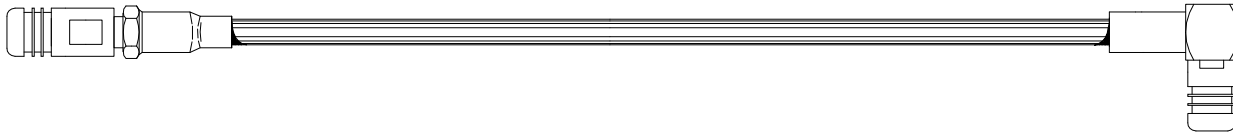

← LENGTH →

LENGTH IN INCHES	DASH NUMBER	75 Ω RG 59B ③⑤ 1 shield® 059-7BA7BC-	93 Ω RG 62 ③⑤ 1 shield® 062-7BA7BC-	75 Ω RD 179 ② 2 shields⑦ 179D-7BA7BC-	75 Ω RG 179A ④② 1 shield® 179-7BA7BC-	75 Ω RG 187 ② 1 shield® 187-7BA7BC-
Solder Center, Crimp Outer with Strain Relief						
12	-0120	\$46.62	\$46.78	\$30.49	\$29.52	\$30.39
24	-0240	\$47.06	\$47.38	\$32.19	\$30.25	\$31.99
36	-0360	\$47.50	\$47.98	\$33.89	\$30.98	\$33.59
48	-0480	\$47.94	\$48.58	\$35.59	\$31.71	\$35.19
60	-0600	\$48.38	\$49.18	\$37.29	\$32.44	\$36.79
72	-0720	\$48.82	\$49.78	\$38.99	\$33.17	\$38.39

75 Ω Mini-SMB Female Plug x 75 Ω TNC Male Plug

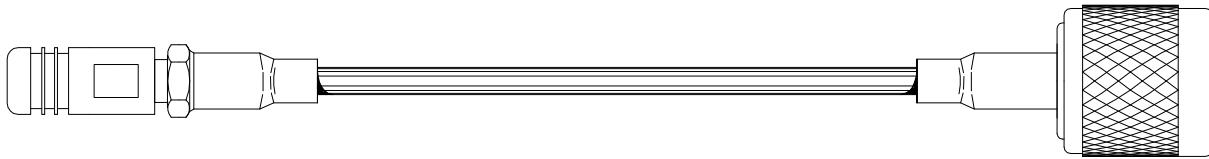

← LENGTH →

LENGTH IN INCHES	DASH NUMBER	75 Ω RG 59B ③⑤ 1 shield® 059-7BA7RA-	93 Ω RG 62 ③⑤ 1 shield® 062-7BA7RA-	75 Ω RD 179 ② 2 shields⑦ 179D-7BA7RA-	75 Ω RG 179A ④② 1 shield® 179-7BA7RA-	75 Ω RG 187 ② 1 shield® 187-7BA7RA-
Solder Center, Crimp Outer with Strain Relief						
12	-0120	\$37.02	\$37.18	\$26.56	\$25.59	\$26.46
24	-0240	\$37.46	\$37.78	\$28.26	\$26.32	\$28.06
36	-0360	\$37.90	\$38.38	\$29.96	\$27.05	\$29.66
48	-0480	\$38.34	\$38.98	\$31.66	\$27.78	\$31.26
60	-0600	\$38.78	\$39.58	\$33.36	\$28.51	\$32.86
72	-0720	\$39.22	\$40.18	\$35.06	\$29.24	\$34.46
Color Designators (add letter to the end of the part number and add \$1.00 to price)						
Black - B		Blue - L		Brown - N		Gray - A
Orange - O		Red - R		Violet - V		Yellow - Y
						Green - G
						White - W

See Page B5 for Cable Characteristics

* Contact Factory for delivery, Consider new RD316 for (RD188) 10 % Discount @ 25 pcs. up 4% Discount @ 10 pcs. up



RF Depot.com Inc.

Phone 856-488-2000 Fax 856-488-2020

75Ω Mini-SMB 90° Female Plug x 75Ω Mini-SMB 90° Female Plug

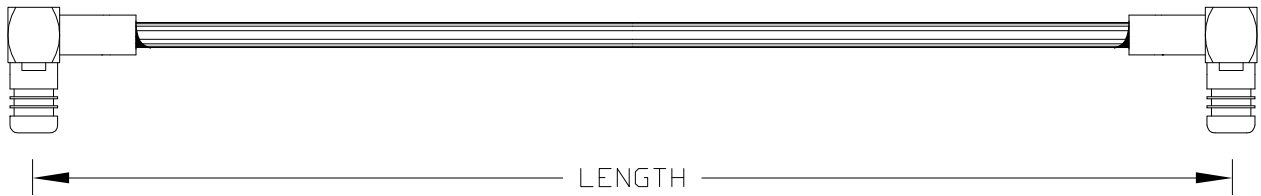

LENGTH IN INCHES	DASH NUMBER	75 Ω RG 59B ①⑤ 1 shield⑧ 059-7BC7BC-	93 Ω RG 62 ②⑤ 1 shield⑧ 062-7BC7BC-	75 Ω RD 179 ② 2 shields⑦ 179D-7BC7BC-	75 Ω RG 179A ④② 1 shield⑧ 179-7BC7BC-	75 Ω RG 187 ② 1 shield⑧ 187-7BC7BC-
Solder Center, Crimp Outer						
12	-0120	\$50.20	\$50.36	\$29.92	\$28.95	\$29.82
24	-0240	\$50.64	\$50.96	\$31.62	\$29.68	\$31.42
36	-0360	\$51.08	\$51.56	\$33.32	\$30.41	\$33.02
48	-0480	\$51.52	\$52.16	\$35.02	\$31.14	\$34.62
60	-0600	\$51.96	\$52.76	\$36.72	\$31.87	\$36.22
72	-0720	\$52.40	\$53.36	\$38.42	\$32.60	\$37.82

75 Ω N Male Plug x 75 Ω N Male Plug

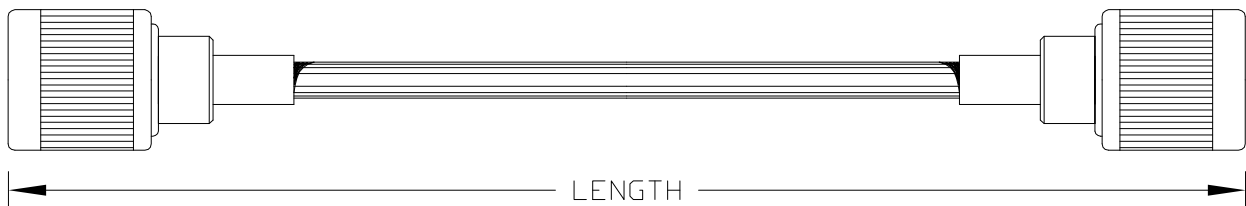

LTH IN INS	DASH NUM	75 Ω RG 6 ①⑤ 2 shields 006-N70N70-	75 Ω RG 11 ⑥ 1 shield⑧ 011-N7AN7A-	75 Ω RG 59 ②⑤ 1 shield⑧ 059-N7AN7A-	93 Ω RG 62 ②⑤ 1 shield⑧ 062-N7AN7A-	75 Ω RG 179 ④② 1 shield⑧ 179-N7AN7A-	75 Ω RG 187② 1 shield⑧ 187-N7AN7A-	75 Ω RG 216③ 2 shields⑥ 216-N7AN7A-
Solder Center, Clamp Outer								
12	-0120	\$63.78	\$39.57	\$41.40	\$41.56	\$51.58	\$51.48	\$55.70
24	-0240	\$64.48	\$40.62	\$41.84	\$42.16	\$53.28	\$53.08	\$57.00
36	-0360	\$65.18	\$41.67	\$42.28	\$42.76	\$54.98	\$54.68	\$58.30
48	-0480	\$65.88	\$42.72	\$42.72	\$43.36	\$56.68	\$56.28	\$59.60
60	-0600	\$66.58	\$43.77	\$43.16	\$43.96	\$58.38	\$57.88	\$60.90
72	-0720	\$67.28	\$44.82	\$43.60	\$44.56	\$60.08	\$59.48	\$62.20
Color Designators (add letter to the end of the part number and add \$1.00 to price)								
Black - B		Blue - L		Brown - N		Gray - A		Green - G
Orange - O		Red - R		Violet - V		Yellow - Y		White - W

See Page B5 for Cable Characteristics

* Contact Factory for delivery, Consider new RD316 for (RD188)

10% Discount @ 25 pcs. up

4% Discount @ 10 pcs. up

75 Ω SMC Female Plug x 75 Ω SMC Female Plug

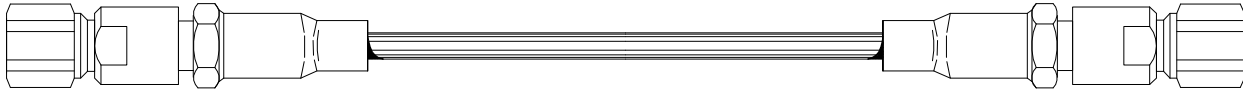

LENGTH IN INCHES	DASH NUMBER	75 Ω BELDEN 8218● 1 shield 8218-7C07C0-	75 Ω RG 59B ●◎ 1 shield◎ 059-7C07C0-	93 Ω RG 62 ●◎ 1 shield◎ 062-7C07C0-	75 Ω RD 179 ◎ 2 shields◎ 179D-7C07C0-	75 Ω RG 179A ●◎ 2 shields◎ 179-7C07C0-	75 Ω RG 187 ◎ 1 shield◎ 187-7C07C0-
Solder Center, Crimp Outer with Strain Relief							
12	-0120	\$38.99	\$38.92	\$39.08	\$40.18	\$39.21	\$40.08
24	-0240	\$39.50	\$39.36	\$39.68	\$41.88	\$39.94	\$41.68
36	-0360	\$40.01	\$39.80	\$40.28	\$43.58	\$40.67	\$43.28
48	-0480	\$40.52	\$40.24	\$40.88	\$45.28	\$41.40	\$44.88
60	-0600	\$41.03	\$40.68	\$41.48	\$46.98	\$42.13	\$46.48
72	-0720	\$41.54	\$41.12	\$42.08	\$48.68	\$42.86	\$48.08

75 Ω SMC Female Plug x 75 Ω SMC Male Bulkhead Jack

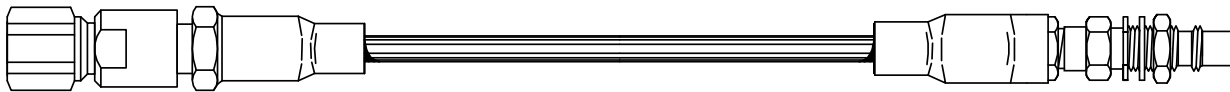

LENGTH IN INCHES	DASH NUMBER	75 Ω BELDEN 8218● 1 shield 8218-7C07C5-	75 Ω RG 59B ●◎ 1 shield◎ 059-7C07C5-	93 Ω RG 62 ●◎ 1 shield◎ 062-7C07C5-	75 Ω RD 179 ◎ 2 shields◎ 179D-7C07C5-	75 Ω RG 179A ●◎ 1 shield◎ 179-7C07C5-	75 Ω RG 187 ◎ 1 shield◎ 187-7C07C5-
Solder Center, Crimp Outer with Strain Relief							
12	-0120	\$38.08	\$38.01	\$38.17	\$39.27	\$38.30	\$39.17
24	-0240	\$38.59	\$38.45	\$38.77	\$40.97	\$39.03	\$40.77
36	-0360	\$39.10	\$38.89	\$39.37	\$42.67	\$39.76	\$42.37
48	-0480	\$39.61	\$39.33	\$39.97	\$44.37	\$40.49	\$43.97
60	-0600	\$40.12	\$39.77	\$40.57	\$46.07	\$41.22	\$45.57
72	-0720	\$40.63	\$40.21	\$41.17	\$47.77	\$41.95	\$47.17
Color Designators (add letter to the end of the part number and add \$1.00 to price)							
Black - B		Blue - L		Brown - N		Gray - A	
Orange - O		Red - R		Violet - V		Green - G	
						White - W	

See Page B5 for Cable Characteristics

* Contact Factory for delivery, Consider new RD316 for (RD188) 10 % Discount @ 25 pcs. up 4% Discount @ 10 pcs. up

75 Ω SMC Female Plug x 75 Ω SMC 90° Female Plug



← LENGTH →

LENGTH IN INCHES	DASH NUMBER	75 Ω BELDEN 8218 ① 1 shield 8218-7C07C2-	75 Ω RG 59B ②⑤ 1 shield③ 059-7C07C2-	93 Ω RG 62 ②⑤ 1 shield③ 062-7C07C2-	75 Ω RD 179 ② 2 shields⑦ 179D-7C07C2-	75 Ω RG 179A ①② 1 shield③ 179-7C07C2-	75 Ω RG 187 ② 1 shield③ 187-7C07C2-
Solder Center, Crimp Outer with Strain Relief							
12	-0120	\$44.57	\$44.50	\$44.66	\$45.76	\$44.79	\$45.66
24	-0240	\$45.08	\$44.94	\$45.26	\$47.46	\$45.52	\$47.26
36	-0360	\$45.59	\$45.38	\$45.86	\$49.16	\$46.25	\$48.86
48	-0480	\$46.10	\$45.82	\$46.46	\$50.86	\$46.98	\$50.46
60	-0600	\$46.61	\$46.26	\$47.06	\$52.56	\$47.71	\$52.06
72	-0720	\$47.12	\$46.70	\$47.66	\$54.26	\$48.44	\$53.66

75 Ω TNC Male Plug x 75 Ω TNC Male Plug

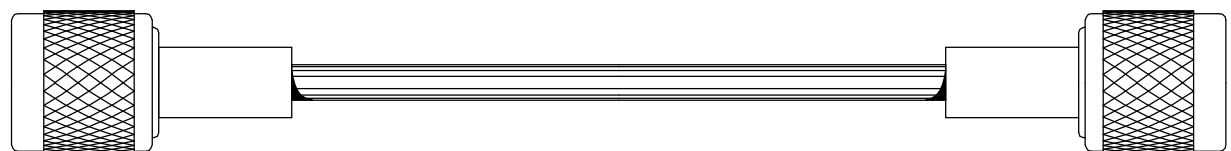

← LENGTH →

LTH IN INS	DASH NUM	75 Ω RG 6A ①⑤ 2 shields 006-RARA-	75 Ω RG 11A ⑥ 1 shield③ 011-RARA-	75 Ω RG 59B ②⑤ 1 shield③ 059-RARA-	93 Ω RG 62 ②⑤ 1 shield③ 062-RARA-	75 Ω RD 179B ② 2 shields⑦ 179D-RARA-	75 Ω RG 179B ①② 1 shield③ 179-RARA-	75 Ω RG 187A② 1 shield③ 187-RARA-	75 Ω RG 216③ 2 shields③ 216-RARA-
Solder Center, Crimp Outer with Strain Relief									
12	-0120	\$16.64	\$22.87	\$31.00	\$31.16	\$22.06	\$21.09	\$21.96	\$23.12
24	-0240	\$17.34	\$23.92	\$31.44	\$31.76	\$23.76	\$21.82	\$23.56	\$24.42
36	-0360	\$18.04	\$24.97	\$31.88	\$32.36	\$25.46	\$22.55	\$25.16	\$25.72
48	-0480	\$18.74	\$26.02	\$32.32	\$32.96	\$27.16	\$23.28	\$26.76	\$27.02
60	-0600	\$19.44	\$27.07	\$32.76	\$33.56	\$28.86	\$24.01	\$28.36	\$28.32
72	-0720	\$20.14	\$28.12	\$33.20	\$34.16	\$30.56	\$24.74	\$29.96	\$29.62
Color Designators (add letter to the end of the part number and add \$1.00 to price)									
Black - B		Blue - L		Brown - N		Gray - A		Green - G	
Orange - O		Red - R		Violet - V		Yellow - Y		White - W	

See Page B5 for Cable Characteristics

* Contact Factory for delivery, Consider new RD316 for (RD188)

10% Discount @ 25 pcs. up

4% Discount @ 10 pcs. up

ASI MaxiFlex Cables

RF Depot Prefix	04F	08F	14F	25F				
Electrical Characteristics (Nominal)								
Impedance:	50 +/- 2 Ohms	50 +/- 2 Ohms	50 +/- 2 Ohms	50 +/- 2 Ohms				
Inductance:	0.0704 µH/ft.	0.0704 µH/ft.	0.0704 µH/ft.	0.0704 µH/ft.				
Capacitance:	29.5 pF/ft.	29.5 pF/ft.	29.5 pF/ft.	29.5 pF/ft.				
Velocity of Propagation:	70.0%	70.0%	70.0%	70.0%				
Delay:	1.46 ns/ft.	1.46 ns/ft.	1.46 ns/ft.	1.46 ns/ft.				
Attenuation Maximum Power (Nominal)								
Frequency	Loss (100 ft)	Power (Watts)	Loss (100 ft)	Power (Watts)	Loss (100 ft)	Power (Watts)	Loss (100 ft)	Power (Watts)
50 MHz	7.8 dB	112	4.5 dB	-	2.3 dB	-	1.37dB	-
100 MHz	11.1 dB	112	6.5 dB	-	3.3 dB	1000	1.97dB	2000
200 MHz	16.0 dB	112	9.2 dB	270	4.7 dB	830	2.86 dB	-
400 MHz	23.0 dB	77	13.0 dB	200	6.9 dB	650	4.18 dB	2000
700 MHz	30.7 dB	60	17.0 dB	155	9.3 dB	520	5.74 dB	1350
900 MHz	35.0 dB	56	20.7 dB	140	10.8 dB	470	6.63 dB	1260
1,000 MHz	37.3 dB	50	22.0 dB	130	11.4 dB	450	7.05 dB	810
4,000 MHz	76.4 dB	24.5	44.0 dB	62	25.3 dB	210	16.5 dB	-
7,000 MHz	102.7 dB	18.1	63.0 dB	35	35.3 dB	150	23.88 dB	-
10,000 MHz	124.2 dB	15.4	76.0 dB	35	44.0 dB	120	30.5 dB	-
15,000 MHz	154.1 dB	12.5	95.0 dB	26	56.8 dB	-	40.66 dB	-
18,000 MHz	170.0 dB	11.5	105.0 dB	22	63.9 dB	72	46.42 dB	-
20,000 MHz	180.3 dB	10.8	114.5 dB	20	68.6 dB	70	50.16 dB	-
30,000 MHz	204 dB	8.8	148.0 dB	17	87.5 dB	56	68.04 dB	-
34,000 MHz	217.2 dB	8.5	160.0 dB	16	93.0 dB	53	74.11 dB	-
40,000 MHz	232.0 dB	7.6	172.0 dB	14	N/A	N/A	85.00 dB	-
Max VSWR:	to 3.0 GHz to 10.0 GHz to 20.0 GHz	1.15:1 1.20:1 1.30:1	1.15:1 1.20:1 1.30:1	1.15:1 1.20:1 1.30:1	1.15:1 1.20:1 1.30:1	1.15:1 1.20:1 1.30:1	1.15:1 1.20:1 1.30:1	1.15:1 1.20:1 1.30:1
DC Shield Resistance/Kft:	8.0 Ohms	10.2 Ohms	4.5 Ohms	8.0 Ohms				
DC Center Resistance/Kft:	207 Ohms	64.2 Ohms	20.5 Ohms	2.5 Ohms				
Volts RMS Max:	1000 V	1500 V	1900 V	3000 V				
Physical Characteristics								
Nom. Weight/1000ft:	5.0 lbs.	10.12 lbs.	27 lbs.	81 lbs.				
Bend Diameter: one time	.13	.250"	.375"	0.65				
Bend Diameter: repeat	.40	.750"	1.0"	1.8*				
Temperature Rating:	-70 to +200 Deg. C	-70 to +200 Deg. C	-70 to +200 Deg. C	-70 to +200 Deg. C				
Max Pulling Tension:	-	26 lbs.	40 lbs.	-				
Insulation Material:	TFE Teflon*	TFE Teflon*	TFE Teflon*	TFE Teflon*				
Outer Shield & Coverage:	Copper Foil +Tin Filled Braid, 100%	Copper Foil +Tin Filled Braid, 100%	Copper Foil +Tin Filled Braid, 100%	Copper Foil +Tin Filled Braid, 100%				
Conductor Diameter:	.0113" Nominal	.0201" Nominal	.0362" Nominal	-				
Core Diameter:	.033" Nominal	.064" Nominal	.115" Nominal	-				
Outside Diameter:	.047" Nominal	.083" Nominal	.138" Nominal	.250" Nominal				

ASI T-Flex Cables

RF Depot Part No.	T-Flex 405		T-Flex 402		T-Flex 401	
Impedance:	50 +/- 2 Ohms		50 +/- 2 Ohms		50 +/- 2 Ohms	
Inductance:	0.0704 µH/ft.		0.0704 µH/ft.		0.0704 µH/ft.	
Capacitance:	29.3 pF/ft.		29.3 pF/ft.		29.3 pF/ft.	
Velocity of Propagation:	69.5%		69.5%		69.5%	
Delay:	1.46 ns/ft.		1.46 ns/ft.		1.46 ns/ft.	
Attenuation (Nominal)						
Frequency	Loss (100 ft)	Power (Watts)	Loss (100 ft)	Power (Watts)	Loss (100 ft)	Power (Watts)
50 MHz	5.0 dB	-	2.7 dB	-	2.3 dB	-
100 MHz	7.0 dB	-	3.9 dB	-	3.3 dB	1000
200 MHz	10.2 dB	270	6.1 dB	270	4.7 dB	830
400 MHz	14.0 dB	200	8.0 dB	200	6.9 dB	650
700 MHz	18.0 dB	155	9.2 dB	155	9.3 dB	520
900 MHz	20.5 dB	140	11.1 dB	140	10.8 dB	470
1000 MHz	23.0 dB	130	13.0 dB	130	11.4 dB	450
4000 MHz	44.3 dB	62	26.2 dB	62	25.3 dB	210
7000 MHz	61.2 dB	38	38.0 dB	35	35.3 dB	150
10000 MHz	76.0 dB	35	45.1 dB	35	4.0 dB	120
15000 MHz	87.9 dB	26	59.8 dB	26	56.8 dB	-
18000 MHz	97.3 dB	22	63.5 dB	22	63.9 dB	72
20000 MHz	112.2 dB	20	69.2 dB	20	68.6 dB	70
Max VSWR:	to 3.0 GHz to 10.0 GHz to 20.0 GHz		1.15:1 1.20:1 1.30:1		1.15:1 1.20:1 1.30:1	
DC Shield Resistance/Kft:	8.0 Ohms		10.2 Ohms		8.0 Ohms	
DC Center Resistance/Kft:	207 Ohms		64.2 Ohms		2.5 Ohms	
Volts RMS Max:	1000 V		1500 V		3000 V	
Physical Characteristics						
Nom. Weight/1000ft:	15 lbs.		33 lbs.		65 lbs.	
Bend Diameter: one time	.1250"		.200"		.375"	
Bend Diameter: repeat	1.0"		2.0"		1.0"	
Temperature Rating:	-65 to +125 Deg. C		-65 to + 125 Deg. C		-65 to + 125 Deg. C	
Max Pulling Tension:	10 lbs		26 lbs.		40 lbs.	
Insulation Material:	TFE Teflon*		TFE Teflon*		TFE Teflon*	
Outer Shield & Coverage:	Copper Foil +Tin Filled Braid, 100%		Copper Foil +Tin Filled Braid, 100%		Copper Foil +Tin Filled Braid, 100%	
Conductor Diameter:	.0113" Nominal		.0201" Nominal		.0362" Nominal	
Core Diameter:	.033" Nominal		.064" Nominal		.115" Nominal	
Outside Diameter:	.047" Nominal		.083" Nominal		.138" Nominal	

Connector Power Ratings

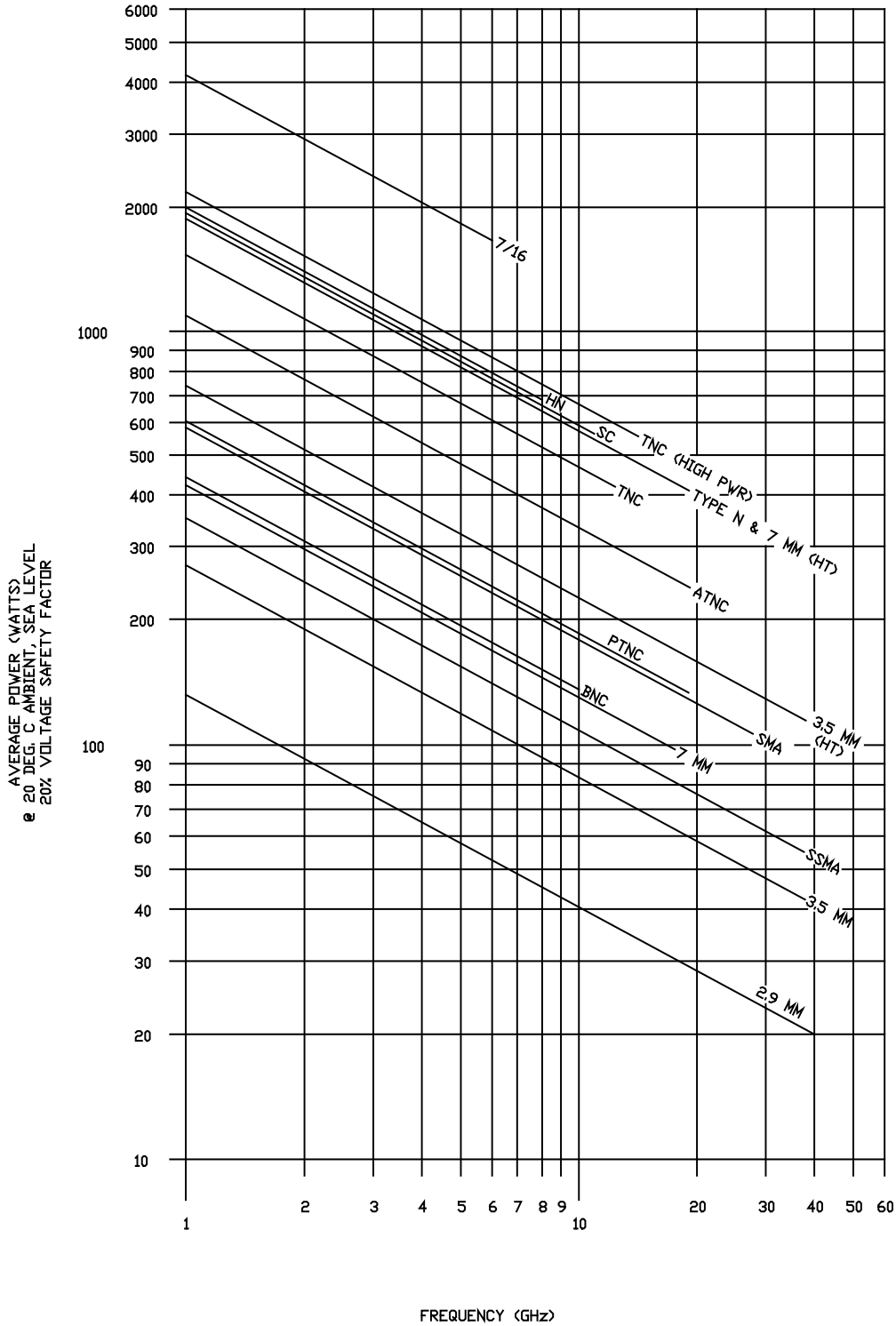

(HT) = HIGH TEMPERATURE INSULATOR

FREQUENCY (GHz)

AVERAGE POWER (WATTS) @ 20° C AMBIENT,
SEA LEVEL 20% VOLTAGE SAFETY FACTOR



RF Depot.com Inc.

Phone 856-488-2000 Fax 856-488-2020

B262

7850 Browning Rd. Pennsauken, NJ 08109

Online @ www.rfdepot.com

Toll Free 877-RF Depot

ENGINEERING NOTE: Bending Pre-terminated SEMIRIGID Coaxial Cables

Ref: Aluminum SEMIRIGID Cable

All cable cores move when coaxial cables are formed. The stronger jackets such as hard copper hold more tightly onto the core. This is a major difference between the "easy bend" cables and conventional cables.

Because of the weaker aluminum metal jacket, the cable core has lower adhesion to the aluminum outer conductor than to the copper outer conductor.

The core assembly moves in all short cables, aluminum and copper, from bending and temperature cycling.

Therefore, our standard procedure is to form cables before trimming. The bend in the cable minimizes the subsequent travel of the core.

We recommend that center pins of cables formed after connector installation be gauged and trimmed. The center pin can be from .075" to .100" long. RF Depot makes the center pin at .095" to allow for any movement. Larger movement has been known to result in damage to marginally constructed female contacts such as those found on coaxial switches. We have a specially modified pointing tool to shorten the long center pins.

Captivated coaxial connectors with internal socket contacts are often used to mitigate this problem. Such connectors, however, often increase the SWR and insertion loss at higher frequencies

All cables that are formed after terminating should have the center pin length measured and adjusted.

A rigid connector mated to the cable minimizes this problem. A "connector saver" can be used for this purpose. The Teflon® can most often be "pushed back" into the connector to improve the SWR and insertion loss.

If the pins are made shorter, the pin that recedes becomes too short.

In sum, we strongly recommend that cables be formed before termination whenever possible.

ASI 8145B	Special Pointing Tool	\$190.00	1 - 3 Weeks
CG SMA-MPL	Pin Length Gauge	\$159.60	Stock
O T - 4582	Dielectric Recess Tool	\$ 71.42	1 - 6 Weeks
S/M 2997-6003SF	Connector Saver JXP	\$ 16.80	Stock
O T - 948	Locator	\$ 92.85	Stock

® Trademark of Dupont Corporation

Test Equipment

BK 1760 TRI POWER SUPPLY
BK PRECISION TRIPLE OUTPUT POWER SUPPLY
HP 415E SWR METER
HP 431C POWER METER
HP 478A 200R THERMISTOR MOUNT (2ea)
HP 651B 10 Hz - 10 MHz SIGNAL GEN.
HP 85032B TYPE N CALIBRATION KIT
HP 85047A 300 KHz - 6 GHz S-PARAMETER TEST SET
HP 8753C 300 KHz - 6 GHz NETWORK ANALYZER
HP 8722C 40 GHz NETWORK ANALYZER
HP COLOR PRO PLOTTER 7440A
TEKTRONICS 2215A 60 MHz SCOPE
TENNEY II WITH TEMPGARD III MODEL #BTRC THERMAL CHAMBER (-73° <-> + 200° C)
TENNEY JR. THERMAL CHAMBER (-80° <-> + 200° C)
WAVETEK 2002A 1-2500 MHz SWEEP GEN.

Manufacturing Equipment

ACCUSTRIP #199B (SEMIRIGID CABLE)
AMERICAN BEAUTY 105A-3 RESISTANCE SOLDERING UNIT (2EA)
BETA MODEL 05 BETTER BENDER
CARPENTER MODEL 74-B COAXIAL STRIPPER
DANIELS Hx23 PNEUMATIC CRIMP TOOL
DANIELS Hx4 RATCHET CRIMP TOOL
DRAPER HEIGHT GAUGE
EMCO UNIMAT 3 LATHE
RACE MODEL PPS 101 SOLDER & REPAIR STATION
PRECISION SAW BETTA #94
SCHLEUNIGER MP 257 PROGRAMMABLE COAXIAL STRIPPER
SCHLEUNIGER MP 8015 PROGRAMMABLE COAXIAL STRIPPER
SCHLEUNIGER SR 1000 PROGRAMMABLE SEMIRIGID TRIMMER
SEIT ELECTRONICA 1TM INDUCTIVE SOLDER STATION
WELLER WTL 24 SERIES SOLDER STATION (2EA)
WESTERN ELECTRONIC CX-700 COAXIAL STRIPPER

Other Equipment

PENTIUM BASED AUTO-CAD WORKSTATIONS
XEROX 2510 ENGINEERING COPIER
HP DESIGN JET PLOTTER

